

Cat. No. 12-2182
OWNER'S MANUAL

Please read before using this equipment.

10 Disc CD Changer

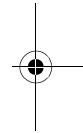
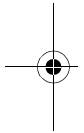

RadioShack®

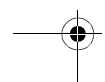
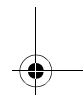
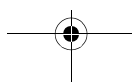
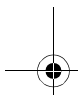

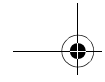

FEATURES

Your RadioShack 10 Disc CD Changer is a versatile, high-quality sound system that lets you load and play up to ten of your favorite CDs in your vehicle.

The CD changer plays CDs through your vehicle's existing sound system. If your sound system does not have RCA input jacks, the Audio Adapter's/FM modulator converts the CD changer's sound to an FM signal so you can hear it by tuning your vehicle's stereo to an FM frequency. If your vehicle's sound system has a pair of RCA input jacks, you can use an RCA cable to connect your system to the CD changer's output signal through the supplied Audio Adapter/Ground Isolator.

Important:

- To connect the CD changer, your vehicle's sound system must have an FM tuner and an antenna jack (for the connection to the CD changer with the Audio Adapter/FM modulator), or an RCA Input jack (to work with the Audio Adapter/ground isolator).
- To be safe, we recommend you do not change your CD changer's or sound system's settings in heavy traffic or during hazardous driving conditions.

Your CD changer has these features:

10-Disc CD Cartridge — lets you load and play up to ten CDs.

Controller with Infrared Wireless Remote Control — lets you control many of the CD changer's functions from anywhere in your vehicle that has direct line of sight with the changer.

Eight-Times Oversampling with Digital Filtering — improves the CD's sound by multiplying the standard 44.1 kHz sample rate by eight and using a digital filter to reduce or eliminate distortion.

1-Bit DAC — uses the latest in digital-to-analog conversion circuitry to accurately reproduce all sound levels with virtually no distortion.

Horizontal/Vertical Mounting — lets you quickly and easily install the CD changer's components in almost any vehicle.

Repeat Play — automatically repeats the current track or the disc.

Shuffle Play — randomly selects and plays tracks from any loaded CD.

Intro Scan — scans and plays the first 10 seconds of each track on a CD, so you can find a specific track.

© 1999 Tandy Corporation.
All Rights Reserved.

RadioShack is a registered trademark used by Tandy Corporation.

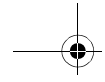

3-Beam Laser Tracking System — improves the quality of the CD changer's sound.

Spring-Loaded, Oil-Dampened Suspension System — helps keep the CD changer steady when you drive over rough roads.

Track Search — lets you quickly locate the beginning of any track while playing a CD.

Track Skip — lets you rapidly play a CD in either direction to locate a desired section of track.

This CD changer is made and tested to meet exacting safety standards.

Warning: This system employs a laser light beam. Only a qualified service person should remove the cover or attempt to service this device, due to possible eye injury.

CDs that can be played on this CD player have this mark on them:

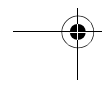
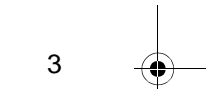
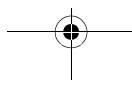
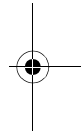
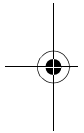

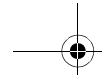

CONTENTS

| | |
|---|-----------|
| A Look at Your CD Player | 5 |
| Preparation | 6 |
| Before You Begin | 6 |
| Choosing Mounting Locations | 6 |
| For the CD Changer | 7 |
| For the Audio Adapter | 7 |
| For the CD Changer Controller | 8 |
| Removing the Transport Screws | 8 |
| Installing the Remote Control's Batteries | 8 |
| Installation | 10 |
| Connecting the Audio Adapter | 10 |
| Using RCA Jacks | 10 |
| Using a Vehicle's Antenna | 10 |
| Connecting the CD Changer | 12 |
| Connecting the CD Changer Controller | 12 |
| Testing the Connections | 13 |
| Mounting the Components | 13 |
| Mounting the CD Changer | 13 |
| Mounting the Audio Adapter | 14 |
| Mounting the CD Changer Controller | 15 |
| Reconnecting the Vehicle's Battery | 15 |
| Operation | 16 |
| Loading and Unloading the CD Magazine | 16 |
| Loading and Unloading the CD Changer | 16 |
| Playing CDs | 17 |
| Using Track Search | 18 |
| Using Track Skip | 18 |
| Selecting a CD | 18 |
| Intro Scan | 19 |
| Repeat Play | 19 |
| Shuffle Play | 19 |
| Switching Between the CD Player and the Radio | 19 |
| Resetting the Audio Adapter | 20 |
| Troubleshooting | 21 |
| Care and Maintenance | 23 |
| The FCC Wants You to Know | 24 |
| CD Care Tips | 24 |
| Resetting the CD Changer | 24 |
| Replacing a Fuse | 25 |
| Specifications | 26 |

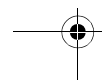
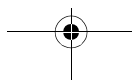

A LOOK AT YOUR CD PLAYER

The CD changer includes the following components:

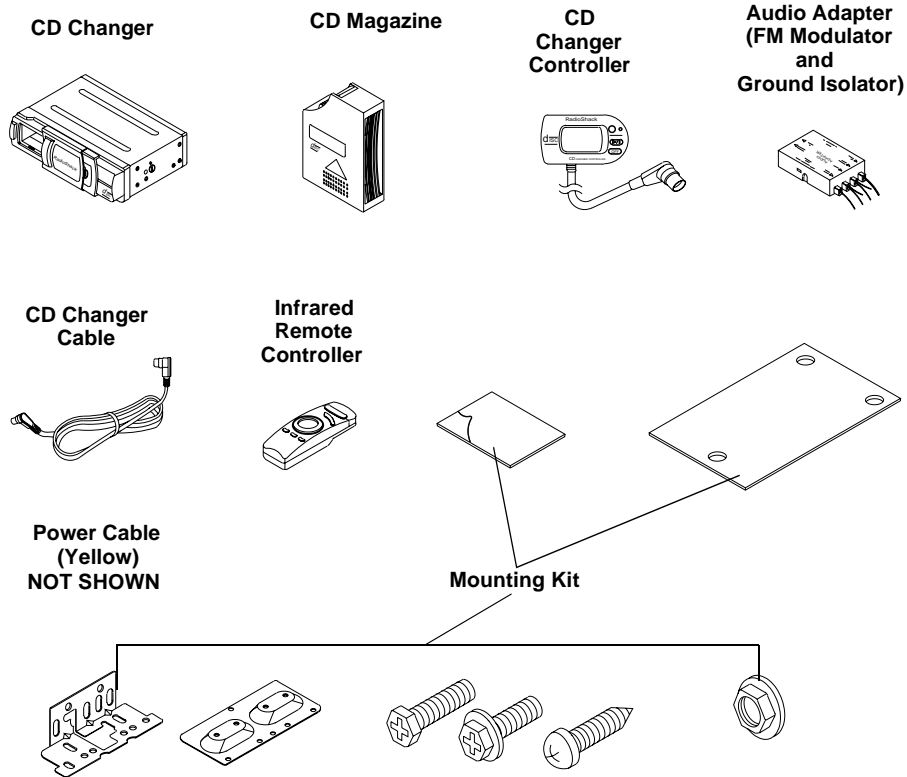

Note: If your CD changer is missing any of these components, contact the RadioShack store where you purchased it.

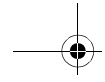

PREPARATION

BEFORE YOU BEGIN

Before you install your CD changer's components, read all the instructions in this owner's manual. You should be able to answer all of these questions about your vehicle's electrical and sound systems:

- Does my vehicle's sound system have a power amplifier with a pair of RCA input jacks? If not, can my vehicle's sound system tune FM broadcasts and does it have an antenna jack?
- Which terminal in my vehicle's fuse box is for accessories?
- How do I connect a wire to the fuse box?
- Which of the CD changer's wires is the power wire?
- Does my vehicle have a 12-volt negative ground system?

Note: Installation in your vehicle might require cutting or modifying your vehicle.

Important: To avoid damage to your stereo, CD changer, and your vehicle's electrical system, you must follow the order of installation shown in this manual, including instructions for making connections and testing.

In addition to the supplied hardware kit, you need these items to install your CD changer:

- cable ties or electrical tape
- isopropyl alcohol

- small-and medium-sized screwdrivers.

CHOOSING MOUNTING LOCATIONS

Choose locations for mounting the CD changer and its components where:

- You can easily reach them.
- Wires and cables will not interfere with the vehicle's pedals or other moving parts.
- No component is directly in front of heating vents.
- All wires and cables will reach their connection points.

Before attempting to mount the CD changer and its components, confirm that they will fit the selected mounting areas.

Caution: Be careful to avoid obstructions behind all mounting surfaces.

For the CD Changer

You can mount the CD changer horizontally or vertically in your vehicle's trunk, on the floorboard, or under a seat.

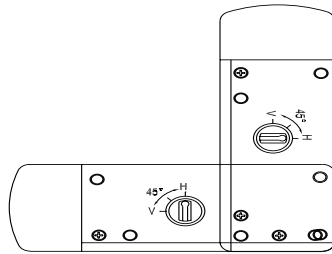

Caution: Do not mount the CD changer upside down.

Notes:

- The CD changer's mounting area must be at least 13 inches (33 cm) deep.
- When you choose a mounting area for the CD changer, make sure it is close enough to the Audio Adapter's mounting area so you can connect both components with the supplied 16-foot (5 meter) CD changer cable.
- Do not mount the CD changer anywhere in your vehicle that is exposed to direct sunlight (such as the front or rear deck) or extreme heat (such as the engine compartment). Direct sunlight or extreme heat can damage CDs and the CD changer.
- Mount the CD changer as level as possible. If you cannot mount the CD changer exactly level, make sure it will not tilt more than 15

degrees from the horizontal or vertical mounting position.

- Make sure there is enough room for you to insert and remove the supplied CD magazine from the CD changer.

For the Audio Adapter

You can mount the supplied Audio Adapter (ground isolator and FM modulator) under your vehicle's dashboard.

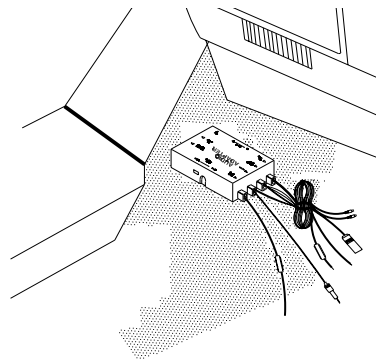

Notes:

- The Audio Adapter's mounting area must be at least 5 inches (127 mm) wide and $1\frac{1}{16}$ inches (26.3 mm) high by $3\frac{3}{5}$ inches (91 mm) deep.
- When you choose a mounting area for the Audio Adapter, make sure it is close enough to your vehicle's ground, power, and sound system so you can connect them with the FM modulator and Ground Isolator's wires and plugs (see "Connecting the Audio Adapter" on Page 10).

For the CD Changer Controller

For ease of use, you can mount the supplied CD changer controller on the dashboard using the supplied hook-and-loop fastening tape.

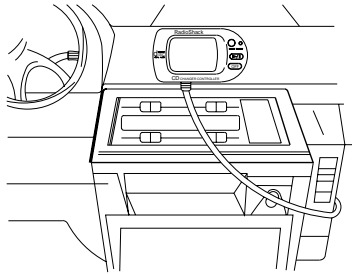

Note: When you choose a mounting area for the controller, make sure it is close enough to the Audio Adapter's mounting area so the controller's cord will reach the Audio Adapter. The controller's cord is about 5 feet (152 cm) long.

REMOVING THE TRANSPORT SCREWS

The transport screws help protect the CD changer from damage during shipment.

Before you mount the CD changer, use a small screwdriver to remove the three transport screws from the bottom of the CD changer.

Note: If you do not remove the shipping screws from the CD changer, the changer will not operate.

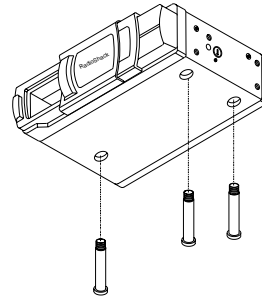

Save the shipping screws in case you might want to install the CD changer in another vehicle. You can secure them to the back of the CD changer with a piece of tape.

INSTALLING THE REMOTE CONTROL'S BATTERIES

Your infrared remote control requires 2 AA batteries (not supplied) for power. For the best performance and longest life, we recommend RadioShack alkaline batteries.

Cautions:

- Use only fresh batteries of the required size and recommended type.
- Do not mix old and new batteries, different types of batteries (standard, alkaline, or rechargeable), or rechargeable batteries of different capacities.

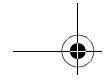

Follow these steps to install batteries.

1. Slide the battery compartment cover in the direction of the arrow to remove it.
2. Place the batteries in the compartment as indicated by the polarity symbols (+ and -) marked inside.
3. Replace the cover.

When the remote control stops operating properly, replace the batteries.

Warning: Dispose of old batteries promptly and properly. Do not burn or bury them.

Caution: If you do not plan to use the remote control for a long time, remove the batteries. Batteries can leak chemicals that can destroy electronic parts.

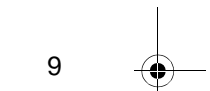
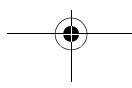
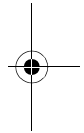
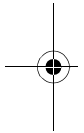

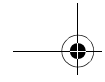

INSTALLATION

Before you mount the CD changer and its components, test it by temporarily making all the required connections.

Cautions:

- For added safety and to protect your CD changer and sound system, disconnect the cable from your vehicle battery's negative (-) terminal before you begin.
- You must make all other connections before you reconnect the cable to your vehicle's battery. If you do not make the connections in the order shown, the CD changer and sound system might be damaged if any wire connections are made incorrectly.

Using RCA Jacks

If your vehicle's sound system has a pair of RCA input jacks (either on the stereo head unit or the power amplifier), you can connect the CD changer to the sound system's output jacks.

1. Use a screwdriver to slide **ISOLATOR** on the side of the Audio Adapter to **ON**.
2. Connect the Audio Adapter's **RCA** output jack to the sound system's RCA input jack by using a cable of the proper length for your connection with 2 RCA plugs at each end. Your local RadioShack store carries a wide range of RCA cables.

CONNECTING THE AUDIO ADAPTER

The supplied Audio Adapter includes all of the lead wires for connecting to your vehicle's, ground, power and sound system. There are two ways to connect the Audio Adapter to the CD changer and the vehicle's sound system.

Using a Vehicle's Antenna

If your vehicle's sound system does not have RCA input jacks, use the Audio Adapter to convert the CD changer's sound to an FM signal, which you can hear by tuning your vehicle's radio to the corresponding FM frequency.

1. Disconnect your vehicle's antenna from your vehicle's sound system, then connect the antenna to the Audio Adapter's large black antenna connector.
2. Connect the Audio Adapter's antenna plug to your sound system's antenna jack.

3. Connect the Audio Adapter's black ground wire to a chassis ground, such as a metal screw attached to a metal part of the vehicle's frame. Be sure that the screw is not insulated from the chassis by a plastic part.

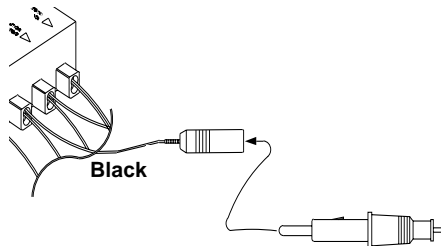

4. Connect the Audio Adapter's red power wire (with inline fuse holder) to a point in your vehicle's fuse block that has power only when you turn the vehicle's key to either the accessory (ACC) or START position.

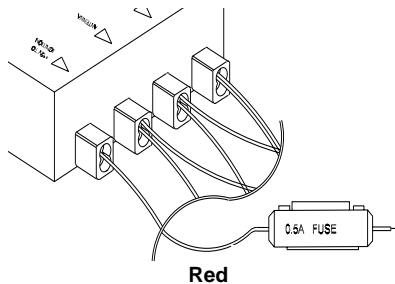

This connection turns on the CD changer and its components when you turn on the ignition or turn the key to ACC, and turns off the CD changer and its components when you turn off the ignition. This prevents your vehicle's battery from being drained if you leave the CD changer on when you turn off the ignition.

5. Connect the Audio Adapter's yellow memory back up wire (with in-line fuse holder) to your vehicle battery's positive (+) terminal or to a fuse that provides a continuous source of 12 volts.

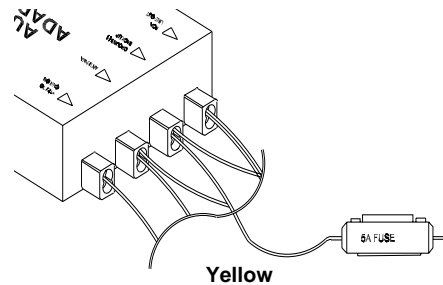

This connection provides power for the CD changer and its components, and continuous power for the CD changer's memory when the ignition is turned off.

6. Use a screwdriver to slide **ISOLATOR** on the side of the Audio Adapter to **OFF**.
7. Set **88.7MHz/89.1MHz** on the side of the Audio Adapter to an active frequency in your area, if available. This is the frequency you tune on to your vehicle's sound system to hear the CD changer.

Note: If there is no FM broadcast on either 88.7 MHz or 89.1 MHz in your area, you might hear static when the CD changer is not playing a CD.

CONNECTING THE CD CHANGER

1. Disconnect the cable from your vehicle battery's negative (-) terminal.
2. Connect the CD changer to the Audio Adapter by inserting the plug on one end of the CD changer cable into the 8-pin **CD CHANGER** jack on the Audio Adapter. Then insert the plug on the cable's other end into the **DIN 8PIN** jack on the left side of the CD changer.

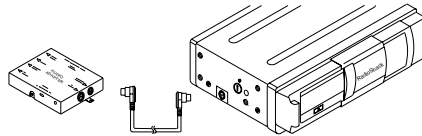

3. Connect the black ground wire to a chassis ground, such as a metal screw attached to a metal part of the vehicle's frame. Be sure that the screw is not insulated from the chassis by a plastic part.
4. Connect the yellow memory back up wire (with in-line fuse holder) to your vehicle battery's positive (+) terminal or to a fuse that provides a continuous source of 12 volts.

This connection provides power for the CD changer and its components, and continuous power for the CD changer's memory when the ignition is turned off.

Cautions:

- The CD changer cable's plugs fit only one way into the Audio Adapter

and CD changer. Do not force them. The recess mark on the metal rim of the DIN plug should face down.

- To disconnect the CD changer cable from the Audio Adapter and CD changer, squeeze each plug, then gently pull it out.
- Never pull on the CD changer cable.

CONNECTING THE CD CHANGER CONTROLLER

To connect the CD changer controller to the Audio Adapter, insert the CD changer controller cable's plug into the 6-pin **CONT.** jack on the Audio Adapter.

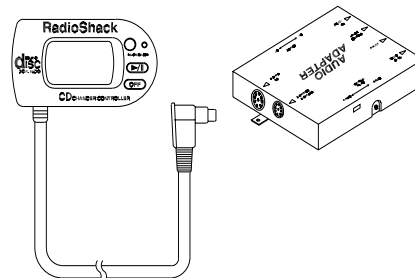

Cautions:

- The plug fits only one way into the Audio Adapter. Do not force it. The oval recess mark on the metal rim of the DIN plug should face down.
- To disconnect the controller from the Audio Adapter, gently pull it out.
- Never pull on the controller's cable.

TESTING THE CONNECTIONS

Make sure all connections are secure before continuing with the installation. Then reconnect the cable to the vehicle battery's negative (-) terminal.

Verify that you connected the CD changer correctly by turning on the changer and playing a CD. Try to use the remote control by pointing the front towards the wired CD changer controller and pressing **PLAY/PAUSE** or **POWER OFF**.

If everything is connected correctly, make sure the connections are correctly marked or identified. Then follow the instructions in "Mounting the Components."

MOUNTING THE COMPONENTS

Before you mount the CD changer and its components, be sure it is connected correctly. Then disconnect the cable from the vehicle battery's negative (-) terminal.

Mounting the CD Changer

Vertical Mounting

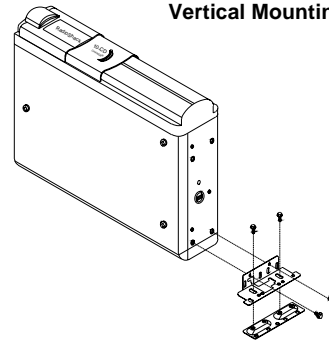

Horizontal Mounting

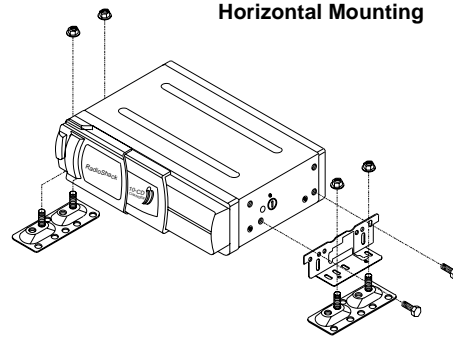

1. Set **SPRING ATTACHMENT H/V** (horizontal/vertical) on both sides of the CD changer for the mounting axis you chose.

SPRING ATTACHMENT H/V is preset to **H**. If you are mounting the CD changer horizontally, go on to Step 2.

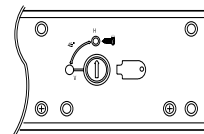

If you are mounting the CD changer vertically, use a screwdriver to remove the screws on both sides of the CD changer from **H** and turn **SPRING ATTACHMENT H/V** to **V** on both sides, then replace the screws into **V**.

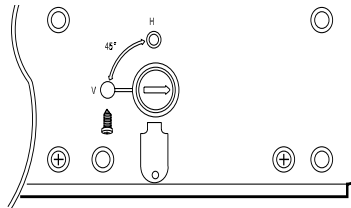

Caution: If you do not set **SPRING ATTACHMENT H/V** on both sides of the CD changer to the correct mounting axis, the CD changer might skip during play.

2. Use a medium-sized screwdriver to attach the supplied mounting brackets to the sides of the CD changer.

Mounting Stud

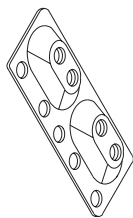

Mounting Bracket

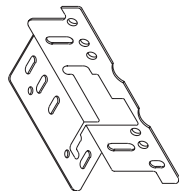

3. Using the supplied mounting studs as templates and the width between the mounting brackets as a guide, mark the positions for the mounting holes.

4. Attach the mounting studs to the mounting surface using the supplied screws.

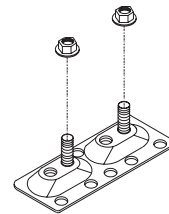

5. Attach the CD changer to the mounting studs using the supplied nuts.

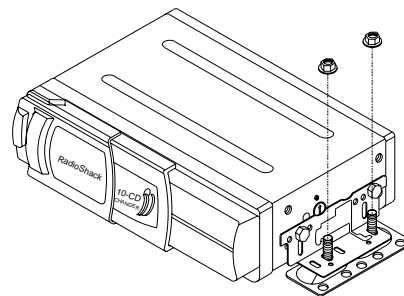

Mounting the Audio Adapter

Use the supplied screws to attach the Audio Adapter under the vehicle's dashboard.

Use cable ties (not supplied) to secure the Audio Adapter's wires under the vehicle's dashboard.

Mounting the CD Changer Controller

The supplied hook-and-loop fastener lets you securely mount the CD changer controller on the dashboard and easily remove it when you need it.

Select a mounting location, then follow these steps to secure the controller.

1. Clean both mounting surfaces with isopropyl alcohol and allow them to completely dry.
2. Peel the backing from one side of the hook-and-loop fastener and attach it to the mounting location.
3. Peel the backing from the other side of the hook-and-loop fastener and press the controller onto the fastener.

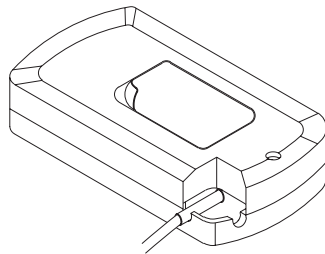

Reconnecting the Vehicle's Battery

When you finish mounting the components, reconnect the cable to the vehicle battery's negative (-) terminal.

OPERATION

LOADING AND UNLOADING THE CD MAGAZINE

You can load as many as ten CDs in the supplied CD magazine.

1. Hold the CD magazine so the clear CD window faces you and the highest CD number (**10**) is at the top of the CD window.
2. Slide all of the disc levers on the back edge of the CD magazine fully in.
3. Use a pencil to record the titles of the CDs you load in the CD magazine on one of the supplied index labels, then peel off the backing and affix the label to the side of CD magazine.

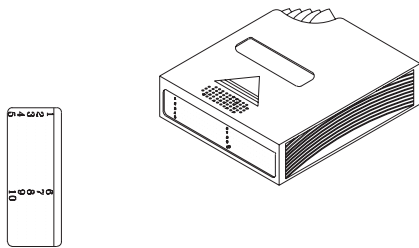

As you insert a CD into the CD magazine, the disc lever moves to the right.

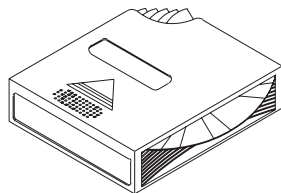

Cautions:

- Do not insert more than one CD into the same slot in the CD magazine. This will damage the CD magazine, the CD changer, and the CDs.
- Do not insert anything other than 5-inch CDs into the CD magazine.

To unload CDs from the CD magazine, hold down the disc lever for the CD you want to unload. The CD pops out. Grasp the CD by its edges and remove it.

LOADING AND UNLOADING THE CD CHANGER

Follow these steps to load the CD magazine into the CD changer.

1. Slide the CD changer's door all the way to the right until it locks into place.

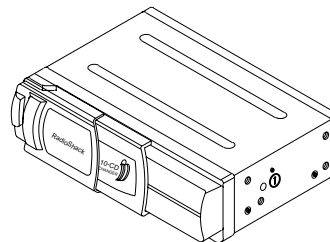

2. Hold the CD magazine with the highest CD number (10) on top with the arrow on the top of the CD magazine pointing toward the CD changer.

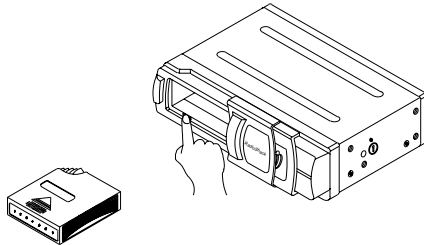

3. Gently push the CD magazine into the CD changer until it clicks. You can see the index label through the opening.

Caution: The CD magazine fits into the CD changer only one way. Do not force it.

4. Slide the CD changer's door all the way to the left to close it.

To unload the CD magazine from the CD changer, slide the CD changer's door open, then press **EJECT** to eject the magazine.

Note: The CD changer must be connected to power to eject the magazine.

PLAYING CDS

Cautions:

- The CD changer has a wide dynamic range. If you turn up your radio's volume too high during soft (low volume) sections of a program, your speakers might be damaged when a sudden loud passage occurs.
- If the CD changer is jolted during play, the rotation speed might suddenly change or the CD changer might make an unusual noise. This is not a malfunction.

Notes:

- To play CDs, you must load them into the CD magazine, then load the magazine into the CD changer. The display continues to flash if you did not load CDs into the magazine, or did not load the magazine into the changer. The changer displays the number for each CD loaded in the magazine (1–10). Then the changer selects the CD you loaded into the lowest slot number.
- If you connected the Audio Adapter's antenna plug to your sound system's antenna jack, you must select the FM band on your sound system's radio and tune to the same frequency as the **89.1MHz/88.7MHz** setting on the Audio Adapter. For easy operation, store this setting as one of your sound system's preset stations.

To turn on the CD changer and play a CD, press ►|| (Play/Pause) on either the infrared remote control or the CD changer controller. The CD starts to play from Track 1 of the CD in the lowest-numbered slot. The display shows **DISC** and the track number.

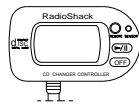

Note: The CD changer controller has only ►|| and **OFF** buttons. To control other functions, use the infrared remote control.

After the CD changer plays each track on the CD, it automatically selects the next loaded CD (from lowest to highest) and plays all tracks on that CD, starting with Track 1.

When the CD changer has played all tracks on all loaded CDs, it automatically plays the lowest loaded CD, starting with Track 1. Play continues until you stop the CD changer.

Press ►|| while a CD is playing to temporarily stop play. || appears on the display. Press ►|| again to resume play.

Note: When play is paused for 5 minutes, the CD changer automatically turns off.

To stop play and turn off the CD changer, press **OFF**. When you press ►||, the

CD changer resumes playing the last song played.

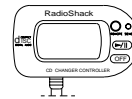

OFF

Using Track Search

To move to the beginning of the next or previous track on the CD, press ◀◀ or ▶▶. Repeatedly press ◀◀ or ▶▶ to move to another track. The display shows the current track number.

Using Track Skip

To search for a particular section of a track on the current CD, hold down ◀◀ or ▶▶ during play. The CD changer rapidly plays the CD backward or forward. Release ◀◀ or ▶▶ to resume normal play.

The display shows the rotating disk moving faster and ◀◀ or ▶▶ flashes.

Selecting a CD

To select a particular CD loaded in the CD magazine, repeatedly press + **DISC** or - **DISC** until the display shows the CD number under **DISC**.

Intro Scan

You can set the CD changer to play the first 10 seconds of each track on the current CD, to help you find the track you want to hear.

Press **SCAN** to begin the scan. The display shows **SCN** and the track number scanning.

To stop scanning and resume to playback, press **SCAN** again. **SCN** disappears from the display.

Repeat Play

Press **REPEAT**. **RPT** appears and the current track plays repeatedly.

Hold down **REPEAT** for three seconds or more. **DISC RPT** appears and the current disc plays repeatedly.

Press **REPEAT** again to end repeat play.

Shuffle Play

Press **SHUFFLE**. **SHUFF** appears, and the tracks on the current disc play in random order. When all tracks on the current disc have played, they play again in a different order.

Hold down **SHUFFLE** for three seconds or more. **DISC SHUFFLE** appears and all the tracks on a randomly-selected disc are played in random order. When all tracks on that disc have played, all the tracks on a different randomly-selected disc play. This continues until all

tracks on all discs in the CD magazine have played. Then shuffle play stops.

Press **SHUFFLE** again to end shuffle play.

SWITCHING BETWEEN THE CD PLAYER AND THE RADIO

If you connected the Audio Adapter's antenna plug to your sound system's antenna jack and you want to listen to the radio, turn off the CD changer, then tune the radio to the station you want to hear.

Note: If you do not stop or turn off the CD changer, the CD continues to play while you listen to the radio.

To return to the CD, tune the radio to the same FM frequency as the **89.1 MHz/88-7 MHz** setting on the FM modulator.

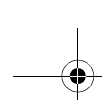

RESETTING THE AUDIO ADAPTER

If the CD changer displays an error code (**Err 1–Err 10**), locks up, or does not work properly, press the hole on the bottom of the Audio Adapter marked **RESET** with a pointed object, such as a straightened paper clip, for 1 or 2 seconds.

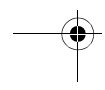
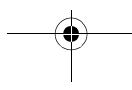
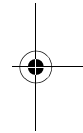
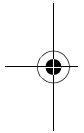
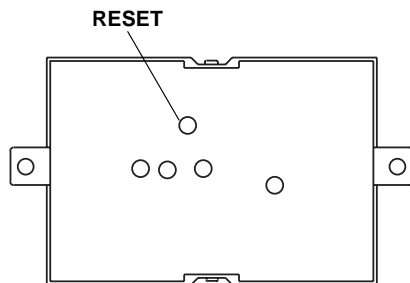

TROUBLESHOOTING

If your CD changer is not working as it should, these suggestions might help you eliminate the problem. If the CD changer still does not operate properly, take it to your local RadioShack store for assistance.

| Symptom | Possible Cause | Suggestion |
|---|---|--|
| No power — display does not light after vehicle power is turned on. | Power problem. CD changer/component's not connected to sound system/vehicle correctly. | Check the CD changer's and sound system's fuses and replace them if necessary (see "Replacing a Fuse" on Page 25). Check all connections. |
| No sound. | Vehicle radio's volume set to minimum. | Adjust the vehicle radio's volume. |
| | Vehicle radio not set to the proper FM frequency. | Set the vehicle's radio to FM band and tune to the frequency set on the FM modulator (89.1 MHz or 88.7 MHz). |
| | CD changer/components not connected to sound system/vehicle correctly. | Check all connections. |
| CD changer does not work. | Transport screws not removed from the CD changer. | Remove the transport screws from the CD changer (see "Removing the Transport Screws" on Page 8). |
| | No CDs loaded in CD magazine. | Load CDs in the CD magazine. |
| | CD magazine not loaded in the CD changer. | Load the CD magazine in the CD changer. |
| | CD loaded upside down in the CD magazine. | Load the CD correctly. |
| | CD is dirty or defective. | Clean the CD (see "CD Care Tips" on Page 24). Try another CD. |
| | CD changer must be reset. | Reset the CD changer (see "Resetting the CD Changer" on Page 24). |

| Symptom | Possible Cause | Suggestion |
|---|---|---|
| Sound from CD skips. | CD is dirty or defective. | Clean the CD and try it again or try another CD (see "CD Care Tips" on Page 24). |
| | H/V set incorrectly. | Check H/V on both sides of CD changer and reset if necessary (see "Mounting the CD Changer" on Page 13). |
| Static sounds on radio when CD stops playing. | FM modulator not set to a frequency with an active radio station. | Set 88.7 MHz/89.1 MHz to a frequency with an active radio station (if available). Note: If there is no active broadcast on 88.7 MHz or 89.1 MHz, you cannot eliminate these static sounds. |
| CD magazine does not eject from CD changer when is pressed. | CD changer requires power to eject CD magazine. | Turn on your vehicle's ignition and try again. |
| | | Check the CD changer's and sound system's fuses and replace them if necessary (see "Replacing a Fuse" on Page 25). |

CARE AND MAINTENANCE

Your 10 Disc CD Changer System is an example of superior design and craftsmanship. The following suggestions will help you care for your CD changer so you can enjoy it for years.



Keep the CD changer dry. If it gets wet, wipe it dry immediately. Liquids might contain minerals that can corrode the electronic circuits.



Use and store the CD changer only in normal temperature environments. Temperature extremes can shorten the life of electronic devices, damage batteries, and distort or melt plastic parts.



Keep the CD changer away from dust and dirt, which can cause premature wear of parts.



Handle the CD changer gently and carefully. Dropping it can damage circuit boards and cases and can cause the CD changer to work improperly.



Use only fresh batteries of the required size and recommended type. Batteries can leak chemicals that damage your remote control's electronic parts.



Wipe the CD changer with a damp cloth occasionally to keep it looking new. Do not use harsh chemicals, cleaning solvents, or strong detergents to clean the CD changer.

Modifying or tampering with the CD changer's internal components can cause a malfunction and might invalidate its warranty and void your FCC authorization to operate it. If your CD changer is not performing as it should, take it to your local RadioShack store for assistance.

THE FCC WANTS YOU TO KNOW

Your CD changer might cause TV or radio interference even when it is operating properly. To determine whether your CD changer is causing the interference, turn off your CD changer. If the interference goes away, your CD changer is causing it. Try to eliminate the interference by:

- Moving your CD changer away from the receiver.
- Contacting your local RadioShack store for help.

If you cannot eliminate the interference, the FCC requires that you stop using your CD changer.

CD CARE TIPS

Even though a CD is very durable, you should handle it with care. We recommend the following precautions.

- Keep the CD in its protective case or sleeve when you are not playing it.
- Handle a CD by its edges to avoid fingerprints which can prevent the CD changer's laser beams from accurately reading the CD. Your local RadioShack store sells a suitable CD cleaner kit.
- Do not write on either side of the CD, particularly the non-label side. (Signals are read from the non-label side.)

- Keep the CD dry. A water drop can act as a lens and affect the laser beam's focus.
- If you park your vehicle in the sun, temperatures inside the vehicle can easily reach levels that could damage your CDs. To prevent heat damage, avoid leaving your CDs in your vehicle.
- If a CD skips when you play it, the CD might be scratched. Your local RadioShack store sells a Scratch and Fix kit that might help remove the scratch and stop the skip.

RESETTING THE CD CHANGER

If your CD changer or any component locks up or does not work properly, or if the vehicle's battery loses power, follow these steps to reset the CD changer.

1. Turn on your vehicle's ignition.
2. Slide the CD changer's door all the way to the right.
3. With a pointed object, such as a straightened paper clip, press the reset hole (to the left of **EJECT** inside the CD changer) for about 2 seconds.

REPLACING A FUSE

If the CD changer or its components do not operate, you might need to replace the fuse from one or more of the power wires with one of the supplied fuses. Check all fuses.

The fuse for the yellow power wire on the CD changer must be 5.0 amps. On the Audio Adapter, the red power wire's fuse should be 0.5 amps, while the yellow continuous power wire's fuse must be 5 amps.

Warning: Before you begin, disconnect the cable from the vehicle battery's negative (-) terminal.

1. Unlatch the two latches on the fuse holder, so the holder springs open.
2. If a fuse is blown, replace it. Use only standard 1¹/₄-inch fuses with the proper rating.

Caution: The supplied spare fuses have the proper ratings. Make sure you replace a fuse only with another fuse of the same rating.

3. Reassemble the fuse holder by squeezing it together.
4. Reconnect the cable to the vehicle battery's negative (-) terminal.

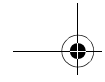

SPECIFICATIONS

CD CHANGER

Frequency Response:

20 Hz ± 3dB

10 kHz ± 3dB

20 kHz ± 3dB

Signal-to-Noise Ratio (1 kHz) 60 dB

Harmonic Distortion (1 kHz) 0.3%

Signal Format :

D-A Conversion 2-Channel Sigma Delta

Sampling Type/Frequency 8× Oversampling 44.1kHz

Pick-Up:

System Sanyo M90281

Wavelength 785–815 nm

CD Used (Diameter) 5 Inches (127 mm)

Power Source 14.4V DC Negative Ground

Power Consumption 3A Maximum

Unit Weight 6 lbs, 7 oz (2920 g)

Unit Dimensions (HWD) 3¹/₂ × 11⁷/₁₆ × 7⁵/₈ Inches (90 × 290 × 194 mm)

CONTROLLER/FM MODULATOR

Power Source 14.4 Volts DC Negative Ground

Unit Weight:

Controller 4 oz (120 g)

FM Modulator and Ground Isolator 14 oz (390 g)

Unit Dimensions (HWD):

Controller 1¹³/₁₆ × 3⁹/₁₆ × 1¹³/₁₆ Inches (47 × 91 × 2 mm)

FM Modulator and Ground Isolator 1 × 4¹/₈ × 3⁹/₁₆ Inches (26 × 105 × 90 mm)

Specifications are typical; individual units might vary. Specifications are subject to change and improvement without notice.

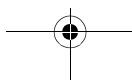

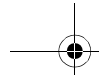

NOTES

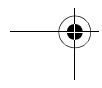
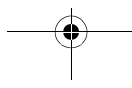
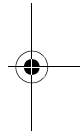
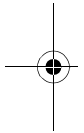

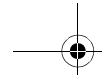

Limited One-Year Warranty

This product is warranted by RadioShack against manufacturing defects in material and workmanship under normal use for one (1) year from the date of purchase from RadioShack company-owned stores and authorized RadioShack franchisees and dealers. EXCEPT AS PROVIDED HEREIN, RadioShack MAKES NO EXPRESS WARRANTIES AND ANY IMPLIED WARRANTIES, INCLUDING THOSE OF MERCHANTABILITY AND FITNESS FOR A PARTICULAR PURPOSE, ARE LIMITED IN DURATION TO THE DURATION OF THE WRITTEN LIMITED WARRANTIES CONTAINED HEREIN. EXCEPT AS PROVIDED HEREIN, RadioShack SHALL HAVE NO LIABILITY OR RESPONSIBILITY TO CUSTOMER OR ANY OTHER PERSON OR ENTITY WITH RESPECT TO ANY LIABILITY, LOSS OR DAMAGE CAUSED DIRECTLY OR INDIRECTLY BY USE OR PERFORMANCE OF THE PRODUCT OR ARISING OUT OF ANY BREACH OF THIS WARRANTY, INCLUDING, BUT NOT LIMITED TO, ANY DAMAGES RESULTING FROM INCONVENIENCE, LOSS OF TIME, DATA, PROPERTY, REVENUE, OR PROFIT OR ANY INDIRECT, SPECIAL, INCIDENTAL, OR CONSEQUENTIAL DAMAGES, EVEN IF RadioShack HAS BEEN ADVISED OF THE POSSIBILITY OF SUCH DAMAGES.

Some states do not allow the limitations on how long an implied warranty lasts or the exclusion of incidental or consequential damages, so the above limitations or exclusions may not apply to you.

In the event of a product defect during the warranty period, take the product and the RadioShack sales receipt as proof of purchase date to any RadioShack store. RadioShack will, at its option, unless otherwise provided by law: (a) correct the defect by product repair without charge for parts and labor; (b) replace the product with one of the same or similar design; or (c) refund the purchase price. All replaced parts and products, and products on which a refund is made, become the property of RadioShack. New or reconditioned parts and products may be used in the performance of warranty service. Repaired or replaced parts and products are warranted for the remainder of the original warranty period. You will be charged for repair or replacement of the product made after the expiration of the warranty period.

This warranty does not cover: (a) damage or failure caused by or attributable to acts of God, abuse, accident, misuse, improper or abnormal usage, failure to follow instructions, improper installation or maintenance, alteration, lightning or other incidence of excess voltage or current; (b) any repairs other than those provided by a RadioShack Authorized Service Facility; (c) consumables such as fuses or batteries; (d) cosmetic damage; (e) transportation, shipping or insurance costs; or (f) costs of product removal, installation, set-up service adjustment or reinstallation.

This warranty gives you specific legal rights, and you may also have other rights which vary from state to state.

RadioShack Customer Relations, 200 Taylor Street, 6th Floor, Fort Worth, TX 76102

We Service What We Sell

04/99

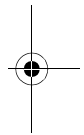
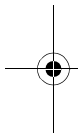

RadioShack
A Division of Tandy Corporation
Fort Worth, Texas 76102

09A99

Printed in China

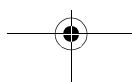

Free Manuals Download Website

<http://myh66.com>

<http://usermanuals.us>

<http://www.somanuals.com>

<http://www.4manuals.cc>

<http://www.manual-lib.com>

<http://www.404manual.com>

<http://www.luxmanual.com>

<http://aubethermostatmanual.com>

Golf course search by state

<http://golfingnear.com>

Email search by domain

<http://emailbydomain.com>

Auto manuals search

<http://auto.somanuals.com>

TV manuals search

<http://tv.somanuals.com>