

900 MHz Analog 2-Line Cordless Phone with CID/ Dual Keypad/ Speakerphone

43-683 **B**

OWNER'S MANUAL — Please read before using this equipment.

CONTENTS

Important Caller ID Information	2
Important Safety Instructions	3
Battery Safety Instructions	5
Installation	5
Connecting to Phone Lines	6
On a Desk Top	6
On a Wall or Wall Plate	7
Connecting and Charging the Battery Pack	8
Setting the Dialing Mode	9
Adjusting the Ringer	10
On the Handset	10
On the Base	10
Setting Auto Talk	10
Setting Caller ID/Call Waiting	10
Storing Your Area Code	11
Selecting a Language	11
Using the Handset	12
Making a Call	12
Answering a Call	12
Selecting the Channel	12
Setting the Handset Volume	12
Using the Speakerphone	13
Making a Call	13
Answering a Call	13
Adjusting the Speakerphone Volume	13
Using Mute	13
Putting a Call On Hold	14
Switching Between the Handset and Speakerphone	14
Using Both the Handset and Speakerphone	14
Using a Headset	15
Making a Conference Call	15
3-Way Conferencing	15
4-Way Conferencing	16
Extension Phones	16
Using Redial	16
Using Flash	17
Tone Services On a Pulse Line	17
Using the Paging/Intercom Features	17
Memory Dialing	18
Storing a Number in Memory	18

(Continued)

Two-Line Telephone System

— lets you easily handle two telephone lines at the same time. You can use both lines to make 3- or 4-way conference calls, or one line for data communication while you are talking on the other.

Speakerphone — lets you make or answer calls without using the handset.

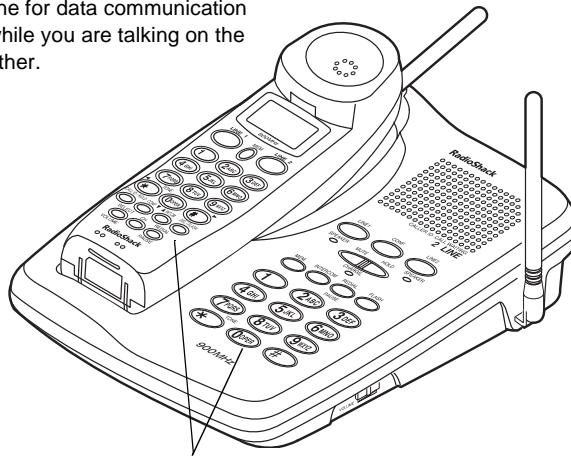

Dual Keypads — a full set of keys on both the phone's handset and base let you use either keypad to make and answer calls or use the phone's features.

Thank you for purchasing a RadioShack 900 MHz 2 Line Cordless Speakerphone. It uses advanced cordless telephone technology to give you superior audio quality and extended range. It is designed to exacting standards that ensure reliability, long life, and outstanding performance.

The phone's Caller ID memory records and stores up to 80 Caller ID records (40 for each line), including telephone number (and name, if available in your area) and the date and time of the call, as provided by your local phone company to Caller ID service subscribers. If you subscribe to Call Waiting with Caller ID, the phone can show you the incoming caller information, even when you are already on the phone.



RadioShack[®]

www.radioshack.comSM

© 2002 RadioShack Corporation.

All Rights Reserved.

RadioShack and RadioShack.com are trademarks used by RadioShack Corporation.



CONTENTS

(Continued)

In the Handset.....	18
Editing or Deleting a Number in the Handset's Memory	19
In the Base.....	20
Entering a Pause	20
Testing Stored Emergency Numbers	21
Reviewing Memory Numbers (Handset Only)	21
Dialing a Memory Number	21
Chain-Dialing Service Numbers	21
Caller ID Operation (Handset Only)	22
Reviewing Caller ID Records	22
Caller ID Messages	23
Adding/Deleting the Area Code	23
Dialing Numbers from a Caller ID Record	23
Storing a Caller ID Record to Memory	24
Deleting Caller ID Records	24
Troubleshooting	24
Care	26
Service and Repair	26
FCC Statement	27
Lightning	28



As an ENERGYSTAR Partner, RadioShack Corporation has determined that this product meets the ENERGYSTAR

WARNING: To reduce the risk of fire or shock	
	
CAUTION RISK OF ELECTRIC SHOCK DO NOT OPEN	
CAUTION: TO REDUCE THE RISK OF ELECTRIC SHOCK, DO NOT REMOVE COVER OR BACK. NO USER-SERVICEABLE PARTS INSIDE. REFER SERVICING TO QUALIFIED PERSONNEL.	
The lightning symbol is intended to alert you to the presence of uninsulated dangerous voltage within this product's enclosure that might be of sufficient magnitude to constitute a risk of electric shock. Do not open the product's case.	
The exclamation symbol is intended to inform you that important operating and maintenance instructions are included in the literature accompanying this product.	

3-Line Liquid Crystal Display — lets you view an entire Caller ID record on one screen.

40-Number Memory Dialing — lets you store up to 40 numbers in memory (30 on the handset and ten on the base) for easy dialing. (See “Memory Dialing” on Page 18.)

Paging/Two-Way Intercom System — lets you send a signal from the base to the handset, or from the handset to the base, to page someone or locate the handset when it is away from the base. If someone answers, you can use the phone as an intercom. (See “Using the Paging/Intercom Features” on Page 17.)

Face-down or Face-up Handset Charging — you can place the handset on the base face-down or face-up.

Ample Talk and Standby Time — the supplied battery pack provides 7 hours of continuous talk time or 14 days of standby time (when fully charged).

Headset Jack — lets you make or answer calls with hands-free convenience using an optional headset. (See “Using a Headset” on Page 15.)

Auto Talk — you can set the phone so you can answer a call by just lifting the handset from the base. (See “Setting Auto Talk” on Page 10.)

Any Key Answer — you can set the phone so you can press any key to answer a call when the handset is away from the base.

IMPORTANT CALLER ID INFORMATION

To use the phone's Caller ID and Call Waiting with Caller ID features, you must be in an area where those services are available and you must subscribe to those services through your local phone company. Where Caller ID is offered, one or more options are generally available:

- caller's number only
- caller's name only
- caller's name and number.





IMPORTANT SAFETY INSTRUCTIONS

When using your telephone equipment, basic safety precautions should always be followed to reduce the risk of fire, electric shock and injury to persons, including the following:

1. Read and understand all instructions.
2. Follow all warnings and instructions marked on the product.
3. Never install telephone wiring during a lightning storm.
4. Never install telephone jacks in wet locations unless the jack is specifically designed for wet locations.
5. Never touch uninsulated telephone wires or terminals unless the telephone line has been disconnected at the network interface.
6. Use caution when installing or modifying telephone lines.
7. Do not fix the AC power supply cord to building surfaces with metal fittings (If the product has an AC power cord).
8. Unplug this product from the wall outlet before cleaning. Do not use liquid cleaners or aerosol cleaners. Use a damp cloth for cleaning.
9. Do not use this product near water, for example, near a bath tub, wash bowl, kitchen sink, or laundry tub, in a wet basement, or near a swimming pool.
10. Do not place this product on an unstable cart, stand, or table. The product may fall, causing serious damage to the product.
11. Slots and openings in the cabinet and the back or bottom are provided for ventilation. To protect it from overheating, these openings must not be blocked or covered. The openings should never be blocked by placing the product on a bed, sofa, rug, or other similar surface. This product should never be placed near or over a radiator or heat register. This product should not be placed in a built-in installation unless proper ventilation is provided.

! IMPORTANT !

If an icon appears at the end of a paragraph, go to the box on that page with the corresponding icon for pertinent information.

-  — Warning  — Important
 — Caution  — Hint
 — Note

12. This product should be operated only from the type of power source indicated on the marking label. If you are not sure of the type of power supply to your home, consult your local power company.
13. Do not allow anything to rest on the power cord. Do not locate this product where the cord will be stepped on.
14. Do not overload wall outlets and extension cords as this can result in a risk of fire or electric shock.
15. Never push objects of any kind into this product through cabinet slots as they may touch dangerous voltage points or short out parts that could result in a risk of fire or electric shock. Never spill liquid of any kind on the product.
16. To reduce the risk of electric shock, do not disassemble this product. Take it to a qualified serviceman when service or repair work is required. Opening or removing covers may expose you to dangerous voltage or other risks. Incorrect reassembly can cause electric shock when the product is subsequently used.
17. Unplug this product from the wall outlet and refer servicing to qualified service personnel under the following conditions:
 - When the power cord plug is damaged or frayed.
 - If liquid has been spilled into the product.
 - If the product has been exposed to rain or water.
 - If the product does not operate normally by following the operating instructions.
 - Adjust only those controls that are covered by the operating instructions because improper adjustment of other controls may result in damage and will often require extensive work by a qualified technician to restore the product to normal operation.
 - If the product has been dropped or the cabinet has been damaged.
 - If the product exhibits a distinct change in performance.
18. Avoid using a telephone (other than a cordless type) during an electrical storm. There may be a remote risk of electric shock from lightning.

19. Do not use the telephone to report a gas leak in the vicinity of the leak.

BATTERY SAFETY INSTRUCTIONS

1. Use only the appropriate type and size of battery pack specified in the instruction manual provided for this product.
2. Do not dispose of the battery pack in a fire. The cell may explode. Check with local codes for possible special disposal instructions.
3. Do not open or mutilate the battery pack. Released electrolyte is corrosive and may cause damage to the eyes or skin. It may be toxic if swallowed.
4. Exercise care in handling the battery pack in order not to short it with conducting materials such as rings, bracelets, and keys. The battery or conductor may overheat and cause burns.
5. Charge the battery pack provided with or identified for use with this product only in accordance with the instructions and limitations specified in this owner's manual.
6. Observe proper polarity orientation between the battery pack and the battery charger.

SAVE THESE INSTRUCTIONS

INSTALLATION

You can place the phone's base on a desk or table, or mount it on a standard wall plate or directly on a wall. Choose a location that is:

- near an AC outlet
- near a modular telephone line jack
- out of the way of normal activities
- away from electrical machinery, electrical appliances, metal walls or filing cabinets, wireless intercoms, alarms, and room monitors
- away from other cordless phones

The base's location affects the handset's range. If you have a choice of several locations, try each to see which provides the best performance.

CAUTION

TO REDUCE THE RISK OF FIRE OR INJURY, READ AND FOLLOW THE INSTRUCTIONS.

✔ **NOTE** ✔

Connecting to Phone Lines

- The line that connects a two-line phone jack to the phone company wiring must be twisted-pair cable. Otherwise, you might hear interference (crosstalk) between the two lines.
- The USOC number of the two-line jack to be installed is RJ14C (RJ14W for a wall-plate). The USOC number of a single-line jack is RJ11C.

On a Desk Top

- If you connect the phone to a two-line phone jack with a two-line cord, do not connect a cord to the **TEL LINE 2** jack or the phone will not operate properly. Instead, you can connect another phone device, such as a fax machine or modem.
- If you connect the phone to a single one-line phone jack, avoid pressing the unused line button or you might hear feedback.

⚡ **CAUTION** ⚡



You must use a Class 2 power source that supplies 9V AC and delivers at least 350 mA. Its center tip must be set to positive and its plug must fit the phone's **DC IN 9V** jack. The supplied adapter meets these specifications. Using an adapter that does not meet these specifications could damage the phone or the adapter.

- Always connect the AC adapter to the phone before you connect it to AC power. When you finish, disconnect the adapter from AC power before you disconnect it from the phone.

CONNECTING TO PHONE LINES

To take full advantage of the phone's capabilities, you must have two phone lines with separate phone numbers. If you have only one line, you can order a second from your phone company.

You can connect the phone to the lines in one of three ways:

- connect two lines through a two-line modular phone jack
- connect two lines through two one-line modular phone jacks
- connect one line through a one-line modular phone jack.

Your telephone connects directly to a modular telephone line jack. If your telephone wiring does not have a modular jack, you can update the wiring yourself using jacks and adapters (available at your local RadioShack store or online at RadioShack.com), or have the telephone company update the wiring for you. You must use compatible modular jacks that are compliant with Part 68 of *FCC Rules*.

ON A DESK TOP

1. To connect the phone to a two-line phone jack, plug one end of the supplied long two-line modular cord into the **TEL LINE 1/2** jack on the back of the phone.

To connect the phone to two one-line phone jacks, plug one end of the supplied long two-line modular cord into **TEL LINE 1/2** and plug another cord (not supplied) into the **TEL LINE 2** jack.

To connect the phone to a single one-line phone jack, plug one end of the supplied long modular cord into the **TEL LINE 1/2** or **TEL LINE 2** jack.

2. Plug the supplied AC adapter's barrel plug into the **DC IN 9V** jack on the back of the base.
3. Route the adapter's cord through the strain relief slot on the bottom of the bracket.
4. Plug the adapter into a standard AC outlet.
5. Connect the phone cord(s) to the modular phone line jack(s).
6. Lift the base's antenna to a vertical position.

ON A WALL OR WALL PLATE

To mount the base directly on the wall, you need two screws (not supplied) with heads that fit into the keyhole slots on the bottom of the bracket. Drill two holes $3^{15}/16$ inches apart. Then thread a screw into each hole, letting the heads extend about $5/32$ inch from the wall.

1. Insert the two tabs at the top of the narrow end of the supplied bracket into the base's upper tab slots, then press down on the bracket's latches and insert them into the clip slots.

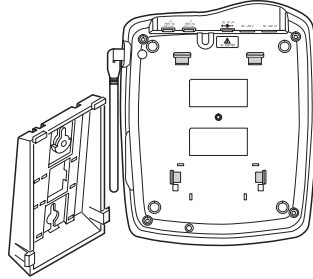

2. To connect the phone to a two-line phone jack, plug one end of the supplied long modular cord into the **TEL LINE 1/2** jack on the back of the phone.

To connect the phone to two one-line phone jacks, plug one end of the supplied short two-line modular cord into **TEL LINE 1/2** and plug another cord (not supplied) into the **TEL LINE 2** jack.

To connect the phone to a single one-line phone jack, plug one end of the supplied long modular cord into the **TEL LINE 1/2** or **TEL LINE 2** jack.

3. Insert the supplied AC adapter's barrel plug into the **DC IN 9V** jack on the back of the base.
4. Route the adapter's cord through the narrow groove on the bracket. If you are using two phone cords, route the second cord through one of the wide grooves on the bracket.

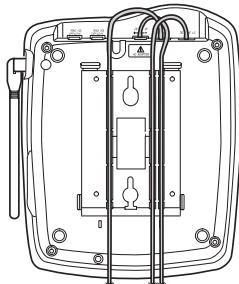

NOTE

If you connect the phone to a two-line phone jack with a two-line cord, do not connect a cord to the **TEL LINE 2** jack or the phone will not operate properly.

☑ **NOTE** ☑

- If the base loses power for 60 minutes while the handset is away from it, the security code might be lost. To reset the code, return the handset to the base for about five seconds.
- Using a pencil eraser, clean the charging contacts on the handset and base about once a month.
- If the battery pack becomes weak during a call, the handset beeps every three seconds and **Low Battery** flashes. When this happens, you cannot make a call until you recharge the battery pack.
- About once a month, fully discharge the battery by keeping the handset off the base until **Low Battery** flashes. Otherwise, the battery pack loses its ability to fully recharge.
- If the display is blank and the phone does not work, recharge the battery pack. (The battery power might be too low to light the display.)
- If you are not going to use your phone for an extended period of time, disconnect the battery pack. This increases the battery pack's usable life.

5. To mount the phone on a wall plate, plug the other end of the short modular cord into the wall plate jack, then align the bracket's keyhole slots with the wall plate studs and slide the base downward to secure it. If you are using two phone cords, plug the second cord into the second phone jack.

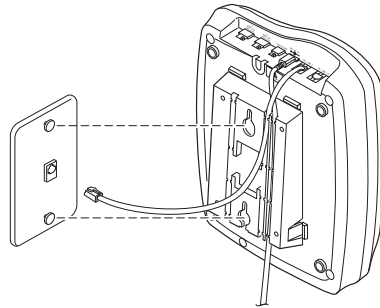

To mount the phone directly on a wall, align the bracket's keyhole slots with the mounted screws and slide the base downward to secure it. Connect the phone cord(s) to the modular phone line jack(s).

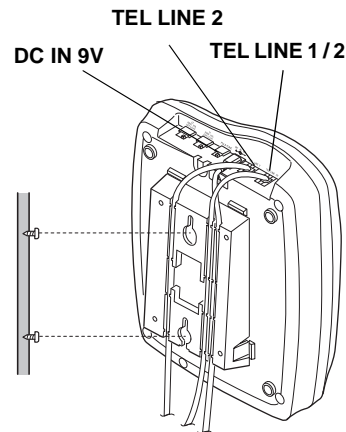

6. Plug the adapter into a standard AC outlet.
7. Press and lift out the handset holder, flip it over, then snap it back into place to hold the handset.
8. Raise the base's antenna to a vertical position.

CONNECTING AND CHARGING THE BATTERY PACK

The phone comes with a rechargeable nickel-cadmium (Ni-Cd) battery pack in the handset. Before using your phone, you must connect the battery pack, then charge it for about 15–20 hours. ☑

1. Press down and slide off the battery pack compartment cover.
2. Lift the battery pack out of the compartment.

3. Plug the battery pack's connector into the socket in the compartment, (the connector fits only one way), replace the battery pack, and replace the cover.

To charge the battery pack, place the handset either face-up or face-down on the base.

The CHARGE indicator on the base lights and the number of new and total Caller ID records for each line appears on the handset's display. Be sure the battery pack is properly connected before you try to charge it. The CHARGE indicator lights when the handset is on the base even if the battery pack is not properly connected.

Recharge the battery pack when **Low Battery** flashes.

When you first use the phone after charging or recharging the battery pack, the phone might not work and you might hear a beep when you press **LINE 1** or **LINE 2**. Return the handset to the base for about five seconds to reset the security access-protection code.

The supplied battery pack should last about a year. If the battery pack does not hold a charge for more than 2 hours after an overnight charge, replace it with a new 3.6-volt, 600 mAh battery pack with a connector that fits the socket in the battery compartment.

You can order a replacement battery pack through RadioShack. Install the new battery pack and charge it for about 15–20 hours. ⚠

If you have trouble replacing the battery pack, take the phone to RadioShack for assistance.!

SETTING THE DIALING MODE

Your phone comes set for tone dialing. If you have pulse service, you must change the dialing mode. If you are not sure which type of service you have, do this test.

1. Press **LINE 1** or **LINE 2** and listen for a dial tone.
2. Press any number other than 0. ☑

If the dial tone stops, you have touch-tone service. If the dial tone continues, you have pulse service.

To set the dialing mode, press the line button to hang up the phone if necessary. Hold down **FLASH** on the base keypad until the phone beeps, then press **#** for pulse dialing or ***** for tone dialing. The phone beeps.

⚠ WARNING ⚠

Dispose of the old battery pack promptly and properly. Do not burn or bury it (see "Battery Safety Instructions+" on Page 5).

! IMPORTANT !

The EPA certified RBRC® Battery Recycling Seal on the nickel-cadmium (Ni-Cd) battery indicates RadioShack is voluntarily participating in an industry program to collect and recycle these batteries at the end of their useful life, when taken out of service in the United States or Canada. The RBRC program provides a convenient alternative to placing used Ni-Cd batteries into the trash or the municipal waste stream, which may be illegal in your area. Please call 1-800-THE-SHACK (1-800-843-7422) for information on Ni-Cd battery recycling and disposal bans/restrictions in your area. RadioShack's involvement in this program is part of the company's commitment to preserving our environment and conserving our natural resources.



☑ NOTE ☑

- If your phone system requires that you dial an access code (9, for example) before you dial an outside number, do not press the access code either.
- The phone exits setting mode if a call is received, or if you press either line button.

ADJUSTING THE RINGER

The phone lets you control its base and handset ringer volume separately. You can choose from a high or low ringer setting for the base and the handset.

ON THE HANDSET

At any time except during a call, press **SELECT/VOLUME** to set the handset's ringer volume. The display shows **Ringer High** or **Ringer Low**.

ON THE BASE

Set **RING VOL** on the back of the base to **HI**, **LO**, or **OFF** for each line (L1 and L2). With **RING VOL** set to **OFF**, the base's ringer does not sound when a call is received, but the handset (and any other phone connected to the same line) still rings.

SETTING AUTO TALK

Your phone is preset so you must press **LINE 1** or **LINE 2** to answer a call. With Auto Talk turned on, you can answer a call by lifting the handset from the base or pressing any number key on the base (or any key on the handset if the handset is away from the base).

1. To turn Auto Talk on or off, lift the handset and hold down **CALL ID/HOLD** until the menu appears with the pointer at Line 1.
2. Use **▲/INTCM** or **CONF/▼** to select Line 1 or Line 2. Then press **#/▶**. A menu appears with **Auto Talk** selected.
3. Press **SELECT/VOLUME** to change the setting. **On** or **Off** appears indicating the selected setting.
4. Return the handset to the base.

NOTE

Auto Talk is set for each line separately. For example, when you turn Auto Talk on for Line 1 only, you must press **LINE 2** to answer a call on line 2.

SETTING CALLER ID/CALL WAITING

If you have Call Waiting and Caller ID service, you can set the phone to show Caller ID information for an incoming call even while you are already on the phone. Caller ID/Call Waiting is set separately for each line.

1. Lift the handset and hold down **CALL ID/HOLD** until the menu appears with **Line 1** selected.

2. Use **▲/INTCM** or **CONF/▼** to select Line 1 or Line 2. Then press **#/▶**.
3. A menu appears with **Auto Talk** selected. Press **CONF/▼** to select **CIDCW**, then press **SELECT/VOLUME** to change the setting. **On** or **Off** appears indicating the selected setting.
4. Return the handset to the base to store the new setting.

STORING YOUR AREA CODE

You can store your local area code in the phone's Caller ID memory so it does not show the area code if the received call is from your local area. If you need to dial the area code (or store it in the memory), you can add it afterwards. See "Adding/Deleting the Area Code" on Page 23.

1. Lift the handset and hold down **CALL ID/HOLD** until the menu appears with **Line 1** selected.
2. Use **▲/INTCM** or **CONF/▼** to select **Line 1** or **Line 2**. Then press **#/▶**. A menu appears with **Auto Talk** selected.
3. Press **CONF/▼** twice to select **Area Code**, then press **SELECT/VOLUME**.
4. Enter your 3-digit area code using the number keys. If you make a mistake, repeatedly press **◀/* or #/▶** to move the cursor over the incorrect digit, then enter the correct number.
5. Press **SELECT/VOLUME** to store the area code.

SELECTING A LANGUAGE

You can set the display's language to English or French. To select the language:

1. Lift the handset and hold down **CALL ID/HOLD** until the menu appears with **Line 1** selected.
2. Use **▲/INTCM** or **CONF/▼** to select **Language**.
3. Press **SELECT/VOLUME** to select **Eng** (English) or **Fr.** (French).

NOTE

- If your calling area requires 10-digit dialing including area code, do not enter the area code but leave this option blank.
- If an area code is already stored, it appears when you press **SELECT/VOLUME**. To delete the area code, press **DEL/FLASH** three times.

📄 **NOTE** 📄

- You can use the keypad on either the handset or the base to operate the phone. To make a call with the speakerphone, you must use the base's keypad; to make a call with the handset, you must use the handset's keypad.
- If **Base** appears above Line 1 or Line 2 on the display, someone is using that line at the base. Press the other line button.
- You can also enter the number before pressing **LINE 1** or **LINE 2**. The entered number appears on the display. After confirming the number is correct, press **LINE 1** or **LINE 2**.

USING THE HANDSET

MAKING A CALL

1. Lift the handset and press **LINE 1** or **LINE 2**. **Line 1** or **Line 2** appears on the handset's display and the same line's indicator on the base flashes green.
2. Dial the number. Within a few seconds, the display starts to count the elapsed time.📄
3. To end a call, press **LINE 1** or **LINE 2** on the handset or place the handset on the base.

ANSWERING A CALL

When a call comes in, **Call** appears on the display, along with **Line 1** or **Line 2** (whichever is ringing). Then the display shows the caller's name (if available) and number (if you subscribe to Caller ID), and the indicator for that line flashes at the base. To help you tell which line is ringing, each line has a distinctive tone.

To answer a call, lift the handset and press the ringing line button. If Auto Talk is on, lift the handset from the base, or if the handset is away from the base, press any key. The display changes to show the elapsed time on the call.

If you receive a call on one line while you are using the handset to talk on the other, you hear a three-ring tone through the handset. Press the line button for the incoming call's line. The current call is automatically put on hold.

If both lines have an incoming call, pressing a key answers the line that began ringing first.

Selecting the Channel

The phone has 20 channels. If a call disconnects for no reason, press **CH** on the handset to select a different channel.

Setting the Handset Volume

To increase or decrease the handset's volume during a call, press **SELECT/VOLUME**. Each time you press the button, the volume setting changes and the display shows the level as **Volume Low**, **Volume Medium**, **Volume High**, or **Volume Maximum**.

USING THE SPEAKERPHONE

MAKING A CALL

To make a call using the speakerphone, press **LINE 1** or **LINE 2**, listen for the dial tone, then dial the number. The **LINE 1 SPEAKER** or **LINE 2 SPEAKER** indicator lights green on the base, and **Base** and **Line 1** or **Line 2** appear on the handset's display as a reminder that the line is in use.

If either line indicator is flashing, someone at the handset is using the line. Press the line button for the line that is not in use.

To end a speakerphone call, simply press **LINE 1** or **LINE 2**. The line indicator turns off.

ANSWERING A CALL

To answer a call using the speakerphone, press **LINE 1** or **LINE 2** (whichever is flashing), or any number key. The line indicator for the selected line lights. **Base** and **Line 1** or **Line 2** appear on the handset's display as a reminder that the line is in use.

If you receive a call on a line while you are talking on the speakerphone on the other line, the other line's indicator flashes and you hear a low ring if you have set **RING VOL** for that line to any position other than **OFF**. Press the line button for the incoming call. The current call is automatically put on hold.

Adjusting the Speakerphone Volume

To set the speakerphone's volume, slide **VOLUME** on the right side of the base.

USING MUTE

While talking on the speakerphone, you can temporarily turn off the phone's microphone by pressing **MUTE** so the other party cannot hear you. The line indicator flashes red when a line is muted. Press **MUTE** again to resume your conversation. ☑

☑ NOTE ☑

Mute is released when you press **INTERCOM**, **HOLD**, or press either line button to switch the line.

☑ **NOTE** ☑

Putting a Call On Hold

Pressing **HOLD** (or **CALL ID/HOLD**) again while a call is on hold does not release the hold. Press the line button that is on hold.

Using Both the Handset and Speakerphone

If you hear a high-pitched noise from the base's speaker, the handset and the base are too close together.

PUTTING A CALL ON HOLD

To put a call on hold, press **HOLD** (**CALL ID/HOLD** on the handset). The indicator for that line lights red on the base, and the handset display shows **Hold** above the line number. While a call is on hold, you can temporarily place the handset on the base or use the other phone line without disconnecting the current call. ☑

To release a line from hold and continue your conversation, press that line's button on the handset or base. You can also release a call from hold by lifting the handset if the handset is on the base, or picking up an extension phone.

You can alternate between the two lines by pressing **HOLD**, then the button for the desired line.

SWITCHING BETWEEN THE HANDSET AND SPEAKERPHONE

*To switch to the speakerphone while you are using the handset, press **CALL ID/HOLD** on the handset, then press the in-use line's button (**LINE 1** or **LINE 2**) on the base.*

*To switch to the handset while you are using the speakerphone, just lift the handset off the base. Or, if the handset is off the base, press **HOLD** on the base, then press the in-use line's button (**LINE 1** or **LINE 2**) on the handset.*

USING BOTH THE HANDSET AND SPEAKERPHONE

To use the handset to join a call at the base, or to use the base to join a conversation at the handset, press the line button for the line that is in use. You hear a busy tone. Before the tone ends, press the line button again.

During the call, one party can hang up and the call can continue. To end the call, you must hang up both the base and handset. ☑

To talk with two parties using both lines, see "4-Way Conferencing" on Page 16.

USING A HEADSET

You can make or answer calls with handsfree convenience using an optional headset (available at RadioShack) that has a $\frac{3}{32}$ -inch plug.

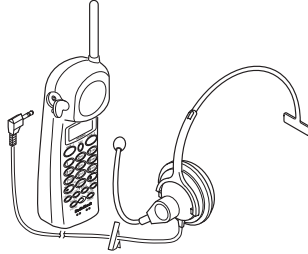

To connect the headset, pull open the rubber cover on the side of the handset, then insert the $\frac{3}{32}$ -inch plug into the jack. ✓

With a headset connected, you make or answer calls as usual using the keys on the handset.

You can use a handset holder (available at RadioShack) to hang the handset on your belt for greater convenience.

When you finish using the headset, disconnect it from the handset and close the rubber cover to protect the jack.

MAKING A CONFERENCE CALL

3-WAY CONFERENCING

Follow these steps to use both phone lines to set up a 3-way call. The procedure is the same for the handset and the base.

1. Place the first call on hold.
2. Make or answer a call on the other line.
3. Once you have the second party on the line, press **CONF** (**CONF/▼** on the handset) to bring in the first party. If you are using the handset, both line indicators on the base flash green. If you are using the speakerphone, the indicators stay lit green. The handset displays **Conference** above **Line 1, Line 2** if you are using the handset. **Conf Base** and **Line 1, Line 2** appear if you are using the speakerphone.
4. *To end the conference call*, press one line button, then the other.

To hang up one line and continue talking on the other, press the line button you want to hang up.

NOTE

- Connecting a headset disconnects the handset's earpiece and microphone, but it does not affect the speakerphone.
- **SELECT/VOLUME** on the handset also controls the connected headset's volume.
- If you place the handset on the base face down to recharge it while the headset is connected, be sure the handset seats properly.

☑ **NOTE** ☑

Extension Phones

If you hang up the phone and someone is still on that line on an extension, the phone's line indicator(s) might not stay lit.

Using Redial

- Each keypad has a separate redial memory. You cannot redial a number you dialed on one keypad using the redial key on the other.
- The redial memory is common to both lines. You can redial the number you originally dialed on Line 1 using Line 2, as long as you use the same keypad as previous.
- The redial memory holds up to 32 digits, so you can redial long distance as well as local numbers.

To talk on one line without disconnecting the other, press **HOLD** or **CALL ID/HOLD**, then the button for the line you want to talk on. To return to a 3-way conversation, press **CONF** or **CONF/▼**.

4-WAY CONFERENCING

Follow these steps to use both lines and the phone's intercom function to set up a four-way call (see "Using the Paging/Intercom Features" on Page 17).

1. Make a 3-way conference call.
2. Press **▲/INTCM** on the handset or **INTERCOM** on the base to page the other keypad. The two outside lines are automatically put on hold, but the parties on both lines can talk to each other.

To answer the page, press **▲/INTCM** on the handset, or **INTERCOM** on the base, then press **CONF/▼** on the handset or **CONF** on the base.

To end the conference call, press **LINE 1** and **LINE 2** on one keypad, then press **LINE 2** on the other keypad.

To hang up one line and continue talking on the other, press the line button that you want to hang up.

You can also make a conference call using both the phone and an extension phone. (See "Extension Phones".)

EXTENSION PHONES

The phone detects when an extension phone is in use. The corresponding line indicator flashes on the base and **In Use** flashes on the handset's display along with **Line 1** or **Line 2**.

To join the conversation from the handset or base, press the line button for the in-use line. While the busy tone is sounding, press the line button again. ☑

USING REDIAL

You can quickly dial the last number dialed on either line. When you hear a dial tone, simply press **REDIAL/PAUSE** on the base or the handset. ☑

USING FLASH

FLASH (DEL/FLASH on the handset) performs the electronic equivalent of a switchhook operation for special services, such as Call Waiting.

For example, if you have Call Waiting, press **FLASH** to answer an incoming call without disconnecting the current call. Press **FLASH** again to return to the first call. ☑

TONE SERVICES ON A PULSE LINE

Some special services, such as bank-by-phone, require tone signals. If you have pulse service, you can still use these special tone services by following these steps.

Dial the service's main number. When the service answers, press **TONE/***. Any additional numbers you dial are sent as tone signals. When you hang up, the phone automatically resets to pulse dialing.

USING THE PAGING/INTERCOM FEATURES

You can use the phone as a two-way pager and intercom between the base and the handset. This is useful if the handset is away from the base and you want to locate it, or if you want to have a conversation between the handset and the base.

*To page the handset from the base, press **INTERCOM**. The handset rings, and **Paging** appears on the handset's display. Press **▲/INTCM** on the handset to answer the page. **intercom** appears.*

*To page the base from the handset, press **▲/INTCM**. **Paging Base** appears, and the base rings. Press **INTERCOM** on the base to answer the page. **intercom** appears on the handset's display. ☑*

*To end an intercom call, press **▲/INTCM** or **INTERCOM**.*

During a call, you can page someone at either the base or the handset to join the conversation.

1. Press **INTERCOM** or **▲/INTCM**. The current call is placed on hold.

☑ NOTE ☑

Using Flash

If you do not have any special services, pressing **FLASH** might disconnect the current call.

Using the Paging/Intercom Features

- The paging ends in one minute if nobody answers. Press **INTERCOM** or **▲/INTCM** again.
- You cannot page the base or handset if it is already in use. You hear a warning tone.
- If a call comes in during an intercom conversation, either of the intercom parties can answer the call as they normally would by pressing the ringing line's button. The intercom call automatically disconnects.

2. Press **INTERCOM** or **▲/INTCM** again to transfer the call when the person at the base or handset answers.

To start a 3-way call, tell the person at the base or handset to press the line button for the call, then press the same button twice on your keypad when they answer the page.

MEMORY DIALING

You can store up to 30 numbers in the handset's memory and another 10 in the base's memory, then dial a stored number by pressing a memory location number. You can also store a name with each number in the handset's memory. Each stored number can be up to 20 digits long, and each name can be up to 13 characters.

You cannot dial a number stored in one memory location (the base or the handset) using the keypad on the other.

STORING A NUMBER IN MEMORY

In the Handset

1. Lift the handset.
2. Hold down **MEM** until **Memory Store** and a list of memory location numbers (and names, if any) appears.
3. Select an empty memory location (or one you want to replace) by entering the location number (01–30) or using **▲/INTCM** or **CONF/▼** to scroll through the list. Precede a single-digit number with a 0 (for example, 01, 02, 03, etc.).
4. Press **SELECT/VOLUME**. **Store name** appears. If you do not want to enter a name, skip to Step 6.
5. *To enter a name*, use the number keys. Refer to the letters on the number keys to select the desired letter. Press the key once for the first letter in upper case, press twice for the second letter in upper case, and so on. To enter the lower case letter, press four times (or five times) to display the first letter in lower case, five or six times for the second letter, and so on.

For example, to enter John: press **5** once; upper case **J** appears. Then press **6** six times; lower case **n** appears. Press **4** five times; lower case **h** appears. Finally, press **6** five times; lower case **n** appears.

NOTE

- An error tone sounds and the phone exits the storing process if you wait more than 30 seconds between key presses.
- If the phone sounds five quick beeps, you have made an entry error and the number was not stored. Re-enter the location number.
- Each tone or pause entry uses one digit of memory.

To enter two letters from the same key in a row, press #/ ▶ to move the cursor to the next position. For example to enter AB, press 2; **A** appears. Then press #/ ▶, the cursor moves to the next position, then press 2 twice so **B** appears.

To enter a space, press #/ ▶ twice without entering any character.

To enter a number, repeatedly press the corresponding number key until the number appears.

To enter a special character, use 0. Each time you press 0, the characters appear in this order:

• # - & { } (space) 0

If you make a mistake, use ◀ /* or #/ ▶ to move the cursor over the error, then enter the correct character, or press **DEL/FLASH** to delete a character. To delete all characters, hold down **DEL/FLASH** for at least 1 second.

6. Press **SELECT/VOLUME**. **Store number** appears.
7. Enter the number and any tone and pause entries (see "Tone Services On a Pulse Line" on Page 17 and "Entering a Pause" on Page 20).
8. Press **SELECT/VOLUME**. The phone beeps and **Memory nn Stored** appears. After 2 seconds, **Memory Store** appears, and you can repeat Steps 3 – 8 to store more numbers.

To replace a stored number, simply store a new one in its place.

Editing or Deleting a Number in the Handset's Memory

1. Lift the handset.
2. Hold down **MEM** until **Memory Store** and a list of memory location numbers (and names, if any) appears.
3. Choose a memory location you want to edit or delete by pressing ▲/INTCM or **CONF**/▼, or entering its location number.
4. Press **SELECT/VOLUME**. Three options (**Edit Memory nn**, **Delete Memory nn**, and **Go Back**) appear. Press ▲/INTCM or **CONF**/▼ to choose an option, follow the instructions listed, then press **SELECT/VOLUME**.

Edit Memory nn — Edit the record as described in Steps 5–8 of “In the Handset” on Page 18.

Delete Memory nn — The display prompts you to confirm the deletion. Move the cursor to **Yes** or **No**, then press **SELECT/VOLUME**. The phone beeps, and **Memory nn Deleted** appears.

Go Back — Returns you to the list of memory numbers.

When you finish editing or deleting memory numbers, press **MEM** or return the handset to the base to exit the Memory Store display.

In the Base

1. Press **MEM**. The CHARGE indicator blinks.
2. Enter the number (up to 20 digits) and any tone mode changes or pause entries (see “Tone Services On a Pulse Line” on Page 17 or “Entering a Pause”).
3. Press **MEM** again, then enter the memory location number (0 – 9) where you want to store the number. A tone sounds to indicate that the number is stored.

To clear a stored number, simply store a new number in its place. Or, press **MEM** twice. Then press the memory location number (0 – 9) you want to clear. A tone sounds.

Use the supplied memory directory sticker to record your stored numbers. Peel the backing from the sticker and attach it to the base.

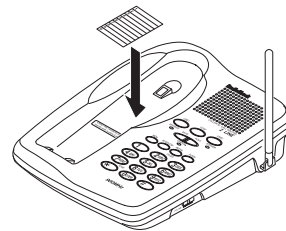

ENTERING A PAUSE

In some telephone systems, you must dial an access code (9, for example) and wait for a second dial tone before you can dial an outside number. You can store the access code with the phone number. However, you should also store a pause after the access code to allow the outside line time to connect.

To enter a 2-second pause, press **REDIAL/PAUSE**. The handset display shows **P** for pause entry. For a longer pause, repeatedly press **REDIAL/PAUSE**.

TESTING STORED EMERGENCY NUMBERS

If you store an emergency service's number (police department, fire department, ambulance) and you choose to test the stored number, make the test call during the late evening or early morning hours to avoid peak demand periods. Also, remain on the line to explain the reason for your call.

REVIEWING MEMORY NUMBERS (HANDSET ONLY)

To review your memory numbers, press **MEM**. The list of memory location numbers appears with the stored name (or **memory nn** if you did not store a name). If necessary, scroll through the list by repeatedly pressing **CONF/▼** or **▲/INTCM**, or by entering the two-digit location number (01, 02, 03, etc.).

To see the stored phone numbers, press **#/▶**. An arrow to the right of the number means it is longer than 14 digits. Press **#/▶** again to see the rest of the number. Repeatedly press **◀/*** to return to the name display.

To exit the memory number list, press **MEM**.

To see a stored name and phone number at the same time, press **SELECT/VOLUME** when the cursor is by a memory location number. To exit this display without storing any changes, hold down **DEL/FLASH** until the display clears.

DIALING A MEMORY NUMBER

To dial a number stored in the handset's memory, lift the handset and press **MEM**. The first three memory location numbers appear. Choose a memory location (01–30) by pressing number keys or repeatedly pressing **▲/INTCM** or **CONF/▼**, then press **LINE 1** or **LINE 2**. The phone automatically dials out the number. ☑

To dial a number stored in the base's memory, press **LINE 1** or **LINE 2**. When you hear a dial tone, press **MEM** and enter the memory location number for the number you want to dial.

CHAIN-DIALING SERVICE NUMBERS

For quick recall of numbers for special services (such as alternate long distance or bank by phone), store each group of numbers in its own memory location.

NOTE

- You can also press **LINE 1** or **LINE 2** first, then choose a memory number to dial.
- If you select an empty memory location, the base beeps five times.

To use the stored special service numbers, dial the service's main number first. Then, at the appropriate place in the call, press **MEM** and the number for the memory location where the additional information is stored.

CALLER ID OPERATION (HANDSET ONLY)

If you subscribe to Caller ID service from your phone company, the phone company sends information about the call, as well as the time and date, between the first and second rings of every call you receive. Although the Caller ID memory is on the handset, it also records information from calls you receive on the speakerphone.

The phone displays this information when it receives a call, and it stores up to 80 Caller ID records (40 each for both lines) for later review. It also shows if caller information is unavailable or if the name and number were blocked by the caller (see "Caller ID Messages" on Page 23).

If you subscribe to Call Waiting with Caller ID, you will hear a tone through the handset when a call comes in, then the Caller ID record appears. If you want to answer the incoming call, press **DEL/FLASH**. To resume the previous phone conversation, press **DEL/FLASH** again.

If the phone's Caller ID memory becomes full, any new call replaces the oldest call's record.

REVIEWING CALLER ID RECORDS

To review the Caller ID records, lift the handset if necessary and press **CALL ID/HOLD**. Numbers of new and total Caller ID records for each line appear. Press **◀/* or #/▶** to select the line you want to view, then press **CONF/▼** or **▲/INTCM**.

Repeatedly press **CONF/▼** to scroll through the Caller ID records from the newest to the oldest, or **▲/INTCM** to scroll back through the records. To scroll quickly through the records, hold down **CONF/▼** or **▲/INTCM**.

The top line of each record shows the date, time and the number of calls from that number. The second line shows the caller's name, and the third line shows the caller's phone number.

When you scroll past the last record, the total record number appears, then the first record. When you scroll past

NOTE

If the handset is face-up on the base, it shows the number of Caller ID records, so you can see if you have new records to review.

the first record, the total record number appears, then the last record.

To exit the Caller ID record display, press **CALL ID/HOLD**.

CALLER ID MESSAGES

Display	Description
<p>Line 1 Line 2</p> <p>NEW xx xx</p> <p>TTL xx xx</p>	Shows the number of new Caller ID records (records you have not reviewed) and the total number of records for each line.
Private name or Private number	The caller has blocked the Caller ID information from being sent.
Unknown name or Unknown number	The caller is not within a Caller ID service area.
Incomplete Data	Appears if there was an error during the transmission of Caller ID information. Minor electrical disturbances can affect Caller ID information. Occasional errors are normal. If the phone frequently displays Incomplete Data , contact your local telephone company or RadioShack store for assistance.

Caller ID Operation (Handset Only)

ADDING/DELETING THE AREA CODE

When the area code of the received call is the same as the one you stored (see "Storing Your Area Code" on Page 11), the Caller ID record does not show the area code. If it is different, the record shows the area code. However, you can add or delete the area code on the display. With the record displayed, press **3** to add or delete the area code. Pressing **3** again deletes or adds the area code.

When you dial the number or store it into memory, the phone dials or stores the number as it appears on the display.

DIALING NUMBERS FROM A CALLER ID RECORD

To dial a local number stored in a Caller ID record, recall the record, then press **LINE 1** or **LINE 2**. If it is a long distance call, press **1** (1 appears before the displayed number) before you press **LINE 1** or **LINE 2**. If you want to add or delete the area code, press **3** before you press **LINE 1** or **LINE 2**. ☑

☑ NOTE ☑

- You can use either line to make a call. For example, you can use line 2 to make a call to the number stored in the line 1 Caller ID memory.
- If a Caller ID record does not contain a phone number (if it was blocked by the caller, for example), you cannot dial from that record.

STORING A CALLER ID RECORD TO MEMORY

1. Recall the record you want to store, then press **MEM**. **Select Location** appears. If it is a long distance number, press **1**. If you want to add or delete the area code, press **3**.
2. Choose a memory location (01– 30) by pressing number keys or by repeatedly pressing **▲/INTCM** or **CONF/▼**, then press **SELECT/VOLUME**.

If the selected location is empty, the phone beeps to confirm that it stored the number, then the Caller ID record appears.

*If a record exists in the selected location, **Replace memory?** appears, prompting you to confirm the replacement. Move the cursor to **Yes** or **no**, then press **SELECT/VOLUME**.*

DELETING CALLER ID RECORDS

You can delete Caller ID records individually or all at once.

*To delete a single record, recall it, then press **DEL/FLASH**. **Delete message?** appears, prompting you to confirm the deletion. Move the cursor to **Yes** or **no**, then press **SELECT/VOLUME** or **DEL/FLASH**.*

*To delete all the records at once, display the number list menu, select the line, and press **DEL/FLASH**. **Del All, Line n?** appears, prompting you to confirm the deletion. Move the cursor to **Yes** or **no**, then press **SELECT/VOLUME** or **DEL/FLASH**.*

TROUBLESHOOTING

Problem	Suggestion
The phone does not work or works poorly.	<p>Be sure the base's phone line cord and AC adapter are correctly and securely connected.</p> <p>Be sure the handset's battery pack is connected and charged.</p> <p>Return the handset to the base for a few seconds to reset the security access-protection code.</p>
The display flashes slowly when the handset is face-up on the base.	Be sure the battery pack in the handset is properly connected.

Problem	Suggestion
The handset stops working or works poorly during a call.	<p>Move the handset closer to the base.</p> <p>Lift the base's antenna to a vertical position.</p> <p>Be sure the handset's battery pack is charged. (If the battery power is too low, it will not light the Low Battery indicator on the display.)</p>
Low volume or unusual sounds	Someone has picked up another phone on the same line. Hang up the other phone.
Severe noise interference	<p>Keep the handset and base away from computers, remote control toys, wireless microphones, alarm systems, intercoms, room monitors, fluorescent lights, and electrical appliances.</p> <p>Move to another location or turn off the source of interference.</p> <p>Hang up and redial the number.</p>
The phone cannot be operated at a useful distance from the base because the signal becomes weak or noisy (handset's range has decreased)	<p>Lift the base's antenna to a vertical position.</p> <p>Be sure neither antenna is touching a metal surface.</p> <p>Recharge the battery pack.</p>
The handset battery pack does not charge.	<p>Check the charging contacts on the handset and base. If they are dirty, clean them with a pencil eraser.</p> <p>Be sure the battery pack is connected correctly.</p> <p>Be sure the handset is properly seated on the base.</p> <p>Replace the battery pack (see "Connecting and Charging the Battery Pack" on Page 8).</p>

Limited One-Year Warranty

This product is warranted by RadioShack against manufacturing defects in material and workmanship under normal use for one (1) year from the date of purchase from RadioShack company-owned stores and authorized RadioShack franchisees and dealers. EXCEPT AS PROVIDED HEREIN, RadioShack MAKES NO EXPRESS WARRANTIES AND ANY IMPLIED WARRANTIES, INCLUDING THOSE OF MERCHANTABILITY AND FITNESS FOR A PARTICULAR PURPOSE, ARE LIMITED IN DURATION TO THE DURATION OF THE WRITTEN LIMITED WARRANTIES CONTAINED HEREIN. EXCEPT AS PROVIDED HEREIN, RadioShack SHALL HAVE NO LIABILITY OR RESPONSIBILITY TO CUSTOMER OR ANY OTHER PERSON OR ENTITY WITH RESPECT TO ANY LIABILITY, LOSS OR DAMAGE CAUSED DIRECTLY OR INDIRECTLY BY USE OR PERFORMANCE OF THE PRODUCT OR ARISING OUT OF ANY BREACH OF THIS WARRANTY, INCLUDING, BUT NOT LIMITED TO, ANY DAMAGES RESULTING FROM INCONVENIENCE, LOSS OF TIME, DATA, PROPERTY, REVENUE, OR PROFIT OR ANY INDIRECT, SPECIAL, INCIDENTAL, OR CONSEQUENTIAL DAMAGES, EVEN IF RadioShack HAS BEEN ADVISED OF THE POSSIBILITY OF SUCH DAMAGES.

Some states do not allow limitations on how long an implied warranty lasts or the exclusion or limitation of incidental or consequential damages, so the above limitations or exclusions may not apply to you.

In the event of a product defect during the warranty period, take the product and the RadioShack sales receipt as proof of purchase date to any RadioShack store. RadioShack will, at its option, unless otherwise provided by law: (a) correct the defect by product repair without charge for parts and labor; (b) replace the product with one of the same or similar design; or (c) refund the purchase price. All replaced parts and products, and products on which a refund is made, become the property of RadioShack. New or reconditioned parts and products may be used in the performance of warranty service. Repaired or replaced parts and products are warranted for the remainder of the original warranty period. You will be charged for repair or replacement of the product made after the expiration of the warranty period.

This warranty does not cover: (a) damage or failure caused by or attributable to acts of God, abuse, accident, misuse, improper or abnormal usage, failure to follow instructions, improper installation or maintenance, alteration, lightning or other incidence of excess voltage or current; (b) any repairs other than those provided by a RadioShack Authorized Service Facility; (c) consumables such as fuses or batteries; (d) cosmetic damage; (e) transportation, shipping or insurance costs; or (f) costs of product removal, installation, set-up service adjustment or reinstallation.

This warranty gives you specific legal rights, and you may also have other rights which vary from state to state.

RadioShack Customer Relations, 200 Taylor Street, 6th Floor, Fort Worth, TX 76102

12/99

Problem	Suggestion
Handset does not ring or receive a page.	Lift the base's antenna to a vertical position.
	Move the handset closer to the base.
	Move the handset and base away from other electrical devices.
You have an incoming call, but do not receive any Caller ID information.	Recharge the battery pack.
	If the base loses power while the handset is off of it, the security access-protection code might change. Restore power to the base, then place the handset back on the base and leave it there for a few seconds.
	Let the phone ring twice before you answer so the system has time to record the Caller ID information.
	Check that the system is correctly and securely connected.
	Call your phone company to verify that your Caller ID service is active.

If you still have problems, disconnect the phone. If other phones on the same line work properly, the fault is in this phone or its installation. If you cannot find the problem, take your phone to your local RadioShack store for assistance.

CARE

Keep the phone dry; if it gets wet, wipe it dry immediately. Use and store the phone only in normal temperature environments. Handle the phone carefully; do not drop it. Keep the phone away from dust and dirt, and wipe it with a damp cloth occasionally to keep it looking new.

SERVICE AND REPAIR

If your phone is not performing as it should, take it to your local RadioShack store for assistance. Modifying or tampering with the phone's internal components can cause a malfunction and might invalidate its warranty and void your FCC authorization to operate it.

FCC STATEMENT

This phone is Hearing Aid compatible.

Your phone complies with Part 68 of *FCC Rules*. You must, upon request, provide the FCC registration number and the REN to your telephone company. Both numbers are on the bottom of the telephone. ☐

We have designed your phone to conform to federal regulations, and you can connect it to most telephone lines. However, each phone (and each device, such as a telephone or answering machine) that you connect to the telephone line draws power from the telephone line. We refer to this power draw as the device's ringer equivalence number, or REN on the bottom of your phone.

If you use more than one phone or other device on the line, add up all of the RENs. If the total is more than five (three in rural areas), your telephones might not ring. If ringer operation is impaired, remove a device from the line.

In the unlikely event that your phone causes problems on the phone line, the phone company can temporarily discontinue your service. If this happens, the phone company attempts to notify you in advance. If advance notice is not practical, the phone company notifies you as soon as possible and advises you of your right to file a complaint with the FCC.

Also, the phone company can make changes to its lines, equipment, operations, or procedures that could affect the operation of this telephone. The telephone company notifies you of these changes in advance, so you can take the necessary steps to prevent interruption of your telephone service.

This equipment has been tested and found to comply with the limits for a Class B digital device, pursuant to Part 15 of the *FCC Rules*. These limits are designed to provide reasonable protection against harmful interference in a residential installation. This equipment generates, uses and can radiate radio frequency energy and, if not installed and used in accordance with the instructions, may cause harmful interference to radio communications.

However, there is no guarantee that interference will not occur in a particular installation. If this equipment does cause harmful interference to radio or television reception, which can be determined by turning the equipment off and

☐ NOTE ☐

You must not connect your phone to:

- coin-operated systems
- party-line systems
- most electronic key telephone systems

! IMPORTANT !

- Cordless phones such as this one require AC power to operate. When the AC power is off, you cannot dial out or receive incoming calls using your phone. For this reason, the phone should not be your only telephone. To be safe, you should also have a phone that does not require AC power to operate (not a cordless phone) so you can still make and receive calls if there is an AC power failure.
- Some cordless phones operate at frequencies that might cause interference to nearby TVs and VCRs. To minimize or prevent such interference, the base of the cordless phone should not be placed near or on top of a TV or VCR.
- Your cordless phone operates on standard radio frequencies, as allocated by the FCC. Even though your phone's access protection code prevents unauthorized use of your phone line, it is possible for other radio units operating on similar frequencies within a certain area to unintentionally intercept your conversations and/or cause interference. This possible lack of privacy can occur with any cordless phone.

on, the user is encouraged to try to correct the interference by one or more of the following measures:

- Reorient or relocate the receiving antenna.
- Increase the separation between the equipment and receiver.
- Connect the equipment into an outlet on a circuit different from that to which the receiver is connected.
- Consult your local RadioShack store or an experienced radio/TV technician for help.
- If you cannot eliminate the interference, the FCC requires that you stop using your phone.

Changes or modifications not expressly approved by RadioShack may cause interference and void the user's authority to operate the equipment.

This device complies with Part 15 of the *FCC Rules*.

Operation is subject to the following two conditions: (1) this device may not cause harmful interference, and (2) this device must accept any interference received, including interference that may cause undesired operation.

Your phone is ETL listed to UL standards and meets all applicable FCC requirements.

LIGHTNING

Your telephone has built-in protection circuits to reduce the risk of damage from surges in telephone line and power line current. These protection circuits meet or exceed the FCC requirements. However, lightning striking the telephone or power lines can damage your telephone.!

Lightning damage is not common. Nevertheless, if you live in an area that has severe electrical storms, we suggest that you unplug your phone when storms approach to reduce the possibility of damage.

RadioShack Corporation
Fort Worth, Texas 76102

43-683 **B**
UCZZ01377ZZ
03A02
Printed in China

Free Manuals Download Website

<http://myh66.com>

<http://usermanuals.us>

<http://www.somanuals.com>

<http://www.4manuals.cc>

<http://www.manual-lib.com>

<http://www.404manual.com>

<http://www.luxmanual.com>

<http://aubethermostatmanual.com>

Golf course search by state

<http://golfingnear.com>

Email search by domain

<http://emailbydomain.com>

Auto manuals search

<http://auto.somanuals.com>

TV manuals search

<http://tv.somanuals.com>