

Cat. No. 43-1101
OWNER'S MANUAL

Please read before using this equipment.

ET-1101

900MHz 40-Channel Headset Cordless Phone

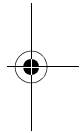
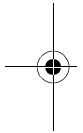

RadioShack®



FEATURES

Your RadioShack ET-1101 900MHz 40-Channel Headset Cordless Phone combines the clarity of 900MHz communication with portability and convenience.

The ET-1101's headset connects to a cordless keypad, so you can make calls away from the base. And the headset lets you keep your hands free while you talk.

Your phone includes these features:

900 MHz — provides less interference and clearer sound than 46–49 MHz cordless phones.

40-Channel Auto Scan — automatically selects a clear channel when you make or answer a call.

Ample Talk and Standby Time — the supplied battery (when fully charged) provides about 8 hours of talk time or 7 days of standby time.

10-Number Memory — stores up to 10 frequently called phone numbers for easy dialing.

Dual Charging Slots — lets you charge a spare battery pack (not supplied) so the ET-1101 is always ready to go, even under constant use.

Intercom — lets you page the keypad from the base, or the base from the keypad, and hold a conversation with the person at the other end.

Headset Volume Control — lets you adjust the volume you hear through the headset.

Ringer Volume Control — lets you choose high, medium, or low volume on the keypad's ringer.

Advanced Super CCT Circuitry — provides sound clarity comparable to that of a corded phone.

Security Access-Protection Code — prevents other cordless phone users from using your phone line while the keypad is off the base.

COM-LOK[®] — ensures that other cordless phone users cannot use your phone line when the keypad is on the base.

Redial — lets you redial the last number dialed, with the touch of a button.

Mute — prevents the person on the other end of the phone line from hearing you as you talk to someone else in the room.

© 1998, 1999 Tandy Corporation.
All Rights Reserved.

COM-LOK and RadioShack are registered trademarks used by Tandy Corporation.

Flash — sends an electronic switchhook signal for use with special phone services such as Call Waiting.

Tone or Pulse (Rotary) Dialing — lets you use your phone with tone or pulse dialing and lets you easily switch from pulse to tone dialing for long-distance, bank-by-phone, or other special services.

Belt Clip — lets you carry the keypad on your belt for easy portability.

Hearing-Aid Compatibility — lets you use your phone with hearing aids that have a T (telephone) switch.

Your ET-1101 is ETL listed to UL standards and meets all applicable FCC standards.

Important Note: Cordless phones such as this one require AC power to operate. When the AC power is off, you cannot dial out or receive incoming calls using your ET-1101. To be safe, you should also have a phone that does not need AC power to operate (not a cordless phone) so you can still make and receive calls if there is an AC power failure.



Note: Your phone operates on standard radio frequencies as allocated by the FCC. It is possible for other radio units operating nearby on similar frequencies to unintentionally intercept your conversa-

tion or cause interference. This possible lack of privacy can occur with any cordless phone.

We recommend you record your phone's serial number here. The number is on the bottom of the base.

Serial Number: _____

Warning: To prevent fire or shock hazard, do not expose this product to rain or moisture.

	CAUTION RISK OF ELECTRIC SHOCK. DO NOT OPEN.	
CAUTION: TO REDUCE THE RISK OF ELECTRIC SHOCK, DO NOT REMOVE COVER OR BACK. NO USER-SERVICEABLE PARTS INSIDE. REFER SERVICING TO QUALIFIED PERSONNEL.		



This symbol is intended to alert you to the presence of uninsulated dangerous voltage within the product's enclosure that might be of sufficient magnitude to constitute a risk of electric shock. Do not open the product's case.



This symbol is intended to inform you that important operating and maintenance instructions are included in the literature accompanying this product.

READ THIS BEFORE INSTALLATION

We have designed your phone to conform to federal regulations, and you can connect it to most telephone lines. However, each device that you connect to the phone line draws power from the phone line. We refer to this power draw as the device's *ringer equivalence number*, or REN. The REN is on the bottom of the base.

If you are using more than one phone or other device on the line, add up all the RENs. If the total is more than five (three in rural areas), your phones might not ring. If ringer operation is impaired, remove a device from the line.

FCC STATEMENT

This telephone complies with Part 68 of *FCC Rules*. You must, upon request, provide the FCC registration number and the REN to your phone company. These numbers are shown on the bottom of the base.

Note: You must not connect your phone to any of the following:

- coin-operated systems
- party-line systems
- most electronic key phone systems

Warning: Changes or modifications to this unit not expressly approved by RadioShack could void the user's authority to operate the equipment.

CONTENTS

Preparation	6
Selecting a Location	6
Connecting the Phone	6
Connecting and Charging the Battery Pack	7
Attaching the Headset Holder	8
Adjusting the Headset	9
Setting the Ringers On or Off	9
Setting the Keypad's Ringer Volume	10
Setting the Dialing Mode	10
Operation	11
Making and Receiving Calls	11
Adjusting the Headset's Volume	11
Changing Channels	11
Using Redial	12
Using Mute	12
Using Flash	12
Using Tone Services on a Pulse Line	12
Using Page/Intercom	13
Paging the Headset/Keypad	13
Paging the Base	13
Memory Dialing	14
Storing a Number in Memory	14
Entering a Pause in a Memory Number	15
Dialing a Stored Number	15
Chain Dialing Service Numbers	15
Testing Stored Emergency Numbers	15
Troubleshooting	16
Care and Maintenance	17
Replacing the Battery Pack	17
The FCC Wants You to Know	18
Lightning	19

PREPARATION

SELECTING A LOCATION

You can place the phone's base on a flat surface such as desk, shelf, or table. Select a location that is:

- near an easily accessible AC outlet
- near a telephone line jack
- out of the way of normal activities
- away from electrical machinery, electrical appliances, metal walls, filing cabinets, wireless intercoms, security alarms, and room monitors

The base's location affects the phone's range. If you have a choice of several locations, try each to see which provides the best performance.

Notes:

- Your telephone connects directly to a modular telephone line jack. If your phone line jack is not a modular jack, you can update the wiring yourself, using jacks and adapters available at your local RadioShack store. Or, you can let the phone company update the wiring for you.
- The USOC number of the jack to be installed is RJ11C.

CONNECTING THE PHONE

After you select a location for the phone's base, follow these steps to connect it to AC power and to the phone line.



Caution: You must use a Class 2 power source that supplies 12 volts DC and delivers at least 500 mA. Its center tip must be set to positive and its plug must fit the ET-1101's **DC 12V 500mA** jack. The supplied adapter meets these specifications. Using an adapter that does not meet these specifications could damage the ET-1101 or the adapter.

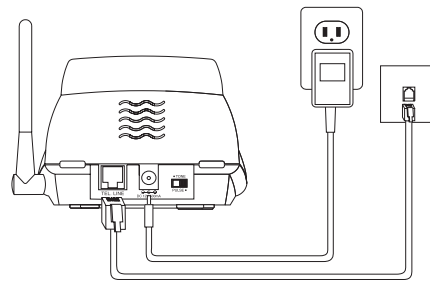

1. Plug one end of the supplied modular cord into the **TEL. LINE** jack on the back of the base.
2. Plug the modular cord's other end into a modular phone line jack.

3. Plug the supplied AC adapter's barrel plug into the **DC 12V 500mA** jack on the back of the base.
4. Plug the adapter into a standard AC outlet.
5. Lift the base's antenna to a vertical position.

To charge the battery pack, place the keypad in the front charging slot on the base. The CHARGE/IN USE indicator on the base lights.

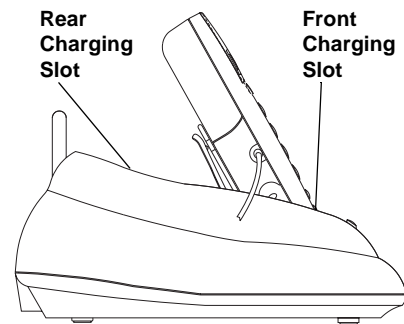

CONNECTING AND CHARGING THE BATTERY PACK

The ET-1101 comes with a rechargeable nickel-cadmium battery pack. You must connect the battery pack and charge it for at least 15 hours before you use the phone.

To connect the battery pack, line up the slots on the battery pack with the posts on the back of the keypad. Press down and slide the battery pack forward until the latch clicks.

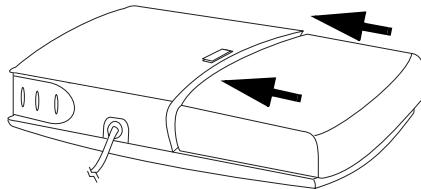

To charge a spare battery pack, place it in the rear charging slot with its latch end facing down and its contacts toward the rear of the base. The CHARGE indicator lights.

Spare battery packs (RadioShack Cat. No. 23-810, not supplied) are available at your local RadioShack store.

Recharge the battery pack when the LOW BATT indicator on the keypad flashes.

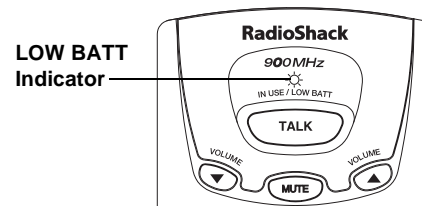

Notes:

- When you first use the phone after charging or recharging the battery pack, the phone might not work and you might hear error tones (three beeps).

If you hear the error tones, return the keypad to the base for about 5 seconds to reset the security access-protection code.

- About once a month, fully discharge the battery pack by keeping the phone off the base until the LOW BATT indicator flashes. Otherwise, the battery pack loses its ability to fully recharge.
- If the CHARGE/IN USE indicator does not light when you place the keypad on the base, be sure the battery pack and AC adapter are correctly and securely connected. Also, check the charging contacts on the keypad and base. If the contacts are dirty or tarnished, clean them with a pencil eraser.

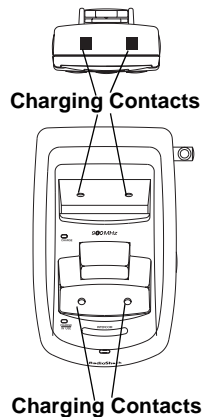

- If the battery pack becomes completely discharged or the base loses power while the handset is away from it, the security access-protection code needs to be reset. To reset the security code, place the handset on the base for about 5 seconds. If it was the handset that lost power, leave it on the base to charge the battery pack.
- If you are not going to use your phone for an extended period of time, disconnect its battery pack. This helps increase the battery pack's usable life.

ATTACHING THE HEADSET HOLDER

Insert the tabs on the headset holder into the slots on the base and snap it into place.

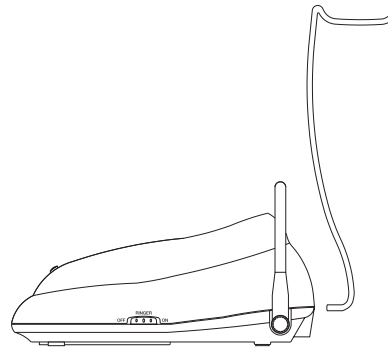



ADJUSTING THE HEADSET

1. Place the headset on your head with the earpiece over either ear.
2. Adjust the headset band until it rests with almost no pressure on your ear and the top of your head.

If the headset is loose, adjust it inward slightly to tighten it. If the headset is tight, gently pull the headset band out to loosen it.

3. Hold the headset in place, and adjust the microphone boom until it is about even with your chin. Experiment until you find the most comfortable position.

Caution: The microphone boom swivels on the headset. Do not bend the microphone boom while you adjust it.

Note: When you are not using the headset, place it on the headset hanger. Otherwise (if you just lay it down on a flat surface, for example), you might have to repeat these adjustments.

SETTING THE RINGERS ON OR OFF

The ringer switch on the right side of the base controls both the keypad and base ringers. To have the ET-1101 ring when a call comes in, set **RINGER** to **ON**. To turn the ringer off, set **RINGER** to **OFF**.



With **RINGER** set to **OFF**, the phone does not ring, but you can still make outgoing calls. If you hear an extension telephone ring, you can answer the incoming call on this phone. The **CHARGE/IN USE** indicator on the base and the **IN USE** indicator on the keypad flash until you answer the call.

SETTING THE KEYPAD'S RINGER VOLUME

You can adjust the keypad's ringer volume by repeatedly pressing **RINGER ADJUST** when the phone is not in use. The keypad rings with the current volume (high, medium, or low) as you select it.

Note: You cannot adjust the base's ringer volume.

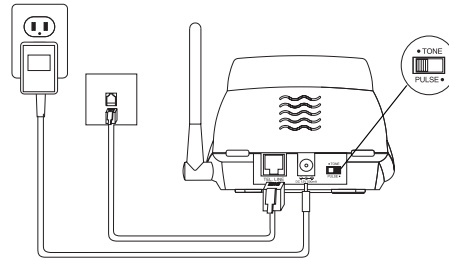
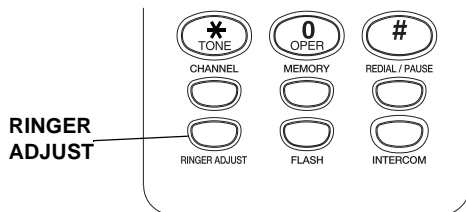

2. Press **TALK** so the **IN USE** indicator lights and listen for a dial tone.

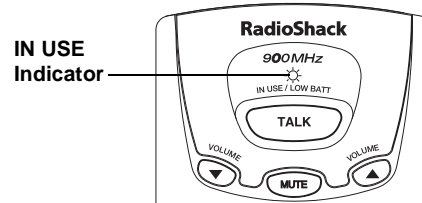

3. Press any number other than **0**.

Note: If your phone system requires that you dial an access code (9, for example) before you dial an outside number, do not press the access code either.

If the dial tone stops, you have touch-tone service. If the dial tone continues, you have pulse service.

4. If you have tone service, leave **TONE-PULSE** set to **TONE**. If you have pulse service, set **TONE-PULSE** to **PULSE**.
5. To hang up, place the keypad on the base or press **TALK**.

SETTING THE DIALING MODE

Set **TONE-PULSE** on the side of the base for the type of service you have. If you are not sure which type you have, do this simple test after charging the battery pack.

1. Set **TONE-PULSE** to **TONE**.

OPERATION

MAKING AND RECEIVING CALLS

Before you use the phone, put the headset on and adjust it as needed.

To make a call, lift the keypad off the base, then press **TALK**. You hear the dial tone and the IN USE indicator lights. Dial the number you want to call.

To answer a call, lift the keypad off the base, then press **TALK**. The IN USE indicator lights.

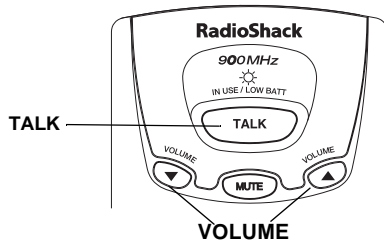

To end a call, press **TALK** or place the keypad on the base.

Notes:

- When you press a button, a single tone indicates that the phone has accepted the command. Three tones indicate that you pressed a button in error, you are out of range, or there is too much interference. If there is severe interference, see "Changing Channels."

- If interference is severe, the keypad might lose communication with the base and the call might disconnect. If this happens, return the keypad to the base for about five seconds to reset the security access-protection code.

ADJUSTING THE HEADSET'S VOLUME

To adjust the headset's volume, repeatedly press **VOLUME ▲** or **VOLUME ▼** during a call until the sound level is comfortable. You can set the headset's volume to one of eight levels, and it will remain set even after you hang up.

CHANGING CHANNELS

Every time you press **TALK**, the ET-1101 automatically selects a clear channel from the 40 it uses for communication between the headset and the base. If you hear interference during a call, repeatedly press **CHANNEL** to change the channel until you get a clear one.

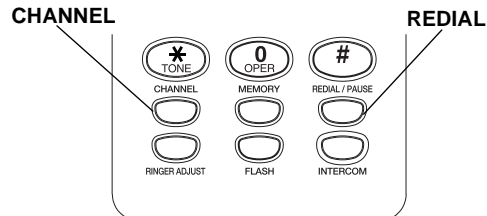

USING REDIAL

To quickly redial the last number dialed, press **TALK** then **REDIAL**.

Notes:

- The redial memory holds up to 32 digits, so you can redial long-distance as well as local numbers.
- The redial memory can also store tone entries (see "Using Tone Services On a Pulse Line") and pause entries (see "Entering a Pause in a Memory Number" on Page 15).

USING MUTE

To talk to someone else in the room without the person on the other end of the phone line hearing your conversation, press **MUTE**.

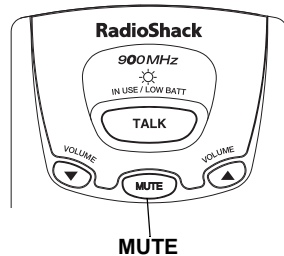

Press **MUTE** again to resume your phone conversation.

USING FLASH

FLASH provides the electronic equivalent of a switchhook signal for special phone services such as Call Waiting.

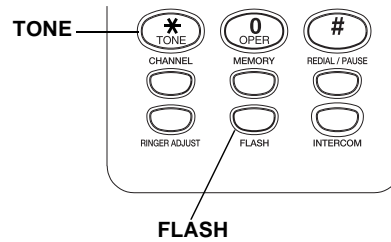

For example, if you have Call Waiting, press **FLASH** to answer an incoming call without disconnecting the current call. Press **FLASH** again to return to the first call.

Note: If you do not have any special phone services, pressing **FLASH** might disconnect your current call.

USING TONE SERVICES ON A PULSE LINE

Some special services, such as bank-by-phone, require tone signals. If you have pulse service, you can still use these tone services by following these steps.

1. Dial the service's main number.

2. When the service answers, press **TONE**. Any additional numbers you dial are sent as tone signals.
3. After you complete the call, press **TALK** or return the keypad to the base. The phone automatically resets to pulse dialing.

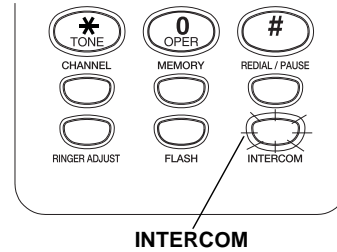

USING PAGE/INTERCOM

You can send a page and use the ET-1101 as an intercom between the base and the headset/keypad. This is useful if the headset/keypad is away from the base and you want to locate it, or if you want to have a conversation between someone using the headset/keypad and someone at the base.

Paging the Headset/Keypad

To page the person who has the headset/keypad or to locate the headset/keypad when the phone is not in use, press **INTERCOM** on the base. The keypad rings three times and its INTERCOM indicator flashes. To have the keypad ring for a longer time, hold down **INTERCOM** for 3 seconds. The keypad rings about 9 times.

To answer the page, press **INTERCOM** on the keypad before the INTERCOM indicator stops flashing (about 6 seconds). When you finish your intercom conversation, press **INTERCOM** again to hang up.

Paging the Base

To page the base, press **INTERCOM** on the keypad. The base rings nine times and its INTERCOM indicator flashes.

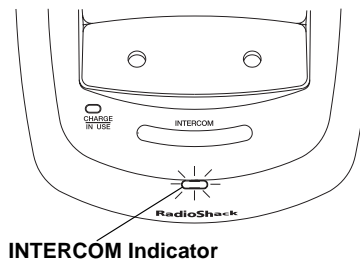

To answer the page, press **INTERCOM** on the base before the INTERCOM indicator stops flashing (about 18 seconds). To end the intercom conversation, press **INTERCOM** again.

MEMORY DIALING

You can store up to 10 numbers of up to 16 digits each in the ET-1101's memory.

Notes:

- To keep your accounts secure, we recommend you do not store your personal access code for services such as bank-by-phone in a memory location.
- When storing numbers for special services (such as alternate long distance or bank-by-phone), store the service's main phone number in one memory location and numbers for additional information in other locations.

Storing a Number in Memory

Note: If you do not press any button on the keypad within about 10 seconds, 3 beeps sound and the phone exits the memory storing process. Start again from Step 1.

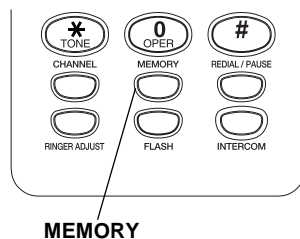

1. While the phone is not in use, press **MEMORY**.
2. Dial the number you want to store.
3. Press **MEMORY** again.
4. Press the memory location number (**0–9**) you want to use. The keypad sounds one long tone to confirm that the phone number has been stored.

Note: If you do not hear a long tone, you did not successfully store the number. Start again at Step 1.
5. Pull out the memory index card at the bottom of the base and write the associated name or stored number next to the location number. We recommend you use a pencil so you can change it later.



Notes:

- If you receive a call while you are storing a number in memory, press **TALK** to answer the call. After the call, begin again at Step 1.
- To change a number stored in memory, simply store a new number in that memory location.

Entering a Pause in a Memory Number

In some telephone systems, you must dial an access code (9, for example) and wait for the second dial tone before you can dial an outside number. You can store the access code with the phone number. However, you should also store a pause after the access code to allow the outside line time to connect. To do so, press **PAUSE** to enter a 3-second pause after entering the access code. For a longer pause, press **PAUSE** again.

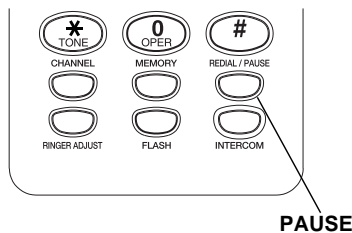
**Dialing a Stored Number**

Press **TALK**. When you hear the dial tone, press **MEMORY** then the memory location number. The phone dials the number.

Chain Dialing Service Numbers

For quick recall of numbers for special services (such as alternate long distance or bank by phone), store each group of numbers in its own memory location.

When calling special services, dial the service's main number first. Then, at the appropriate place in the call, press **MEMORY**, then the number for the location where the additional numbers are stored.

Note: If you use pulse dialing, be sure you have stored a tone entry in another memory location (see "Using Tone Services on a Pulse Line" on Page 12).

Testing Stored Emergency Numbers

If you store an emergency service's number (police department, fire department, ambulance) and you want to test the stored number, make the test call during the late evening or early morning to avoid peak demand periods. Remain on the line to explain the reason for your call.

TROUBLESHOOTING

We do not expect you to have any problems with your phone, but if you do, the following suggestions might help.

Problem	Suggestion
The keypad does not work.	Move the keypad closer to the base.
	Raise the base's antenna to a vertical position.
	Ensure the phone's modular cord and the AC adapter are correctly and securely connected.
	Recharge the keypad's battery pack. (If battery power is too low, the LOW BATT indicator does not light.)
Call is noisy.	Reset the security access-protection code by placing the keypad on the base for about five seconds.
	Keep the headset and base away from interference sources such as computers, remote control toys, wireless alarm systems, wireless intercoms and room monitors, fluorescent lights, and electrical appliances. If the interference is severe, turn off the interfering device.
	Move the keypad closer to the base.
	Hang up and redial the number.
The range decreases.	Press CHANNEL to change the channel.
	Ensure the base's antenna is raised and is not touching a metal surface.
Can receive calls, but cannot make calls.	Recharge the keypad's battery pack.
	Set TONE-PULSE correctly for the type of service you have (see "Setting the Dialing Mode" on Page 10).

If you still have problems, disconnect the phone. If other phones on the same line work properly, the fault is in this phone or its installation. If you cannot locate the problem, take your ET-1101 to your local RadioShack store for assistance.

CARE AND MAINTENANCE

To enjoy your RadioShack ET-1101 900 MHz 40-Channel Headset Cordless Phone for a long time:

- Keep the phone dry. If it gets wet, wipe it dry immediately.
- Use and store the phone only in normal temperature environments.
- Handle the phone gently and carefully. Don't drop it.
- Keep the phone away from dust and dirt.
- Wipe the phone with a damp cloth occasionally to keep it looking new.

Modifying or tampering with the phone's internal components can cause a malfunction and invalidate its warranty. If your phone is not performing as it should, take it to your local RadioShack store for assistance. If the trouble is affecting the telephone lines, the phone company can ask you to disconnect your phone until you have resolved the problem.

REPLACING THE BATTERY PACK

If you follow the instructions in "Connecting and Charging the Battery Pack" on Page 7, the battery pack should last about a year. If the battery pack does not hold a charge for more than 2 hours after an overnight charge, replace it. You can order a replacement battery pack (Cat. No. 23-810) through your local RadioShack store.

Note: To avoid losing numbers stored in memory, try to install and begin charging the new battery pack within 2 minutes of removing the old one.

1. To remove the old battery pack, press the latch release, then slide the battery pack back and lift it from the keypad.

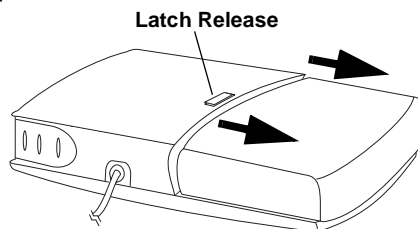

2. To connect the new battery pack, line up the slots on the battery pack with the posts on the keypad. Press down and slide it forward until the latch clicks.

3. Charge the battery pack for 15 hours before using it.

Cautions:

- Be careful not to short the battery pack by touching it with conducting materials, such as rings, bracelets, and keys. The battery pack or conductor might overheat and burn.
- Do not dispose of the battery pack in a fire because it might explode.
- Do not open or mutilate the battery pack.

Note: If you have trouble replacing the battery pack, take the phone to your local RadioShack store for assistance.

Important: Your telephone contains a rechargeable nickel cadmium battery pack. At the end of the battery pack's useful life, it must be recycled or disposed of properly. Contact your local, county, or state hazardous waste management authorities for information on recycling or disposal programs in your area. Some options that might be available are: municipal curb-side collection, drop-off boxes at retailers such as your local RadioShack store, recycling collection centers, and mail-back programs.

THE FCC WANTS YOU TO KNOW

In the unlikely event that your phone causes problems on the phone line, the phone company can temporarily discontinue your service. If this happens, the phone company attempts to notify you in advance. If advance notice is not practical, the phone company notifies you as soon as possible and advises you of your right to file a complaint with the FCC.

Also, the phone company can make changes to its lines, equipment, operations, or procedures that could affect the operation of this telephone. The telephone company notifies you of these changes in advance, so you can take the necessary steps to prevent interruption of your telephone service.

This equipment complies with the limits for a Class B digital device as specified in Part 15 of *FCC Rules*. These limits provide reasonable protection against radio and TV interference in a residential area. However, your equipment might cause TV or radio interference even when it is operating properly. To eliminate interference, you can try one or more of the following corrective measures:

- Reorient or relocate the receiving antenna.

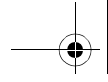

-
- Increase the distance between the equipment and the radio or TV.
 - Use outlets on different electrical circuits for the equipment and the radio or TV.

Consult your local RadioShack store if the problem still exists.

LIGHTNING

Your telephone has built-in lightning protection to reduce the risk of damage from surges in telephone line and power line current. This lightning protection meets or exceeds FCC requirements. However, lightning striking the telephone or power lines can damage your telephone.

Lightning damage is not common. Nevertheless, if you live in an area that has severe electrical storms, we suggest that you unplug your phone before storms to reduce the possibility of damage.

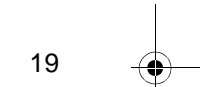
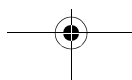
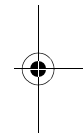
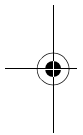

Limited One-Year Warranty

This product is warranted by RadioShack against manufacturing defects in material and workmanship under normal use for one (1) year from the date of purchase from RadioShack company-owned stores and authorized RadioShack franchisees and dealers. EXCEPT AS PROVIDED HEREIN, RadioShack MAKES NO EXPRESS WARRANTIES AND ANY IMPLIED WARRANTIES, INCLUDING THOSE OF MERCHANTABILITY AND FITNESS FOR A PARTICULAR PURPOSE, ARE LIMITED IN DURATION TO THE DURATION OF THE WRITTEN LIMITED WARRANTIES CONTAINED HEREIN. EXCEPT AS PROVIDED HEREIN, RadioShack SHALL HAVE NO LIABILITY OR RESPONSIBILITY TO CUSTOMER OR ANY OTHER PERSON OR ENTITY WITH RESPECT TO ANY LIABILITY, LOSS OR DAMAGE CAUSED DIRECTLY OR INDIRECTLY BY USE OR PERFORMANCE OF THE PRODUCT OR ARISING OUT OF ANY BREACH OF THIS WARRANTY, INCLUDING, BUT NOT LIMITED TO, ANY DAMAGES RESULTING FROM INCONVENIENCE, LOSS OF TIME, DATA, PROPERTY, REVENUE, OR PROFIT OR ANY INDIRECT, SPECIAL, INCIDENTAL, OR CONSEQUENTIAL DAMAGES, EVEN IF RadioShack HAS BEEN ADVISED OF THE POSSIBILITY OF SUCH DAMAGES.

Some states do not allow the limitations on how long an implied warranty lasts or the exclusion of incidental or consequential damages, so the above limitations or exclusions may not apply to you.

In the event of a product defect during the warranty period, take the product and the RadioShack sales receipt as proof of purchase date to any RadioShack store. RadioShack will, at its option, unless otherwise provided by law: (a) correct the defect by product repair without charge for parts and labor; (b) replace the product with one of the same or similar design; or (c) refund the purchase price. All replaced parts and products, and products on which a refund is made, become the property of RadioShack. New or reconditioned parts and products may be used in the performance of warranty service. Repaired or replaced parts and products are warranted for the remainder of the original warranty period. You will be charged for repair or replacement of the product made after the expiration of the warranty period.

This warranty does not cover: (a) damage or failure caused by or attributable to acts of God, abuse, accident, misuse, improper or abnormal usage, failure to follow instructions, improper installation or maintenance, alteration, lightning or other incidence of excess voltage or current; (b) any repairs other than those provided by a RadioShack Authorized Service Facility; (c) consumables such as fuses or batteries; (d) cosmetic damage; (e) transportation, shipping or insurance costs; or (f) costs of product removal, installation, set-up service adjustment or reinstallation.

This warranty gives you specific legal rights, and you may also have other rights which vary from state to state.

RadioShack Customer Relations, 200 Taylor Street, 6th Floor, Fort Worth, TX 76102

We Service What We Sell

04/99

RadioShack
A Division of Tandy Corporation
Fort Worth, Texas 76102

07A99

Printed in China

Free Manuals Download Website

<http://myh66.com>

<http://usermanuals.us>

<http://www.somanuals.com>

<http://www.4manuals.cc>

<http://www.manual-lib.com>

<http://www.404manual.com>

<http://www.luxmanual.com>

<http://aubethermostatmanual.com>

Golf course search by state

<http://golfingnear.com>

Email search by domain

<http://emailbydomain.com>

Auto manuals search

<http://auto.somanuals.com>

TV manuals search

<http://tv.somanuals.com>