

Cat. No. 43-1105
OWNER'S MANUAL

Please read before using this equipment.

ET-1105

**Digital Spread Spectrum
900 MHz Cordless Telephone
with Caller ID/Call Waiting ID**

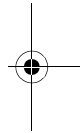

RadioShack®

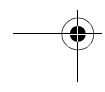
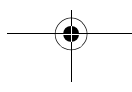

FEATURES

Your RadioShack ET-1105 Digital Spread Spectrum 900 MHz Cordless Telephone uses advanced digital cordless technology to give you superior sound quality and extended range. The telephone digitizes and scrambles your conversation before transmitting it between the handset and the base, so your conversation is secure from interception by other cordless telephone or scanner users. Its cordless operation lets you handle calls just about anywhere in your home or office.

The phone can display a caller's phone number, name (if available), and the date and time the call was received. It can store up to 45 records as provided by your local phone company to Caller ID service subscribers.

If you have Call Waiting with Caller ID, the phone displays incoming caller information for a new call when you are already on the phone.

The ET-1105 has these features:

900 MHz Operation — provides better sound and less interference than many other cordless phones.

Digital Spread Spectrum — provides the longest range and the utmost in security. Frequencies are constantly changing across the entire 900 MHz band, making your calls impossible to monitor on scanners.

Headset Jack — lets you connect an optional headset (such as RadioShack Cat. No. 43-195) for hands-free convenience while you use the phone.

20-Number Memory Dialing — lets you store 20 numbers in memory for easy dialing.

Volume Control — lets you adjust the volume you hear through the handset.

Page — lets you send a paging signal from the base to the handset to page someone or locate the handset when it is away from the base.

4-Hour Talk or 7-Day Standby Time — lets you talk for 4 hours or keep the phone off the base for 7 days without recharging (with a fully charged battery pack).

Caller ID Memory Dialing — lets you select a phone number stored in Caller ID memory, then dial it with the touch of a button.

20 Channels — automatically selects a clear channel when you make or answer a call.

VIP Memory — alerts you with a distinctive ring when someone you have added to the VIP list calls.

© 1999 Tandy Corporation.
All Rights Reserved.

RadioShack is a registered trademark used by Tandy Corporation.

Review Scrolling — lets you easily scroll through all information stored in the ET-1105's Caller ID memory.

Phone Information Display — lets you see incoming Caller ID information and phone numbers as you dial them or recall them from the ET-1105's memory and Caller ID records.

Trilingual Messages — lets you set the phone to display messages in English, French, or Spanish.

Out of Range Signal — the handset beeps twice to let you know when you move out of the base's operating range.

Security Access-Protection Code — helps prevent other cordless phone users from using your phone line while the handset is off the base.



Flash — sends an electronic switchhook signal for use with special phone services such as Call Waiting.

Redial — lets you quickly redial the last number dialed.

Tone/Pulse Dialing — lets you use your phone with tone or pulse service.

This telephone has been tested and found to comply with all applicable UL and FCC standards.

WARNING: To reduce the risk of fire or shock hazard, do not expose this product to rain or moisture.

	CAUTION RISK OF ELECTRIC SHOCK. DO NOT OPEN.	
CAUTION: TO REDUCE THE RISK OF ELECTRIC SHOCK, DO NOT REMOVE COVER OR BACK. NO USER-SERVICEABLE PARTS INSIDE. REFER SERVICING TO QUALIFIED PERSONNEL.		



This symbol is intended to alert you to the presence of uninsulated dangerous voltage within the product's enclosure that might be of sufficient magnitude to constitute a risk of electric shock. Do not open the product's case.



This symbol is intended to inform you that important operating and maintenance instructions are included in the literature accompanying this product.

Important Caller ID Information

To use the phone's Caller ID and Call Waiting features, you must be in an area where Caller ID and Call Waiting services are available and you must subscribe to the services.

Where Caller ID is offered, one or more of the following options are generally available:

- Caller's number only
- Caller's name only
- Caller's name and number

For the ET-1105's Caller ID memory dial feature to operate, you must receive the caller's number.

Important: Cordless phones such as this one require AC power to operate. When the AC power is off, you cannot dial out or receive incoming calls using your ET-1105. For this reason, the ET-1105 cordless phone should not be your only telephone. To be safe, you should also have a corded phone that does not require AC power to operate so you can still make and receive calls if there is an AC power failure.

Your telephone operates on standard radio frequencies as allocated by the FCC. Even though the access protection code prevents unauthorized use of your phone line, it is possible for other radio units operating on similar frequencies within a certain area to unintentionally intercept your conversations and/or cause inter-

ference. This lack of privacy can occur with any cordless phone.

READ THIS BEFORE INSTALLATION

Each device that you connect to the phone line draws power from the phone line. We refer to this power draw as the device's *ringer equivalence number*, or REN. The REN is on the bottom of the base.

If you are using more than one phone or other device on the line, add up all the RENs. If the total is more than five (three in rural areas), your phone might not ring. If ringer operation is impaired, remove a device from the line.

FCC STATEMENT

This telephone complies with Part 68 of *FCC Rules*. You must, upon request, provide the FCC registration number and the REN to your phone company. These numbers are on the bottom of the base.

Note: You must not connect your ET-1105 to any of the following:

- coin-operated systems
- party-line systems
- most electronic key phone systems

CONTENTS

Preparation	6
Selecting a Location	6
Attaching the Handset's Antenna	6
Placing the Base on a Desk Top	6
Mounting the Base on a Wall Plate	8
Connecting and Charging the Battery Pack	9
Setting the Dialing Mode	11
Selecting the Language	11
Setting the Area Code	12
Setting the Ringer	12
Turning the Ringer On or Off	12
Checking/Setting the Ringer	12
Using a Headset	13
Removing the Belt Clip	13
Telephone Operation	14
Making and Receiving a Call	14
Setting the Handset's Volume	14
Using Redial	14
Using Flash	15
Using Tone Services on a Pulse Line	15
Using Page	15
Memory Dialing	15
Storing a Number and Name in Memory	16
Using the VIP Call List	16
Entering a Pause	17
Recalling Numbers Stored in Memory	17
Dialing a Memory Number	17
Chain-Dialing Service Numbers	17
Testing Stored Emergency Numbers	18
Deleting Information in a Single Memory Location	18
Deleting Information in All Memory Locations	18
Caller ID Operation	19
Caller ID Displays	20
Reviewing Caller ID Records	21
Storing Caller ID Records in a Memory Location	21
Dialing Numbers from a Caller ID Record	21
Deleting Caller ID Records	21
Troubleshooting	22
Care and Maintenance	25

PREPARATION

SELECTING A LOCATION

You can place the phone on a desk top or table, or mount it on a standard wall plate. Select a location that is:

- near an accessible AC outlet
- near a telephone line jack
- out of the way of normal activities
- away from electrical machinery, electrical appliances, metal walls or filing cabinets, wireless intercoms, alarms, and room monitors

The base's location affects the phone's range. If you have a choice of several locations, try each to see which provides the best performance.

Caution: The supplied AC adapter was designed specifically for your ET-1105. Use only the supplied adapter.

ATTACHING THE HANDSET'S ANTENNA

Screw the antenna into the hole at the top of the handset.

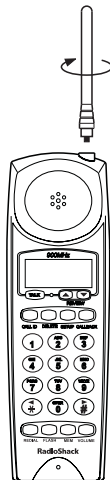

PLACING THE BASE ON A DESK TOP

Follow these steps to place the base on a desk, shelf, or table.

1. Remove the bracket by holding in both tabs and gently pulling out the wide end of the bracket.

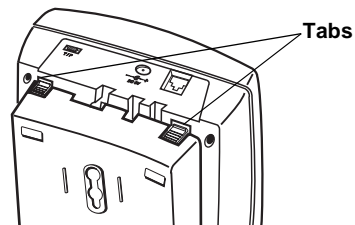

2. Plug one end of the supplied long modular cord into the phone jack on the back of the base.

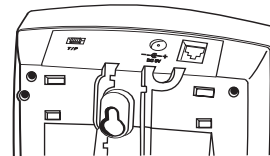

3. Insert the supplied AC adapter's barrel plug into the **DC 9V** jack on the back of the base.

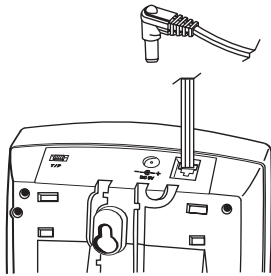

4. Route the adapter's cord through the strain relief slot on the bottom of the base.

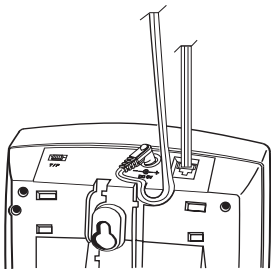

5. Insert the tabs on the narrow end of the bracket into both upper slots on the bottom of the base as shown and push the tabs on the wide end of the bracket into the upper slots on the bottom of the base.

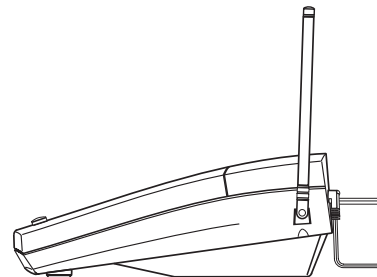

6. Plug the modular cord's other end into a modular phone line jack.
7. Plug the adapter into a standard AC outlet.
8. Raise the base's antenna to a vertical position.

MOUNTING THE BASE ON A WALL PLATE

1. Follow Steps 1 through 3 under "Placing the Base on a Desk Top" on Page 6.
2. Route the modular cord through the left groove on the bottom of the base and the adapter cord through the groove below the strain relief slot.

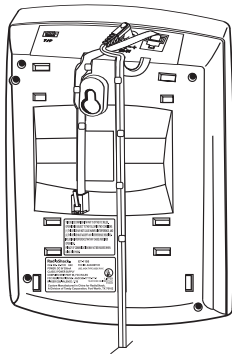

3. Insert the tabs on the narrow end of the bracket into the slots on the bottom of the base as shown and route the other end of the short modular cord through the center of the bracket.

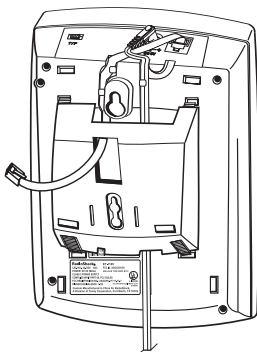

4. Push the tabs on the wide end of the bracket into the lower slots on the bottom of the base.

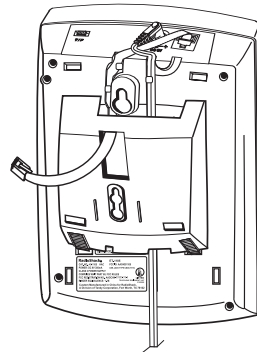

5. Plug the short modular cord's other end into the wall plate jack, align the base's keyhole slots with the wall plate studs, and slide the base downward to secure it.

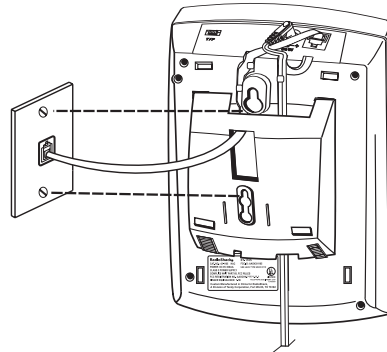

6. Plug the adapter into a standard AC outlet.
7. Raise the base's antenna to a vertical position.

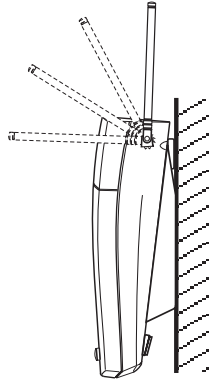

2. Plug the battery pack's connector into the socket in the compartment. The connector fits only one way.

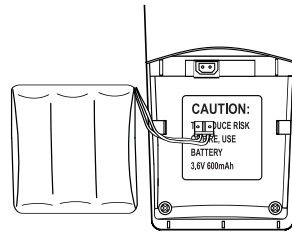

Note: For easier battery pack connection, lift it out of the compartment, insert its connector into the socket, then replace the battery pack inside the compartment.

3. Replace the cover.

To charge the battery pack, place the handset on the base. The CHARGE indicator on the base lights.

CONNECTING AND CHARGING THE BATTERY PACK

The ET-1105 comes with a rechargeable nickel-cadmium battery pack in the handset but not connected. Before using your phone, you must connect the battery pack and then charge it for about 16 hours.

1. Press down and slide off the compartment cover as shown.

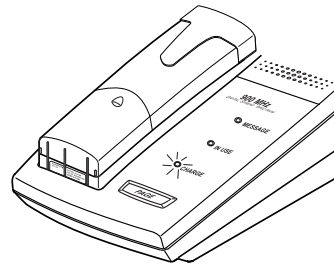
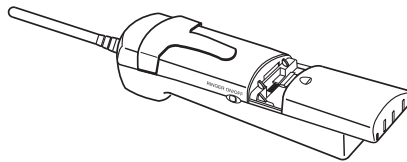

Recharge the battery pack when  and **LOW BATTERY** appear on the handset's display.

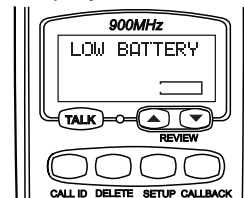

Notes:

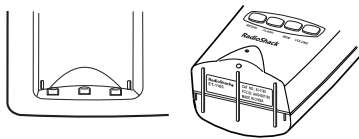

- You can place the handset on the base face down or face up without removing the belt clip. If you want to use the hanging hole on the back of the handset to place the handset on the wall-mounted base face-up, remove the belt clip (see "Removing the Belt Clip" on Page 13). However, the battery pack will not fully charge in this position.
- When you first use the phone after charging or recharging the battery pack, the phone might not work and you might hear an error tone when you press **TALK**. If this happens, return the handset to the base for about 6 seconds. This resets the security access protection code.
- If the **CHARGE** indicator does not light when you place the handset on the base, be sure the battery pack and AC adapter are correctly and securely connected.

Also, check the charging contacts on the handset and the base. If the contacts are dirty or tarnished, clean them with a pencil eraser.



- If the battery pack gets completely discharged or the base loses power while the handset is away from it, the security access-protection code needs to be reset. To reset the code, place the handset on the base. If it

was the handset that lost power, leave the handset on the base to charge the battery pack.

- If the battery pack gets weak during a call, the handset beeps once every 16 seconds. If this happens, you cannot make another call on the phone until you recharge the battery pack.
- About once a month, fully discharge the battery pack by keeping the handset off the base until  and **LOW BATTERY** appear. Otherwise, the battery pack loses its ability to fully recharge.
- To avoid damage to the battery pack, always recharge the handset before battery power grows too weak to display  .
- If you are not going to use your phone for an extended period of time, disconnect the battery pack. This increases the battery pack's usable life.
- The supplied battery pack should last for about a year. When it loses its ability to fully recharge, order a replacement battery pack from your local RadioShack store (see "Replacing the Battery Pack" on Page 26).

SETTING THE DIALING MODE

Set **T/P** (Tone/Pulse) on the back of the base for the type of service you have. If you are not sure which type you have, once the battery is fully charged, do this test.

1. Set **T/P** to **T**.

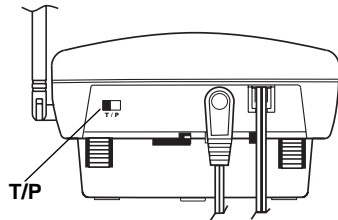

2. Lift the handset, then press **TALK** and listen for the dial tone.

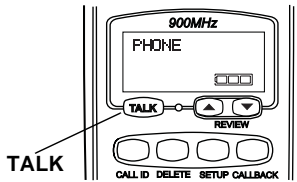

3. Press any number other than 0.

Note: If your phone system requires that you dial an access code (9, for example) before you dial an outside number, do not press the access code either.

If the dial tone stops, you have touch-tone service. Leave **T/P** set to **T**.

If the dial tone continues, you have pulse service. Set **T/P** to **P**.

SELECTING THE LANGUAGE

The ET-1105 comes set to display all Caller ID messages in English, but if you want it to display messages in French or Spanish, follow these steps.

1. Press **SETUP** on the handset. **LANGUAGE** and the currently selected language appear.



SETUP

Note: If you do not press any key within 30 seconds after the language selection display appears, the ET-1105 exits the language selection display without changing the current selection.

2. To select another language, repeatedly press **#/▶** until you see the desired language.

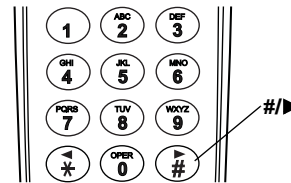

3. Press **SETUP** to store the selected language.

SETTING THE AREA CODE

When you return a call from a Caller ID record (see "Dialing Numbers from a Caller ID Record" on Page 21), your phone automatically dials 1, the area code, and the number. The ET-1105 lets you store one local area code and three neighborhood area codes. If the number you call has the same area code with your local area code, the ET-1105 dials the 7-digit local number. If the number you call has the same area code with one of three neighborhood area codes, the ET-1105 dials the 10-digit local number.

Follow these steps to set area codes.

Note: If you make a mistake or do not press a key within 10 seconds during these steps, start again at Step 1.

1. Press **SETUP**. The language selection display appears.
2. Press ***/***. The currently entered area codes (or **AREACODE=000 000/000/000**) appear.



3. Enter your local area code first, then the three neighborhood area codes, then press **SETUP** to store them.

SETTING THE RINGER

Turning the Ringer On or Off

You can turn the ET-1105's ringer on and off. Set **RINGER** on the side of the handset to **ON** to hear an incoming call or a page from the base. Set **RINGER** to **OFF** to silence the ringer.

Note: With the ringer off, you can still make or receive calls using this cordless phone. Telephones on the same line still ring when there is an incoming call, and the IN USE indicator on the ET-1105's base flashes until you answer the call.

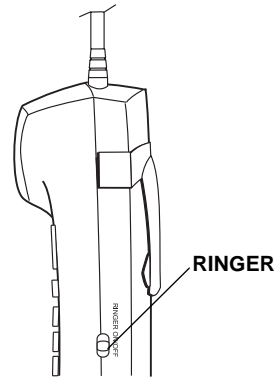

Checking/Setting the Ringer

You can set the ET-1105's handset to sound any of three ringer types. The handset is preset to use the ringer tone (1). To change or hear the different tones, press **FLASH** when the phone is not in use. **PROG. RINGER** displays. With **RINGER** set to **ON**, press 1, 2, or 3, then press **FLASH** to confirm the setting. (The last number button you pressed is the tone you will hear.)

USING A HEADSET

You can make or answer calls with hands-free convenience using an optional headset that has a $\frac{3}{32}$ -inch (2.5 mm) plug. We recommend RadioShack Cat. No. 43-195, which is specially designed for use with the ET-1105.

Follow these steps to use a headset.

1. Insert the headset's plug into the  jack on the top of the handset.

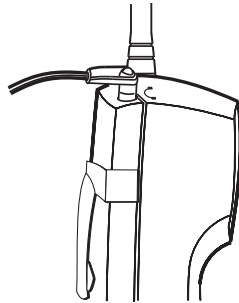

2. Place the headset on your head with the earpiece over either ear and adjust the microphone boom until it is about even with your chin.
3. Hang the belt clip on your belt.
4. Make or receive calls as you would normally (see "Making and Receiving a Call" on Page 14).

Notes:

- Connecting a headset disconnects the handset's earpiece and microphone.

- If you place the handset on the base to recharge it while the headset is connected, be sure the handset seats properly.

REMOVING THE BELT CLIP

The belt clip on the back of the handset lets you hang the handset on your belt for easy portability. But to use the hanging hole on the back of the handset to place the handset on the wall-mounted base face-up, you must remove the belt clip.

Insert a flat-blade screwdriver into either side of the belt clip, then pull it off.

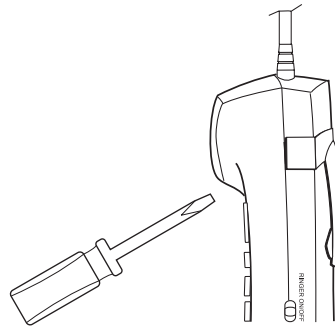

To replace the belt clip, insert either tab of the belt clip into one of the handset's slots, then snap the other tab into handset's other slot.

TELEPHONE OPERATION

MAKING AND RECEIVING A CALL

To make a call, lift the handset and press **TALK**. **PHONE** displays. When the TALK indicator lights steadily and you hear the dial tone, dial the desired phone number or memory number (see "Memory Dialing" on Page 15).

The ET-1105 displays the phone number as you dial. Then **PHONE** disappears, the duration of your call (after 14 seconds) in minutes and seconds displays.

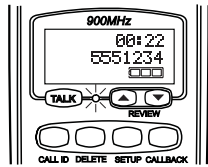

To answer a call if the handset is on the base, lift the handset and press **TALK**. Or, if the handset is away from the base, press any key on the handset before speaking. The TALK indicator on the handset lights and the IN USE indicator on the base flashes.

To end a call, place the handset on the base or press **TALK**. The TALK and IN USE indicators turn off.

Notes:

- If you press **TALK** to hang up and the phone does not disconnect, move closer to the base then press **TALK** again, or place the handset on the base.

- If you hear loud static during a conversation, move the handset closer to the base.
- **OUT OF RANGE** appears when the distance from the handset to the base is out of the phone's range.

SETTING THE HANDSET'S VOLUME

You can select any of four different volume settings by repeatedly pressing **VOLUME** during a call.

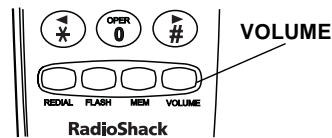

USING REDIAL

You can quickly redial the last number dialed. Lift the handset and press **TALK**. When you hear the dial tone, press **REDIAL**. The number appears on the display as the phone dials it.

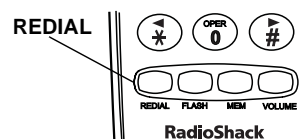

Notes:

- The redial memory holds up to 32 digits, so you can redial long-distance as well as local numbers.

- We recommend you not use **REDIAL** to dial numbers that include a tone entry. This could result in a wrong number being dialed. (See "Using Tone Services on a Pulse Line.")
 - The redial memory does not store a flash entry or any digits entered after you press **FLASH** (see "Using Flash").
3. When the service answers, press *****. ***** appears. Any additional numbers you dial are sent as tone signals.
 4. After you complete the call, return the handset to the base or press **TALK**. The phone automatically re-sets to pulse dialing.

USING FLASH

FLASH performs the electronic equivalent of a switchhook operation for special services, such as Call Waiting.

For example, if you have Call Waiting, press **FLASH** to answer an incoming call without disconnecting the current call. Press **FLASH** again to return to the first call.

Note: If you do not have any special phone services, pressing **FLASH** might disconnect the current call.

USING TONE SERVICES ON A PULSE LINE

Some special services, such as bank-by-phone, require tone signals. If you have pulse service, you can still use these special tone services by following these steps.

1. Be sure **T/P** is set to **P**.
2. Press **TALK** and dial the service's main number.

USING PAGE

To page the person who has the handset or to locate the handset when the phone is not in use, press **PAGE** on the base. The handset beeps twice per second for 15 seconds and **PAGING** appears. The MESSAGE indicator flashes while the handset beeps.

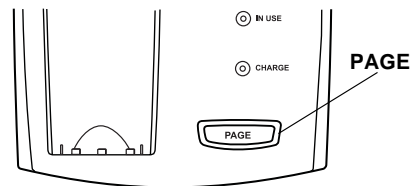

To stop the handset from beeping before it automatically stops, press any key on the handset or **PAGE** on the base.

Note: You cannot page the handset during a call.

MEMORY DIALING

You can store up to 20 phone numbers in memory, then dial a stored number by pressing a two-digit memory location number.

Each stored number can be up to 16 digits long.

Storing a Number in Memory

Notes:

- If **T/P** is set to **P** and you want to use tone dialing for a memory number, you must store a ***** as the first entry of the number you want to tone dial.
- Do not store a number with both pulse and tone entries in the same memory location. This could result in a wrong number being dialed.
- Each pause and tone entry (*****) uses one digit of memory.
- To keep your accounts secure, we recommend you do not store your personal access code for services such as bank-by-phone in a memory location.
- An error tone sounds and the phone exits the programming mode if you wait more than 30 seconds between each keypress or enter more than 16 digits. You must start over at Step 1.

1. Press **MEM. MEMORY STORE** appears.

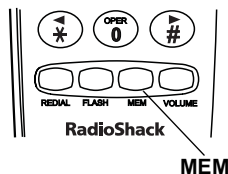

2. Enter the number you want to store. The number appears on the display.

If you enter an incorrect digit, start from Step 1, then re-enter the correct digit.

3. Press **MEM. ENTER 01-20** appears.
4. Enter a two-digit memory location number between 05 and 20 (01-04 are reserved for your VIP Call List). The ET-1105 beeps twice, and the display becomes blank.
5. To keep a record of each stored number, use a flat-blade screwdriver to lift the plastic cover from the telephone number index card. Write the name on the index card.

Note: If you receive a call while you are storing information in memory, press **TALK** to answer the call. After the call, begin again at Step 1.

To replace a stored number, store a new one in its place.

Using the VIP Call List

Your phone lets you save 4 phone numbers in the memory location numbers 01-04 as its VIP Call List. Whenever someone calls from one of those 4 numbers, if you subscribe to Caller ID, the system sounds distinctive rings after the first ring to alert you. **VIP** displays when you recall the phone numbers (see "Recalling Numbers Stored in Memory" on Page 17).

Entering a Pause

In some telephone systems, you must dial an access code (9, for example) and wait for a second dial tone before you can dial an outside number. You can store the access code with the phone number. However, you should also store a pause after the access code to allow the outside line time to connect. To do so, press **REDIAL** to enter a 2-second pause after entering the access code. **P** appears. For a longer pause, press **RE-DIAL** again.

Recalling Numbers Stored in Memory

1. Press **CALL ID**, then press **#/▶**. **TOTAL MEM=xx** displays.

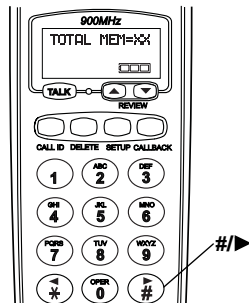

Note: If no phone number is stored, **MEM EMPTY** displays.

2. Repeatedly press **REVIEW ▲** or **▼** until the desired number appears.

Dialing a Memory Number

1. Press **TALK**. The TALK indicator lights.
2. When you hear the dial tone, press **MEM** then enter the 2-digit memory location number. The ET-1105 automatically dials the displayed phone number.

Or, follow Step 2 in "Recalling Numbers Stored in Memory" on Page 17 to recall the desired phone number. Then press **CALLBACK**.

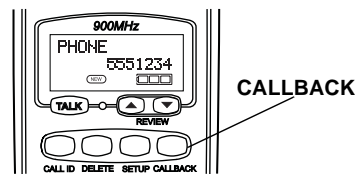

Chain-Dialing Service Numbers

For quick recall of numbers for special services (such as alternate long distance or bank by phone), store each group of numbers in its own memory location.

When calling special services, dial the service's main number first. Then, at the appropriate place in the call, press **MEM** and enter the number for the location where the additional information is stored.

Testing Stored Emergency Numbers

If you store an emergency service's number (police department, fire department, ambulance) and you choose to test the stored number, make the test call during the late evening or early morning hours to avoid peak demand periods. Remain on the line to explain the reason for your call.

Deleting Information in a Single Memory Location

1. Recall the memory location containing the information you want to delete.
2. Press **DELETE**. **DELETE ?** appears.

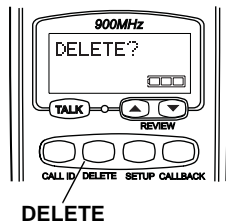

3. Press **DELETE** again to confirm deletion. The previous memory location number and the number stored there appear.

To exit without deleting the information, wait 10 seconds without pressing any button.

Deleting Information in All Memory Locations

1. Press **CALL ID**, then press **#/▶**. **TOTAL MEM=xx** displays.
2. Press **DELETE**. **DELETE ALL ?** appears.
3. Press **DELETE** again to confirm deletion. **DELETE OK** appears.

To exit without deleting all of the memory location information, wait 10 seconds without pressing any button.



CALLER ID OPERATION

If you subscribe to Caller ID service from your phone company, the ET-1105 automatically displays the information the phone company sends, along with the date and time the call was received, between the first and second rings of every call you receive. It stores up to 45 number only or name and number call records in its Caller ID memory.

The display also shows if caller information is not available or if the number is blocked by the sender (see "Caller ID Displays" on Page 20).

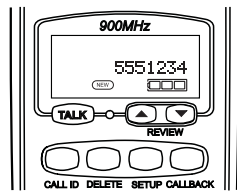
The IN USE indicator flashes on the base during an incoming call, **RING** appears briefly, the call record and **NEW** appear for 10 seconds, then the display blanks out.



If you subscribe to your phone company's message waiting service, your system informs you when you have a message waiting. If the IN USE and MESSAGE indicators on the base flash (or  appears after you press **TALK** or **CALL ID** on the handset), you have a voice message in your mailbox. The IN USE and MESSAGE indicators flash (or  appears after you press **TALK** or **CALL ID** on the handset) until you retrieve the message.

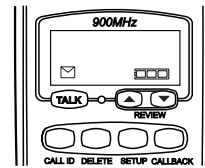

If you subscribe to Call Waiting, the MESSAGE indicator lights on the base during a call. The Caller ID record appears. If you want to answer the incoming call, press **FLASH**. To resume the previous phone conversation, press **FLASH** again.

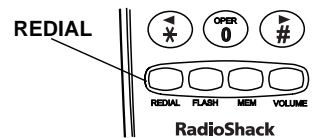

CALLER ID DISPLAYS

English Display — French Spanish	Description
xx NEW CID TOTAL CID= xx NOUV IDAP TOUT IDAP=xx NUEV. ID. TOTAL ID.=xx	The first line indicates the number of new calls. The second line shows the total number of Caller ID records in memory.
ERROR ERREUR ERROR	Appears when the Caller ID information was garbled, or if there was an error during the transmission.
PRIVATE PRIVÉ PRIVADO	Appears if the caller chose to block sending Caller ID information. No caller information appears.
UNAVAILABLE NON DISPON. NO DISPON.	Appears if the caller is not within a Caller ID service area, or during operator-assisted calls or calls made with a credit card.
END OF LIST FIN DE LISTE FIN DE LISTA	Appears when you reach the end of your call records.
NO CID MSG PAS DE MESSIDAP NING MENS ID	Appears when there are no Caller ID records in memory.
R#xx	Appears when you review a Caller ID record from someone who has called more than one time from the same number.

REVIEWING CALLER ID RECORDS

1. Press **CALL ID**. **xx NEW CID TOTAL CID=xx** appears.

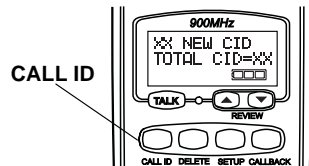

2. Repeatedly press **REVIEW ▲** to see more recent calls or **REVIEW ▼** to see older calls.
3. To see the Caller ID record number and date/time, press *** / ◀** twice.

Note: If you do not press a button within 10 seconds while you are reviewing Caller ID records, the ET-1105's display automatically blanks out.

STORING CALLER ID RECORDS IN A MEMORY LOCATION

1. Press **CALL ID**. **xx NEW CID TOTAL CID= xx** appears.
2. Repeatedly press **REVIEW ▲** or **▼** until you see the desired Caller ID record.
3. Press **MEM** twice, then enter the memory location number. The ET-1105 beeps and the phone number is stored.

DIALING NUMBERS FROM A CALLER ID RECORD

1. Press **CALL ID**, then press **REVIEW ▲** or **▼** until you see the phone number you want to dial.
2. Press **CALLBACK**. The ET-1105 dials the displayed phone number.

If the phone number's area code does not match the stored area code, the system automatically dials a 1 before dialing the displayed area code and 7-digit phone number. (See "Setting the Area Code" on Page 12.)

DELETING CALLER ID RECORDS

The ET-1105 lets you delete *individual* Caller ID records or *all reviewed* Caller ID records at one time.

To delete a single Caller ID record:

1. Press **CALL ID** then repeatedly press **REVIEW ▲** or **▼** until the record you want to delete appears.
2. Press **DELETE**. **DELETE ?** appears.
3. Press **DELETE** again. **DELETE OK** appears.

To delete all Caller ID records:

1. Press **CALL ID** then press **DELETE**. **DEL ALL OLD ?** appears.
2. Press **DELETE**. **DELETE OK** appears.

TROUBLESHOOTING

We do not expect you to have any problems with your telephone, but if you do, the following suggestions might help.

Problem	Suggestion
The handset does not work.	Move the handset closer to the base.
	Be sure the phone line cord and AC adapter are correctly and securely connected.
	Be sure the battery pack is connected and charged.
	Raise the base's antenna to a vertical position.
	Return the handset to the base for 6 seconds, then try again.
Volume drops or you hear unusual sounds.	Someone has picked up another phone on the same line. Hang up the other phone.
Call is noisy.	Do not place the base near appliances or large metal objects.
	Keep the handset away from interference sources such as computers, remote control toys, wireless alarm systems, wireless intercoms and room monitors, fluorescent lights, and electrical appliances. If the interference is severe, turn off the interfering device.
	Hang up and redial the number.
Phone dials more than 7 digits when dialing a local phone number from a Caller ID record.	Store the local area code (see "Setting the Area Code" on Page 12).
The handset's range decreases.	Raise the base's antenna to a vertical position.
	Return the handset to the base to recharge the battery pack.
	Be sure the base's antenna is not touching a metal surface.

Problem	Suggestion
Receiver sound flutters or fades.	Be sure the battery pack is charged.
	Raise the base's antenna to a vertical position.
	Move the handset closer to the base.
Can receive calls, but cannot make calls.	Set T/P correctly for the type of service you have (see "Setting the Dialing Mode" on Page 11).

If you still have problems, disconnect the phone. If other phones on the same line work properly, the fault is in this phone or its installation. If you cannot find the problem, take your ET-1105 to your local RadioShack store for assistance.



OUT OF RANGE INDICATIONS

If you move the ET-1105's handset out of the base's range, **OUT OF RANGE** displays and the handset will not operate properly.

If you move the handset out of the base's range when the handset is not in use, the handset beeps twice every 16 seconds. When you move the handset back within range of the base again, **OUT OF RANGE** disappears.

If you move the handset out of the base's range while a call is in progress, two beeps sound through the earpiece every 3-4 seconds, and you and the other party cannot hear each other.

If you move the handset back within the base's range within 30 seconds, **OUT OF RANGE** disappears, and you can resume your phone conversation.

If you keep the handset out of the base's range for 30 seconds or more, two beeps sound through the earpiece every 4 seconds. After 30 seconds, the call is disconnected, and the handset beeps twice every 16 seconds. When you move the handset back within range of the base again, **OUT OF RANGE** disappears.

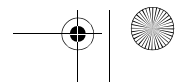
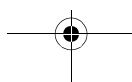
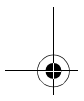
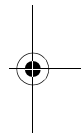
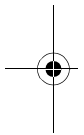

CARE AND MAINTENANCE

Your RadioShack ET-1105 Digital Spread Spectrum 900 MHz Cordless Telephone is an example of superior design and craftsmanship. The following suggestions will help you care for your phone so you can enjoy it for years.



Keep the phone dry. If it gets wet, wipe it dry immediately. Liquids might contain minerals that can corrode the electronic circuits.



Use and store the phone only in normal temperature environments. Temperature extremes can shorten the life of electronic devices, damage batteries, and distort or melt plastic parts.



Keep the phone away from dust and dirt, which can cause premature wear of parts.



Handle the phone gently and carefully. Dropping it can damage circuit boards and cases and can cause the phone to work improperly.



Use only fresh batteries of the required size and recommended type. Batteries can leak chemicals that damage your phone's electronic parts.



Wipe the phone with a damp cloth occasionally to keep it looking new. Do not use harsh chemicals, cleaning solvents, or strong detergents to clean the phone.

Modifying or tampering with the phone's internal components can cause a malfunction and might invalidate its warranty and void your FCC authorization to operate it. If your phone is not performing as it should, take it to your local RadioShack store for assistance. If the trouble is affecting the telephone lines, the phone company can ask you to disconnect your phone until you have resolved the problem.

REPLACING THE BATTERY PACK

If you follow the instructions in "Connecting and Charging the Battery Pack" on Page 9, the battery pack should last about one year. If the battery does not hold a charge for more than 2 hours after an overnight charge, replace the battery with a new 3.6 volt, 600 milliamp battery with a connector that fits the socket in the battery compartment. You can order a replacement battery pack through your local RadioShack store.

Install the new battery pack as described below, then charge the battery pack for about 15 hours (see "Connecting and Charging the Battery Pack" on Page 9).

Note: To avoid losing information stored in memory, try to install and begin charging the new battery pack within 2–3 minutes.

1. Press down and slide off the cover.

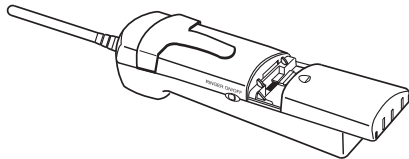

2. Gently pull on the battery pack connector to disconnect it, then remove the battery pack.
3. Plug the new battery pack's connector into the socket and place the battery pack into the compartment.
4. Replace the cover.

Cautions:

- You must use a replacement battery pack of the same size and type, with the proper connector.
- Do not dispose of the battery pack in a fire because it might explode.
- Do not open or mutilate the battery pack.
- Be careful not to short the battery pack by touching it with conducting materials, such as rings, bracelets, and keys. The battery pack or conductor might overheat and burn.

If you have trouble replacing the battery pack, take the phone to your local RadioShack store for assistance.

Important: This phone can use nickel-cadmium rechargeable batteries. At the end of a nickel-cadmium battery's useful life, it must be recycled or disposed of properly. Contact your local, county, or state hazardous waste management authorities for information on recycling or disposal programs in your area or call 1-800-843-7422. Some options that might be available are: municipal curbside collection, drop-off boxes at retailers such as your local RadioShack store, recycling collection centers, and mail-back programs.



THE FCC WANTS YOU TO KNOW

In the unlikely event that your phone causes problems on the phone line, the phone company can temporarily discontinue your service. If this happens, the phone company attempts to notify you in advance. If advance notice is not practical, the phone company notifies you as soon as possible and advises you of your right to file a complaint with the FCC.

Also, the phone company can make changes to its lines, equipment, operations, or procedures that could affect the operation of this telephone. The telephone company notifies you of these changes in advance, so you can take the necessary steps to prevent interruption of your telephone service.

Your phone might cause TV or radio interference even when it is operating properly. To determine whether your phone is causing the interference, turn off your phone. If the interference goes away, your phone is causing the interference. Try to eliminate the interference by:

- Moving your phone away from the receiver
- Connecting your phone to an AC outlet that is on a different electrical circuit from the receiver
- Contacting your local RadioShack store for help

If you cannot eliminate the interference, the FCC requires that you stop using your phone.

Some cordless telephones operate on frequencies that may cause interference to nearby TVs and VCRs. To minimize or prevent such interference, the base of the cordless telephone should not be placed near or on top of a TV or VCR.

LIGHTNING

Your telephone has built-in lightning protection to reduce the risk of damage from surges in telephone line and power line current. This lightning protection meets or exceeds FCC requirements. However, lightning striking the telephone or power lines can damage your telephone.

Lightning damage is not common. Nevertheless, if you live in an area that has severe electrical storms, we suggest that you unplug your phone during storms to reduce the possibility of damage.



Limited One-Year Warranty

This product is warranted by RadioShack against manufacturing defects in material and workmanship under normal use for one (1) year from the date of purchase from RadioShack company-owned stores and authorized RadioShack franchisees and dealers. EXCEPT AS PROVIDED HEREIN, RadioShack MAKES NO EXPRESS WARRANTIES AND ANY IMPLIED WARRANTIES, INCLUDING THOSE OF MERCHANTABILITY AND FITNESS FOR A PARTICULAR PURPOSE, ARE LIMITED IN DURATION TO THE DURATION OF THE WRITTEN LIMITED WARRANTIES CONTAINED HEREIN. EXCEPT AS PROVIDED HEREIN, RadioShack SHALL HAVE NO LIABILITY OR RESPONSIBILITY TO CUSTOMER OR ANY OTHER PERSON OR ENTITY WITH RESPECT TO ANY LIABILITY, LOSS OR DAMAGE CAUSED DIRECTLY OR INDIRECTLY BY USE OR PERFORMANCE OF THE PRODUCT OR ARISING OUT OF ANY BREACH OF THIS WARRANTY, INCLUDING, BUT NOT LIMITED TO, ANY DAMAGES RESULTING FROM INCONVENIENCE, LOSS OF TIME, DATA, PROPERTY, REVENUE, OR PROFIT OR ANY INDIRECT, SPECIAL, INCIDENTAL, OR CONSEQUENTIAL DAMAGES, EVEN IF RadioShack HAS BEEN ADVISED OF THE POSSIBILITY OF SUCH DAMAGES.

Some states do not allow the limitations on how long an implied warranty lasts or the exclusion of incidental or consequential damages, so the above limitations or exclusions may not apply to you.

In the event of a product defect during the warranty period, take the product and the RadioShack sales receipt as proof of purchase date to any RadioShack store. RadioShack will, at its option, unless otherwise provided by law: (a) correct the defect by product repair without charge for parts and labor; (b) replace the product with one of the same or similar design; or (c) refund the purchase price. All replaced parts and products, and products on which a refund is made, become the property of RadioShack. New or reconditioned parts and products may be used in the performance of warranty service. Repaired or replaced parts and products are warranted for the remainder of the original warranty period. You will be charged for repair or replacement of the product made after the expiration of the warranty period.

This warranty does not cover: (a) damage or failure caused by or attributable to acts of God, abuse, accident, misuse, improper or abnormal usage, failure to follow instructions, improper installation or maintenance, alteration, lightning or other incidence of excess voltage or current; (b) any repairs other than those provided by a RadioShack Authorized Service Facility; (c) consumables such as fuses or batteries; (d) cosmetic damage; (e) transportation, shipping or insurance costs; or (f) costs of product removal, installation, set-up service adjustment or reinstallation.

This warranty gives you specific legal rights, and you may also have other rights which vary from state to state.

RadioShack Customer Relations, 200 Taylor Street, 6th Floor, Fort Worth, TX 76102

We Service What We Sell

04/99

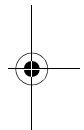
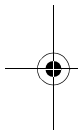

RadioShack
A Division of Tandy Corporation
Fort Worth, Texas 76102

08A99

Printed in China

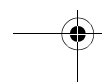
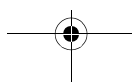

Free Manuals Download Website

<http://myh66.com>

<http://usermanuals.us>

<http://www.somanuals.com>

<http://www.4manuals.cc>

<http://www.manual-lib.com>

<http://www.404manual.com>

<http://www.luxmanual.com>

<http://aubethermostatmanual.com>

Golf course search by state

<http://golfingnear.com>

Email search by domain

<http://emailbydomain.com>

Auto manuals search

<http://auto.somanuals.com>

TV manuals search

<http://tv.somanuals.com>