

Cat. No. 43-1047
OWNER'S MANUAL

Please read before using this equipment.

ET-547

**25-Channel Cordless Telephone with
3 Priority and 10 Speed-Dial Memories**

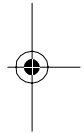
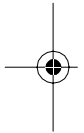

Radio Shack

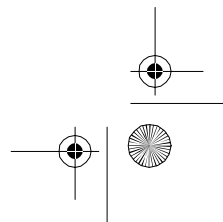
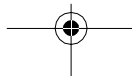
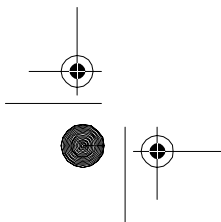

FEATURES

Your ET-547 25-Channel Cordless Telephone with 3 Priority and 10 Speed Dial Memories is designed to exacting standards that ensure reliability, long life, and outstanding performance.

Its features include:

25 Channels — so you can switch to the one that provides the least interference

Super CCT Noise-Reduction Circuitry — provides clear telephone conversations, giving you sound clarity comparable to that of a corded phone.

Security Access-Protection Code — automatically sets the first time you use your phone to prevent other cordless phone users from using your phone line while the handset is off the cradle.

COM-LOK® — ensures that other cordless phone users cannot use your phone line when the handset is on the cradle.

Page — lets you send a paging signal from the base to the handset to page someone or locate the handset if you misplace it.

13-Memory Automatic Dialing — lets you store frequently called numbers then dial them with the touch of a button (from three priority dialing memories), or by entering one of 10 speed-dial memory location numbers.

Redial — lets you quickly redial the last number dialed by touching a single button.

Flash — sends an electronic switch-hook signal for use with special phone services, such as call waiting.

Volume Control — lets you adjust the volume of the handset's ringer/paging tone and your telephone conversations.

Tone/Pulse Dialing — lets you use your phone with tone or pulse service.

Hearing-Aid Compatibility — lets you use your phone with hearing aids that have a T (telephone) switch.

This telephone has been tested and found to comply with all applicable UL and FCC standards.

© 1995 Tandy Corporation.
All Rights Reserved.



COM-LOK and Radio Shack are registered trademarks used by Tandy Corporation.

Important Note: Cordless phones such as this one require AC power to operate. When the AC power is off, you cannot dial out or receive incoming calls using your ET-547. To be safe, you should also have a phone that does not need AC power to operate (not a cordless phone) so you can still make and receive calls if there is an AC power failure.

For your records, we urge you to record the serial number of your phone in the space below. The serial number is located on the bottom panel of the base.

Serial Number: _____

Warning: To prevent fire or shock hazard, do not expose this product to rain or moisture.

	CAUTION RISK OF ELECTRIC SHOCK. DO NOT OPEN.	
CAUTION: TO REDUCE THE RISK OF ELECTRIC SHOCK, DO NOT REMOVE COVER OR BACK. NO USER-SERVICEABLE PARTS INSIDE. REFER SERVICING TO QUALIFIED PERSONNEL.		



This symbol is intended to alert you to the presence of uninsulated dangerous voltage within the product's enclosure that might be of sufficient magnitude to constitute a risk of electric shock. Do not open the product's case.



This symbol is intended to inform you that important operating and maintenance instructions are included in the literature accompanying this product.

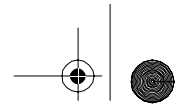

READ THIS BEFORE INSTALLATION



Each device that you connect to the phone line draws power from the phone line. We refer to this power draw as the device's Ringer Equivalence Number, or REN. The REN is shown on the bottom of the base.

If you are using more than one phone or other device on the line, add up all the RENs. If the total is more than five, your phones might not ring. In rural areas, a total REN of three might impair ringer operation. If ringer operation is impaired, remove a device from the line.

FCC STATEMENT

This telephone complies with Part 68 of *FCC Rules*. You must, upon request, provide the FCC Registration Number and the REN to your phone company. These numbers are located on the bottom panel of the base.

Note: You must not connect your phone to any of the following:

- coin-operated systems
- party-line systems
- most electronic key phone systems

Some cordless telephones operate on frequencies that may cause interference to nearby TVs and VCRs. To minimize or prevent such interference, the base of the cordless telephone should not be placed near or on top of TVs or VCRs. If interference is experienced, moving the cordless telephone farther away from the TV or VCR will often reduce or eliminate the interference.

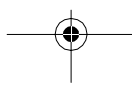
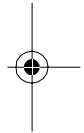
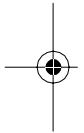

CONTENTS

Installation	6
Selecting a Location	6
Placing the Base on a Desk Top.....	6
Mounting the Base on a Wall Plate.....	7
Mounting the Base Directly on the Wall.....	8
Installing and Charging the Battery	9
Setting the Dialing Mode	11
Setting the Handset's Volume	11
Setting the Ringer Tone	11
Using RINGER ON/OFF	12
Operation	13
Making and Receiving Calls	13
Selecting the Channel	13
Using Redial	13
Using Flash	14
Using Tone Services on a Pulse Line	14
Paging	15
Memory Dialing	15
Storing a Number in Memory	15
Storing a Tone Entry with a Memory Number.....	16
Entering a Pause	16
Dialing a Memory Number	16
Chain-Dialing Service Numbers	17
Testing Stored Emergency Numbers	17
Troubleshooting	18
Care and Maintenance	21
Replacing the Battery.....	22
The FCC Wants You to Know	23
Lightning	23

INSTALLATION

SELECTING A LOCATION

You can place the phone on a desktop or table, or mount it on a wall. Select a location that is:

- near an AC outlet
- near a telephone line jack
- out of the way of normal activities
- away from electrical machinery, electrical appliances, metal walls or filing cabinets, wireless intercoms, alarms, and room monitors
- away from other cordless phones

The base's location affects the handset's range. If you have a choice of several locations, try each to see which provides the best performance.

Notes:

- Your telephone connects directly to a modular telephone line jack. If your phone line jack is not a modular jack, you can update the wiring yourself, using jacks and adapters available at your local Radio Shack store. Or, you can let the phone company update the wiring for you.
- The phone company will charge you for the installation of necessary jacks.
- The USOC number of the jack to be installed is RJ11C (RJ11W if you want to mount it on a wall plate).

Placing the Base on a Desk Top

Follow these steps when you place the base on a desk, shelf, or table.

1. Plug one end of the supplied modular cord into the **TEL. LINE** jack on the back of the base.

2. Plug the modular cord's other end into a modular phone line jack.

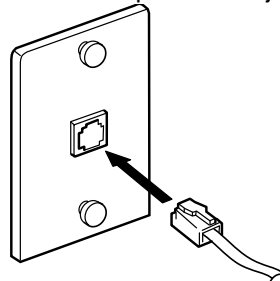

3. Insert the supplied AC adapter's barrel plug into the **DC IN 9V** jack on the back of the base.

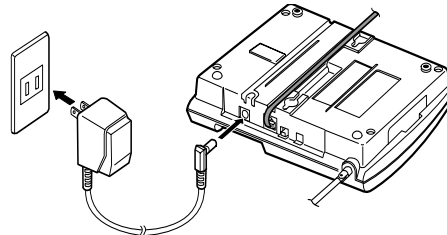

4. Route the adapter's cord through the strain relief slot on top of the base.

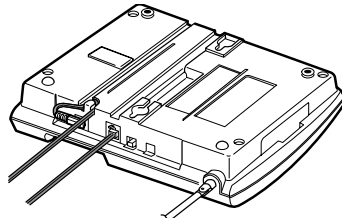

5. Plug the adapter into a standard AC outlet.
6. Fully extend the base's antenna and place it in a vertical position.

Mounting the Base on a Wall Plate

1. Plug one end of the supplied modular cord into the **TEL. LINE** jack on the back of the base.
2. Route the modular cord through the groove on the bottom of the base.

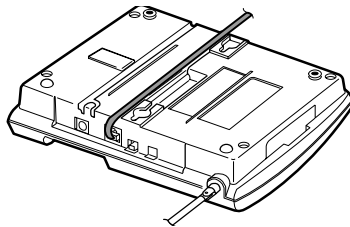

3. Plug the cord's other end into a modular phone line jack.

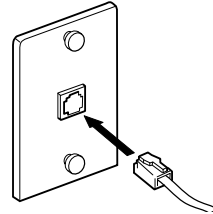

4. Insert the supplied AC adapter's barrel plug into the **DC IN 9V** jack on the back of the base.

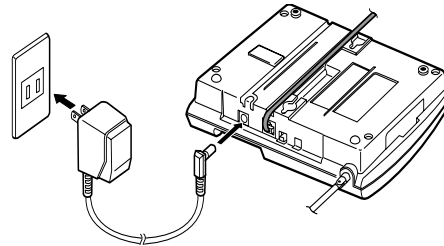

5. Route the adapter's cord through the strain relief slot on top of the base and through the groove on the bottom of the base.

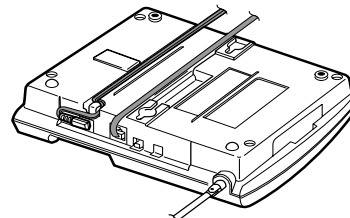

6. Plug the adapter into a standard AC outlet.

- Align the base's keyhole slots with the wall plate studs and slide the base downward to secure it.

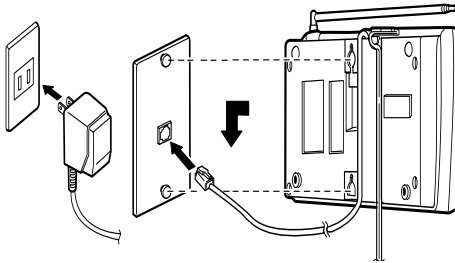

- Press and lift out the handset holder, rotate it 180°, then snap it back into place so it holds the handset.

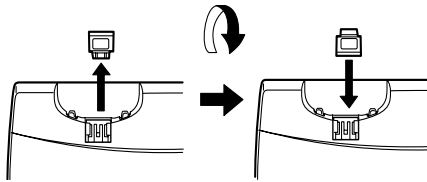

- Fully extend the base's antenna and place it in a vertical position.

Mounting the Base Directly on the Wall

For this mounting method, you need two wood screws (not supplied) with heads that fit into the keyhole slots on the bottom of the base.

- Drill two holes $3^{15}/16$ inches apart. Then thread a screw into each hole, letting the heads extend about $1/5$ inch from the wall.

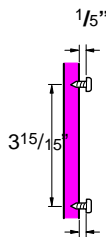

- Plug one end of the supplied modular cord into the **TEL. LINE** jack on the back of the base.

- Route the modular cord through the groove on the bottom of the base.

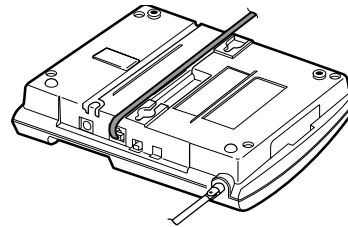

- Plug the cord's other end into a modular phone line jack.

- Insert the supplied AC adapter's barrel plug into the **DC IN 9V** jack on the back of the base.

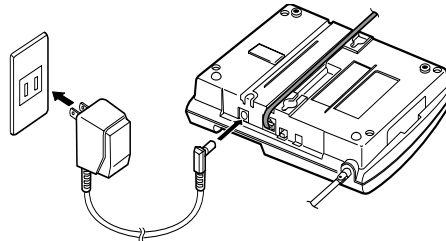

- Route the adapter's cord through the strain relief slot on top of the base and through the groove on the bottom of the base.

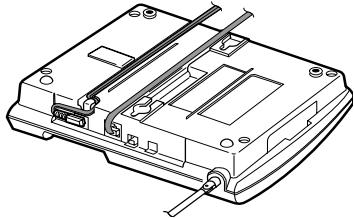

- Plug the adapter into a standard AC outlet.
- Align the keyhole slots with the mounting screws and slide the base downward to secure it.

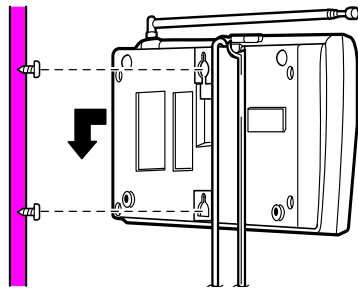

- Press and lift out the handset holder, rotate it 180°, then snap it back into place so it holds the handset.

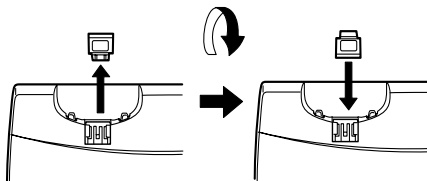

- Fully extend the base's antenna and place it in a vertical position.

INSTALLING AND CHARGING THE BATTERY

The ET-547 comes with a rechargeable nickel-cadmium battery. Before using your phone, you must install the battery and then charge it for 15-24 hours.

- Press down and slide off the handset's battery compartment cover in the direction of the arrow.

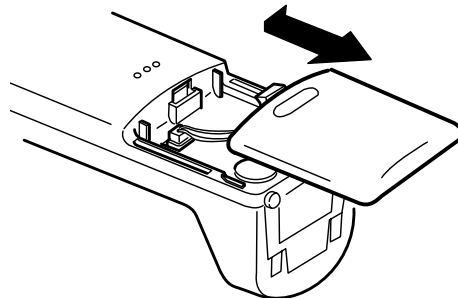

- Align the battery pack's plastic connector with its socket and plug it in with the tab up. The plug fits only one way.
- Place the battery inside the compartment.
- Replace the cover.

To charge the battery, place the handset on the base in either of two ways:

Upright

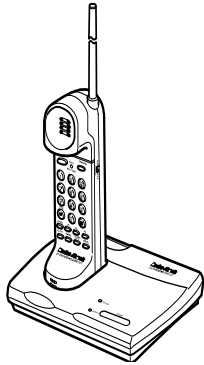

Face Down

Notes:

- If the CHARGE indicator does not light when you place the handset on the base, be sure the battery and AC adapter are correctly and securely connected. Also, check the charging contacts on the handset and the base. If the contacts are dirty or tarnished, clean them with a pencil eraser.

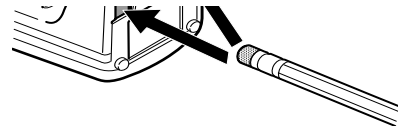
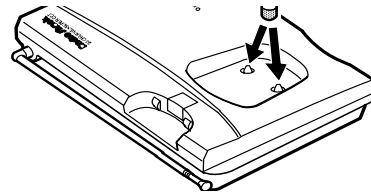

The CHARGE indicator lights.

Recharge the battery when the TALK/BATT LOW indicator flashes.

- When you first use the phone after charging or recharging the battery, the phone might not work and you might hear an error tone. If this happens, return the handset to the base for 5 seconds.
- About once a month, fully discharge the battery by keeping the handset off the base until the TALK/BATT LOW indicator lights. Otherwise, the battery loses its ability to fully recharge.
- If the TALK/BATT LOW indicator does not light, but the phone does not work, recharge the battery.

- The supplied battery should last for about a year. When the battery loses its ability to fully recharge, order a replacement battery from your local Radio Shack store (see "Replacing the Battery").

SETTING THE DIALING MODE

Set **TONE/PULSE** on the back of the base for the type of service you have. If you are not sure which type you have, do this test.

1. Set **TONE/PULSE** to **TONE**.

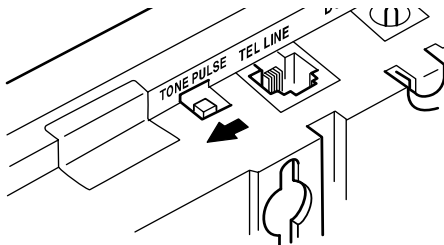

2. Lift the handset and listen for a dial tone.
3. Press any number other than **0**.

Note: If your phone system requires that you dial an access code (**9**, for example) before you dial an outside number, do not press the access code.

If the dial tone stops, you have touch-tone service. Leave **TONE/PULSE** set to **TONE**.

If the dial tone continues, you have pulse service. Set **TONE/PULSE** to **PULSE**.

SETTING THE HANDSET'S VOLUME

To adjust the handset's ringer volume, press **R.VOL.** while the phone is not in use. To adjust the volume of your telephone conversation, press **R.VOL.** while the call is in progress.

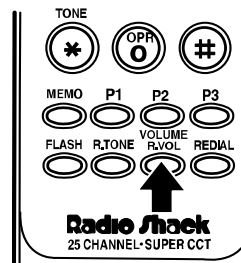

SETTING THE RINGER TONE

You can select one of the two different ringer tones when the phone is not in use. Press **R.TONE** to switch between a "chirping" and a "warbling" ringer tone.

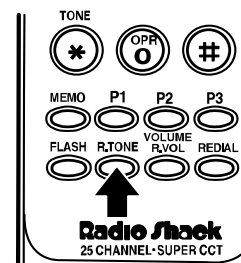

USING RINGER ON/OFF

To turn off the handset's ringer so you will not be disturbed by a telephone call, set **RINGER ON/OFF** to **OFF**. This setting also saves battery power.

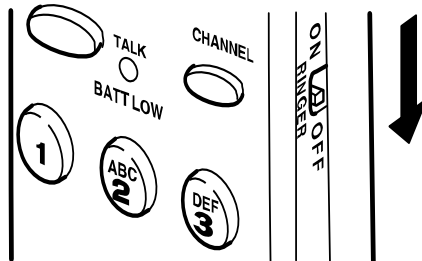

When a call comes in, the ringer does not sound, but other telephones connected to the same line still ring. You can answer the call as usual. See "Making and Receiving Calls."

Note: The page function does not work when the ringer is off.

OPERATION

MAKING AND RECEIVING CALLS

To make a call, lift the handset and press **TALK**. To answer a call, just lift the handset. Or, if the handset is away from the cradle, simply press **TALK**. The TALK/BATT LOW indicator lights.

Note: If you lift the handset to answer a call and press **TALK** after 2.5 seconds, you might disconnect the caller.

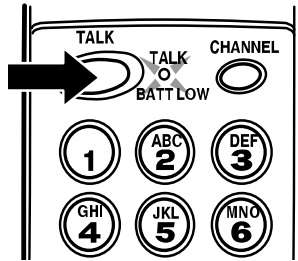

To end a call, place the handset on the cradle or press the handset's **TALK** button until its indicator turns off.

Note: When you press **TALK** to hang up the phone, you might get an error tone and the phone might not disconnect. If this happens, place the handset on the cradle or press **TALK** again while holding the handset closer to the base.

SELECTING THE CHANNEL

Your telephone can communicate between the base and the handset on

any of 25 channels. If you hear other conversations or excessive noise during a call, press **CHANNEL** on the handset to select a different channel. You hear a click, then a brief pause as your phone searches for a clear channel.

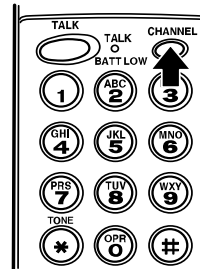

Note: If the handset is too far from the base, the channel might not change. Move closer to the base.

USING REDIAL

Redial lets you quickly dial the last number dialed. When you hear a dial tone, simply press **REDIAL**.

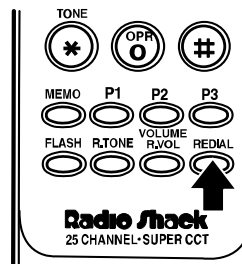

Notes:

- The redial memory holds up to 32 digits, so you can redial long-distance as well as local numbers.

- The redial memory also holds **PAUSE** entries. See “Entering a Pause” under “Memory Dialing.”
- The redial memory does not store a **FLASH** entry or any digits you press after **FLASH** (see “Using Flash”).

USING FLASH

FLASH performs the electronic equivalent of a switchhook operation for special services, such as call waiting.

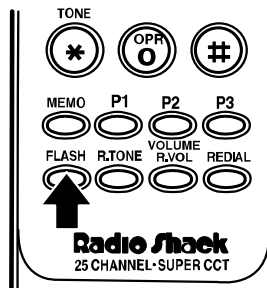

For example, if you have call waiting, press **FLASH** to answer an incoming call without disconnecting the current call. Press **FLASH** again to return to the first call.

Note: If you do not have any special phone services, pressing **FLASH** might disconnect the current call.

USING TONE SERVICES ON A PULSE LINE

Some special services, such as bank-by-phone, require tone signals. If you have pulse service, you can still use these special tone services by following these steps.

1. Be sure **TONE/PULSE** is set to **PULSE**.
2. Dial the service's main number.
3. When the service answers, press **TONE**. Then dial the additional numbers. The phone uses touch-tone dialing to dial these numbers.

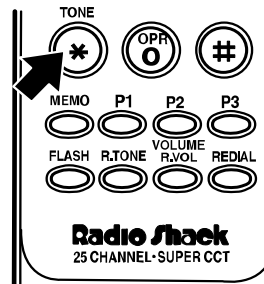

4. After you complete the call, return the handset to the cradle or press **TALK**. The phone automatically resets to the pulse mode.

PAGING

To page the person who has the handset or to locate the handset when the phone is not in use, press **PAGE** on the base. The handset beeps five times.

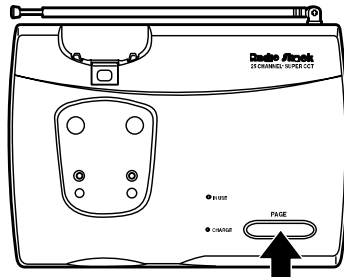

Note: The handset does not beep when the ringer is off.

MEMORY DIALING

This phone has three priority dialing memories. You can dial a number stored in any of these memories by pressing a single button. In addition, you can store up to 10 telephone numbers in speed-dial memory, then dial a stored number by pressing a one-digit memory-location number.

Note: Each number you store can be up to 16 digits long.

Storing a Number in Memory

Note: An error tone sounds and the phone exits the programming mode if you wait more than 20 seconds between each keypress.

1. Lift the handset and press **MEMO**. The TALK/BATT LOW indicator blinks.

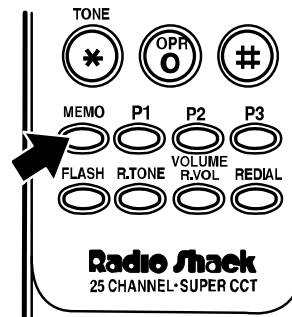

2. Enter the number and any **TONE** and **PAUSE** entries. See "Storing a Tone Entry on a Pulse Line" and "Entering a Pause."

Note: Each **TONE** or **PAUSE** entry uses one digit of memory.

3. If you want to store the number in priority dialing memory, press **MEMO**, then press a priority dialing button (**P1-P3**).

If you want to store the number in a speed-dial memory, press **MEMO**, then enter the memory location number (**0-9**).

A tone sounds to indicate that the number is stored.

4. To store more numbers, repeat Steps 1-3.

- For each stored number, write the person's or company's name next to the appropriate location number on the supplied MEMORY directory sticker. Use a pencil in case you need to change the number later. Attach the sticker to the phone.

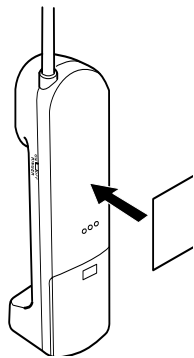

Note: To erase a number previously stored, simply store a new number in its place. Or, lift the handset and press **MEMO** twice, then press the priority dialing button or the speed-dial memory location number (**0-9**) you want to clear. A tone sounds.

Storing a Tone Entry with a Memory Number

If your phone is set for pulse dialing, you can store a tone entry so you can easily access special services that require tone signals.

- Lift the handset and press **MEMO**. The TALK/BATT LOW indicator blinks.
- Enter the phone number for the service you want to call.
- Press **TONE**.
- Enter the next number (the one that should be sent as tone signals).
- Press **MEMO**, then press the desired priority dialing button (**P1**, **P2**, or **P3**) or enter the desired speed-dial memory location (**0-9**). A tone indicates that the entire number is stored.

Entering a Pause

In some telephone systems, you must dial an access code (**9**, for example) and wait for a second dial tone before you can dial an outside number. You can store the access code with the phone number. However, you must also store a pause after the access code to allow the outside line time to connect. To do so, press **REDIAL**. Each press enters a 4-second pause. For a longer pause, press **REDIAL** additional times.

Dialing a Memory Number

Follow these steps to dial a number stored in memory.

- Lift the handset or press **TALK**.

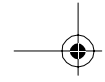

-
2. When you hear a dial tone, press the priority dialing button, or press **MEMO** and enter the speed-dial memory location number for the number you want to dial.

Chain-Dialing Service Numbers

When calling special services (such as alternate long distance or bank by phone), dial the service's main number first. Then, at the appropriate place in the call, press **MEMO** and the number for the location where the additional information is stored.

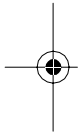

TESTING STORED EMERGENCY NUMBERS

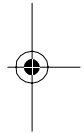

If you store an emergency service's number (police department, fire department, ambulance) and you choose to test the stored number, make the test call during the late evening or early morning hours to avoid peak demand periods. Also, remain on the line to explain the reason for your call.

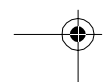
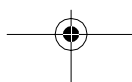

TROUBLESHOOTING

We do not expect you to have any problems with your phone, but if you do, the following guidelines might help. If you still have problems, take the phone to your local Radio Shack store for assistance.

Problem	Remedy
Low volume or unusual sounds.	Someone has picked up another phone on the same line. Hang up the other phone.
Severe noise interference.	<ul style="list-style-type: none"> • Press CHANNEL to change the channel. • Keep the handset away from computers, remote control toys, wireless microphones, alarm systems, intercoms, room monitors, fluorescent lights, and electrical appliances. • Move to another location or turn off the source of interference.
The phone cannot be operated at a useful distance from the base because the signal becomes weak or noisy (handset's range has decreased).	<ul style="list-style-type: none"> • Fully extend the base's antenna in a fully vertical position. • Return the handset to the cradle, and recharge the battery. • Be sure neither antenna is touching a metal surface.
The phone does not work or works poorly.	<ul style="list-style-type: none"> • Be sure the base's phone line cord and AC adapter are correctly and securely connected, and the battery is charged.
The handset battery does not charge.	<ul style="list-style-type: none"> • Check the charging contacts on the handset and base. If they are dirty, clean them with a pencil eraser. • Be sure the battery is connected correctly.

Problem	Remedy
Handset doesn't ring or receive a page.	<ul style="list-style-type: none">• The battery pack might be weak. Charge the battery on the base for 15-24 hours.• Set RINGER ON/OFF on the handset to ON.• Extend the base's antenna vertically.• Move closer to the base.• Place the base away from noise sources.• Return the handset to the cradle to reset it.
The handset stops working or works poorly during a call.	<ul style="list-style-type: none">• Move the handset closer to the base.• Be sure the handset's battery is charged. (If the battery power is too low, it does not have enough power to light the TALK/BATT LOW indicator.)• Fully extend the base's antenna, and place it in a fully vertical position.• Make sure that the charging contacts on the handset and base are clean.
The call is too noisy.	Change channels or hang up and redial the number.



Problem	Remedy
If the base loses power for over an hour while the handset is off of it, the code might change.	Re-establish communication between the handset and the base. Remove the handset from the base (if it is on the base). Restore power to the base, then place the handset back on the base. The CHARGE indicator lights, indicating that the code is set again.

If you still have problems, disconnect the phone. If other phones on the same line work properly, the fault is in this phone or its installation. If you cannot find the problem, take your phone to your local Radio Shack store for assistance.

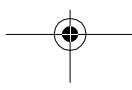
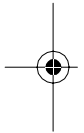

CARE AND MAINTENANCE

Your ET-547 25-Channel Cordless Telephone with 3 Priority and 10 Speed-Dial Memories is an example of superior design and craftsmanship. The following suggestions will help you care for your cordless telephone so you can enjoy it for years.



Keep the phone dry. If it gets wet, wipe it dry immediately. Liquids might contain minerals that can corrode the electronic circuits.



Use and store the phone only in normal temperature environments. Temperature extremes can shorten the life of electronic devices(, damage batteries,) and distort or melt plastic parts.



Keep the phone away from dust and dirt, which can cause premature wear of parts.



Handle the phone gently and carefully. Dropping it can damage circuit boards and cases and can cause the phone to work improperly.



Wipe the phone with a damp cloth occasionally to keep it looking new. Do not use harsh chemicals, cleaning solvents, or strong detergents to clean the phone.

Modifying or tampering with the ET-547's internal components can cause a malfunction and might invalidate your ET-547's warranty and void your FCC authorization to operate it. If your ET-547 is not performing as it should, take it to your local Radio Shack store for assistance. If the trouble is affecting the phone lines, the phone company might ask you to disconnect your phone until you have resolved the problem.

REPLACING THE BATTERY

If you follow the instructions in "Installing and Charging the Battery," the battery should last about one year. If the battery will not hold a charge for more than 2 hours after an overnight charge, replace the battery with a new 3.6 volt, 300 milliamp battery with a connector that fits the connector in the battery compartment. You can order a replacement battery through your local Radio Shack store.

Install the new battery as described below, then charge the battery (see "Installing and Charging the Battery").

1. Slide off the handset's battery compartment cover in the direction of the arrow.

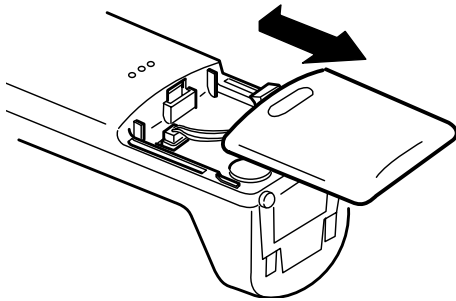

2. Gently pull on the battery connector to disconnect the plug, then remove the battery.
3. Insert a fresh battery pack and connect its plug to the pins inside the battery compartment.
4. Replace the cover.

Cautions:

- You must use a replacement battery of the same size and type.
- Do not dispose of the battery in a fire because it might explode.
- Do not open or mutilate the battery.
- Be careful not to short the battery by touching it with conducting materials, such as rings, bracelets, and keys. The battery or conductor might overheat and burn.

Notes:

- If you have trouble replacing the battery, take the phone to your local Radio Shack store for assistance.
- To avoid losing phone numbers stored in memory, try to install and begin charging the new battery within 3 minutes.
- This product contains a rechargeable nickel cadmium battery. At the end of the battery's useful life, it must be recycled or disposed of properly. Contact your local, county, or state hazardous waste management authorities for information on recycling or disposal programs in your area. Some options that might be available are: municipal curbside collection, drop-off boxes at retailers, recycling collection centers, and mail-back programs.

THE FCC WANTS YOU TO KNOW

In the unlikely event that your phone causes problems on the phone line, the phone company can temporarily discontinue your service. If this happens, the phone company attempts to notify you in advance. If advance notice is not practical, the phone company notifies you as soon as possible and advises you of your right to file a complaint with the FCC.

Also, the phone company can make changes to its lines, equipment, operations, or procedures that could affect the operation of this telephone. The telephone company notifies you of these changes in advance, so you can take the necessary steps to prevent interruption of your telephone service.

Your phone might cause TV or radio interference even when it is operating properly. To determine whether your phone is causing the interference, turn off your phone. If the interference goes away, your phone is causing the interference. Try to eliminate the interference by:

- Moving your phone away from the receiver
- Connecting your phone to an AC outlet that is on a different electrical circuit from the receiver
- Contacting your local Radio Shack store for help

If you cannot eliminate the interference, the FCC requires that you stop using your phone.

LIGHTNING

Your telephone has built-in protection circuits to reduce the risk of damage from surges in telephone line and power line current. These protection circuits meet or exceed FCC requirements. However, lightning striking the telephone or power lines can damage your telephone.

Lightning damage is not common. Nevertheless, if you live in an area that has severe electrical storms, we suggest that you unplug your phone during storms to reduce the possibility of damage.

Limited One-Year Warranty

This product is warranted by Radio Shack against manufacturing defects in material and workmanship under normal use for one (1) year from the date of purchase from Radio Shack company-owned stores and authorized Radio Shack franchisees and dealers. EXCEPT AS PROVIDED HEREIN, Radio Shack MAKES NO EXPRESS WARRANTIES AND ANY IMPLIED WARRANTIES, INCLUDING THOSE OF MERCHANTABILITY AND FITNESS FOR A PARTICULAR PURPOSE, ARE LIMITED IN DURATION TO THE DURATION OF THE WRITTEN LIMITED WARRANTIES CONTAINED HEREIN. EXCEPT AS PROVIDED HEREIN, Radio Shack SHALL HAVE NO LIABILITY OR RESPONSIBILITY TO CUSTOMER OR ANY OTHER PERSON OR ENTITY WITH RESPECT TO ANY LIABILITY, LOSS OR DAMAGE CAUSED DIRECTLY OR INDIRECTLY BY USE OR PERFORMANCE OF THE PRODUCT OR ARISING OUT OF ANY BREACH OF THIS WARRANTY, INCLUDING, BUT NOT LIMITED TO, ANY DAMAGES RESULTING FROM INCONVENIENCE, LOSS OF TIME, DATA, PROPERTY, REVENUE, OR PROFIT OR ANY INDIRECT, SPECIAL, INCIDENTAL, OR CONSEQUENTIAL DAMAGES, EVEN IF Radio Shack HAS BEEN ADVISED OF THE POSSIBILITY OF SUCH DAMAGES.

Some states do not allow the limitations on how long an implied warranty lasts or the exclusion of incidental or consequential damages, so the above limitations or exclusions may not apply to you.

In the event of a product defect during the warranty period, take the product and the Radio Shack sales receipt as proof of purchase date to any Radio Shack store. Radio Shack will, at its option, unless otherwise provided by law: (a) correct the defect by product repair without charge for parts and labor; (b) replace the product with one of the same or similar design; or (c) refund the purchase price. All replaced parts and products, and products on which a refund is made, become the property of Radio Shack. New or reconditioned parts and products may be used in the performance of warranty service. Repaired or replaced parts and products are warranted for the remainder of the original warranty period. You will be charged for repair or replacement of the product made after the expiration of the warranty period.

This warranty does not cover: (a) damage or failure caused by or attributable to acts of God, abuse, accident, misuse, improper or abnormal usage, failure to follow instructions, improper installation or maintenance, alteration, lightning or other incidence of excess voltage or current; (b) any repairs other than those provided by a Radio Shack Authorized Service Facility; (c) consumables such as fuses or batteries; (d) cosmetic damage; (e) transportation, shipping or insurance costs; or (f) costs of product removal, installation, set-up service adjustment or reinstallation.

This warranty gives you specific legal rights, and you may also have other rights which vary from state to state.

Radio Shack Customer Relations, Dept. W, 100 Throckmorton St., Suite 600, Fort Worth, TX 76102

We Service What We Sell

3/97

RADIO SHACK
A Division of Tandy Corporation
Fort Worth, Texas 76102

UDZZ01353ZB
Printed in the Philippines

11A7

Free Manuals Download Website

<http://myh66.com>

<http://usermanuals.us>

<http://www.somanuals.com>

<http://www.4manuals.cc>

<http://www.manual-lib.com>

<http://www.404manual.com>

<http://www.luxmanual.com>

<http://aubethermostatmanual.com>

Golf course search by state

<http://golfingnear.com>

Email search by domain

<http://emailbydomain.com>

Auto manuals search

<http://auto.somanuals.com>

TV manuals search

<http://tv.somanuals.com>