

Cat. No. 43-727

OWNER'S MANUAL

Please read before using this equipment.

TAD-727

900 MHz Digital Spread Spectrum Cordless Telephone with Digital Answering System

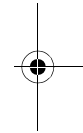
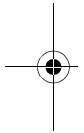

RadioShack®

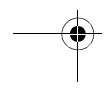
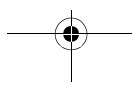

FEATURES

Your RadioShack TAD-727 900 MHz Digital Spread Spectrum Cordless Telephone uses advanced cordless telephone technology to give you superior audio quality and extended range.

The TAD (Telephone Answering Device) has about a 15 minute record capacity and stores all messages on a microchip. This gives you advanced capabilities over tape-based answering machines. For example, you can delete individual messages and save the rest. Because your TAD is fully digital, there are no tapes to bother with, no tape mechanisms to wear out, and no lost messages if power fails.

The remote operation feature lets you access your TAD from a touch-tone phone, and guides you through system operation with voice prompts.

Telephone Features

900 MHz Operation — provides longer range and less interference than many other cordless phones.

Spread Spectrum Technology — spreads the signal across several frequencies, providing additional security for your phone conversations.

10-Number Memory Dialing — lets you store up to 10 numbers in memory for quick and easy dialing.

20 Channels — automatically selects a clear channel when you make or answer a call, even while talking.

Two-Way Intercom/Paging System — lets you send a signal from the base to the handset, or from the handset to the base, so you can page someone or easily locate the handset when it is away from the base. If someone answers, you can use the TAD-727 as a two-way intercom.

Facedown or Faceup Handset Charging — you can place the handset on the base facedown or faceup.

Ample Talk and Standby Time — the supplied battery (when fully charged) provides about 4 hours of talk time or 7 days of standby time.

Security Access-Protection Code — automatically prevents other cordless phone users from using your phone line while the handset is off the base.

Redial — lets you quickly redial the last number dialed.

Flash — sends an electronic switch-hook signal for use with special phone services, such as Call Waiting.

Out of Range Signal — lets you know when you move out of the base's operating range.

© 1999 Tandy Corporation.
All Rights Reserved.

RadioShack is a registered trademark used by Tandy Corporation.

Tone/Pulse Dialing — lets you use either type of service, and you can easily switch from pulse to tone dialing for long-distance, bank-by-phone, or other special services.

Hearing-Aid Compatibility — lets you use your phone with hearing aids that have a T (telephone) switch.

Volume Control — lets you adjust the volume you hear through the handset in four steps.

Adjustable Ringer Volume — lets you choose high or low volume for the handset ringer.

Headset Jack — lets you connect an optional headset for hands-free convenience.

TAD Features

Date/Time Stamp — records the day and time of each message.

Digitally-Synthesized Voice — guides you through operation of the system.

Prerecorded Messages — gives you the option of using existing outgoing messages or recording your own.

Memo Recording — lets you leave messages for yourself or others in your home or office.

Answer Only — lets you play an announcement for callers to hear, without recording their messages.

Digital Message Counter — shows the number of messages and the operating status of the TAD.

Remote Operation — lets you use a touch-tone phone (or rotary phone and pocket tone dialer) to operate the TAD while you are away from your home or office.

Programmable PIN — you can set a two-digit personal identification number (PIN) for secure remote operation.

Remote Answer-On — lets you call the TAD from a remote location even when it is not set to answer calls.

Toll-Saver — lets you avoid unnecessary long-distance charges when you call by long distance to check your messages.

Phone Pick-Up Detection — stops recording when you pick up any phone on the same line as the TAD, and resets to answer the next call.

Call Screening — lets you listen as a caller leaves a message so you can decide whether or not to answer the call.

Two-Way Conversation Recording — lets you record the conversation when you are talking on the TAD-727.

Adjustable Ring Number — lets you set the TAD to answer after two or five rings.



Volume Control — lets you adjust the volume of incoming message playback.

This TAD has been tested and found to comply with all applicable FCC standards and is UL listed.

We recommend you record your phone's serial number here. The number is on the bottom of the case.

Serial Number _____

WARNING: To reduce the risk of fire or shock hazard, do not expose this product to rain or moisture.

	CAUTION RISK OF ELECTRIC SHOCK. DO NOT OPEN.	
CAUTION: TO REDUCE THE RISK OF ELECTRIC SHOCK, DO NOT REMOVE COVER OR BACK. NO USER-SERVICEABLE PARTS INSIDE. REFER SERVICING TO QUALIFIED PERSONNEL.		



This symbol is intended to alert you to the presence of uninsulated dangerous voltage within the product's enclosure that might be of sufficient magnitude to constitute a risk of electric shock. Do not open the product's case.



This symbol is intended to inform you that important operating and maintenance instructions are included in the literature accompanying this product.

Important:

- Cordless phones such as this one require AC power to operate. When the AC power is off, you cannot dial out or receive incoming calls using your TAD-727. To be safe, you should also have a phone that does not need AC power to operate (not a cordless phone) so you can still make and receive calls if there is an AC power failure.
- When AC power to the base is lost, **PF** appears on the display to show that a power failure occurred. The TAD-727 loses the security access-protection code connection between the base and the handset. When power is restored, put the handset on the base briefly to restore this connection so you can use the handset.

READ THIS BEFORE INSTALLATION

We have designed your phone to conform to federal regulations and you can connect it to most phone lines. However, each device that you connect to the telephone line draws power from the line. We refer to this power draw as the phone's ringer equivalence number, or REN. The REN is on the bottom of your phone.

If you use more than one phone or other device on the line, add up all the RENs. If the total is more than five, your phones might not ring. In rural areas, a total REN of three might impair ringer operation. If ringer operation is impaired, remove one of the devices from the line.

FCC STATEMENT

Your telephone complies with Part 68 of FCC Rules. You must, upon request, provide the FCC registration number and the REN to your phone company. These numbers are on the bottom of the base.

You must not connect your phone to any of the following:

- coin-operated systems
- party-line systems
- most electronic key phone systems

This equipment complies with the limits for a Class B digital device as specified in Part 15 of *FCC Rules*. These limits provide reasonable protection against radio and TV interference in a residential area. However, your equipment might cause TV or radio interference even when it is operating properly.

To eliminate interference, you can try one or more of the following corrective measures.

- Reorient or relocate the receiving antenna.
- Increase the distance between the equipment and the radio or TV.
- Use outlets on different electrical circuits for the equipment and the radio or TV.

Consult your local RadioShack store if the problem still exists.

IMPORTANT SAFETY INSTRUCTIONS

When using your telephone equipment, basic safety precautions should always be followed to reduce the risk of fire, electric shock and injury to persons, including the following:

1. Read and understand all instructions.
2. Follow all warnings and instructions marked on the product.
3. Unplug this product from the wall outlet before cleaning. Do not use liquid cleaners or aerosol cleaners. Use a damp cloth for cleaning.
4. Do not use this product near water, for example, near a bath tub, wash bowl, kitchen sink, or laundry tub, in a wet basement, or near a swimming pool.
5. Do not place this product on an unstable cart, stand, or table. The product may fall, causing serious damage to the product.
6. Slots and openings in the cabinet and the back or bottom are provided for ventilation, to protect it from overheating. These openings must not be blocked or covered. The openings should never be blocked by placing the product on the bed, sofa, rug, or other similar surface. This product should not be placed in a built-in installation unless proper ventilation is provided.
7. This product should be operated only from the type of power source indicated on the marking label. If you are not sure of the type of power supply to your home, consult your dealer or local power company.
8. Do not allow anything to rest on the power cord. Do not locate this product where the cord will be abused by persons walking on it.
9. Do not overload wall outlets and extension cords as this can result in the risk of fire or electric shock.
10. Never push objects of any kind into this product through cabinet slots as they may touch dangerous voltage points or short out parts that could result in a risk of fire or electric shock. Never spill liquid of any kind on the product.
11. To reduce the risk of electric shock, do not disassemble this product, but take it to a qualified serviceman when some service or repair work is required. Opening or removing covers may expose you to dangerous voltages or other risks. Incorrect reassembly can cause electric shock when the appliance is subsequently used.
12. Unplug this product from the wall outlet and refer servicing to qualified service personnel under the following conditions:
 - When the power supply cord or plug is damaged or frayed.
 - If liquid has been spilled into the product.
 - If the product has been exposed to rain or water.

- If the product does not operate normally by following the operating instructions. Adjust only those controls, that are covered by the operating instructions because improper adjustment of other controls may result in damage and will often require extensive work by a qualified technician to restore the product to normal operation.
- If the product has been dropped or the cabinet has been damaged.
- If the product exhibits a distinct change in performance.

13. Avoid using a telephone (other than a cordless type) during an electrical storm. There may be remote risk of electric shock from lightning.
14. Do not use the telephone to report a gas leak in the vicinity of the leak.

Installation:

1. Never install telephone wiring during a lightning storm.
2. Never install telephone jacks in wet locations unless the jack is specifically designed for wet locations.
3. Never touch uninsulated telephone wires or terminals unless the telephone line has been disconnected at the network interface.
4. Use caution when installing or modifying telephone lines.

CAUTION: TO REDUCE THE RISK OF FIRE OR INJURY TO PERSONS, READ AND FOLLOW THESE INSTRUCTIONS.

1. Use only the required size and type battery.
2. Do not dispose of the battery in a fire.

The cell may explode. Check with local codes for possible special disposal instructions.

3. Do not open or mutilate the battery. Released electrolyte is corrosive and may cause damage to the eyes or skin. It may be toxic if swallowed.
4. Exercise care in handling batteries in order not to short the battery with conducting materials such as rings, bracelets, and keys. The battery or conductor may overheat and cause burns.
5. Charge the battery provided with or identified for use with this product only in accordance with the instructions and limitations specified in this manual.
6. Observe proper polarity orientations between the battery and battery charger.
7. Use only the required size and type AC adapter.

SAVE THESE INSTRUCTIONS

CONTENTS

Installation	10
Mounting the Phone	10
On a Desk	10
On a Wall Plate or Wall	11
Connecting and Charging the Battery Pack	12
Setting the Dialing Mode	14
Setting the Ringers	14
Turning the Ringers On or Off	14
Setting the Handset's Ringer Volume	15
Telephone Operation	16
Making and Receiving Calls	16
Out of Range Signal	16
Adjusting the Handset Volume	16
Using Redial	16
Using Flash	17
Using Tone Services On a Pulse Line	17
Using the Intercom	17
Paging from the Base to the Handset	18
Paging from the Handset to the Base	18
Memory Dialing	18
Storing a Number	18
Entering a Pause	19
Dialing a Memory Number	19
Chain-Dialing Service Numbers	19
Testing Stored Emergency Numbers	20
Using a Headset	20
TAD Operation	21
Using the Handset to Control the TAD	21
Setting the Number of Rings	21
Setting the Day and Time	22
Selecting an Outgoing Message	23
Recording an Outgoing Message	23
Setting the TAD to Answer Calls	24
Screening Calls	25
Recording a Memo	25
Recording Telephone Conversations	25
Using the Handset	26
Using the Base	26

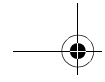

Playing Messages 26

Deleting Messages 27

Adjusting the TAD's Volume 27

Remote Operation 28

 Using the Toll-Saver 28

 Setting the Remote Operation Pin 28

 Accessing the TAD Remotely 28

Troubleshooting 30

Care and Maintenance 32

 Replacing the Battery Pack 33

 The FCC Wants You To Know 34

 Lightning 34

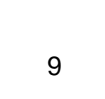
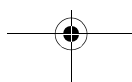
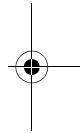
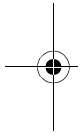

INSTALLATION

MOUNTING THE PHONE

You can place the TAD-727's base on a desk or table, mount it on a standard wall plate, or mount it directly on a wall. Choose a location that is:

- near an AC outlet
- near a telephone line jack
- out of the way of normal activities
- away from electrical machinery, electrical appliances, metal walls or filing cabinets, wireless intercoms, alarms, and room monitors
- away from other cordless phones

The base's location affects the handset's range. If you have a choice of several locations, try each to see which provides the best performance.



Caution: You must use a Class 2 power source that supplies 9 volts DC and delivers at least 500 mA. Its center tip must be set to negative and its plug must fit the TAD-727's **DC 9V AC ADAPTER** jack. The supplied RadioShack adapter was specifically designed for your TAD-727. Use only the supplied adapter. Using an adapter that does not meet these specifications could damage the TAD-727 or the adapter.

Notes:

- Your telephone connects directly to a modular phone line jack. If your phone line jack is not a modular jack, you can update the wiring yourself, using jacks and adapters available from your local RadioShack store. Or, you can let the telephone company update the wiring for you.
- The USOC number of the jack to be installed is RJ11C, or RJ11W for a wall plate jack.

On a Desk

Follow these steps when you place the base on a desk or table.

1. Plug one end of the supplied long modular cord into the **TEL LINE** jack on the back of the base.

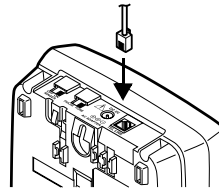

2. Plug the modular cord's other end into a modular phone line jack.
3. Insert the supplied AC adapter's barrel plug into the **DC 9V AC ADAPTER** jack on the back of the base.

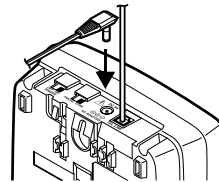

4. Route the adapter's cord through the strain relief slot on the base.

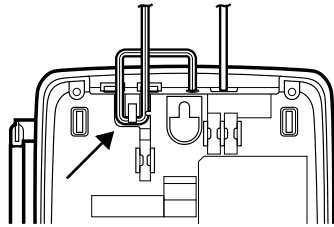

5. Plug the adapter into a standard AC outlet. **PF** (power failure) flashes on the digital display.
6. Lift the base's antenna to a vertical position.

4. Insert the mounting bracket's tabs into the base's tab slots then press down on the bracket's clips to insert them into the clip slots.

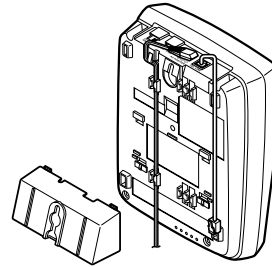

5. Plug the modular cord's other end into the wall plate jack, then align the bracket's keyhole slots with the wall plate studs and slide the base downward to secure it.

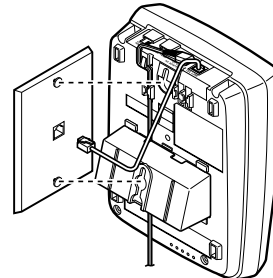

On a Wall Plate or Wall

1. Plug one end of the supplied short modular cord into the **TEL LINE** jack on the back of the base as in "On a Desk," Step 1, on Page 10.
2. Insert the supplied AC adapter's barrel plug into the **DC 9V AC ADAPTER** jack as in "On a Desk," Step 3 on Page 10.
3. Route the adapter's cord through the strain relief slot on the bottom of the base.

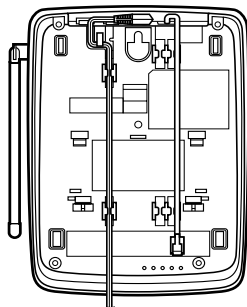

6. Plug the adapter into a standard AC outlet. **PF** flashes on the display.
7. Lift the base's antenna to a vertical position.

Note: To mount the TAD directly on a wall, you need two screws (not supplied) with heads that fit into the keyhole slots on the bottom of the base.

Follow the above steps, then apply these additional instructions for placement on a wall.

1. Drill two holes $3 \frac{15}{16}$ inches (100 mm) apart. Then thread a screw into each hole, letting the heads extend about $\frac{1}{16}$ inch (8 mm) from the wall.

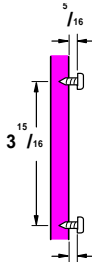

2. Plug one end of the supplied long modular cord into the **TEL LINE** jack on the back of the base.
3. Align the bracket's keyhole slots with the mounting screws and slide the base downward to secure it.

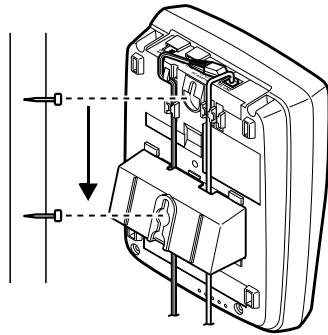

CONNECTING AND CHARGING THE BATTERY PACK

The TAD-727 comes with a rechargeable nickel-cadmium battery pack in the handset but not connected. Before using your phone, you must connect the battery pack, then charge it for about 12 hours.

1. Press down and slide off the battery pack compartment cover.

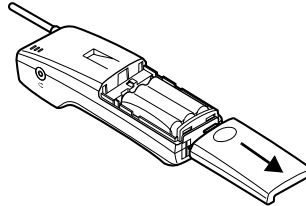

2. Lift the battery pack out of the compartment.
3. Plug the battery pack's connector into the socket in the compartment (the connector fits only one way), route the battery pack's leads through the strain relief slot and place the battery pack into the compartment.

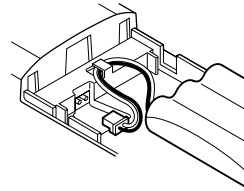

Note: When you connect the battery, the TALK/LOW/BATT indicator flashes (when in the phone is not in use) indicating that the security access protection code on the handset was lost.

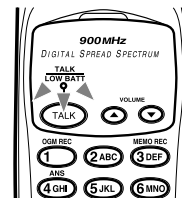

To reset the code, return the handset to the base for about 2 seconds.

4. Replace the cover.

To charge the battery pack, place the handset either faceup or facedown on the base. The IN USE/CHARGE indicator on the base lights.

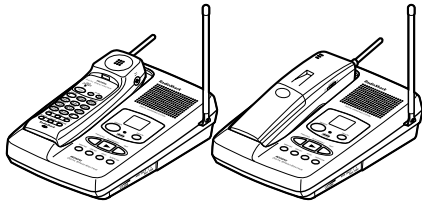

Recharge the battery pack when the TALK/LOW BATT indicator on the handset flashes.

Important: Be sure the battery pack is properly connected before you try to charge it. The IN USE/CHARGE indicator lights when the handset is on the base, even if the battery pack is not connected.

Notes:

- When you first use the phone after charging or recharging the battery pack, the phone might not work and you might hear three beeps when you press **TALK**. If this happens, return the handset to the base for about 2 seconds. This resets the security access-protection code.
- If the battery pack is completely discharged, the handset might lose its security access-protection code. To reset the code, return the handset to the base for about 2 seconds.
- Using a pencil eraser, clean the charging contacts on the handset and the base about once a month.

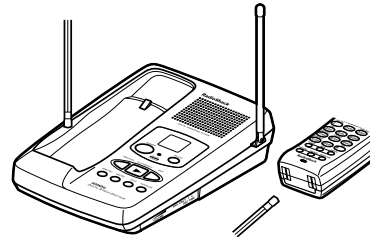

- If the battery pack becomes weak during a call, the handset beeps every 16 seconds and the TALK/LOW BATT indicator flashes. When this happens, you cannot make another call on the phone until you recharge the battery pack.
- About once a month, fully discharge the battery pack by keeping the handset off the base until the TALK/LOW BATT indicator flashes. Otherwise, the battery pack loses its ability to recharge.
- If the TALK/LOW BATT indicator does not light and the phone does not work, recharge the battery pack. (The battery charge might be too low to light the indicator.)
- If you are not going to use your phone for an extended period of time, disconnect the battery pack. This increases the battery pack's usable life.
- The supplied battery pack should last for about a year. When it loses its ability to fully recharge, order a replacement battery pack from your local RadioShack store (see "Replacing the Battery Pack" on Page 33).

SETTING THE DIALING MODE

Set **PULSE/TONE** on the back of the base for the type of service you have. If you are not sure which type you have, once the battery pack is fully charged, do this test.

1. Be sure **PULSE/TONE** is set to **TONE**.

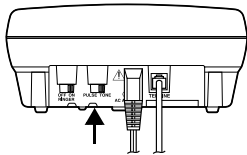

2. Lift the handset, press **TALK**, and listen for a dial tone.

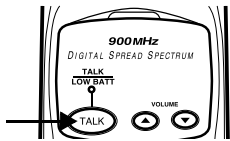

3. Press any number other than 0.

Note: If your phone system requires that you dial an access code (9, for example) before you dial an outside number, do not dial the access code either.

If the dial tone stops, you have touch-tone service. Leave **PULSE/TONE** set to **TONE**.

If the dial tone continues, you have pulse service. Set **PULSE/TONE** to **PULSE**.

SETTING THE RINGERS

Turning the Ringers On or Off

You can turn the ringers on the base or handset on or off.

Use **RINGER OFF/ON** on the base to turn the ringer on the base on or off.

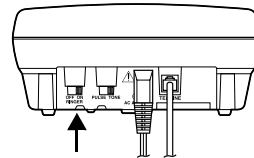

Use **RINGER OFF/ON** on the handset's left side to turn the handset's ringer on or off.

Notes:

- The handset does not ring when it is on the base, even when **RINGER OFF/ON** is set to **ON**.
- If you turn off the ringer, you can still make calls (and answer calls if you hear another phone on the same line ringing).

Setting the Handset's Ringer Volume

Be sure **RINGER OFF/ON** located on the side of the handset is set to **ON**.

At any time except during a call, press **VOLUME ▲** or **▼** to set the ringer volume either high or low. Each time you press **VOLUME ▲** or **▼**, the handset rings at the selected volume.

Note: You cannot set the handset's ringer volume if you press **TALK** when you lift the handset.

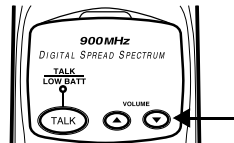

TELEPHONE OPERATION

MAKING AND RECEIVING CALLS

To make a call, lift the handset and press **TALK**. When you hear the dial tone, dial the number.

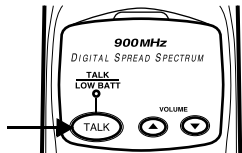

To answer a call, just lift the handset when the handset is on the base or press any key on the handset when it is off the base.

Both the IN USE/CHARGE indicator on the base and the TALK/LOW BATT indicator on the handset flash when you receive a call.

To end a call, place the handset on the base or press **TALK** so the TALK/LOW BATT indicator on the handset turns off.

OUT OF RANGE SIGNAL

If you move the handset out of the base's range while a call is in progress, three beeps sound through the earpiece every four seconds. Return to within the base's range within 40 seconds, then the out of range signal stops, and you can resume your phone conversation.

If you keep the handset out of the base's range for 40 seconds or more, the call is disconnected.

ADJUSTING THE HANDSET VOLUME

The handset's **VOLUME** control lets you set the volume you hear through the handset to one of four levels.

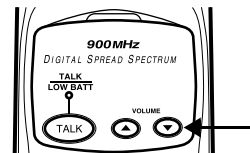

To turn the volume up or down during a call, repeatedly press **VOLUME ▲** or **▼** on the handset. The TAD-727 beeps once each time you press **VOLUME ▲** or **▼**. When you reach the highest or lowest volume level, the TAD-727 beeps three times.

USING REDIAL

You can quickly dial the last number dialed. Lift the handset and press **TALK**, then press **REDIAL**.

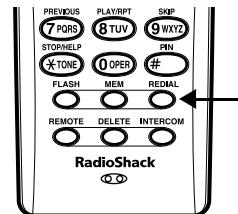

Notes:

- The redial memory holds up to 32 digits, so you can redial long distance as well as local numbers.
- The redial memory also holds pause entries. See "Entering a Pause" on Page 19.

USING FLASH

Flash performs the electronic equivalent of a switchhook operation for special services, such as Call Waiting.

For example, if you have Call Waiting, press **FLASH** to answer an incoming call without disconnecting the current call. Press **FLASH** again to return to the first call.

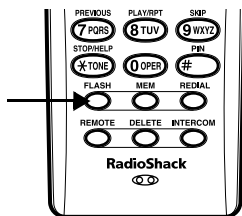

Note: If you do not have any special phone services, pressing **FLASH** might disconnect the current call.

USING TONE SERVICES ON A PULSE LINE

Some special services, such as bank-by-phone, require tone signals. If you have pulse dialing, you can still use these special tone services by following these steps.

1. Be sure **PULSE/TONE** is set to **PULSE**.
2. Dial the service's main number.

3. When the service answers, press *** TONE**. Any additional numbers you dial are sent as tone signals.

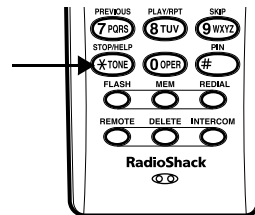

4. After you complete the call, return the handset to the base or press **TALK**. The phone automatically resets to the pulse mode.

USING THE INTERCOM

You can use the TAD-727 as a two-way pager and intercom between the base and handset. This is useful if the handset is away from the base and you want to locate it, or if you want to have a conversation between someone with the handset and someone at the base.

Note: If a call comes in during an intercom conversation, the person using the handset can answer the call by pressing **TALK**, but the intercom call is disconnected.

Paging from the Base to the Handset

To send a page from the base to the handset, press **INTERCOM** on the base. The handset beeps twice per second for 15 seconds. The base's IN USE/CHARGE indicator flashes.

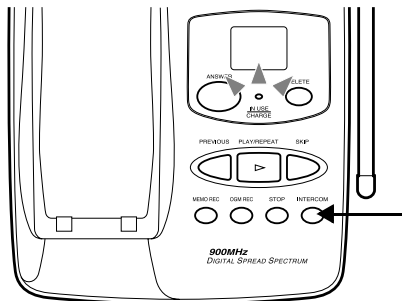

To answer a page at the handset, press **INTERCOM**. Begin your conversation after the TALK/LOW BATT indicator on the handset lights steadily.

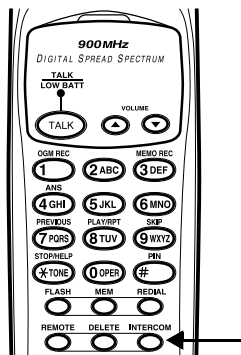

To end an intercom call, press **INTERCOM** on the base or handset. All indicators turn off.

Paging from the Handset to the Base

To send a page from the handset to the base, press **INTERCOM** on the handset. The base sounds two short beeps, and automatically answers the handset's page (whether or not anyone is there). Begin your conversation.

To end an intercom call, press **INTERCOM** on the base or handset. All indicators turn off.

MEMORY DIALING

You can store up to 10 numbers of up to 16 digits each in the TAD-727's memory, then dial them with the press of a few buttons.

Storing a Number

Notes:

- An error tone sounds and the phone exits the storing process if you wait more than 30 seconds between each key press.
- If you receive a call during memory entry, the phone exits the storing process.

1. Press **MEM** on the handset. The TALK/LOW BATT indicator flashes.

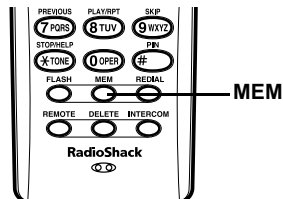

2. Enter the number you want to store.

Notes:

- If you have pulse service and want to send tone signals, press * at the appropriate place in the sequence of numbers.
 - Each * or pause entry (see "Entering a Pause") counts as one digit in memory.
 - Each number you store can be up to 16 digits long.
3. Press **MEM** then press the memory location number (0-9) where you want to store the number. A beep sounds to indicate that the number is stored.
 4. For each stored number, write the person's or company's name next to the appropriate location number on the supplied memory directory sticker. Peel the backing from the sticker and attach it to the phone.

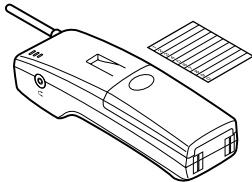

To change a number in memory, store a new one in its place. To clear a number

from memory, press **MEM** twice, then press the memory location number (0-9) you want to clear.

Entering a Pause

In some telephone systems, you must dial an access code (9, for example) and wait for a second dial tone before you can dial an outside number. You can store the access code with the phone number. However, you should also store a pause after the access code to allow the outside line time to connect. To enter a 2-second pause, press **REDIAL** at each point where a pause is needed. For a longer pause, press **REDIAL** additional times.

Dialing a Memory Number

To dial a stored number, lift the handset from the base and press **TALK**. When you hear the dial tone, press **MEM** and enter the memory location number (0-9) for the number you want to dial.

Chain-Dialing Service Numbers

For quick recall of numbers for special services (such as bank by phone), store each group of numbers in its own memory location.

Dial the service's main number first. Then, at the appropriate place in the call, press **MEM** and enter the number for the location where the additional information is stored.

Testing Stored Emergency Numbers

If you store an emergency service's number (police department, fire department, ambulance) and you choose to test the stored number, make the test call during the late evening or early morning hours to avoid peak demand periods. Also, remain on the line to explain the reason for your call.

- If you place the handset on the base to recharge it while the headset is connected, be sure the handset seats properly.

With a headset connected, you can make or answer calls as usual using the keys on the handset.

You can use a headset holder (available from your local RadioShack store) to hang the handset on your belt for greater convenience.

USING A HEADSET

You can make or answer calls with hands-free convenience using an optional headset that has a $\frac{3}{32}$ -inch (2.5 mm) plug. Contact your local RadioShack store for a suitable headset.

Insert the headset plug into the  jack on the side of the handset.

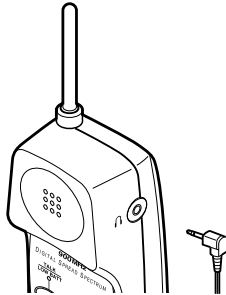

Notes:

- Connecting a headset disconnects the handset's earpiece and microphone.
- **VOLUME** ▲ or ▼ on the handset also controls the headset's volume.

TAD OPERATION

You can use the base or the handset to control the TAD. With the handset, you set the remote operation personal identification number (PIN), select the outgoing message, record outgoing messages, memos, or telephone conversation, turn the TAD on and off, play messages, and delete a current message. At the base, you can set the day and time, set the number of rings before the TAD answers an incoming call, select the outgoing message, set incoming message recording time, record outgoing messages, memos, or telephone conversation, turn the TAD on and off, play and delete messages, and adjust the TAD's volume.

Note: While you are using the base to control the TAD, you can still answer incoming calls with the handset or another phone on the same telephone line.

USING THE HANDSET TO CONTROL THE TAD

To control the TAD with the handset, press **REMOTE** in standby mode. The TALK/LOW BATT indicator on the handset lights, and two bars flash on the digital display on the base.

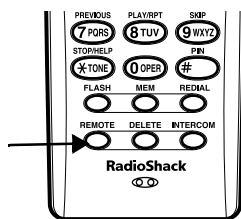

The TAD announces the number of messages you have (if any). If the TAD has no messages, the TAD announces "You have no messages." Then the TAD is ready to accept a command.

Note: If you need help during operation, press **STOP/HELP/ * TONE**. The TAD plays a series of voice prompts to guide you through the handset operation.

When you finish operating the TAD, wait until the TALK/LOW BATT indicator turns off or press **REMOTE** again.

SETTING THE NUMBER OF RINGS

Follow these steps to set how long the TAD waits before it answers a call (2 rings, 5 rings, or toll-saver).

Note: If you plan to check your messages by long distance, set the number of rings to toll-saver (see "Using the Toll-Saver" on Page 28).

1. Hold down **ANSWER** on the base until the TAD announces the number of rings ("two", "five" or "toll-saver") and the display flashes the current setting **2**, **5**, or **SA**.

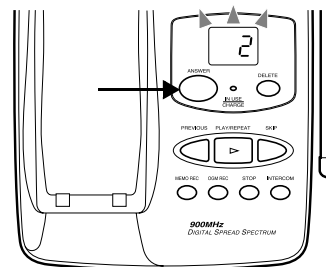

2. Repeatedly press **PREVIOUS** or **SKIP** on the base until the TAD announces and displays the number of rings you desire – “two” so the TAD answers on the second ring, “five” for fifth ring, or “toll saver” when you want to use the toll-saver function.

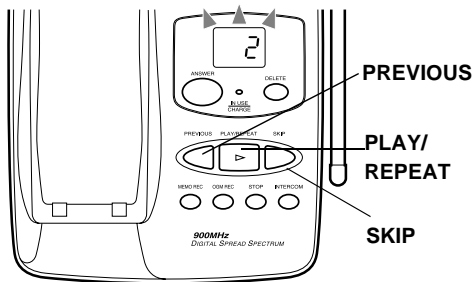

3. Press **ANSWER** or **PLAY/REPEAT/▶**. The TAD sounds a long beep and announces the selected number of rings.

Note: Press each button within 30 seconds. If you take longer, the setting procedure is canceled automatically.

SETTING THE DAY AND TIME

You must set the day and time so the TAD can record the correct day and time of each message.

1. Hold down **STOP** on the base until a long beep sounds. The TAD announces the day of the week. **CL** flashes on the digital display.

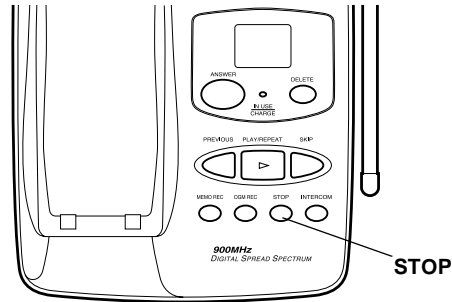

2. Press **PREVIOUS** or **SKIP** until the TAD announces the correct day of the week.
3. Press **PLAY/REPEAT/▶**. The TAD announces the hour and “AM” or “PM.”
4. Press **PREVIOUS** or **SKIP** until the TAD announces the correct hour, including AM or PM.
5. Press **PLAY/REPEAT/▶**. The TAD announces the minute.
6. Press **PREVIOUS** or **SKIP** until the TAD announces the correct minute.

Holding down **PREVIOUS** or **SKIP** advances the minute rapidly and announces minutes in 10 minute increments. Release **PREVIOUS** or **SKIP** and the TAD announces the minute setting. If you advance too far when holding down **PREVIOUS** or **SKIP**, press the opposite button.

7. Press **PLAY/REPEAT/▶**. The TAD announces the minute and sounds a beep. Then the seconds start to count from 0.

Notes:

- If you make an error, the TAD beeps rapidly 3 times. Repeat Steps 1–7.
- Press each button within 30 seconds of the previous button press. If you take longer, the setting procedure is canceled automatically.
- When you have an incoming call or paging from the base while setting the day and time, the setting procedure is canceled.
- If there is a power failure, **PF** flashes on the digital display when power returns. Reset the day and time.

SELECTING AN OUTGOING MESSAGE

The TAD has two prerecorded messages. One asks the caller to leave a message (“Hello, no one is available to take your call. Please leave your message after the tone.”), the other is an announcement and does not let the caller leave a message (“Hello, no one is available to take your call.”). You can also record your own message (see “Recording an Outgoing Message”).

Use the **REC TIME** switch to select which message you want. When you set it to either 1 or 4 (minutes), the normal message is selected and the TAD records each incoming message for 1 or 4 minutes. When you set it to **ANS. ONLY**, the announce-only message is selected.

RECORDING AN OUTGOING MESSAGE

You can record your own message up to 1 minute long for the caller to hear when the TAD answers a call. You can use either the base or the handset to record the message.

Hints:

- Do not tell callers that you are not home. Instead, say that you cannot come to the phone right now.
- When you record an announcement-only message, be sure that the caller understands he or she cannot leave a message.

Follow these steps to record your outgoing message.

1. Hold down **OGM REC** on the base for about 2 seconds until a beep sounds. The digital display begins counting up by second (00 - 01 - 02 - - -). Then speak your outgoing message into the base.

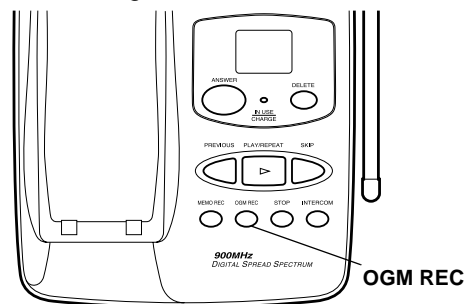

2. When finished, press **OGM REC** again (or press **STOP**). The TAD beeps, plays back the message, then beeps again. The display shows **A** (or **AO** if you set it to announcement-only), and the number of messages (if the TAD has new messages) alternately. The TAD is now ready to answer calls.

You can also record your message using the handset. Press **REMOTE**, and after hearing the number of messages, follow these steps.

1. Press **OGM REC/1** on the handset twice within 2 seconds. A beep sounds. Then speak your outgoing message into the handset.

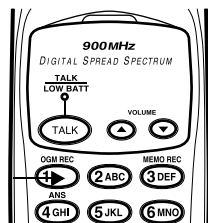

2. When finished, press **OGM REC/1** again (or press **STOP/HELP/ * TONE**). The handset beeps, then plays back the message.

SETTING THE TAD TO ANSWER CALLS

To set the TAD to answer calls, press **ANSWER** on the base. The TAD plays the current outgoing message, then displays **A** (or **AO** if set to announcement-only). Press **ANSWER** again to select be-

tween the prerecorded or your own message.

To turn off the TAD, press **STOP** except while any message is playing back. The TAD announces "Answer off."

To turn the TAD on and off from the handset, press **REMOTE** so the TALK/LOW BATT indicator lights. You hear the TAD announce the number of currently recorded messages. If there are no messages, the TAD announces "No messages". Repeatedly press **ANS/4** when you hear the announcement to turn the TAD on, select between the prerecorded or your own message, or turn off the TAD.

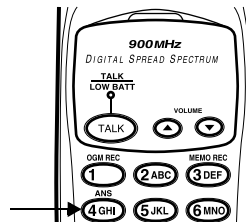

Note: If the incoming message memory is full (59 messages including your own outgoing messages or less than 15 seconds left), the TAD announces "No remaining time", **F** flashes on the digital display. The TAD does not answer calls.

SCREENING CALLS

You can let the TAD answer calls for you while you listen to the caller's message through the base's speaker. You can adjust the volume of caller's voice using the **VOLUME** on the base. If you decide to answer the call, lift the handset and press **TALK**, or pick up any phone on the same phone line as the TAD. The TAD stops recording.

You can also use the handset to screen calls. When the TAD starts to answer a call, press **REMOTE** on the handset and listen to the caller's message. If you decide to answer the call, press **TALK**. If you decide to hang up and let the TAD continue recording the caller's message, press **REMOTE** again.

RECORDING A MEMO

You can leave a message (memo) up to 4 minutes long, for yourself or others. The memo is counted as one message and played back with other messages (see "Playing Messages" on Page 26).

1. Hold down **MEMO REC** on the base for about 2 seconds until a beep sounds.

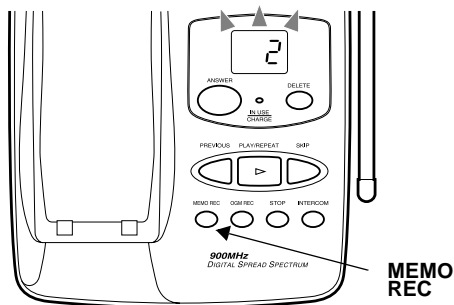

2. Speak into the base.
3. When you finish, press **MEMO REC** again (or press **STOP**). The TAD beeps again and the message number increases by one.

To record from the handset, press **REMOTE**. After hearing the number of messages, follow these steps.

1. Press **MEMO REC/3**.

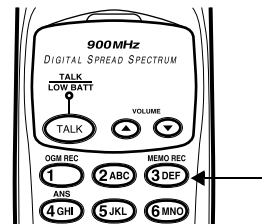

2. When the TAD beeps, speak into the handset.
3. When you finish, press **MEMO REC/3** again (or press **STOP/HELP/ * TONE**). The TAD beeps again and plays back the recorded message.

RECORDING TELEPHONE CONVERSATIONS

The TAD-727 lets you record both sides of a telephone the conversation. The TAD-727 stores a recorded conversation as a message. The recording can be as long as the available recording time (about 15 minutes maximum).

Note: It is illegal in some areas to record a conversation without the consent of all parties to the conversation, including the phone company. Check the laws in your area before you use the two-way recording feature.

Using the Handset

Press **REMOTE** then **MEMO REC/3**. The TAD begins recording.

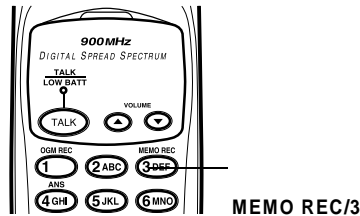

To send the contents of the recording back to the caller through the telephone line, press **PLAY/RPT/8** while recording.

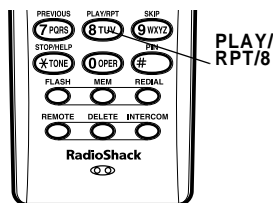

To stop recording, press **MEMO REC/3**.

Using the Base

Hold down **MEMO REC** on the base for about 2 seconds. The recording starts.

To send the recorded contents you just made back to the caller through the telephone line, press **PLAY/REPEAT/ ►**.

To stop recording, press **MEMO REC**.

Notes:

- To stop the playback, press **REMOTE** on the handset, or press **STOP** on the base.
- To repeat the playback, press **PLAY/RPT/8** on the handset, or press **PLAY/REPEAT/ ►** on the base.

PLAYING MESSAGES

After a new message is recorded, **A** and the number of all recorded messages flash on the display alternately.

Notes:

- The maximum number of messages that the display can show is 59. The number does not change after that even if you have received more messages.
- When the TAD receives 59 messages (including your own outgoing message), or the memory has less than 15 seconds left, **F** (full) and the number of messages flash on the display.

Press **PLAY/REPEAT/ ►** on the base, or press **REMOTE** then **PLAY/RPT/8** on the handset. The TAD announces the number of messages and whether the messages are new or old (already listened to). Then each new message plays, followed by the day and time it was recorded.

When you have both old and new messages, the TAD first plays back only the new messages.

While playing back the messages, **PL** (playback) and the number of the current messages flash on the display. For example, if you have a total of four messages (one old, three new), pressing **PLAY/REPEAT/ ►** displays **2** (the first new message).

If there are no messages when you press **PLAY/REPEAT/ ►** or **PLAY/RPT/8**, the TAD announces "You have no messages."

Notes:

- If the TAD detects a busy signal for more than 5 seconds or silence for more than 8 seconds while recording a message, it stops recording and releases the call.
- When you play back messages using handset, the message number does not appear on the display.

To skip to the next message, press **SKIP** (or **SKIP/9** on the handset).

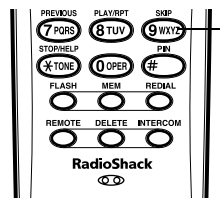

To skip to the previous message, press **PREVIOUS** (or **PREVIOUS/7** on the handset).

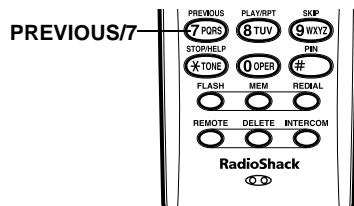

To play the current message again, press **PLAY/REPEAT/ ►** (or **PLAY/RPT/8** on the handset).

To stop playback before the end of the messages, press **STOP** (or **STOP/HELP/ ✕ TONE** on the handset).

DELETING MESSAGES

To delete the current message, press **DELETE**, on either the handset or base, until a beep sounds at any time during playback.

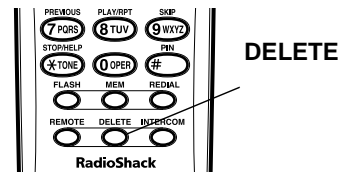

To delete all messages at once, while messages are not playing, hold down **DELETE** on the base until the TAD beeps 3 times. After all messages have been deleted, the TAD announces "You have no messages."

ADJUSTING THE TAD'S VOLUME

You can adjust the playback volume with the **VOLUME** control, located on the right side of the base, during message playback or call screening.

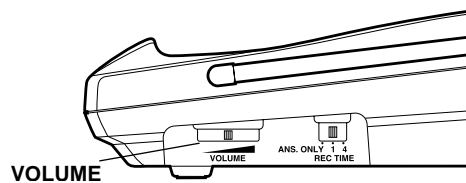

REMOTE OPERATION

USING THE TOLL-SAVER

When you call the TAD-727 and the number of rings to answer calls is set to "toll-saver", it answers after about two rings if you have new messages (ones you have not listened to). If there are no new messages, the TAD waits for about five rings before it answers. This gives you time to hang up before the TAD answers so you can avoid long-distance charges.

SETTING THE REMOTE OPERATION PIN

The remote operation PIN (personal identification number) permits remote access to the TAD. The PIN can be any number from 00 to 99. The default setting is 99, but you can change it by following these steps.

1. Press **REMOTE** on the handset so the TALK/LOW BATT indicator lights. The TAD announces the number of messages you have (if any).
2. Press **PIN/#** on the handset. Then the TAD announces the current PIN through the handset.

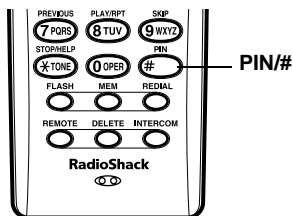

3. Enter your two-digit PIN.

4. Press **PIN/#** on the keypad again. Then the TAD announces your new PIN stored through the handset's speaker.
5. Press **REMOTE** so the TALK/LOW BATT indicator turns off.

Accessing the TAD Remotely

While you are away from your home, you can use a touch-tone phone, or a pulse (rotary) phone with a pocket tone dialer, to enter your PIN and do any of the following:

- set the TAD to answer calls
- select an outgoing message
- listen to your messages
- record a new announcement
- record a memo
- delete messages
- turn the TAD off

Note: You cannot access the TAD from another telephone on the same line as your TAD-727.

1. Dial your phone number and wait for the TAD to answer.

The TAD automatically turns itself on to answer your call.

2. When the outgoing message ends, press * then enter your 2-digit PIN within 2 seconds.

The TAD announces “You have xx new message(s)” (where xx is the numbers of messages) or “You have no messages”, then the TAD plays back the recorded messages continuously. When you have both old and new messages, the TAD first plays back only new messages. Press **8** to hear old messages.

3. During playback, you can press the number key for the command you want.

Press:	To:
7	Skip to the previous message.
8	Repeat the current message.
9	Skip to the next message.
*	Stop message playback.
0 twice within 2 seconds	Delete the current message.

After all messages have been played back (or you finished playing back by pressing *****), you can continue to access other features.

To record a new outgoing message:

1. Press **1** twice within 2 seconds. The TAD beeps.
2. Record your new outgoing message.
3. Press **1** or *****. A beep sounds and the recorded outgoing message plays back.

To record a memo:

1. Press **3**. The TAD beeps.
2. Record your message.
3. Press **3**. The TAD beeps and the recorded memo plays.

To listen to help guidance:

Press ***** and the TAD plays a series of voice prompts to guide you through remote operation.

To set the TAD to answer/not answer calls:

Press **4**. The TAD announces the current outgoing message or “Answer off.” Repeatedly press **4** during outgoing message playback to turn the TAD on and select between the prerecorded or your own message, or turn the TAD off. You hear “Answer off”.

TROUBLESHOOTING

We do not expect you to have any problems with your phone, but if you do, the following suggestions might help.

Problem	Suggestion
The phone does not work or works poorly.	Check all phone line connections.
	Make sure the AC adapter and battery pack are properly connected.
	Make sure the battery pack is properly charged.
	Return the handset to the base for about 2 seconds to reset its security access-protection code.
The TALK/LOW BATT indicator flashes slowly when the handset is faceup on the base.	Be sure the handset's battery pack is connected.
The handset stops working or works poorly during a call.	Move the handset closer to the base.
	Lift the base's antenna to a fully vertical position.
	Be sure the handset's battery pack is charged. (If the battery pack power is too low, it does not have enough power to light the TALK/LOW/BATT indicator.)
Handset does not ring or receive a page.	Lift the base's antenna to a fully vertical position.
	Move the handset closer to the base.
	Move the base away from other electrical devices.
	Recharge the battery pack.
The TAD does not record caller's messages.	Set REC TIME to 1 or 4 .

Problem	Suggestion
The handset battery does not charge.	Check the charging contacts on the handset and base. If they are dirty, clean them with a pencil eraser (see "Connecting and Charging the Battery Pack" on Page 12).
	Be sure the battery pack is properly connected.
	Be sure the handset is properly seated on the base.
	Replace the battery pack (see "Replacing the Battery Pack" on Page 33).
Severe noise interference. The phone cannot be operated at a useful distance from the base because the signal becomes weak or noisy (handset's range has decreased).	Keep the handset away from computers, remote control toys, wireless microphones, alarm systems, intercoms, room monitors, fluorescent lights, and electrical appliances.
	Move to another location or turn off the source of the interference.
	Hang up and redial the number.
	Lift the base's antenna to a fully vertical position.
	Be sure neither the handset's nor base's antenna is touching a metal surface.
	Recharge the battery pack.
The TAD does not answer calls.	Make sure the TAD is set to on.
	Make sure the AC adapter and battery pack are properly connected.
	Check all phone line connections.
	Delete messages if memory is full.

If you still have problems, disconnect the phone. If other phones on the same line work properly, the fault is in this phone or its installation. If you cannot find the problem, take your TAD-727 to your local RadioShack store for assistance.

CARE AND MAINTENANCE

Your RadioShack TAD-727 900 MHz Digital Spread Spectrum Cordless Telephone is an example of superior design and craftsmanship. The following suggestions will help you care for your TAD-727 so you can enjoy it for years.



Keep the TAD-727 dry. If it gets wet, wipe it dry immediately. Liquids might contain minerals that can corrode the electronic circuits.



Use and store the TAD-727 only in normal temperature environments. Temperature extremes can shorten the life of electronic devices, damage the battery pack, and distort or melt plastic parts.



Keep the TAD-727 away from dust and dirt, which can cause premature wear of parts.



Handle the TAD-727 gently and carefully. Dropping it can damage circuit boards and cases and can cause the TAD-727 to work improperly.



Use only fresh batteries of the required size and recommended type. Batteries can leak chemicals that damage your TAD-727's electronic parts.



Wipe the TAD-727 with a damp cloth occasionally to keep it looking new. Do not use harsh chemicals, cleaning solvents, or strong detergents to clean the TAD-727.

Modifying or tampering with the TAD-727's internal components can cause a malfunction and might invalidate its warranty and void your FCC authorization to operate it. If your TAD-727 is not performing as it should, take it to your local RadioShack store for assistance. If the trouble is affecting the telephone lines, the phone company can ask you to disconnect your TAD-727 until you have resolved the problem.

REPLACING THE BATTERY PACK

If you follow the instructions in "Connecting and Charging the Battery Pack" on Page 12, the battery pack should last about one year. If the battery pack does not hold a charge for more than 2 hours after an overnight charge, replace it with a new 3.6-volt, 600 mAh battery pack with a connector that fits the socket in the battery compartment. You can order a replacement battery pack through your local RadioShack store.

Install the new battery pack as described below, then charge it for about 12 hours.

1. Press down and slide off the battery pack compartment cover as shown.
2. Lift the battery pack out of the compartment, then gently pull on the battery connector to disconnect it.
3. Insert the new battery pack's connector into the socket in the compartment, route the battery pack's leads into the strain relief slot and place the battery pack into the compartment.
4. Replace the cover.

Cautions:

- You must use a replacement battery pack of the same size and type.
- Do not dispose of the battery pack in a fire because it might explode.
- Do not open or mutilate the battery pack.

- Be careful not to short the battery pack by touching the connector's pins with conducting materials, such as rings, bracelets, and keys. The battery pack or conductor might overheat and burn.
- If you have trouble replacing the battery pack, take the phone to your local RadioShack store for assistance.

Important: This telephone can use nickel cadmium rechargeable batteries. At the end of a nickel cadmium battery's useful life, it must be recycled or disposed of properly. Contact your local, county, or state hazardous waste management authorities for information on recycling or disposal programs in your area or call 1-800-843-7422. Some options that might be available are: municipal curbside collection, drop-off boxes at retailers such as your local RadioShack store, recycling collection centers, and mail-back programs.



THE FCC WANTS YOU TO KNOW

In the unlikely event that your phone causes problems on the phone line, the phone company can temporarily discontinue your service. If this happens, the phone company attempts to notify you in advance. If advance notice is not practical, the phone company notifies you as soon as possible and advises you of your right to file a complaint with the FCC.

Also, the phone company can make changes to its lines, equipment, operations, or procedures that could affect the operation of this telephone. The telephone company notifies you of these changes in advance, so you can take the necessary steps to prevent interruption of your telephone service.

Your phone might cause TV or radio interference even when it is operating properly. To determine whether your phone is causing the interference, turn off your phone. If the interference goes away, your phone is causing it. Try to eliminate the interference by:

- moving your phone away from the receiver
- connecting your phone to an AC outlet that is on a different electrical circuit from the receiver
- contacting your local RadioShack store for help

If you cannot eliminate the interference, the FCC requires that you stop using your phone.

Some cordless telephones operate on frequencies that might cause interference to nearby TVs and VCRs. To minimize or prevent such interference, the base of the cordless telephone should not be placed near or on top of a TV or VCR.

LIGHTNING

Your telephone has built-in lightning protection to reduce the risk of damage from surges in telephone line and power line current. This lightning protection meets or exceeds FCC requirements. However, lightning striking the telephone or power lines can damage your telephone.

Lightning damage is not common. Nevertheless, if you live in an area that has severe electrical storms, we suggest that you unplug your phone during storms to reduce the possibility of damage.

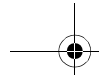

NOTES

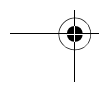
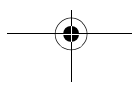
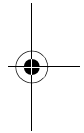
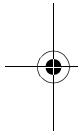



Limited One-Year Warranty

This product is warranted by RadioShack against manufacturing defects in material and workmanship under normal use for one (1) year from the date of purchase from RadioShack company-owned stores and authorized RadioShack franchisees and dealers. EXCEPT AS PROVIDED HEREIN, RadioShack MAKES NO EXPRESS WARRANTIES AND ANY IMPLIED WARRANTIES, INCLUDING THOSE OF MERCHANTABILITY AND FITNESS FOR A PARTICULAR PURPOSE, ARE LIMITED IN DURATION TO THE DURATION OF THE WRITTEN LIMITED WARRANTIES CONTAINED HEREIN. EXCEPT AS PROVIDED HEREIN, RadioShack SHALL HAVE NO LIABILITY OR RESPONSIBILITY TO CUSTOMER OR ANY OTHER PERSON OR ENTITY WITH RESPECT TO ANY LIABILITY, LOSS OR DAMAGE CAUSED DIRECTLY OR INDIRECTLY BY USE OR PERFORMANCE OF THE PRODUCT OR ARISING OUT OF ANY BREACH OF THIS WARRANTY, INCLUDING, BUT NOT LIMITED TO, ANY DAMAGES RESULTING FROM INCONVENIENCE, LOSS OF TIME, DATA, PROPERTY, REVENUE, OR PROFIT OR ANY INDIRECT, SPECIAL, INCIDENTAL, OR CONSEQUENTIAL DAMAGES, EVEN IF RadioShack HAS BEEN ADVISED OF THE POSSIBILITY OF SUCH DAMAGES.

Some states do not allow the limitations on how long an implied warranty lasts or the exclusion of incidental or consequential damages, so the above limitations or exclusions may not apply to you.

In the event of a product defect during the warranty period, take the product and the RadioShack sales receipt as proof of purchase date to any RadioShack store. RadioShack will, at its option, unless otherwise provided by law: (a) correct the defect by product repair without charge for parts and labor; (b) replace the product with one of the same or similar design; or (c) refund the purchase price. All replaced parts and products, and products on which a refund is made, become the property of RadioShack. New or reconditioned parts and products may be used in the performance of warranty service. Repaired or replaced parts and products are warranted for the remainder of the original warranty period. You will be charged for repair or replacement of the product made after the expiration of the warranty period.

This warranty does not cover: (a) damage or failure caused by or attributable to acts of God, abuse, accident, misuse, improper or abnormal usage, failure to follow instructions, improper installation or maintenance, alteration, lightning or other incidence of excess voltage or current; (b) any repairs other than those provided by a RadioShack Authorized Service Facility; (c) consumables such as fuses or batteries; (d) cosmetic damage; (e) transportation, shipping or insurance costs; or (f) costs of product removal, installation, set-up service adjustment or reinstallation.

This warranty gives you specific legal rights, and you may also have other rights which vary from state to state.

RadioShack Customer Relations, 200 Taylor Street, 6th Floor, Fort Worth, TX 76102

We Service What We Sell

04/99

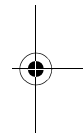
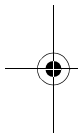

RadioShack
A Division of Tandy Corporation
Fort Worth, Texas 76102

1AD6P1P0942- -
Printed in Malaysia

07A99

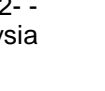
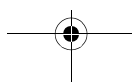

Free Manuals Download Website

<http://myh66.com>

<http://usermanuals.us>

<http://www.somanuals.com>

<http://www.4manuals.cc>

<http://www.manual-lib.com>

<http://www.404manual.com>

<http://www.luxmanual.com>

<http://aubethermostatmanual.com>

Golf course search by state

<http://golfingnear.com>

Email search by domain

<http://emailbydomain.com>

Auto manuals search

<http://auto.somanuals.com>

TV manuals search

<http://tv.somanuals.com>