

Cat. No. 43-729 A  
**OWNER'S MANUAL**

Please read before using this equipment.

---

# TAD-729

---



**900 MHz Digital Caller ID Call Waiting  
Cordless Speakerphone  
with Digital Answerer**



## FEATURES

---

**WARNING:** To reduce the risk of fire or shock hazard, do not expose this product to rain or moisture.

	<b>CAUTION</b> RISK OF ELECTRIC SHOCK. DO NOT OPEN.	
<b>CAUTION:</b> TO REDUCE THE RISK OF ELECTRIC SHOCK, DO NOT REMOVE COVER OR BACK. NO USER-SERVICEABLE PARTS INSIDE. REFER SERVICING TO QUALIFIED PERSONNEL.		



This symbol is intended to alert you to the presence of uninsulated dangerous voltage within the product's enclosure that might be of sufficient magnitude to constitute a risk of electric shock. Do not open the product's case.



This symbol is intended to inform you that important operating and maintenance instructions are included in the literature accompanying this product.

Your RadioShack TAD-729 900 MHz Dual Keypad Cordless Speakerphone Digital Answering System combines a 900 MHz digital cordless telephone unit and a digital TAD (Telephone Answering Device).

The 900 MHz band means less interference, clearer sound, and greater range than 46/49 MHz cordless telephones. The Caller ID unit records each caller's telephone number (and name, if available in your area) and the date and time of the call, as provided by your local phone company to Caller ID service subscribers. And, if you subscribe to Call Waiting with Caller ID, the TAD-729 can show you the incoming caller information, even when you are already on the phone.

The TAD stores up to 12 minutes of messages on a computer chip and records each message's day and time. This gives you advanced capabilities over tape-based answering machines:

- You can delete individual messages and save the rest.
- There are no tapes to bother with and no tape mechanisms to wear out.

© 1999, 2000 RadioShack Corporation.  
All Rights Reserved.

RadioShack is a trademark used by RadioShack Corporation.

---

---

## TELEPHONE FEATURES

**30-Number Memory Dialing** — lets you store 30 numbers in memory (20 in the handset, 10 in the base) for easy dialing.

**Dual Keypad** — a full set of keys on both the handset and base let you use either keypad to make and answer calls or to program the phone's features.

**Headset Jack** — lets you connect an optional headset for handsfree convenience.

**Volume Controls** — let you adjust the volume you hear through the handset and speakerphone.

**Ringer Volume Control** — lets you select from four ringer tone/volume settings on the handset.

**Caller ID Memory** — stores up to 50 Caller ID records.

**3-Line Liquid Crystal Display** — lets you view an entire Caller ID record on one screen.

**Two-Way Intercom/Paging System** — lets you send a signal from the base to the handset, or from the handset to the base, to page someone or locate the handset when it is away from the base. If someone answers, you can use the TAD-729 as an intercom.

**30 Channels** — automatically selects a clear channel when you make or answer a call. You can also manually change channels during a call.

**Security Access-Protection Code** — helps prevent other cordless phone users from using your phone line.

**Long Battery Life** — the supplied battery pack (when fully charged) provides about 7 hours of talk time or 7 days of standby time.

**Tone/Pulse Dialing** — lets you use either type of service, and you can easily switch from pulse to tone dialing for long-distance, bank-by-phone, or other special services.

**Redial** — lets you quickly redial any of the last three numbers dialed on the handset. You can also redial the last number you dialed on the base.

**Auto Talk** — you can set the phone so you can answer a call simply by lifting the handset from the base.

**Any Key Answer** — you can set the phone so you can press any key to answer a call when the handset is away from the base.

**Hearing-Aid Compatibility** — lets you use your phone with hearing aids that have a T (telephone) switch.

**Facedown or Faceup Handset Charging** — you can charge the handset on the base facedown or faceup.

---

**Wall Mountable** — you can mount the TAD-729 on the wall to save space on your desk top.

## TAD FEATURES

**Day/Time Stamp** — records the day and time each message was recorded.

**Remote Operation** — lets you operate your TAD from a touch-tone phone (or from a rotary phone with a pocket tone dialer).

**Two Prerecorded Messages** — gives you the option of using one of two pre-recorded outgoing messages or recording your own.

**Announcement Only** — lets you play an announcement for callers to hear, without recording their messages.

**Message Counter** — shows the number of messages the TAD has recorded.

**Programmable PIN** — lets you set a two-digit personal identification number (PIN) for secure remote operation.

**Call Screening** — lets you listen as a caller leaves a message so you can decide whether or not to answer the call.

**Memo Recording** — lets you leave messages for yourself or others in your home or office. You can also record your phone conversation.

**Phone Pick-Up Detection** — stops recording when you pick up any phone on the same line as the TAD, and resets to answer the next call.

**Adjustable Ring Number** — lets you set the TAD to answer after three or five rings.

**Toll-Saver** — lets you avoid unnecessary charges when you call by long distance to check your messages.

**Digital Volume Control** — lets you precisely adjust the speakerphone and message playback.

## IMPORTANT CALLER ID INFORMATION

To use the phone's Caller ID and Caller ID with Call Waiting features, you must be in an area where those services are available and you must subscribe to those services through your local phone company.

Where Caller ID is offered, one or more options are generally available:

- caller's number only
- caller's name only
- caller's name and number

---

## READ THIS BEFORE INSTALLATION

We have designed your phone to conform to federal regulations, and you can connect it to most telephone lines. However, each device that you connect to the phone line draws power from the phone line. We refer to this power draw as the device's ringer equivalence number, or REN. The REN is on the bottom of the base. If you are using more than one phone or other device on the line, add up all the RENs. If the total is more than five (three in rural areas), your phones might not ring. If ringer operation is impaired, remove a device from the line.

## FCC STATEMENT

Your TAD-729 complies with Part 68 of *FCC Rules*. You must, upon request, provide the FCC registration number and the REN to your phone company. These numbers are on the bottom of the base.

You must not connect your phone to any of the following:

- coin-operated systems
- party-line systems
- most electronic key phone systems

**Note:** Your telephone operates on standard radio frequencies, as allocated by the FCC. Even though the security access-protection code prevents unauthorized use of your phone line, it is possible for other radio units operating on similar frequencies within a certain area to unintentionally intercept your conversations and/or cause interference. This lack of privacy can occur with any cordless phone.

# CONTENTS

---

<b>Preparation .....</b>	<b>8</b>
Mounting the Phone .....	8
On a Desk Top .....	8
On a Wall Plate or Wall .....	9
Connecting and Charging the Battery Pack .....	10
Setting the Dialing Mode .....	11
Turning the Base's Ringer Off and On .....	12
Setting the Ringer Tone/Volume .....	12
Setting the Number of Rings .....	13
Setting the Day/Time .....	13
Setting Auto Talk .....	14
Turning Call Waiting/Caller ID On/Off .....	14
Storing Your Area Code .....	14
<b>Telephone Operation .....</b>	<b>16</b>
Making and Receiving a Call .....	16
Using the Handset .....	16
Using the Speakerphone .....	16
Adjusting the Handset Volume .....	17
Selecting the Channel .....	17
Using Mute .....	17
Switching Between the Handset and Speakerphone .....	17
Using Both the Handset and Speakerphone .....	17
Using Flash .....	18
Using Redial .....	18
Using Tone Services on a Pulse Line .....	18
Using Page/Intercom .....	19
Transferring a Call Between the Handset and Base .....	19
Using a Headset .....	20
<b>Memory Dialing .....</b>	<b>21</b>
Storing a Number in Memory .....	21
In the Handset .....	21
In the Base .....	22
Editing or Deleting a Number in the Handset's Memory .....	23
Entering a Pause .....	23
Reviewing Memory Numbers (Handset Only) .....	23
Dialing a Memory Number .....	24
Chain-Dialing Service Numbers .....	24
Testing Stored Emergency Numbers .....	24

---

<b>Caller ID Operation (Handset Only)</b> .....	<b>25</b>
Reviewing Caller ID Records .....	25
Caller ID Messages .....	25
Dialing Numbers from a Caller ID Record .....	26
Storing a Caller ID Record to Memory .....	26
Deleting Caller ID Records .....	26
<b>TAD Operation</b> .....	<b>28</b>
Selecting the Outgoing Message .....	28
Recording/Deleting an Outgoing Message .....	28
Setting the Record Time .....	28
Setting the TAD to Answer Calls .....	29
Screening Calls .....	29
Recording Incoming Messages .....	29
Recording a Memo .....	29
Recording a Conversation .....	30
Playing Messages .....	30
Adjusting the TAD's Volume .....	31
Deleting Messages .....	31
Setting the Remote Operation PIN .....	31
<b>Remote Operation</b> .....	<b>32</b>
Using the Toll-Saver .....	32
Using Remote Commands .....	32
<b>Troubleshooting</b> .....	<b>34</b>
<b>Care and Maintenance</b> .....	<b>36</b>
Replacing the Battery Pack .....	37
The FCC Wants You to Know .....	38
Lightning .....	38

## PREPARATION

---

### MOUNTING THE PHONE

You can place the TAD-729's base on a desk or table, mount it on a standard wall plate, or mount it directly on a wall. Choose a location that is:

- near an AC outlet
- near a modular telephone line jack
- out of the way of normal activities
- away from electrical machinery, electrical appliances, metal walls or filing cabinets, wireless intercoms, alarms, and room monitors
- away from other cordless phones

The base's location affects the phone's range. If you have a choice of several locations, try each to see which provides the best performance.

**Caution:** The supplied RadioShack adapter was designed specifically for your TAD-729. Use only the supplied adapter.

#### Notes:

- Your telephone connects directly to a modular telephone line jack. If your phone line jack is not a modular jack, you can update the wiring yourself, using jacks and adapters available at your local RadioShack store. Or, you can let the phone company update the wiring for you.
- The USOC number of the jack to be installed is RJ11C (RJ11W for a wall plate).

### On a Desk Top

1. Plug one end of the supplied long modular cord into the **TEL LINE** jack on the back of the base.

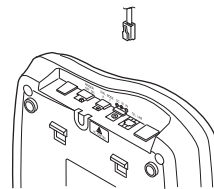

2. Plug the modular cord's other end into a modular telephone line jack.
3. Insert the supplied AC adapter's barrel plug into the **DC IN 9V** jack on the back of the base.

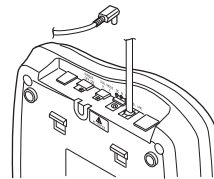

4. Route the adapter's cord through the strain relief slot on the bottom of the base.

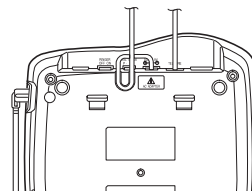

5. Plug the adapter into a standard AC outlet.
6. Lift the base's antenna to a vertical position.



---

## On a Wall Plate or Wall

1. Insert the two tabs at the top of the narrow end of the supplied bracket into the base's upper tab slots as shown, then press down on the bracket's latches and insert them into the lower slots.

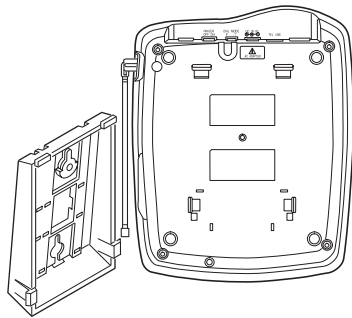

2. Plug one end of the supplied short modular cord into the **TEL LINE** jack on the back of the base as in Step 1 of "On a Desk Top" on Page 8.
3. Insert the supplied AC adapter's barrel plug into the **DC IN 9V** jack as in Step 3 of "On a Desk Top" on Page 8.
4. Route the adapter and modular cords through the grooves on the bracket.

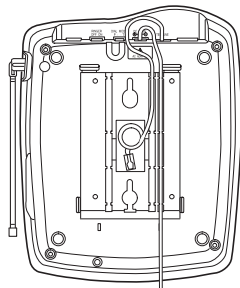

5. Plug the modular cord's other end into the wall plate jack, then align the bracket's keyhole slots with the wall plate studs and slide the base downward to secure it.

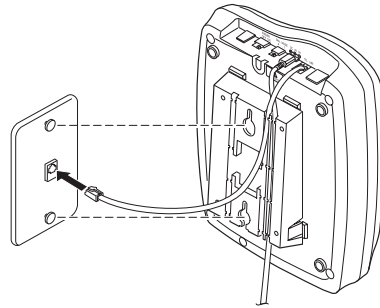

6. Plug the adapter into a standard AC outlet.
7. Press and lift out the handset holder, flip it over as shown, then snap it back into place so it holds the handset.

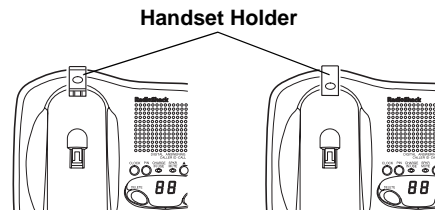

8. Lift the base's antenna to a vertical position.

**Note:** To mount the TAD directly on a wall, you need two screws (not supplied) with heads that fit into the keyhole slots on the bottom of the base. Follow the steps under "On a Wall Plate or Wall" on Page 9, then apply these additional instructions for placement on a wall.

1. Drill two holes  $3^{15}/16$  inches (100 mm) apart. Then thread a screw into each hole, letting the heads extend about  $5/16$  inch (8 mm) from the wall.

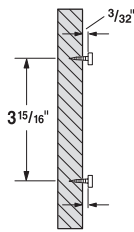

2. Plug one end of the supplied long modular cord into the **TEL LINE** jack at the back of the base.
3. Align the bracket's keyhole slots with the mounting screws and slide the base downward to secure it.

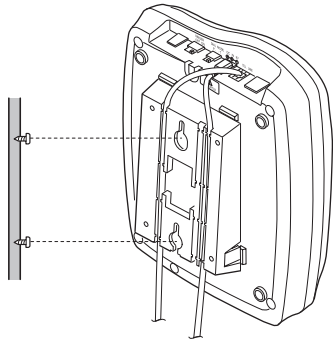

## CONNECTING AND CHARGING THE BATTERY PACK

The TAD-729 comes with a rechargeable nickel-cadmium battery pack installed in the handset, but not connected. Before using your phone, you must connect the battery pack, then charge it for about 24 hours.

1. Press down and slide off the battery pack compartment cover.

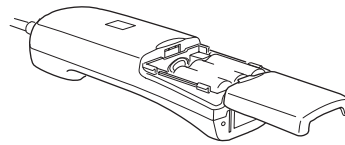

2. Lift the battery pack out of the compartment. Plug the battery pack's connector into the socket in the compartment. The connector fits only one way.

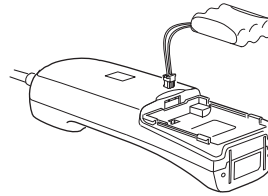

3. Put the battery pack in the compartment.
4. Replace the cover.

To charge the battery pack, simply place the handset on the base, facing either up or down. The **CHARGE/IN USE** indicator on the base lights.

---

Recharge the battery pack when **Low Battery** flashes on the display.

**Important:** Be sure the battery pack is properly connected before you try to charge it. The CHARGE/IN USE indicator lights when the handset is on the base, even if the battery pack is not connected.

**Notes:**

- When you first use the phone after charging or recharging the battery pack, the phone might not work and you might hear a five-beep error signal. If this happens, return the handset to the base for about 5 seconds. This resets the security access-protection code.
  - Using a pencil eraser, clean the charging contacts on the handset and the base about once a month.
- If the battery pack becomes weak during a call, the handset beeps every 3 seconds and **Low Battery** flashes. When this happens, you cannot make another call on the phone until you recharge the battery pack.
  - About once a month, fully discharge the battery pack by keeping the handset off the base until **Low Battery** flashes. Otherwise, the battery pack loses its ability to fully recharge.
  - If the battery pack is completely discharged or the base loses power while the handset is away from it, place the handset on the base to reset the security access-protection code. If it was the handset that lost power, recharge the battery pack.
  - The supplied battery pack should last about a year. When it loses its ability to fully recharge, order a replacement battery pack through your local RadioShack store (see "Replacing the Battery Pack" on Page 37).

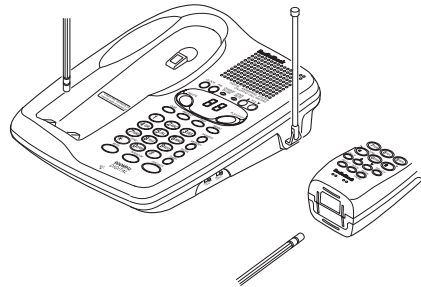

- If the display is blank and the phone does not work, recharge the battery pack. (The battery power might be too low to light the display.)

## SETTING THE DIALING MODE

Set **DIAL MODE** on the back of the base for the type of service you have. If you are not sure which type you have, after you charge the handset battery pack, do this simple test.

1. Set **DIAL MODE** to **T** (tone).

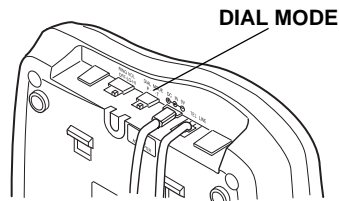

2. Lift the handset and listen for a dial tone.
3. Press any number other than 0.

**Note:** If your phone system requires that you dial an access code (9, for example) before you dial an outside number, do not press the access code number either.

If the dial tone stops, you have touch-tone service. Leave **DIAL MODE** set to **T**. If the dial tone continues, you have pulse service. Set **DIAL MODE** to **P** (pulse).

4. Press **TALK** or place the handset on the base to hang up.

## TURNING THE BASE'S RINGER OFF AND ON

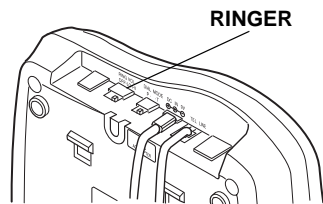

To turn off the base's ringer, set **RINGER** on the back of the base to **OFF**. You can still make or receive calls using this

phone. Telephones on the same line (and the TAD's handset if it is away from the base) still ring when there is an incoming call.

To turn on the base's ringer, set **RINGER** to **ON**.

## SETTING THE RINGER TONE/VOLUME

You can select one of four different ringer tone/volume settings while the phone is not in the talk mode. Press **▲** or **▼** to increase or decrease the ringer level setting.

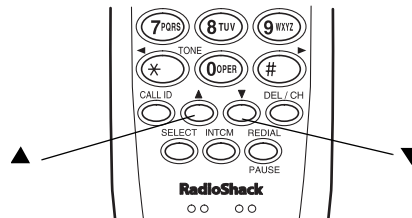

Repeatedly press **▲** or **▼** until you hear the desired ringer setting. Each time you press **▲** or **▼** the ringer changes and the display shows **Ringer A High**, **Ringer A Low**, **Ringer B High**, or **Ringer B Low**.

**Note:** Pressing **▲** when the display shows **Ringer A High** or **▼** when the display shows **Ringer B Low** does not change the setting. Press the other button to change the setting.

---

## SETTING THE NUMBER OF RINGS

Set **RING TIME** on the side of the base to **3**, **5**, or **T/S** to select how long the TAD waits to answer a call (3 rings, 5 rings, or toll-saver).

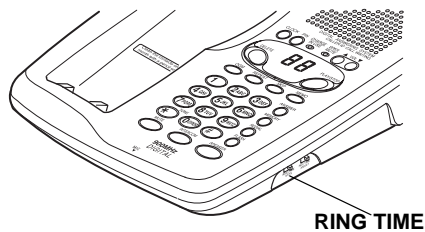

**Note:** If you plan to check messages by long distance, set **RING TIME** to toll-saver (see "Using the Toll-Saver" on Page 32).

## SETTING THE DAY/TIME

You must set the day of the week and time so the TAD can record the correct day and time of each message.

**Note:** Enter each key press within about 2 minutes. Otherwise, the TAD exits the time setting process and you must begin again with Step 1.

1. Hold down **CLOCK** until the TAD beeps. The TAD announces the currently set day and displays the day's number (**0** for Sunday, **1** for Monday, and so on).
2. To change the day of the week, repeatedly press **SKIP** to move for-

ward or **REPEAT** to move backward. To set the correct day of the week when it displays, press **CLOCK**.

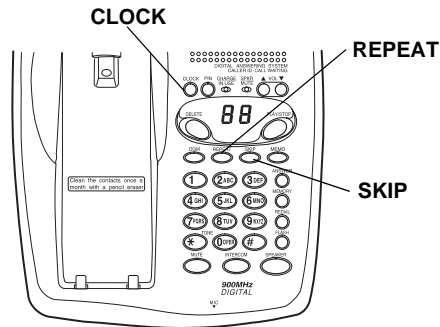

3. The TAD announces the hour. To change the hour, repeatedly press **SKIP** or **REPEAT**. To set the correct hour when it displays, press **CLOCK**.
4. The TAD announces the minutes. To change the minutes, repeatedly press **SKIP** or **REPEAT**. To set the correct minutes when they display, press **CLOCK**.

The TAD announces "AM" or "PM," and **A** or **P** appears. Press **SKIP** or **REPEAT** to change this setting. Press **CLOCK** again to set "AM" or "PM." The TAD beeps and announces the day and time.

5. To check the day and time press **CLOCK**. The TAD announces the currently set day and time.

**Note:** When power fails, the clock retains the current time. When the power is restored, it starts counting again from the time the power failed.

---

---

## SETTING AUTO TALK

Your phone is preset so you must press **TALK** to answer a call. With auto talk turned on, you can answer a call by just lifting the handset from the base, or, if the handset is away from the base, by pressing any key.

Follow these steps to turn auto talk on or off.

1. Lift the handset and hold down **CALL ID** until **Caller ID Setup** appears on the display with **Auto Talk** selected.

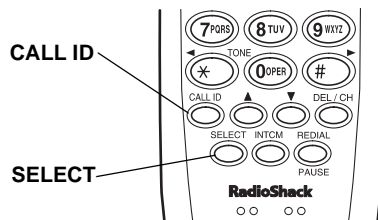

2. Press **SELECT** to change the auto talk setting. **On** or **Off** appears indicating the selected setting.
3. To clear the display when you finish, press **CALL ID** or return the handset to the base.

## TURNING CALL WAITING/ CALLER ID ON/OFF

If you have Call Waiting with Caller ID service, you can set the TAD-729 to show Caller ID information for an incoming call even while you are already on the phone.

Follow these steps to turn the Caller ID/Call Waiting feature on or off.

1. Lift the handset and hold down **CALL ID** until **Caller ID Setup** appears on the display with **Auto Talk** selected.
2. Press **2** or **▼** to select **CIDCW** (Caller ID/Call Waiting).
3. Press **SELECT** to change the Caller ID/Call Waiting setting. **On** or **Off** appears indicating the selected setting.
4. Press **CALL ID** then return the handset to the base to store the new setting.

## STORING YOUR AREA CODE

To quickly dial a number from a Caller ID record (see "Dialing Numbers from a Caller ID Record" on Page 26) or to correctly store a number from a record into a memory dialing location (see "Storing a Caller ID Record to Memory" on Page 26), you must store your local area code in the TAD-729's memory. Then, when you dial from a Caller ID record, the TAD-729 skips the area code if it matches the one you stored.

Follow these steps to store your area code.

1. Lift the handset and hold down **CALL ID** until **Caller ID Setup** appears on the display with **Auto Talk** selected.

---

2. Press **3** (or **▼** twice) to select **Area Code**.

3. Press **SELECT**, then enter your 3-digit area code. If you make a mistake, repeatedly press **▶** or **◀** to move the cursor over the incorrect digit, then enter the correct number.

**Note:** If an area code is already stored, it appears on the display. To delete the area code, press **DEL/CH** three times. Then enter your area code.

4. Press **SELECT** to store the area code, then press **CALL ID** or return the handset to the base to clear the display.

# TELEPHONE OPERATION

**Note:** To use the speakerphone, you must use the base keypad; to use the handset, you must use the handset keypad.

## MAKING AND RECEIVING A CALL

### Using the Handset

To make a call, lift the handset and press **TALK**. **TALK** appears on the handset's display and the CHARGE/IN USE indicator on the base light. Dial the number. You see the number as you dial, then (after a few seconds) the call's elapsed time.

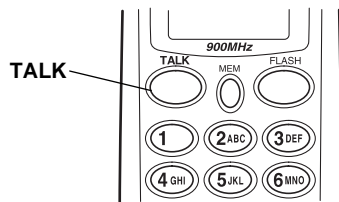

**Note:** You can also dial the number before you press **TALK**. If you make a mistake, repeatedly press **DEL/CH** to erase up to the wrong entry, then enter the correct number. You can also press and hold **DEL/CH** for more than one second to delete the entire number.

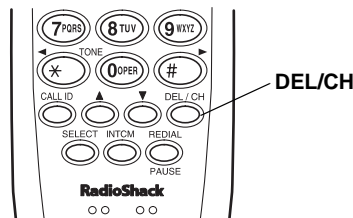

To answer a call, lift the handset from the base and press **TALK**. If auto talk is on, just lift the handset from the base or press any key to answer a call.

To end a call, place the handset on the base or press **TALK**.

### Using the Speakerphone

To make or answer a call using the speakerphone, simply press **SPEAKER**. The SPKR/MUTE indicator lights. Use the base's keypad to dial the desired number.

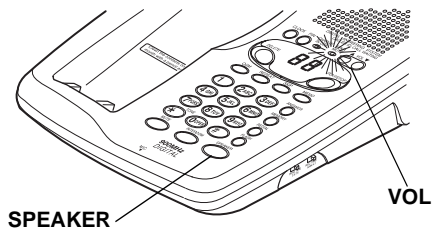

To adjust the speakerphone's volume, repeatedly press **VOL ▲** or **VOL ▼** on the base. The volume setting from 1 (lowest) to 10 (highest) appears in the message counter window.

To end a speakerphone call, press **SPEAKER** again. The SPKR/MUTE indicator turns off.



---

## ADJUSTING THE HANDSET VOLUME

To adjust the volume you hear through the handset during a call, press ▲ to increase or ▼ to decrease the volume. The display shows **Volume Maximum**, **Volume High**, **Volume Medium**, or **Volume Low**.

**Note:** When you press ▲ while the volume is maximum or ▼ while the volume is low, the setting does not change.

## SELECTING THE CHANNEL

The phone scans 30 channels (frequency pairs used between the base and the handset) and automatically selects a clear channel each time you make or receive a call. If you hear other conversations or excessive noise during a call, press **DEL/CH** to select a different channel. The display shows **Scanning**.

**Note:** If the handset is too far from the base, the channel might not change. Move closer to the base and try again.

## USING MUTE

To talk to someone in the room while using the speakerphone without the person on the other end of the phone line hearing your conversation, press **MUTE**. The SPKR/MUTE indicator flashes.

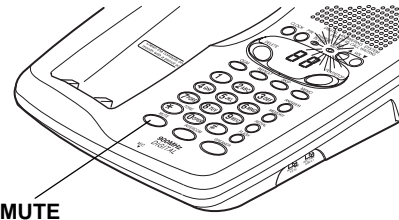

Press **MUTE** again to resume your phone conversation.

## SWITCHING BETWEEN THE HANDSET AND SPEAKERPHONE

To switch to the speakerphone while you are using the handset, press **SPEAKER** on the base. When you hear the conversation on the speakerphone, press **TALK** on the handset.

To switch to the handset while you are using the speakerphone, lift the handset off the base. If the handset is away from the base, press **TALK**, then press **SPEAKER**.

## USING BOTH THE HANDSET AND SPEAKERPHONE

If someone else is using the speakerphone, press **TALK** on the handset to join the conversation. If someone else is using the handset, press **SPEAKER** on the base to join the conversation.

---

During the call, one person can hang up and let the call continue at the other keypad. Or, both people can hang up to end the call.

**Note:** If you hear a high-pitched noise from the base's speaker, the handset and the base are too close together.

## USING FLASH

**FLASH** performs the electronic equivalent of a switchhook operation for special services, such as Call Waiting.

For example, if you have Call Waiting, press **FLASH** to answer an incoming call without disconnecting the current call. Press **FLASH** again to return to the first call.

**Note:** If you do not have any special phone services, pressing **FLASH** might disconnect the current call.

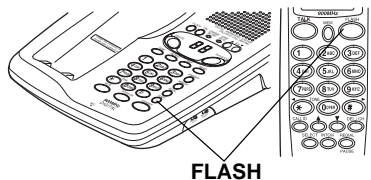

## USING REDIAL

To quickly dial any of the last three numbers dialed on the handset, lift the handset and repeatedly press **REDIAL/PAUSE** on the handset until the desired number appears on the display. Then press **TALK**.

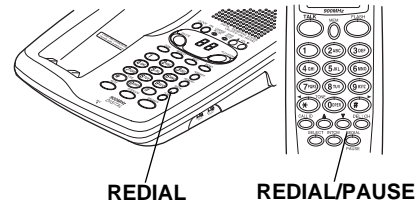

To dial the last number dialed on the base, press **SPEAKER**, and, when you hear the dial tone, press **REDIAL** on the base. You can redial only the last number on the base.

### Notes:

- The redial memory is separate for each keypad. You cannot redial a number you dialed on the handset keypad using **REDIAL** on the base, and vice versa.
- The redial memory holds up to 32 digits, so you can redial long-distance as well as local numbers.
- The redial memory also holds pause entries (see "Entering a Pause" on Page 23).

## USING TONE SERVICES ON A PULSE LINE

Some special services, such as bank-by-phone, require tone signals. If you have pulse service, you can still use these special tone services by following these steps.

1. Be sure **DIAL MODE** is set to **P**.
2. Dial the service's main number.

- When the service answers, press **-tone** (\*). Any additional numbers you dial are sent as tone signals.

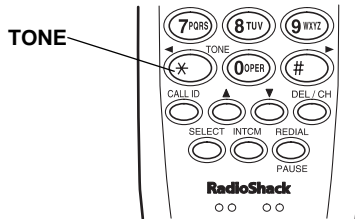

- When you hang up, the phone automatically resets to pulse dialing.

## USING PAGE/INTERCOM

You can use the TAD-729 as a two-way pager and intercom between the base and the handset. This is useful if the handset is away from the base and you want to locate it, or if you want to have a conversation between someone with the handset and someone at the base.

To page the base from the handset, press **INTCM**. The base and handset ring. Press **SPEAKER** or **INTERCOM** on the base to answer the page.

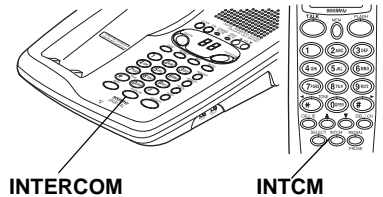

To page the handset from the base, press **INTERCOM**. The handset and base ring. Press **TALK** or **INTCM** on the handset to answer the page.

In either case, if the called party does not answer within 1 minute, the paging stops. Press **INTCM** or **INTERCOM** again to re-start paging.

To end an intercom call, press **TALK** on the handset, press **SPEAKER** on the base, or hang up the handset.

If a call comes in during an intercom conversation, only the base rings but person at the handset can also hear the ring through the intercom. Either person can answer the call. Press **TALK** or **SPEAKER** once to end the intercom call, then press **TALK** or **SPEAKER** again to answer the call.

**Note:** The intercom does not operate if the party being paged is already on a call.

## TRANSFERRING A CALL BETWEEN THE HANDSET AND BASE

You can use the TAD-729's intercom feature to transfer a call between the handset and the base.

---

To transfer a call from the handset to the base, press **INTCM**. The call is placed on hold. When the person at the base answers, press **TALK**. The call is released from hold and transferred to the base. To bring the handset back into the conversation for a 3-way conference, press **TALK** again.

To transfer a call from the base to the handset, press **INTERCOM**. The call is placed on hold. When the person with the handset answers, press **SPEAKER**. The call is released from hold and transferred to the handset. To bring the base back into the conversation for a 3-way conference, press **SPEAKER** again.

## USING A HEADSET

You can talk with hands-free convenience using an optional headset that has a  $\frac{3}{32}$ -inch (2.5-mm) plug. Contact your local RadioShack store for a suitable headset.

To connect the headset, open the rubber cover marked  on the side of the handset, then insert the headset's plug into the jack.

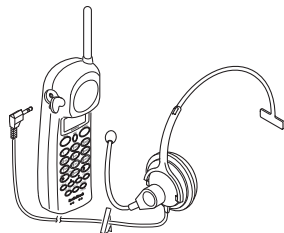

### Notes:

- Connecting a headset disconnects the handset's earpiece and microphone.
- ▲ or ▼ on the handset also controls the connected headset's volume.
- If you place the handset on the base to recharge it while the headset is connected, be sure the handset seats properly.

With a headset connected, you make or answer calls as usual using the keys on the handset. You can also make or answer calls by pressing the **SPEAKER** button located on the base.

You can use a handset holder (available from your local RadioShack store) to hang the handset on your belt for greater convenience.

When you finish using the headset, disconnect it from the handset and close the rubber cover to protect the jack.

## MEMORY DIALING

---

You can store up to 20 numbers in the handset's memory and another 10 in the base's memory, then dial a stored number by pressing a memory location number. You can also store a name with each number in the handset's memory.

Each number you store can be up to 20 digits long, and each name can be up to 13 characters.

You cannot dial a number stored in one memory location (the base or the handset) using the keypad on the other.

### STORING A NAME AND NUMBER IN MEMORY

#### Notes:

- An error tone sounds and the phone exits the storing process if you wait more than 20 seconds between key presses.
- If you receive a call during memory entry, the phone exits the storing process.

#### In the Handset

1. Lift the handset.
2. Hold down **MEM** until **Memory Store** and a list of memory location numbers (and names, if any) appears.

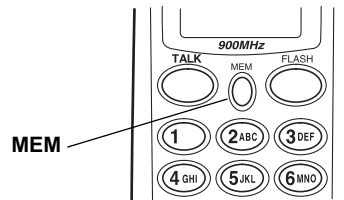

3. Select an empty memory location (or the one you want to replace) by using ▼ or ▲ to scroll through the list or entering the location number (01–20). Precede a single-digit number with a 0 (01, for example).

**Note:** If the phone sounds five quick beeps, you have made an entry error and the number was not stored. Re-enter the location number correctly.

4. Press **SELECT**. **Store Name** appears. If you do not want to enter a name, skip to Step 6. <Memory nn> appears as the name (nn is the memory location number you selected).
5. To enter a name, use ▲ or ▼ to select the characters and ► or ◀ to move the cursor. Repeatedly press ▼ to view the characters in alphabetical order. The display shows uppercase letters first, then lowercase letters, numbers, and special characters. Press ▲ to view the characters in reverse order. You can hold down ▲ or ▼ to scroll rapidly through the characters.

---

If you make a mistake, move the cursor over the error, then enter the correct character, or press **DEL/CH** to delete a character. To delete all the characters, hold down **DEL/CH** for at least 1 second.

6. Press **SELECT**. **Store Number** appears.
7. Enter the phone number and any tone or pause entries (see "Using Tone Services on a Pulse Line" on Page 18 and "Entering a Pause" on Page 23).
8. Press **SELECT**. The phone beeps and **Memory n Stored** appears. After 2 seconds, **Memory Store** appears. Repeat Steps 3–8 to store more numbers.
9. When you finish, press **MEM** to exit Memory Store.

Use the supplied memory directory sticker to record your stored numbers. Peel the backing from the sticker and attach it to the base.

To replace a stored number, store a new one in its place.

## In the Base

1. Press **MEMORY**. The **CHARGE/IN USE** indicator blinks.

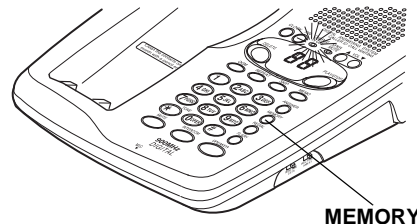

2. Enter the phone number and any tone or pause entries (see "Using Tone Services on a Pulse Line" on Page 18 and "Entering a Pause" on Page 23).
3. Press **MEMORY** again, then enter the memory location number (**0–9**) where you want to store the number. A tone sounds to indicate that the number is stored.

To clear a stored number, simply store a new number in its place. Or, press **MEMORY** twice. Then press the memory location number (**0–9**) you want to clear. A tone sounds.

Use the supplied memory directory sticker to record your stored numbers. Peel the backing from the sticker and attach it to the base.

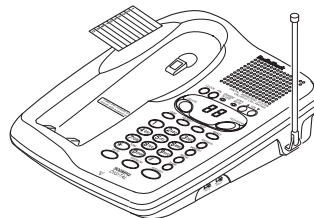

---

## EDITING OR DELETING A NUMBER IN THE HANDSET'S MEMORY

Follow these steps to edit or delete a memory number.

1. Lift the handset.
2. Hold down **MEM** until **Memory Store** and a list of memory location numbers appear on the display.
3. Choose a memory location (01–20) by pressing a number or by repeatedly pressing **▲** or **▼**.
4. Press **SELECT**. A menu appears with the three options listed below. Press **▲** or **▼** to highlight the desired option then press **SELECT** to choose it.

**Edit Memory nn** — Edit the record as described in Steps 5 through 8 of “Storing a Name and Number in Memory” on Page 21

**Delete Memory nn** — The display prompts you to confirm the deletion. Move the cursor to **Yes**, then press **SELECT** or **DEL/CH**. The phone beeps, and **Memory n Deleted** appears.

**Go Back** — Returns you to the list of memory numbers.

## ENTERING A PAUSE

In some telephone systems, you must dial an access code (9, for example) and wait for a second dial tone before you can dial an outside number. You can

store the access code with the phone number. However, you should also store a pause after the access code to allow the outside line time to connect.

To enter a 2-second pause, press **REDIAL/PAUSE** (**REDIAL** on the base). **P** appears on the display when you enter a pause in handset's memory. You can add more pause entries for a longer pause.

## REVIEWING MEMORY NUMBERS (HANDSET ONLY)

To review your memory numbers, press **MEM**. The list of memory location numbers (01–20) and the name stored with each number (or **<Memory nn>** if you did not store a name) appears.

To see the stored phone numbers, press **►**. An arrow to the right of the number means it is longer than 14 digits. Press **►** again to see the rest of the number.

Repeatedly press **◀** to return to the name display.

To exit the memory number list, press **MEM**.

To see a stored name and phone number at the same time, press **SELECT** when the cursor is by a memory location number. To exit this display without storing any changes, hold down **DEL/CH** until the display clears.

---

## DIALING A MEMORY NUMBER

To dial a number stored in handset's memory, lift the handset and press **MEM**. The list of memory location numbers appears. Choose a memory location (01–20) by pressing a number or by repeatedly pressing **▲** or **▼**, then press **TALK**.

You can also dial a memory number after pressing **TALK**. Press **MEM** (the display does not change but the phone is in memory recall mode) then enter a memory location number.

To dial a number stored in the base's memory, press **SPEAKER**. When you hear a dial tone, press **MEMORY** and enter the memory location number for the number you want to dial.

**Note:** If you select an empty memory location, the base beeps 5 times.

## CHAIN-DIALING SERVICE NUMBERS

For quick recall of numbers for special services (such as bank by phone), store each group of numbers in its own memory location. Dial the service's main number first. Then, at the appropriate place in the call, press **MEM** (or **MEMORY** on the base) and enter the number for the location where the additional information is stored.

## Testing Stored Emergency Numbers

If you store an emergency service's number (police department, fire department, ambulance) and you choose to test the stored number, make the test call during the late evening or early morning hours to avoid peak demand periods. Also, remain on the line to explain the reason for your call.



## CALLER ID OPERATION (HANDSET ONLY)

If you subscribe to Caller ID service from your phone company, the phone company sends information about the call, as well as the time and date, between the first and second rings of every call you receive. Although the Caller ID memory is on the handset, it records the call you receive on the speakerphone also.

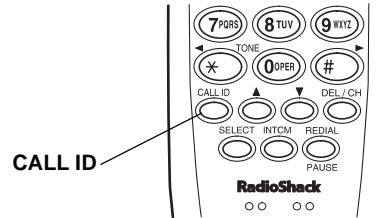

The TAD-729 displays this information when it receives a call, and it stores up to 50 Caller ID records for later review. It also shows if caller information is unavailable or if the name and number were blocked by the caller (see “Caller ID Messages”).

If you subscribe to Call Waiting with Caller ID, you will hear a tone through the handset when a call comes in, then the Caller ID record appears. If you want to answer the incoming call, press **FLASH**. To resume the previous phone conversation, press **FLASH** again.

If the TAD-729's Caller ID memory becomes full, any new call replaces the oldest call's record.

### REVIEWING CALLER ID RECORDS

To review the Caller ID records, lift the handset and press **CALL ID**. The number of new Caller ID records, if any, and the total number of records appears.

**Note:** If the handset is faceup on the base, it shows the number of Caller ID records, so you can see if you have new records to review.

Repeatedly press **▼** to scroll through the Caller ID records from the newest to the oldest, or **▲** to scroll back through the records. To scroll quickly through the records, hold down **▲** or **▼**.

When you scroll past the last record, **End** appears. When you scroll past the first record, the record totals appear.

The top line of each record shows the date, time and the number of calls from that number. The second line shows the caller's name, and the third line shows the caller's phone number.

### CALLER ID MESSAGES

Display	Description
<b>New: XX</b> <b>Total: XX</b>	Shows the number of new Caller ID records (records you have not reviewed) and the total number of records.
<b>Private Name</b> or <b>Private Number</b>	The caller has blocked the Caller ID information from being sent.

Display	Description
<b>Unknown Name</b> or <b>Unknown Number</b>	The caller is not within a Caller ID service.
<b>Incomplete Data</b>	Appears if there was an error during the transmission of Caller ID information. Minor electrical disturbances can affect Caller ID information. Occasional errors are normal. If the phone frequently displays <b>Incomplete Data</b> , contact your local telephone company or RadioShack store for assistance.
<b>End</b>	Appears when you scroll past the oldest Caller ID record.

## DIALING NUMBERS FROM A CALLER ID RECORD

To dial a local number stored in a Caller ID record, recall the record, then press **TALK**. If it is a long distance call, press **1** before you press **TALK**.

**Note:** If a Caller ID record does not contain a phone number (if it was blocked by the caller, for example) you cannot dial from that record.

## STORING A CALLER ID RECORD TO MEMORY

Follow these steps to store the name and number from a Caller ID record into a handset's memory location.

1. Recall the record you want to store, then press **MEM**. **Select Location** appears.
2. Choose a memory location (01–20) by pressing a number or by repeatedly pressing **▲** or **▼**, then press **SELECT**.

If the selected location is empty, the phone beeps to confirm that it stored the number, then the Caller ID record appears. If a record exists in the selected location, **Replace Memory?** appears, prompting you to confirm the replacement. Move the cursor to **Yes** or **No**, then press **SELECT**.

## DELETING CALLER ID RECORDS

You can delete Caller ID records individually or all at once.

To delete a single record, recall it, then press **DEL/CH**. **Delete Message?** appears, prompting you to confirm the deletion. Move the cursor to **Yes** or **No**, then press **SELECT** or **DEL/CH**.

---

To delete all the records at once, press **CALL ID** so the record totals appear, then press **DEL/CH**. **Delete All?** appears, prompting you to confirm the deletion. Move the cursor to **Yes** or **No**, then press **SELECT** or **DELETE**.

## TAD OPERATION

---

### SELECTING THE OUTGOING MESSAGE

The TAD has two prerecorded outgoing messages. One asks the caller to leave a message: "Hello, no one is available to take your call. Please leave a message after the tone." The TAD uses this message when **REC TIME** is set to **1** or **4** (see "Setting the Record Time"). The other is simply an announcement and does not let the caller leave a message: "Hello, no one is available to take your call." The TAD uses this message when **REC TIME** is set to **ANN** (announcement only).

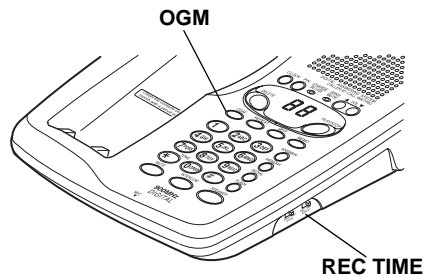

You can also record your own message (see "Recording/Deleting an Outgoing Message"). When you record your own outgoing message, the TAD uses it for all **REC TIME** settings.

To switch between your outgoing message and the TAD's prerecorded message, press **OGM**. When the current message begins to play, press **OGM** again. The TAD switches to the other message and plays it.

### RECORDING/DELETING AN OUTGOING MESSAGE

To record your outgoing message (up to 30 seconds long), hold down **OGM** until the TAD beeps and -- appears. When you finish your message, press **PLAY/STOP** or **OGM**. The TAD plays back your message.

To delete your outgoing message and use the TAD's prerecorded messages, hold down **OGM** until the TAD beeps. Then press **OGM** again within two seconds.

### SETTING THE RECORD TIME

Set **REC TIME** to **1**, **4**, or **ANN** to determine how the TAD-729 will record incoming messages.

**1** — The TAD plays the outgoing message and lets callers leave a message up to 1 minute long.

**4** — The TAD plays the outgoing message and lets callers leave a message up to 4 minutes long.

**ANN** (announcement only) — The TAD plays the outgoing message but does not let callers leave a message.

---

## SETTING THE TAD TO ANSWER CALLS

To set the TAD to answer calls, press **ANSWER**. If the TAD is set to record a caller's message (see "Setting the Record Time" on Page 28), it plays the outgoing message and shows the number of recorded messages. If the TAD is set to announcement-only, it plays the outgoing message, and **A** appears. To set the TAD to not answer calls, press **ANSWER**. The TAD announces, "Answer off" and the message counter turns off.

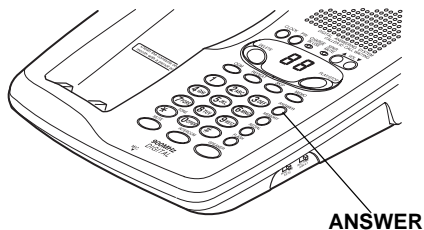

## SCREENING CALLS

You can let the TAD answer calls for you while you listen to the caller's message through the base's speaker (**Answering** appears on the handset's display). If you decide to answer the call, press **SPEAKER** to answer using the speakerphone, lift the handset (if necessary) and press **TALK** to answer. You can also pick up any phone on the same line. The TAD stops recording and resets to answer the next call.

## RECORDING INCOMING MESSAGES

After the TAD answers a call, it plays the outgoing message, beeps, and records the caller's message. The base's display shows --, and the handset's display shows **Answering**.

Each incoming message can be up to 1 or 4 minutes long, depending on how you set **REC TIME** (see "Setting the Record Time" on Page 28). The TAD-729's maximum recording capacity is 12 minutes.

The TAD stops recording and resets to answer the next call when:

- The caller hangs up.
- The maximum message length is reached.
- The TAD detects a busy signal or more than 7 seconds of silence.
- You pick up the TAD-729's handset or any phone on the same phone line.

**Note:** When the TAD's message memory is full, **FL** appears on the display and the TAD announces "No remaining time" when you try to operate it.

## RECORDING A MEMO

A memo is a message you can record at the TAD for yourself or others in your home or office. The TAD-729 stores memos as incoming messages ("Playing Messages" on Page 30).

---

To record a memo, hold down **MEMO** on the base until the TAD beeps and -- appears in the message counter window, then speak your message. When you finish the memo, press **PLAY/STOP** or **MEMO**.

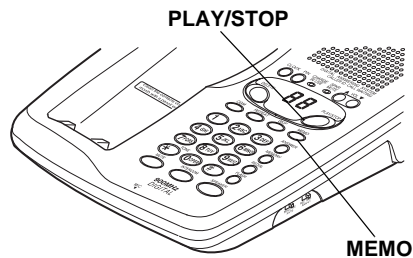

**Note:** The TAD-729 cannot record a memo less than two seconds long.

## RECORDING A CONVERSATION

The TAD-729 lets you record both sides of a telephone conversation when you are talking with the handset.

**Important Note:** It is illegal in some areas to record a conversation without the consent of all parties to the conversation, including the phone company. Check the laws in your area before you use the two-way recording feature.

To start recording a phone conversation, hold down **MEMO** on the base until the TAD beeps and -- appears.

To stop recording, press **PLAY/STOP** or **MEMO**. The TAD-729 stores a recorded conversation as a message (see "Playing Messages").

**Note:** The TAD-729 cannot record a conversation less than two seconds long, or a call using the speakerphone.

## PLAYING MESSAGES

After the TAD-729 has recorded a message, its message counter shows the total number of messages stored. If you have new messages, the number flashes. To play your messages, press **PLAY/STOP**. The TAD announces the number of new and old messages, then plays the new messages. The message number appears as each message plays, and the TAD announces the day and time of the call at the end of each message.

To play all messages after playing the new messages, press **PLAY/STOP** again. To skip to the next message, press **SKIP** during playback.

To replay the current message from the beginning, press **REPEAT**. If you press **REPEAT** within about 4 seconds after a message begins playing, the TAD replays the previous message.

---

## ADJUSTING THE TAD'S VOLUME

To adjust the speaker's volume, repeatedly press **VOL ▲** or **▼** on the base. The volume setting from **1** (lowest) to **10** (highest) appears in the message counter window.

## DELETING MESSAGES

To delete the current message while it is playing, hold down **DELETE** until the TAD beeps.

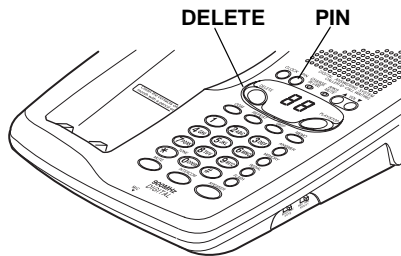

To delete all messages at once, while messages are not playing, hold down **DELETE** on the base until the TAD beeps and **0** appears in the message counter window.

**Note:** You cannot delete new (not yet played) messages. If you try to delete all messages at once while you still have new messages, the TAD sounds five quick beeps and does not delete any messages.

## SETTING THE REMOTE OPERATION PIN

The TAD-729's two-digit remote operation PIN (personal identification number) prevents unauthorized remote access to your messages. The PIN is preset to **80**.

Follow these steps to change the PIN to any number from **00** to **99**.

**Note:** If you wait more than 2 minutes between each keypress, the TAD exits the PIN setting process. Start again at Step 1.

1. Hold down **PIN** until the TAD beeps and **00** appears in the message counter window.
2. Press **SKIP** to set the first digit of the PIN higher or **REPEAT** to set it lower. Then press **PIN**.
3. Press **SKIP** or **REPEAT** to set the second digit of the PIN, then press **PIN**. The TAD announces the new PIN.

To check your PIN at any time, press **PIN**. The PIN appears in the message counter window, and the TAD announces it.

**Note:** If you press **SPEAKER** or **PLAY/STOP** while changing the PIN, the TAD exits. Begin again with Step 1.

## REMOTE OPERATION

---

While you are away from your home or office, you can use a touch-tone phone, or a pulse (rotary) phone with a pocket tone dialer (available through your local RadioShack store) to enter your PIN and do any of the following:

- Set the TAD to answer or not answer calls.
- Listen to your messages.
- Record a new outgoing message.
- Record a memo.
- Erase messages.

**Note:** You cannot remotely operate the TAD-729 using its handset or another telephone on the same line as the TAD.

## USING THE TOLL-SAVER

If **RING TIME** is set to **T/S** (toll-saver), (see "Setting the Number of Rings" on Page 13), the TAD-729 answers after three rings if you have new messages (ones you have not listened to). If there are no new messages, the TAD answers after five rings. This gives you time to hang up before the TAD answers so you can avoid unnecessary long-distance charges.

## USING REMOTE COMMANDS

Follow these steps to operate the TAD from a remote location.

**Note:** If you wait more than 15 seconds between each keypress, the TAD sounds a long beep and hangs up.

1. Dial your phone number and wait for the TAD to answer. If the TAD is not set to answer calls, it will answer after about 10 rings and sound a series of beeps.
2. When the outgoing message begins (or the TAD sounds a series of beeps), press #, then enter your PIN within 2 seconds.
3. If the PIN is correct, the TAD announces the day and time, then it announces the number of new and old messages. The TAD plays all new messages then beeps about once every two seconds to let you know it is ready to accept remote commands.

### Notes:

- If the TAD does not respond, try entering your PIN again. If you enter an incorrect PIN three times, the TAD beeps and hangs up.
- When the TAD is in remote operation, it stops all answering functions and the display on the base shows **rc**. The TAD resumes answering functions when it is no longer in remote command if you have not turned it off.
- When using remote operation, you can only delete the current message during playback. You cannot delete all the messages stored at one time.



- The maximum length of a memo recorded by remote operation is 4 minutes.

To use a remote command, press # and (within 2 seconds) the number for the command you want.

**Note:** The remote operation stops when someone picks up the handset or any phone on the same phone line.

When playback of the incoming messages exceeds 4 minutes, the TAD once stops playback. To listen further, press # and 2 again.

Press # then:	To:
1	Repeat current message during playback.
2	Play messages.
3	Skip current message during playback.
4	Delete current message during playback.
5	Stop playback, recording, and room monitoring.
6	Set the TAD to answer calls. The TAD announces the current outgoing message.
7	Record a memo, or stop recording a memo.
8	Record or stop recording a new outgoing message.
9	Set the TAD to not answer calls. The TAD announces "Answer off."
*	Monitor the room where the TAD is located for 15 seconds.

## TROUBLESHOOTING

---

We do not expect you to have any problems with your TAD-729, but if you do, these suggestions might help.

Problem	Suggestion
Low volume or unusual sounds.	Someone has picked up another phone on the same line. Hang up the other phone.
Severe noise interference.	Press <b>DEL/CH</b> to change the channel.
	Keep the handset away from computers, remote control toys, wireless microphones, alarm systems, intercoms, room monitors, fluorescent lights, and electrical appliances.
	Move the handset to another location or turn off the source of interference.
The phone cannot be operated at a useful distance from the base because the signal becomes weak or noisy (handset's range has decreased).	Lift the base's antenna to a vertical position.
	Be sure neither antenna is touching a metal surface.
	Return the handset to the cradle, and recharge the battery pack. Replace the battery pack if necessary (see "Replacing the Battery Pack" on Page 37).
The phone does not work or works poorly.	Be sure the base's phone line cord and AC adapter are correctly and securely connected, and the battery pack is charged.
The handset battery pack does not charge.	Check the charging contacts on the handset and base. If they are dirty, clean them with a pencil eraser.
	Be sure the battery pack is connected correctly.
	Replace the battery pack.
The handset does not ring or receive a page.	Move the base away from other electrical devices and sources of noise.

Problem	Suggestion
The handset stops working or works poorly during a call.	Move the handset closer to the base.
	Lift the base's antenna to a vertical position.
	Be sure the battery pack is charged. (If the battery power is too low, it does not have enough power to light the display.)
	If the base loses power while the handset is away, the security access-protection code might change. Restore power to the base, then place the handset back on the base. The CHARGE/IN USE indicator lights, indicating that the code is set again.
	Check the charging contacts on the handset and base. If they are dirty, clean them with a pencil eraser.
The TAD does not answer calls.	Make sure the TAD is turned on.
	Make sure the AC adapter is properly connected.
	Check all phone line connections.
The TAD does not record callers' messages.	<b>REC TIME</b> is set to <b>ANN</b> (announcement only). Set it to 1 or 4.
	Delete messages if memory is full.
Low Battery flashes on the display every few seconds.	Be sure the battery pack is correctly connected.
You have an incoming call, but do not receive any Caller ID information.	Let the phone ring twice before you answer so the system has time to record the Caller ID information.
	Check that the system is correctly and securely connected.
	Call your phone company to verify that your Caller ID service is active.

If you still have problems, disconnect the TAD-729. If other phones on the same line work properly, the fault is in this phone or its installation. If you cannot find the problem, take your phone to your local RadioShack store for assistance.

## CARE AND MAINTENANCE

---

Your RadioShack RadioShack TAD-729 900 MHz Dual Keypad Cordless Speakerphone Digital Answering System is an example of superior design and craftsmanship. The following suggestions will help you care for your TAD-729 so you can enjoy it for years.



Keep the TAD-729 dry. If it gets wet, wipe it dry immediately. Liquids might contain minerals that can corrode the electronic circuits.



Use and store the TAD-729 only in normal temperature environments. Temperature extremes can shorten the life of electronic devices, damage batteries, and distort or melt plastic parts.



Keep the TAD-729 away from dust and dirt, which can cause premature wear of parts.



Handle the TAD-729 gently and carefully. Dropping it can damage circuit boards and cases and can cause the TAD-729 to work improperly.



Use only fresh batteries of the required size and recommended type. Batteries can leak chemicals that damage your TAD-729's electronic parts.



Wipe the TAD-729 with a damp cloth occasionally to keep it looking new. Do not use harsh chemicals, cleaning solvents, or strong detergents to clean the TAD-729.

Modifying or tampering with the TAD-729's internal components can cause a malfunction and might invalidate its warranty and void your FCC authorization to operate it. If your TAD-729 is not performing as it should, take it to your local RadioShack store for assistance. If the trouble is affecting the telephone lines, the phone company can ask you to disconnect your TAD-729 until you have resolved the problem.

---

## REPLACING THE BATTERY PACK

If you follow the instructions in “Connecting and Charging the Battery Pack” on Page 10, the battery pack should last about one year. If the battery pack does not hold a charge for more than 2 hours after an overnight charge, replace it with a new 3.6-volt, 600 mAh battery pack with a connector that fits the socket in the battery compartment. You can order a replacement battery pack through your local RadioShack store.

Install the new battery pack as described below, then charge it for about 24 hours (see “Connecting and Charging the Battery Pack” on Page 10).

**Note:** To avoid losing memory numbers, install and begin charging the new battery pack within 1 minute.

1. Press down and slide off the battery pack compartment cover.
2. Lift the battery pack out of the compartment, then gently pull on the battery connector to disconnect it.
3. Insert the new battery pack's connector into the socket in the compartment and place the battery pack into the compartment.
4. Replace the cover.

If you have trouble replacing the battery, take the TAD to your local RadioShack store for assistance.

### Cautions:

- You must use a replacement battery of the same size and type.
- Do not dispose of the battery in a fire because it might explode.
- Do not open or mutilate the battery.
- Be careful not to short the battery by touching the connector's pins with conducting materials, such as rings, bracelets, and keys. The battery pack or conductor might overheat and burn.

**Important:** The EPA certified RBRC<sup>®</sup> Battery Recycling Seal on the nickel-cadmium (Ni-Cd) battery indicates RadioShack is voluntarily participating in an industry program to collect and recycle these batteries at the end of their useful life, when taken out of service in the United States or Canada. The RBRC program provides a convenient alternative to placing used Ni-Cd batteries into the trash or the municipal waste stream, which may be illegal in your area. Please call 1-800-THE-SHACK (1-800-843-7422) for information on Ni-Cd battery recycling and disposal bans/restrictions in your area. RadioShack's involvement in this program is part of the company's commitment to preserving our environment and conserving our natural resources.



---

## THE FCC WANTS YOU TO KNOW

In the unlikely event that your phone causes problems on the phone line, the phone company can temporarily discontinue your service. If this happens, the phone company attempts to notify you in advance. If advance notice is not practical, the phone company notifies you as soon as possible and advises you of your right to file a complaint with the FCC.

Also, the phone company can make changes to its lines, equipment, operations, or procedures that could affect the operation of this telephone. The telephone company notifies you of these changes in advance, so you can take the necessary steps to prevent interruption of your telephone service.

Your phone might cause TV or radio interference even when it is operating properly. To determine whether your phone is causing the interference, turn off your phone. If the interference goes away, your phone is causing it. Try to eliminate the interference by:

- moving your phone away from the receiver
- connecting your phone to an AC outlet that is on a different electrical circuit from the receiver
- contacting your local RadioShack store for help

If you cannot eliminate the interference, the FCC requires that you stop using your phone.

Some cordless telephones operate on frequencies that might cause interference to nearby TVs and VCRs. To minimize or prevent such interference, the base of the cordless telephone should not be placed near or on top of a TV or VCR.

## LIGHTNING

Your telephone has built-in lightning protection to reduce the risk of damage from surges in telephone line and power line current. This lightning protection meets or exceeds FCC requirements. However, lightning striking the telephone or power lines can damage your telephone.

Lightning damage is not common. Nevertheless, if you live in an area that has severe electrical storms, we suggest that you unplug your phone during storms to reduce the possibility of damage.

## NOTES

---

### Limited One-Year Warranty

This product is warranted by RadioShack against manufacturing defects in material and workmanship under normal use for one (1) year from the date of purchase from RadioShack company-owned stores and authorized RadioShack franchisees and dealers. EXCEPT AS PROVIDED HEREIN, RadioShack MAKES NO EXPRESS WARRANTIES AND ANY IMPLIED WARRANTIES, INCLUDING THOSE OF MERCHANTABILITY AND FITNESS FOR A PARTICULAR PURPOSE, ARE LIMITED IN DURATION TO THE DURATION OF THE WRITTEN LIMITED WARRANTIES CONTAINED HEREIN. EXCEPT AS PROVIDED HEREIN, RadioShack SHALL HAVE NO LIABILITY OR RESPONSIBILITY TO CUSTOMER OR ANY OTHER PERSON OR ENTITY WITH RESPECT TO ANY LIABILITY, LOSS OR DAMAGE CAUSED DIRECTLY OR INDIRECTLY BY USE OR PERFORMANCE OF THE PRODUCT OR ARISING OUT OF ANY BREACH OF THIS WARRANTY, INCLUDING, BUT NOT LIMITED TO, ANY DAMAGES RESULTING FROM INCONVENIENCE, LOSS OF TIME, DATA, PROPERTY, REVENUE, OR PROFIT OR ANY INDIRECT, SPECIAL, INCIDENTAL, OR CONSEQUENTIAL DAMAGES, EVEN IF RadioShack HAS BEEN ADVISED OF THE POSSIBILITY OF SUCH DAMAGES.

Some states do not allow the limitations on how long an implied warranty lasts or the exclusion of incidental or consequential damages, so the above limitations or exclusions may not apply to you.

In the event of a product defect during the warranty period, take the product and the RadioShack sales receipt as proof of purchase date to any RadioShack store. RadioShack will, at its option, unless otherwise provided by law: (a) correct the defect by product repair without charge for parts and labor; (b) replace the product with one of the same or similar design; or (c) refund the purchase price. All replaced parts and products, and products on which a refund is made, become the property of RadioShack. New or reconditioned parts and products may be used in the performance of warranty service. Repaired or replaced parts and products are warranted for the remainder of the original warranty period. You will be charged for repair or replacement of the product made after the expiration of the warranty period.

This warranty does not cover: (a) damage or failure caused by or attributable to acts of God, abuse, accident, misuse, improper or abnormal usage, failure to follow instructions, improper installation or maintenance, alteration, lightning or other incidence of excess voltage or current; (b) any repairs other than those provided by a RadioShack Authorized Service Facility; (c) consumables such as fuses or batteries; (d) cosmetic damage; (e) transportation, shipping or insurance costs; or (f) costs of product removal, installation, set-up service adjustment or reinstallation.

This warranty gives you specific legal rights, and you may also have other rights which vary from state to state.

RadioShack Customer Relations, 200 Taylor Street, 6th Floor, Fort Worth, TX 76102

*We Service What We Sell*

04/99

**RadioShack Corporation  
Fort Worth, Texas 76102**

09A00

UCZZ01629ZA  
Printed in China



## Free Manuals Download Website

<http://myh66.com>

<http://usermanuals.us>

<http://www.somanuals.com>

<http://www.4manuals.cc>

<http://www.manual-lib.com>

<http://www.404manual.com>

<http://www.luxmanual.com>

<http://aubethermostatmanual.com>

Golf course search by state

<http://golfingnear.com>

Email search by domain

<http://emailbydomain.com>

Auto manuals search

<http://auto.somanuals.com>

TV manuals search

<http://tv.somanuals.com>