

iHome®

Model iP42
The Home System
For Your iPhone® or iPod®

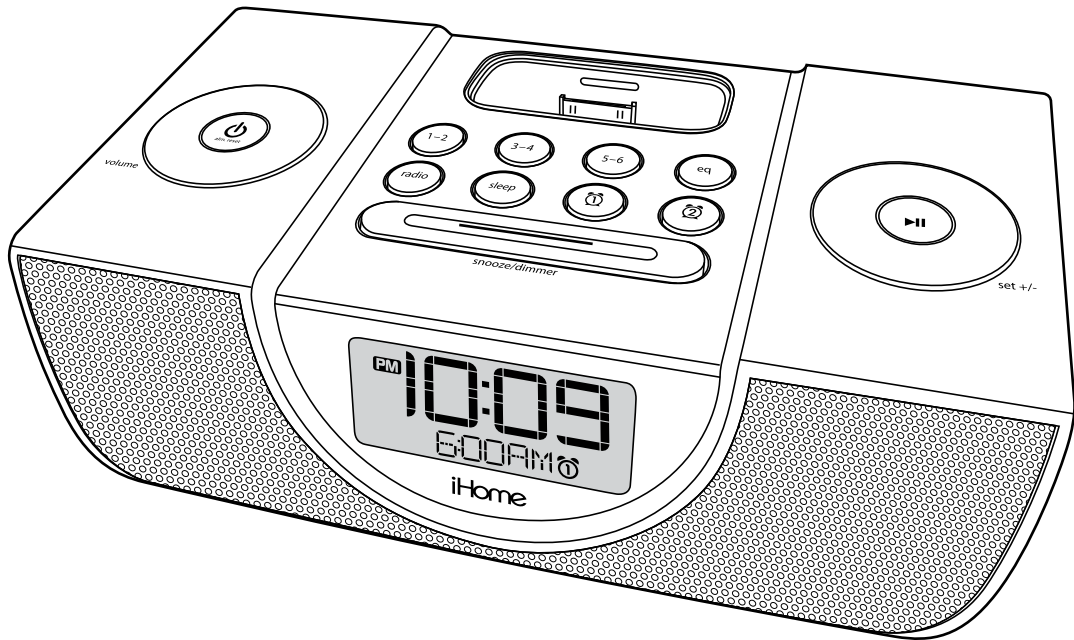

Questions? Visit www.ihomeaudio.com

Download from www.Somanuals.com. All Manuals Search And Download.

Table of Contents

Quick Start	1
Controls and Indicators	2
iP42 Display	2
Installing/Replacing iP42 Backup Batteries / Battery Warning	3
Setting Up the iP42	4
Using the iP42 Alarms.....	5-6
Listening to iPhone/iPod, Radio or Aux devices.....	6-7
Sleep mode, Dimmer and more.....	7
A Consumer Guide to Product Safety	8
Troubleshooting	9-10
Warranty Information	11

A Consumer Guide to Product Safety

This device complies with Part 15 of the FCC Rules. Operation is subject to the following two conditions: (1) This device may not cause harmful interference, and (2) this device must accept any interference received, including interference that may cause undesired operation.

This equipment complies with the limits for a Class B digital device as specified in Part 15 of FCC Rules. These limits provide reasonable protection against radio and TV interference in a residential area.

However, your equipment might cause TV or radio interference even when it is operating properly. To eliminate interference you can try one or more of the following corrective measures:

- Reorient or relocate the receiving antenna.
- Increase the distance between the equipment and the radio or TV.
- Use outlets on different electrical circuits for the equipment and the radio or TV.
- Consult your dealer or an experienced radio/television technician if the problem still exists.

Modifying or tampering with your system's internal components can cause a malfunction and might invalidate the system's warranty and void your FCC authorization to operate it.

This Class B digital apparatus complies with Canadian ICES-003.

Cet appareil numérique de la classe B est conforme à la norme NMB-003 du Canada.

Maintenance

- Place the unit on a level surface away from sources of direct sunlight or excessive heat.
- Protect your furniture when placing your unit on a natural wood and lacquered finish. A cloth or other protective material should be placed between it and the furniture.
- Clean your unit with a soft cloth moistened only with mild soap and water. Stronger cleaning agents, such as Benzene, thinner or similar materials can damage the surface of the unit.

iP42 Quick start

1: power

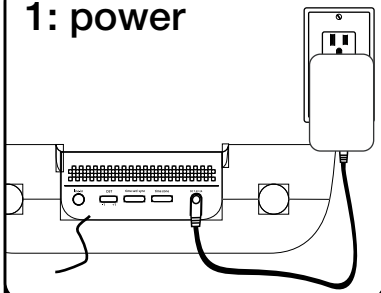

Attach AC adaptor cable to DC jack on back of the iP42 and plug the other end into a working outlet.

2: inserts

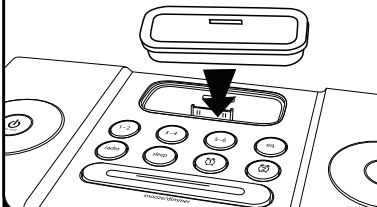

Select the dock insert for your iPhone or iPod® model from the table below and place insert in dock.

3: time sync



- Dock your iPhone
- Press the Time set/sync button on back of the unit.
- “SYNC OK” will flash on the display, indicating sync attempt
- Day and date will appear and you will hear a beep when sync is complete.
- If sync fails, attempt again or set time manually (see page 3).

Use this insert

iPhone 3G
insert 15

iPod touch 2G
insert 16

nano 5G
insert 18

For this iPhone / iPod

iPhone 3G/3GS

iPod touch 2G

nano 5G

4: iPhone/ iPod

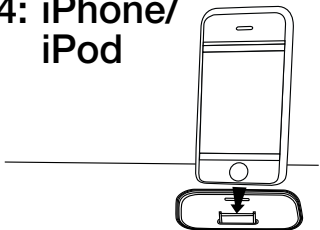

Gently dock an iPhone or iPod into the dock with proper insert (iPhone/iPod must not be in a skin or case). The iPhone/iPod will charge while docked. Press the **▶▶** Button to play your iPhone/iPod.

5: radio



- Press the Radio button to select FM radio mode.
- Turn the Set Wheel to select a station.
- See page 4 for programming presets.

NOTE: If you do not have an insert for your iPhone/iPod, please visit www.ihomeaudio.com or call iHome toll free at 800-288-2792 to purchase one.

Controls and Indicators

Top Panel

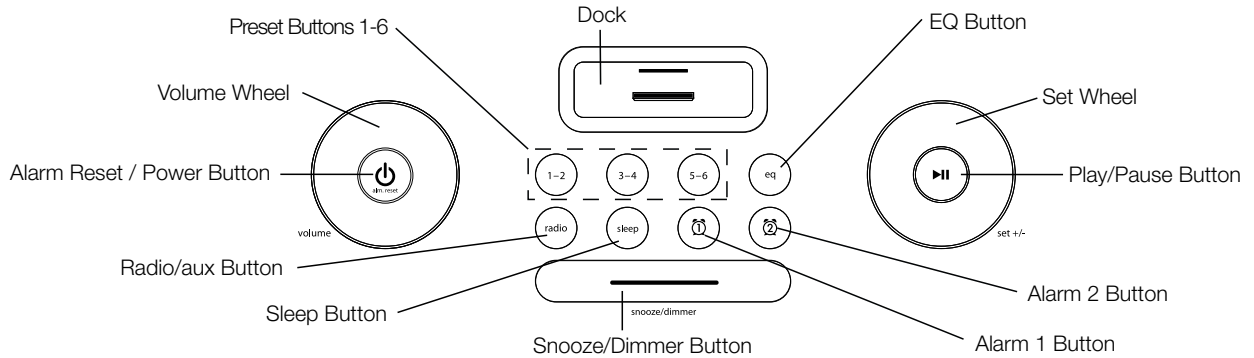

Rear Panel

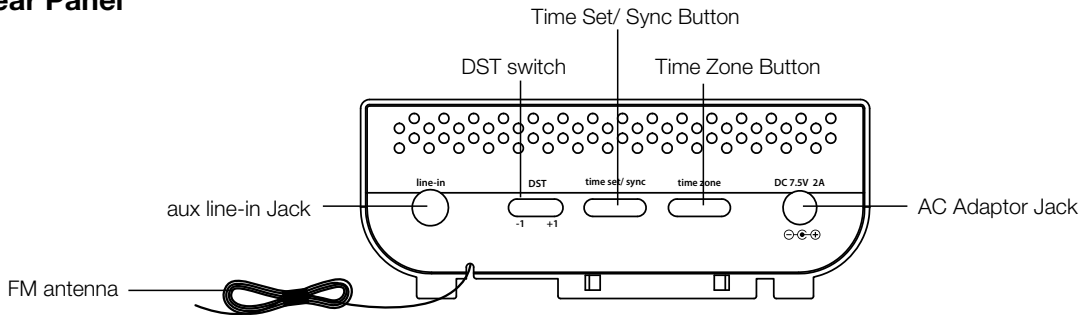

iP42 Display

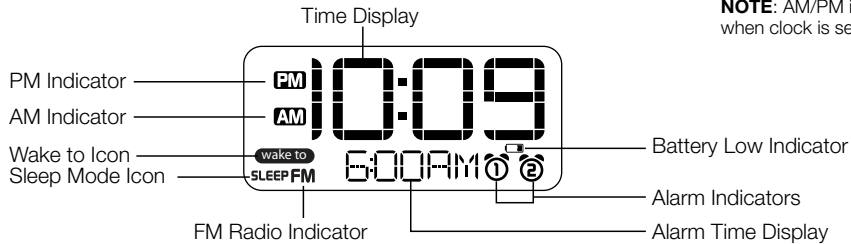

NOTE: AM/PM indicators will not appear when clock is set to 24 hour display mode

Installing/Replacing the iP42 Backup Batteries

The iP42 uses “AA” LR06 batteries (pre-installed) for backup battery system to provide continuous alarm operation and clock settings in the event of a power failure. If the Battery Low Icon located on the right of the display is flashing, it is time to replace the backup batteries. Please make sure the AC adaptor is connected, otherwise all settings may be lost during battery replacement.

1. Open the battery compartment cover located on the bottom of the unit
2. Insert 2 “AA” (LR06) batteries as indicated, making sure that the + and – polarities match the diagram inside.
3. Replace battery compartment cover.

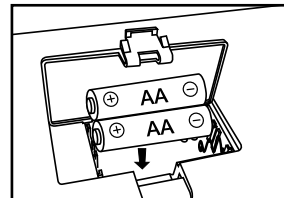

We recommend alkaline batteries for longer battery life.

Battery Warning

For models that require more than one battery

- Do not mix with used or other battery types/brands
- Replace all batteries at the same time
- Do not open batteries
- Do not dispose of in fire
- Do not heat above 75°C (167°F)
- Do not expose contents to water
- Do not charge or recharge
- Do not install backwards

Setting Up the iP42

Connect iP42 to Power Source

Plug the AC adaptor cable into the AC Adaptor Jack and the other end into a standard 120V AC wall socket. Adaptor must be plugged in to operate unit. **The iP42 does not operate on batteries** (a battery back up system maintains clock settings during power failures).

This unit is a preset clock: the clock is preset at the factory. It's simple to match the Time Zone setting to your location (US only).

1. Depending on your location and whether or not Daylight Saving Time (DST) is in effect, manually set the **DST Switch** located at the back of the unit to +1 to add an hour or to -1 to subtract an hour. A DST adjust screen appears briefly.
2. Press and hold the **Time Zone Button** located on the back of the unit until the Time Zone flashes on the lower part of the display. Turn the **Set Wheel** to select your time zone. **Note:** Time Zone is disabled when clock display is set to 24 hours (see step 5 under Setting Time).
3. Press the **Time Zone Button** again (or no button within 10 seconds) to exit the time zone setting mode.
4. If the displayed time is not correct, please see "Setting Time and Calendar manually" section below.



Sync Time to iPhone/iPod

The iP42 Time Sync feature allows you to sync the time setting on the iP42 to the time from your iPhone or recent model iPod Touch, iPod Nano and iPod Classic (older iPod models such as iPod mini do not support this feature).

1. Dock your iPhone or iPod
2. Press the **Time Sync Button** located at the back of the unit.
3. The iP42 will sync to the time on your iPhone/iPod. Once sync is completed, "SYNC OK" will appear on the display.
4. If sync was not successful, "Failed" will appear on the display. If this happens, please try again, with a different iPhone/iPod if needed. If time sync still fails, please set time manually (see below).

NOTE: The iPhone is constantly updated to current time via cell phone towers. The time on your iPod is only accurate to the last time it was synced to a computer. It's possible to have up to 59 seconds difference between the iP42 and synced iPhone/iPod.



Setting Time and Calendar manually

1. Press and hold the **Time set/sync Button** located at the back of the unit until the time flashes on the display.
2. Turn the **Set Wheel** to the correct time. Remember to set the correct AM or PM time. The **AM/PM Indicators** appear to the left of the time display (except when clock display is set to 24 hour mode-- see step 5).
3. Press the **Time set/sync button** again. The year will flash. Turn the **Set Wheel** until the current year is displayed.
4. Press the **Time set/sync button** again. The month and date will flash. Turn the **Set Wheel** until the current month/date is displayed.
5. During Time set, press either the  or  button to toggle the clock display format to 12 hours or 24 hours.
6. Press the **Time set/sync button** again (or no button within 10 seconds) to exit the time/calendar setting mode.

Using the Alarms

iP42 has a dual alarm system so you can set two separate alarms to different alarm times, wake-to sources and frequencies (daily, weekdays or weekend).

Setting the Alarms

1. Press and hold the  or  **Button** until the alarm time flashes on the lower part of the display. Turn the **Set Wheel** to set the alarm time. Remember to set the correct AM or PM time.
2. Press the **Alarm Button** again to confirm the desired alarm time and then turn the **Set Wheel** to set the alarm frequency (7 = the whole week, 5 = weekdays, 2 = weekends only).
3. Press the **Alarm Button** again to confirm alarm frequency then turn the **Set Wheel** to select an alarm source to wake to: Buzzer, Playlist (user created), iPhone/iPod or Radio.

NOTE: to wake to playlist, you must first create a playlist named "iHome". The iP42 will play music randomly from within the "iHome" playlist.

If the selected alarm source is iPhone/iPod and no iPhone/iPod is docked/detected, the iP42 will default to a buzzer alarm.

4. **For wake to radio**, after selecting Radio as wake to source, press the **Alarm Button** again and turn the **Set Wheel** to select a different radio station or press one of the preset buttons to wake to a preset radio station (see *Using Radio* on page 6 for details on setting radio stations and presets).
5. Press the **Alarm button** again (or no button within 10 seconds) to exit the alarm setting mode. The alarm will be armed once set and the corresponding alarm icon will light up. The lower part of the display will show the earliest set alarm time.

Reviewing, Arming and Disarming Alarm (Turn Alarm Function On and Off)

1. Once an alarm is armed, the lower part of the display will show the alarm time and the alarm icon. If more than one alarm is armed, the earliest alarm time will show along with both icons.
2. To review the alarm time, press an alarm button once. The related alarm time will show on the lower part of the display.
3. During alarm review, press the alarm button once to toggle it on or off. If the alarm is armed, the related alarm icon will light up.

Resetting the Alarm to Come on the Next Day

When an alarm is sounding, press the  **Button** to stop the alarm and reset it to come on the next set day. For example, if an alarm is set for 5 days and you press the alarm reset on Friday, the alarm will come on again on Monday, not Saturday.

Snooze Operation

1. Press and hold the **Snooze/Dimmer Button** for a few seconds until the snooze time flashes. Turn the **Set Wheel** to set the snooze timer from 1 to 29 minutes.
2. Press the **Snooze/Dimmer Button** after an alarm sounds. The alarm will be silenced for the set snooze duration time then sound again. Snooze can be pressed several times during the 1 hour alarm cycle.

Using the iP42 Alarms

Sure Alarm

The iP42 has a sure alarm feature. If backup batteries are installed, the buzzer alarm will still sound in the event of a power failure.

Listening to iPhone/iPod, Radio

Charging your iPhone/Pod

Note: Please make sure you are using the correct insert for your iPhone/iPod and that it is properly docked into the iP42. Failure to do so may damage your iPhone/iPod.

While an iPhone/iPod is docked in the unit and the unit is connected to AC power, it recharges until fully charged.

Listening to iPhone/iPod

1. Dock an already-playing iPhone/iPod in the dock. The iP42 will automatically turn on and you will hear the audio playing from your iPhone/iPod.

Note: If the playing song/music loudness is too low on the iPod itself, the iP42 may not detect iPod is in play mode. Press the **▶|| Button** to play it.

2. When an iPhone/iPod is docked and in standby mode, press the **▶|| Button** to play it. "iPod" will appear briefly in the lower part of the display to show iPod is currently in play mode.
3. Press the **▶|| Button** again to pause play; press again to resume it.
4. Turn the **Volume Wheel** to adjust the system volume.
5. Press the **EQ Button** to select and turn the **Set Wheel** to adjust Treble, Bass, and Left/Right Balance.
6. To turn off the unit, press the **⏻ Button**. An iPhone/iPod will continue charging while docked.

Listening to Radio

Setting up Antenna

Extend FM wire antenna fully for best reception. Do not strip, alter or attach to other antennas.

Tuning and Playing the Radio

1. Press the **Radio Button** as needed to turn on iP42 and choose between FM radio and aux line-in modes.
2. When FM radio mode is selected, turn the **Set Wheel** to tune the radio to a desired station. The current radio frequency appears in the lower right of the display.
3. **To memorize a station as a preset**, use the **Set Wheel** to select your station. Press and hold the desired **Preset Button** until odd number preset (P1, etc) flashes on display; press again for even number presets and allow to time-out. You will hear 2 beeps confirming the preset has been assigned.
4. **To access a preset station**, press the desired **Preset Button** once (for odd number presets) or twice (for even number presets).
5. Turn the **Volume Wheel** to adjust the system volume.
6. Press the **EQ Button** to select and turn the **Set Wheel** to adjust Treble, Bass, and Left/Right Balance.
7. To turn off the unit, press the **⏻ Button**. An iPhone/iPod will continue charging while docked.

Listening to Aux device

Using the aux line-in Jack

You can play any iPod or other MP3 player or portable audio device through the iP42 via the aux line-in Jack.

1. Plug one end of a standard stereo audio patch cord (not included) into the headphone or line-out jack on your device and the other end of the patch cord into the iP42 aux line-in Jack located on the back of the unit.
2. Press the **Radio Button** until “aux” appears in the lower part of the display.
3. Turn on and play your device.
4. Turn the **Volume Wheel** to adjust the iP42 volume. You may need to adjust volume on your audio device, too.
5. Press the **EQ Button** to select and turn the **Set Wheel** to set Treble, Bass, and Left/Right Balance.
6. To turn off the unit, press the **⏻ Button**. Please remember to turn off your device, too.

Sleep mode, Dimmer and more

Sleep Operation

Sleep mode lets you sleep to your iPhone/Pod or radio, gradually lowering the volume until the unit shuts off at the selected time.

1. Press the **Sleep Button** to enter sleep mode. The sleep time will show in the lower display.
2. Press the **Sleep Button** again as needed to adjust the sleep timer from 120, 90, 60, 30 or 15 minutes.
3. When the display changes back to show the real time, press the **Sleep Button** once to show the sleep time remaining. Pressing it again will change sleep time to next lowest increment.
4. iP42 has independent volume setting for sleep mode so you can adjust the sleeping volume without affecting the normal volume. The sleep volume will remain at that level the next time you enter sleep mode until controls are changed.
5. To stop listening at any time, press the **⏻ Button** to turn unit off.

Dimmer Operation

During normal operation, press the **Snooze/Dimmer Button** to control the brightness of the LCD display.

Using the iP42 in Other Countries

Different regions of the world use different FM radio frequency steps and ranges. You will need to select the one that matches the standards in your region (USA, EUROPE, JAPAN, AUSTRALIA, or CHINA). The default setting is USA; if you live in the US, you may skip this section.

1. Make sure the iP42 is OFF (not playing in any mode). Press and hold the **Radio Button** for about 5 seconds until “USA” appears in the lower part of display. Tune the **Set Wheel** to adjust country frequency to your region.
2. Press the **Radio Button** again (or no button within 5 seconds) to exit the radio frequency setting mode.

IMPORTANT SAFETY INSTRUCTIONS

When used in the directed manner, this unit has been designed and manufactured to ensure your personal safety. However, improper use can result in potential electrical shock or fire hazards. Please read all safety and operating instructions carefully before installation and use, and keep these instructions handy for future reference. Take special note of all warnings listed in these instructions and on the unit.

1. **Water and Moisture** – The unit should not be used near water. For example: near a bathtub, washbowl, kitchen sink, laundry tub, swimming pool or in a wet basement.
2. **Ventilation** – The unit should be situated so that its location or position does not interfere with its proper ventilation. For example, it should not be situated on a bed, sofa, rug or similar surface that may block ventilation openings. Also, it should not be placed in a built-in installation, such as a bookcase or cabinet, which may impede the flow of air through the ventilation openings.
3. **Heat** – The unit should be situated away from heat sources such as radiators, heat registers, stoves or other appliances (including amplifiers) that produce heat.
4. **Power Sources** – The unit should be connected to a power supply only of the type described in the operating instructions or as marked on the appliance.
5. **Power-Cable Protection** – Power supply cables should be routed so that they are not likely to be walked on or pinched by items placed upon or against them. It is always best to have a clear area from where the cable exits the unit to where it is plugged into an AC socket.
6. **Cleaning** – The unit should be cleaned only as recommended. See the Maintenance section of this manual for cleaning instructions.
7. **Objects and Liquid Entry** – Care should be taken so that objects do not fall and liquids are not spilled into any openings or vents located on the product.
8. **Attachments** – Do not use attachments not recommended by the product manufacturer.
9. **Lightning and Power Surge Protection** – Unplug the unit from the wall socket and disconnect the antenna or cable system during a lightning storm or when it is left unattended and unused for long periods of time. This will prevent damage to the product due to lightning and power-line surges.
10. **Overloading** – Do not overload wall sockets, extension cords, or integral convenience receptacles as this can result in a risk of fire or electric shock.
11. **Damage Requiring Service** – The unit should be serviced by qualified service personnel when:
 - A. the power supply cable or plug has been damaged.
 - B. objects have fallen into or liquid has been spilled into the enclosure.
 - C. the unit has been exposed to rain.
 - D. the unit has been dropped or the enclosure damaged.
 - E. the unit exhibits a marked change in performance or does not operate normally.
12. **Antenna** – Do not connect an external antenna to the unit (other than that provided).
13. **Periods of Nonuse** – If the unit is to be left unused for an extended period of time, such as a month or longer, the power cable should be unplugged from the unit to prevent damage or corrosion.
14. **Servicing** – The user should not attempt to service the unit beyond those methods described in the user's operating instructions. Service methods not covered in the operating instructions should be referred to qualified service personnel.

Questions? Visit www.ihomeaudio.com

Troubleshooting

Symptom	Possible Problem	Solution
iP42 does not turn on	AC adaptor isn't plugged into a working wall socket or not plugged into the power supply jack on back of the unit	Plug the AC adaptor into a working wall socket and plug the connector into the supply jack on the unit
iP42 doesn't respond	iP42 requires a reset	If unit is plugged in and doesn't respond, try resetting the unit by following these steps: a) remove iPhone/iPod from dock b) unplug unit from power source c) remove back up batteries d) wait a few minutes, then resume use
	iPhone/iPod is not docked properly	Remove your iPhone/iPod from the dock and check for obstruction on the connectors in the dock and on your iPhone/iPod. Then reseat it in the dock.
Battery Low icon always flashing	Batteries are weak	Replace with new batteries
	Batteries were not installed properly	Check to make sure the polarity (+ and – ends) matches the diagram in the battery compartment
iPhone/iPod does not respond to the unit/iPod is playing but no sound comes out	iPhone/iPod is not docked properly	Remove your iPhone/iPod from the dock and check for obstruction on the connectors in the dock and on your iPhone/iPod. Then reseat it in the dock.
	Your iPhone/iPod software is too old	Upgrade software on your iPhone/iPod via iTunes on your computer
	iPhone/iPod is locked up/plays but no sound comes out	Check the volume setting. Make sure your iPhone/iPod is working properly before docking into the unit. Please refer to your iPhone/iPod manual for details. See above for software upgrade information. You may need to reset your iPhone/iPod. Refer to your iPhone or iPod user guide for details on how to perform a reset.
	Using 1 st or 2 nd generation iPod, iPod Shuffle or other devices.	iP42 cannot control those iPod models or other devices.
iP42/iPhone/iPod performance is erratic	The iP42 is reacting to external interference	Move unit away from potential sources of external interference such as computers, modems, wireless devices (routers) or fluorescent light.
No sound from iP42	Volume is set too low on iP42	Make sure volume is turned up
iPhone/iPod didn't charge up	iPhone/iPod is not installed properly	Remove your iPhone/iPod from the dock and check for obstruction on the connectors in the dock and on your iPhone/iPod. Then reseat it in the dock.
	iPhone/iPod is locked up/ frozen	Please make sure your iPhone/iPod is working properly before docking into the unit. Please refer to your iPhone/iPod manual for details.
	iPhone/iPod battery has problem	

Troubleshooting

Symptom	Possible Problem	Solution
Sound is distorted	Volume level is set too high	Decrease the volume
	Sound source is distorted	If the iPhone/iPod original sound source (MP3) is old or of poor quality, distortion and noise are easily noticed with high-power speakers. Try a different audio source such as a music CD through the line-in jack. If you are using an external sound source like older generation of iPod or iPod Shuffle, try reducing the output volume on the device itself. Also try turning bass boost OFF.
	EQ settings are too high.	Lower EQ settings.
Unit/adaptor gets warm after extended play at high volume	This is normal	Turn unit off for a while or lower volume
Snooze time is too long/short	Custom snooze time not set	Press and hold Snooze button then turn Set Wheel to adjust
Alarm not working	AM/PM time/alarm time not set correctly	When setting clock or alarm time, take note of the AM/PM indicators
	Alarm time or source selected for alarm 2 or alarm 3, not alarm 1, etc.	Make sure to set the alarm time and source for the alarm icon 1, 2 or 3 that is shown on the clock display
	7-5-2 days setting is not correct	7 days is every day alarm, 5 days is Mon-Fri, and 2 days is Sat-Sun. See page 5 for setting alarms.
	Calendar is not set correctly, which can affect 7/5/2 day alarm operation	See page 4 for Time/Calendar setting section.
Time sync didn't work	Older iPod models such as iPod mini do not support time sync function	Make sure you are using an iPhone or newer iPod such as touch, nano or classic. If not available, set time manually (see page 4).

Limited 1 Year Warranty Information

iHome Products, a division of SDI Technologies Inc. (hereafter referred to as SDI Technologies), warrants this product to be free from defects in workmanship and materials, under normal use and conditions, for a period of 1 Year from the date of original purchase.

Should this product fail to function in a satisfactory manner, it is best to first return it to the store where it was originally purchased. Should this fail to resolve the matter and service still be required by reason of any defect or malfunction during the warranty period, SDI Technologies will repair or, at its discretion, replace this product without charge (except for a \$15.00 charge for handling, packing, return UPS/postage, and insurance). This decision is subject to verification of the defect or malfunction upon delivery of this product to the Factory Service Center listed below. The product must include proof of purchase, including date of purchase. The fee for service without proof of purchase is \$30.00.

Before returning this product for service, please first replace the batteries (if applicable) with fresh ones, as exhausted or defective batteries are the most common cause of problems encountered.

If service is still required:

1. Remove the batteries (if applicable) and pack the unit in a well padded, heavy corrugated box.
2. Enclose a photocopy of your sales receipt, credit card statement, or other proof of the date of purchase, if within the warranty period.
3. Enclose a check or money order payable to the order of SDI Technologies, for the sum of \$15.00 (\$30.00 without proof of purchase).
4. Send the unit prepaid and insured, to the Factory Service Center listed below.

Consumer Repair Department
SDI Technologies Inc.
1330 Goodyear Dr.
El Paso, TX 79936-6420

Disclaimer of Warranty

NOTE: This warranty is valid only if the product is used for the purpose for which it was designed. It does not cover (i) products which have been damaged by negligence or willful actions, misuse or accident, or which have been modified or repaired by unauthorized persons; (ii) cracked or broken cabinets, or units damaged by excessive heat; (iii) damage to digital media players, CD's or tape cassettes (if applicable); (iv) the cost of shipping this product to the Factory Service Center and its return to the owner.

This warranty is valid only in the United States of America and does not extend to owners of the product other than to the original purchaser. In no event will SDI Technologies or any of its affiliates, contractors, resellers, their officers, directors, shareholders, members or agents be liable to you or any third party for any consequential or incidental damages, any lost profits, actual, exemplary or punitive damages. (Some states do not allow limitations on implied warranties or exclusion of consequential damages, so these restrictions may not apply to you.) This warranty gives you specific legal rights, and you may also have other rights which vary from state to state.

Your acknowledgment and agreement to fully and completely abide by the above mentioned disclaimer of warranty is contractually binding to you upon your transfer of currency (money order, cashier's check, or credit card) for purchase of your SDI Technologies product.

Questions? Visit www.ihomeaudio.com

Toll Free Customer Service: 1-800-288-2792

Free Manuals Download Website

<http://myh66.com>

<http://usermanuals.us>

<http://www.somanuals.com>

<http://www.4manuals.cc>

<http://www.manual-lib.com>

<http://www.404manual.com>

<http://www.luxmanual.com>

<http://aubethermostatmanual.com>

Golf course search by state

<http://golfingnear.com>

Email search by domain

<http://emailbydomain.com>

Auto manuals search

<http://auto.somanuals.com>

TV manuals search

<http://tv.somanuals.com>