

Owner's Operation Manual



Important:

Read and understand all safety information before operating.

AquaSEALTM AS-1600
Liquid Laminator

Preface

This manual contains the following Sections:

Section 1. Introduction – provides a basic overview of the *AquaSEAL™* AS-1600 liquid laminator, and contains illustrations of the basic hardware components.

Section 2. Operating Procedures – describes procedures for setting up, starting, stopping, and controlling the machine.

Section 3. Troubleshooting/Miscellaneous – describes problems that may be encountered and lists corrective actions to resolve them. Information on who to call for after sales support.

Table of Contents

General

Warranty Statement	3
Safety Information	4-5
Safety Labels	5

Section 1. Introduction

Hardware Overview	6-10
-------------------------	------

Section 2. Operating Procedures

Tools / Supplies Needed	11
Loading the Sealant	11
Loading the Media.....	11
Pre-heat the Laminator	12
Web the Laminator.....	13
Run the Laminator	14-15
Cleaning the Laminator.....	16

Section 3. Troubleshooting/Miscellaneous

Troubleshooting	17
After Sales Support.....	19

Warranty

SEAL® Graphics warrants to the original consumer purchaser that each new SEAL® Image® Laminator, which proves defective in materials or workmanship within the applicable warranty period, will be repaired or, at our option, replaced without charge.

Effective November 1st, 2002 the applicable warranty period for New Equipment shall be one year (parts), six months (labor and rollers) from date of purchase.

This warranty extends to and is enforceable by only the original consumer purchaser, and only for the period (during the applicable term), which the product remains in the possession of the original consumer purchaser. "Original consumer purchaser" means the person who first purchased the product covered by this warranty other than for purpose of resale. This warranty does not apply if it is found that at any time the equipment has not been used for its intended purpose.

Effective November 1st, 2002 the applicable warranty period for Refurbished Equipment shall be ninety days (parts and labor, excluding rollers). Rollers are not covered under warranty. The applicable warranty period for Demo Equipment shall vary, not exceeding the maximum warranty period stated herein. All Demo Equipment comes with a specific warranty, which will be stated at the time of purchase. If warranty period is not detailed in writing, there is no remaining warranty.

Please ask your dealer, distributor, or sales representative for details.

NOTE: Used and Not Refurbished Equipment is sold on an "AS IS" basis with No Warranty.

For more information regarding this warranty, please contact your distributor.

WARNING! Any unauthorized changes or modifications to this unit without our prior written approval will void the user's warranty and will transfer health and safety obligations to the user.

WARNING! Changes or modifications to this unit not expressly approved by the party responsible for compliance could void the user's authority to operate the equipment

NOTE: This equipment has been tested and found to comply with the limits for a class A digital device, pursuant to part 15 of the FCC rules. These limits are designed to provide reasonable protection against harmful interference when the equipment is operated in a commercial environment. This equipment generates uses and can radiate radio frequency energy and, if not installed and used in accordance with Owner's Manual, may cause harmful interference to radio communications. Operation of this equipment in a residential area is likely to cause harmful interference in which case the user will be required to correct the interference at their own expense.

©Copyright SEAL® Graphics 2002

All rights are reserved. No part of the document may be photocopied, reproduced, or translated to another language without the prior written consent of SEAL Graphics.

The information contained in this document is subject to change without notice and should not be construed as a commitment by SEAL Graphics.

SEAL Graphics assumes no responsibility for any errors that may appear in this document. Nor does it make expressed or implied warranty of any kind with regard to this material, including, but not limited to, the implied warranties of merchantability and fitness for a particular purpose.

SEAL Graphics shall not be liable for incidental or consequential damages in connection with, or arising out of the furnishing, performance, or use of this document and the program material, which it describes.

Trademarks Credits

SEAL® is a registered trademark of SEAL Graphics.

Image® is a registered trademark of SEAL Graphics.

AquaSEAL® is a registered trademark of SEAL Graphics.

ProSEAL® is a registered trademark of SEAL Graphics.

Safety Information

Intended Use

The *AquaSEAL™ AS-1600* liquid laminator is intended for use with medium and large format graphic output. Graphics can vary in widths up to 1.6M (5 ft.) in width and can be up to 90M (295 ft.) in length (dependent on thickness of media used). The *AquaSEAL™ AS-1600* liquid laminator is intended for use with *AquaSEAL™ water based sealant only*. Use of solvent-based or other manufacturers sealants may damage the machine and may void any warranty.

Safety Instructions

Caution

When handling any chemical products, read the manufacturers' container labels and the Material Safety Data Sheets (MSDS) for important health, safety, and environmental information.

To obtain MSDS Sheets for *AquaSEAL™* Products, Please call your local distributor.

In case of emergency, please telephone: +44 (0)1268 530 331 Europe, or (800) 486-6502 USA

When using any equipment, always follow the manufacturers' instructions for safe operation.

Warning

Avoid contact with heat source during use. Wear heat resistant gloves and safety glasses. Failure to avoid contact with hot surfaces may cause burns. Always observe manufacturers recommendations when handling chemicals.

Safety Information

General

- ❑ Do not operate the machine until it is connected to the proper power source. Refer to Installation instructions located inside control cabinet.
- ❑ It is strongly recommended that the machine is fed from an “Earth Leakage” protected electrical outlet – if in doubt, please contact Hunt Technical Services (contact details in “Miscellaneous” section at the rear of the manual) or consult a licensed electrician.
- ❑ Familiarize yourself with the layout of the Control Panel, and with the operation of the sealant delivery system.
- ❑ Do not wear loose clothing, and contain loose hair to avoid becoming entangled with moving parts of the machine.
- ❑ Comply with all safety warning signs, labels, and instructions.
- ❑ Operators should be trained on the proper use of the machine and all safety procedures.
- ❑ Provide fresh water, clean towels and rubber gloves for use during cleanup.
- ❑ It is advisable to wear eye protection when filling/emptying sealant tank. Always Provide an approved emergency eyewash station adjacent to the machine.

Figure 1 shows the safety labels that appear on the *AquaSEAL™ AS-1600*.



Figure 1. Safety Labels

Section 1. Introduction

The *AquaSEAL™ AS-1600* is a medium to large format media liquid laminator used to coat graphics with a protective sealant. Operating roll to roll, the media is threaded under the applicator mechanism, under the drying assembly, and onto the take-up roller. During operation, the liquid laminator applies sealant onto the printed graphics and then cures and dries it before winding the media onto the take-up core.

Hardware Overview

Figure 1.1 shows the front view of the liquid laminator. Major components (safety items shown in red) include the following:

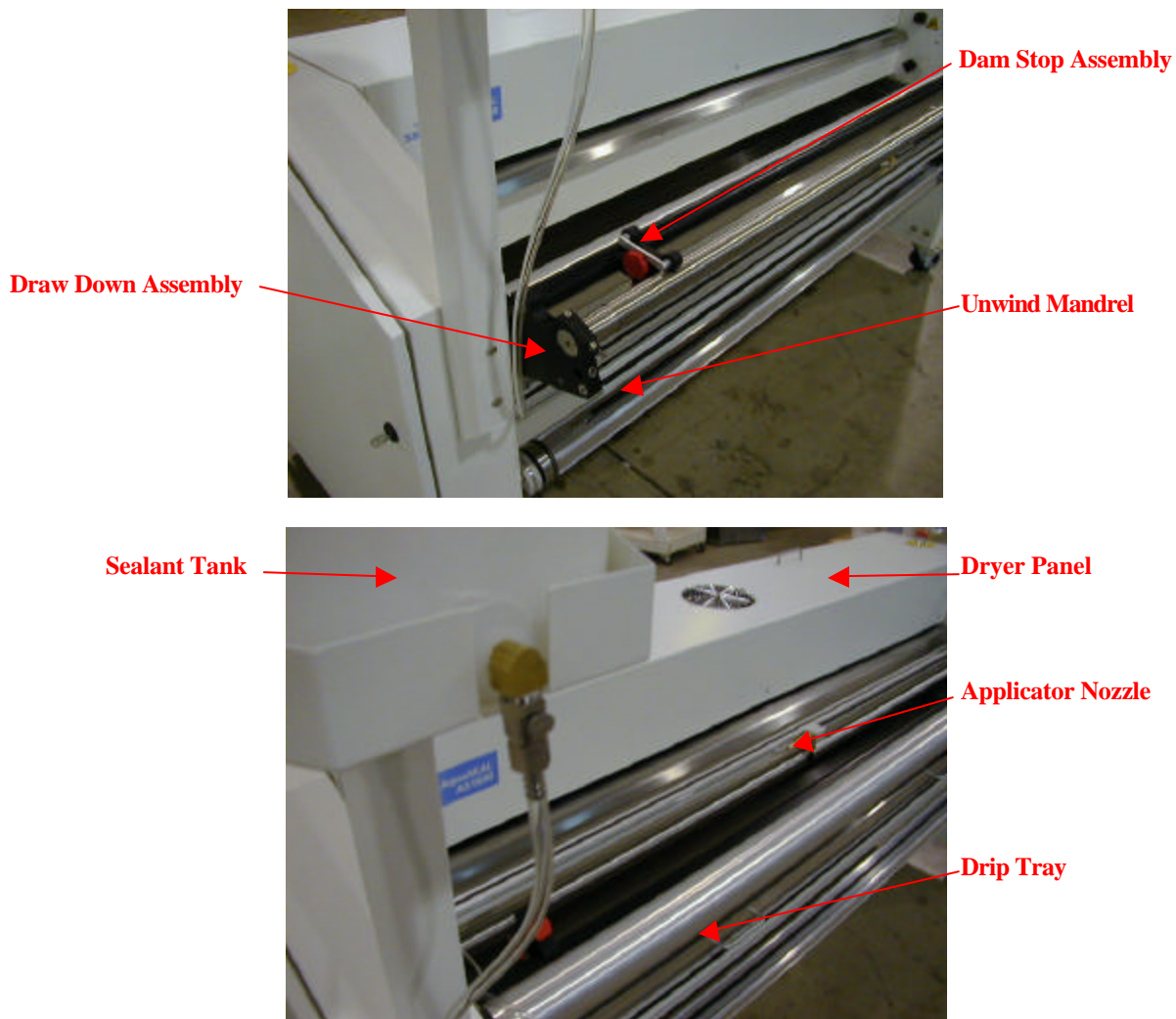

Figure 1.1 *AquaSEAL™ AS-1600* Liquid Laminator Front Views

Section 1. Introduction

Hardware Overview (continued)

- ❑ Two **Emergency Stop Buttons** are fitted to the machine, located prominently on top of both end cabinets. When pressed, all power is removed from the working parts of the machine. The machine cannot be used again until the Emergency Stop Buttons are reset twisting the button $\frac{1}{4}$ turn clockwise. When the emergency stop buttons are reset, the laminator powers up and the power switch must be reset to begin operation.
- ❑ The **Draw Down Assembly** is located directly over the Drip Tray and is used to smooth the coating onto the surface of the media. It is manually raised and lowered by pivoting the assembly into it's up or down positions.
- ❑ The **Dam Stop Assemblies** are used to stop the coating from flowing off the edges of the media during operation. They are positioned at the edges of the media and are composed of two separate parts. An inner dam bracket is positioned on top and at the edges of the media and outer bracket positions up underneath the media to ensure that the dam stops hold a seal during operation.
- ❑ The **Drip Tray** is located directly under the Draw Down Assembly and is used to catch any drips of coating that may fall off the edge or end of the media during operation. The Drip Tray pulls out the front of the machine for periodic cleaning. The Sealant Recovery Trays sit inside the Drip Tray.
- ❑ The **Sealant Tank** is used to hold the supply of coating (18 liters/5 gallons). It is positioned on an overhead stand located on the left cabinet of the machine. The machine has no pump and the coating flows from the tank to the applicator nozzle by gravity feed and is controlled with flow control valves.
- ❑ The **Applicator Nozzle** is used to control the flow of coating delivered to the surface of the media. Coating flows from the Sealant Tank to the Applicator Nozzle and is flooded onto the surface of the media.
- ❑ The **Unwind Mandrel** is used to load a roll of media onto the front of the machine for roll to roll operation. It is a cantilevered assembly located low on the front of the machine. On the left side of the Unwind Mandrel is located a Tension Braking mechanism for applying back tension to the web. It is adjusted by turning the knurled collar. Core alignment is accomplished by sliding the core onto the mandrel and positioning in the desired position. Once the drive starts the Auto-grip bands will engage the core and enable the Tension Brake.

Section 1. Introduction

Hardware Overview (continued)

- The **Take-up Mandrel** is the primary drive for the machine used to pull the material through the machine and wind it onto the take-up core. It is a cantilevered assembly located low at the rear of the machine. It pivots from the left side of the machine and allows for the cores to be loaded and unloaded. Core alignment is accomplished by sliding the core onto the mandrel and positioning the core so it is aligned with the unwind core. Once the drive starts the Auto-grip bands will engage the core and begin pulling the media through the machine.
- The **Dryer Panel** is located on top of the machine running between the two end cabinets. This assembly is used to dry and cure the coating before it winds up on the Take-up roller. Lifting the handle located on top of the panel raises the dryer panel. The Dryer panel should be in the up position during web-up and heat-up procedures. Once the machine is ready for operation it is lowered into its down position.

Note: *The Dryer Panel has fans in the top of it that force air through perforations in the face of the Heater. These fans are used to push humidity out of the Dryer Panel compartment and assist in drying the media.*

- The **Control Panel** contains all the displays, controls, and indicators required to operate the laminator. Refer to Figure 1.2 and its accompanying descriptions.
 - **Main Power** is used to turn power On and Off to the machine. It is also used to reset the machine after an E-stop switch has been depressed.
 - **Heater** is used to turn power On and Off to the Heater Assembly.
 - **Temperature Controller** is used to adjust the set point of the dryer panel. The temperature is adjusted by holding the set button down and using the UP and DOWN arrow buttons to scroll to the desired temperature setting. When power to the machine is ON the controller will display the actual temperature, and when the SET button is depressed, it will display its desired running temperature. The display on the controller will be ON regardless of whether the Heater switch is On or Off.
 - **Speed Control** is used to adjust the speed setting of the Drive.

Section 1. Introduction

Hardware Overview (continued)

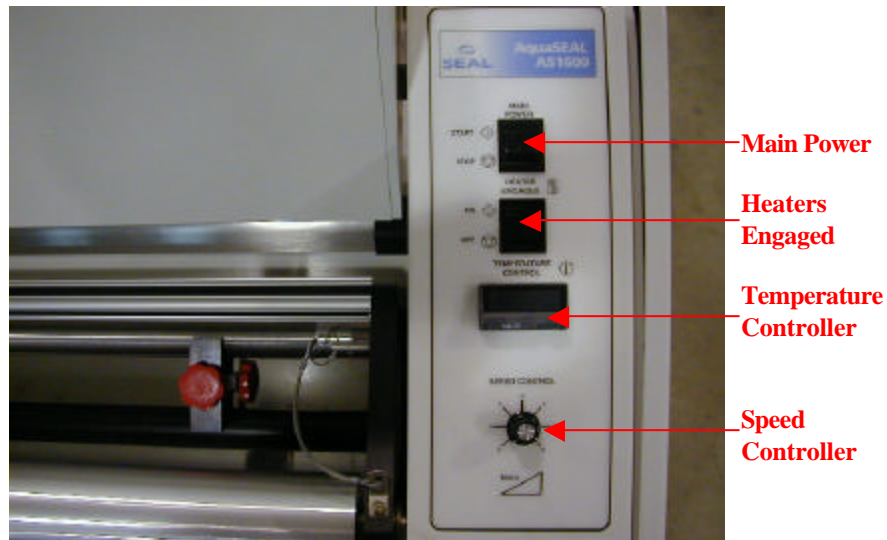

Figure 1.2 Control Panel

- The **Main Power Circuit Breakers** provide over-current protection.

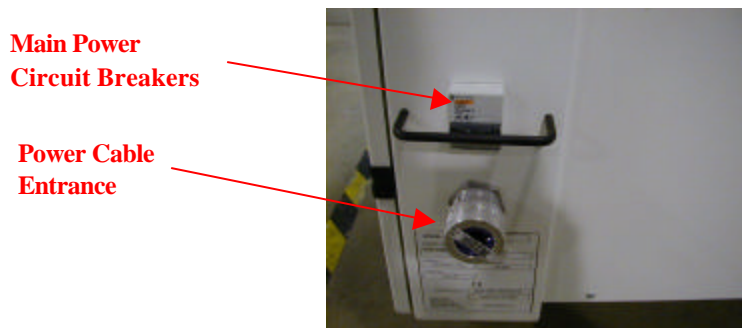

Figure 1.3 Circuit Breaker / Power Cable Entrance

- The **Power Cable Entrance** is the point where the cable connected to the power source enters the machine. It connects the machine to the following power sources:

- 228-240VAC, 50/60 Hz, single phase, 30 Amps.

Maximum Power Consumption: 6000 Watts

It is strongly recommended that the machine is fed from an “Earth Leakage” protected electrical outlet – if in doubt, please contact Seal Graphics Technical Services (listed at rear of manual) or consult a licensed electrician.

Section 1. Introduction

Hardware Overview (continued)

Figure 1.3 shows the rear view of the liquid laminator. Major components (safety items shown in red) include the following:

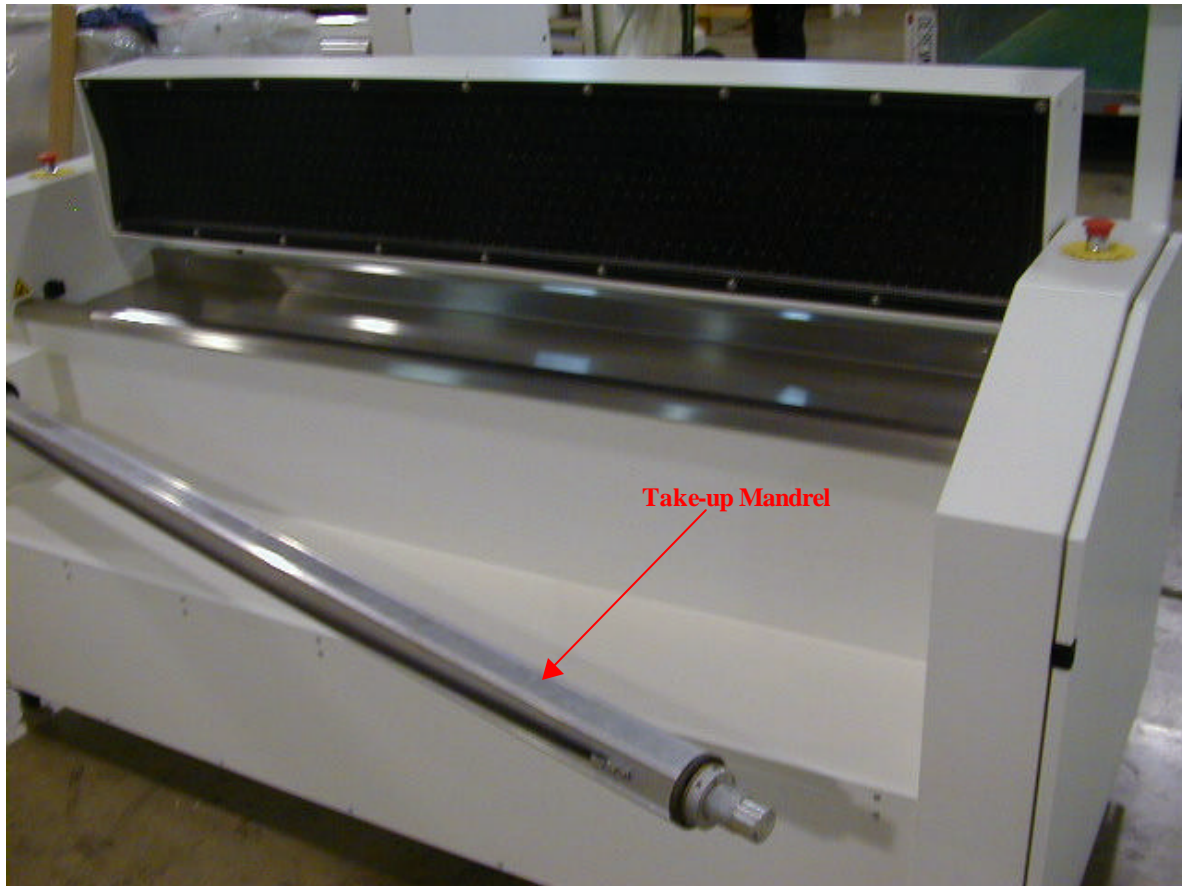

Figure 1.4 Rear View

Section 2. Operating Procedures

All operating functions are initiated at the control panel. The following section outlines general procedures and describes specific functions used to coat media. This section is divided into the following sub-headings:

1. Loading Materials
2. Pre-heat the laminator
3. Web the laminator
4. Run the laminator
5. Cleaning the laminator

Tools/Supplies Required:

- Absorbent towels: soft, lint free, disposable
- Lab coat or smock
- Rubber gloves
- Bucket of water
- 3M Scotchbrite pad

1. Loading Materials

Loading the Sealant:

1. Disconnect quick-connector fitting in supply line and remove the lid from the Sealant Tank.



Figure 2.1 Quick Disconnect

2. Pour *AquaSEAL™* 110 or *AquaSEAL™* 510 into the Sealant Tank. The sealant tank holds 18 Liters (5 US gallons) of sealant. (Be careful not to add too much sealant to the tank.)
3. Position Sealant Tank onto the tank pedestal and reattach the quick-connector fitting in the supply line. (Ensure that the Flow control valve is closed)
4. Using rolled media, position the roll on the Unwind Mandrel. The media must be oriented to feed into the machine with the image side up.

Section 2. Operating Procedures

2. Pre-heat the Laminator

All Pre-heat control operations are controlled from the Control Panel as shown in Figure 2.2

1. Switch machine to START at the **Main Power Switch**
 - Laminator will power-up
 - Dryer Panel is in the UP position.
 - Heaters are OFF.

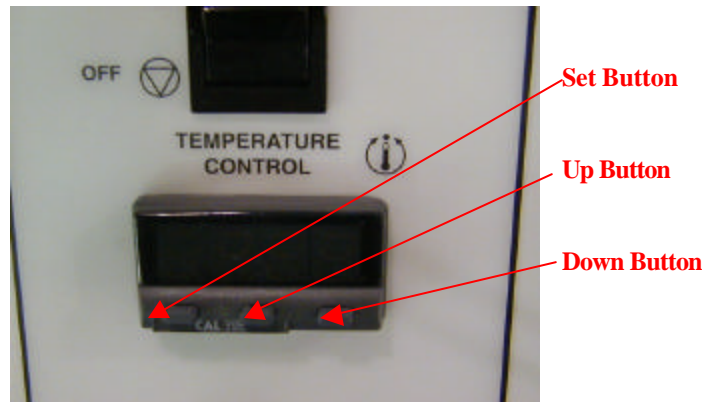

Figure 2.2 Heater Control locations

2. On the Heater Controller, press and hold the *SET* button to check the set-point temperature. Adjust the set point by holding the *SET* button down and using the UP/DOWN arrows to scroll to the desired temperature setting.

Note: *Most vinyl's run well with a SET POINT temperature of 315°C (600°F) dependent on speed.*

3. Press the Heater Switch to ON to power the Dryer Panel and begin heating.
4. Once the machine reaches its SET POINT it is ready to be operated.

Section 2. Operating Procedures

3. Web the Laminator

A Web diagram is provided in Figure 2.3 Below

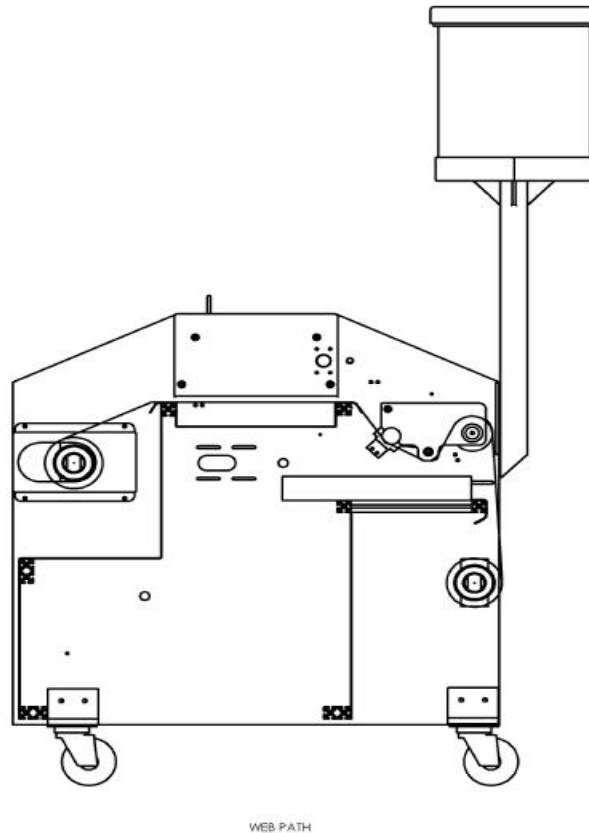

Figure 2.3 Web Diagram

Method

1. Lift Unwind Assembly to the UP position.
2. Load a take-up core onto the Take-up Mandrel and align with the edge of the roll of media on the Unwind Mandrel.
3. Pull media up over the web Idler, under the Draw down Assembly and under the Dryer Assembly to the Take-up Core.
4. Tape material to the Take-up core.

Note: *It is important to get the material as straight as possible to ensure a minimal amount of “telescoping” on the Take-up Roller.*

Section 2. Operating Procedures

4. Run the Laminator

1. Lower Draw Down Assembly and secure locking pins.
2. Align right and left Dam Stop brackets into position at the edges of the media. The inner brackets align with the outer edges of the media and lock down by turning the red knob on top of the bracket. The outer brackets position similarly next to the inner brackets with the bracket roller sealing against the bottom of the media. Tighten in place with the red knob on the side of the bracket.
3. Open the Flow Control valves on the applicator Nozzle and begin filling the reservoir between the Dam Stops.

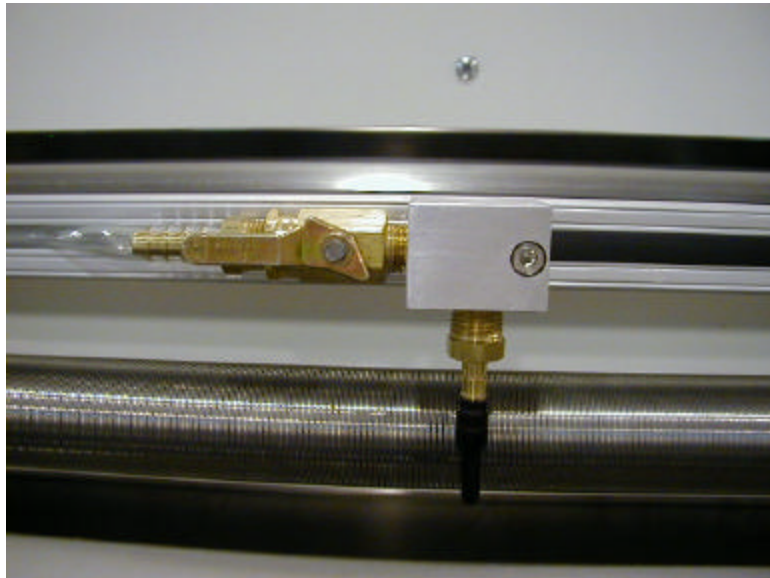

Figure 2.4 Applicator Nozzle

4. Once coating is spanning between the two dam stops, lower the Dryer Assembly to the Down position.
5. Turn the Speed Control knob to the desired speed setting.

Section 2. Operating Procedures

6. Adjust Brake tension so that the material is pulling through smoothly with no wrinkles.



Figure 2.5 Unwind Mandrel Brake Adjust

7. When the media being coated comes to an end, the last piece will loose tension; you will need to manually provide back-tension as the media runs out.
8. Approximately 1.6M (5 ft) prior to the last piece of media going past the Draw Down Assembly the Flow control valve at the Applicator Nozzle should be closed.
9. Once the material is through the Dryer Panel, the Dryer switch should be turned OFF.
10. The finished material is easily unloaded by swinging the Take-up Mandrel out and slipping the finished roll off the mandrel.

Section 2. Operating Procedures

5. Cleaning the Laminator

1. It is important to clean the machine **immediately** after the end of the material is completely through the Dryer panel.
2. Switch the machine to Stop on the Main Power Switch.
3. Pull Drip tray out 6 inches and raise the draw down assembly for cleaning.



Figure 2.6 Clean Up View

4. Using a **WET** cloth, wipe the 2 draw down bars to remove any excess sealant from them.

Note: *Sometimes the tail end of the material will drag a little coating onto the stainless steel table behind the Draw Down Assembly. It needs to be cleaned off quickly because the heat from the Dryer Panel will dry it rapidly.*

5. Dry the Draw Down bars with a clean dry cloth.
6. Put cap back on Applicator Nozzle.

Section 3. Troubleshooting

The following table lists problems that may occur when using the AS1600 Liquid Laminator. Recommended corrective actions are provided for all commonly encountered problems.

Problem / Symptom	Causes	Corrective Action
Very thin coating	Sealant is diluted with water	Remove old coating and refill with new
Heavy coating	Weight of coating in application area causes material to sag and not get wiped off properly	Increase break tension on the Transition and Tension Idlers
Streaked finish	Dirty Draw Down Bar	Clean the Draw Down Bar
	Overly thinned coating can dry quickly and streak	Remove old coating and refill with new
	Contaminated coating can clump up and streak	Remove old coating and refill with new
Media wrinkles	Media has been overheated	Cool down heaters or speed up drive
	Unwind to take-up alignment is poor	Realign the media
	Insufficient back-tension	Increase brake tension on Transition and Tension Idlers
Telescoping media	Roll-feed to take-up alignment is poor	Realign the media
Coated Media is wet coming out of the dryer panel	Insufficient drying	<ul style="list-style-type: none"> • Reduce web speed • Increase the heat panel temperature
Non-wets (areas where the sealant has not adhered to the film or paper)	Media surface is contaminated	Ensure media is free from contaminates
	Sealant is contaminated	Remove old coating and refill with new
	Media or inks and sealant are incompatible	Use a compatible media
Distortions in media	Media is too hot and is beginning to melt	Cool down the heaters and/or speed up the drive
	Media is hot and back tension is too high	Decrease back tension
Cracking effect in the coating	With thick coatings a high heat setting can cause evaporation to occur too rapidly causing this effect	<ul style="list-style-type: none"> • Lower heat controller setting to 600°F
Surface impressions occur at the take-up roll	Insufficient drying	<ul style="list-style-type: none"> • Check web temperature with IR gun • Reduce web speed • Increase heater panel temperature
Sealant in tank develops a skin over its surface	Sealant has been left without agitation for too long and has begun to dry out	Pull skin off the top of the sealant and add a small amount of water (1 cup) and mix into sealant thoroughly.

Section 3. Troubleshooting

Section 3. After Sales Support

SEAL[®] Brands Technical Service

(For technical assistance & service)

Tel: 1-800-486-6502
Fax: 1-800-966-4554

SEAL[®] Brands Technical Service – Europe and Asia Pacific

(For technical assistance & service)
For UK: Tel: +44 1268 722 400
Fax: +44 1268 729 442 or +44 870 125 5798
For NL: Tel: +31 572 345 500
Fax: +31 572 345 501

SEAL[®] Brands Customer Service

(For information and placing orders)

Tel: 1-800-257-7325
Fax: 1-800-966-4554

SEAL[®] Brands Customer Service - Europe

(For information and placing orders)

Tel: +31 572 345 500
Fax: +31 572 345 501

Note: SEAL Graphics recommends that your main power be installed by a licensed electrician in accordance with electrical codes in your area. Specifications subject to change without notice.

Seal Graphics Americas Corporation

7091 Troy Hill Drive
Elkridge, MD 21075
Tel: 410-379-5400
Fax: 410-579-8960

Seal Graphics Canada

1601 Matheson Blvd. E
Unit #4
Mississauga, Ontario
Canada, L4W 1H9
Tel: 905-212-9232
Fax: 905-212-9313

Seal Graphics U.K. Ltd

Unit 1, 1 Watkins Close
Burnt Mills Industrial Estate
Basildon, Essex SS13 1BJ
United Kingdom
Tel: +44 1268 722 400
Fax: +44 1268 729 442

Seal Graphics Europe BV

Kanaaldijk O.Z.3
P.O. Box 29,
8100 AA Raalte
The Netherlands
Tel: +31 572 345 500
Fax: +31 572 345 501

Seal Graphics Pacific Limited

Unit A, 13th Floor, Block 1
Leader Industrial Centre
Tsuen Wan,
New Territories, Hong Kong
Tel: +852 2407 3738
Fax: -852 2408 0973



www.sealbrands.com

© 2002 SEAL Graphics
SEAL[®] and Image[®] are registered trademarks of SEAL Graphics
Part #OM1600-E Rev. 8
(11/02)

Free Manuals Download Website

<http://myh66.com>

<http://usermanuals.us>

<http://www.somanuals.com>

<http://www.4manuals.cc>

<http://www.manual-lib.com>

<http://www.404manual.com>

<http://www.luxmanual.com>

<http://aubethermostatmanual.com>

Golf course search by state

<http://golfingnear.com>

Email search by domain

<http://emailbydomain.com>

Auto manuals search

<http://auto.somanuals.com>

TV manuals search

<http://tv.somanuals.com>