

# **ENFORCER<sup>®</sup>**

## **E-37EV**

### Alarm Pager System

## **Manual**



- Monitors up to three zones per premises or vehicle, plus manual paging.
- One positive and two negative instant trigger inputs.
- Low-battery indicator.
- Red LED transmission indicator.
- Code-learning receiver learns up to three transmitter codes.
- Transmitter can page an unlimited number of receivers.
- Colored LEDs or vibrate function indicate received page.
- Unattended page indicator.

**NOTE:** Antenna required. See page 3 for more details. Antenna not included.

## Table of Contents

Introduction .....	2
Parts List .....	2
Dimensions .....	2
Specifications .....	3
Installation .....	3-4
Wiring .....	4
Connection Diagram .....	5
Programming .....	5
Audible and Visual Signals Chart.....	6
Operation .....	6-7
Warning.....	7
Troubleshooting .....	8
Also available from SECO-LARM .....	8

## Introduction

The E-37EV is a sophisticated paging system consisting of two parts: a transmitter with trigger and timing circuitry, and a matching E-37RV receiver with both vibrating and audible paging functions.

The pager alerts users when a protected building or vehicle is being vandalized or broken into, or when someone presses the manual paging button. The transmitter has a maximum output power of 4 watts as allowed by the FCC.

Mount the E-37EV inside the secure area. The transmitter sends a page signal when triggered. The page signal is received by the small, highly sensitive, lightweight receiver. The receiver beeps or vibrates and colored LEDs indicate the type of trigger event.

The system is easy to install in any type of building or vehicle. The two 1.5V AAA-sized batteries (batteries not included) in the receiver will last approximately one month (5 transmissions/day). The receiver can be programmed to receive page signals from up to 3 separate transmitters and the transmitter can page an unlimited number of receivers.

## Parts List

- 1 x Transmitter
- 1 x Receiver (model E-37RV)
- 1 x Wire harness
- 3 x Mounting screws
- 1 x Radio antenna adapter cord (18")

## Dimensions

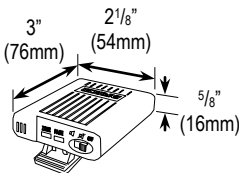
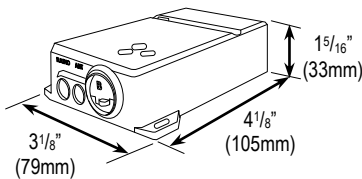

## Specifications

<b>Transmitter</b>	Number of codes		Over 2 million (factory pre-set)
	Power		12VDC
	RF output power		4W max.
	Current drain	Standby	10mA
		Active	1A
	Frequency		27MHz
	Antenna impedance		50 Ω
	Range		Up to 1/2 mile in open air <sup>1</sup>
	Dimensions		4 1/8" x 3 1/8" x 1 5/16" (105x79x33 mm)
	Weight		5.1-oz (145g)

<sup>1</sup> Actual range may vary depending on the environment, installation, and/or antenna.

<b>Receiver</b>	Number of codes		Learns up to 3 transmitter codes
	Power		3VDC (2 AAA batteries) <sup>2</sup>
	Battery life		Approx. 1 month <sup>3</sup>
	Current drain	Standby	1mA
		Active (Beep)	20mA
		Active (Vibrate)	50mA
	Dimensions		3" x 2 1/8" x 5/8" (76x54x16 mm)
Weight		1.6-oz (45g) (without battery)	

<sup>2</sup> Batteries not included

<sup>3</sup> Based on 5 transmissions/day

## Installation

### Transmitter Installation

1. Mark locations for drilling the mounting bracket holes. Be careful that the area to be drilled is free from wiring, trim, and/or any other obstructions.
2. Drill holes at the location marks. Position the transmitter where it will be mounted, but do not secure immediately.
3. The transmitter should be permanently mounted only after all connections and tests are made.

### NOTES:

- Do not mount the E-37EV transmitter in the engine compartment as this automatically voids the warranty.
- Do not power up the transmitter before the antenna connections are made as this may damage the transmitter.
- In a building, mount as close to a window as possible.
- In a vehicle, mount under the dashboard or in the glove compartment.

### Antenna Installation (see Connection Diagram on pg. 5)

The E-37EV can be connected to one of four types of antennas:

#### TYPE 1: Strip antenna (A Position)

1. E-37ANT (optional) can be used in either a building or vehicle.
2. Connect the male antenna plug into the transmitter jack marked "ANT."
3. Place the antenna selection switch in the "A" position.
4. Do not secure the strip antenna to metal, window defrosters, or existing antennas.

**TYPE 2: CB antenna (A Position)**

1. Connect the male antenna plug of an optional CB antenna into the transmitter jack marked "ANT."
2. Place the antenna selection switch in the "A" position.

**TYPE 3: Standard radio antenna (B Position)**

1. Disconnect the radio antenna lead going into the radio and connect it to the transmitter jack marked "ANT."
2. Connect the provided male-to-male 18" radio antenna adapter cord between the transmitter jack marked "RADIO" and the radio antenna jack.
3. Place the antenna selection switch in the "B" position.

**TYPE 4: Fully automatic radio antenna (B Position)**

1. Disconnect the radio antenna lead going to the radio and connect to the transmitter jack marked "ANT."
  2. Connect the provided male-to-male 18" radio antenna adapter cord between the transmitter jack marked "RADIO" and the radio antenna jack.
  3. Cut the power antenna lead running from the radio to the fully automatic radio antenna.
  4. Connect the lead coming from the power antenna to the **long** white wire (marked "To power antenna sensor wire").
  5. Connect the lead coming from the radio to the **short** white wire (marked "To radio switched power lead").
  6. Place the antenna selection switch in the "B" position.
- 

## Wiring

**Red Wire – Positive 12VDC power**

- Connect the red wire to a constant +12VDC power source.

**Black Wire – Ground**

- Connect the black wire to the negative terminal of a 12VDC power source.
- Optionally, connect to the frame of the vehicle.

**Purple Wire – Positive trigger input**

- Connect the purple wire to a burglar or car alarm output that outputs +12V when the alarm is triggered (the trigger signals must be at least 1 second long in order to trigger pager.)

**Green Wire – Negative trigger input #1**

- Connect the green wire to a burglar or car alarm output that outputs ground when the alarm is triggered (the trigger signals must be at least 1 second long in order to trigger pager.)

**Blue Wire – Negative trigger input #2**

- Connect the blue wire to a burglar or car alarm output that outputs ground when the alarm is triggered (the trigger signals must be at least 1 second long in order to trigger pager.)

**White Wire – Fully automatic radio antenna**





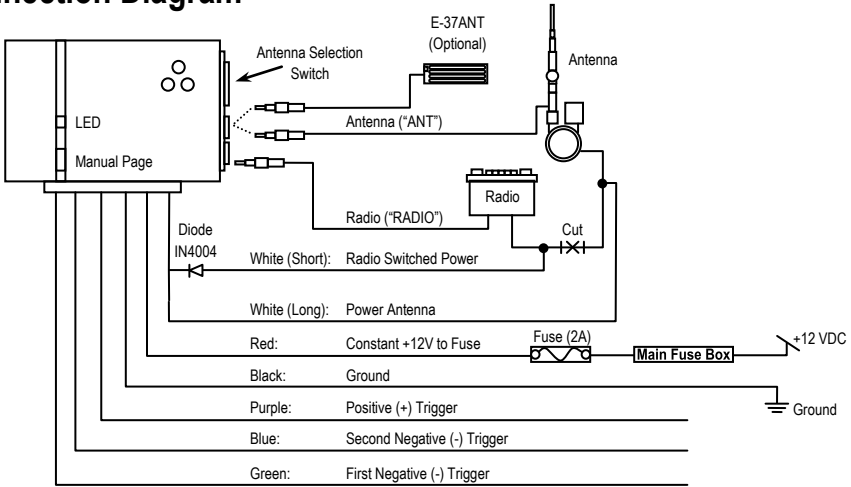

- Connect the long white wire (female spade plug) to the power antenna wire coming from the power antenna sensor wire.
- Connect the short white wire (male spade plug) to the power antenna wire coming from the radio switched power lead.
- **Warning:** Do not reverse the white wire connections.

## Connection Diagram



## Programming

The receiver must learn the transmitter's code before it can receive signals from the transmitter. The receiver can learn the page codes of up to 3 transmitters.

1. Turn the receiver OFF. Then press and hold the  /  / OFF switch and slide it to the  position. Continue holding for 3 seconds until the receiver beeps once.
2. The PAGE LED will flash GREEN at a steady rate. The ZONE LED will be solid ORANGE. This means the receiver is ready to learn the page code of the first transmitter.
3. Press the manual page button on the transmitter. This will send the page signal to the receiver. The receiver will beep twice and the LEDs will turn off to indicate the code has been learned. The receiver will beep five times in four minutes if no code is learned.
4. To learn a second (or third) transmitter, repeat step 1 then press down on the  /  / OFF switch once. The PAGE LED will begin flashing RED for the second transmitter and ORANGE for the third transmitter.
5. Press the manual page button on the second (or third) transmitter. The receiver will beep twice and the LEDs will turn off to indicate the page code has been learned. The receiver will beep five times in four minutes if no code is learned.
6. If no additional transmitters need to be learned then move the  /  / OFF switch back to the OFF position.

Notes:



- The receiver remembers the transmitter codes in EEPROM memory even without power for over one year. The receiver does not need to re-learn the transmitter codes after battery replacement.
- Only one of each transmitter ID may be learned at a time. For example, if a green transmitter is already programmed and a new green transmitter is learned, the previous green transmitter will no longer work.

## Audible and Visual Signals Chart

Transmitter ID	Input	Receiver Display		
		Page LED	Zone LED	Audible / Vibrator Indicator
Green	Positive Trigger	Green	Green	Groups of 9
	Negative Trigger #1	Green	Red	Groups of 9
	Negative Trigger #2	Green	Orange	Groups of 9
	Manual Page	Green	Green	3 groups of 3
	Power ON	Green	None	3 groups of 3
Red	Positive Trigger	Red	Green	Groups of 9
	Negative Trigger #1	Red	Red	Groups of 9
	Negative Trigger #2	Red	Orange	Groups of 9
	Manual Page	Red	Green	3 groups of 3
	Power ON	Red	None	3 groups of 3
Orange	Positive Trigger	Orange	Green	Groups of 9
	Negative Trigger #1	Orange	Red	Groups of 9
	Negative Trigger #2	Orange	Orange	Groups of 9
	Manual Page	Orange	Green	3 groups of 3
	Power ON	Orange	None	3 groups of 3

## Operation



### Receiver Switch Settings

- : Beeping only
- : Vibration only
- OFF: Receiver off



### Trigger Duration

- The transmitter will transmit the page signal for a cycle of about 30 seconds, whether or not the triggered zone is reset. If the same zone remains triggered, the transmitter will not start a new transmission cycle. However, a new cycle will begin once another un-triggered zone is triggered.

### Manual Paging

- When triggered by the manual page button the receiver will beep (or vibrate) continuously for 1 minute in 3 groups of 3.
- The Page LED will indicate which transmitter is sending the signal (Green, Red, or Orange).
- The Zone LED will flash green.
- Press the //OFF button after 30 seconds to stop the indicator.

### Power-On Paging

- When the transmitter is connected to power the receiver will beep (or vibrate) continuously for 1 minute in 3 groups of 3.
- The Page LED will indicate which transmitter is sending the signal (Green, Red, or Orange).
- The Zone LED will remain blank.
- Press the //OFF button after 30 seconds to stop the indicator.

### **Alarm Paging**

- When triggered by either the purple (+), green (-), or blue (-) triggers, the receiver will beep (or vibrate) continuously for 1 minute in groups of 9.
- The Page LED will indicate which transmitter is sending the signal (Green, Red, or Orange).
- The Zone LED will indicate which trigger was triggered.
  - Positive trigger (purple wire) will flash green.
  - Negative trigger #1 (green wire) will flash red.
  - Negative trigger #2 (blue wire) will flash orange.
- Press the /OFF button after 30 seconds to stop the indicator.

### **Receiver Power-On**

- The receiver will beep (or vibrate) once each time the receiver is turned on.

### **Unattended Indicator**

- The receiver will beep (or vibrate) once every 30 seconds to remind the user that it received a page signal from the transmitter.
- Press the /OFF button to stop the indicator.

### **Low-Battery Indicator**

- The receiver will beep (or vibrate) twice following power-on if the batteries are low.
- The receiver will also beep (or vibrate) twice every 60 seconds when the batteries are low.

### **Viewing the Page Memory**

- Scroll back the page signal memory by pressing the /OFF button repeatedly.
- The receiver remembers the last 6 page signals received.
- Page signals will be shown one by one, beginning with the most recent.
- The receiver will beep once for an alarm page, but will not beep for a manual page.
- The receiver will beep three times to indicate that all signals have been viewed, or that no signals are stored.
- Two consecutive page signals carrying the same information are treated as one.
- Turning off the receiver will erase all stored signals.

---

## **Warning**

- Ensure that an antenna is connected before connecting power to the unit. Failure to do so may damage the transmitter.
- Do not open the receiver or transmitter cases. All adjustments have been made at the factory. There are no user serviceable parts inside.
- Holes marked 1, 2, and 3 on the transmitter case are factory set. Do not make any adjustments in these holes.
- Use only AAA size 1.5V alkaline batteries for the receiver.

## Troubleshooting

---

No page signal

- Check that all connections are securely made
- Check that the antenna is securely fastened
- Check the receiver batteries
- Possibly out of range – Move antenna to better position
- Make sure the antenna selection switch is in the correct position
- Check that the transmitter has been properly learned

Receiver only outputting vibrate/beep

- Check that the receiver is in the correct alert mode
- 

## Also Available from SECO-LARM

E-37RV Vibrating Transmitter



E-37ANT Strip Antenna



---

### FCC COMPLIANCE STATEMENT

Information to the user: This equipment has been tested and found to comply with the limits for a class B digital device, pursuant to part 15 of the FCC rules. These limits are designed to provide reasonable protection against harmful interference when the equipment is operated in a commercial environment. This equipment generates, uses, and can radiate radio frequency energy and, if not installed and used in accordance with the instruction manual, may cause harmful interference to radio communications. Operation of this equipment in a residential area is likely to cause harmful interference in which case the user will be required to correct the interference at his or her own expense.

---

**WARRANTY:** This SECO-LARM product is warranted against defects in material and workmanship while used in normal service for a period of one (1) year from the date of sale to the original customer. SECO-LARM's obligation is limited to the repair or replacement of any defective part if the unit is returned, transportation prepaid, to SECO-LARM.

This Warranty is void if damage is caused by or attributed to acts of God, physical or electrical misuse or abuse, neglect, repair or alteration, improper or abnormal usage, or faulty installation, or if for any other reason SECO-LARM determines that such equipment is not operating properly as a result of causes other than defects in material and workmanship.

The sole obligation of SECO-LARM and the purchaser's exclusive remedy shall be limited to replacement or repair only, at SECO-LARM's option. In no event shall SECO-LARM be liable for any special, collateral, incidental, or consequential personal or property damages of any kind to the purchaser or anyone else.

---

### NOTICE

The information and specifications printed in this manual are current at the time of publication. However, the SECO-LARM policy is one of continual development and improvement. For this reason, SECO-LARM reserves the right to change specifications without notice. SECO-LARM is also not responsible for misprints or typographical errors.

Copyright © 2012 SECO-LARM U.S.A., Inc. All rights reserved. This material may not be reproduced or copied, in whole or in part, without the written permission of SECO-LARM.

---

### SECO-LARM U.S.A., Inc.

16842 Millikan Avenue, Irvine, CA 92606

Tel: 800-662-0800 / 949-261-2999

Website: [www.seco-larm.com](http://www.seco-larm.com)

E-mail: [sales@seco-larm.com](mailto:sales@seco-larm.com)



MI-E-37EV\_1209.docx



## Free Manuals Download Website

<http://myh66.com>

<http://usermanuals.us>

<http://www.somanuals.com>

<http://www.4manuals.cc>

<http://www.manual-lib.com>

<http://www.404manual.com>

<http://www.luxmanual.com>

<http://aubethermostatmanual.com>

Golf course search by state

<http://golfingnear.com>

Email search by domain

<http://emailbydomain.com>

Auto manuals search

<http://auto.somanuals.com>

TV manuals search

<http://tv.somanuals.com>