

xD

2009

# QUICK REFERENCE GUIDE

GET INFORMED.  
ROLL.



what moves you

# 2009 Scion xD

This *Quick Reference Guide* is a summary of basic vehicle operations. It contains brief descriptions of fundamental operations so you can locate and use the vehicle's main equipment quickly and easily.

The *Quick Reference Guide* is not intended as a substitute for the *Owner's Manual* located in the vehicle's glove box. We strongly encourage you to review the *Owner's Manual* and supplementary manuals so you will have a better understanding of the vehicle's capabilities and limitations.

Your dealership and the entire staff of Toyota Motor Sales, U.S.A., Inc. wish you many years of satisfied driving in your new Scion xD.

## ! A word about safe vehicle operations

This *Quick Reference Guide* is not a full description of Scion xD operations. Every Scion xD owner should review the *Owner's Manual* that accompanies this vehicle.

Pay special attention to the boxed information highlighted in color throughout the *Owner's Manual*. Each box contains safe operating instructions to help you avoid injury or equipment malfunction.

All information in this *Quick Reference Guide* is current at the time of printing. Toyota reserves the right to make changes at any time without notice.

# INDEX

## OVERVIEW

Engine maintenance	7
Fuel tank door release and cap	6
Hood release	7
Indicator symbols	4-5
Instrument cluster	4
Instrument panel	2-3
<b>Keyless entry<sup>1</sup></b>	<b>6</b>
Light control-Instrument panel	7

## FEATURES/OPERATIONS

Air Conditioning/Heating	12
Automatic Transmission	8
AUX audio jack	13
Bottle holders	15
Clock	12
Cruise control	11
Cup holders	15
iPod® jack	13
Lights & turn signals	10
Multi-information display	14
Parking brake	8
Power outlet	15
Seat adjustments	9
Seat-Folding down rear seat	9
Seats-Head restraints	8
Steering wheel switches	14
Tilt steering wheel	12
Windows	11
Window wipers & washers	10

## SAFETY AND

## EMERGENCY FEATURES

Door locks	16
Doors-Child safety locks	16
Seat belts	16
Seat belts-Shoulder belt anchor	16
Spare tire & tools	17
Tire Pressure Monitoring (warning) System	17

<sup>1</sup> Visit your Toyota dealer for information on customizing this feature.

## Instrument panel

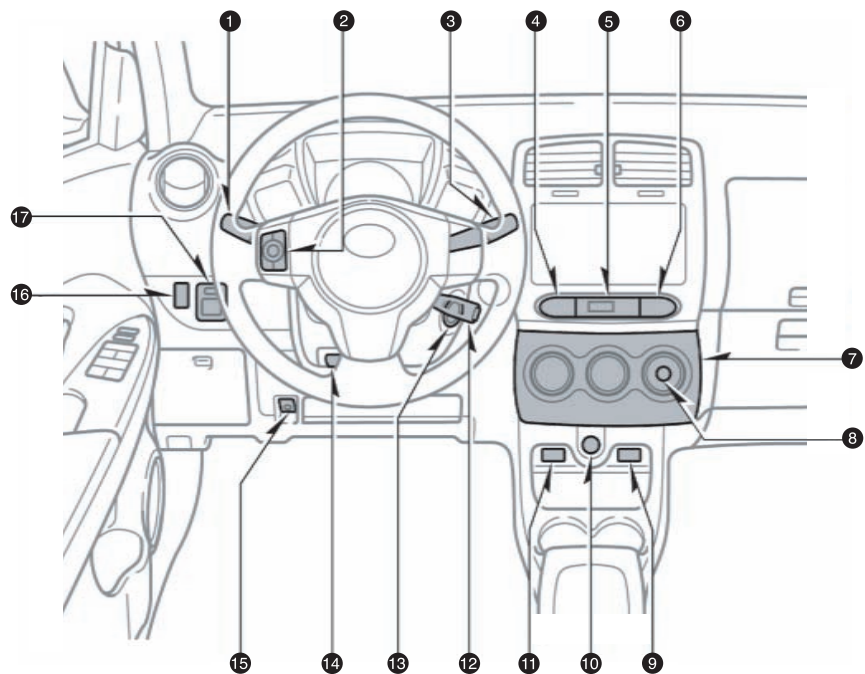









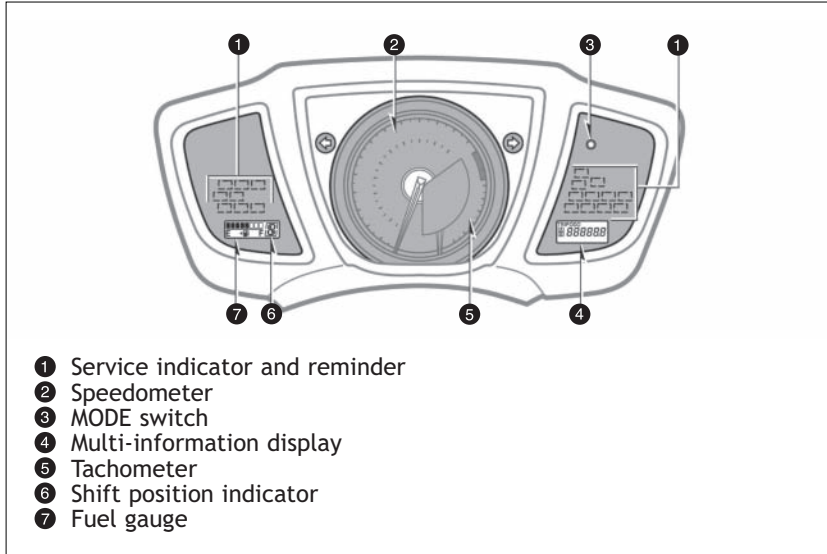





- ① Headlight and turn signal controls
- ② Steering wheel audio controls\*
- ③ Wiper and washer controls
- ④ Emergency flasher button
- ⑤ Clock
- ⑥ Front passenger occupant classification indicator/Front passenger seat belt reminder light
- ⑦ Air Conditioning controls
- ⑧ Rear window defogger button

- ⑨ iPod® jack\*
- ⑩ 12V DC Power outlet
- ⑪ AUX audio jack\*
- ⑫ Cruise control
- ⑬ Engine switch
- ⑭ Tilt steering lock release
- ⑮ Tire Pressure Monitoring (warning) System
- ⑯ Instrument panel light control
- ⑰ Power rearview mirror controls











\* For details, refer to the *SCION Audio System, Owner's Manual* or *SCION Navigation System Owner's Manual*.

### Instrument cluster



-  Low engine coolant temperature indicator<sup>2</sup>
-  High engine coolant temperature warning<sup>1</sup>
-  Engine oil replacement reminder<sup>1</sup>
-  Front passenger occupant classification indicator
-  Headlight low beam indicator
-  Headlight high beam indicator
-  Turn signal indicator
-  Low fuel level warning<sup>1</sup>
-  Slip indicator
-  Vehicle Stability Control OFF indicator
-  Cruise control indicator<sup>3</sup>
-  Electric power steering system warning<sup>1</sup>
-  Anti-lock Brake System warning<sup>1</sup>

### Indicator symbols

-  Brake system warning<sup>1</sup>
-  Driver seat belt reminder<sup>1</sup>  
(alarm will sound if speed is over 12 mph)
-  Front passenger seat belt reminder<sup>1</sup>  
(alarm will sound if speed is over 12 mph)
-  Charging system warning<sup>1</sup>
-  Malfunction/Check Engine indicator<sup>1</sup>
-  Low engine oil pressure warning<sup>1</sup>
-  Open door warning<sup>1</sup>
-  Airbag SRS warning<sup>1</sup>
-  Low Tire Pressure Warning<sup>1</sup>
-  Low windshield washer fluid level warning<sup>1</sup>

<sup>1</sup> For details, refer to “Service reminder indicators and warning buzzers,” Section 1-6, 2009 Owner’s Manual.  
<sup>2</sup> For details, refer to “Engine coolant temperature indicator and warning light,” Section 1-6, 2009 Owner’s Manual.

<sup>3</sup> If this light flashes, refer to “Cruise control,” Section 1-7, 2009 Owner’s Manual.

### Keyless entry

#### Locking operation

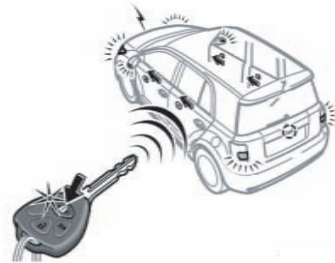

Push 

#### Unlocking operation



Push ONCE: Driver door  
TWICE: ALL doors 

**NOTE:** If a door is not opened within 30 seconds of unlocking, all doors will relock for safety.

#### Panic button



Push and hold 

### Fuel tank door release and cap

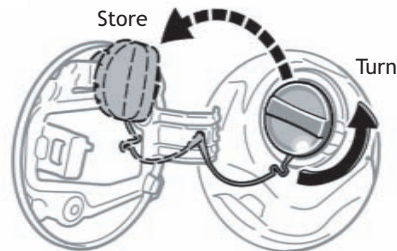
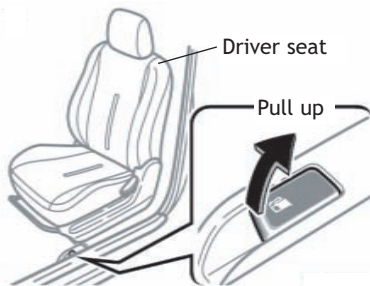

**NOTE:** Tighten until one click is heard. If the cap is not tightened enough, Check Engine  indicator may illuminate.

### Light control-Instrument panel

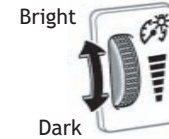

### Hood release

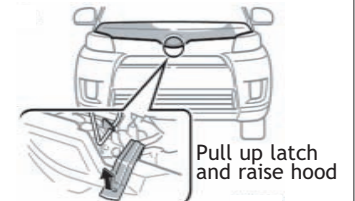
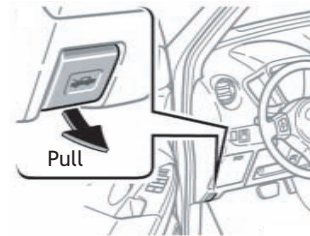

### Engine maintenance

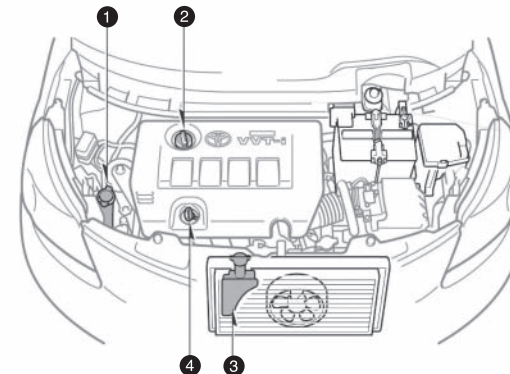

- 1 Windshield washer fluid tank
- 2 Engine oil filler cap
- 3 Engine coolant reservoir
- 4 Engine oil level dipstick

**Note:** Regularly scheduled maintenance, including oil changes, will help extend the life of your vehicle and maintain performance. Please refer to the "Owner's Warranty Information Booklet," "Scheduled Maintenance Guide" or "Owner's Manual Supplement."

# FEATURES/OPERATIONS

## Automatic Transmission (if equipped)

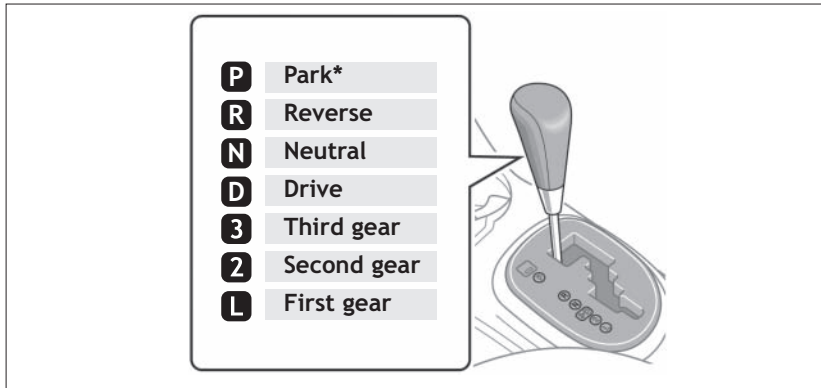

\* The engine switch must be "ON" and the brake pedal depressed to shift from Park.

Downshifting increases power going uphill, or provides engine braking downhill. For best fuel economy during normal driving conditions, always drive with the shift lever in the "D" position.

## Parking brake

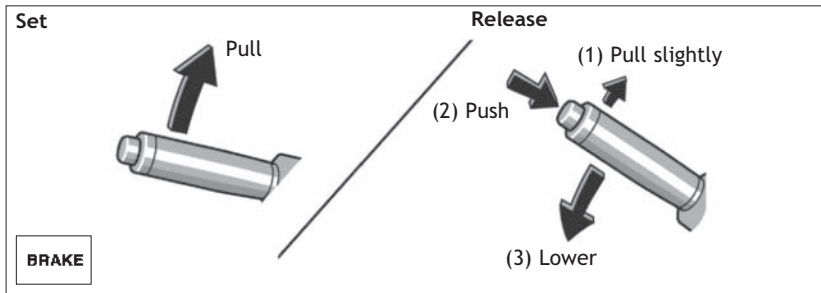

## Seats-Head restraints

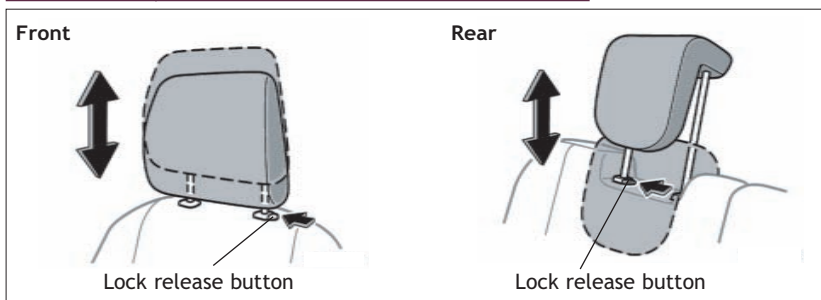

## Seat adjustments

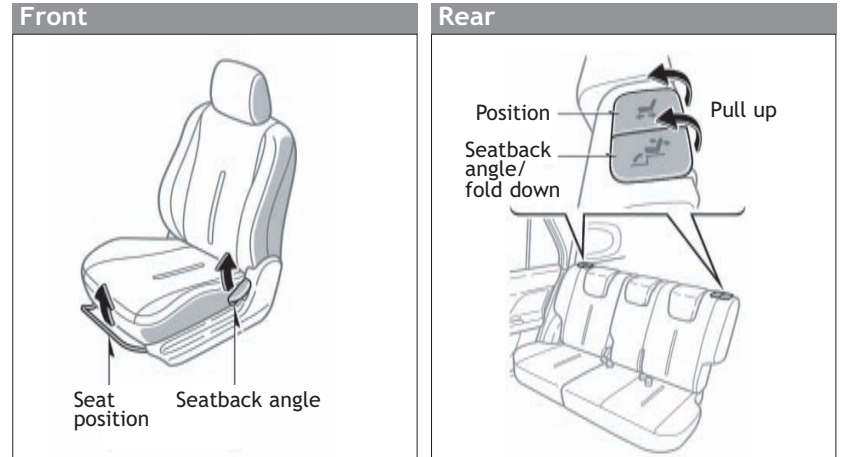

## Seat-Folding down rear seat

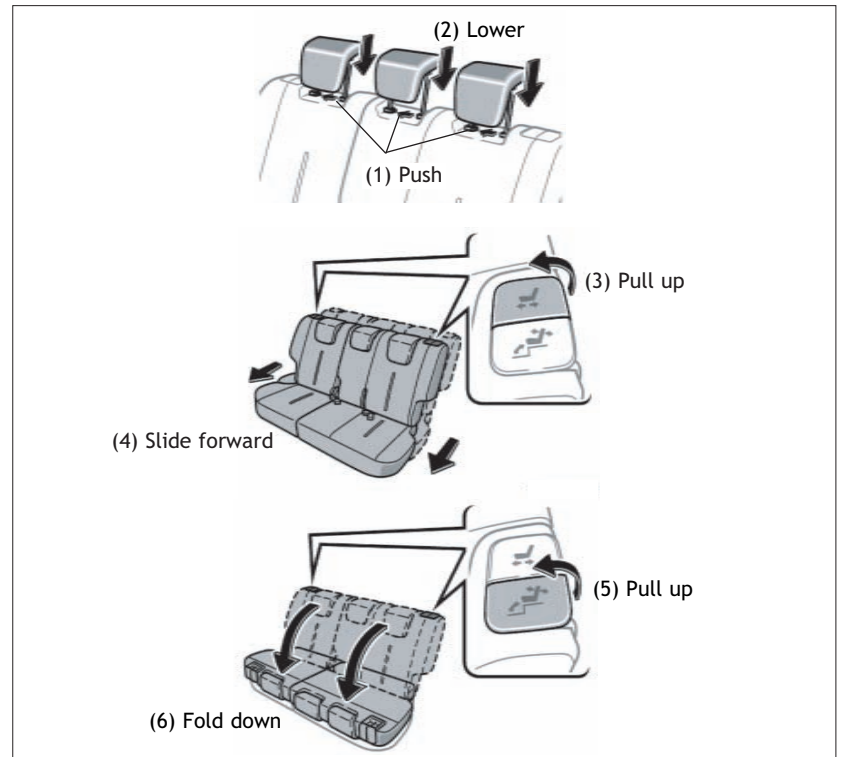



## Lights & turn signals

### Headlights

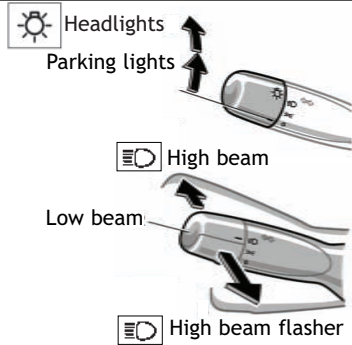

### Turn signals

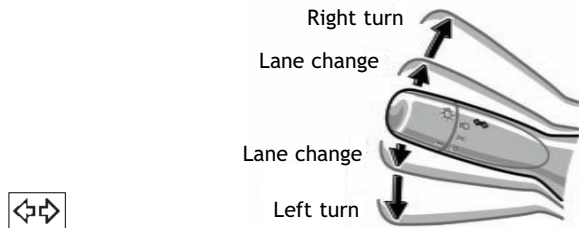

## Window wipers & washers

### Front

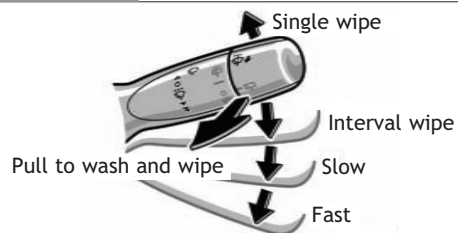

### Rear

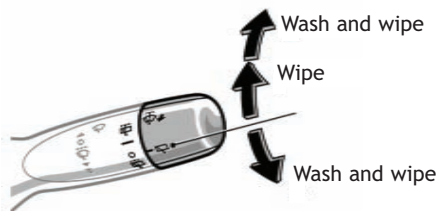

## Windows

### Driver side

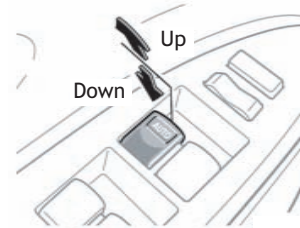

### Window lock switch

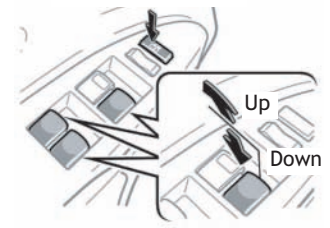

### Automatic down operation (driver side only)

Push the switch completely down and release to fully open. To stop window midway, lightly pull the switch up.

**Window lock switch** Deactivates all passenger windows. Driver's window remains operable.

## Cruise control

### System ON/OFF

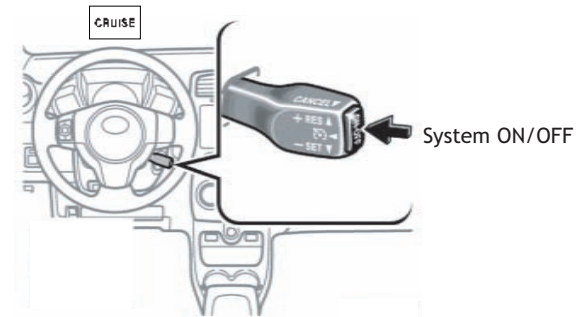

### Functions

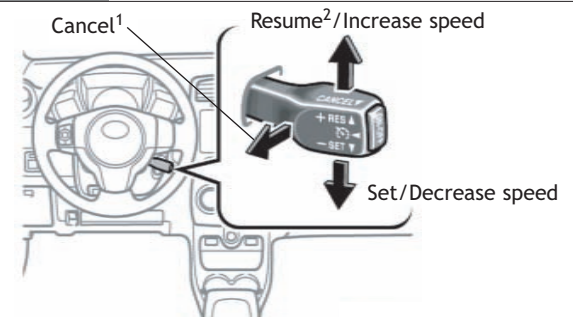

<sup>1</sup> The set speed may also be cancelled by depressing the brake pedal.

<sup>2</sup> The set speed may be resumed once vehicle speed reaches 25 mph.



### Tilt steering wheel

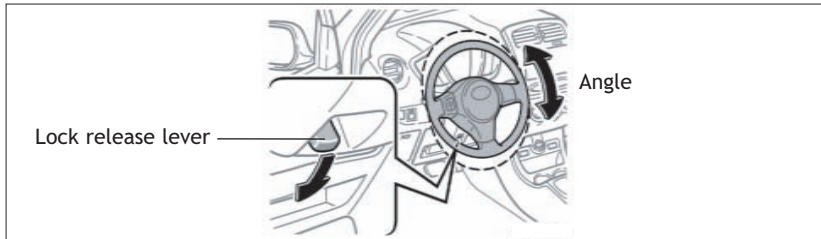

Hold wheel, push lever down, set angle and return lever.

**Note:** Do not attempt to adjust while the vehicle is in motion.

### Clock

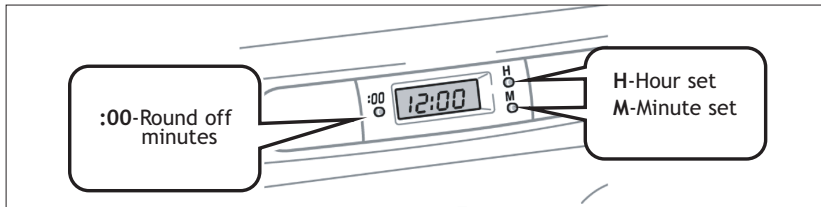

### Air Conditioning/Heating

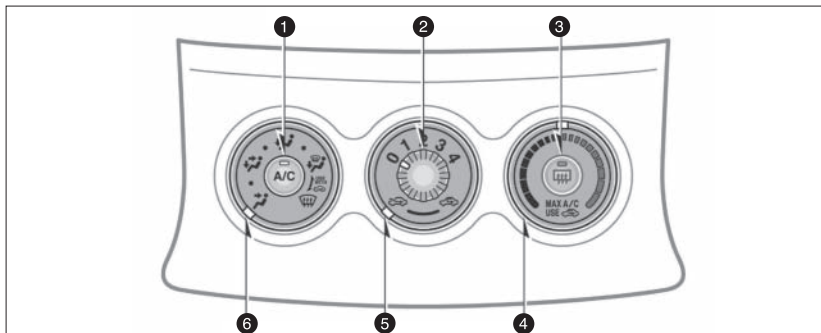

- ❶ Air Conditioning ON/OFF  
Use fresh air to quickly cool interior, then change to recirculate for cooler air.
- ❷ Fan speed
- ❸ Rear window defogger
- ❹ Temperature selector
- ❺ Fresh or recirculated cabin air
- ❻ Airflow vent  
In “” or “” mode, use with the air intake selector position in “” to reduce window fogging.

### AUX audio jack

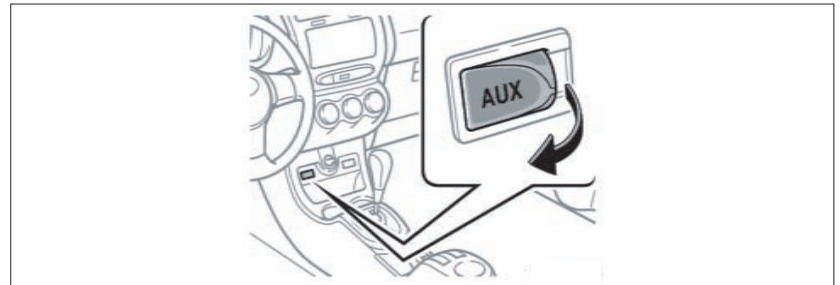

By inserting a mini plug (not included) into the AUX jack, you can listen to music from a portable audio device through the vehicle’s speaker system while in AUX mode.

If you do not have a SCION genuine audio system, you will not be able to use the AUX jack.

Refer to the *SCION Audio or Navigation System Owner’s Manual* for more details.

### iPod® jack

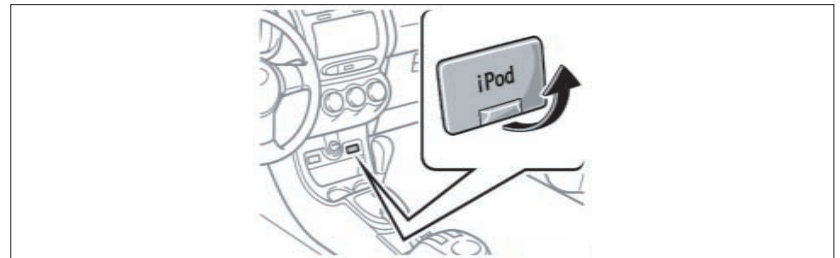

By inserting the standard iPod® connector cable into the iPod® jack, you can charge the iPod® battery, control the iPod® functions using the car audio unit and listen to music from your iPod® through the vehicle’s speaker system.

If you do not have a SCION genuine audio system, you will not be able to use the iPod® jack.

Refer to the *SCION Audio or Navigation System Owner’s Manual* for more details.

### Steering wheel switches

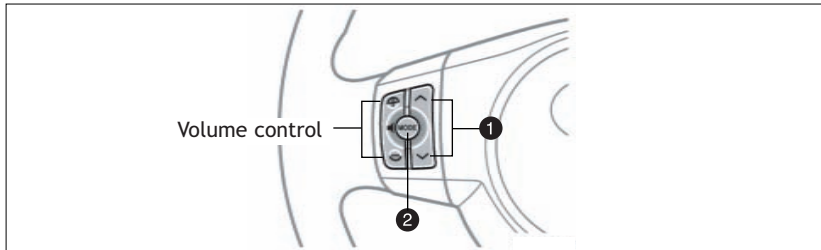

- ① “V ^”  
-In radio mode Push to select a preset station; push and hold to seek the next strong station.  
-In CD mode Push to skip up or down to a next/previous track.
- ② “MODE”  
Push to turn audio ON and select an audio mode. Push and hold to turn the audio system OFF.

Refer to the *SCION Audio or Navigation System Owner's Manual* for more details.

### Multi-information display

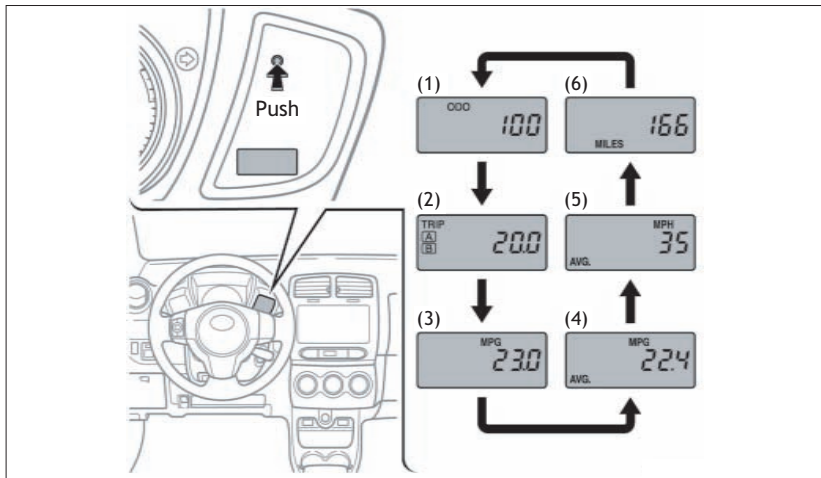

Push button to change information in the following succession:

- (1) Odometer
- (2) Trip meters
- (3) Current gas mileage (MPG)
- (4) Average gas mileage (AVG/MPG)
- (5) Average vehicle speed from engine start (AVG/MPH)
- (6) Miles left on remaining fuel (RANGE/MI)

### Power outlet

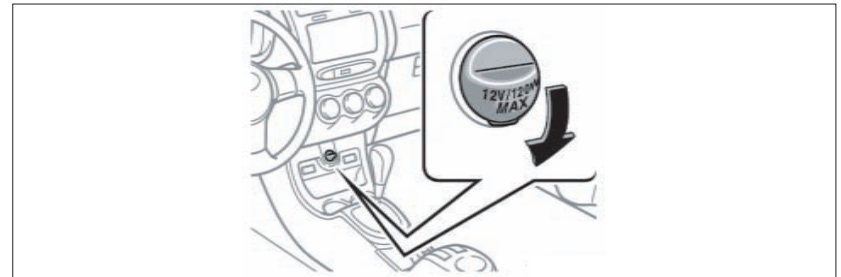

Designed for car accessories. Key must be in the “ACC” or “ON” position for use.

### Bottle holders

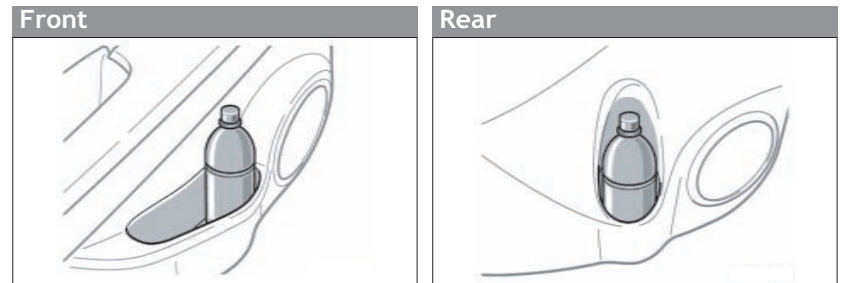

### Cup holders

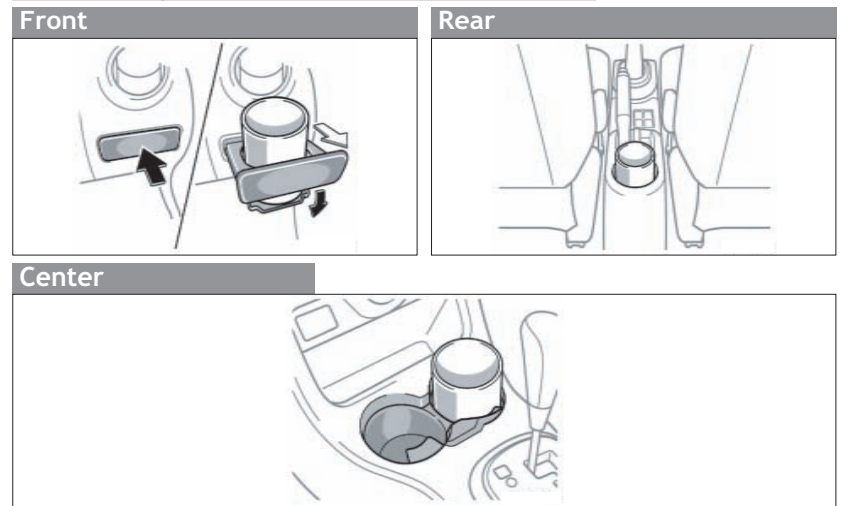

# SAFETY AND EMERGENCY FEATURES

## Door locks



## Doors-Child safety locks

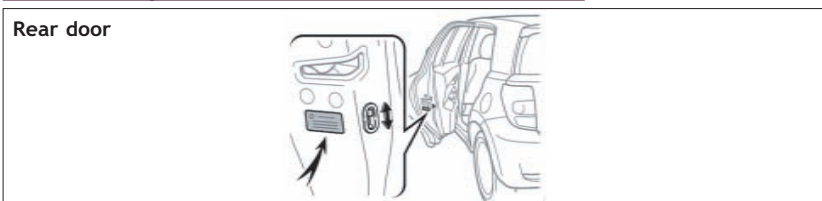

Moving the lever to "LOCK" will allow the door to be opened only from the outside.

## Seat belts-Shoulder belt anchor

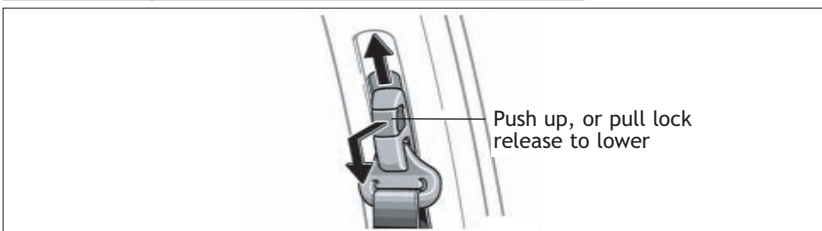

## Seat belts

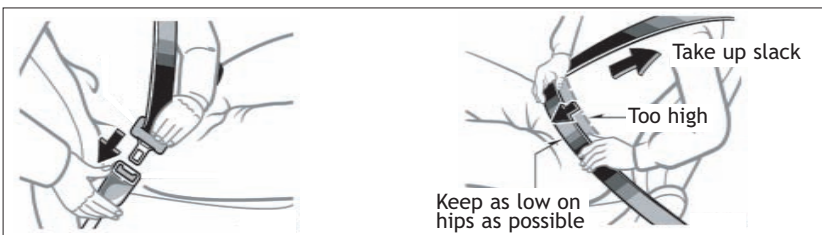

If belt is fully extended, then retracted even slightly, it cannot be re-extended beyond that point, unless fully retracted again. This feature is used to help hold child restraint systems securely.

To find more information about seat belts, and how to install a child restraint system, refer to the *Owner's Manual*.

## Tire Pressure Monitoring (warning) System



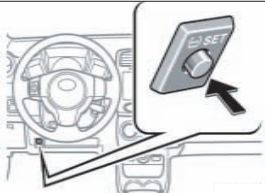

**System reset initialization**

1. Push and hold “ SET” button until the indicator blinks three times.
2. Wait several minutes to allow initialization to complete.

After adjusting tire pressures, or after tires have been rotated or replaced, turn the ignition switch to “ON” and press and hold the “ SET” button until indicator blinks three times. Let the vehicle sit for a few minutes to allow initialization to complete.

Refer to the load label on the door jamb or the *Owner’s Manual* for tire inflation specifications.

If the tire pressure indicator flashes for more than 60 seconds and then remains on, take the vehicle to your local Toyota dealer.

**Note:** The warning light may come on due to temperature changes or changes in tire pressure from natural air leakage. If the system has not been initialized recently, setting the tire pressures to factory specifications should turn off the light.

## Spare tire & tools

### Tool and spare tire location

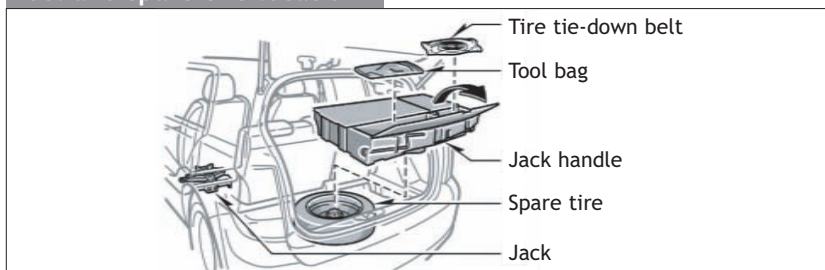

### Removing the spare tire

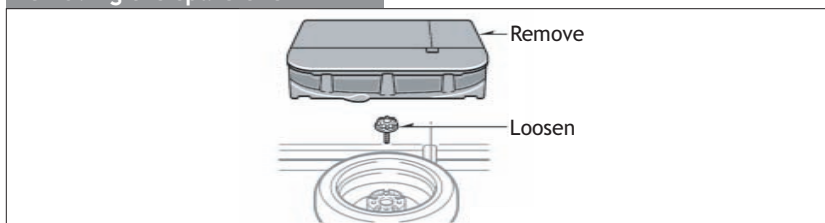

Refer to the *Owner’s Manual* for jack positioning and tire changing procedures.

**EMAIL**

[www.scion.com](http://www.scion.com)  
> Contact

-

**CHAT**

[www.scion.com](http://www.scion.com)  
> Have a Question?  
> Contact

-

**PHONE**

1.866.70.SCION

-

**MAIL**

SCION  
19001 S. Western Ave.  
D102, P.O. Box 2742  
Torrance, CA 90509-2742  
USA

-

**WEB**

[www.scion.com](http://www.scion.com)

-

©2009 Scion, a marque of  
Toyota Motor Sales, U.S.A., Inc.

00505-QRG09-XD

## Free Manuals Download Website

<http://myh66.com>

<http://usermanuals.us>

<http://www.somanuals.com>

<http://www.4manuals.cc>

<http://www.manual-lib.com>

<http://www.404manual.com>

<http://www.luxmanual.com>

<http://aubethermostatmanual.com>

Golf course search by state

<http://golfingnear.com>

Email search by domain

<http://emailbydomain.com>

Auto manuals search

<http://auto.somanuals.com>

TV manuals search

<http://tv.somanuals.com>