

# SEARS Kenmore

## CONTENTS

### SAFETY

..... 1-4

### USE AND CARE

Your Range and Its Features ..... 5

Cooktop Cooking ..... 6, 7

Oven Controls ..... 8, 9, 10

Oven Cooking ..... 10

Broiling ..... 11

Self-Clean Cycle ..... 12, 13

Cleaning Tips ..... 14

Removable Range Parts ..... 15-17

### SERVICE

Before Calling For Service ..... 18, 19

Adjusting Oven Temperature ..... 20

### WARRANTY

MODELS 45520, 45521



## USE • CARE • SAFETY MANUAL

IMPORTANT IMPORTANT IMPORTANT IMPORTANT IMPORTANT IMPORTANT IMPORTANT IMPORTANT IMPORTANT

# IMPORTANT INSTRUCTIONS FOR YOUR SAFETY

## SAVE THESE INSTRUCTIONS

Read all instructions before using this appliance. When using electrical appliances, basic safety precautions should be followed, including the following:



**Teach children not to play with control knobs or any other part of the range.**

**Never leave children alone or unattended where a range is in use.**

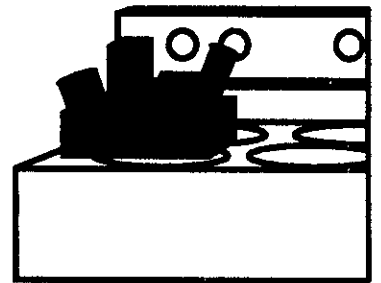

### Caution:

**Never store things children might want above a range.**

**Never let anyone climb, sit or stand on the range. They might be injured on a hot surface.**

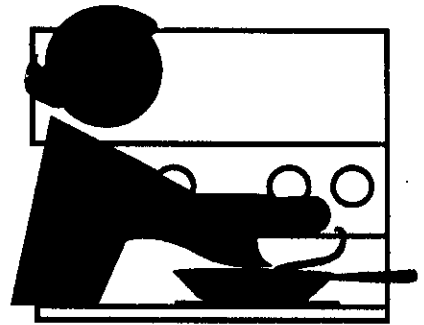

**Never leave an oven door open when you are not watching.**



IMPORTANT  
IMPORTANT  
IMPORTANT  
IMPORTANT  
IMPORTANT  
IMPORTANT  
IMPORTANT  
IMPORTANT  
IMPORTANT  
IMP

To insure safety for yourself and your home, please read your Owner's Manual carefully. Keep it handy for quick easy reference. Pay close attention to the safety sections of your manual. You can recognize the safety sections by looking for the  symbol or the word "Safety".

Always keep the range area clear and free from things that will burn.

**CAUTION:**

Never store things in an oven or near cooktop elements/burners. These things may catch fire and plastic items could melt.

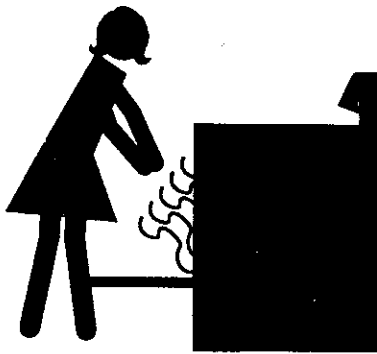

Never use your range for warming or heating a room. You could be burned or seriously injured. Such misuse could also cause damage to the range.

Never wear loose clothing when using your range. Such clothing could catch fire.



Never use a towel or other bulky cloth as a potholder. Such cloths could catch fire on a hot element/burner.

Never let pot handles stick out over the front of the range. Turn handles in so that they cannot be bumped into. Keep the handles away from other hot surface elements/burners.

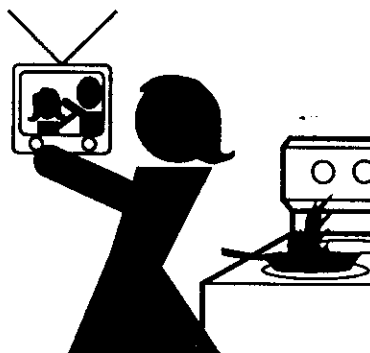

Never leave cooktop elements/burners unwatched at high heat settings. Boilovers cause smoking and greasy spillovers could catch fire.

# IMPORTANT SAFETY INSTRUCTIONS

**Keep this book for later use.**

**Be sure your range is installed and grounded properly by a qualified technician.**

**Always use care when touching cooktop elements, areas near the cooktop elements, oven heating elements or inside the oven. Heating elements could be hot enough to burn you even if they are dark in color. The oven vent duct and oven door may also become hot during oven use.**

**After broiling, always take the broiler pan out of the oven and clean it. Leftover grease in the broiler pan can catch on fire next time you use the pan.**

**Always use dry potholders when removing pans from the oven. Moist or damp potholders can cause steam burns.**

**Always use care when opening oven door. Let hot air and steam out before moving food.**

**Always keep the range and oven clean. Food and grease are easy to ignite. Clean the range, oven and vent hood regularly.**

**Always keep combustible wall coverings, curtains or drapes a safe distance away from your range.**

**Always keep dish towels, dish cloths, potholders and other linens a safe distance away from your range.**

**Always keep canned food and wooden or plastic utensils a safe distance away from your range.**

**Always follow cleaning instructions in this book.**

**Choose pots and pans with flat bottoms large enough to cover the entire cooktop element. This will cut down the risk of setting potholders or clothing on fire with an uncovered element and waste less energy.**

**Only certain kinds of glass or ceramic pans can be used for cooktop cooking. Be sure that the pan you use will not break when heated on the cooktop elements.**

**Teach children not to play with oven controls or any other part of the range.**

**Always remove the broiler pan and other utensils from the oven before a self-clean cycle.**

**Be sure the range is securely installed in a cabinet that is firmly attached to the house structure. Weight on the oven door could potentially cause the oven to tip and result in injury. Never allow anyone to climb, sit, stand or hang on the oven door.**

**Always keep the appliance area clear and free from things that will burn, gasoline and other flammable vapors and liquids.**

**Place oven racks in desired position while oven is cool.**

**Clean Only parts listed in the Manual.**

**Never try to repair or replace any part of the range unless instructions are given in this book. All other work should be done by a skilled technician.**

**A fan noise may be heard sometime during the clean cycle. This is normal.**

**Never heat unopened food containers. Pressure buildup may make container burst and cause injury.**

**Never leave jars or cans of fat or drippings on or near the oven. Never let grease build up on your oven. You can keep grease fires from starting if you clean up grease and spills after each oven use.**

**Never use aluminum foil to line oven bottoms. Improper use of foil could start a fire.**

**Never block free airflow through the oven vent.**

**Never try to move a pan of hot fat, especially a deep fat fryer. Wait until the fat has cooled.**

**Never leave children alone or unattended where a range is in use.**

**Never use your range for warming or heating a room. Such use can be dangerous and can damage oven parts.**

**Never wear loose fitting or hanging clothes while using your oven. Such clothes could catch fire and cause serious injury.**

**Never use a towel or other bulky cloth as a potholder. Such cloths could catch fire on a hot element.**

**Never put removable heating elements in water. Don't put them in a dishwasher. Do not put them in the self-clean cycle of self-cleaning ovens.**

**Never use the cooktop without reflector pans or drip bowls in place. If these pans or bowls are not there during cooking, wiring or other range parts may be damaged.**

**Never clean cooktop surface when it is hot. Some cleaners produce noxious fumes and wet cloths could cause steam burns if used on a hot surface.**

**Never try to clean utensils, cookware or removable parts of your range in the oven during a self-clean cycle. Do not use any type of commercial oven cleaner or oven liner protective coating in or around your oven.**

**Never store things in an oven or on your range.**

**Do Not clean door gasket without following instructions in this manual.**

**Never rub, move, or damage the door gasket on self-cleaning oven. The gasket is essential for a good seal.**

**If the self-cleaning mode malfunctions, turn off and disconnect the power supply. Have serviced by a qualified technician.**

**Do Not Use Oven Cleaners—No commercial oven cleaner or oven liner protective coating of any kind should be used in or around any part of the self-clean oven.**

## **IMPORTANT SAFETY INSTRUCTIONS (continued)**

**Read and understand this information NOW!**

**Should you ever need it, you will not have time for reading.**

**Be sure everyone in your home knows what to do in case of a fire.**

**Never use water on a grease fire - it will only spread the flames.**

### **OVEN FIRE**

**Do not try to move the pan.**

1. Close oven door and turn controls off.
2. If fire continues, throw baking soda on the fire, or use a Halon or dry chemical extinguisher.

### **COOKTOP GREASE FIRE**

**Never pick up a flaming pan. . . instead:**

1. Turn off the element.
2. Smother the fire with a tightly fitting pan lid, baking soda or a Halon or dry chemical extinguisher

---

## **IMPORTANT SAFETY NOTICE**

The California Safe Drinking Water and Toxic Enforcement Act requires the Governor of California to publish a list of substances known to the state to cause birth defects or other reproductive harm, and requires businesses to warn customers of potential exposure to such substances.

The fiberglass insulation in self-clean ovens gives off a very small amount of carbon monoxide during the cleaning cycle. Exposure can be minimized by venting with an open window or using a ventilation fan or hood.

# YOUR RANGE

## IMPORTANT:

The model and serial number of your oven can be found on a tag located below the lift-up cooktop, at the rear.

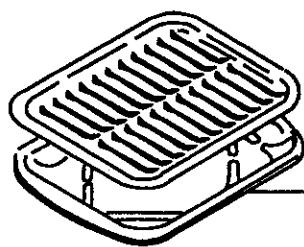
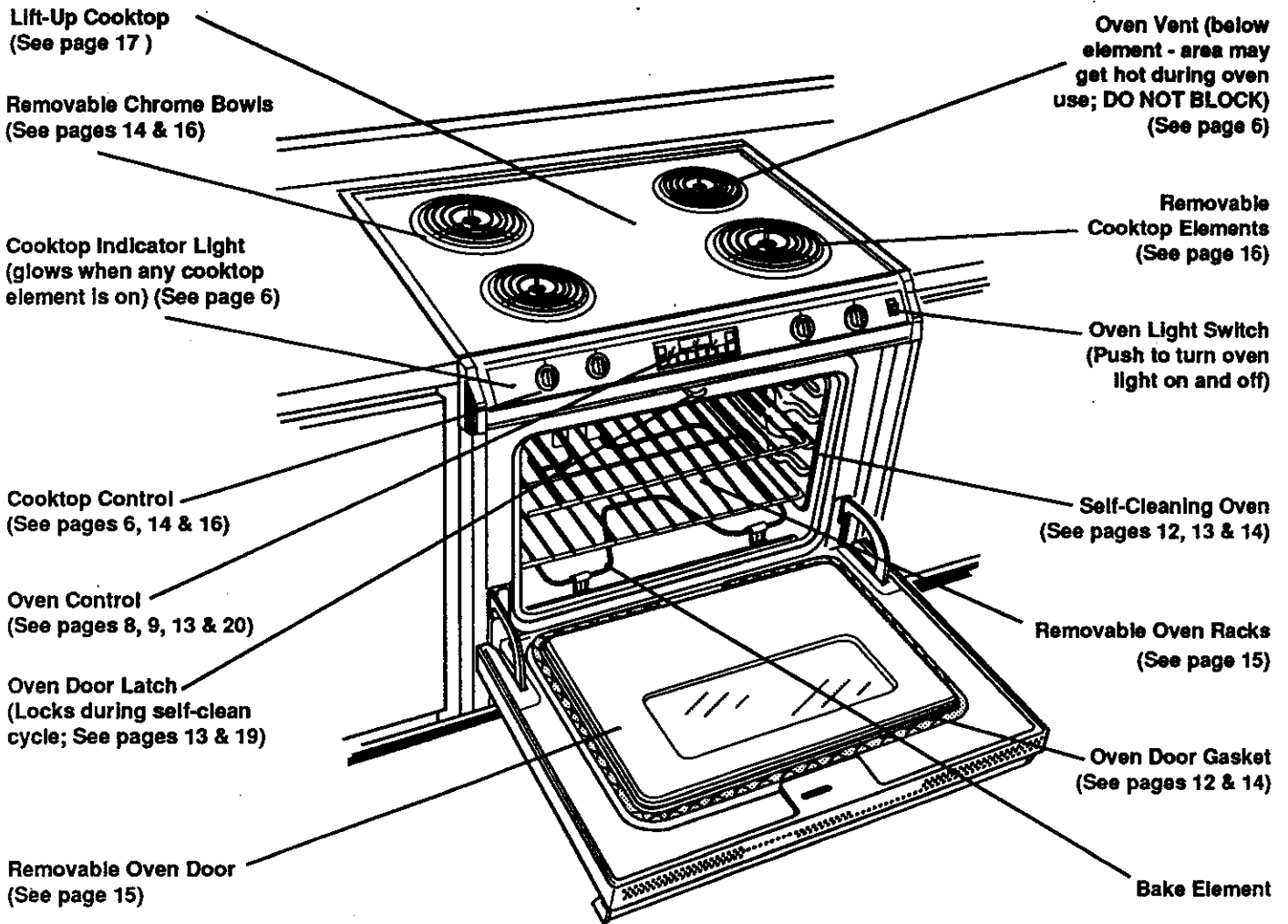

Broiler Pan & Grid  
(See pages 11 and 14)



## COOKTOP COOKING

The sign near each cooktop control knob shows which element is turned on by that knob.

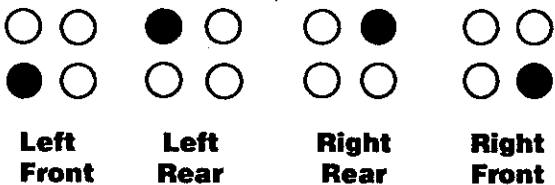

To operate cooktop controls:

1. Push cooktop control knob in and turn.
2. Set on or between marks for desired heat.

An indicator light will glow when any cooktop element is on.

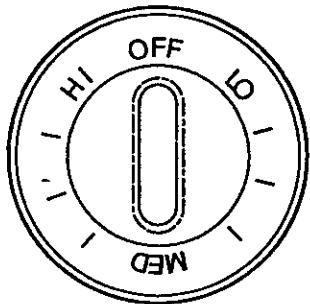

COOKTOP CONTROL

For best cooking results and energy efficient operation, you should use pans that:

- A. Have flat bottoms and straight sides.
- B. Have light handles that do not tilt pans.
- C. Are about the same size as the element.

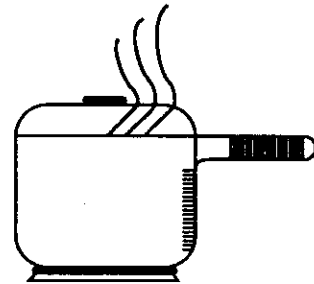

When the oven is on, heated air moves through a vent under the right rear cooktop element. This hot air may make pot handles hot or melt plastic items left too near the vent. The vent is necessary for proper oven performance. Do not block it.



**Never line the bowls below cooktop elements with aluminum foil. Foil can block normal heat flow and damage the range. This is especially true if foil blocks the oven vent tube under the right rear cooktop element.**

## QUESTIONS & ANSWERS

**Q. May I can foods and preserves on my surface units?**

A. Yes, but only use cookware designed for canning purposes. Check the manufacturer's instructions and recipes for preserving foods. Be sure canner is flat-bottomed and fits over the center of your surface unit. Since canning generates large amounts of steam, be careful to avoid burns from steam or heat. Canning should only be done on surface units.

**Q. Can I cover my drip pans with foil?**

A. No. Clean as recommended in Cleaning Tips. Do not use aluminum foil to line drip pans or anywhere in the oven except as described in this book. Misuse could result in a shock, fire hazard, or damage to the range.

**Q. Can I use special cooking equipment, like an oriental wok, on any surface units?**

A. We recommend flat bottomed woks. Cookware without flat surfaces is not recommended. The life of your surface unit can be shortened and the range top can be damaged from the high heat needed for this type of cooking.

**Q. Why am I not getting the heat I need from my units even though I have the knobs on the right setting?**

A. After turning surface unit off and making sure it is cool, check to make sure that your plug-in units are securely fastened into the surface connection.

**Q. Why does my cookware tilt when I place them on the surface unit?**

A. Because the surface unit or the cookware is not flat. Make sure that the "feet" on your surface units are sitting tightly in the range top indentation and the outer edge of the drip pan is flat on the range surface.

**Q. Why is the porcelain finish on my cookware coming off?**

A. If you set the temperature of your surface unit higher than required for the cookware material and leave it, the finish may smoke, crack, pop or burn, depending on the pot or pan. Also, a too high heat for long periods, and small amounts of dry food, may damage the finish.

## HOME CANNING TIPS

In surface cooking of foods other than canning, the use of large-diameter pots (extending more than 1" beyond edge of drip pan) is not recommended. However, when canning with water-bath or pressure canner, large-diameter pots may be used. This is because boiling water temperatures (even under pressure) are not harmful to cooktop surfaces surrounding heating unit.

**HOWEVER, DO NOT USE LARGE DIAMETER CANNERS OR OTHER LARGE DIAMETER POTS FOR FRYING OR BOILING FOODS OTHER THAN WATER.**

Most syrup or sauce mixtures — and all types of frying — cook at temperatures much higher than boiling water. Such temperatures could eventually harm cooktop surfaces surrounding heating units.

## OBSERVE FOLLOWING POINTS IN CANNING

1. Bring water to boil on HIGH heat, then after boiling has begun, adjust heat to lowest setting to maintain boil (saves energy and best uses surface unit).
2. Be sure canner fits over center of surface unit. If your range does not allow canner to be centered on surface unit, use smaller-diameter pots for good canning results.

3. Flat-bottomed canners give best canning results. Be sure bottom of canner is flat or slight indentation fits snugly over surface unit. Canners with flanged or rippled bottoms (often found in enamelware) are not recommended.

RIGHT



WRONG

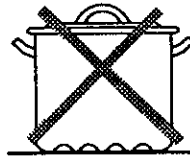

4. When canning, use recipes from reputable sources. Reliable recipes are available from the manufacturer of your canner; manufacturers of glass jars for canning, such as Ball and Kerr; and the United States Department of Agriculture Extension Service.
5. Remember, in following the recipes, that canning is a process that generates large amounts of steam. Be careful while canning to prevent burns from steam or heat.

**NOTE:** If your range is being operated on low power (voltage), canning may take longer than expected, even though directions have been carefully followed. The process may be improved by:

- (1) using a pressure canner, and
- (2) beginning with hot tap water when heating larger quantities of water.



# RANGE CONTROL

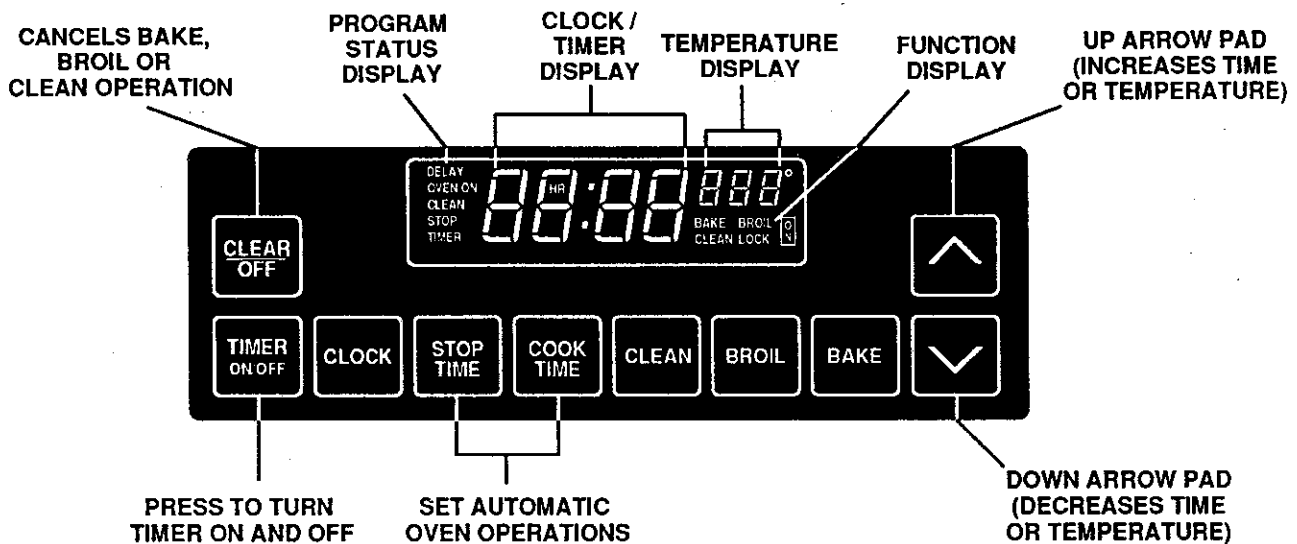

Your range control is touch controlled. To set BAKE, BROIL, TIMER or CLEAN, touch the desired function pad and select the temperature or time by touching the arrow pad. Hold your finger on the arrow pad to change display numbers quickly. Touch and release the arrow pad to change display numbers slowly.

## TO SET THE CLOCK:

1. Press the **CLOCK** pad. The word "TIME" will flash in the display.
2. Press the **UP** or **DOWN** arrow pad to select the correct time of day. The clock will start automatically.

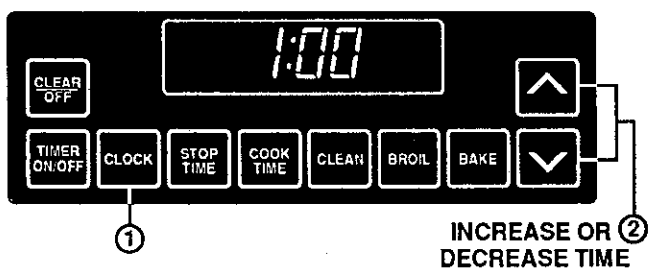

## TO CANCEL THE TIMER:

Press and hold the **TIMER ON/OFF** pad until the time of day returns to the display (about 4 seconds).

## TO SET BAKE:

1. Press the **BAKE** pad. "BAKE" will flash in the display.
2. Press the **UP** or **DOWN** arrow pad to select the desired temperature. The last bake temperature you used will appear in the temperature display. Increase the temperature with the **UP** arrow pad. Decrease the temperature with the **DOWN** arrow pad.

If you do not set a temperature after you press BAKE, the display will go blank. Repeat steps 1 and 2.

3. When baking is complete, press the **CLEAR/OFF** pad.

## TO SET THE TIMER:

**NOTE: The TIMER does not control oven operations. The maximum time setting is 9 hours and 55 minutes.**

1. Press the **TIMER ON/OFF** pad. "TIMER" will flash in the display.
2. Press the **UP** or **DOWN** arrow pad to select the amount of time. The **TIMER** will automatically begin counting down after a few seconds.
3. When the time is up, the end-of-cycle tone will beep. Press the **CLOCK** pad to return the time of day to the display.

## TO RESET THE TIMER:

If you have set the timer and wish to change the time:

1. Press the **TIMER ON/OFF** pad.
2. Press the **UP** or **DOWN** arrow pad to select the time.

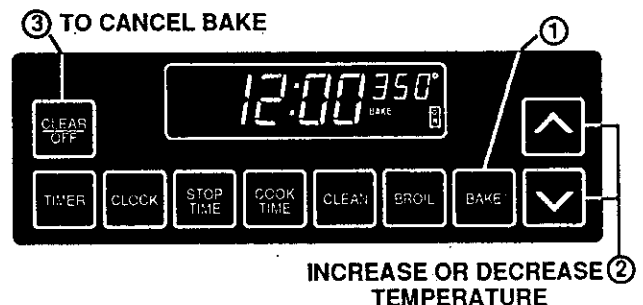

## TO SET BROIL:

1. Press the **BROIL** pad. "BROIL" will flash and (---) will appear in the display.
2. Select **LO BROIL** by pressing the **UP** arrow pad once. Select **HI BROIL** by pressing the **UP** arrow pad twice. To change from **HI BROIL** to **LO BROIL**, press the **DOWN** arrow pad.
3. After cooking is complete, press the **CLEAR/OFF** pad.

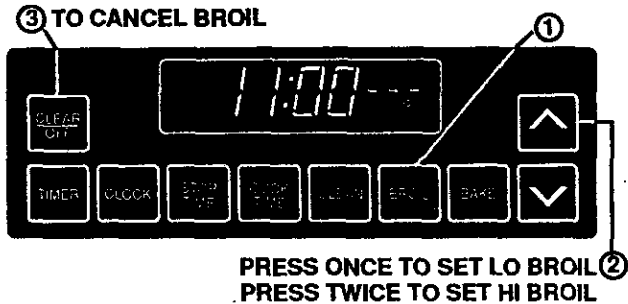

## TO RESET BROIL:

If you do not select **LO** or **HI BROIL** the function display will go blank.

1. Press the **BROIL** pad.
2. Press the **UP** or **DOWN** arrow pad.

## TIMED BAKING:

### AUTOMATIC OVEN OFF:

You can begin baking now and set the oven to turn **OFF** automatically.

1. Press the **COOK TIME** pad.
2. Press the **UP** or **DOWN** arrow pad to set how long you want to bake.
3. Press the **BAKE** pad.
4. Press the **UP** or **DOWN** arrow pad to select the temperature you prefer. Use the temperature in your recipe.

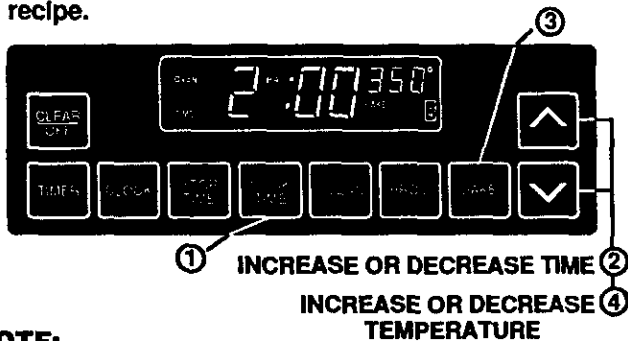

### NOTE:

You should consider that food left in the oven will continue to cook after the control turns **OFF**, unless you remove the food immediately.

## DELAYED ON AND OFF:

You can set the oven to turn on and off automatically. The control will calculate the time to start cooking.

1. Press the **COOK TIME** pad.
2. Press the **UP** or **DOWN** arrow pad to set how long you want to bake. Use the time given in your recipe.
3. Press the **STOP TIME** pad. The **OVEN CONTROL** will calculate the earliest stop time you can set. This time will appear in the display.
4. Press the **UP** or **DOWN** arrow pad if you want to change the calculated **STOP TIME**.
5. Press the **BAKE** pad.
6. Press the **UP** or **DOWN** arrow pad to select the temperature. Use the temperature in your recipe.
7. Press the **CLOCK** pad to return to the time of day.

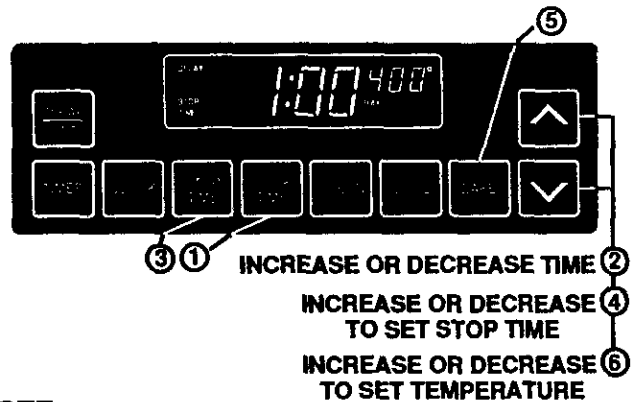

### NOTE:

If the control beeps, you have not completed your timed oven setting. Press the **CLEAR/OFF** pad and start again with Step 1.



The low temperature zone of this range (between 150°F and 200°F) is available to keep hot cooked foods warm. Food kept longer than two hours at these low temperatures may spoil.



Never let food, such as dairy products, fish, meat, poultry, etc., sit for more than 1 hour before cooking starts when you set your oven for a delay start. Room temperature promotes the growth of harmful bacteria. Be sure the oven light is off because heat from the bulb will speed bacteria growth.

## DISPLAY:

Once you have programmed your control for any operation, you can display the setting by pressing the appropriate pad. For example, if you are using the **TIMER** and want to see the time of day, press **CLOCK**. The display will show the time of day.

**NOTE:** You cannot set **BAKE**, **BROIL** or **COOK TIME** while the oven door is in the locked position. If you try, the word "door" will appear in the display. The oven door lock is to be used for Self-Cleaning only.

## TONES:

The end-of-cycle tone will sound at the end of timer use and automatic oven functions. The end-of-cycle tone is 3 short beeps followed by 1 beep every 6 seconds that repeat until you press any operation. If you would like to eliminate the repeating beeps, push and hold **CLEAR/OFF** for ten seconds. To return the 1 beep every 6 seconds, push and hold **CLEAR/OFF** for 10 seconds.

To cancel the end-of-cycle tone, press any key except the **UP** or **DOWN** arrow key.

## F-CODE:

If the time display beeps continuously and flashes an "F" followed by a number, you have a function error code. Note the number after the "F". Press **CLEAR/OFF**. Allow oven to cool for 1 hour. If problem repeats, disconnect all power to the range and call for service. Advise your service technician of the number following the "F" in the display.

## OVEN COOKING

- When cooking a food for the first time in your new oven, use time given on recipes as a guide.  
Your new oven has been set correctly at the factory and is more apt to be accurate than the oven it replaced.  
After you have used your oven for awhile, if you feel your oven should be hotter or cooler, you can adjust it yourself. See **TEMPERATURE ADJUSTMENTS** in this manual.
- Always follow recipe carefully.
- Measure ingredients properly.
- Use proper pan placement.
- Place pans on the oven racks with 1" to 1 1/2" of air space on all sides of each pan. Avoid overcrowding the oven.
- Pans too close to each other, to oven walls or to the oven bottom block the free movement of air. Improper air movement causes uneven browning and cooking.

- When baking several items stagger pans so that no pan is directly above another.
- Let the oven preheat thoroughly before cooking baked products. Listen for preheat notification tone or watch for the indicator light to go off. If your range does not have either of these features, preheat for 10 minutes and put the food in the oven.
- Opening the door too often to check food during baking will allow heat loss and may cause poor baking results.



2 cake layers

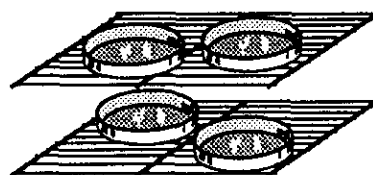

4 cake layers

- Cakes, cookies, muffins, and quick breads should be baked in shiny pans — to reflect the heat — because they should have a light golden crust. Yeast breads and pie crusts should be baked in glass or dull (non-shiny) pans — to absorb the heat — because they should have a brown, crisp crust.
- Be sure the underside of the pan is shiny, too. Darkened undersides will absorb the heat and may cause over-browning on the bottom of your food.
- Oven temperatures should be reduced 25 degrees below recommended temperatures if exterior of pan is predarkened, darkened by age or oven proof glass.
- There may be some odor when the oven is first used. This is caused by the heating of new parts and insulation.
- Do not cover an entire oven rack with foil. The foil can block normal heat flow and cause poor baking results. Do not place any foil directly above the bake element. Foil used on the oven bottom under the element may damage the oven surface; therefore, it should not be used.
- Cookies should be baked on flat cookie sheets without sides to allow the air to circulate properly.
- When recipes require preheating, have food nearby before you open the oven door. If the oven door is allowed to remain open for more than a brief time, the preheat temperature will be lost.

## BROILING

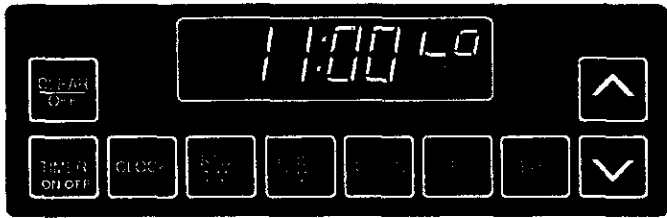

Most foods can be broiled at the HI Broil Setting. Select the LO Broil setting to avoid excessive browning or drying of foods that should be cooked to the well-done stage (such as thick pork chops or poultry).

### BROILING TIPS

**Please note:**

**Your oven door should be open to the broil stop position while broiling. If the door is closed, the food will roast and not broil.**

- Use only the broiler pan and grid that came with your range for broiling. They are designed for proper drainage of fat and liquids and help prevent spatter, smoke or fire.
- **Do not preheat when broiling.** For even broiling on both sides, start the food on a cold pan.
- Trim the outer layer of fat from steaks and chops. Silt the fatty edges to keep the meat from curling.
- For maximum juiciness, salt the first side just before turning the meat. Salt the second side just before serving.
- Brush chicken and fish with butter several times as they broil. When broiling fish, grease the grid to prevent sticking and broil with skin side down. It is not necessary to turn fish.
- **Never leave a soiled broiler pan in the range.** Grease in the pan may smoke or burn the next time the oven is used.
- Be sure you know the correct procedure for putting out a grease fire. See the section on safety.



**Do not cover the entire broiler grid with foil (mold foil tightly to grid and cut slits in foil to align with slits in the grid). Poor drainage of hot fat may cause a broiler fire.**

**If a fire starts, close the oven door and turn controls off. If fire continues, throw baking soda on the fire. Do not put water on the fire.**

## POSITIONING BROILER PAN

Broiling is cooking by direct heat from the broil element. Tender cuts of meat or marinated meat should be selected for broiling. For best results steaks and chops should be at least 3/4" thick.

After placing food on the broiler pan, put the pan on an oven rack in the proper position. The recommended rack position and cooking time can be found in the chart below.

The closer the food is to the broil element, the faster the meat browns on the outside, yet stays red to pink in the center. Moving the meat farther away from the element lets the meat cook to the center while browning outside. Side one should be cooked 1 - 2 minutes longer than side two.

Food	Rack Position	Total Time (minutes)	
	4 = Highest 1 = Lowest		
Steak - 1" Thick			
	Rare	4	9-11
	Medium	3	13-15
	Well Done	3	21-23
Ground Beef Patties			
	Medium-1" Thick	3	16-18
	Medium-1/2" Thick	4	7-9
Lamb Chops - 1" Thick	3	18-21	
Pork Chops - 1" Thick	3	27-29	
Pork Chops - 1/2" Thick	3	16-18	
Ham Slice - 1/2" Thick	3	11-12	
Fish (Filets)	3	11-13	
Chicken (Pieces)	2	45-55	
Frankfurters	3	8-11	
Bacon	3	9-11	

This chart is a general guide. The size, weight, thickness, and starting temperature of the food, as well as your own personal preference, will affect the cooking time. Times in the chart are based on the food being at refrigerator temperature.

# THE SELF-CLEAN CYCLE

## BEFORE A CLEAN CYCLE

1. Remove the broil pan and grid, oven racks, all utensils and any foil that may be in the oven. Do not try to clean utensils or any other objects in the oven during a self-clean cycle. **If oven racks are left in the range during a clean cycle, they will darken, lose their luster and become hard to slide.** If you choose to leave the racks in the oven, you can polish the edges of the racks with steel wool and apply a small amount of vegetable oil to the rack edges after the self-clean cycle. This will make the racks easier to slide.
2. Soil on the oven front frame, under the front edge of the cooktop, the door liner outside the door gasket and the front edge of the oven cavity (about 1" into the oven) will not be cleaned during a clean cycle (see illustration below). Clean these areas by hand before starting a clean cycle.  
Use hot water with a soap-filled steel wool pad, then rinse well.

3. Wipe up heavy spillovers on the oven bottom. Too much soil may cause smoking during the clean cycle.
4. Do not rub the door gasket. The fiberglass material of the gasket has an extremely low resistance to abrasion. An intact and well fitting oven door gasket is essential for energy efficient oven operation and good baking results. If you notice the seal becoming worn, frayed or damaged in any way or if it has become displaced on the door, you should replace the gasket. The gasket is designed with a 5-6" gap at the bottom for proper air circulation.

## AFTER A CLEAN CYCLE

After a clean cycle, you may notice some white ash in the oven. Just wipe it up with a damp cloth.

If white spots remain, remove them with a soap-filled steel wool pad. Be sure to rinse thoroughly. These deposits are usually a salt residue that cannot be removed by the clean cycle.

If the oven is not clean after one clean cycle, the cycle may be repeated.

**NOTE:** Your oven light should be OFF during a self-clean cycle to prolong the life of the bulb.

This range has a fan that will turn "ON" and "OFF" by itself to keep the electronics cool. Sometimes it will run after the range has been turned off.

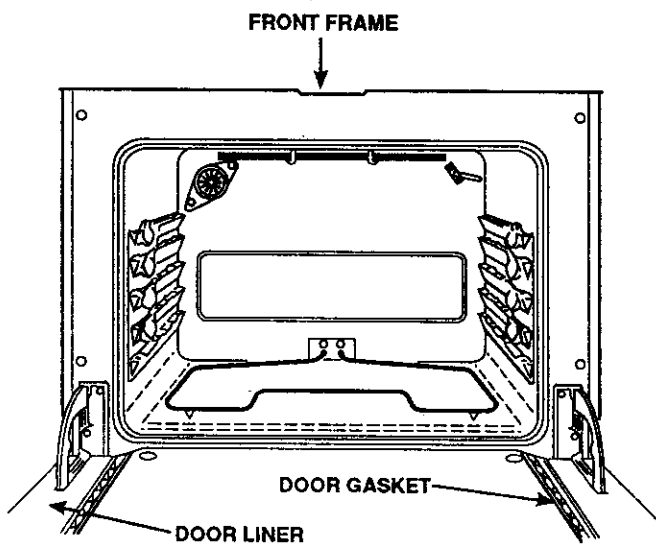

## TO SET SELF-CLEAN CYCLE:

1. Close oven door. Press the **CLEAN** pad. The time display will show (---). See Fig. 1. You may need to press slightly on the door.

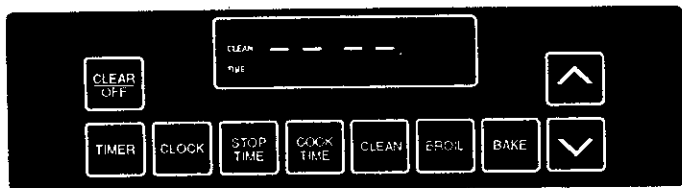

Fig. 1

2. Press the UP or DOWN arrow pad to set the desired length of clean time. **Clean time is normally 3 hours.** You can change it between 2 and 4 hours, depending on how dirty the oven is. See Fig. 2. The door locks automatically after the controls are set. The display will show "LOCK" when door locks.



Fig. 2

You can push the **STOP TIME** to find out when the cycle will end. Push the **CLEAN** pad to return to countdown.

## WHEN A CLEAN CYCLE IS FINISHED:

1. Wait until the **LOCK** display goes out. The oven temperature must drop to a safe level before the door can be opened. See Fig. 3.

WAIT UNTIL LOCK GOES OUT



Fig. 3

If you cannot open the door immediately after the word **LOCK** goes off, wait about one minute and try again.

## TO INTERRUPT A CLEAN CYCLE:

1. Push **CLEAR/OFF**.

Follow instructions under "WHEN A CLEAN CYCLE IS FINISHED."

## TO SET DELAYED SELF-CLEAN CYCLE:

1. Close oven door. Press the **CLEAN** pad. The time display will show (---). See Fig. 1. You may need to press slightly on the door.
2. Press the UP or DOWN arrow pad to set the desired length of clean time. **Clean time is normally 3 hours.** You can change it between 2 and 4 hours, depending on how dirty the oven is. See Fig. 2. The door locks automatically after the controls are set. The display will show "LOCK" when door locks.
3. Press the **STOP TIME**.
4. Set the time of day when you want the clean cycle to end. See Fig. 4.

The control will calculate when to start clean cycle time.



Fig. 4

**Note:** When selecting a stop time for a delayed clean cycle, you must allow time for the 2-4 hour clean time.

Your oven light should be OFF during a self-clean cycle to prolong the life of the bulb.

## CLEANING TIPS

### REMOVAL OF PACKAGING TAPE

The safest way to remove adhesive left from packing tape on new appliances, to assure no damage is done to the finish of the product, is an application of household liquid dishwashing detergent, mineral oil or cooking oil. Apply with a soft cloth; DO NOT use a plastic pad or equivalent. Wipe dry and then apply any appliance polish to thoroughly clean and protect the surface. This procedure is also safe for the face of microwave doors and other plastic parts.

**NOTE:** The plastic tape that is not removed from chrome trim on range parts **CANNOT** be removed if baked on.

## CLEANING TIPS (CONTINUED)

Refer to removable parts section when cleaning your range.

Warm water, a mild detergent, and a soft cloth are safe to use on all cleanable parts of your range. Do not use metal scouring pads, except where recommended.

Range cooktop finishes will be either porcelain enamel or brushed chrome. Porcelain enamel looks like a painted surface. Brushed chrome has a metallic appearance.

PART	CLEANING MATERIALS	REMARKS
Control panel knobs	Detergent, warm water, soft cloth	Do not use abrasive cleaners. Knobs pull off for easier cleaning.
Porcelain enameled cooktop, oven door	Detergent, warm water, plastic or nylon scouring pad	Clean after each spillover. Rub bowls gently with scouring pad. Soak stubborn soil.
Brushed chrome cooktop (some models)	Detergent, warm water, soft cloth or a chrome cleaner or Sears Cooktop Cleaning Creme®	Do not scour chrome tops. Stubborn stains may be removed by using Espree Magwheel Cleaner® or Turtle Wax Polishing Compound®.
	To remove fingerprints on brushed chrome, apply a little baby oil with a paper towel. Rub in the direction of the brush marks. Armor All Protectant® can also be used (after cleaning). Be sure to clean spills of acidic foods quickly. Vinegar spills can permanently stain chrome.	
Chrome reflector bowls		Bowls can permanently discolor if exposed to excessive heat or if soil is allowed to bake on.
Brown food stains	Detergent and water, plastic scouring pads, mild abrasive cleaners, soap-filled scouring pads, ammonia	After each use, wash, rinse and dry to prevent difficult soils. If heavily soiled, place an ammonia-soaked paper towel on stains to loosen soil, then gently scrub with plastic scouring pad.
Blue/gold heat stains	Metal polish	These stains are caused by overheating, normally occur over a period of time, and usually are permanent.
	To minimize:	
	<ol style="list-style-type: none"> <li>1. Avoid excessive use of the high heat setting. Use it to start cooking, then lower the heat setting to finish cooking.</li> <li>2. Use flat bottom pans that do not extend more than two inches from the surface element. If large pans or canners are used, alternate the elements that are used.</li> </ol>	
Glass	Glass cleaner and paper towels	Remove stubborn soil with paste of baking soda and water. Do not use abrasive cleaners. Rinse thoroughly.
Self-cleaning oven finish	Detergent, warm water, scouring pad or soap-filled steel wool pad	Rinse thoroughly after cleaning. Cleaning inside the oven need only be done as an optional touchup between self-clean cycles. See the self-cleaning oven section of this manual for more information.
Oven door gasket	Do not clean	See self-cleaning section for more information.
Broiler pan and grid	Detergent, warm water, soap-filled scouring pad, plastic scouring pad, commercial oven cleaner (pan only)	Remove soiled pan from oven to cool. Drain fat or drippings. Fill pan with warm water. Sprinkle grid with detergent and cover with damp cloth or paper towels. Let pan and grid soak for a few minutes. Rinse or scour as needed. Dry well. Grid and pan may be washed in a dishwasher.
Oven racks	Detergent, warm water, scouring pad or soap-filled steel wool pad	Remove from oven to clean. Rinse thoroughly.

## REMOVABLE OVEN DOOR

### To remove:

1. Open the door to the stop position (see illustration).
2. Grasp the door at each side and lift up and off the hinges. Do not lift door by the handle. Glass breakage or damage to the door could result.

**NOTE:** When the door is removed and hinge arms are at stop position, do not bump or try to move the hinge arms. The hinges could snap back causing an injury to the hands or damage to the porcelain on the front of the range. Cover the hinges with toweling or empty towel rolls while working in the oven area.

### To replace:

1. Hold the door over the hinges with the slots at the bottom edge of the door lined up with the hinges. The hinge arms must still be in the stop position.
2. Slide the door down onto the hinges as far as it will go and close the door.

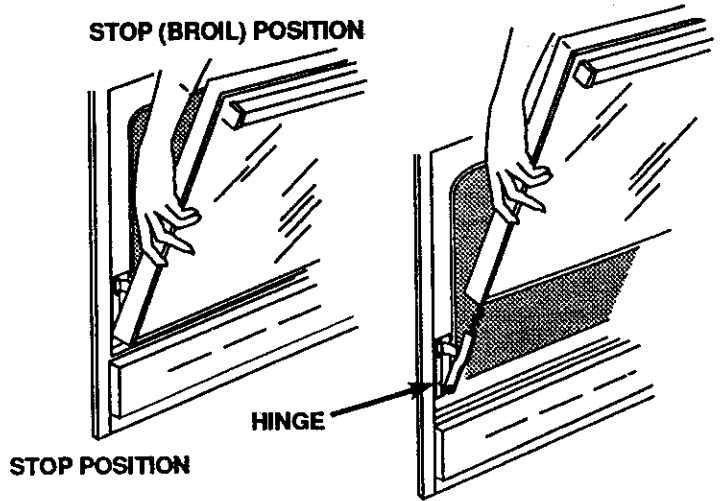

## REMOVABLE OVEN RACKS

Be careful not to scratch the oven finish when installing or removing oven racks.

### To install:

1. Set the raised back edge of the rack on a pair of rack guides.
2. Push the rack in until you reach the bump in the rack guide, then lift the front of the rack a bit and push the rack all the way in.

### To remove:

1. Pull the oven rack out, then up, in one motion. See the cleaning chart.

**Note:** For best performance remove oven racks during a clean cycle. If oven racks are left in the range during a clean cycle, they will darken, lose their luster and become hard to slide. If you choose to leave the racks in the oven, you can polish the edges of the racks with steel wool and apply a small amount of vegetable oil to the rack edges after the self-clean cycle. This will make the racks easier to slide.

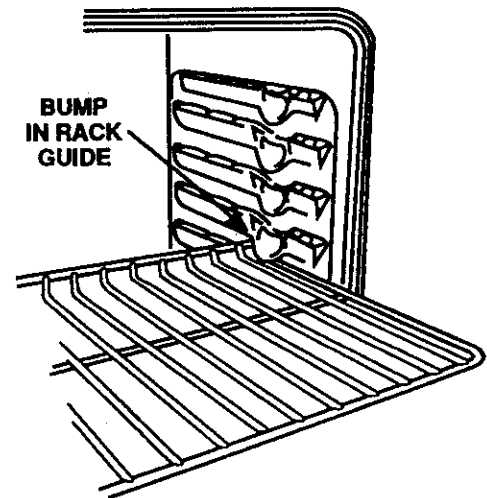

**Note:** The racks are designed with stop locks. When the racks are placed correctly on the rack support and extended from the oven the stop locks prevent the racks from tilting when removing foods from them or placing foods on them.



## REMOVABLE KNOBS

All control knobs may be removed for easy cleaning by pulling the knob straight off the stem. Be sure that the knob is in the OFF position before removal.

Hint: Slip a thin cloth (such as a handkerchief) or a piece of string under and around the knob edge and pull up.



**Caution:** Read these instructions carefully before replacing the knobs. Replacing the knobs improperly will damage the knobs and the spring clip on the stems. If this happens, the knobs will fit loosely.

### To replace the knob:

1. The knob stem has a groove in each side. The groove on one side has a spring clip. The other groove is clear (see illustration).
2. Check the inside of the knob and find the molded rib.
3. Replace the knob by fitting the molded rib inside the knob into the clear groove on the stem.

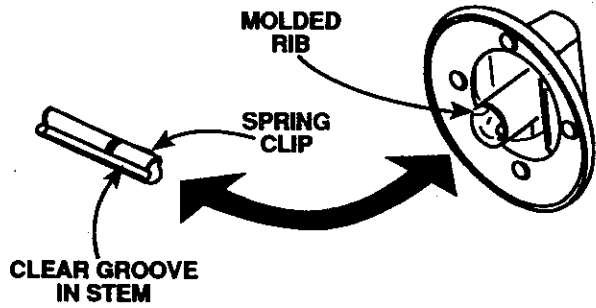

**Note:** Be sure to replace knobs on correct stems from which they came.

## REMOVABLE COOKTOP UNITS

The cooktop elements can be unplugged and the bowls removed for cleaning.

**Be sure all cooktop unit control knobs are turned off and elements are cool before you remove or replace a cooktop unit.**

### To remove:

1. Grasp element, tilt it upward slightly to clear the bowl, then pull away from the receptacle. The element will not sit level when replaced if it is forced too far upward when removed.
2. For models with porcelain enameled reflector bowls, remove the chrome trim ring.
3. Lift out the bowl.

Do not put the element into water. It cleans itself when heated during normal use.

### To replace:

1. Replace the bowl. Be sure the receptacle is showing in the bowl opening.
2. For models with porcelain enameled reflector bowls, replace chrome trim ring.
3. Slide the plug of the element firmly into the receptacle and lower the element into place.

**IMPORTANT:** Never operate a cooktop element without the bowl in place. This can cause scorching of the cooktop, burning of wiring insulation and loss of energy.

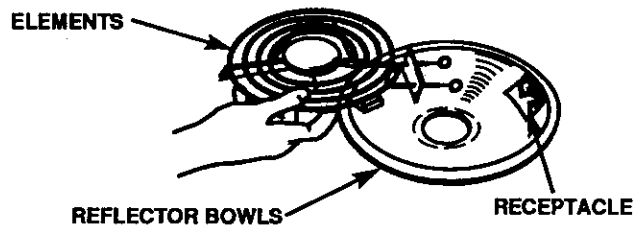

**CAUTION:** Do not pull element up more than 1" or damage to the receptacle will occur.

## LIFT-UP COOKTOP

The range has a support to hold the cooktop up while cleaning.

Raise the support as shown in the illustration.

Porcelain enamel can chip if dropped. Handle porcelain enameled cooktops carefully.

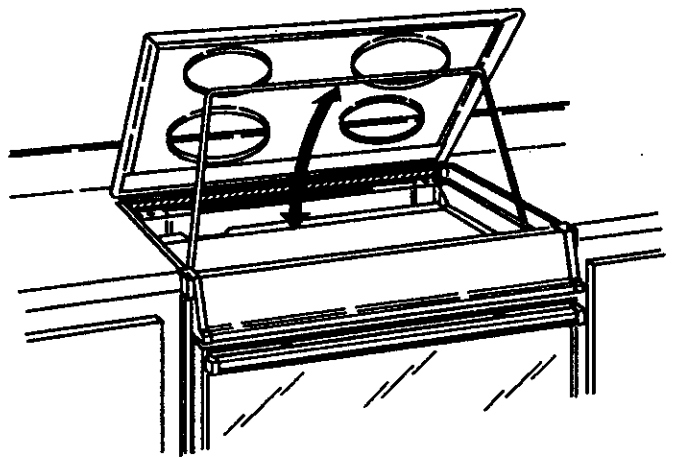

## REPLACING THE OVEN LIGHT

Be sure that the light switch is in the off position. Do not touch hot oven bulb. Do not touch oven bulb with wet hands. Do not wipe oven light area with wet cloth.

Never touch the electrically live collar on the bulb when replacing it.

Electrical power must be shut off if you have to replace a broken bulb.

1. Unscrew glass cover and remove.
2. Replace the bulb with a 40 watt appliance bulb.
3. Replace the cover.

**Note:** We recommend you use a 40 watt appliance bulb that is no longer than 3 1/2".

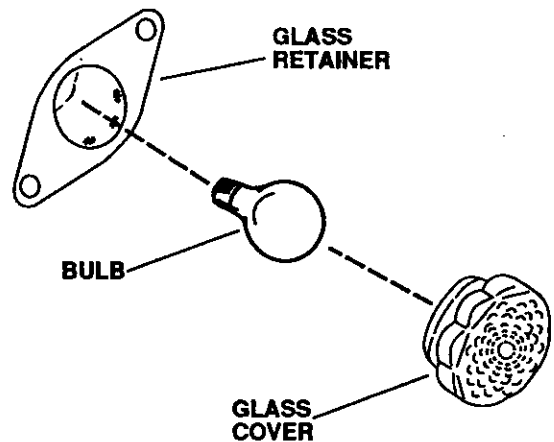

# BEFORE CALLING FOR SERVICE

**Save time and money — Check this list before you call for service.**

To eliminate unnecessary service calls, first, read all the instructions in this manual carefully. Then, if you have a problem, always check this list of common problems and possible solutions before you call for service.

If you do have a problem you cannot fix yourself, call your nearest Sears Store or Service Center for help. When calling, have this manual, the Repair Parts List, Model Number, Serial Number and purchase date handy.

<b>PROBLEM</b>	<b>POSSIBLE CAUSE</b>	<b>DON'T CALL FOR SERVICE UNTIL YOU CHECK</b>
<ul style="list-style-type: none"> <li>• Range display is flashing "F" and a number; oven stops working-surface works</li> </ul>	<ul style="list-style-type: none"> <li>• Range display is flashing "F" and a number; oven stops working-surface works</li> </ul>	<ul style="list-style-type: none"> <li>• Press CLEAR/OFF. Let the range cool down for one hour. Place range back into cooking or cleaning cycle. If problem repeats, call for service.</li> </ul>
<ul style="list-style-type: none"> <li>• Range does not work; totally inoperative</li> </ul>	<ul style="list-style-type: none"> <li>• No power to range</li> </ul>	<ul style="list-style-type: none"> <li>• Check appliance's individual circuit breakers located behind storage drawer.</li> <li>• Check household circuit breaker or fuse.</li> <li>• Check cord (if equipped) to be sure it is plugged in.</li> </ul>
<ul style="list-style-type: none"> <li>• Oven does not heat; cooktop elements OK</li> </ul>	<ul style="list-style-type: none"> <li>• Clock set incorrectly (if equipped)</li> <li>• Oven controls set incorrectly</li> </ul>	<ul style="list-style-type: none"> <li>• Check clock instructions.</li> <li>• Check oven control.</li> </ul>
<ul style="list-style-type: none"> <li>• Cooktop does not work; oven OK</li> </ul>	<ul style="list-style-type: none"> <li>• Element(s) unplugged</li> <li>• Improper operation of control</li> </ul>	<ul style="list-style-type: none"> <li>• Check element connections by removing and re-plugging element(s) firmly.</li> <li>• Be sure knob is pushed in while turning.</li> </ul>
<ul style="list-style-type: none"> <li>• Foods do not bake properly</li> <li>• Oven temperature seems inaccurate</li> </ul>	<ul style="list-style-type: none"> <li>• Oven not preheated long enough</li> <li>• Improper rack or pan placement</li> <li>• Oven vent blocked or covered</li> <li>• Improper use of foil</li> <li>• Improper temperature setting for utensil used</li> <li>• Recipe not followed</li> <li>• Using improper cookware</li> <li>• Thermostat calibration</li> </ul>	<ul style="list-style-type: none"> <li>• Be sure to pre-heat: until notification tone sounds.</li> <li>• Maintain uniform air space around pans and utensils; see cooking hints section.</li> <li>• Reflector bowl must have hole in center over oven vent.</li> <li>• Foil use not recommended.</li> <li>• Reduce temperature 25° for glass or dull/darkened pans.</li> <li>• Is recipe tested and reliable?</li> <li>• See cooking hints.</li> <li>• See adjustments described following this section.</li> </ul>
<ul style="list-style-type: none"> <li>• Surface works; oven stops working and range display is flashing</li> </ul>	<ul style="list-style-type: none"> <li>• Possible range malfunction</li> </ul>	<ul style="list-style-type: none"> <li>• Let range cool down for one hour. Place range back into cooking or cleaning cycle. If problem repeats, call for service.</li> </ul>
<ul style="list-style-type: none"> <li>• Fan comes on during bake, broil, or clean (if so equipped)</li> </ul>	<ul style="list-style-type: none"> <li>• This is normal operation of a fan designed to cool the range's internal components</li> </ul>	<ul style="list-style-type: none"> <li>• Fan should turn OFF after the internal components have cooled.</li> </ul>

## BEFORE CALLING FOR SERVICE (CONT.)

PROBLEM	POSSIBLE CAUSE	DON'T CALL FOR SERVICE UNTIL YOU CHECK
<ul style="list-style-type: none"> <li>• Foods do not broil properly</li> </ul>	<ul style="list-style-type: none"> <li>• Improper rack position</li> <li>• Oven preheated</li> <li>• Improper utensil used</li> <li>• Oven door closed during broil</li> </ul>	<ul style="list-style-type: none"> <li>• Check broil pan placement. See broiling section.</li> <li>• Do not preheat when broiling.</li> <li>• Use broiler pan and grid supplied with range.</li> <li>• Open door to broil stop position; see removable oven door section.</li> </ul>
<ul style="list-style-type: none"> <li>• Oven smokes</li> </ul>	<ul style="list-style-type: none"> <li>• Improper broiling time</li> <li>• Dirty oven</li> <li>• Broiler pan containing grease left in oven</li> </ul>	<ul style="list-style-type: none"> <li>• Check broiling chart in broiling section.</li> <li>• Check for heavy spillover.</li> <li>• Clean pan and grid after each use.</li> </ul>
<ul style="list-style-type: none"> <li>• Oven light does not work</li> </ul>	<ul style="list-style-type: none"> <li>• Light switch in off position</li> <li>• Light bulb burned out</li> </ul>	<ul style="list-style-type: none"> <li>• Check switch setting; see operating instructions.</li> <li>• Replace bulb. See removable parts section of this manual.</li> </ul>
<ul style="list-style-type: none"> <li>• Oven does not clean or poor cleaning results</li> </ul>	<ul style="list-style-type: none"> <li>• Controls not set properly</li> <li>• Clean cycle interrupted too soon</li> <li>• Oven too dirty</li> </ul>	<ul style="list-style-type: none"> <li>• Check self-clean instructions.</li> <li>• Heavily soiled ovens require a 3 1/2 hour clean cycle.</li> <li>• Heavy spillovers should be removed before setting clean cycle. Repeat clean cycle.</li> </ul>
<ul style="list-style-type: none"> <li>• Oven door will not unlock (self-clean models only)</li> </ul>	<ul style="list-style-type: none"> <li>• Clean cycle not complete</li> </ul>	<ul style="list-style-type: none"> <li>• Oven must cool below lock temperature.</li> </ul>
<ul style="list-style-type: none"> <li>• Repeating tone does not sound</li> </ul>	<ul style="list-style-type: none"> <li>• Tone has been altered by pushing and holding CLEAR/OFF button</li> </ul>	<ul style="list-style-type: none"> <li>• Push and hold CLEAR/OFF pad to activate repeating tone.</li> </ul>
<ul style="list-style-type: none"> <li>• Heavily soiled or stained cooktop cannot be satisfactorily cleaned</li> </ul>	<ul style="list-style-type: none"> <li>• Spills were not wiped up promptly</li> </ul>	<ul style="list-style-type: none"> <li>• See the instructions, under Cleaning Tips.</li> </ul>

## “DO-IT-YOURSELF” OVEN TEMPERATURE ADJUSTMENT

You may feel that your new oven cooks differently than the oven it replaced. We recommend that you use your new oven a few weeks to become more familiar with it, following the times given in your recipes as a guide.

Your oven has been preset to maximize cooking efficiency. If you think your new oven is too hot (burning foods), or not hot enough (foods are undercooked) you can adjust the temperature yourself. The appearance and texture of foods is a better indicator of oven accuracy than an inexpensive oven thermometer. **We do not recommend the use of inexpensive thermometers, such as those found in the grocery store, to readjust the temperature setting of your new oven.** These thermometers can vary by 20°-40°F. Also, you must open the oven door to read the thermometer and this changes the temperature of the oven.

To decide how much to change the temperature, set the oven temperature 25°F higher (if foods are undercooked) or 25°F lower (if foods are burning) than the temperature in your recipe, then bake. The results of this “test” should give you an idea of how much the temperature should be changed.

To adjust temperature follow these instructions:



1. Press the **BAKE** pad.



2. Press the **UP** arrow pad to select a temperature between 500°F and 550°F.



3. **IMMEDIATELY**, press and hold the **BAKE** pad for about 4 seconds. This display will show “ON” and “BAKE” will flash in the display.

4. Use the **UP** pad to increase temperature. Press the down arrow pad to decrease the temperature.

The temperature can be adjusted up to +35°F hotter or -35°F cooler.



SET BETWEEN -35°F  
AND +35°F

TEMPERATURE ADJUSTMENT  
YOU HAVE SELECTED IS  
SHOWN IN THE DISPLAY

5. When you have made the adjustment, push the **CLOCK** pad to return the display to the time of day. Use your oven as you would normally.



**NOTE: This adjustment will not affect Broil or Clean temperatures. It will be remembered when power is removed.**

# NOTES

# NOTES

# KENMORE ELECTRIC RANGE WARRANTY

Dear Customer:

Our constant efforts are directed toward making sure your new Kenmore Range will arrive at your home in perfect condition and will give you proper performance. As part of these efforts, we feel it is our responsibility to provide you with this warranty for your range.



Recycled Paper

## FULL ONE YEAR WARRANTY ON THE FUNCTIONING OF ALL PARTS EXCEPT GLASS PARTS

If, within one year from the date of installation, any part, other than a glass part, fails to function properly due to a defect in material or workmanship, Sears will repair or replace it, free of charge.

## FULL 30-DAY WARRANTY ON GLASS PARTS AND FINISH OF PORCELAIN ENAMEL, PAINTED OR BRIGHT METAL FINISHED PARTS

If, within 30 days from the date of installation, any glass part or the finish on any porcelain enamel, painted or bright metal part is defective in material or workmanship, Sears will replace the part, free of charge.

## FULL 90-DAY WARRANTY ON MECHANICAL ADJUSTMENTS

For 90 days from the date of installation, Sears will provide, free of charge, any mechanical adjustments necessary for proper operation of the range, except for normal maintenance.

If the range is subjected to other than private family use, the above warranty coverage is effective for only 90 days.

## WARRANTY SERVICE IS AVAILABLE BY CONTACTING THE NEAREST SEARS SERVICE CENTER/DEPARTMENT IN THE UNITED STATES

This warranty applies only while this product is in use in the United States. This warranty gives you specific legal rights, and you may also have other rights which vary from state to state.

**SEARS, ROEBUCK and CO.**  
 Dept. 731 CR-W  
 Sears Tower  
 Chicago, IL 60684

## WE SERVICE WHAT WE SELL

"We Service What We Sell" is our assurance to you that you can depend on Sears for service because Sears service is nationwide.

Your Kenmore Range has added value when you consider that Sears has a service unit near you staffed by Sears trained technicians. . . professional technicians specifically trained on Sears appliances, having the parts, tools and equipment to ensure that we meet our pledge to you — "We Service What We Sell!"

**TO FURTHER ADD TO THE VALUE OF YOUR RANGE, BUY A SEARS MAINTENANCE AGREEMENT.**

Kenmore Ranges are designed, manufactured and tested for years of dependable operation. Yet, any modern appliance may require service from time to time. The Sears Warranty plus the Sears Maintenance Agreement provides protection from unexpected repair bills and assures you of enjoying maximum range efficiency.

Here's a comparative warranty and Maintenance Agreement chart showing you the benefits of a Sears Range Maintenance Agreement.

Years of Ownership Coverage		1st Year	2nd Year	3rd Year
1	Replacement of Defective Parts other than Porcelain or Glass	W	MA	MA
2	Mechanical Adjustment	90 DAYS W	MA	MA
3	Porcelain and Glass Parts	30 DAYS W	MA	MA
4	Annual Preventive Maintenance Check at your request	MA	MA	MA

W - Warranty MA - Maintenance Agreement

**CONTACT YOUR SEARS SALESPERSON OR LOCAL SEARS SERVICE CENTER TODAY AND PURCHASE A SEARS MAINTENANCE AGREEMENT.**

# Kenmore® America's Best Selling Appliance Brand

Sold by SEARS, ROEBUCK AND CO., Chicago, IL 60684

— Printed in LaFayette, Georgia —



## Free Manuals Download Website

<http://myh66.com>

<http://usermanuals.us>

<http://www.somanuals.com>

<http://www.4manuals.cc>

<http://www.manual-lib.com>

<http://www.404manual.com>

<http://www.luxmanual.com>

<http://aubethermostatmanual.com>

Golf course search by state

<http://golfingnear.com>

Email search by domain

<http://emailbydomain.com>

Auto manuals search

<http://auto.somanuals.com>

TV manuals search

<http://tv.somanuals.com>