

OWNER'S MANUAL

SEARS

Kenmore

SEWING MACHINE

MODEL 385. 1960180

IMPORTANT SAFETY INSTRUCTIONS

Your sewing machine is designed and constructed only for HOUSEHOLD use. Read all instruction before using this sewing machine.

DANGER— To reduce the risk of electric shock:

1. An appliance should never be left unattended when plugged in. Always unplug this appliance from the electric outlet immediately after using and before cleaning.
2. Always unplug before relamping. Replace bulb with same type rated 15 Watts.
3. Do not reach for the appliance that has fallen into water. Unplug immediately.
4. Do not place or store appliance where it can fall or be pulled into a tub or sink. Do not place in or drop into water or other liquid.

WARNING— To reduce the risk of burns, fire, electric shock,

or injury to persons.

1. Do not allow to be used as a toy. Close attention is necessary when this appliance is used by or near children.
2. Use this appliance only for its intended use as described in this manual. Use only attachments recommended by the manufacturer as contained in this manual.
3. Never operate this appliance if it has a damaged cord or plug, if it is not working properly, if it has been dropped or damaged, or dropped into water. Return the appliance to the nearest authorized dealer or service center for examination, repair, electrical or mechanical adjustment.

4. Never operate the appliance with any air opening blocked. Keep ventilation openings of the sewing machine and foot controller free from accumulation of lint, dust, and loose cloth.
5. Never drop or insert any object into any opening.
6. Do not use outdoors.
7. Do not operate where aerosol (spray) products are being used or where oxygen is being administered.
8. To disconnect, turn all controls to the off ("O") position, then remove plug from outlet.
9. Do not unplug by pulling on cord. To unplug, grasp the plug, not the cord.
10. Keep fingers away from all moving parts. Special care is required around the sewing machine needle.
11. Always use the proper needle plate. The wrong plate can cause the needle to break.
12. Do not use bent needles.
13. Do not pull or push fabric while stitching. It may deflect the needle causing it to break.
14. Switch the sewing machine off ("O") when making any adjustment in the needle area, such as threading needle, changing needle, threading bobbin, or changing presser foot, and the like.
15. Always unplug the sewing machine from the electrical outlet when removing covers, lubricating, or when making any other user servicing adjustments mentioned in the instruction manual.

SAVE THESE INSTRUCTIONS

SEARS, ROEBUCK AND CO.

Dear Homemaker,

CONGRATURATIONS!

You have just purchased a Kenmore 100 Stitch sewing machine that can, with some easy setting by you, do both decorative and utility sewing more quickly and accurately than you ever dreamed possible. This machine can take the guesswork, the frustrating trial and error out of sewing, virtually eliminating hand-sewing. By just pressing a button or two, you can sew a seam or smock a dress, reinforce a sleeve or darn socks, create a border or embroider a sampler.

This manual will show you how to perform these wonders, making your sewing creations and crafts the "talk of the town", and make you the "star of the bazaar"



You can also program this machine to automatically sew your borders and monogram your clothing, and it will remember the entire sequence and repeat it when you press the foot control again.

Practice makes an expert ! Follow these directions and suggestions carefully. Get to know your machine intimately and it will turn your sewing tasks into a joy !

These instructions will help you obtain the best sewing results and avoid unnecessary service expense for conditions beyond our control. Advice on the operation and care of your machine is always available at your nearest Sears Retail Store. Please remember, if you have questions about your machine, always mention the model number and serial number when you inquire.

Write them here, for easy reference: Model No. 385
Serial No. _____

TABLE OF CONTENTS

| | |
|---|---|
| <p>SECTION 1. KNOW YOUR MACHINE</p> <p>A Portable Case or Cabinet is Available 4</p> <p>Locate and Identify the Parts 5~6</p> <p>Identify the Accessories 6</p> <p>SECTION 2. PREPARE YOUR MACHINE FOR SEWING</p> <p>Set Up the Machine 7~11</p> <ul style="list-style-type: none"> • Plug in the Machine and Switch on the Power 7 • Set the Foot Control 8 • Check Your Feed Balance Dial 8 • Set the Pressure Dial 8 • Setting Spool Pins 9 • Adjust the Presser Foot Lever 9 • Thread Cutter 9 • Accessory Storage Box 10 • Free-Arm Sewing: the Removable Extension Table 10~11 <p>Know What the Presser Feet Will Do 12~15</p> <ul style="list-style-type: none"> • Foot Storage Compartment 12 • Presser Foot Types 13~15 <ul style="list-style-type: none"> A. Zigzag Foot 13 C. Overedge Foot 13 D. Quilter 13 E. Zipper Foot 13 F. Satin Stitch Foot 13 G. Blind Hem Stitch Foot 14 H. Straight Stitch Foot 14 J. Sliding Buttonhole Foot 14 N. Automatic Buttonhole Foot 14 • Check Your Presser Foot 15 • Change the Presser Foot 15 <p>Choose Your Needle and Thread 16~17</p> <ul style="list-style-type: none"> • Check Your Needle 16 • Fabric, Needle, Thread and Stitch Length Chart 17 • To Change Your Needle 17 <p>Prepare the Bobbin 18~20</p> <ul style="list-style-type: none"> • To Remove the Bobbin from the Machine 18 | <ul style="list-style-type: none"> • Wind the Bobbin 18~19 • Insert the Bobbin into the Bobbin Holder 20 <p>Prepare Your Top Thread 21~24</p> <ul style="list-style-type: none"> • Thread Your Needle 21 • Pick Up Your Bobbin Thread 22 • Adjust the Top Thread Tension 23~24 <ul style="list-style-type: none"> For Straight Stitch 23 For Zigzag Stitch 24 <p>SECTION 3. LEARN TO USE THE CONTROLS</p> <p>Reverse Stitch Button 26</p> <p>Up/Down Needle Position Button 26</p> <p>Control Panel 27</p> <p>Pattern Indicator 28</p> <p>Pattern Selection Buttons 28</p> <p>Direct Entry Stitch Buttons 29</p> <p>Memory Button 29</p> <p>Clear Button 29</p> <p>Twin Needle Button 30</p> <p>Auto-Lock Button 30</p> <p>Mirror Image Button 30</p> <p>Editing Button 31</p> <p>Editing Pattern Combinations 31</p> <p>Stitch Width and Length Buttons 32~33</p> <ul style="list-style-type: none"> • Stitch Width Button 32 • Stitch Length Button 33 <p>SECTION 4. PRACTICE COMMON STITCHING SKILLS</p> <p>Use the Seam Guides 34</p> <p>Turn a Square Corner 34</p> <p>Sew on Heavy Fabrics 35</p> <p>Use the Darning Plate 35</p> <p>Basting  36</p> <p>Darning  37</p> <p>Sew a Button 38</p> <p>Put in a Zipper 39~41</p> |
|---|---|

SECTION 5. LEARN THE STITCHES

| | |
|---|-------|
| Chart of Sewing Functions | 42 |
| Stitch Pattern Chart | 43~49 |
| Straight Stitches 10 ~ 12, 17 and 18 | 50~59 |
| • Straight Stitch | 50 |
| • Topstitching | 51 |
| • Position Your Needle for Topstitching | 52 |
| • Pintucking | 53 |
| • Quilting | 54 |
| • Gathering | 55 |
| Straight Stretch 11 | 56 |
| Lock-a-Matic Seam 12 | 57 |
| Outline Stretch 17 | 58 |
| Saddle Stitch 18 | 59 |
| Zigzag Stitches 13 ~ 15, 20, 27 and 32 | 60~66 |
| • Basic Zigzag 14 | 60 |
| • Satin Stitch 14 | 61 |
| • Overcasting Stitch 14 | 62 |
| • Mending 13 | 63 |
| • Overedge Seam 15 | 64 |
| • Knit Stitch 20 | 65 |
| • Double Edge Zigzag 27 | 65 |
| • Rick-Rack Stretch 32 | 66 |
| Automatic Darning 29 | 67~68 |
| • Darning Small Rips | 68 |
| • Adjusting Evenness of Darning | 68 |
| Automatic Buttonholing 11, 12, 13, 14, 15, 16, 17, 18, 19 | 69~71 |
| • Adjust the Stitch Width and Density | 71 |
| Manual Buttonholing 11, 12, 13, 14, 15, 16, 17, 18, 19 | 72~73 |
| • Stitch Density on One Side | 73 |
| Corded Buttonholes 11, 12, 13, 14, 15, 16, 17, 18, 19 | 74 |
| Hemming and Edging Stitches 16, 21, 22, 28, 30 and 31 | 75~79 |
| • Blind Hem Stitch (stretch) 16 | 76 |
| • Blind Hem Stitch (woven) 28 | 76 |
| • Shell Stitch 28 | 77 |
| • Scallop Stitch 21 and 22 | 78 |
| • Cut-Out Work Edging and Applique 30 and 31 | 79 |

| | |
|---|-------|
| Reinforcing Stitches 25, 26, 33 and 35 | 80~82 |
| • Feather Stitch 25 | 80 |
| • Fagoting Stitch 33 | 81 |
| • Elastic Casing Stitch 33 | 82 |
| • Elastic Stretch Stitch 35 | 82 |
| Twin Needle Stitching 21, 22, 24, 25, 30, 36, 40 and 41 | 83 |
| Decorate with Geometric Patterns 42 ~ 54 | 84 |
| Decorate with Stretch Stitch Patterns 39 ~ 41 and 57 ~ 67 | 85 |
| Cross Stitch 34 | 86 |
| Smocking 23, 24, 36, 37 and 41 | 87 |
| Sand Stitch 38 | 88 |
| Shading Stitches 55 and 56 | 89 |
| Program Decorative Stitch Patterns 57 ~ 63 etc. | 90~92 |
| • One Cycle Stitching | 90 |
| • Two Cycle Stitching | 90 |
| • Cycle Stitching by Pressing Mirror Image Button | 91 |
| • Test Sewing Pattern Combinations | 91 |
| • Pattern Single Units | 92 |
| Monogramming 00 ~ 09, 60 ~ 98 | 93 |
| Adjusting Patterns | 94 |
| • To Adjust Distorted Patterns | 94 |
| • To Adjust Distorted Letters or Numbers | 94 |

SECTION 6. PERFORMANCE PROBLEMS CHART

| | |
|-----------------|-------|
| What to Do When | 95~96 |
|-----------------|-------|

SECTION 7. CARE FOR YOUR MACHINE

| | |
|-----------------------------------|----|
| Clean the Bobbin Holder | 97 |
| Clean the Hook Race and Feed Dogs | 98 |
| Oiling the Machine | 99 |
| Replace the Light Bulb | 99 |

| | |
|------------|---------|
| PARTS LIST | 100~101 |
|------------|---------|

| | |
|-------|---------|
| INDEX | 102~103 |
|-------|---------|

SECTION 1. KNOW YOUR MACHINE

A Portable Case or Cabinet is Available

A full line of sewing cabinets is available at your nearest Sears retail store or through our general catalog. Whenever you're ready to sew, so is your sewing place.

Another option buy a Carrying Case then your Kenmore goes anywhere, can be stored anywhere.

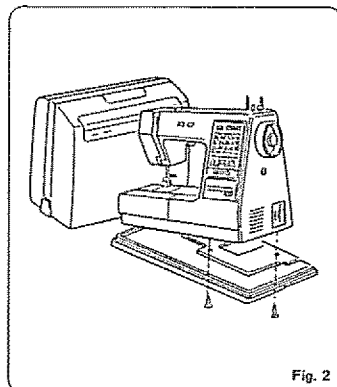
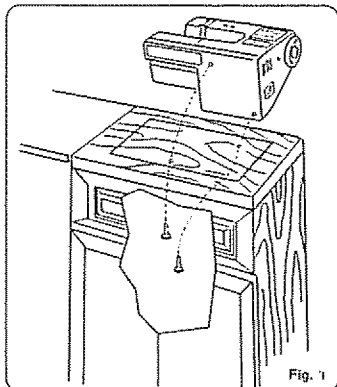

Locate and Identify the Parts

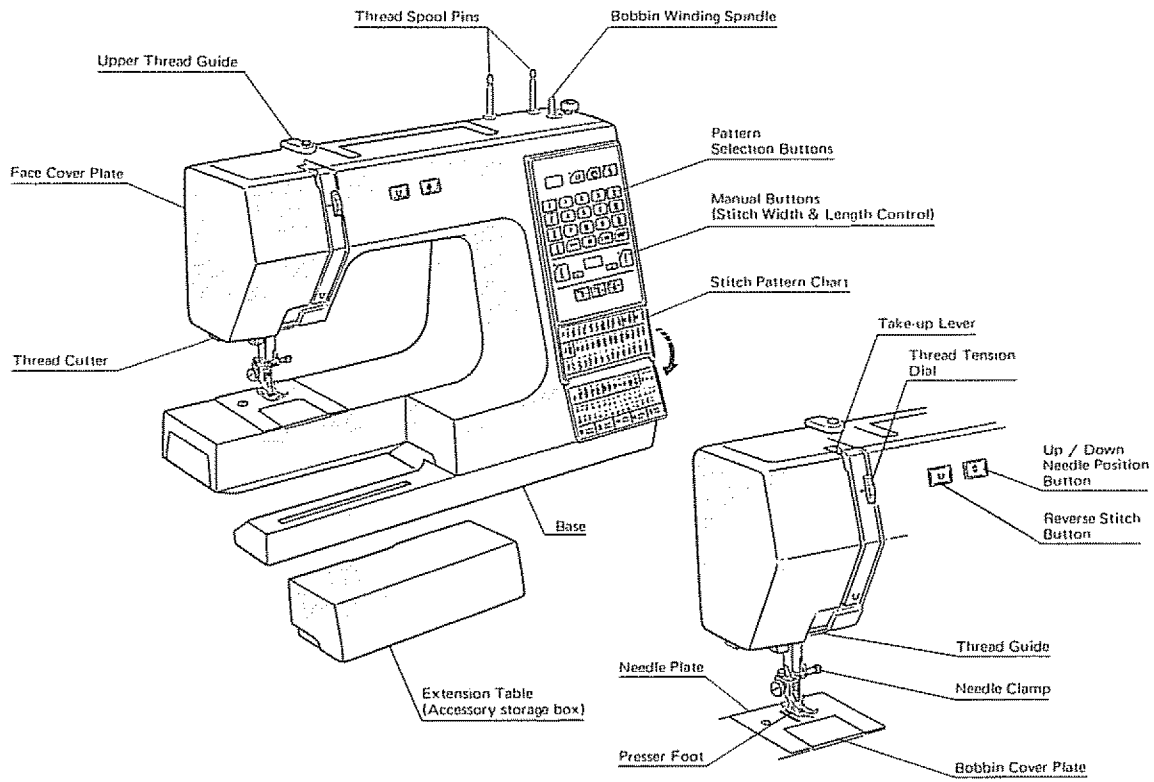

SECTION 1. KNOW YOUR MACHINE

Locate and Identify the Parts (Continued)

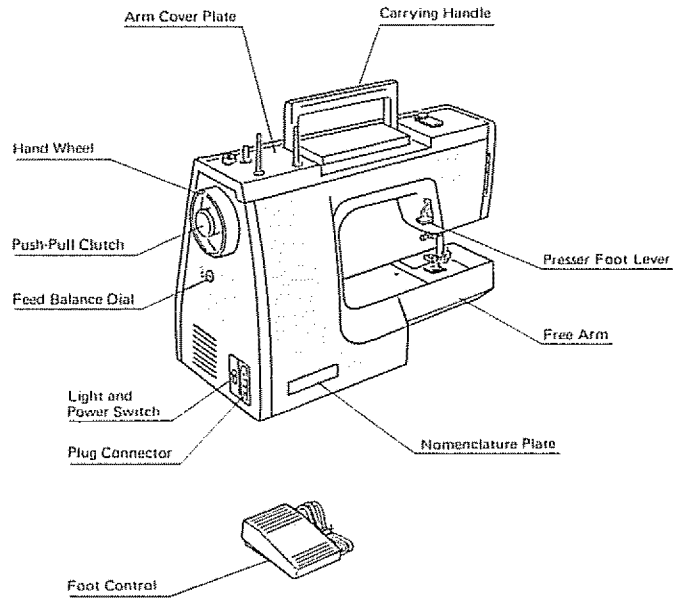

Identify the Accessories

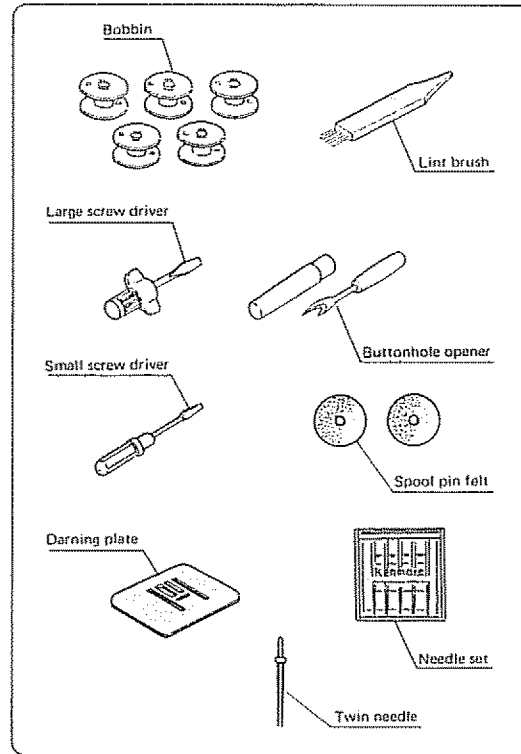

Set Up the Machine

• Plug in the Machine and Switch on the Power

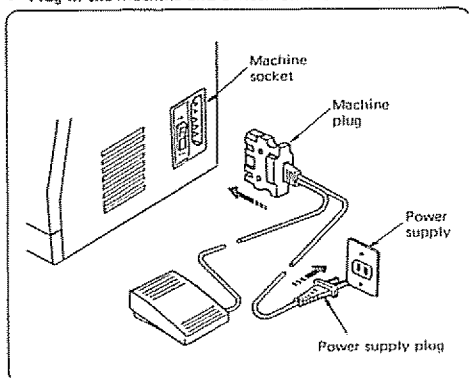

NOTE: Before inserting the plug into your machine, be sure the power switch is OFF.

1. Check your outlet to be sure it is a 110 to 120 Volt AC outlet.
2. Insert the machine plug into the five-prong outlet, as shown. It will only fit one way.
3. Insert the power supply plug into the outlet.
4. Push the light and power switch to turn on the power and sewing light.

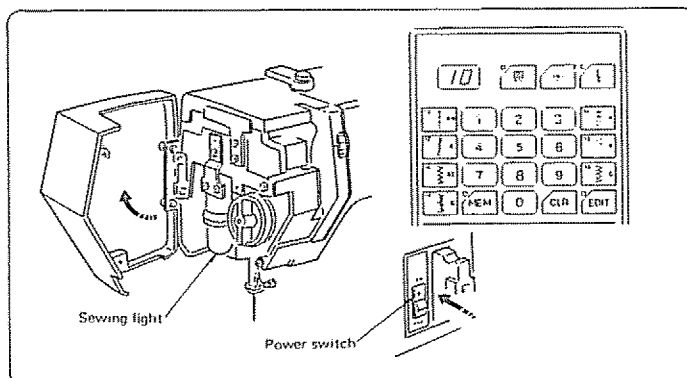

NOTE: The Pattern Indicator light will show 10.

SAFETY FEATURE:

Your machine will not operate unless the light/power switch is turned on. If you are interrupted or stop sewing, turn off the light/power switch to prevent injury to children.

SECTION 2. PREPARE YOUR MACHINE FOR SEWING

Set Up the Machine (Continued)

• Set the Foot Control

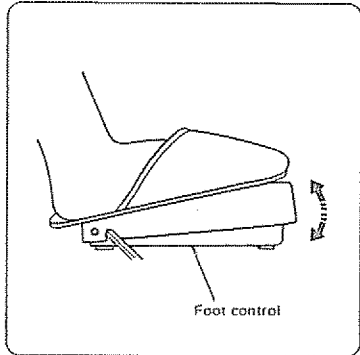

The foot control regulates the speed at which you sew.

Position the foot control as shown, with your heel on the floor.

To increase speed, gently press down with the ball of your foot.

To decrease speed, release your foot pressure slightly.

NOTE: The foot control is sensitive and will increase or decrease your sewing speed immediately. Practice on a scrap of fabric to regulate your sewing speed to your taste and needs.

• Check Your Feed Balance Dial

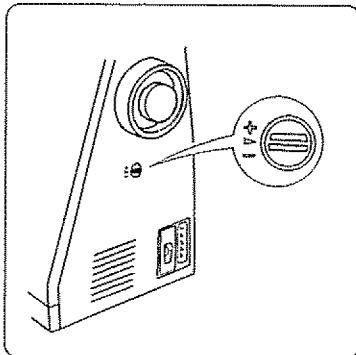

For most sewing, the groove in the Feed Balance Dial should point to the arrow ("▷").

You may rarely need to adjust the dial. But, if necessary, use this dial to regulate the feed balance for:

- Automatic Darning (See p. 68 for details)
- Buttonholes (See p. 73 for details)
- Any "stretch" stitch such as patterns **11**, **15**, **17**, **18**, **20**, **21**, **23** ~ **25**, **27**, **30** ~ **41**, **57** ~ **63** and monogramming when sewing on special fabrics.

• Set the Pressure Dial

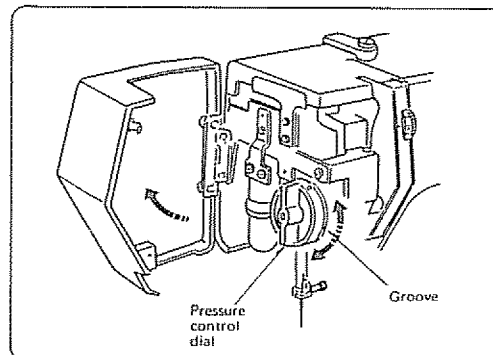

The pressure control dial is located inside the face cover plate.

Set the dial aligning the setting mark on the dial with the groove as follows.

- 3 most sewing
- 2 applique and Cut-Out work
- 1 sewing chiffon, lace, organdy and other lightweight fabrics. Also for velours and knits (with more stretch)
- 0 basting, manual darning and embroidery

NOTE: The pressure dial should be reset at 3 after changing pressure, so the machine is ready for most normal sewing the next time you use it.

• Setting Spool Pins

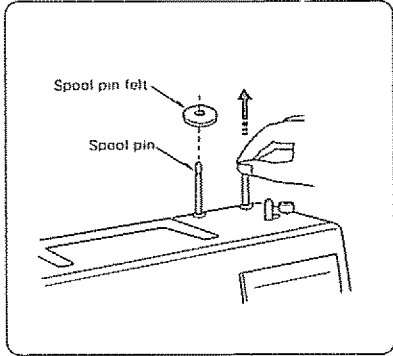

The spool pins are used for holding the spools of thread when feeding thread to the machine.

To use, pull up the spool pins. Be sure to place the spool felt on the pins. Push down for storage.

• Adjust the Presser Foot Lever

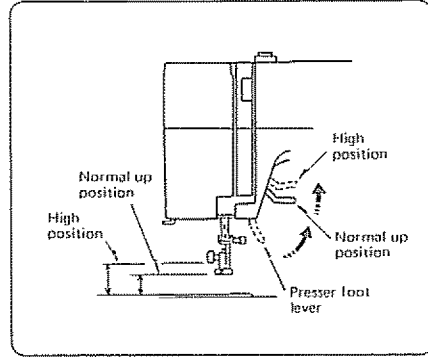

The Presser Foot Lever raises and lowers your presser foot.

You can raise it about 1/4" higher than the normal up position for easy removal of the presser foot or to help you place heavy fabrics under the presser foot.

• Thread Cutter

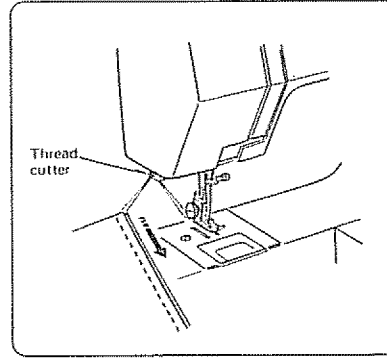

You don't need a pair of scissors to cut the thread after you finish sewing. Just use the handy thread cutter.

The threads are cut the proper length for starting the next seam.

SECTION 2. PREPARE YOUR MACHINE FOR SEWING

Set Up the Machine (Continued)

• Accessory Storage Box

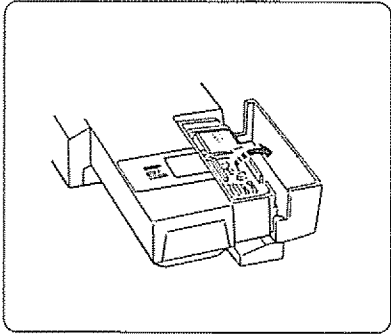

The lid of the accessory storage box lifts open toward you.

Sewing accessories are conveniently located in the box.

• Free-Arm Sewing: the Removable Extension Table

To Remove:

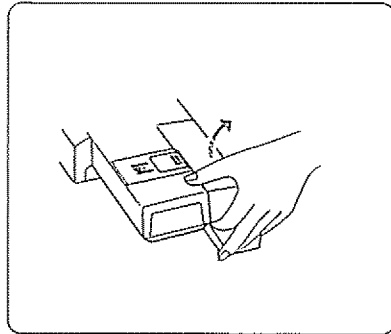

To Remove the Extension Table
(for free-arm sewing)

1. Grip the table with your index finger and thumb, as shown.
2. Pull gently toward you.
The extension table will snap out.

To Attach:

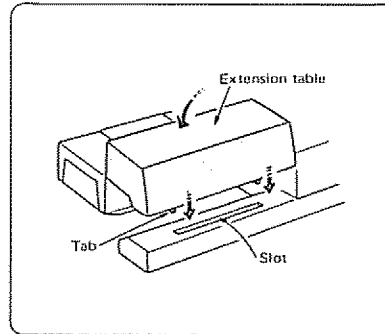

To Attach the Extension Table
(for flat-bed sewing)

1. Fit the tabs into the slot, as shown.
2. With your thumb and index finger, gently snap in.

SECTION 2. PREPARE YOUR MACHINE FOR SEWING

Your sewing machine can do free arm sewing.
This feature makes sewing easy for:

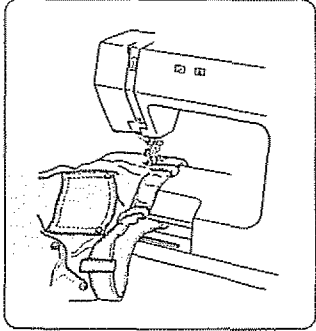

- Bar tacking to reinforce pockets, plackets and waistlines on ready-made or home-made garments to avoid fabric bunching around the needle.

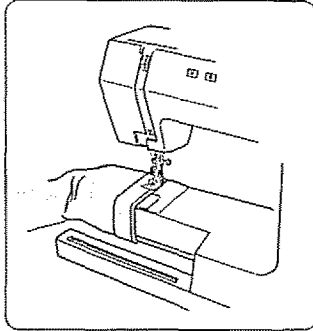

- Stitching sleeves, waistbands, pant legs, or any circular garment area.

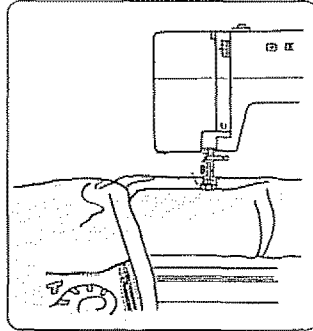

- Darning socks or mending knees, elbows, or areas of wear in children's clothes.

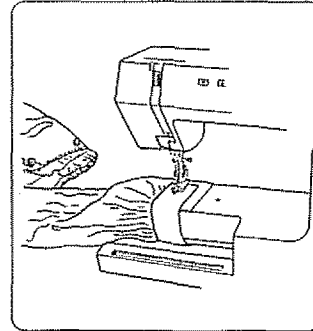

- Sewing buttons on sleeves, waistbands, etc.

SECTION 2. PREPARE YOUR MACHINE FOR SEWING

Know What the Presser Feet Will Do

The Presser feet are an important feature of this machine. You need to know what each foot does in order to use them effectively.

The Foot Storage Compartment with most of the presser feet is located in the accessory storage box. (See page 10). Automatic buttonhole foot N and other sewing accessories will be found under the Foot Storage Compartment.

• Foot Storage Compartment

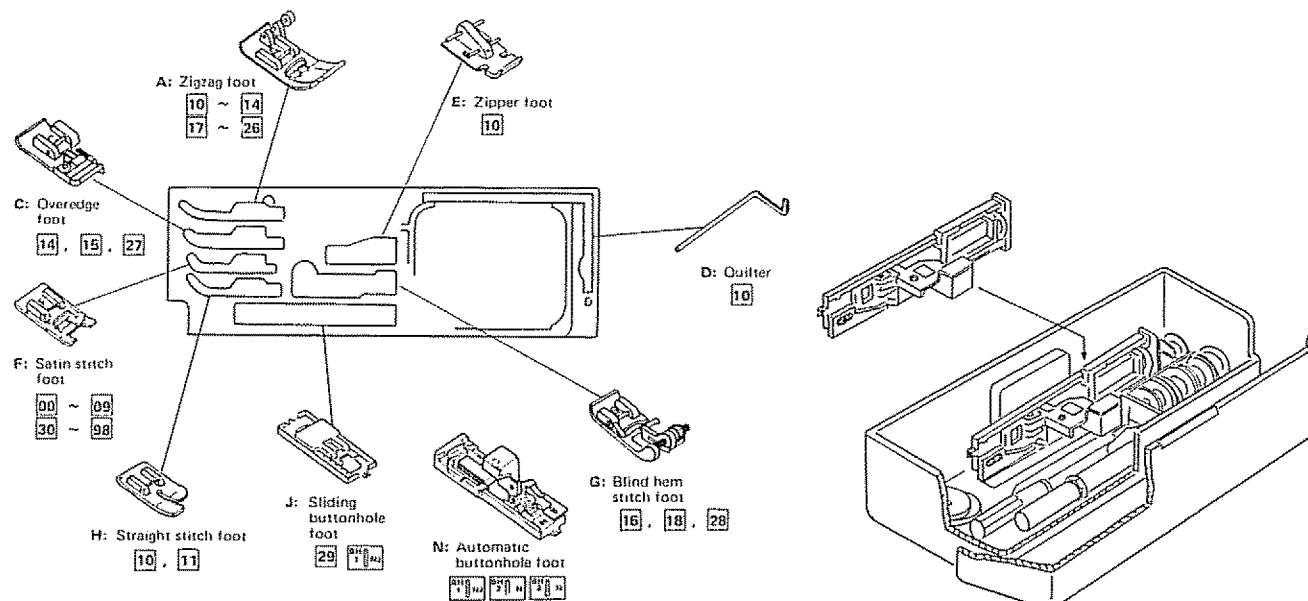

NOTE: The numbers after each foot indicate the stitch patterns where you use the foot.

The Automatic Buttonhole Foot N fits in the accessory storage box as illustrated.

SECTION 2. PREPARE YOUR MACHINE FOR SEWING

• Presser Foot Types

A. Zigzag Foot

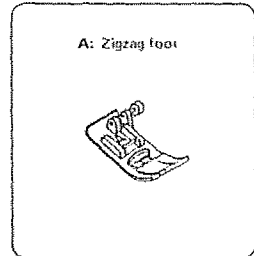

Use this foot for both straight and zigzag stitching.

The black button on the right side of the foot sets the foot to remain rigid so that you can sew on heavy fabrics.

(See p. 35 for detailed instructions.)

Stitch Patterns: $\frac{10}{17} \sim \frac{14}{26}$

C. Overedge Foot

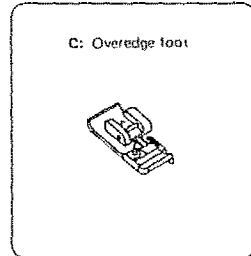

This foot is especially constructed for stitching and/or overcasting seams. The small brush and wire guides help control the fabric, hold the raw edge in place and keep it from puckering, especially when sewing on knit fabrics.

You may use this foot for the regular zigzag stitch $\frac{14}{15}$ or with the overedge stitch $\frac{15}{15}$.

See p. 62 and 64 ~ 65 for details.

Stitch Patterns: $\frac{14}{27}$, $\frac{15}{15}$ and $\frac{15}{27}$

D. Quilter

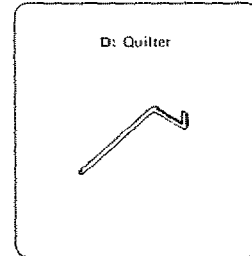

This attachment turns your zigzag foot into a quilting foot. See p. 54 for detailed instructions.

Stitch Pattern: $\frac{10}{10}$

E. Zipper Foot

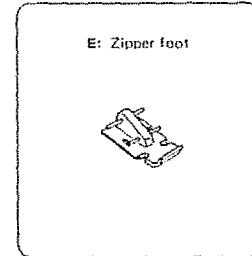

This foot can be set to sew on each side of your zipper. The edges of the foot guide the zipper and keep the seam straight.

For details on sewing zippers, see p. 39 ~ 41.

Stitch Pattern: $\frac{10}{10}$

F. Satin Stitch Foot

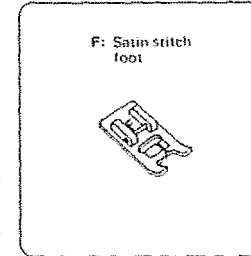

Use this transparent foot for outlining applique and Cut-Out Work, as well as for all your Decorative Stitching and monogramming.

Stitch Patterns: $\frac{00}{30} \sim \frac{99}{98}$

SECTION 2. PREPARE YOUR MACHINE FOR SEWING

Know What the Presser Feet Will Do (Continued)

• Presser Foot Types (Continued)

G. Blind Hem Stitch Foot

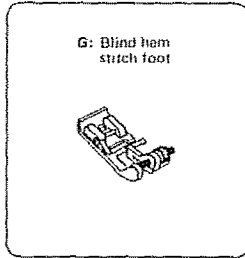

Use this foot for perfect blind hemming. The foot has ridges on the bottom to keep the fabric from slipping and a guide screw on top to guide the folded edge of your hem.

For detailed instructions, see p. 59 and 75 ~ 76.

Stitch Patterns: , and

H. Straight Stitch Foot

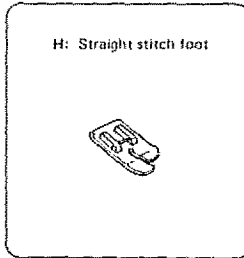

Use this foot exclusively for straight stitching.

Stitch Patterns: and (Center needle position)

J. Sliding Buttonhole Foot

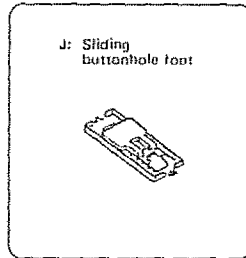

Use this foot for manual buttonholing. It is marked to help you measure your buttonholes accurately.

The maximum length of buttonhole that can be made by this foot is 30 mm.

For detailed instructions, see p. 67 and 72 ~ 74.

Stitch Patterns:

N. Automatic Buttonhole Foot

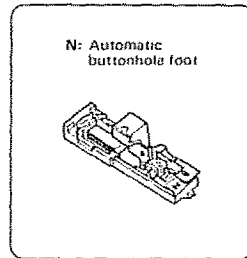

Use this foot for one step, automatic buttonholing.

Simply set a button on the guide of this foot and depress the foot control. You can then sew exactly the same length of buttonhole as the button.

For detailed instructions, see p. 69 ~ 70.

Stitch Patterns:

SECTION 2. PREPARE YOUR MACHINE FOR SEWING

• Check Your Presser Foot

Your presser foot is held in place by a Foot Holder. Each presser foot merely snaps on the foot holder, which is seldom removed.

If you need to remove or attach the foot holder, here is what you do:

To Remove:

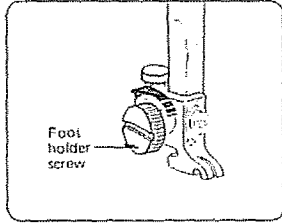

To Remove:

Turn the screw toward the back of the machine. Use the large screw driver.

To Attach:

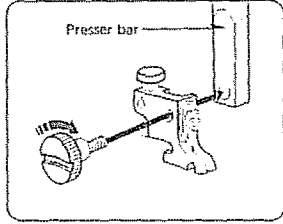

To Attach:

1. Match the hole in the foot holder with the threaded hole in the presser bar.
2. Fit the foot holder screw into the hole.
3. Tighten the screw by turning it toward you.

• Change the Presser Foot

Use the correct presser foot for the stitch you wish to sew. Consult the Stitch Pattern Chart and the detailed directions for sewing with the various presser feet.

To snap off:

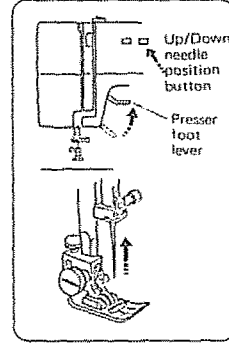

To Snap Off the Presser Foot:

1. Press the Up/Down Needle Position Button to raise the needle to its highest position.
2. Raise the presser foot.
3. Press the red button on the back of the foot holder. The presser foot will drop off.

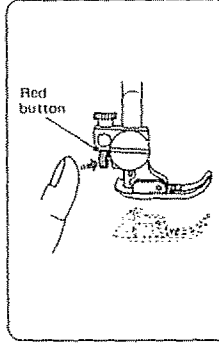

To snap on:

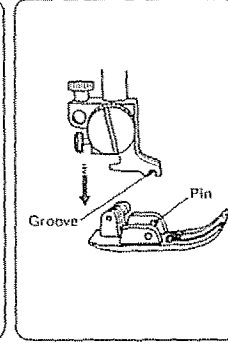

To Snap On the Presser Foot:

1. Set the Pressure Dial at "3".
2. Place the presser foot so the horizontal pin on the foot lies just under the groove of the foot holder.
3. Lower the presser foot holder to lock the presser foot in place.

NOTE: If you do not hear the presser foot snap in place, press down on the presser foot holder firmly until you hear the snap.

SECTION 2. PREPARE YOUR MACHINE FOR SEWING

Choose Your Needle and Thread

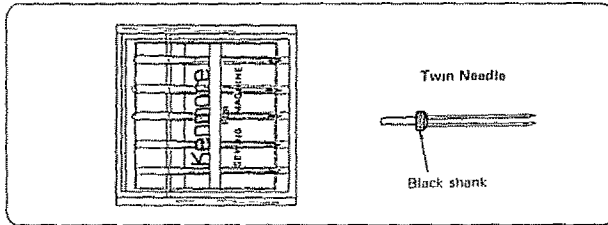

Your choice of needle and thread depends on the fabric you are sewing.

In your needle case, you will find the following color-coded needles:

- Blue (11) for stretch fabrics
- Orange (11) for lightweight fabrics
- Red (14) for medium or medium-heavy weight fabrics
- Purple (16) for medium-heavy weight and decorative topstitching on these fabrics
(This needle has a larger thread hole for thicker topstitching thread.)
- Green (18) for heavy weight fabrics and decorative topstitching on these fabrics
- Twin Needle for sewing parallel rows of straight or decorative stitches

NOTE: These needles are found in the accessory storage box. (see page 10)

• Check Your Needle

1. Look for barbed or blunt point.
2. A damaged needle can cause permanent snags or runs in knits, fine silks and silk-like fabrics.

Always buy a good quality thread. It should resist tangling and be strong, smooth and consistent in thickness.

SECTION 2. PREPARE YOUR MACHINE FOR SEWING

• Fabric, Needle, Thread and Stitch Length Chart

| FABRIC | NEEDLE SIZE AND COLOR | THREAD SIZE | RECOMMENDED STITCH LENGTH SETTING |
|--|-------------------------------|---|--|
| Lightweight: Batiste, Dimity, Chiffon, Silks, Fine Lace, Organza, Crepe, Taffeta, Voile, Organdy | 11-ORANGE | Polyester Core/Cotton Wrap Fine Mercerized Cotton Silk A | 2.0 (12 stitches per inch) |
| Medium Weight: Cotton, Cotton Blends, Percale, Gingham, Shantung, Figue, Sarsueker, Satin, Knits, Vinyl Suitings, Linen, Wool Crepe, Leather | 14-RED | 50 Mercerized Cotton Polyester Core/Cotton Wrap Silk A | 2.0 ~ 2.5 (10 ~ 12 stitches per inch) |
| Medium Heavy Weight: Corduroy, Denim, Wool, Sailcloth, Wool Flannel, Gabardine, Velvets, Leather | 14-RED or 16-PURPLE | 50 Mercerized Cotton Mercerized Heavy-Duty Polyester Core/Cotton Wrap Silk A | 2.5 ~ 3.0 (8 ~ 10 stitches per inch) |
| Heavy Weight: Coatings, Upholstery Cotton Duck, Heavy Twills, Canvas | 18-GREEN | Heavy Duty Mercerized Cotton Polyester Core/Cotton Wrap Silk A | 3.0 (8 stitches per inch) |
| Decorative top-stitching on all types of fabric | 16-PURPLE 18-GREEN | Buttonhole Twist (Use as top thread only) | 4.0 ~ 4.5 (4 ~ 6 stitches per inch) |
| Stretch Fabric: Polyester Double Knits, Nylon Tricot, Jersey, Stretch Terry, Spandex, Cira Tricot | 11-STRETCH FABRIC NEEDLE-BLUE | Polyester Core/Cotton Wrap 50 Mercerized Cotton | 2.0 ~ 2.5 (10 ~ 12 stitches per inch) |

• To Change Your Needle

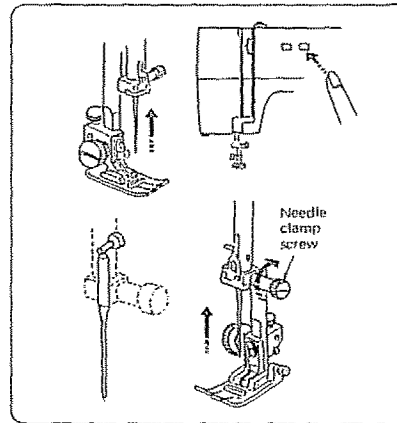

NOTE: Raise the needle bar to its highest position by pressing the Up/Down Needle Position Button:

1. Loosen the needle clamp screw by turning it toward you.
2. Remove the needle by pulling it downward.
3. Insert the new needle into the needle clamp with the flat side away from you.
4. Push the needle up as far as it will go.
5. Tighten the needle clamp screw firmly with the large screwdriver from your accessory box.

SECTION 2. PREPARE YOUR MACHINE FOR SEWING

Prepare the Bobbin

• To Remove the Bobbin from the Machine

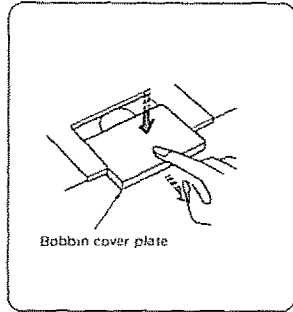

1. Gently push down on the bobbin cover plate and slide it towards you.
2. Set aside.
3. Lift out the bobbin, as shown.

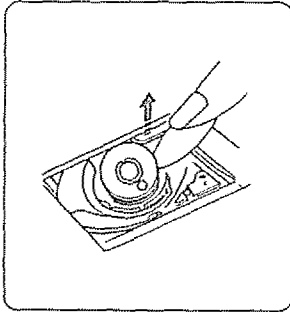

• Wind the Bobbin

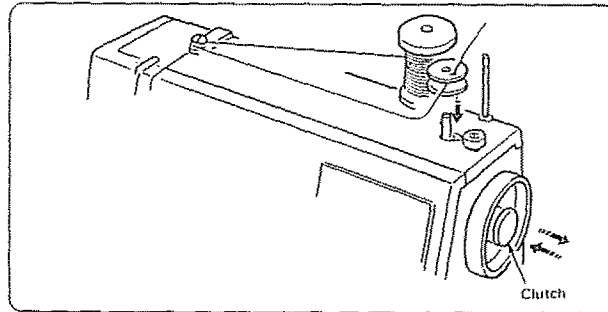

1. Put your spool of thread onto spool pin, with the thread winding in the direction shown.
2. Pull the clutch away from the machine to stop the needle from moving while winding the bobbin.

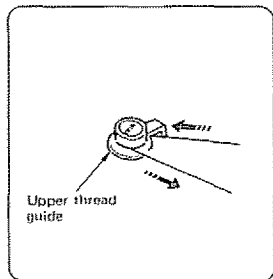

3. Draw thread from spool through bobbin winder upper thread guide tension disc as shown.

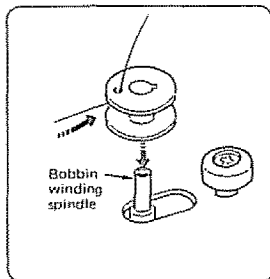

4. Place the threaded bobbin on the bobbin winding spindle so that the thread comes out on top.

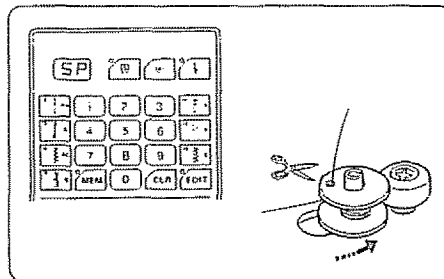

5. Push the bobbin winding spindle to the right until it clicks.
 6. Holding onto end of thread, depress the foot control.
 7. When the bobbin is slightly filled, stop the machine and clip the thread coming from the bobbin.
 8. Slowly start the machine again and wind the thread until the bobbin stops.

NOTE: The Pattern Indicator will read "SP" to show the machine is winding the bobbin.

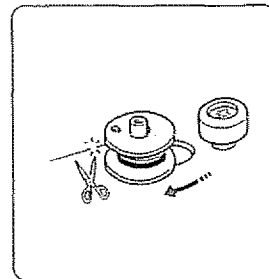

9. Push the bobbin winding spindle to the left and clip the thread.
 10. Remove the bobbin.
 11. Push in the clutch for normal sewing operation.

NOTES: If you do not push in the clutch, the machine will not run when you press the foot control.

Do not depress the foot control while sliding the bobbin winding spindle in either direction.

SECTION 2. PREPARE YOUR MACHINE FOR SEWING

Prepare the Bobbin (Continued)

• Insert the Bobbin into the Bobbin Holder

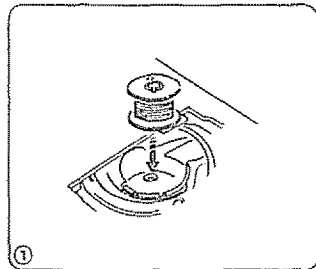

① Put the bobbin into the bobbin holder so that the thread feeds counter-clockwise.

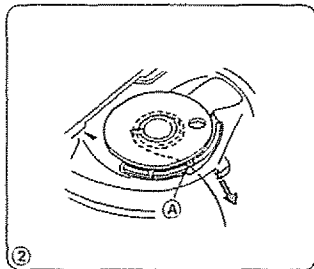

② Pull about 4 inches of thread toward you through the tension slot (A).

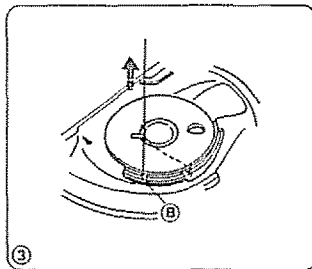

③ Then pull the thread clockwise toward the back of the machine through the slot (B).

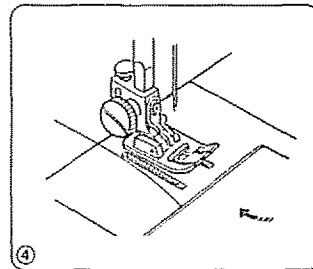

④ Slide the bobbin cover plate while pushing it down slightly over the bobbin. Allow about 4 inches of thread to show above the needle plate.

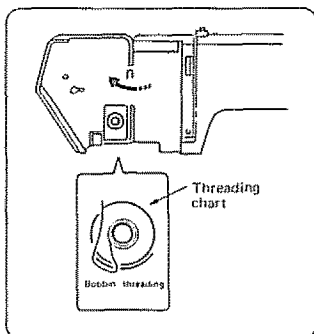

* Bobbin threading chart is located behind the face cover plate.

SECTION 2. PREPARE YOUR MACHINE FOR SEWING

Prepare Your Top Thread

• Thread Your Needle

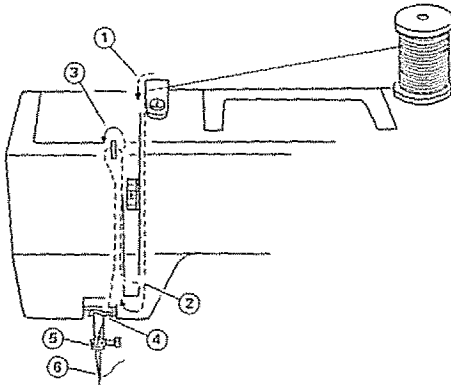

The numbered steps above follow the numbers on the illustrations.

Dotted lines show places where the thread loops and then is pulled tight.

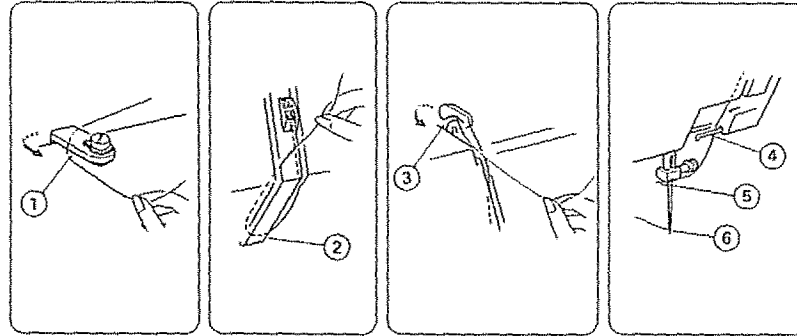

Raise take-up lever to its highest position by turning hand wheel toward you.

Raise presser foot lever.

Place spool on spool pin as shown, with thread coming from the back of the spool.

1. Draw thread into thread guide using both hands.
2. While holding thread near spool, draw thread down into the tension area and then around the check spring holder.
3. Firmly draw thread up and through take-up lever from right to left.
4. Draw thread down and slip it through the thread guide.
5. Thread then is slipped into needle bar thread guide.
6. Thread needle from front to back.

NOTE: You may want to cut the end of thread with sharp scissors for easier needle threading.

SECTION 2. PREPARE YOUR MACHINE FOR SEWING

Prepare Your Top Thread (Continued)

• Pick Up Your Bobbin Thread

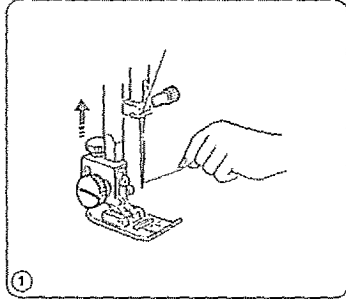

① Hold the top thread tightly with your left hand.

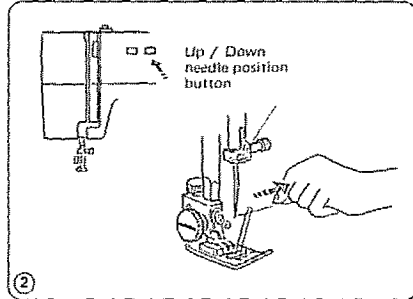

② Press the Up/Down Needle Position Button twice.
Bring the bobbin thread up by pulling the top thread.

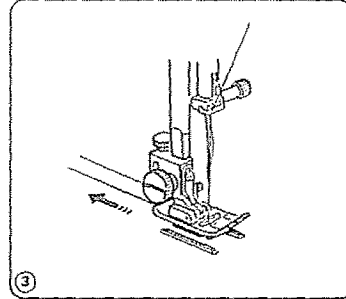

③ Pull both threads under and to the back of the presser foot, leaving 4 to 6 inches of thread clear.

SECTION 2. PREPARE YOUR MACHINE FOR SEWING

• Adjust the Top Thread Tension

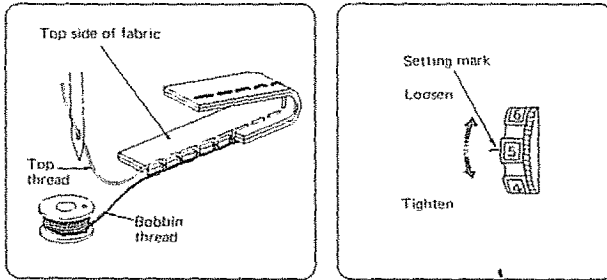

For Straight Stitch

The ideal straight stitch will have threads locked between the two layers of fabric, as shown above, magnified to show detail.

If you look at the stitch, front and back, you will notice that there are no gaps, that each stitch is smooth and even.

When adjusting top thread tension, the higher the number, the tighter the top thread.

Choose the Correct Tension:

The best tension will depend on;

- the stiffness and thickness of the fabric
- the number of fabric layers
- the type of stitch

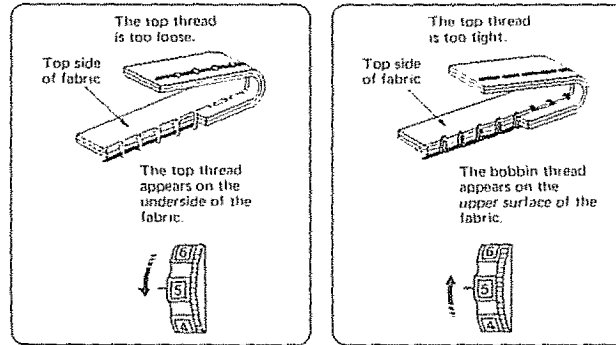

Tension is too loose:

The top thread shows through the bottom of the fabric. The bottom side of the stitch will feel bumpy.

Tension is too tight:

The bobbin thread will come through the top of the fabric. The top side of the stitch will feel bumpy.

SECTION 2. PREPARE YOUR MACHINE FOR SEWING :

Prepare Your Top Thread (Continued)

• Adjust the Top Thread Tension (Continued)

For Zigzag Stitch

In the correct zigzag stitch, the bobbin threads will not show on the top side of fabric and the top threads will show slightly on the bottom side. See below for the correct appearance. To match this appearance, adjust your top tension.

Top tension
Too Tight

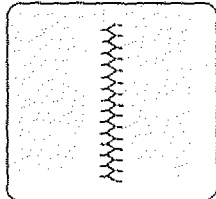

Top side of Fabric

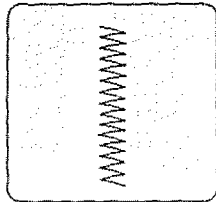

Bottom side of Fabric

Too Tight:

Corner of each zigzag will pull together on the top side of fabrics.

Top tension
Too Loose

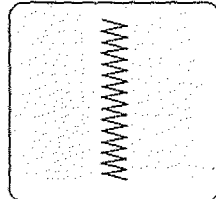

Top side of Fabric

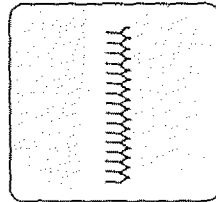

Bottom side of Fabric

Too Loose:

The top thread will loop through bottom side of fabric and will be pulled almost together.

Just Right

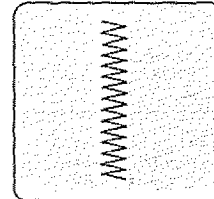

Top side of Fabric

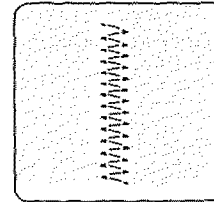

Bottom side of Fabric

Just Right:

Minimize the amount of top thread visible on the bottom side of fabric without causing excessive puckering or causing the bobbin thread to show on the top side. Results vary with fabric, thread and sewing conditions.

SECTION 3. LEARN TO USE THE CONTROLS

The illustration shows the Reverse Stitch Button, Up/Down Needle Position Button and the control panel of your Kenmore 100 Stitch. The control buttons, LED lights and indicator screens enable you to control your machine and know what it is doing at all times.

In this section, you will learn what these buttons are and how to use them. Each time you press a control button you will hear a "beep". Practice using these controls to see what they will do.

Let's look carefully at each control button, beginning with the Reverse Stitch Button and continuing down the Control Panel.

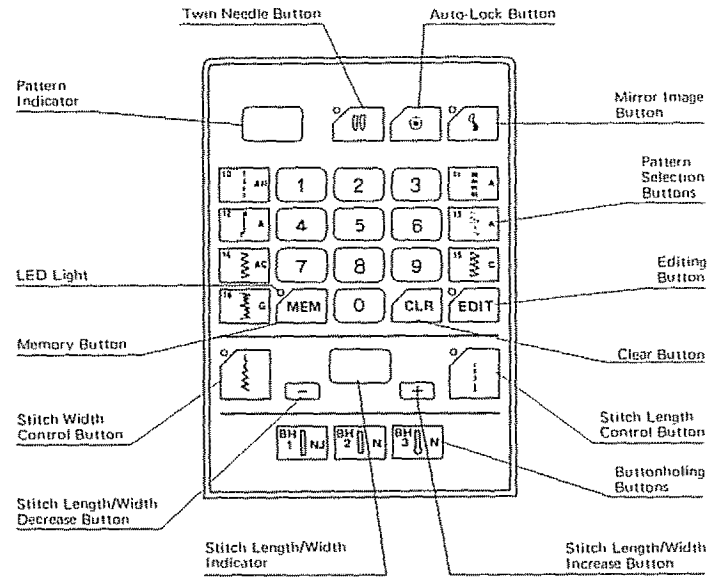
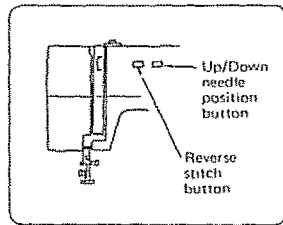

SECTION 3. LEARN TO USE THE CONTROLS

Reverse Stitch Button (manual – no memory)

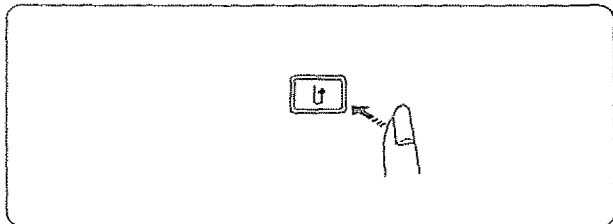

Use this button to:

- secure seams.
- reinforce the seams and the top edges of pockets.

At Straight Stitching:

Press and hold the reverse stitch button.

The machine will sew in reverse until you release the button.

At Zigzag or Decorative Stitching:

Press this button, then the machine will sew auto-lock stitch immediately and stops automatically.

Up/Down Needle Position Button

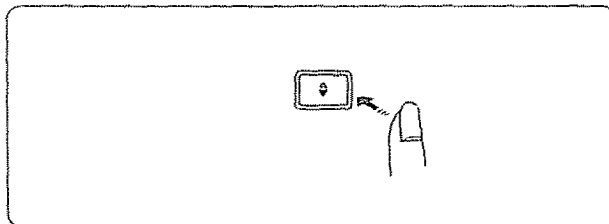

When you press this button, the needle will go up or down.

If the needle is up and you press this button, the needle will go down to its lowest position.

If the needle is down and you press this button, the needle will go to its highest position.

CAUTION: Do not press the foot control while you press the up/down needle position button.

Use this button to:

- take up the bobbin thread (down and up) as you hold the top thread.
- turn a corner (down to keep the fabric from slipping).

It eliminates the hand wheel for raising and lowering the needle.

Control Panel

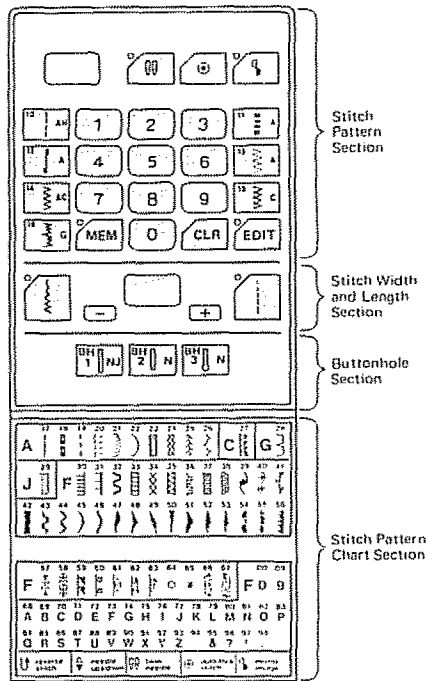

The Control Panel is divided into four sections:

The Stitch Pattern Section.

Where you set stitch patterns, with memory and clear buttons. Other useful buttons are also located in this section:

- seven direct entry stitch buttons
- twin needle button
- mirror image button
- auto-lock button
- editing button

The Stitch Width and Length Section.

Where you adjust the length of straight stitches and the length and width of zigzag stitches.

The Buttonhole Section.

The Kenmore 100 Stitch can make three types of buttonholes:

- Bartack
- Rounded
- Keyhole

Using the automatic buttonhole foot N, you can sew the exactly same length of buttonhole with the actual button.

The Stitch Pattern Chart Section.

You can check the pattern number which you want to sew at a glance by referring to this chart.

Pattern numbers 64 to 97 include the auto-lock stitch at both beginning and end of the stitch.

SECTION 3. LEARN TO USE THE CONTROLS

Pattern Indicator

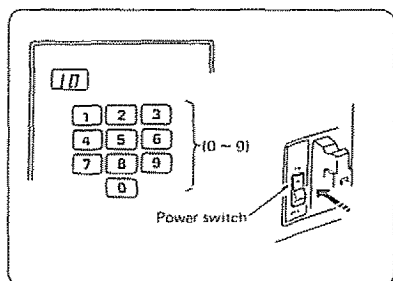

This two digit indicator screen lights up to show what stitch pattern you are using.

NOTE: When you turn on your machine, the indicator will automatically show the straight stitch **10**.

To Select a Stitch Pattern:

1. Press two numbers to indicate which pattern you want to use.
2. The numbers will show on the pattern indicator.

Pattern Selection Buttons

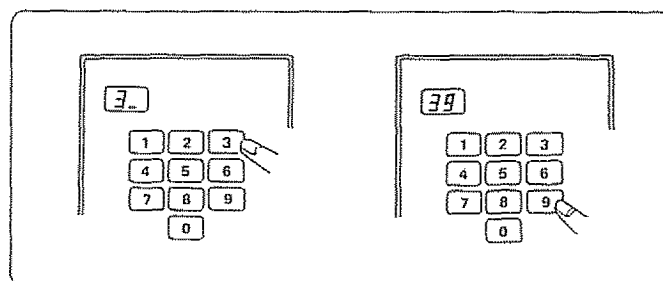

Use these buttons to select a stitch pattern. They run from 0 to 9.

Example: To use decorative stitch **39**.

1. Press **3**. A number 3 and a flashing line will appear on the pattern indicator screen.
2. Press **9**.

You have selected stitch pattern **39**.

NOTE: If you select numbers not on the stitch pattern chart, the machine will blink until you select numbers on the chart.

Direct Entry Stitch Buttons

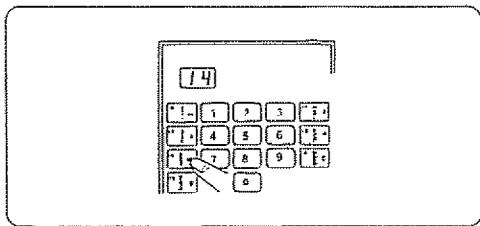

You can set each of following most frequently used stitches by pressing just one button. The pattern indicator screen will show the selected pattern number.

You can also select these patterns by pressing pattern selection buttons.

| Stitch No. | Stitch Illustration | Name of Stitches |
|------------|---------------------|-------------------------|
| 10 | ----- | Straight Stitch |
| 11 | ≡≡≡≡≡ | Straight Stretch Stitch |
| 12 | ————— | Lock-A-Matic Stitch |
| 13 | ▲▲▲▲▲ | Mending Stitch |
| 14 | ▲▲▲▲▲ | Zigzag Stitch |
| 15 | ▲▲▲▲▲ | Overedge Stitch |
| 16 | ▲▲▲▲▲ | Blind Hem Stitch |

Memory Button

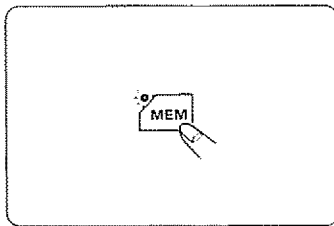

The Memory Button, with its LED Light, will “memorize” your pattern selection. Your machine can remember up to 31 stitch patterns, including the Auto-Lock, which automatically reinforces or locks the stitch you have chosen. This button is most typically used when monogramming or combining patterns.

To Set the Memory:

Press the Memory Button after you select your stitch pattern. The LED light will go on to show that the machine has recorded your selection.

NOTE: If you are selecting a series of different stitch patterns, you must press the memory button after each selection. The machine Kenmore 100 Stitch will remember them in order.

Clear Button

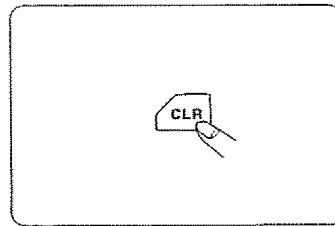

The Clear Button will erase the stitch pattern you have selected and automatically return your machine to **10** the straight stitch pattern.

The Clear Button works in two ways to clear a series of stitch patterns, depending on whether you have pressed the foot control.

1. Foot Control Not Pressed:

The Clear Button clears one stitch pattern at a time, beginning with the last selected and ending with the first selected until it comes to “10” prior to editing. This allows you to correct any mistakes made while programming a series of patterns. The Clear Button will delete all stitches at once if pressed after editing.

2. Foot Control Pressed:

The Clear Button deletes all stitch patterns in the series at once. The indicator returns to **10**.

NOTE: Turning off the machine will clear the memory completely.

Twin Needle Button

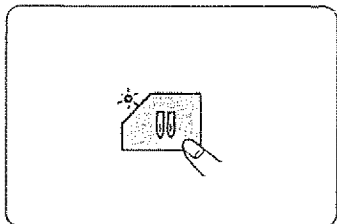

Just press this button, and the machine automatically reduces the maximum width for twin needle sewing.

Press button again to single needle sewing.

For detailed instructions, see p. [83](#).

Auto-Lock Button (automatic with memory)

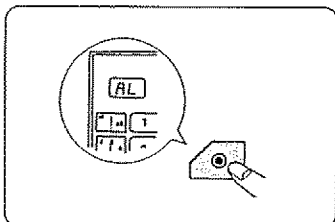

Use this button to secure seams with an auto-lock stitch at the first and last stitch you sew.

To Use the Auto-Lock Stitch:

Press the Auto-Lock Button.

The pattern indicator screen will show "AL".

The machine will take a few stitches in place and stop automatically.

To Use the Auto-Lock Memory:

1. Press the Auto-Lock Button.
2. Press the Memory Button.
3. Press the Stitch Pattern Buttons you desire. (Be sure to press the Memory Button after each stitch pattern selection.)
See p. [90](#) for more details.
4. Press the Auto-Lock Button.
5. Press the Memory Button.

Mirror Image Button

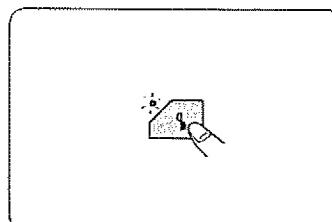

Use this button to;

- sew & memorize patterns in a mirror image.
- sew & memorize letters and numbers in two third size.

NOTE: Since this control memorizes the pattern selected, press the Clear Button or Power Switch to clear the memory prior to selecting another stitch.
(How to use the Clear Button, see p. [29](#).)

Editing Button

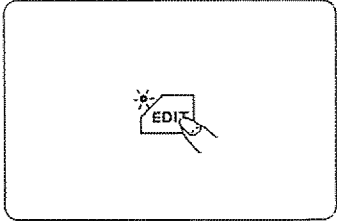

Use this button to:

- check and correct pattern combinations before sewing.
- press again when editing is complete, the light will go out.

Editing Pattern Combinations

To check your programming for possible errors in a long pattern sequence, your Kenmore 100 Stitch has a built-in editing system (EDIT).

After programming touch the editing button. A flashing light will appear and the pattern indicator will show the first pattern number programmed. Each time the memory button is pressed the pattern indicator will advance to the next pattern. Continue pressing the memory button until you reach the last pattern or you find an error. Pressing the Mirror Image Button will sequence from last to first.

To Delete and Add Patterns: You wanted to program 01, 02, 03 and 04 but 05 was programmed instead of 03. Press the editing button. Then press the memory button until 05 appears in the pattern indicator. Press the clear button. 02 will appear in the pattern indicator. Now select pattern 03 and press the memory button. Pattern 05 has been deleted and pattern 03 added.

To Delete Patterns Without Adding: You programmed 01, 02, 03, 04 and 05. You want to delete 02 and 04. Press the editing button. Press the memory button until 02 appears. Press the clear button. Advance until 04 appears. Press the clear button. 02 and 04 have been deleted.

To Add Patterns Without Deleting: You programmed 01, 03 and 04. You want to add 02. Press the editing button. 01 will appear. Because you want 02 to come after 01 add it when 01 is in the pattern indicator. Select pattern 02 and press the memory button.

If your programming is correct, press the editing button again. The flashing light will disappear and you're ready to sew. The machine will not sew when the editing signal is flashing.

In editing, pressing the memory button advances the patterns from first to last while the mirror image button shows the sequence from last to first;

SECTION 3. LEARN TO USE THE CONTROLS

Stitch Width and Length Buttons

All stitches in your Kenmore 100 Stitch are pre-set for the best stitch length and width. But if you wish to change the settings here's how:

You can set stitch width and length with these two buttons. (Use one at a time. The machine will remember the first one while you set the other.)

Use the Plus "+" or Minus "-" buttons to increase or decrease the stitch width or length.

The indicator screen will show the stitch width or length you have selected.

• Stitch Width Button

This button controls the width of zigzag stitches.

NOTE: If you press the stitch width button while doing straight stitching, the stitch width light will go on and the indicator screen will show "C". Your needle is in the "Center". If you press the "+" button, the indicator will show "R" (Right). If you press the "-" button, the indicator will show "L" (Left).

When you press this button for zigzag stitches, the stitch width light will go on and the indicator screen will show the preset stitch width of "5.0"

NOTE: The range of stitch width depends on the stitch pattern you select.

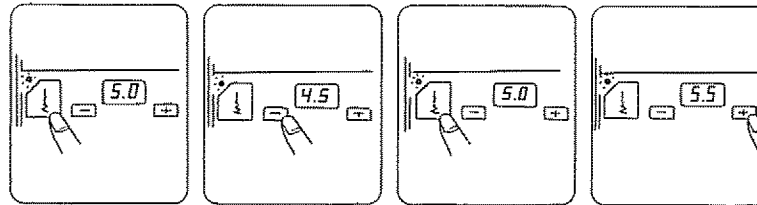

To Decrease the Stitch Width:

To Increase the Stitch Width:

Press the "-" button. The width will decrease by 0.5 mm to "0.0" each time you press the button.

Press the "+" button. The zigzag width will increase by 0.5 mm up to "7.0" each time you press the button.

To Adjust the Stitch Width Quickly:

Hold Down the "-" or "+" button until you reach the stitch width you desire.

To Return to the Preset Stitch Width (or clear the stitch width):

Press the Stitch Width button again (or press the Clear button).

The stitch width light and the indicator screen will go off.

- **Stitch Length Button**

This button sets the stitch length for both straight and zigzag stitches.

When you press the stitch length button, the stitch length light will go on and the indicator screen will show the pre-set stitch length:

- "2.0" for straight stitching
- "1.5" for zigzag stitching

NOTE: The range of stitch length depends on the stitch pattern you select.

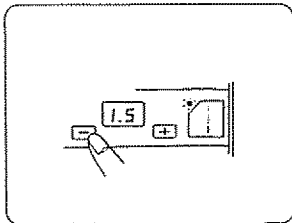
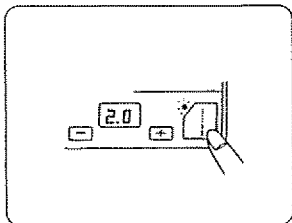

To Decrease the Stitch Length:

Press the "-" button.

The stitch length will decrease

- by 0.1 mm from "1.0" down to "0.0"
- by 0.5 mm from "4.5" down to "1.0"

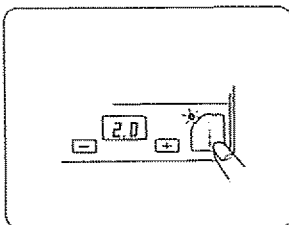

To Increase the Stitch Length:

Press the "+" button.

The stitch length will increase

- by 0.1 mm from "0.0" up to "1.0"
- by 0.5 mm from "1.0" up to "4.5"

To Adjust the Stitch Length Quickly:

Hold Down the "+" or "-" button until you reach the desired length.

To Return to the Preset Stitch Length

(or clear the stitch length setting), press the Stitch Length button again (or press the Clear button). The stitch length light and the indicator screen will go off.

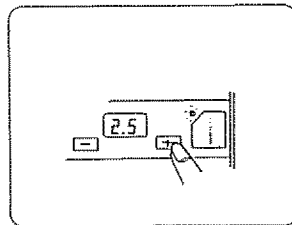

The sewing covered in this section require some special skills. For all other stitches, your machine does most of the work. Even if you are skilled at these stitches, you will want to learn the features of this machine that may be new to you.

Use the Seam Guides

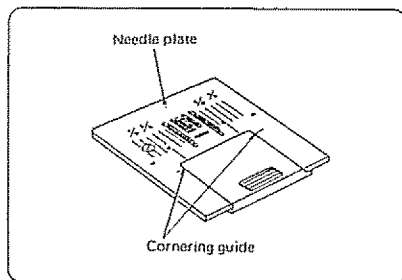

The seam guides on the needle plate help you measure seam width. The lines are 1/8" apart, with the 5/8" and 7/8" lines marked.

Turn a Square Corner

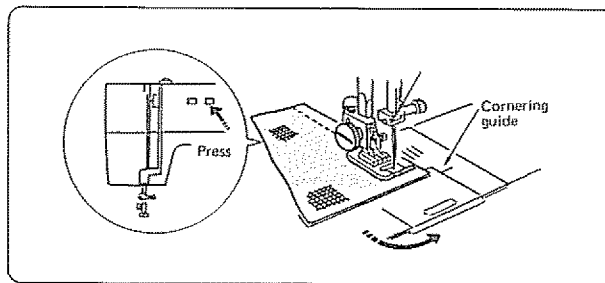

To turn a square corner 5/8" from the fabric edge:

1. Stop stitching and lower the needle by pressing the Up/Down Needle Position button when the fabric edge facing you lines up with the cornering guide, as shown.
2. Raise the presser foot and turn the fabric to line the edge with the 5/8" seam guide.
3. Lower the presser foot and begin stitching in the new direction.

Sew on Heavy Fabrics

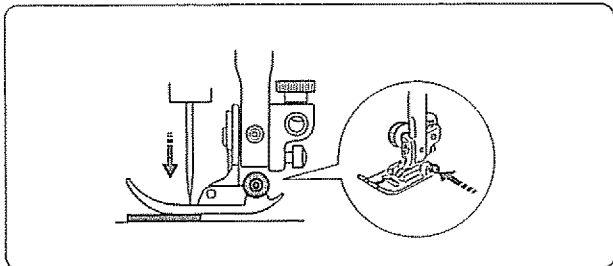

When sewing from 3 to 12 layers of fabric, such as sewing over welt seams when hemming jeans.

1. Use Foot A (Zigzag foot) with the black spring button.

NOTE: This black button locks the foot so it does not give with the fabric.

2. Sew as usual.
3. Stop when your needle reaches the point where the fabric layers increase.
4. Lower the needle and raise the presser foot.
5. Press and hold the black button as you lower the presser foot.
6. Release the black button and continue sewing.

Use the Darning Plate

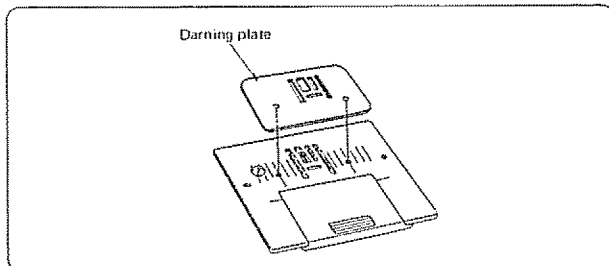

Sometimes when you sew, you want to control the fabric yourself. The Darning Plate covers the feed dogs so that they do not touch the fabric.

To Put on the Darning Plate:

NOTE: The rectangular holes in the Darning Plate match the holes in the needle plate. In the darning plate, these holes are slightly to the right of center.

1. Position the darning plate with the pins on the bottom.
2. Fit the darning plate pins into the needle plate holes at the 5/8" mark. The feed dogs will show through the darning plate holes.

Use the darning plate in the following ways:

- Basting (p. 36)
- Darning (p. 37)
- Button Sewing (p. 38)

SECTION 4. PRACTICE COMMON STITCHING SKILLS

Basting 19

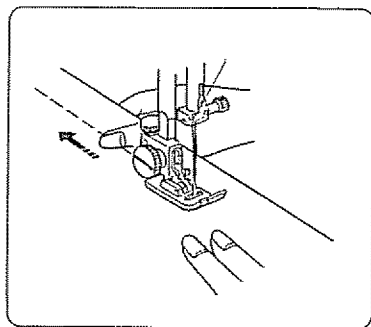
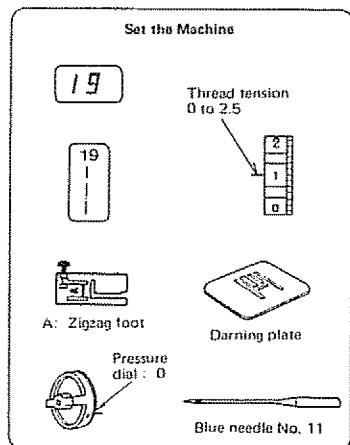

1. Press the foot control.
The machine will take one stitch and stop automatically.
2. Release the foot control.
3. Hold the fabric taut and slide it to the place where you want the next stitch.
4. Press the foot control.
5. Take out the darning plate when finished.

NOTE: Reset the tension and pressure dial for straight sewing.

Use the darning plate for basting.
(See p. 35 for details.)

Use this stitch to:

- baste seams.
- tailor tack.
- tack quilt layers.

CAUTION: Do not use this stitch if the needle will leave permanent marks in the fabric. A small needle will be less likely to leave permanent marks.

Darning 10

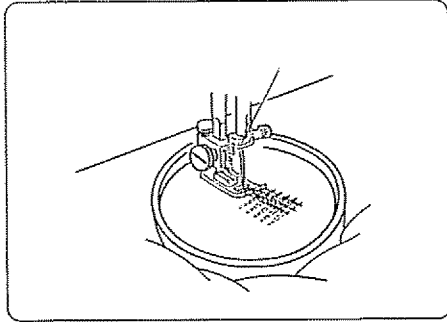
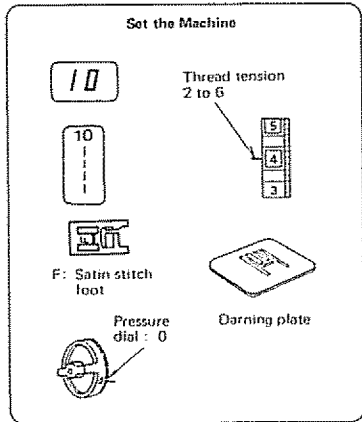

1. Put the darning plate on the needle plate (see p. 35).
2. Stretch the fabric with the hole in the center between embroidery hoops, as shown.
3. Lower the presser bar and sew at a slow speed.
4. Move the fabric back and forth slowly until you have covered the darning area.
5. Turn the fabric 1/4 turn and sew another layer of stitching over the first layer.

NOTE: If your fabric is thin or badly damaged, use a separate piece of fabric under the hole to reinforce it.

6. When you finish darning, return the pressure dial to 3 and remove the darning plate.

NOTE: See the p. 67 ~ 68, automatic darning for a quick, easy way to mend rips & holes.

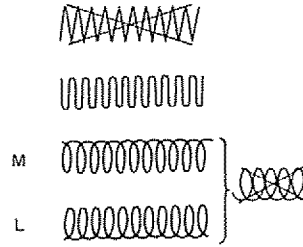

How to darn correctly

Make the turning points of each row blunt or the stitching will draw little holes at the ends. Beginners may prefer the L or M movement.

Take care not to get circles.

The quick mastering of this work depends on regular guiding.

Therefore:

- Hold the hoop correctly.
- Always work from left to right.
- Move work lengthways (not sideways).

SECTION 4. PRACTICE COMMON STITCHING SKILLS

Sew a Button

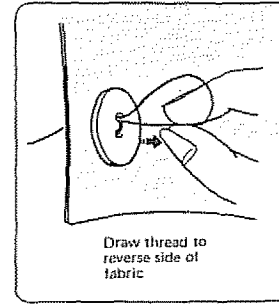
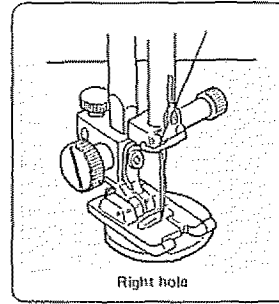
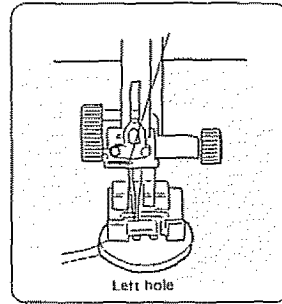
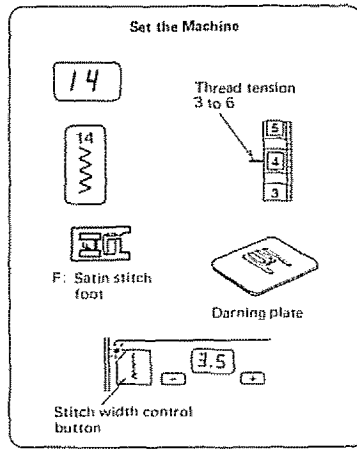

Use the darning plate for button sewing (see p. 35).

1. Match the button holes to the horizontal slot on the presser foot.
2. Lower the foot to hold the button in place.
3. Turn the hand wheel by hand until the needle point is just above the button.
4. Press the stitch width button (+ or -) so the needle will enter the left hole of the button.
5. Turn the hand wheel so the needle will enter the right hole of the button. Readjust the stitch width if necessary.
6. Stitch several times.
7. After you finish sewing, cut the thread but leave 3 to 4 inches of thread at the button.
8. Draw the thread to the reverse side of the fabric and knot the threads.

Put in a Zipper

It's as easy as A – B – C

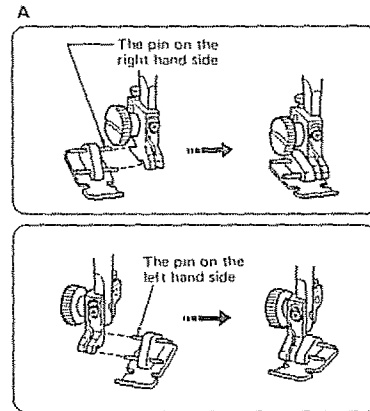
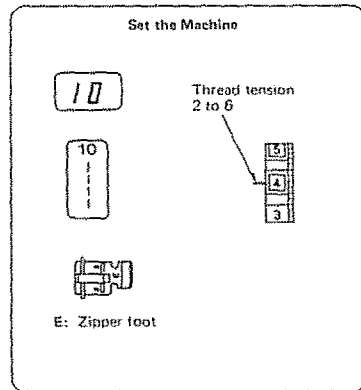

A. Attach the zipper foot, as shown.

1. To sew on the left side of the zipper, attach the presser bar to the right pins on the zipper foot.
2. To sew on the right side of the zipper, attach the presser bar to the left pins on the zipper foot.

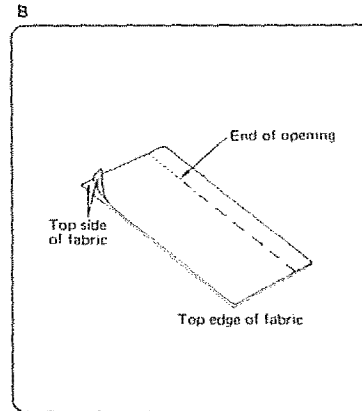

B. Prepare your fabric.

1. Put the top sides of the fabric together and sew to the end of the zipper opening. Use the reverse to lock the stitches.
2. Set the stitch length at "4.5" and sew the zipper opening.

SECTION 4. PRACTICE COMMON STITCHING SKILLS

Put in a Zipper (Continued)

C

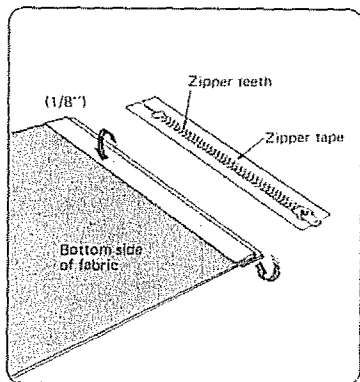

C. Sew in the zipper.

1. Fold back the left seam allowance as shown.
2. Turn under the right seam allowance to form a 1/8" fold.
3. Place the zipper teeth next to the 1/8" fold and pin in place.

NOTE: Be sure the top of the zipper (the slider) is at the top of the garment.

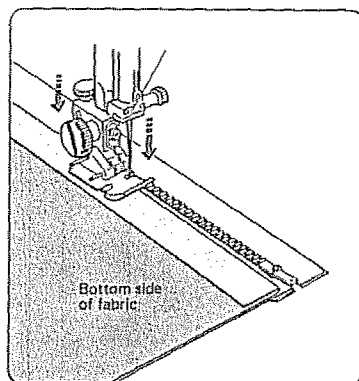

4. Attach the presser bar to the right pins on the zipper foot.

5. Lower the zipper foot on the top side at the bottom of the zipper so that the needle pierces the fold and the zipper tape.

6. Sew through the fold and the zipper tape to the point where the slider begins.

7. Lower the needle to hold the fabric and raise the presser foot.

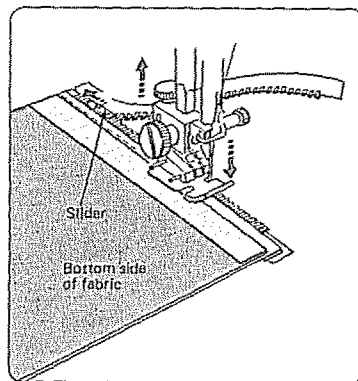

8. Open the zipper.

9. Lower the presser foot and stitch the rest of the seam.

SECTION 4. PRACTICE COMMON STITCHING SKILLS

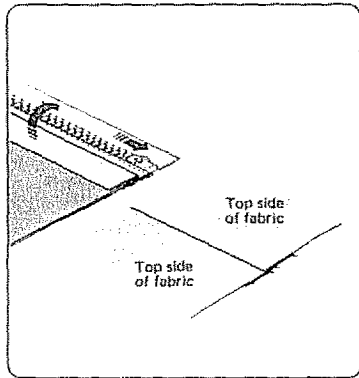

10. Close the zipper and turn the fabric top side up. Spread flat.

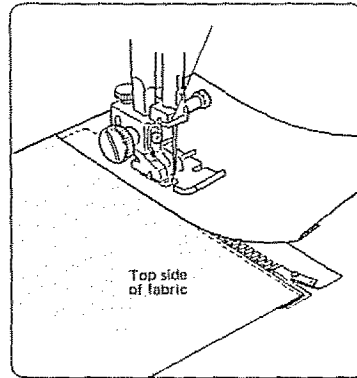

11. Remove the zipper foot and attach the presser bar to the left pins on the zipper foot.
12. Stitch across and below the bottom of the zipper.
13. Turn the corner and continue to guide the foot along the zipper teeth, as shown. Stitch through the fabric and the zipper tape.

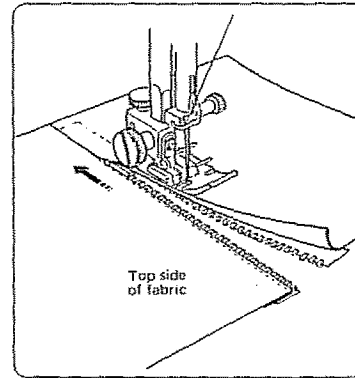



14. Stop about two inches from the top of the zipper.
15. Lower the needle into the fabric and raise the presser foot.
16. Remove the basting stitches and open the zipper.
17. Lower the foot and stitch the rest of the seam. Make sure the fold is even.













SECTION 5. LEARN THE STITCHES

Chart of Sewing Functions

Now that you are familiar with your machine and ready to sew, what are you going to sew? The following chart tells you (in alphabetical order) what sewing functions this machine performs and directs you to the proper page for detailed instructions. In many cases, you also have a choice of stitches.















| FUNCTION | STITCH PATTERN(S) | Ref. Page | FUNCTION | STITCH PATTERN(S) | Ref. Page |
|-----------------------------|---|-----------------------------|-----------------------|-----------------------------------|---|
| APPLIQUE | 30, 31 | 46, 79 | GATHER | 10 | 43, 55 |
| BARTACK | 13, 14 | 43, 63 | HEMS | 15, 16, 20, 27, 28 | 44~46, 64, 65, 76 |
| BASTE | 10, 19 | 36, 43, 44 | KNITS, STRETCH FABRIC | See all Stitches marked "S" | 43~48, 56, 58~59, 64~66, 76, 78~83, 87~88 |
| BATHING SUIT, SEW | 20 | 45, 65 | MEND | 10, 13, 14, 29 | 37, 43, 60, 63, 67~68 |
| BLIND HEM | 16, 28 | 44, 46, 76 | PINTUCK | 10 | 43, 53 |
| BUTTON, SEW | 14 | 38, 43 | QUILT | 10 | 43, 54 |
| BUTTONHOLE | | 49, 69~74 | REINFORCE SEAMS | 13, 17, 25, 26, 33, 35 | 43, 45, 58, 63, 80~82 |
| BARTACK |  | | SHELL TUCKS | 28 | 46, 77 |
| ROUNDED |  | | SMOCK | 23, 24, 36, 37, 41 | 47, 87 |
| KEYHOLE |  | | STRAIGHT SEAM | 10, 12 | 43, 50~55, 57 |
| CROSS STITCH | 34 | 47, 86 | STRETCH STITCH | 11 and all Stitches marked "S" | 43~48, 56, 58~59, 64~66, 76, 78~83, 87~88 |
| CUT-OUT WORK | 30, 31 | 46, 79 | TOPSTITCH | 10 | 43, 51 |
| DARN | 10, 13, 14, 29 | 37, 43, 46, 67, 68 | SADDLE STITCH | 18 | 44, 59 |
| EDGE A GARMENT/PROJECT | 15, 20, 21, 27, 28 30, 31 | 44~46, 64~65, 76, 78~79 | OUTLINE STITCH | 17 | 44, 58 |
| DECORATE (WITH STITCHES) | 23~26, 28, 36, 37, 41~54 | 45, 48, 77, 80, 83, 87 | TRIMS, SEW | 20~22 | 65, 78 |
| ELASTIC, APPLY | 25, 33, 35 | 45, 47, 80, 82 | TWIN NEEDLE STITCH | 21, 22, 24, 25, 30 | 45, 83 |
| EMBROIDER | 10, 14, 34, 38, 55, 56 | 43, 47~48, 61, 86, 88~89 | ZIPPER | 36, 40, 41 10 | 39~41, 43 |
| FAGOTING (create open work) | 25, 26, 33 | 45, 47, 81 | | | |
| FINISH RAW EDGE | 13~16, 20, 28 | 43~46, 62~65, 76 | | | |

Stitch Pattern Chart











| Stitch Pattern | No. | Foot | Other Attach. | Needle | Thread Tension | Pressure Dial | Uses | Refer to Page |
|---|-----|--|--|----------------------|----------------|---------------|---|----------------------|
| STRAIGHT  | 10 | Straight (H)  Zigzag (A)  | Quilter Darning plate Zipper foot Blind hem stitch foot Satin stitch foot | Check Chart on p. 17 | 2 ~ 6 | 3 | Regular seams, pintucking, quilting, zippers, topstitching, darning, mending, basting, gathering, etc. | 37, 39 ~ 41, 50 ~ 55 |
| STRAIGHT STRETCH  | 11 | Straight (H)  Zigzag (A)  | ————— | Check Chart on p. 17 | 2 ~ 6 | 3 | Use on knits and other stretch fabrics, good for topstitching. | 56 |
| LOCK-A-MATIC SEAM  | 12 | Zigzag (A)  | ————— | Check Chart on p. 17 | 2 ~ 6 | 3 | For fastening and securing at the beginning and the end of a seam. (Press the Reverse Button at end of seam.) | 57 |
| MENDING  | 13 | Zigzag (A)  | ————— | Check Chart on p. 17 | 3 ~ 6 | 3 | Use for sewing patches, repairing straight or corner tears, finishing seams on terrycloth, sewing bar tacks for belt loops and drapery pleats (strong than zigzag). | 63 |
| ZIGZAG (regular)  | 14 | Zigzag (A)  Overedge (C)  | Darning plate Satin stitch foot | Check Chart on p. 17 | 3 ~ 8 | 3 | Mend, darn, finish edges, apply trims, embroider, gather, buttons, satin stitch, monogram decorative stitches. | 38, 60 ~ 62 |

SECTION 5. LEARN THE STITCHES

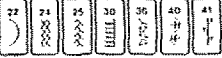
Stitch Pattern Chart (Continued)









| Stitch Pattern | No. | Foot | Other Attach. | Needle | Thread Tension | Pressure Dial | Uses | Refer to Page |
|---|-----|--|---|----------------------|----------------|---------------|---|---------------|
| OVEREDGE SEAM  S | 15 | Overedge (C)  |  | Check Chart on p. 17 | 3 ~ 7 | 3 | Use for overcasting, for knits and woven fabrics needing extra strength, for narrow seams on knits or heavy weight woven fabrics. | 64 |
| BLIND HEM STITCH  S | 16 | Blind Hem Stitch (G)  |  | Check Chart on p. 17 | 2 ~ 6 | 3 | Use for stretch fabrics, more elastic. | 75 ~ 76 |
| OUTLINE STRETCH  S | 17 | Zigzag (A)  |  | Blue (11) | 3 ~ 6 | 3 | Use in place of straight stitch on knits, bias seams, tricot, chiffon for a flat, non-puckering seam. | 58 |
| SADDLE STITCH  S | 18 | Zigzag (A)  Blind Hem Stitch (G)  |  | Check Chart on p. 17 | 2 ~ 6 | 3 | Topstitching suits, blazers, jumpers, denim outfits. | 59 |
| BASTING  S | 19 | Zigzag (A)  | Darning plate | Blue (11) | 0 ~ 2.5 | 0 | Basting, tailor tacks, tack quilt layers. | 36 |

Stitch Pattern Chart





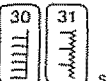











| Stitch Pattern | No. | Foot | Other Attach. | Needle | Thread Tension | Pressure Dial | Uses | Refer to Page |
|---|--|---|---------------|----------------------|----------------|---------------|--|---------------|
| KNIT STITCH  S | 20 | Zigzag (A)  | ————— | Blue (11) | 3 ~ 6 | 3 | Use for swimwear and stretch velour. | 65 |
| TWIN NEEDLE STITCHES  S | 21 22 24 25 30 36 40 41 | Zigzag (A)  or Satin (F)  | Twin Needle | | 3 ~ 7 | 3 | Use for sewing parallel rows of straight or decorative stitches adding an exquisite touch to table linen and clothing.  | 63 |
| SCALLOP STITCH  S | 21 22 | Zigzag (A)  | ————— | Check Chart on p. 12 | 3 ~ 6 | 3 | Use for scalloped edges on collars, pockets or placemats. Create a delicate edge on thin fabrics. Decorate edges on hemlines or sleeves. | 78 |
| FEATHER STITCH  S | 25 26 | Zigzag (A)  | ————— | Check Chart on p. 17 | 2 ~ 6 | 3 | Hand-quilting stitch, used to reinforce stretch and woven fabrics, use on spandex undergarments and to decoratively hem elastic fabric. Use for patchwork quilting. | 80 |
| DOUBLE EDGE ZIGZAG  S | 27 | Overedge (C)  | ————— | Check Chart on p. 17 | 3 ~ 7 | 3 | Use for fabrics that tend to fray extensively such as linens and gaberdines. | 65 |

SECTION 5. LEARN THE STITCHES

Stitch Pattern Chart (Continued)





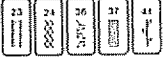



| Stitch Pattern | No. | Foot | Other Attach. | Needle | Thread Tension | Pressure Dial | Uses | Refer to Page |
|---|----------|---|---------------|----------------------|----------------|---------------|---|---------------|
| BLIND HEM STITCH  | 28 | Blind Hem Stitch (G)  | _____ | Check Chart on p. 17 | 2 ~ 6 | 3 | Use for woven fabrics: blind hem and overcasting. | 76 |
| SHELL STITCH  | 28 | Satin (F)  | _____ | Check Chart on p. 17 | 6 ~ 9 | 3 | Finish hems, sleeve and neck openings. Use on nylon tricot and other lingerie to overcast and seam. Do shell tucking on blouses and lingerie. | 77 |
| AUTOMATIC DARNING  | 29 | Sliding Buttonhole (J)  | _____ | Check Chart on p. 17 | 2 ~ 6 | 3 | Darn rips and holes quickly and automatically. | 67 ~ 68 |
| CUT-OUT WORK APPLIQUE  | 30 31 | Satin (F)  | _____ | Check Chart on p. 17 | 2 ~ 6 | 2 | Use on cut-out work and applique for edging the designs, also on placemats, blankets, collars, cuffs and pockets. | 79 |

Stitch Pattern Chart

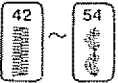

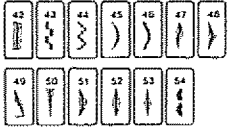
| Stitch Pattern | No. | Foot | Other Attach. | Needle | Thread Tension | Pressure Dial | Uses | Refer to Page |
|--|----------------------------|---|---|----------------------|----------------|---------------|--|---------------|
| RICK-BACK STRETCH  s | 32 | Zigzag (A)  Satin (F)  |  | Check Chart on p. 17 | 2 ~ 6 | 3 | Decorate garments with one row or several. | 66 |
| ELASTIC CASING FAGOTING  s | 33 | Satin (F)  | Use paper behind | Check Chart on p. 17 | 3 ~ 8 | 3 | Elastic Casing: Replace bias tape casings in wrists and waists; tack down elastic. Fagoting: Join two folded edges for decorative open-work appearance. | 81 ~ 82 |
| CROSS STITCHING  s | 34 | Satin (F)  |  | Check Chart on p. 17 | 2 ~ 6 | 3 | Use in embroidery, combine with letters and numbers for samplers. | 86 |
| ELASTIC STRETCH  s | 35 | Zigzag (A)  Satin (F)  |  | Check Chart on p. 17 | 3 ~ 6 | 3 | Use for applying elastic. | 82 |
| SMOCKING STITCHES  s | 23 24 36 37 41 | Zigzag (A)  Satin (F)  |  | Check Chart on p. 17 | 2 ~ 6 | 3 | Smocking on children's clothes, blouses, curtains, etc.  | 87 |

SECTION 5. LEARN THE STITCHES

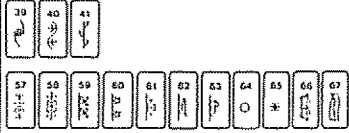
Stitch Pattern Chart (Continued)

| Stitch Pattern | No. | Foot | Other Attach. | Needle | Thread Tension | Pressure Dial | Uses | Refer to Page |
|--|-------------------------|---|---------------|----------------------|----------------|---------------|--|----------------|
| SAND STITCHING  S | 38 | Satin (F)  | — | Check Chart on p. 17 | 2 ~ 6 | 1 or 2 | Fill in designs already outlined with satin or other embroidery stitch. | 88 |
| DECORATIVE GEOMETRICS  | 42~ 54 | Satin (F)  | — | Check Chart on p. 17 | 2 ~ 8 | 3 | Decorate garments with one row or several, one stitch or a combination.  | 84 |
| SHADING STITCH  | 55 56 | Satin (F)  | — | Check Chart on p. 17 | 2 ~ 8 | 1 or 2 | Use for free hand machine embroidery and attractive shading stitch applique. | 89 |
| STRETCH STITCH DECORATIVE | 39~ 41, 57~ 67 | Satin (F)  | — | Check Chart on p. 17 | 2 ~ 6 | 3 | Decorate with flower or leaf designs. Use in combination (programmable) or singly.  | 85, 90 ~ 91 |

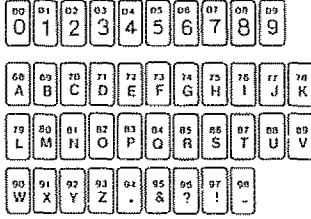
Stitch Pattern Chart

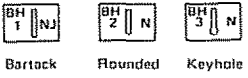
| Stitch Pattern | No. | Foot | Other Attach. | Needle | Thread Tension | Pressure Dial | Uses | Refer to Page |
|--|-----------------------------|--|---------------|----------------------------|----------------|---------------|--|---------------|
| MONOGRAM Numbers, Letters, Period, Space | 00~ 09, 68~ 98 | Satin (F)  | _____ | Check Chart on p. 17 | 2 ~ 6 | 3 | Numbers and letters or sentences may be programmed in sequence for monogramming.  | 93 |
| BUTTONHOLE Bartock Rounded Keyhole | 1 2 3 | Sliding Buttonhole (J)  Automatic buttonhole (N)  | _____ | Check Chart on p. 17 | 2 ~ 6 | 3 | Buttonholes in three shapes: also corded buttonholes.  | 69 ~ 74 |

SECTION 5. LEARN THE STITCHES

Straight Stitches 10 ~ 12, 17 and 18

When you turn on your machine, it is automatically set to sew a straight stitch (pattern 10).

• Straight Stitch

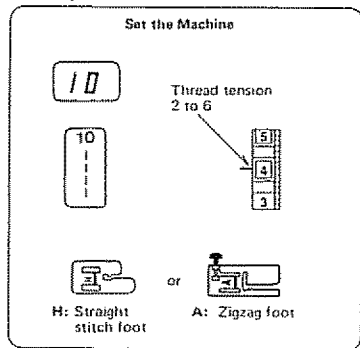

The Stitch and Its Uses

You can use your basic straight stitch in many ways besides just sewing a straight seam. Three common uses for the straight stitch are:

Pintucking
Quilting
Topstitching

All are discussed in this section.

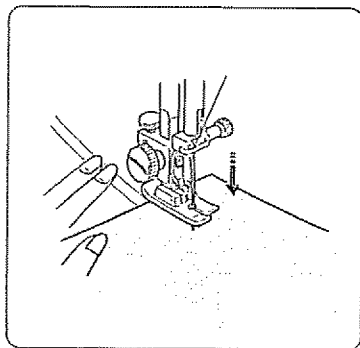

To sew a straight stitch:

1. Raise the presser foot.
2. Raise the needle to its highest position.
3. Place the edge of the fabric next to a stitching guide line on the needle plate (5/8" is most common).
4. Draw the threads towards the back and lower the presser foot.
5. Press the foot control.
6. Hold the fabric loosely and gently guide it along the guide line, so that it feeds naturally.
Do not force the fabric or try to pull it tight.
7. At the end of the seam, you may want to reverse to lock the stitch.
8. When you stop sewing, the needle will automatically rise to its highest position.
9. Raise the presser foot and remove the fabric.
10. Cut the threads.

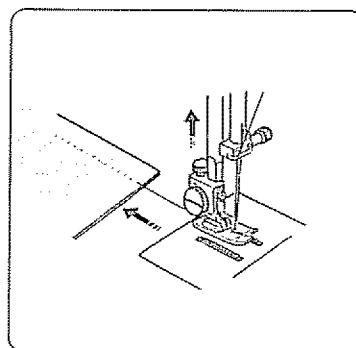

• Topstitching

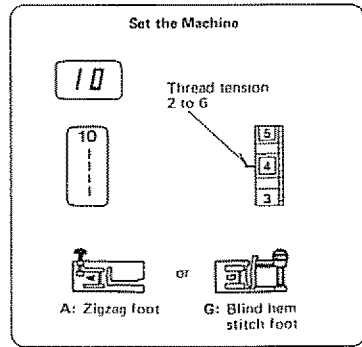

The Stitch and Its Uses

Topstitching emphasizes the lines of your garment and keeps seams and edges flat and crisp.

Accent suits or blouses with one or two rows of topstitching around the outer edges of cuffs, lapels or collars.

Use the Auto-Lock button to secure your topstitching and eliminate unsightly back-tacking.

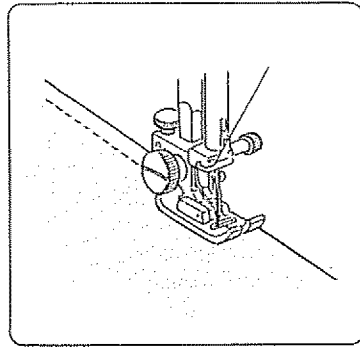

Here's How

1. Lower the presser foot.
2. Keep the edge of the fabric next to the right edge of Foot A.
3. Evenly guide the fabric along this edge to produce an even row of topstitching $3/8$ " from the edge.

NOTE: You can easily adjust your needle from left to right for topstitching without moving your fabric from under the presser foot. See the next page for instructions.

SECTION 5. LEARN THE STITCHES

Straight Stitches 10 ~ 12, 17 and 18 (Continued)

• Position Your Needle for Topstitching

The needle has three positions:
left, center and right.

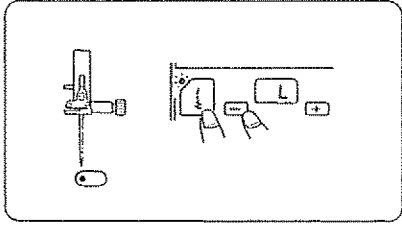

To position the needle to the left:

1. Press the stitch width control button.
2. Press the stitch length/width decrease button.
3. The stitch length/width indicator will show "L" or left needle position.

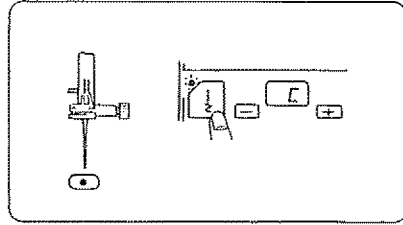

To position the needle at the center:

1. Press the stitch width control button.
2. The stitch length/width indicator shows "C" or center needle position.

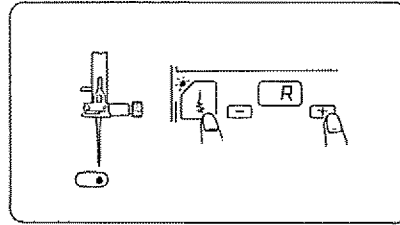

To position the needle to the right:

1. Press the stitch width control button.
2. Press the stitch length/width increase button.
3. The stitch indicator will show "R" or right needle position.

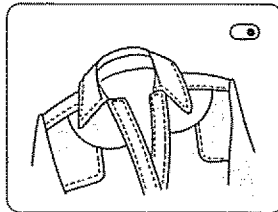
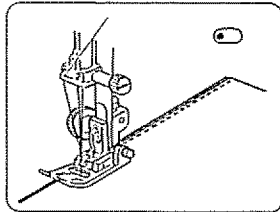

NOTE: Left or right needle position is recommended for stitching edge of the fabric.

Besides the normal straight stitch method of topstitching, this machine does other types of topstitching that are better for knits or produce a more elaborate decorative effect.

Always use zigzag foot A for left and right needle position.

• **Pintucking**

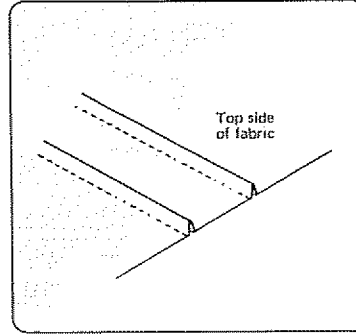
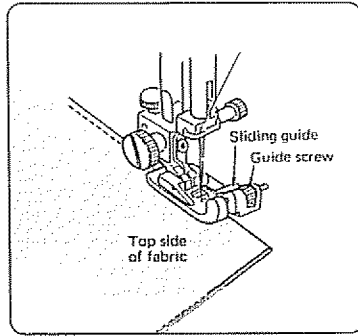
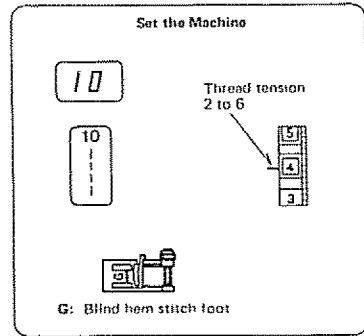

The Stitch and Its Uses

Pintucks are narrow tucks spaced close together to add design interest on such items as blouses and pillowcases. One pintuck can form a permanent front crease on knit pants.

Here's How

1. Attach the blind stitch hem foot.
2. Place the folded fabric under the presser foot.
3. Position the needle 1/16" inside from the folded edge and lower the presser foot.
4. Adjust the sliding guide on the blind hem foot to the folded edge by turning the guide screw, as shown.
5. Feed the folded edge smoothly against the sliding guide.

NOTE: If the fabric tends to pucker, hold the material slightly taut while sewing. Also, decrease the upper tension slightly.

SECTION 5. LEARN THE STITCHES

Straight Stitches 10 ~ 12, 17 and 18 (Continued)

• Quilting

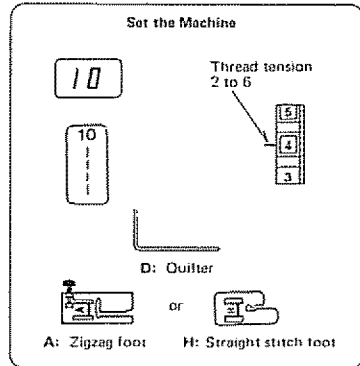

The Stitch and Its Uses

Quilting is stitching two layers of fabric together with batting in between to add dimension and warmth.

You can use quilting on entire garments or parts of garments, such as yokes, pockets, cuffs and collars. It is also popular for table fashions. In addition to straight stitch quilting, you can quilt with decorative stitches or stitch pattern combinations.

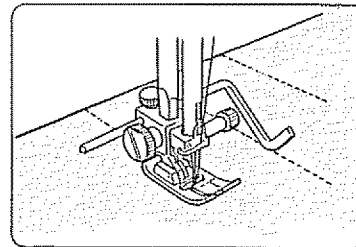
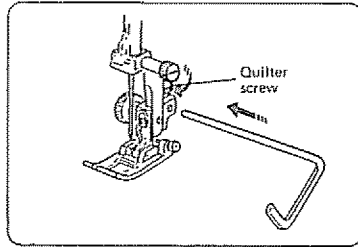

Here's How

To do quilting successfully, follow these simple steps:

1. Loosen the quilter screw on the back of the presser foot as shown.
2. Slide the quilting guide (D) into the opening under the screw to the width between lines of quilting stitches you desire.
3. Tighten the screw.
4. Sew the first row of stitching.
5. Sew other rows, guiding the quilting guide over the previous row of stitching.

NOTE: When you are quilting large areas, tack the layers together with the basting stitch. Then quilt from the center out.

Another quilting variation:

Instead of quilting with rows of straight stitches, you can bartack your quilt at regular intervals.

Set up the machine as if you were going to sew a button (see p. 38). Position your fabric and bartack.

• **Gathering**

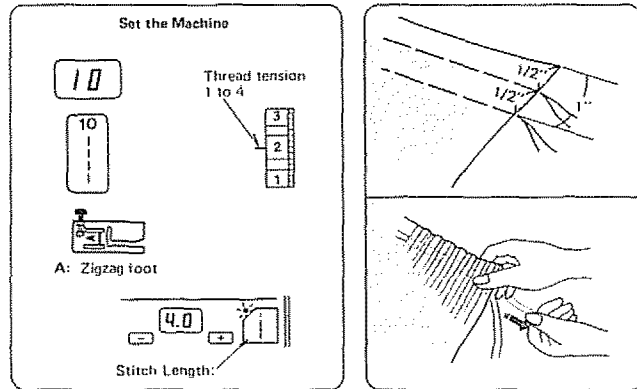

The Stitch and Its Uses

Use this stitch to gather trims, skirts, sleeves at the top, smocking or any time you want more fullness. Use two rows of stitches.

Here's How (for medium weight fabrics and tight, firm gathers)

1. Set the stitch length to "4.0"
2. Loosen the needle thread tension to "2" or as desired.

NOTE: Steps 3 and 4 are for 5/8" seam allowances. For other widths, adjust your fabric accordingly.

3. Sew the first row of stitches with the right edge of Foot A on the edge of the fabric.
4. Sew the second row with the right edge of Foot A following the first row of stitches.
5. Using both hands, pull the bobbin threads from each end of the fabric until you have the gathers you want.
6. Knot the threads at each end even out the gathers.

Here's How (for light weight fabrics, ruffles and flounces)

1. Set your stitch length at "4.5"
2. Secure your gathering rows at the beginning.
3. Stitch two rows, as in steps 3 and 4 for medium weight fabrics.
4. Do not lock the threads at the end of your stitching rows.
5. Pull the bobbin threads to produce the fullness you desire.
6. Knot the threads and even out the gathers.

SECTION 5. LEARN THE STITCHES

Straight Stretch 11

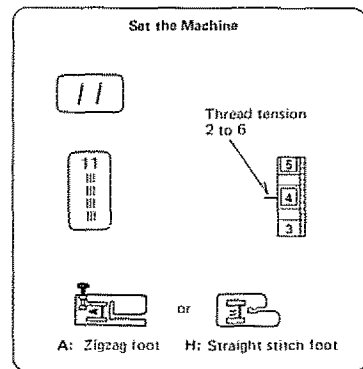

The Stitch and Its Uses

This stitch is the stretch variation of the straight stitch, especially developed for knits and stretch fabrics.

This stitch can also be used for topstitching.

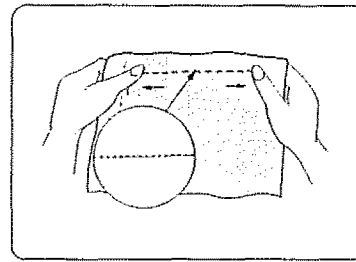
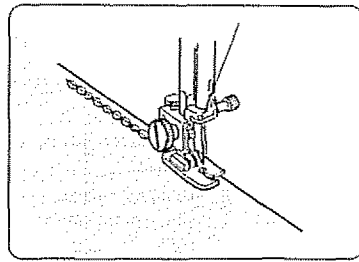

A NOTE ON STRETCH STITCHING

Stretch stitching was developed to be used on stretch fabrics and knits. It can be used on other fabrics as well. It works well on curved seams and on any garments that will receive a great deal of strain (ie. children's clothes).

The stretch stitch does not actually stretch as it is being sewn, but is stitched in a forward and back motion (sometimes called a "reverse-action" stitch), so that it will give instead of break when the fabric stretches.

Lock-a-Matic Seam

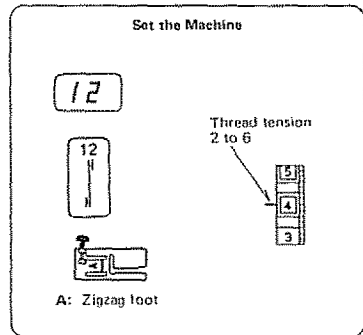

For general sewing, the lock-a-matic stitch is the fastest way to sew and secure a seam.

It is programmed to automatically sew reverse stitches at the beginning and when the reverse stitch button is pressed at the end of a seam.

Seams are sewn quickly and securely.

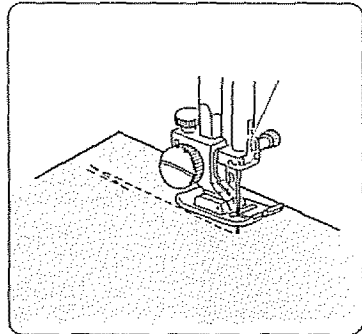

Lower the needle close to the top edge of the fabric.

The machine will sew four stitches forward, four stitches in reverse then continue sewing forward.

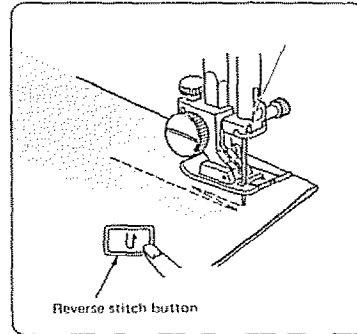

When you reach the lower edge of the fabric, touch the reverse button.

The machine will sew four reverse stitches, four forward stitches, then stop sewing.

SECTION 5. LEARN THE STITCHES

Outline Stretch 17

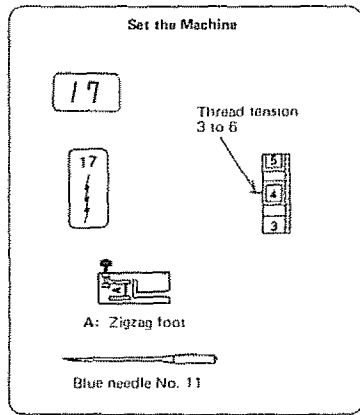

The Stitch and Its Uses

This stitch pattern, a variation of the straight stitch, is a narrow stretch stitch designed to eliminate puckering on knit fabrics and bias seams.

On tricot and filmy chiffons, it can be used to seam and overcast at the same time to produce a narrow, almost invisible seam or seam finish.

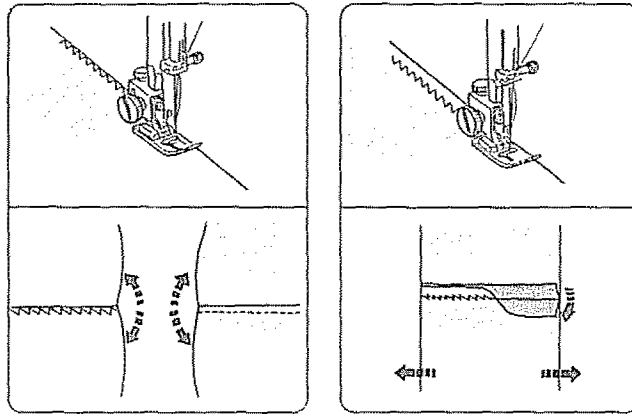

Here's How:

1. Place your fabric edge on the 5/8" seam line in order to produce a 5/8" seam.
2. Sew as you would a straight stitch.

Helpful Hints (for lightweight fabrics)

1. Set the pressure dial at "1" or "2"
2. To seam and overcast tricot:
 - a. Set the stitch width at "3"
 - b. Sew with the right hand stitch falling off the fabric edge.

Saddle Stitch 18

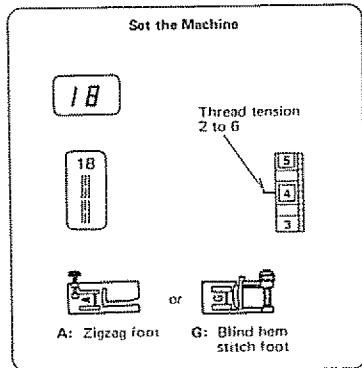
The Stitch and Its Uses

The saddle stitch is formed with one stitch forward, two stitches backward, and a fourth stitch forward.

You can achieve a lovely hand-worked look when topstitching suits, blazers, jumpers, and denim outfits with the saddle stitch.

NOTE: Adjust the needle position for the effect you want.

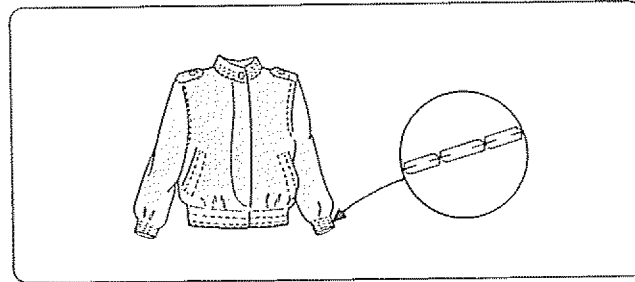
Here's How

1. Sew as you would for topstitching.
2. To turn corners:
 - a. Lower the needle into the fabric on the fourth stitch.
 - b. Raise the presser foot and turn the fabric.
 - c. Lower the presser foot and continue to sew.

Helpful Hint

The Blind hem stitch foot is good to use when topstitching near the edge of the garment. Just set the edge guide with the guide screw.

SECTION 5. LEARN THE STITCHES

Zigzag Stitches **13** ~ **15**, **20**, **27** and **32**

• Basic Zigzag

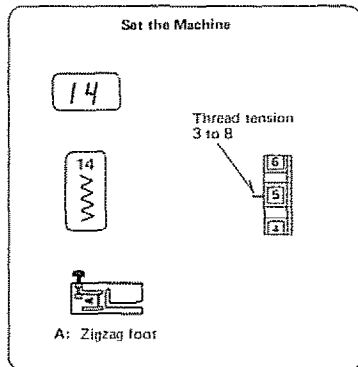

The Stitch and Its Uses

The zigzag stitch is one of the most common and most versatile stitches on your machine. It can be a utility stitch for sewing buttons, buttonholes, hemming, overcasting, mending and darning. It can also be used to decorate with trims, appliques and cut-out work or as a decorative stitch.

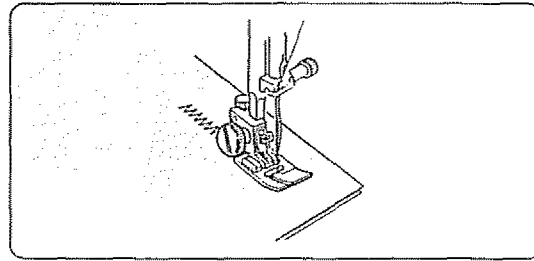

Here's How

The many ways to sew a zigzag stitch are as varied as the stitch patterns on this machine or as the width and length settings allow. Consult the specific variations for detailed directions.

The zigzag stitch as a utility stitch has several variations, discussed in this section:

- Satin Stitch **14**
- Overcasting Stitch **14**
- Multiple Zigzag **13**
- Overedge Seam **15**
- Knit Stitch **20**

• Satin Stitch

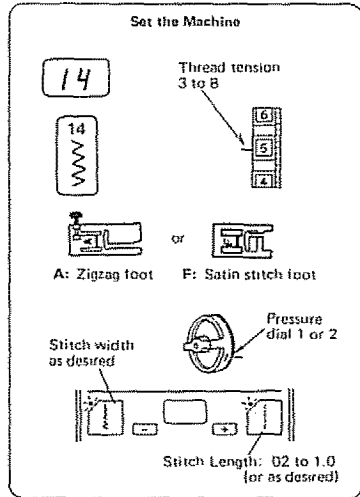

The Stitch and Its Uses

The Satin stitch is a versatile and often used decorative stitch, but it can also be used to overcast a raw edge (for example, blankets, linens, tablecloths and napkins).

The Satin stitch is especially attractive in applique and is the basis for the geometric stitches 42 to 54 on this machine.

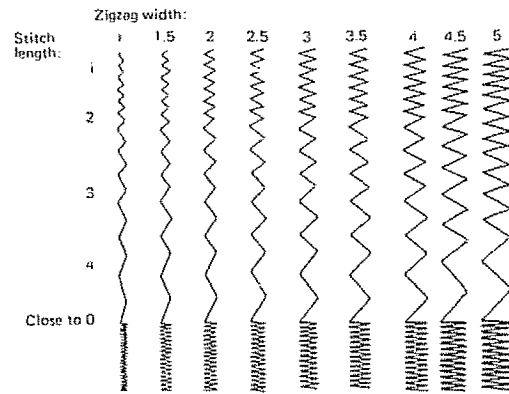

Here's How

Once your machine is set up to stitch, you may want to experiment on a fragment of the fabric you are planning to use. Too tight a satin stitch may pucker some light weight fabrics.

Otherwise, stitch as usual.

SECTION 5. LEARN THE STITCHES

Zigzag Stitches 13 ~ 15, 20, 27 and 32 (Continued)

• Overcasting Stitch

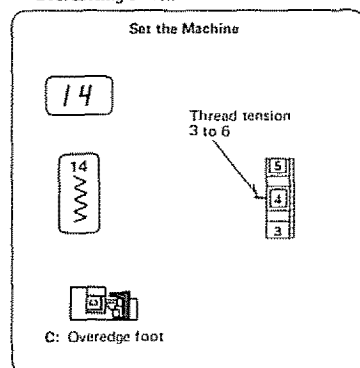

The Stitch and Its Uses

This zigzag variation is very useful in garment construction and in finishing raw edges of any sewing project.

Here's How

1. The black ridge and brush and the guide wires on the overedge foot keep the edge neat and the fabric straight.
2. Place your fabric so that the double guide wires come to the edge.

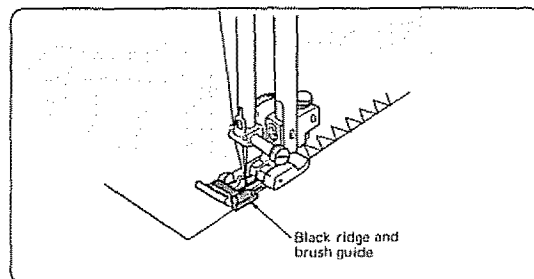

NOTE: These wires keep light weight fabric from rolling into a ridge and hold medium weight fabric flat.

The machine will stitch over these wires. The black ridge and brush will keep the loose threads in so that the needle can stitch over them.

3. As you sew, be sure your fabric edge pushes against the black ridge and brush guide.
4. When you stop sewing, remove the fabric by drawing it to the back and out. The fabric will catch on the wire guides if you pull it toward you.

For overcasting folded fabric:

You can also fold the raw edge of the seam and overcast.

1. Start the fold by sliding it under the needle and lowering the needle.

NOTE: Be sure your needle is in the left position.

2. Lower the presser foot so that both guide wires are on the fabric.
3. Fold the fabric to the left 1/8" as you feed it into the machine and stitch.

Helpful Hints

Start overcasting about 1/8" inside the raw corner of your seam. If you start right at the edge, the fabric will bunch up and the stitches will become tangled.

• Mending 13

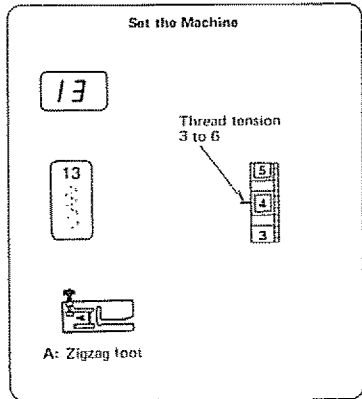
The Stitch and Its Uses

The mending or multiple zigzag is a combination zigzag and straight stitch. Use the mending everywhere you would use the basic zigzag stitch. It has more strength, elasticity, and is flatter than a regular zigzag.

The mending stitch is especially useful for:

- sewing patches smoothly and securely.
- repairing straight tears.
- finishing seams on terrycloth.
- sewing bar tacks for belt loops and drapery pleats.

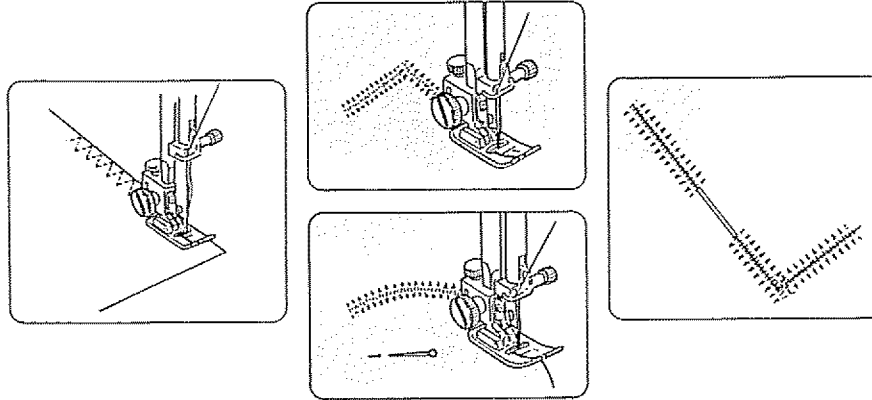
Here's How to Repair a Tear:

Straight — position the tear under the needle so that the stitching will catch both sides.

Cornered — stitch from each end to the center. Use a piece of fabric under the tear to reinforce your mending.

SECTION 5. LEARN THE STITCHES

Zigzag Stitches 13 ~ 15, 20, 27 and 32 (Continued)

• Overedge Seam 15

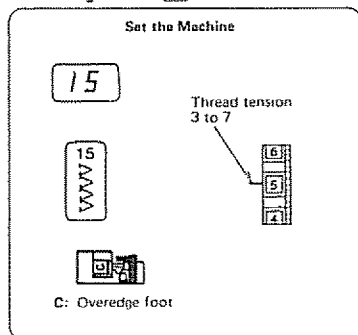

The Stitch and Its Uses

This stitch pattern combines the straight and the zigzag stitches, using the overedge foot, to stitch and overcast seams in one step. It also is a stretch stitch to provide elasticity for knits and extra strength for woven fabrics.

Use this stitch when you want a narrow seam that you do not need to press open flat. It is ideal for 1/4" seams on knits (when attaching ribbing) or on medium to heavyweight woven fabrics where you want a narrow seam.

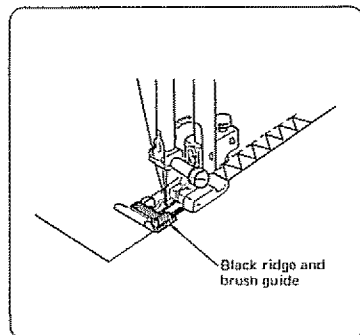

Here's How

1. Place your fabric so that the raw edges fit under the wire guides and touch the black ridge and brush guide.
2. Gently guide the fabric so that the raw edges always touch the black ridge and brush guide.

NOTE: When sewing over several thickness (under arms, in crotch, etc.) raise the presser foot slightly to ease the presser foot over the hump and keep stitches from bunching.

3. When you stop sewing, remove the fabric by drawing it to the back and out. The fabric or stitching will catch on the wire guides if you pull it toward you.

• Knit Stitch 20

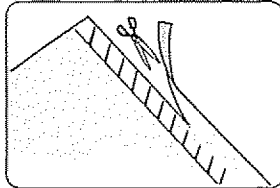
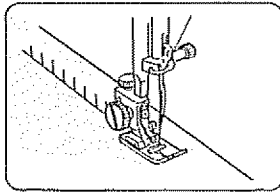
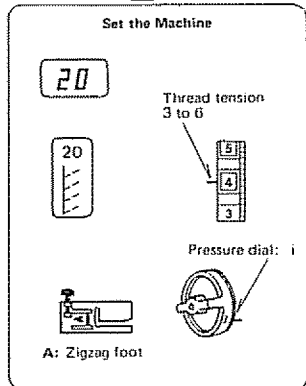
The Stitch and Its Uses

This knit stitch is ideal for sewing swimwear and stretch velour, because it provides the greatest amount of elasticity and strength.

Here's How

1. Place your fabric to allow a 5/8" seam.
2. Trim the seam allowance after sewing.

NOTE: Be careful not to cut the stitches.

• Double Edge Zigzag 27

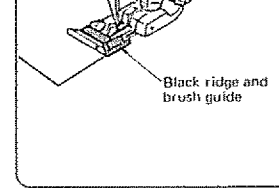
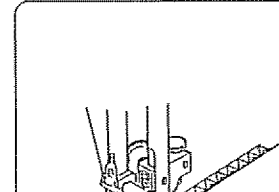
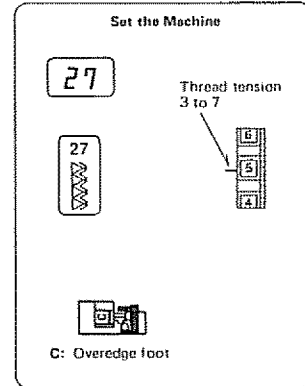
The Stitch and Its Uses

This stitch can be used for sewing fabrics that tend to fray extensively such as linens and gabardines.

Here's How

Two rows of zigzag stitches are simultaneously sewn over the edge to insure that your seams will not ravel.

SECTION 5. LEARN THE STITCHES

Zigzag Stitches **13** ~ **15**, **20**, **27** and **32** (Continued)

• Rick-Rack Stretch **32**

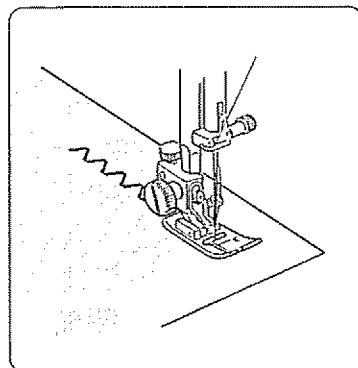
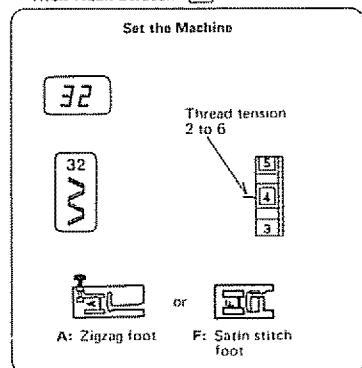

The Stitch and Its Uses

Sew on stretch fabrics in any area that you might use a zigzag stitch.

This stitch can be used as a decorative top stitch as well.

Automatic Darning 29

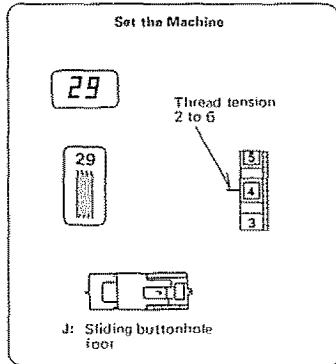

The Kenmore 100 Stitch automatically darns rips and holes. Large and small holes can be mended quickly and easily with this unique stitch.

Buttonhole foot J is used to hold the fabric securely while darning.

For extra support, or strengthen the darn, pin or baste a backing fabric such as organdy under the hole to be darned.

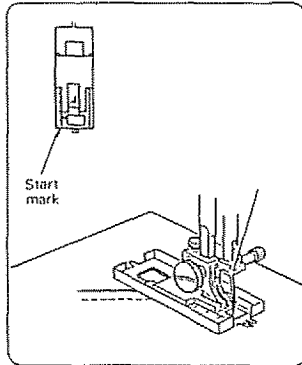

Press down the foot control. The machine will lock the stitches, sew 16 rows of darning, lock the stitches and stop automatically.

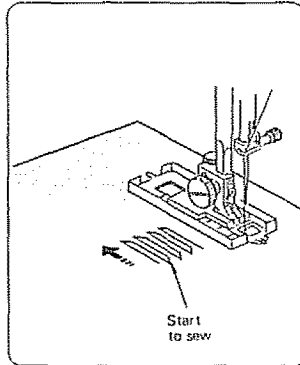

Keep the foot control depressed until the machine stops sewing.

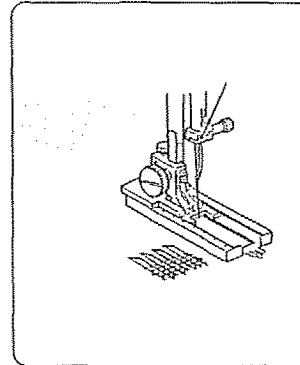

For extra strength on blue jeans or other work clothes the darn can be reinforced as shown above.

The finished darn measures 2.0 cm (4/5") long by 0.7 cm (1/4") wide.

If hole is larger, move the fabric and sew additional darning units until the hole is covered.

SECTION 5. LEARN THE STITCHES

Automatic Darning 29 (Continued)

• Darning Small Rips

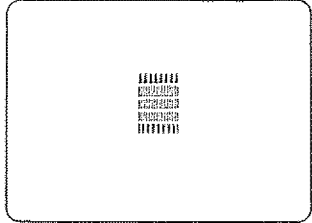

Small rips can be repaired by programming the machine to sew a shorter darn.

Begin the first row of the darn stopping the machine when you reach the bottom edge of the rip. For example, you may only need to sew 5 stitches. Press the reverse button but do not hold it. The machine will now complete the 16 rows with 5 stitches in each row and stop automatically.

It is simple to make a darning of same size as the first one.

Press memory button when you have completed the first darning, and depress the foot control. Then the second darning is automatically made. Pressing mirror image button instead of memory button will give the same result but the darning is made in the reverse sequence.

• Adjusting Evanness of Darning

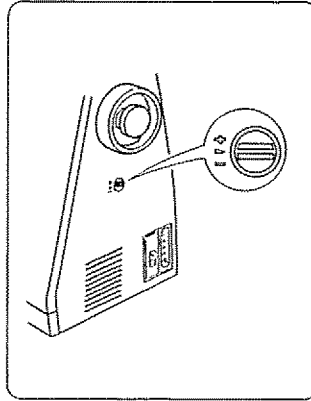

When the left side is lower, turn the feed balance dial to "+"



When the right side is lower, turn the feed balance dial to "-"

* After darning, return setting mark to "▷"

Automatic Buttonholing

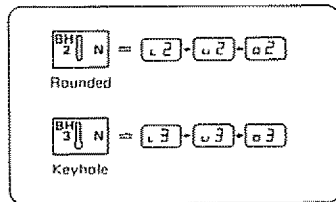
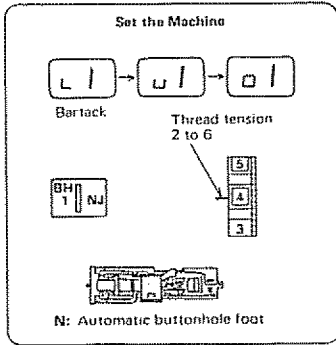

The Kenmore 100 Stitch sews three different types of buttonhole to meet every sewing need. All three buttonholes are made in the same way.

Automatic buttonhole foot will gauge the buttonhole length.

Before you sew buttonholes on the actual garment, make several practice buttonholes.

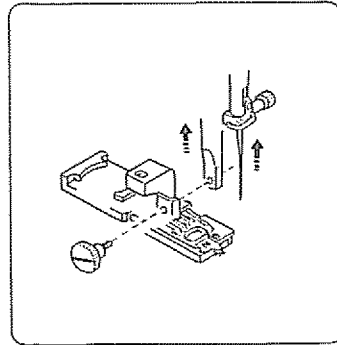

1. a. Press the Up/Down Needle Position Button to raise the needle to its highest position.
- b. Raise the presser foot.
- c. Remove the foot holder.
- d. Attach the automatic buttonhole foot by tightening the foot holder screw.

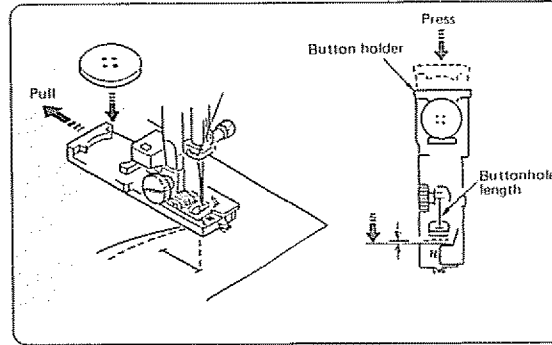

2. a. Draw both threads toward the left under the foot.
- b. Lower the needle to the bottom mark.
- c. Lower the presser foot.
- d. Open the button holder by pulling it back as shown above.
- e. Place the button you intend to use on the button holder of the automatic buttonhole foot N.
 1. Press the back of the holder towards you to secure the button.

NOTE: If the thickness of button is more than 0.4 cm (3/16"), measure thickness and diameter and set the button holder as shown.

EXAMPLE: If the button is 2 cm (3/4") in diameter and 0.5 cm (3/16") in thickness, set the measure 2.5 cm (31/32").

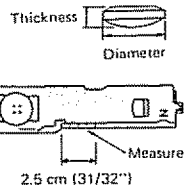

SECTION 5. LEARN THE STITCHES

Automatic Buttonholing (Continued)

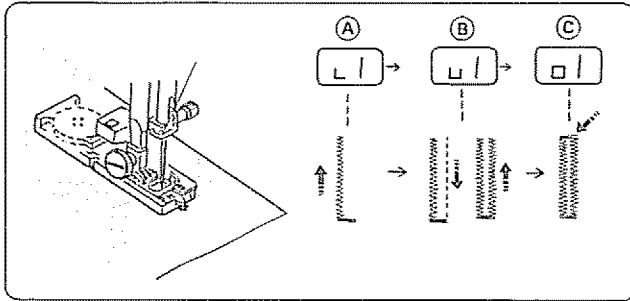

3. a. Select and press one of the buttonholing buttons which you want to sew.

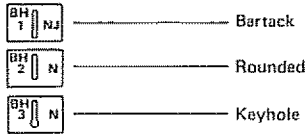

b. Depress the foot control until the machine stops automatically.

4. a. If you want to sew another buttonhole identical to the first, press the same selected buttonholing button.

b. Press the foot control until the machine stops by itself.

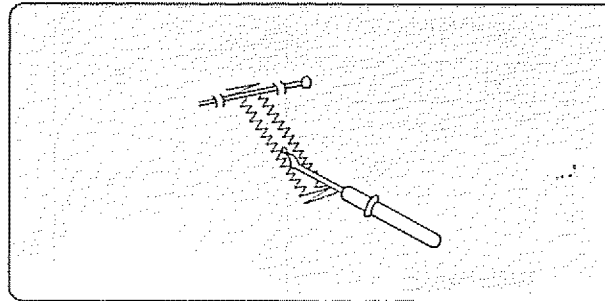

5. Cut the opening with the buttonhole opener in your accessory box.

NOTE: If you want to wind the bobbin in the middle of buttonholing, press the clear button. Then, place the threaded bobbin on the bobbin winding spindle and push the spindle to the right until it clicks. Depress the foot control and wind the bobbin.

- Adjust the Stitch Width and Density

Stitch Width:

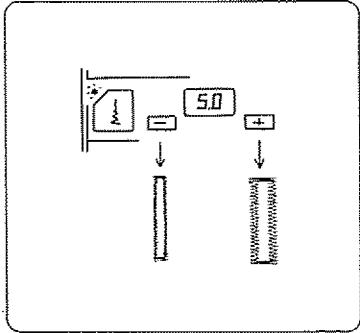

The stitch width button controls the stitch width. It is pre-set at "5.0"

Press "+" or "-" to adjust the stitch width of the entire buttonhole.

Stitch Density in Entire Buttonhole:

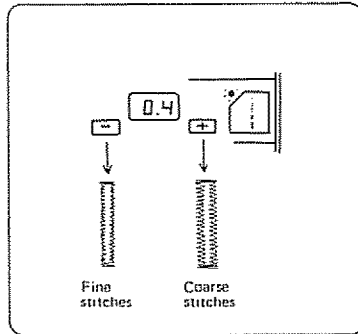

The stitch length button controls the stitch density. It is pre-set at "0.4"

Press "+" or "-" to adjust the stitch density of the entire buttonhole.

Manual Buttonholing

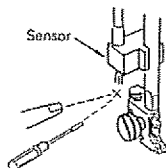
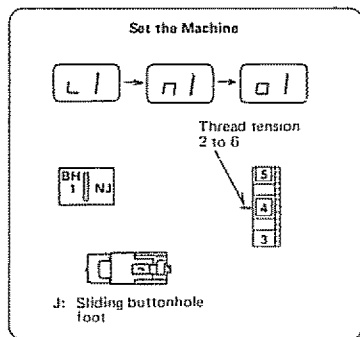

NOTE: Do not put finger, screw driver or any other object near under the sensor when sewing buttonholes by using sliding buttonhole foot J, otherwise the sewing procedure in the pattern indicator may advance to the next step.

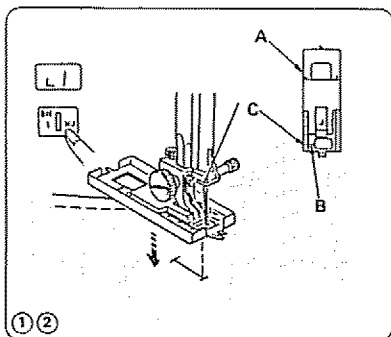

- ①
 - a. Carefully mark the buttonhole length on your garment.
 - b. Change to the sliding buttonhole foot.
 - c. Insert the garment under the foot with the buttonhole marking running toward you. Slide both threads to the left.
- ②
 - a. Move the slider (A) away from you so that the bottom mark (C) on the slider meets the start mark (B).
 - b. Line up the markings on the foot with the bottom mark on your garment.
 - c. Lower the presser foot and press BH 1 (bar-tack) button.

NOTE: The markings on the slider are engraved in centimeters.

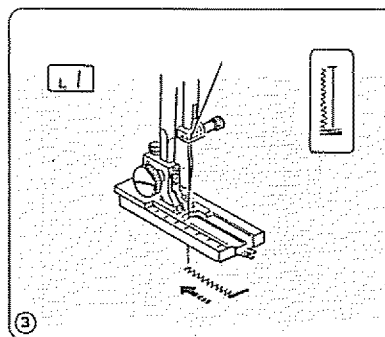

- ③ The machine will automatically bartack and sew up the left side of the buttonhole. Stop the machine at the top mark.

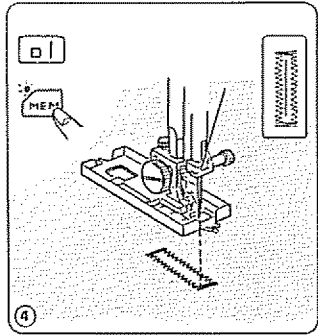

④ Press the memory button.

The machine will automatically bartack and sew down the right side.

Stop the machine when you are directly opposite the first stitch on the left hand side.

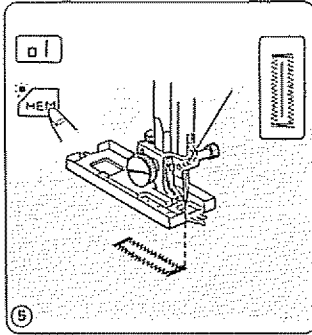

⑤ Press the memory button.

The machine will auto-lock the end of the buttonhole and stop. Keep the foot control depressed until the machine stops by itself.

• **Stitch Density on One Side:**

The stitches on each side of the buttonhole should be the same stitch density. To adjust, use the feed balance dial below the Hand Wheel.

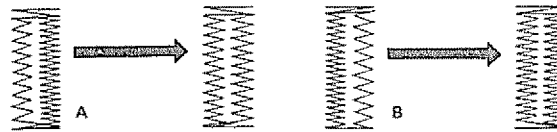
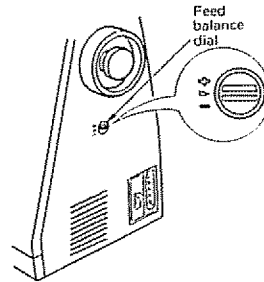

For Condition A:

Left Side Stitches too Far Apart (see above)

Turn the feed balance dial slightly toward "+". Use the large screw driver in your accessory box.

For Condition B:

Right Side Stitches too Far Apart (see above)

Turn the feed balance dial slightly toward "-".

After adjusting the feed balance dial, sew another test buttonhole to be sure your adjustment is correct.

NOTE: Remember to return the feed balance dial to the standard mark { > } when you have completed the buttonholes.

SECTION 5. LEARN THE STITCHES

Corded Buttonholes

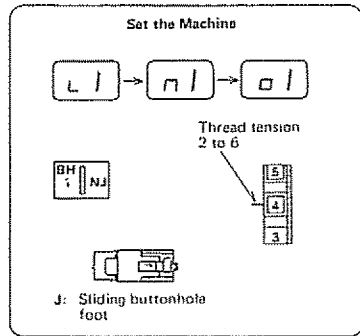

Use this procedure when you want to achieve a tailored, more attractive raised buttonhole.

Use filler cord (at least 15 inches of heavy thread).

Try a practice buttonhole first.

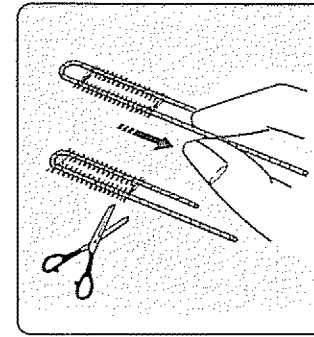
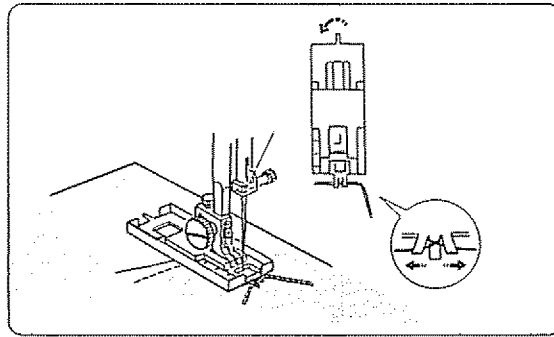

1. With the buttonhole foot raised, hook the filler cord on the cord spur at the back of the buttonhole foot.
2. Bring the ends toward you under the buttonhole foot until they clear the front end.
3. Hook the filler cord into the forks on the front of the J foot to hold them tight.
4. Lower the needle into the garment where the buttonhole will start and lower the foot.
5. Sew the buttonhole according to the buttonhole sewing instructions on p. [72](#) to [73](#). Each side of the buttonhole and the bartacks will be sewn over the cord.
6. Remove the fabric from the machine and cut the sewing threads.
7. Pull the right end of the filler cord to tighten it.
8. Thread the end through a darning needle, draw to the bottom side of the fabric and cut.

NOTE: To adjust stitch density, see p. [73](#).

Hemming and Edging Stitches 16, 21, 22, 28, 30 and 31

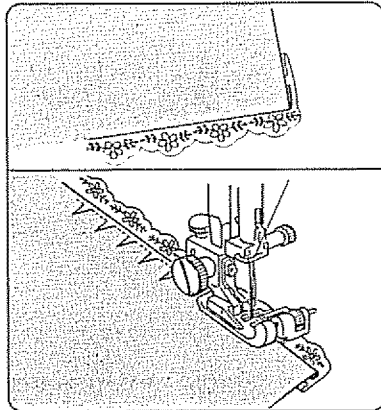
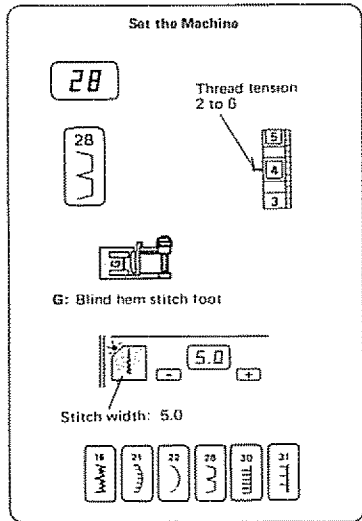

Hemming and Edging garments, tablecloths, napkins and craft items have often required careful hand sewing to produce a professional, finished look.

The Kenmore 100 Stitch can do these precision stitches much faster and more precisely than you ever dreamed possible.

| 16 | 21 | 22 | 28 | 30 | 31 |
|----|----|----|----|----|----|
| | | | | | |
| G | A | A | G | F | F |

The Stitches covered in this section are:

Blind Hem Stitch 16 (stretch) 28

Shell Stitch 28

Scallop Stitch 21 and 22

Cut-Out Work Edging 30 and 31

Applique 30 and 31

SECTION 5. LEARN THE STITCHES

Hemming and Edging Stitches 16, 21, 22, 28, 30 and 31 (Continued)

• Blind Hem Stitch (stretch) 16

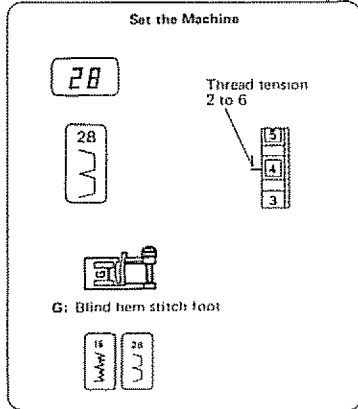

The Stitches and Their Uses

The stretch Blind Hem Stitch 16 is to be used for stretch fabrics because it is the stronger and more elastic of the blind hem stitches.

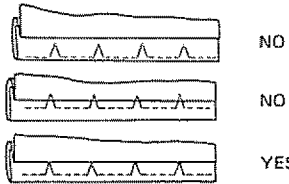

The regular blind hem stitch 28 is strong enough for woven fabrics.

• Blind Hem Stitch (woven) 28

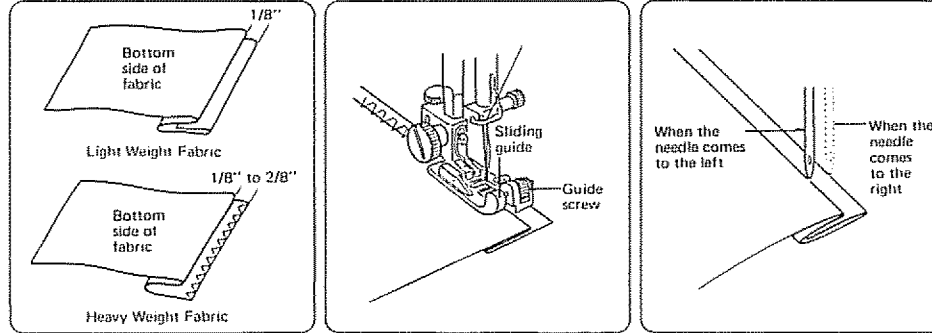

Here's How

1. Finish the raw edge of your hem any way you desire. (See Overcasting, p. 62)
2. Measure, turn up your hem and pin.

NOTE: For light weight fabrics, you may need a double fold.

3. Fold the material (Bottom side out) on the edge to be stitches, as shown, leaving 1/8" of the finished hem edge showing.
4. Turn the sliding guide screw so that the sliding guide is very close (1/16") to the left side of the blind hem foot.
5. Place the fold of the hem against the sliding guide so that the 1/8" extending edge shows on the right. The long zigzag stitch should barely pierce the folded edge of the fabric, but still sew on the 1/8" extended edge. See at left for proper stitch appearance.
6. After hemming, press both sides of the finished hem. The right side of the garment will show only the blind stitches.

Helpful Hint

Hemming Thin Fabrics:

Reduce pressure on the presser foot to avoid a distinct line.

• Shell Stitch 28

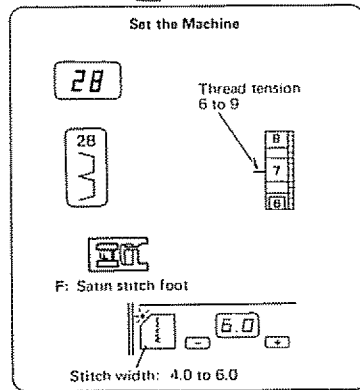
The Stitch and Its Uses

The Shell Stitch is formed by sewing a blind hem over folded fabric. Several rows of shell stitching are called shell tucks.

Shell stitching can be used to finish hems, sleeve and neck openings.

Shell tucking can be used to create scalloped tucks on blouses and lingerie.

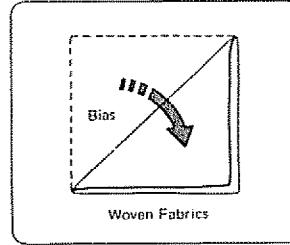
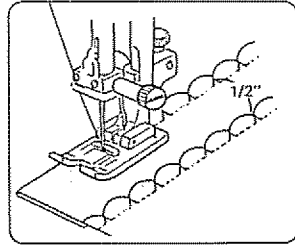
Here's How

1. For best effect
 - set the stitch width and length as you desire.
 - you may need to tighten the top thread slightly.
 - allow the needle to just clear the folded edge of the fabric when it zigzags.
2. If you sew rows of shell stitches, space the rows 1/2" apart.

You can sew Shell Stitch on knits or soft silky wovens in any direction.

SECTION 5. LEARN THE STITCHES

Hemming and Edging Stitches 16, 21, 22, 28, 30 and 31 (Continued)

• Scallop Stitch 21 and 22

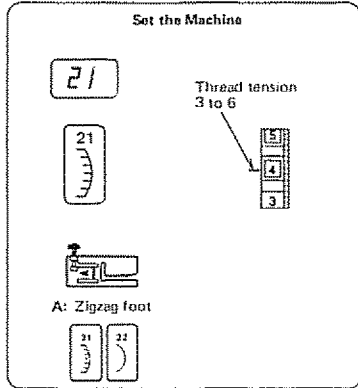

The Stitch and Its Uses

Use this attractive scallop stitch to create scallop edges or decorate your sewing projects, such as collars, pockets or placemats. You can create a delicate appearance on thin fabrics, such as chiffon, using a single layer of fabric with a tear-away backing for support while stitching.

You can also use this scallop stitch to sew decorative edgings on the hemlines of dresses or sleeves.

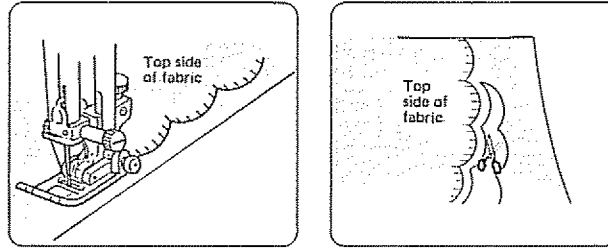

Here's How

1. Sew your scallops at least 3/8" from the folded edge.
2. After stitching, trim fabric close to the stitching. Be careful not to cut the thread.

Helpful Hints

For thin fabrics:

Use a single layer of fabric with a tear-away backing for support while stitching.

For hemlines and sleeves:

Use a tear-away backing, if necessary.

For collars, pockets or craft projects:

Place interfacing between the layers of fabric to provide stiffness.

• Cut-Out Work Edging and Applique **30** and **31**

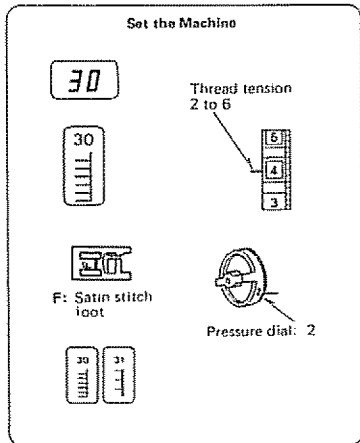

The Stitch and Its Uses

Cut-Out Work and Applique are the major uses for this stitch, but it can also be used to provide edging on many sewing projects, including placemats, blankets, collars, cuffs and pockets.

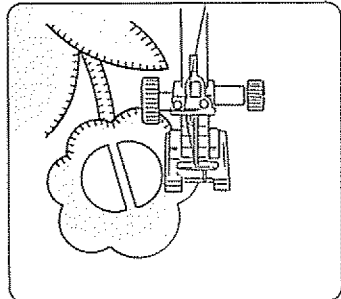

Here's How – For Applique

1. Use a fusible heavy weight interfacing behind each piece of your applique.
2. Cut the interfacing slightly smaller than the design pieces.
2. Tape or baste the applique in place and sew around each piece with stitch pattern **30** or **31**.

NOTE: You may also use a satin stitch.

4. When sewing curves, leave the needle in the fabric, raise the presser foot and turn the fabric.
5. Lower the presser foot and stitch.

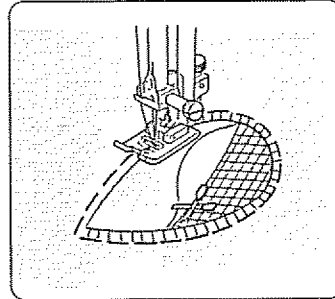

Here's How – For Cut-Out Work

1. Choose a simple design and trace the outline on the right side of the fabric.
2. Place a piece of tulle or organdy under the design and pin in place.

NOTE: You may want to use a contrasting insert fabric to accent your work.

3. Baste the layers together, stitching just outside the outline. Remove the pins.
4. Stitch around the design, using stitch pattern **30** or **31**.

NOTE: You may also use a narrow satin stitch (see p. **61**).

5. Remove basting and cut the fabric inside the design close to the stitching, using an embroidery scissors.

SECTION 5. LEARN THE STITCHES

Reinforcing Stitches **25**, **26**, **33** and **35**

• Feather Stitch **25**

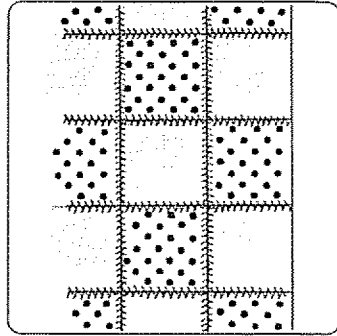
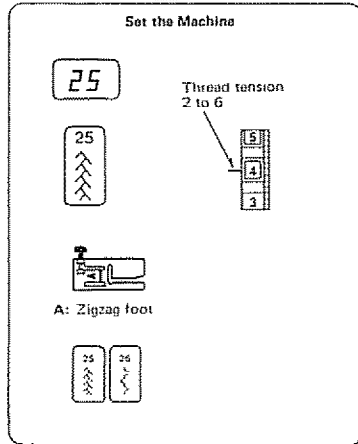

Here's How

1. Sew this pattern on a seam that is already joined and pressed flat.

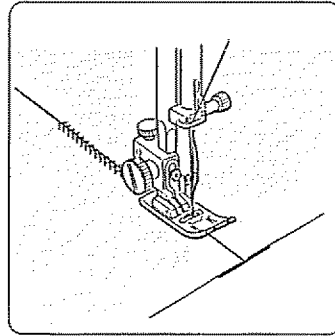

2. Butt two folded edges together and use this stitch to join them.

The Stitch and Its Uses

This stitch is strong, useful and decorative. It can reinforce stretch and woven fabrics. You can use it to sew spandex undergarments or decoratively hem elastic fabric. You may also use this stitch in patchwork quilting.

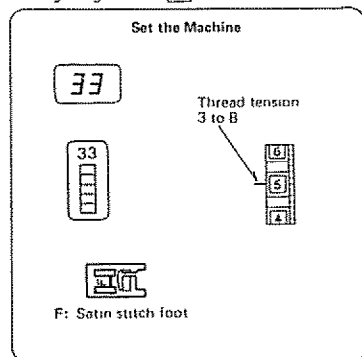
• Fagoting Stitch **33**The Stitch and Its Uses

Use this stitch to join two pieces of fabric to create an open work appearance and add design interest.

For other stitches that may be used in fagoting, see stitch patterns **25** and **26** (p. **80**).

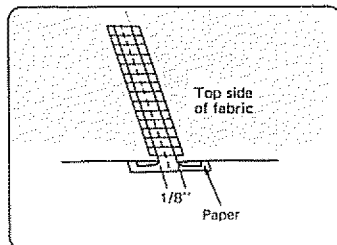
Here's How

1. Fold under each fabric edge 1/2" and press.
2. Pin the two edges to paper or tear-away backing 1/8" apart.
3. Sew slowly, guiding the fabric so the needle catches the folded edge on each side.

Helpful Hint

You may want to set the stitch width on "7.0" for maximum effect.

SECTION 5. LEARN THE STITCHES

Reinforcing Stitches 25, 26, 33 and 35 (Continued)

• Elastic Casing Stitch 33

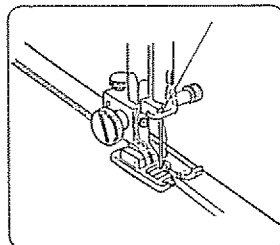
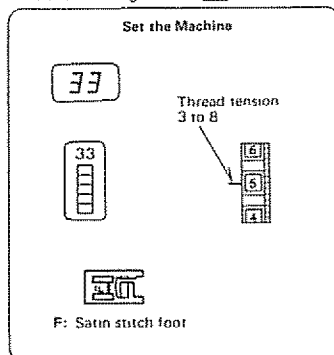

Here's How

1. Slide a piece of 1/8" elastic under the foot, then up through the slot in Foot F (satin stitch).
2. Sew the elastic on the bottom side of the fabric, pulling it gently to avoid sewing through the elastic.
3. Pull on the elastic to gather the fabric and bartack at both ends.

The Stitch and Its Uses

Use this stitch to replace bias tape casings in such areas as wrists and waists. In children's clothing, this stitch is especially helpful, because it reduces bulk.

• Elastic Stretch Stitch 35

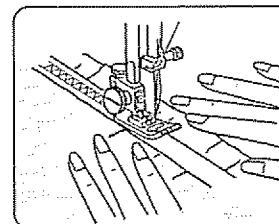
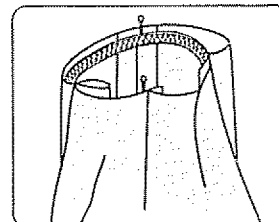
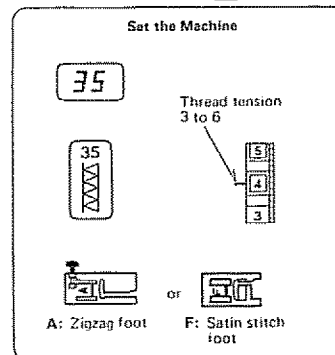

The Stitch and Its Uses

Choose this stitch to attach elastic to garments.

Here's How

1. Mark the elastic into quarters and match these to the center front, center back and side seams.
2. Place the middle of the elastic under the center of the presser foot and stitch into place, making sure the elastic is evenly distributed.

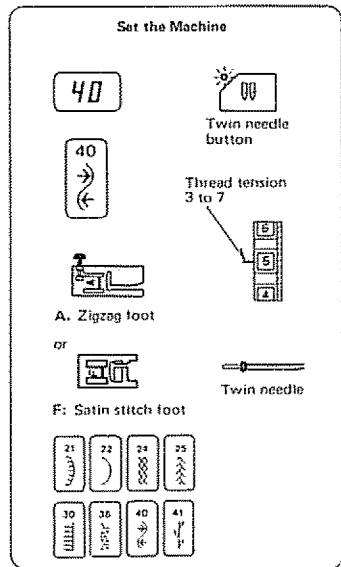
Twin Needle Stitching **21**, **22**, **24**, **25**, **30**, **36**, **40** and **41**

Your Kenmore 100 Stitch is equipped with a twin needle that can be used to sew parallel rows of straight or decorative stitches adding an exquisite touch to table linens and clothing.

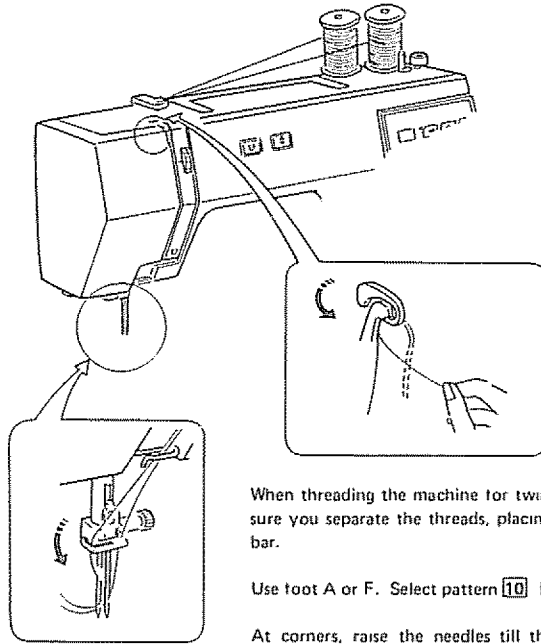

When threading the machine for twin needle sewing follow this chart making sure you separate the threads, placing one in each thread guide on the needle bar.

Use foot A or F. Select pattern **10** for parallel rows of straight stitching.

At corners, raise the needles till they clear the fabric. Partially raise the presser foot and carefully pivot the fabric.

To return to single needle sewing, press the Twin Needle Button or turn off the Power Switch.

SECTION 5. LEARN THE STITCHES

Decorate with Geometric Patterns 42 ~ 54

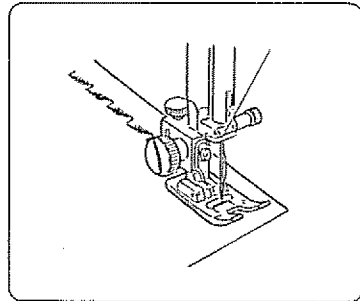
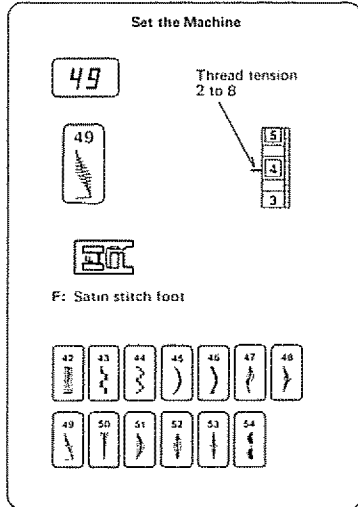

Here's How

1. Adjust the stitch width and length as you desire.
2. Practice the stitch on a scrap of fabric.
3. Mark the lines for decoration on the fabric, using a washable fabric marker.
4. Lower the needle at the starting point.
5. Lower the presser foot.
6. Lock the stitch at the beginning (press auto-lock).
7. Gently guide the fabric along the marked line.
8. Use the auto-lock to secure the row of stitches at the end.

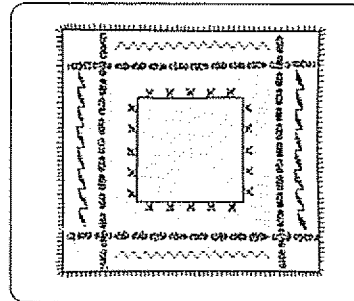

Helpful Hint

You may want to combine these geometric decorative stitches with other decorative stitches. See "Programming Decorative Stitch Patterns" (p. 90) for detailed instructions.

The Stitches and Their Uses

These stitches are purely decorative. You can sew one row or several or vary the stitch width and length for special effects. Experiment on a scrap of fabric to see what special effects are possible.

Decorate with Stretch Stitch Patterns 39 ~ 41 and 57 ~ 67

Set the Machine

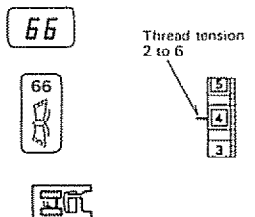

Thread tension
2 to 6

F: Satin stitch foot

| | | |
|----|----|----|
| 39 | 40 | 41 |
| 57 | 58 | 59 |
| 60 | 61 | |
| 62 | 63 | 64 |
| 65 | 66 | 67 |

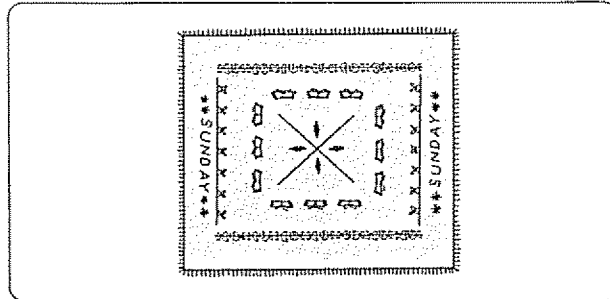

The Stitches and Their Uses

Decorative stretch patterns can be used for adding creative and personalized touch to the items you sew for your home and family.

Cross Stitch 34

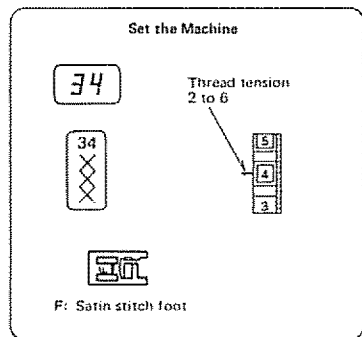
The Stitch and Its Uses

You can make beautiful designs with this embroidery stitch pattern, in half the time it would take if embroidered by hand. You can also combine cross stitches with the other decorative patterns and letters or numbers for attractive samplers and other sewing projects.

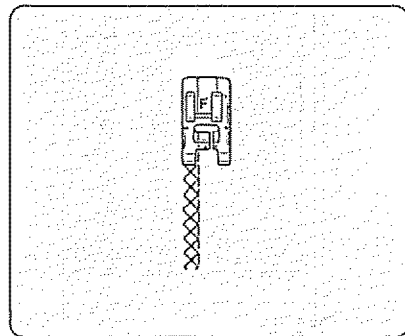
Here's How

1. Choose a plain close weave fabric such as linen or wool flannel for the background fabric.
2. If you choose light weight fabric, use a tear-away fabric backing for support.
3. Adjust the stitch width and length as you desire to match the pattern you have or plan.
4. Find the center of the design, or if the design is a border, choose a starting point.
5. Count the cross stitches from the center up and program the number.
(See p. 92, Pattern Single Units.)
Use Auto-Lock to begin and end.

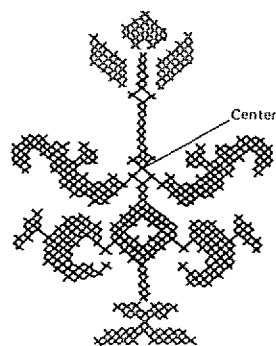
For Cross-Stitching Without a Pattern:

1. Start in the center of the design and sew the first row, letting the fabric feed naturally.
2. Then count the next row of stitches to the left or right.
3. Add or delete stitches by pressing the Clear button and reprogramming.
4. Begin each row by lowering the needle at the corner of a previous stitch.
5. Use the placement arrow "Δ" on Foot F to insure straight, even rows.

Smocking [23], [24], [36], [37] and [41]

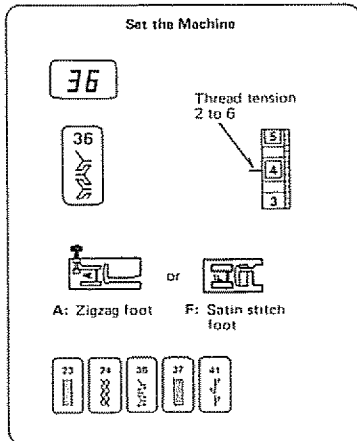
The Stitches and Their Uses

Smocking is a delicate decorative treatment for children's clothes or women's blouses.

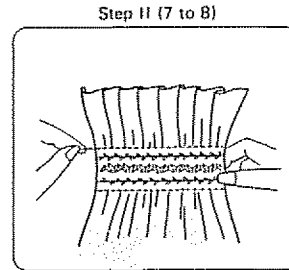
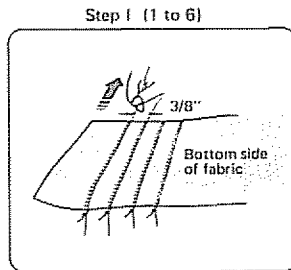
Here's How

1. Choose a soft, lightweight fabric such as batiste, gingham or challis.
2. Cut the fabric three times the finished width.
3. Set the stitch length control button at "4.5" and sew rows of straight gathering stitches 3/8" apart across the area to be smocked.

NOTE: Loosen the needle thread tension to make gathering easier.

4. Knot the threads along the edge.
5. Pull the bobbin threads and distribute the gathers evenly.
6. Secure the threads at the other end.
7. Sew the decorative stitches of your choice between the gathering stitches.
8. Pull out the gathering stitches.

Helpful Hint

These stitches can be used in combination with others for any decorative effect you desire.

Sand Stitch **38**

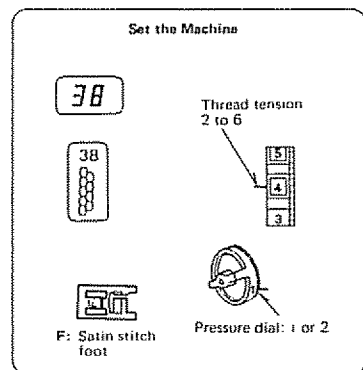

The Stitch and Its Uses

The sand stitch fills in outlined embroidery designs.

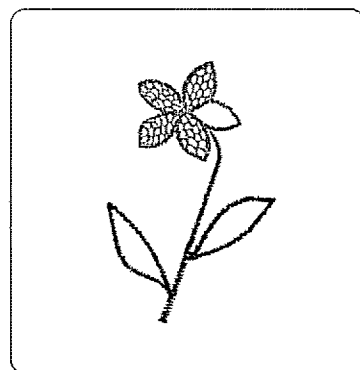

Here's How

1. Outline the pattern with a Satin Stitch **14**.
Set stitch width at "1.5".
Set stitch length at "0.3" or as you desire.
2. Fill in the design with the sand stitch.
3. Decrease the stitch width to fill in small spaces.
4. Sew in rows, starting at the edge, until the pattern is filled in.

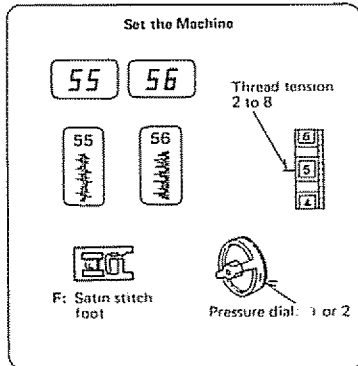
Shading Stitches **55** and **56**The Stitches and Their Uses

These stitches can be used to quickly and neatly outline designs. Use them to enhance appliques and create your own machine embroidered motifs.

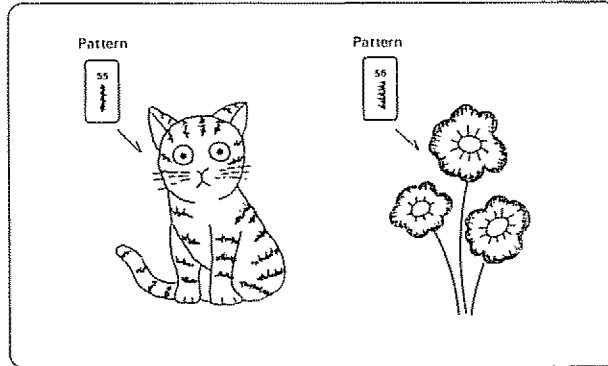
Here's How

Draw the design on the right side of the fabric. Place a tear away backing or iron-on interfacing beneath the fabric for support where necessary.

Use the automatic settings or manually adjust the stitch length and width to achieve a desired effect. Reduce the pressure to facilitate sewing curved areas and you may need to pivot on sharp curves.

A second row in the same or varied thread color can be sewn inside the first row for a more pronounced outline.

SECTION 5. LEARN THE STITCHES

Program Decorative Stitch Patterns **57** ~ **63** etc.

To program stitch pattern combinations, press the pattern selection buttons in the order shown.

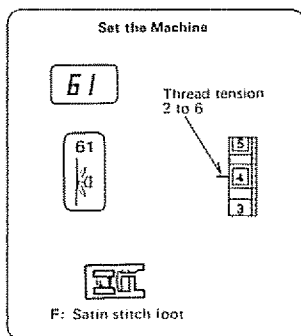

• One Cycle Stitching

1. Press the Auto-Lock.
2. Press Memory.
3. Press the stitch pattern.
4. Press Memory.
5. Press the Auto-Lock.
6. Press Memory.

See the Pattern Single Unit Chart.
You will sew one flower.

NOTE: The Auto-Lock stitch is already programmed into the buttonhole stitches and pattern numbers of 64 to 97, but not on any other stitches. You must press Auto-Lock to lock the decorative stitches.

• Two Cycle Stitching

To sew two of any stitch pattern, press the memory button twice after selecting the stitch pattern numbers.

NOTE: Continue to press the foot control until the machine stops automatically.

Combine Stitch Patterns

1. Press the Auto-Lock.
2. Press Memory.
3. Press the stitch pattern.
4. Press Memory.
5. Press the next stitch pattern.
6. Press Memory.
7. Press the stitch pattern.
8. Press Memory.
9. Press the stitch pattern.
10. Press Memory.
11. Press the Auto-Lock.
12. Press Memory.

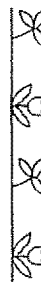

To repeat the same combination of stitches, just press the foot control again after stitching the first combination.

NOTE: To delete errors made while programming a series of patterns, press the Clear Button (see p. 29) and continue the programming.

• Cycle Stitching by Pressing Mirror Image Button

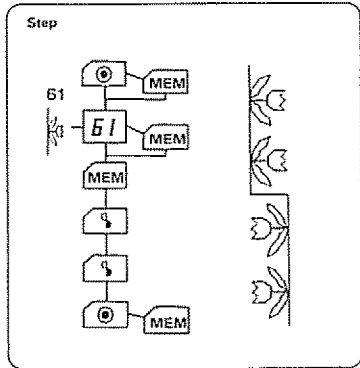

• Test Sewing Pattern Combinations

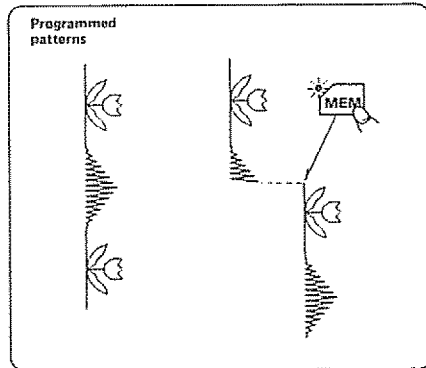

To Start Sewing at the Beginning of Your Pattern Combination:

There may be instances when you want to test a pattern without sewing all the patterns.

Sew as much as necessary then press the Memory button.

The machine will now start sewing at the beginning of your pattern combination.

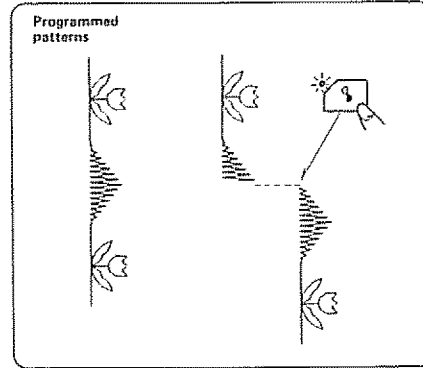

To Start Sewing at the Beginning of the Pattern You Have Been Sewing:

If you run out of thread in the middle of a pattern, press the Mirror Image Button.

Remove the stitching of the last pattern only.

Lower the needle at the end of the last completed pattern.

The machine will start sewing at the beginning of the pattern you have been sewing when you have run out of thread and continue sewing the remaining patterns.

SECTION 5. LEARN THE STITCHES

Program Decorative Stitch Patterns 57 ~ 63 etc. (Continued)

- Pattern Single Units
(Aid to Programming)

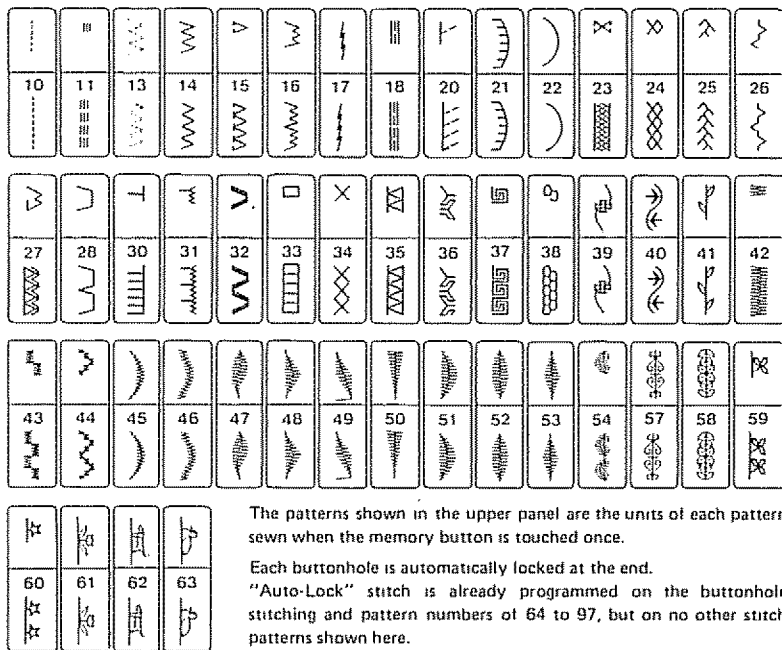

The patterns shown in the upper panel are the units of each pattern sewn when the memory button is touched once.

Each buttonhole is automatically locked at the end.

"Auto-Lock" stitch is already programmed on the buttonhole stitching and pattern numbers of 64 to 97, but on no other stitch patterns shown here.

Monogramming 00 ~ 09, 68 ~ 98

Your machine will sew the 26 letters of the alphabet, the period and leave a space, plus the numbers from 0 to 9. You can program entire words and sentences.

Each number and letter is automatically locked at the beginning and end so you can clip connecting threads.

Letters and numbers can be sewn two-thirds their regular size by pressing mirror image button instead of memory button when programming.

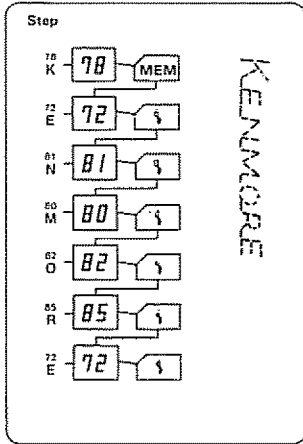
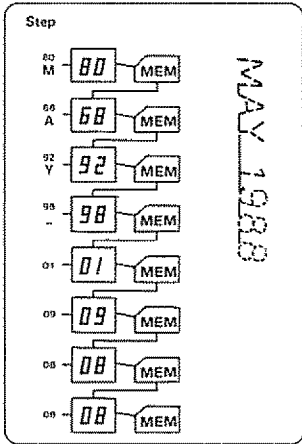

| | | | | | | | | | | |
|----|----|----|----|----|----|----|----|----|----|----|
| 00 | 01 | 02 | 03 | 04 | 05 | 06 | 07 | 08 | 09 | |
| 0 | 1 | 2 | 3 | 4 | 5 | 6 | 7 | 8 | 9 | |
| 68 | 69 | 70 | 71 | 72 | 73 | 74 | 75 | 76 | 77 | 78 |
| A | B | C | D | E | F | G | H | I | J | K |
| 79 | 80 | 81 | 82 | 83 | 84 | 85 | 86 | 87 | 88 | 89 |
| L | M | N | O | P | Q | R | S | T | U | V |
| 90 | 91 | 92 | 93 | 94 | 95 | 96 | 97 | 98 | | |
| W | X | Y | Z | . | ? | ! | - | | | |

The chart above shows where to clip the connecting threads and where each pattern starts, marked by "o"

You can program words and sentences in the same way as you program other stitch patterns. Press the memory button after each stitch pattern selection up to 31 selections. See example.

Adjusting Patterns

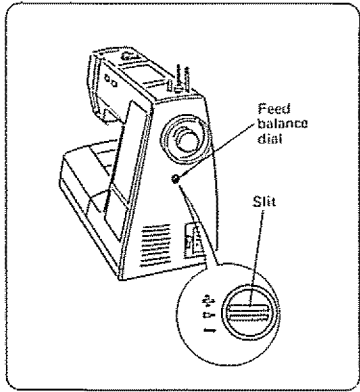

If decorative stitch patterns, letters or numbers are uneven when you sew on a particular fabric, adjust them with the feed balance dial.

• To Adjust Distorted Patterns

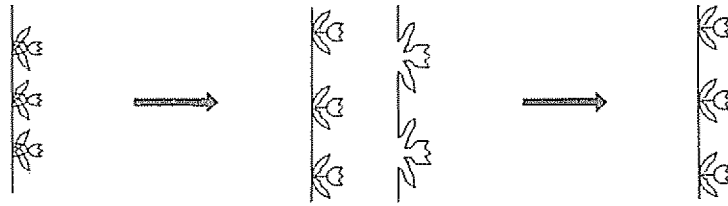

Compressed Patterns:

Correct by turning the feed balance dial toward the "+" Use the large screw driver in your accessory box.

Drawn Out Pattern:

Correct by turning the feed balance dial toward the "-"

• To Adjust Distorted Letters or Numbers

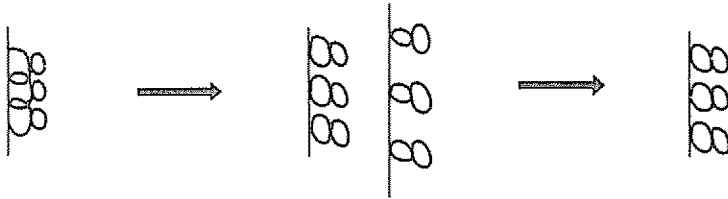

Compressed Letters or Numbers:

Correct by turning the feed balance dial toward the "+"

Drawn Out Letters or Numbers:

Correct by turning the feed balance dial toward the "-"

SECTION 6. PERFORMANCE PROBLEMS CHART

What to Do When

| PROBLEM | PROBABLE CAUSE | CORRECTION |
|---|--|---|
| The machine does not work. | A single digit number was programmed. A number without pattern was selected. | Two digit number must be programmed. A number in the stitch package chart must be selected. |
| The machine does not work and the Pattern Indicator reads "Er" | The area of feed dogs is filled with dust and lint. | Clean the area of the feed dogs. |
| Irregular Stitches | Incorrect size needle. Improper threading. Loose upper thread tension. Pulling fabric. Light pressure on presser foot. Loose presser foot. Unevenly wound bobbin. Nicks or burrs at hole of needle plate. | Choose correct size needle for thread and fabric. Rethread machine. Tighten upper thread tension. Do not pull fabric; guide it gently. Increase pressure on presser foot. Reset presser foot. Rewind bobbin. Replace needle plate, or polish off burrs completely. |
| Breaking Needle | Pulling fabric. Incorrect size needle. Incorrect setting of needle. Loose presser foot. | Do not pull fabric; guide it gently. Choose correct size needle for thread and fabric. Reset needle. Reset presser foot. |
| Bunching of Thread | Upper and lower threads not drawn back under presser foot before starting seam. | When starting a seam be sure to draw both threads under and back of presser foot about 4" and hold until a few stitches are formed. |
| Puckering | Incorrect thread tension(s). Light pressure on presser foot. Using two different sizes or kinds of thread. Bent or blunt needle. Loose presser foot. Fabric too sheer or too soft. | Reset thread tension(s). Increase pressure on presser foot. Upper thread and bobbin thread should be same size and kind. Insert new needle. Reset presser foot. Use underlay of tissue paper. |
| Monograms and buttonholes are not identical during memory sewing. | Fabric feed is restricted in some way. | Check threads for tangles. Check feed dogs and clean, if necessary. Be sure fabric does not pile up behind the presser foot. See pages 69 to 74 for buttonholing instructions. |

SECTION 6. PERFORMANCE PROBLEMS CHART

What to Do When (Continued)

| PROBLEM | PROBABLE CAUSE | CORRECTION |
|--|---|--|
| Monograms and buttonholes not identical. | Machine was not allowed to complete the last few stitches. | Hold down the foot control until the machine has stopped. |
| Skipping Stitches | Incorrect size needle. Bent or blunt needle. Incorrect setting of needle. Tight upper thread tension. Light pressure on presser foot. | Choose correct size needle for thread and fabric. Insert new needle. Reset needle. Loosen upper thread tension. Increase pressure on presser foot. |
| Breaking Upper Thread | Starting to stitch too fast. Improper threading. Tight upper thread tension. Incorrect size needle. Sharp eye in needle. Nicks or burrs at hole of needle plate. | Start to stitch at a medium speed. Rethread machine. Loosen upper thread tension. Choose correct size needle for thread and fabric. Insert new needle. Replace needle plate, or polish off burrs completely. |
| Breaking Bobbin Thread | Improper bobbin holder threading. Lint in bobbin holder or hook race. | Check bobbin holder threading. Clean bobbin holder and hook race. |
| Fabric not Moving | Darning plate in place. Light pressure on presser foot. Thread knotted under fabric. Push-pull clutch is disengaged. | Remove darning plate. Increase pressure on presser foot. Place both threads back under presser foot before beginning to stitch. Push in the clutch. |
| Machine Jamming Knocking Noise | Thread caught in hook race. Lint in bobbin holder or hook race. | Disassemble and clean hook race. Clean bobbin holder and hook race. |
| Buttonholes are not identical in length and shape. | Fabric is pulling and distorting the automatic fabric feed. | <ol style="list-style-type: none"> 1. Keep the fabric from falling off the edges of the sewing surface. 2. Bunch the fabric slightly all around the needle. |
| | Fabric is too thick near the seam and the buttonholes. | <ol style="list-style-type: none"> 1. Use the J Foot in these instances. 2. Start the buttonhole so that you sew <u>toward</u> the edge of the fabric. 3. Put standard writing paper (not tissue paper) under the garment to aid fabric feed (for woven and stretch fabrics). 4. Do not use the Automatic Buttonhole function. Sew each button individually. |

Clean the Bobbin Holder

To insure that your machine operates at its best, you need to keep the essential parts clean at all times.

The bobbin area can attract dust and lint. Your machine can become sluggish or knock loudly if a thread is caught.

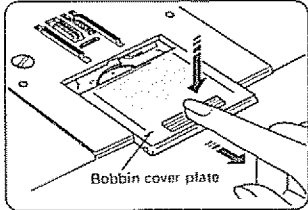

Follow these directions:

1. Turn off the power or unplug the machine.
2. Remove the bobbin cover plate by firmly pulling it toward you.
3. Remove the bobbin.

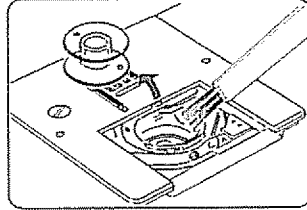

4. Brush or vacuum the dust and lint out of the bobbin holder.
5. Replace the bobbin.

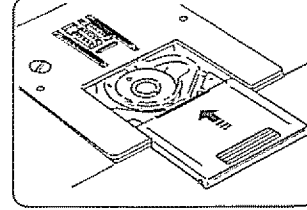

6. Slide on the bobbin cover plate by pushing it into the grooves.

SECTION 7. CARE FOR YOUR MACHINE

Clean the Hook Race and Feed Dogs

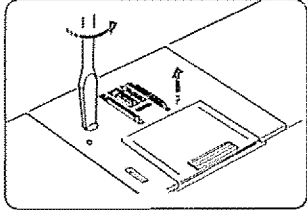

1. Unplug the machine and remove the presser foot and needle.
2. Remove the bobbin cover plate.
3. Remove the screw on the left side of the needle plate with the large screw driver from your accessory box.
4. Remove the needle plate.

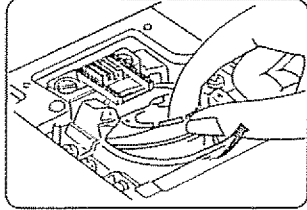

5. Take out the bobbin. Lift up the bobbin holder and remove it.

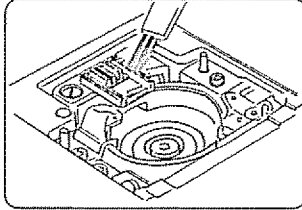

6. Use the lint brush in the accessory box to clean the feed dogs, hook race and bobbin holder. Also use a soft, dry cloth.

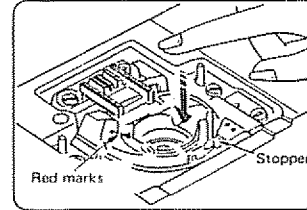

7. Line up the red marks and place the bobbin holder so the knob fits next to the stopper in the hook race, as shown above.

Oiling the Machine

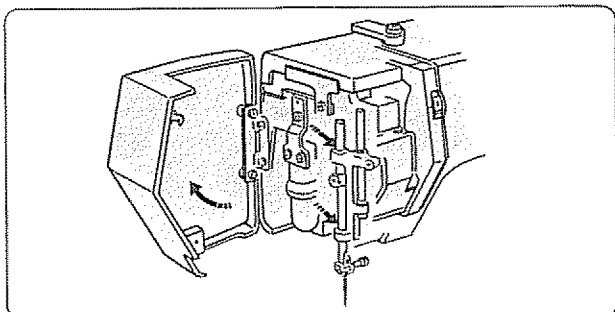

Open face cover plate and oil points as shown below at least once a year. One or two drops of oil is sufficient.

Remove excess oil; otherwise it may stain fabrics.

In case machine is not used for an extended time, oil it before sewing. Use Kenmore sewing machine oil.

No other oiling is required

Replace the Light Bulb

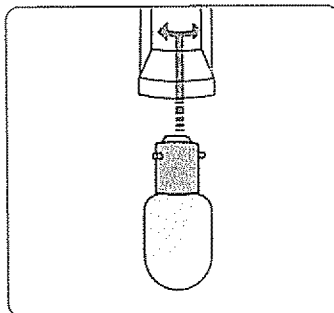

1. Unplug the machine and open the face cover.

CAUTION! The light bulb will be HOT. Protect your fingers when you handle it.

2. Push the bulb up and turn the bulb counter-clockwise to remove it.
3. Put the new bulb in by turning clockwise and pushing up.

PARTS LIST

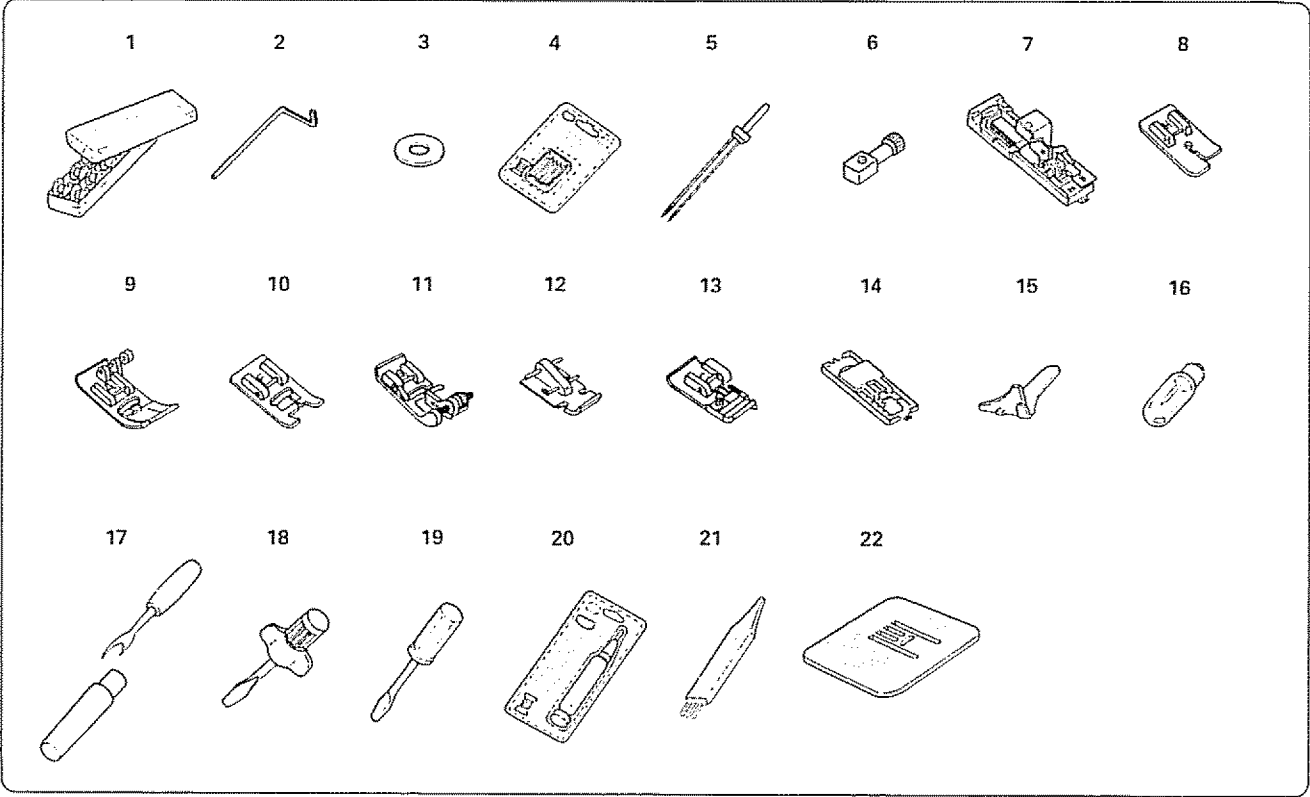

All parts listed herein may be ordered from any Sears store or service center.

WHEN ORDERING REPAIR PARTS, ALWAYS GIVE THE FOLLOWING INFORMATION:

1. PART NUMBER
2. PART DESCRIPTION
3. MODEL NUMBER
4. NAME OF ITEM

If the parts you need are not stocked locally, your order will be electronically transmitted to a Sears Repair Parts Distribution Center for expedited handling.

| Ref. No. | Part No. | Description |
|----------|-----------|-------------------------------------|
| 1 | *20-6868 | Bobbin box with 10 bobbins |
| 2 | 802422002 | Quilter |
| 3 | 102403202 | Spool pin felt |
| 4 | 813404013 | No. 11 Stretch fabric needles (BLU) |
| | 6551 | No. 11 Single needles (ORG) |
| | 6552 | No. 14 Single needles (RED) |
| | 6553 | No. 16 Single needles (PUR) |
| | 6554 | No. 18 Single needles (GRN) |
| 5 | 826815000 | Twin needle |
| 6 | 826501000 | Needle clamp with screw |
| 7 | 826801003 | Automatic buttonhole foot |
| 8 | 823801004 | Straight stitch foot |
| 9 | 822508005 | Zigzag foot |
| 10 | 822804118 | Satin stitch foot |
| 11 | 820817015 | Blind hem stitch foot |
| 12 | 823803006 | Zipper foot |
| 13 | 822801001 | Overedge foot |
| 14 | 826811006 | Sliding buttonhole foot |
| 15 | *6864 | Needle threader |
| 16 | 6797 | Light bulb |
| 17 | 6830 | Buttonhole opener |
| 18 | 820832005 | Large screw driver |
| 19 | 41669 | Small screw driver |
| 20 | *6889 | Oil and lint brush |
| 21 | 802424004 | Lint brush |
| 22 | 652804001 | Darning plate |

* These items are not furnished with the machine, but may be ordered per instructions above.

INDEX

- A**
- Accessories 6
 - Accessory storage box 5, 10
 - Alphabet & numbers 93
 - Appliqueing 46, 79
 - Arm cover plate 6
 - "Auto-Lock" pattern 25, 30
 - Automatic buttonholing 69~71
 - Automatic buttonhole foot 12, 14, 49, 69~70, 100~101
 - Automatic darning 46, 67~68
- B**
- Base 5
 - Basting 36, 44
 - Blind hemming 44, 46, 76
 - Blind hem stitch foot 12, 14, 44, 46, 100~101
 - Bobbin 6, 18~20, 97, 100~101
 - Bobbin cover plate 5, 18, 97
 - Bobbin thread 22~23
 - Bobbin winding 18~19
 - Bobbin winding spindle 5, 19
 - Buttonhole 49, 69~74
 - Buttonhole foot, automatic 12, 14, 49, 100~101
 - Buttonhole foot, sliding 12, 14, 46, 49, 100~101
 - Buttonhole opener 6, 100~101
 - Buttonholing buttons 25
 - Button sewing 38
- C**
- Carrying handle 6
 - Cleaning bobbin holder 97
 - Cleaning hook race and feed dogs 98
 - Clear button 25, 29
 - Corded buttonhole 74
 - Cornering guide 34
 - Control panel 27
 - Cross stitching 47, 86
- Cut-out work 46, 79**
- D**
- Darning 37
 - Darning plate 6, 35~38, 100~101
 - Decorative stitching 48, 84~85
 - Direct entry stitch button 29
 - Distorted pattern 94
 - Double edge zigzag stitching 45, 65
- E**
- Editing button 25, 31
 - Editing pattern combinations 31
 - Elastic casings 47, 82
 - Elastic stretch stitching 47, 82
 - Extension table 5, 10
- F**
- Fabric, needle, thread and stitch length chart 17
 - Face cover plate 5
 - Fagoting 47, 81
 - Feather stitching 45, 80
 - Feed balance dial 6, 8, 68, 73
 - Foot control 6, 8
 - Foot holder 15
 - Foot storage compartment 12
 - Free arm sewing 10, 11
- G**
- Gathering 55
- H**
- Hand wheel 6
 - Hemming and edging stitching 75~79
- K**
- Knit stitching 45, 65
- L**
- Large screw driver 6, 100~101
 - LED light 25
 - Light and power switch 6
 - Light bulb 99~101
 - Lint brush 6, 97~98, 100~101
 - Lock-a-Matic seam 43, 57
- M**
- Machine plug 7
 - Machine socket 7
 - Manual buttonholing 72~73
 - Memory button 25, 29
 - Mending 43, 63
 - Mirror image button 25, 30
 - Monogramming 49, 93
- N**
- Needle 16~17, 100~101
 - Needle clamp 5, 17, 100~101
 - Needle plate 5, 34, 100~101
 - Needle position 52
 - Needle set 6, 100~101
 - Needle, thread and fabric chart 17
 - Needle threader 100~101
- O**
- Oiling 99
 - Outline stretch stitching 44, 58
 - Overcasting stitching 62
 - Overedge foot 12, 13, 43~44, 100~101
 - Overedge seam 44, 64

| | |
|--------------------------|---------------|
| P | |
| Parts list | 100~101 |
| Pattern indicator | 25, 28~29, 31 |
| Pattern memory | 29~30 |
| Pattern reduction | 93 |
| Pattern selection | 27~31 |
| Pattern selection button | 5, 25, 28 |
| Performance problems | 95~96 |
| Pintucking | 43, 53 |
| Plug connector | 6 |
| Portable case | 4 |
| Power supply | 7 |
| Power supply plug | 7 |
| Power switch | 7, 28 |
| Presser bar | 15 |
| Presser foot | 5, 12~14 |
| Presser foot lever | 6, 9 |
| Pressure control dial | 8 |
| Program sewing | 90~93 |
| Push-pull clutch | 6, 18 |

| | |
|----------|---------------------|
| Q | |
| Quilter | 12, 13, 43, 100~101 |
| Quilting | 43, 54 |

| | |
|-----------------------------|----------|
| R | |
| Reinforcing stitching | 80~82 |
| Replacing light bulb | 99 |
| Reverse stitch button | 5, 25~26 |
| Rick-Rack stretch stitching | 47, 66 |

| | |
|-------------------|-----------------------|
| S | |
| Saddle stitching | 44, 59 |
| Sand stitching | 48, 88 |
| Satin stitch foot | 12~13, 45~49, 100~101 |
| Satin stitching | 61 |

| | |
|-------------------------------------|---------------------------------------|
| Scalloped stitching | 45, 78 |
| Seam guides | 34 |
| Sewing function chart | 42 |
| Sewing light | 7 |
| Sewing on heavy fabrics | 35 |
| Shading stitching | 48, 89 |
| Shell stitching | 46, 77 |
| Sliding buttonhole foot | 12, 14, 46, 49, 100~101 |
| Small screw driver | 6, 100~101 |
| Smocking stretch stitching | 47, 87 |
| Spool pins | 5, 9 |
| Spool pin felt | 6, 9, 100~101 |
| Stitch length adjustment | 33 |
| Stitch length/width indicator | 25 |
| Stitch length/width control buttons | 5, 25, 32~33 |
| Stitch length/width decrease button | 25 |
| Stitch length/width increase button | 25 |
| Stitch pattern chart | 5, 27, 43~49 |
| Stitch width adjustment | 32 |
| Straight stitch foot | 12, 14, 43, 100~101 |
| Straight stitching | 43, 50~55 |
| Straight stretch stitching | 43, 56 |
| Stretch stitching | 43~48, 56, 58~59, 64~66, 78~83, 87~88 |

| | |
|-------------------------|--------------------|
| T | |
| Take-up lever | 5, 21 |
| Thread cutter | 5, 9 |
| Thread guide | 5, 19, 21, 83 |
| Thread tensions | 23~24 |
| Thread tension dial | 5, 23 |
| Threading chart | 20 |
| Top stitching | 43, 51~52 |
| Top thread | 21, 23~24 |
| Turning a square corner | 34 |
| Twin needle | 6, 16, 83, 100~101 |
| Twin needle button | 25, 30, 83 |
| Twin needle sewing | 45, 83 |

| | |
|--------------------------------|----------------------|
| U | |
| Up/down needle position button | 5, 15, 17, 22, 25~26 |

| | |
|--------------------|---------------------------|
| Z | |
| Zigzag foot | 12~13, 43~45, 47, 100~101 |
| Zigzag stitching | 24, 38, 43, 60~62 |
| Zigzag overcasting | 62 |
| Zipper application | 39~41 |
| Zipper foot | 12~13, 39~41, 100~101 |

WARRANTY

FULL 25-YEAR WARRANTY ON SEWING MACHINE HEAD

For 25 years from the date of purchase, Sears will, free of charge, repair defects in material or workmanship which appear in the mechanical components of the sewing machine head.

FULL TWO YEAR WARRANTY ON ELECTRICAL EQUIPMENT OF SEWING MACHINE

For two years from the date of purchase, Sears will, free of charge, repair defects in material or workmanship which appear in the electrical equipment of the sewing machine, including electronic components, motor, wiring, switch and speed control.

FULL 90-DAY WARRANTY ON ALL PARTS AND MECHANICAL ADJUSTMENTS

For 90 days from the date of purchase, Sears will, free of charge, replace any parts and provide mechanical service necessary for proper operation of the sewing machine, except for normal maintenance.

WARRANTY SERVICE IS AVAILABLE BY RETURNING THE SEWING MACHINE TO THE NEAREST SEARS SERVICE CENTER/DEPARTMENT IN THE UNITED STATES.

This warranty gives you specific legal rights, and you may also have other rights which vary from state to state.

SEARS, ROEBUCK AND CO., D/817 WA, Hoffman Estates, IL 60179

SEWING MACHINE

Now that you have purchased your Kenmore Sewing Machine, should a need ever exist for repair parts or service, simply contact your nearest Sears Service Center. Be sure to provide all pertinent facts when you call or visit.

The model number of your Sewing Machine will be shown on your nomenclature plate on the back of your Sewing Machine. See page 3 for location.

WHEN ORDERING REPAIR PARTS, ALWAYS GIVE THE FOLLOWING INFORMATION:

*MODEL NUMBER *NAME OF ITEM *PART DESCRIPTION

If the parts you need are not stocked locally, your order will be electronically transmitted to a Sears Repair Parts Distribution Center for handling.

SEARS, ROEBUCK AND CO., Chicago, IL60684 U.S.A.

Free Manuals Download Website

<http://myh66.com>

<http://usermanuals.us>

<http://www.somanuals.com>

<http://www.4manuals.cc>

<http://www.manual-lib.com>

<http://www.404manual.com>

<http://www.luxmanual.com>

<http://aubethermostatmanual.com>

Golf course search by state

<http://golfingnear.com>

Email search by domain

<http://emailbydomain.com>

Auto manuals search

<http://auto.somanuals.com>

TV manuals search

<http://tv.somanuals.com>