

# SEGA®



A Game of Skill  
**Owner's Manual**



SEGA AMUSEMENTS USA, INC.  
**MANUAL NO. 999-2035**  
GAME CODE: GSM

# VISIT OUR WEBSITE!

The screenshot shows a web browser window with the address bar displaying "http://www.seuservice.com/". The browser's address bar also shows "SAUService.com" and a search box with "Google". The website header includes the "SEGA SERVICE" logo, contact information for "Sega Amusements USA Inc." (45133 Industrial Dr., Fremont, CA 94538, (415) 701-6580), and a "Google" search box for "Search SEUService.com". A navigation menu contains links for Home, Whats New, Manuals, Bulletins, Assemblies, Graphics, Search, Bulletin Sign-Up, Staff, Warranty Policy, Return Policy, and Corporate Info. The main content area features the text "Help is on the way!!" with two cartoon characters: a thief and a police officer. To the right is a large "SEGA SERVICE" logo with a list of services: Bulletins, Game Manuals, Search, and What's New. At the bottom, there is a text prompt: "If you have any questions or comments about this site please E-Mail to [Dave.Cantrelle@seu.sega.com](mailto:Dave.Cantrelle@seu.sega.com)" and a "POWERED BY Mac OS X" logo.

## BEFORE USING THE PRODUCT, BE SURE TO READ THE FOLLOWING:

To maintain the safety:

To ensure the safe usage of the product, be sure to read the following before using the product. The following instructions are intended for the users, operators and the personnel in charge of the operation of the product. After carefully reading and sufficiently understanding the warning displays and cautions, handle the product appropriately. Be sure to keep this manual nearby the product or elsewhere convenient for referring to it when necessary.

Herein, explanations which require special attention are enclosed with dual lines. Depending on the potentially hazardous degrees, the terms of WARNING, CAUTION, etc. are used. Be sure to understand the contents of the displays before reading the text.



Indicates that mishandling the product by disregarding this warning will cause a potentially hazardous situation which can result in death or serious injury.



Indicates that mishandling the product by disregarding this caution will cause a slight hazardous situation which can result in personal injury and or material damage.

### For the safe usage of the product, the following pictographs are used:



Indicates “HANDLE WITH CARE.” In order to protect the human body an equipment, this display is attached to places where the Owner’s Manual and or Service Manual should be referred to.

- **Perform work in accordance with the instructions herein stated.**  
Instructions for work are explained by paying attention to the aspect of accident prevention. Failing to perform work as per the instructions can cause accidents. In the case where only those who have technical expertise should perform the work to avoid hazardous situation, the instructions herein state that the serviceman should perform such work.
- **Be sure to turn off power before working on the machine.**  
To prevent electric shock, be sure to turn off power before starting the work in which the worker touches the interior of the product. If the work is to be performed in the power-on status, the Instruction Manual herein always states to that effect.
- **Be sure to ground the Earth Terminal** (this, however, is not required in the case where a power cord with earth is used).  
This product is equipped with the Earth Terminal. When installing the product, Connect the Earth Terminal to the “accurately grounded indoor earth terminal” by using an earth wire. Unless the product is grounded appropriately, the user can be subject to electric shock. After performing repair, etc. for the Control equipment, ensure that the Earth Wire is firmly connected to the Control equipment.
- **Ensure that the Power Supply used is equipped with an Earth Leakage Breaker.**  
This product does not incorporate the Earth Leakage Breaker. Using a power supply which is not equipped with the Earth Leakage Breaker can cause a fire when earth leakage occurs.
- **Be sure to use fuses which meet the specified rating.** (only for the machines which use fuses).  
Using fuses exceeding the specified rating can cause a fire and electric shock.

- **Specification changes (removal of equipment, conversion and addition) not designated by SEGA are not allowed.**  
The parts of the product include warning labels for safety, covers for personal protection, etc. It is very hazardous to operate the product by removing parts and or modifying the circuits. Should doors, lids and protective parts be damaged or lost, refrain from operating the product, and contact where the product was purchased from or the office herein stated. SEGA shall not be held responsible for any accidents, compensation for damage to a third party, resulting from the specifications not designated by SEGA.
  - **Ensure that the product meets the requirements of appropriate Electrical Specifications.**  
Before installing the product, check for Electrical Specifications. SEGA products have a nameplate on which Electrical Specifications are described. Ensure that the product is compatible with the power supply voltage and frequency requirements of the location. Using any Electrical Specifications different from the designated Specifications can cause a fire and electric shock.
  - **Install and operate the product in places where appropriate lighting is available, allowing warning labels to be clearly read.**  
To ensure safety for the customers, labels and printed instructions describing potentially hazardous situation are applied to places where accidents can be caused. Ensure that where the product is operated has sufficient lighting allowing the warnings to be read. If any label is peeled off, apply it again immediately. Please place an order with where the product was purchased from or the office herein stated.
  - **When handling the Monitor, be very careful. (Applies only to the product w/monitor.)**  
Some of the monitor (TV) parts are subject to high tension voltage. Even after running off power, some portions are still subject to high tension voltage sometimes. Monitor repair and replacement should be performed only by those technical personnel who have knowledge of electricity and technical expertise.
  - **Be sure to adjust the monitor (projector) properly. (Applies only to the product w/monitor.)**  
Do not operate the product leaving on-screen flickering or blurring as it is. Using the product with the monitor not properly adjusted may cause dizziness or a headache to an operator, a player, or the customers.
  - **When transporting or reselling this product, be sure to attach this manual to the product.**  
In the case where commercially available monitors and printers are used in this product, only the contents relating to this product are explained herein. Some commercially available equipment has functions and reactions not stated in this manual. Read this manual together with the specific Instruction Manual of such equipment.
- Descriptions herein contained may be subject to improvement changes without notice.
  - The contents described herein are fully prepared with due care. However, should any question arise or errors be found, please contact SEGA.

#### **INSPECTIONS IMMEDIATELY AFTER TRANSPORTING THE PRODUCT TO THE LOCATION.**

Normally, at the time of shipment, SEGA products are in a status allowing for usage immediately after transporting to the location. Nevertheless, an irregular situation may occur during transportation. Before turning on power, check the following points to ensure that the product has been transported in a satisfactory status.

- Are there any dented portions or defects (cuts, etc.) on the external surfaces of the cabinet?
- Are Casters and Adjusters, damaged?
- Do the power supply voltage and frequency requirements meet with those of the location?
- Are all wiring connectors correctly and securely connected? Unless connected in the correct direction, connector connections can not be made accurately. Do not insert connectors forcibly.
- Do power cords have cuts and dents?
- Do the fuses used meet specified rating? Is the Circuit Protector in an energized status?
- Are all accessories available?
- Can all Doors and Lids be opened with the Accessory keys? Can Doors and Lids be firmly closed?

---

---

## TABLE OF CONTENTS

---

---

BEFORE USING THE PRODUCT, BE SURE TO READ THE FOLLOWING:

TABLE OF CONTENTS

INTRODUCTION OF THE OWNER'S MANUAL

1. HANDLING PRECAUTIONS .....	1
2. PRECAUTIONS CONCERNING INSTALLATION LOCATION .....	3 - 4
3. OPERATION .....	5 - 6
4. ASSEMBLING AND INSTALLATION .....	7 - 9
5. PRECAUTIONS TO BE HEDED WHEN MOVING THE MACHINE .....	10
6. NAME OF PARTS .....	11
7. GAME DESCRIPTION .....	12
8. HOW TO PLAY .....	13
9. GAME SETTINGS AND GAME TEST .....	14 - 15
10. DESIGN RELATED PARTS .....	16
11. PARTS □	17 - 24
12. WIREING PINOUT .....	XXX

## SPECIFICATIONS

Installation Space	: 25.5 inches width X 48 inches deep
Height	: 79 inches
Width	: 25.5 inches
Length	: 24 inches
Weight	: 200 lbs
Power, maximum current	: 600 W 5 A (AC 120V 60 Hz AREA)

Monitor : NO MONITOR USED FOR THIS GAME

## INTRODUCTION OF THE OWNERS MANUAL

This Owner's Manual is intended to provide detailed descriptions together with all the necessary information covering the general operation of electronic assemblies, electromechanicals, servicing control, spare parts, etc. as regards the product,

### **Gameshow Game of Skill.**

This manual is intended for the owners, personnel and managers in charge of operation of the product. Operate the product after carefully reading and sufficiently understanding the instructions. If the product fails to function satisfactorily, non-technical personnel should under no circumstances touch the internal system. Please contact where the product was purchased from.

Use of this product is unlikely to cause physical injuries or damages to property. However, where special attention is required this is indicated by a thick line, the word "IMPORTANT" and its sign in this manual.



Indicates that mishandling the product by disregarding this display can cause the product's intrinsic performance not to be obtained, resulting in malfunctioning.

SEGA AMUSEMENTS USA, INC. / CUSTOMER SERVICE  
45133 Industrial Drive, Fremont, California 94538, U.S.A.  
Phone : (415) 701-6580  
Fax : (415) 701-6594

## DEFINITION OF LOCATION MAINTENANCE MAN AND SERVICEMAN



Non-technical personnel who do not have technical knowledge and expertise should refrain from performing such work that this manual requires the location's maintenance man or a serviceman to carry out, or work which is not explained in this manual. Failing to comply with this instruction can cause a severe accident such as electric shock.

Ensure that parts replacement, servicing & inspections, and troubleshooting are performed by the location's maintenance man or the serviceman. It is instructed herein that particularly hazardous work should be performed by the serviceman who has technical expertise and knowledge.

The location's maintenance man and serviceman are herein defined as follows:

### **"Location's Maintenance Man" :**

Those who have experience in the maintenance of amusement equipment and vending machines, etc., and also participate in the servicing and control of the equipment through such routine work as equipment assembly and installation, servicing and inspections, replacement of units and consumables, etc. within the Amusement Facilities and or locations under the management of the Owner and Owner's Operators of the product.

### **Activities of Location's Maintenance Man :**

Assembly & installation, servicing & inspections, and replacement of units & consumables as regards amusement equipment, vending machines, etc.

### **Serviceman :**

Those who participate in the designing, manufacturing, inspections and maintenance service of the equipment at an amusement equipment manufacturer.

Those who have technical expertise equivalent to that of technical high school graduates as regards electricity, electronics and or mechanical engineering, and daily take part in the servicing & control and repair of amusement equipment.

### **Serviceman's Activities :**

Assembly & installation and repair & adjustments of electrical, electronic and mechanical parts of amusement equipment and vending machines.

**LISTED**



**5K92**

**AMUSEMENT MACHINE**

# **IMPORTANT MERCHANDISING TIPS**

**FOR BEST RESULTS, ARRANGE PREMIUM PLUSH TOYS, HIGH PERCEIVED VALUE TOYS AND PRIZES ATTRACTIVELY WITHIN THE PRIZE DISPLAY BIN.**

**PRIZES SHOULD BE ARRANGED WITHIN THE DISPLAY BIN TO OFFER THE PLAYER AN ENTICING AND DIVERSE SELECTION OF PRIZES AVAILABLE.**

**ALWAYS BLEND A VARIETY OF PRIZE CAPSULES IN YOUR GAME TO APPEAL TO A BROAD RANGE OF MALE AND FEMALE PLAYERS. A GAME THAT DISPLAYS PRIMARILY TEDDY BEAR PLUSH FOR EXAMPLE, MAY ONLY APPEAL TO A SPECIFIC PLAYER GROUP.**

**BE SURE TO MIX PRIZE VARIETIES AND PRIZES HAVING THE MOST APPARENT VALUE IN ORDER TO APPEAL TO PLAYERS YOUNG AND OLD, MALE OR FEMALE SO REPEAT PLAY OCCURS.**

**IT IS COMMON TO DISPLAY HIGH VALUE PRIZES IN THE DISPLAY BIN AND ONLY INCLUDE 4 TO 5 PCS. OF THIS PRIZE TYPE MIXED WITHIN THE BALANCE OF THE PRIZE CAPSULE INVENTORY OF LOWER PRICED MERCHANDISE IN ORDER TO MAINTAIN A CONTROLLED PRIZE VEND TO INCOME RATIO.**



# 1. HANDLING PRECAUTIONS

When installing or inspecting the machine, be very careful of the following points and pay attention to ensure that the player can enjoy the game safely.

Non-compliance with the following points or inappropriate handling running counter to the cautionary matters herein stated can cause personal injury or damage to the machine.



- Before performing work, be sure to turn power off. Performing the work without turning power off can cause an electric shock or short circuit. In the case work should be performed in the status of power on, this manual always states to that effect.
- To avoid electric shock or short circuit, do not plug in or unplug quickly.
- To avoid electric shock, do not plug in or unplug with a wet hand.
- Do not expose Power Cords and Earth Wires on the surface, (floor, passage, etc.). If exposed, the Power Cords and Earth Wires are susceptible to damage. Damaged cords and wires can cause electric shock or short circuit.
- To avoid causing a fire or electric shock, do not put things on or damage Power Cords.
- When or after installing the product, do not unnecessarily pull the power cord. If damaged, the power cord can cause a fire or electric shock.
- In case the power cord is damaged, ask for replacement through where the product was purchased from or the office herein stated. Using the cord as is damaged can cause fire, electric shock or leakage.
- Be sure to perform grounding appropriately. Inappropriate grounding can cause an electric shock.
- Be sure to use fuses meeting specified rating. Using fuses exceeding the specified rating can cause a fire or electric shock.
- Completely make connector connections for IC BD and others. Insufficient insertion can cause an electric shock.
- Specification changes, removal of equipment, conversion and/or addition, not designated by SEGA are not permitted.
  - Failure to observe this may cause a fire or an electric shock. Non-compliance with this instruction can have a bad influence upon physical conditions of the players or the lookers-on, or result in injury during play.
  - SEGA shall not be held responsible for damage, compensation for damage to a third party, caused by specification changes not designated by SEGA.
- Be sure to perform periodic maintenance inspections herein stated.



- For the IC board circuit inspections, only the logic tester is allowed. The use of a multiple-purpose tester is not permitted, so be careful in this regard.
- Static electricity from your body may damage some electronics devices on the IC board. Before handling the IC board, touch a grounded metallic surface so that the static electricity can be discharged.
- Some parts are the ones designed and manufactured not specifically for this game machine. The manufacturers may discontinue, or change the specifications of, such general-purpose parts. If this is the case, Sega cannot repair or replace a failed game machine whether or not a warranty period has expired.

◆ PRODUCTION DATE ◆

This SEGA product was produced in the year of:

2004

This signifies that this work was disclosed in 2004.

## 2. PRECAUTIONS CONCERNING INSTALLATION LOCATION



This product is an indoor game machine. Do not install it outside. Even indoors, avoid installing in places mentioned below so as not to cause a fire, electric shock, injury and or malfunctioning.

- Places subject to rain or water leakage, or places subject to high humidity in the proximity of an indoor swimming pool and or shower, etc.
- Places subject to direct sunlight, or places subject to high temperatures in the proximity of heating units, etc.
- Places filled with inflammable gas or vicinity of highly inflammable/volatile chemicals or hazardous matter.
- Dusty places.
- Sloped surfaces.
- Places subject to any type of violent impact.
- Vicinity of anti-disaster facilities such as fire exits and fire extinguishers.
- The operating (ambient) temperature range is from 5°C to 30°C.

### LIMITATIONS OF USAGE REQUIREMENTS



- Be sure to check the Electrical Specifications.  
Ensure that this product is compatible with the location's power supply, voltage and frequency requirements.  
A plate describing Electrical Specifications is attached to the product.  
Non-compliance with the Electrical Specifications can cause a fire and electric shock.
- This product requires the Breaker and Earth Mechanisms as part of the location facilities. Using them in a manner not independent can cause a fire and electric shock.
- Ensure that the indoor wiring for the power supply is rated at 5 A or higher (AC single phase 100 ~ 120 V area). Non-compliance with the Electrical Specifications can cause a fire and electric shock.
- Be sure to independently use the power supply equipped with the Earth Leakage Breaker. Using a power supply without the Earth Leakage Breaker can cause an outbreak of fire when earth leakage occurs.
- Putting many loads on one electrical outlet can cause generation of heat and a fire resulting from overload.
- When using an extension cord, ensure that the cord is rated at 5 A or higher (AC 100 ~ 120 V area). Using a cord rated lower than the specified rating can cause a fire and electric shock.

### Operation Area



- For the operation of this machine, secure a minimum area of 25.5 in. (W) × 48 in. (D). In order to prevent injury resulting from the falling down accident during game play, be sure to secure the minimum area for operation.
- Be sure to provide sufficient space so as to allow this product's ventilation fan to function efficiently. To avoid machine malfunctioning and a fire, do not place any obstacles near the ventilation opening.
- SEGA shall not be held responsible for damage, compensation for damage to a third party, resulting from the failure to observe this instruction.



For transporting the machine into the location's building, the minimum necessary dimensions of the opening (of doors, etc.) are 26 in. (W) and 80 in. (H).

### Electric current consumption

MAX. 5 A (AC 120 V 60 Hz)

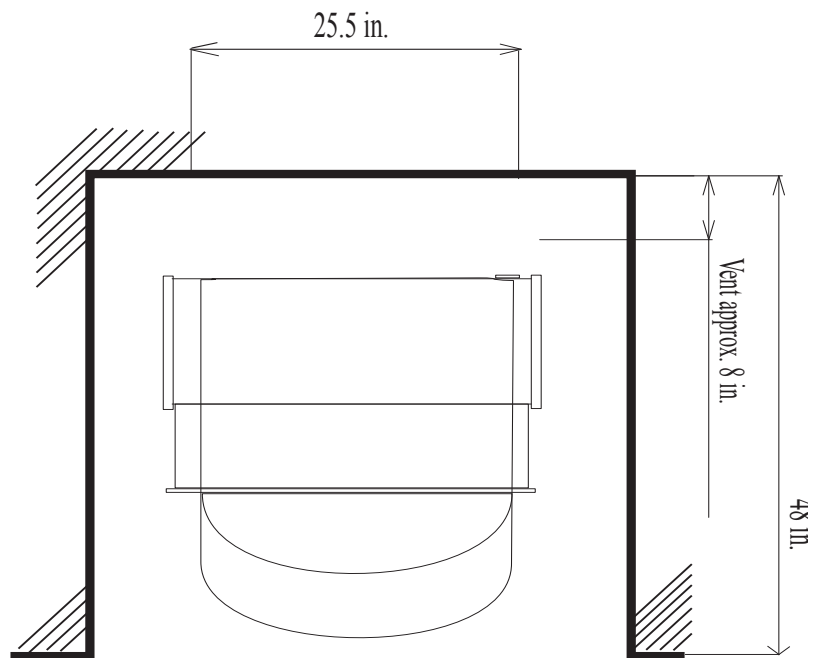

### 3. OPERATION

#### PRECAUTIONS TO BE HEHEDED BEFORE STARTING THE OPERATION

To avoid injury and trouble, be sure to constantly give careful attention to the behavior and manner of the visitors and players.



In order to avoid accidents, check the following before starting the operation:

- To ensure maximum safety for the players and the customers, ensure that where the product is operated has sufficient lighting to allow any warnings to be read. Operation under insufficient lighting can cause bodily contact with each other, hitting accident, and or trouble between customers.
- It is suggested to ensure a space allowing the players who feel sick while playing the game to take a rest.





- Immediately stop such violent acts as hitting and kicking the product. Such violent acts can cause parts damage or falling down, resulting in injury due to fragments and falling down.



- Do not put any heavy item on this product. Placing any heavy item on the product can cause a falling down accident or parts damage.
- Do not climb on the product. Climbing on the product can cause falling down accidents. To check the top portion of the product, use a step.
- To avoid electric shock, check to see if door & cover parts are damaged or omitted.
- To avoid electric shock, short circuit and or parts damage, do not put the following items on or in the periphery of the product.  
Flower vases, flowerpots, cups, water tanks, cosmetics, and receptacles/containers/ vessels containing chemicals and water.

#### PRECAUTIONS TO BE HEDED DURING OPERATION (PAYING ATTENTION TO CUSTOMERS)

To avoid injury and trouble, be sure to constantly give careful attention to the behavior and manner of the visitors and players.



- To avoid injury and accidents, those who fall under the following categories are not allowed to play the game.
  - Those who have experienced muscle convulsion or loss of consciousness when playing video game, etc.
  - Intoxicated persons.
  - Persons whose act runs counter to the product's warning displays.
- To avoid injury resulting from falling down and electric shock due to spilled drinks, instruct the player not to place heavy items or drinks on the product.
- To avoid electric shock and short circuit, do not allow customers to put hands and fingers or extraneous matter in the openings of the product or small openings in or around the doors.
- To avoid falling down and injury resulting from falling down, immediately stop the customer's leaning against or climbing on the product, etc.



#### **WARNING: HAZARD TO EPILEPTICS.**

- A very small portion of the population has a condition which may cause them to experience epileptic seizures or have momentary loss of consciousness when viewing certain kinds of flashing lights or patterns that are present in our daily environment. These persons may experience seizures while watching some kinds of television pictures or playing certain video games. People who have not had any previous seizures may nonetheless have an undetected epileptic condition.
- If you or anyone in your family has experienced symptoms linked to an epileptic condition (e.g., seizures or loss of awareness), immediately consult your physician before using any video games.
- We recommend that parents observe their children while they play video games. If you or your child experience the following symptoms: dizziness, altered vision, eye or muscle twitching, involuntary movements, loss of awareness, disorientation, or convulsions, **DISCONTINUE USE IMMEDIATELY** and consult your physician.

## 4. ASSEMBLING AND INSTALLATION



- Perform assembly work by following the procedure herein stated. Failing to comply with the instructions can cause electric shock hazard.
- Perform assembling as per this manual. Since this is a complex machine, erroneous assembling can cause an electric shock, machine damage and or not functioning as per specified performance.
- When assembling, be sure to use more than one person. Depending on the assembly work, there are some cases in which working by one person alone can cause personal injury or parts damage.
- Ensure that connectors are accurately connected. Incomplete connections can cause electric shock hazard.
- Be careful not to damage the wires. Damaged wires may cause electric shock or short circuit or present a fire risk.
- This work should be performed by the Location's Maintenance Man or Serviceman. Performing work by non-technical personnel can cause a severe accident such as electric shock. Failing to comply with this instruction can cause a severe accident such as electric shock to the player during operation.
- Provide sufficient space so that assembling can be performed. Performing work in places with narrow space or low ceiling may cause an accident and assembly work to be difficult.
- To perform work safely and avoid serious accident such as the cabinet's falling down, do not perform work in places where step-like grade differences, a ditch, or slope exist.



- Handle molded parts with care. Undue weight or pressure may cause them to break and the broken pieces may cause injury.
- To perform work safely and securely, be sure to prepare a step which is in a secure and stable condition. Performing work without using the step can cause violent falling down accidents.

Tools such as a Phillips type screwdriver, wrench, socket wrench and Ratchet Handle may be required for the assembly work.

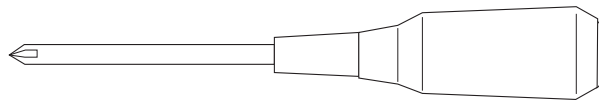

Phillips type screwdriver

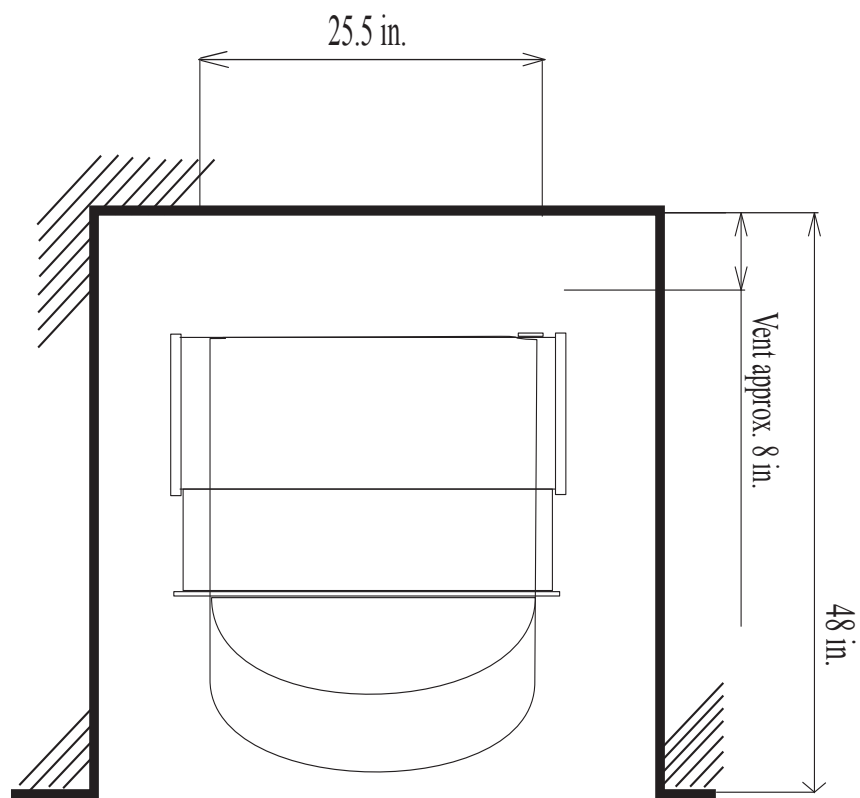

FIG. 6.2 e  
 Provide ventilation space for the ventilation opening.  
 Allow more than 28 in. of space for customer traffic.



## POWER SUPPLY, AND EARTH CONNECTION



- Be sure to independently use the power supply socket outlet equipped with an Earth Leakage Breaker. Using a power supply without an Earth Leakage Breaker can cause a fire when electric leakage occurs.
- Ensure that the "accurately grounded indoor earth terminal" and the earth wire cable are available (except in the case where a power cord plug with earth is used). This product is equipped with the earth terminal. Connect the earth terminal and the indoor earth terminal with the prepared cable. If the grounding work is not performed appropriately, customers can be subjected to an electric shock, and the product's functioning may not be stable.
- Ensure that the power cord and earth wire are not exposed on the surface (passage, etc.). If exposed, they can be caught and are susceptible to damage. If damaged, the cord and wire can cause electric shock and short circuit accidents. Ensure that the wiring position is not in the customer's passage way or the wiring has protective covering.
- After wiring power cord on the floor, be sure to protect the power cord. Exposed power cord is susceptible to damage and causes an electric shock accident.

The AC Unit is located inside on one side of Cabinet. The AC Unit has Main SW, Earth Terminal and the Inlet which connects the Power Cord.

- Ensure that the Main SW is OFF.

Power is off when the MAIN SWitch is in the down position. To supply power to the unit, flip the MAIN SWitch upwards.

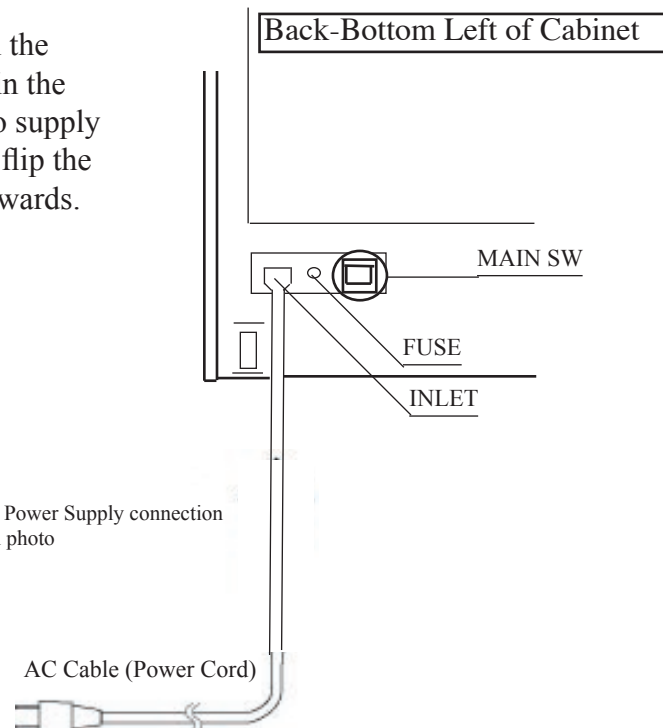

## 5. PRECAUTIONS WHEN MOVING THE MACHINE



- When moving the machine, be sure to unplug the power plug. Moving the machine with the plug as is inserted can damage the power cord and cause fire and electric shock hazards.
- When moving the machine on the floor, pay careful attention so that adjusters do not tread power cords and earth wires. Damaging the power cords can cause electric shock and short circuit hazards.
- Do not push the cabinet from the left/right when attempting to move the unit. Pushing from the sides may cause the unit to tip and result in injury and damage to parts.



Do not push on any parts made of glass (e.g. Main Plex) or plastic, as these parts may break and result in bodily injury.

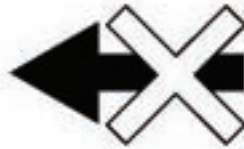

Do not push the cabinet from the left/right direction.

## 6. NAME OF PARTS



TABLE 4 Dimensions and Weights

	Width	x	Length	x	Height	Weight
CABINET	29.25 in	x	24 in	x	79 in	200 LBS
When assembled	29.25 in	x	24 in	x	90 in	200 LBS

## 7. GAME DESCRIPTION

The following explanations apply to the case the product is functioning satisfactorily. Should there be any moves different from the following contents, some sort of faults may have occurred. Immediately look into the cause of the fault and eliminate the cause thereof to ensure satisfactory operation.

When the power is connected, the fluorescent lamps light up, and the game enters a test mode. In this mode the game runs the Auger up and down to locate a “Large” Prize and the Prize bin under the Display bin runs until a “Small” prize is located.



### Game Overview

This is a self contained merchandiser game. Meaning that you input coins/tokens and after play it dispenses a product for the player. After inserting the appropriate amount of coins/tokens the players ball is released to the plunger which allows the player to shoot the ball and attempt through 4 tries to beat the “high score” displayed on the top LED display. If the “high score” is beat then a “Large” prize is dispensed otherwise a “Small” prize is dispensed.

## 8. HOW TO PLAY

- After enough coins/tokens are inserted into the coin/credit slot, the game begins to run. The Player is given 4 shots to beat the Top displayed score.



Insert Coins/Tokens

- The player then grasps the plunger and attempts to shoot the ball with the proper force to score highly.



Shoot Ball

- The goal is to beat the “top score”, within 4 shots, by placing the ball through the various passages on the playing field.

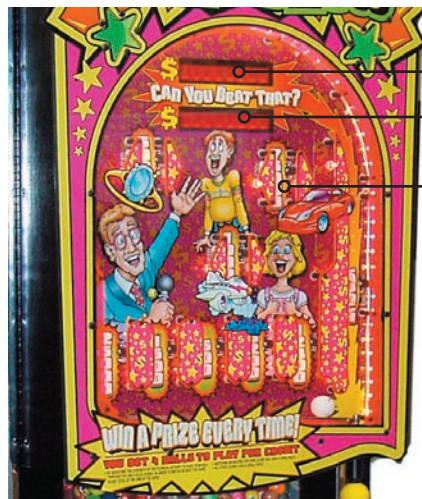

Top score

Your current score

Score + amounts

- If the player scores higher than the “top score” within his 4 shots allocated, gameplay is stopped and a “Large” prize is dispensed in the form of a 4” capsule. Otherwise the player is rewarded for playing by being given a superball prize for his efforts. More credits are needed to play another round. During the next round the “current score” is set back to 0 and the “top score” is adjusted accordingly.



Receive Prize

# 9. Game Settings and Game Test

## Game Settings

Note: Switches can be used only with the door open, so the door switch must be connected to perform these 4 functions.

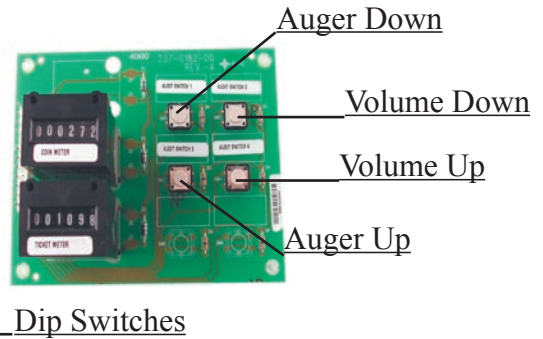
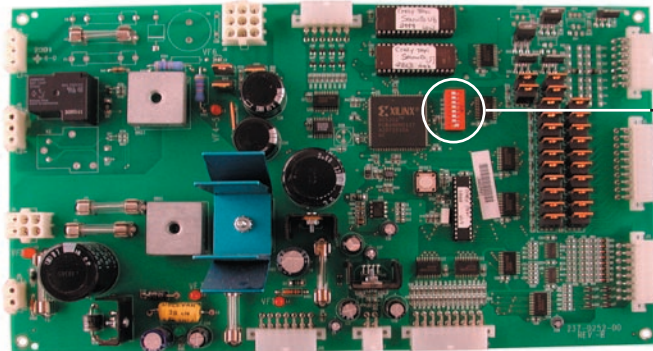

### Dip Switch Settings:

Level A Scoring:	SW1-Off	SW2-Off	[approximately 1 in 10 win ratio]
*Level B Scoring:	SW1-On	SW2-Off	[approximately 1 in 15 win ratio]
Level C Scoring:	SW1-Off	SW2-On	[approximately 1 in 20 win ratio]
Level D Scoring:	SW1-On	SW2-On	[approximately 1 in 25 win ratio]

\* - Factory Default Settings

There are four levels of “skill”. This means that there are four levels of scoring tables. The level A scoring table is the easiest with the game posting lower scores to beat [in addition to high scores] while the level D scoring is mostly high scores to beat making the game much more difficult. When a game is set for example, on the level B scoring table which is the factory setting, then the game only posts scores from tables B-C-D in order to control the “skill” required to beat the score posted. The game posts scores to beat from any tables above the setting chosen in addition to the table chosen but will not post scores lower than the table chosen.

When a capsule is won, the game software will automatically adjust the difficulty level up or down within the Level Scoring tables [beginning with the table chosen in the dip switch setting] to reach the desired approximate win ratio.

All scores posted by the software in the “Score to Beat” [or match] in order to win a capsule are 100% attainable by the Player at all times. There is NEVER a score which cannot be won.

### Credits:

*1 credit required:	SW3-Off
2 credit required:	SW3-On

### Game Operation:

*Normal operation:	SW7-Off
Factory Reset:	SW7-On

Factory reset setting is used to clear any accumulated superball or capsule wins which may have accumulated in a game that has run out of prizes. The operator turns off the power to the game, sets this setting and returns the power which resets the game and clears any unpaid prizes. The operator then turns the power off, returns the setting to 'Normal' and resumes play.

#### Game Test

The game is tested simply by opening the door and actuating the door switch located at the upper right hand corner of the inside of the playfield door. Depressing this switch and holding it in emulates a 'door closed' condition. The game is designed to, upon 'door closed' after filling stock, etc., run the auger motor, run the superball motor, cycle the displays, flash the playfield lamps, and draw back the ball release plunger in order to insure each of these devices are working. All of these internal game tests can be observed by simply actuating the switch when the door is open and holding it until the game music is heard [game attract mode comes on following the test].

The only switches which cannot be tested are the playfield optos. These switches can only be verified by removing the front glass to access the playfield and then playing a game [crediting the game up to start a game] and then one by one, passing an object through the optos to verify the switch closure which is indicated by the flashing score at the switch location.

In the door open test mode, the playfield lamps will be cycling [verifying lamps]

holding the door switch closed will:

- 1- Operate the auger in the up motion followed by the down motion until the next prize capsule reaches the capsule read switch. When a capsule has reached the switch and the switch is made, then a 'Beep-Beep' sound effect is heard to verify the action of the switch.
- 2- Following the auger test, the superball mechanism will operate until a superball is dispensed, indicated by a 'slide whistle' sound effect which verifies the superball dispense switch actuation.
- 3- The ball release coil will withdraw and release the ball.

In summary, the game performs a test of it's own each time the game door is opened to say, fill stock or take meter readings. If an operator wants to monitor this test, then the test can be performed by holding the door switch closed and watching each individual test cycle through.

## 10. DESIGN RELATED PARTS

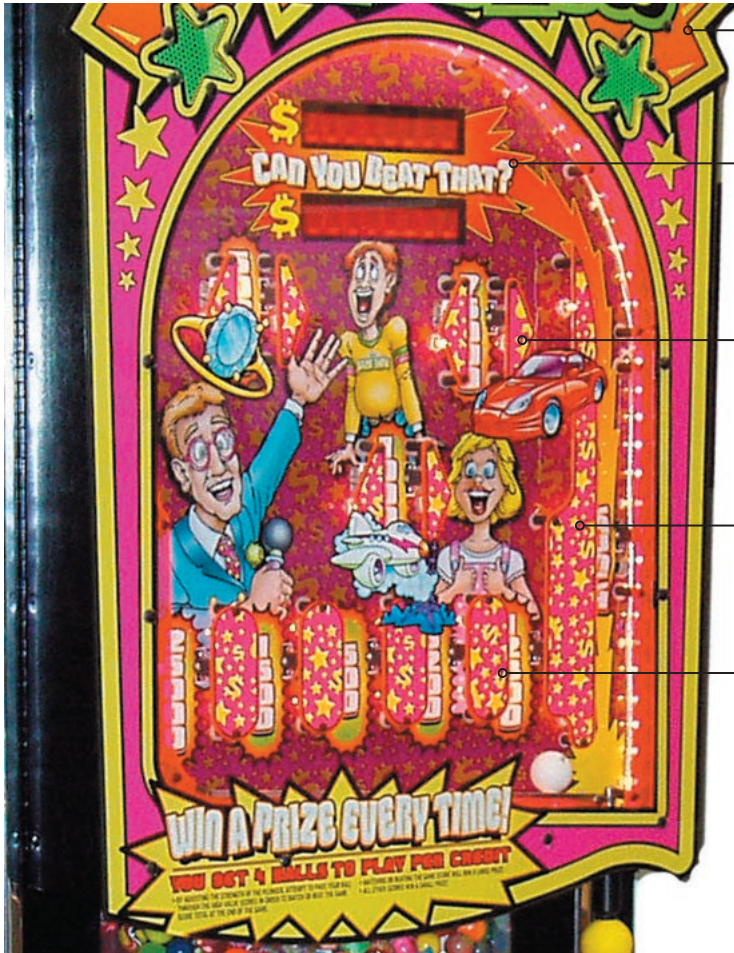

Playfield Cover Plex GS  
999-2036

Decal Playfield GS  
999-2037

Triangle Sensor Cover GS  
999-2038

Shooting Sensor Cover GS  
999-2039

Oval Sensor Cover GS  
999-2040

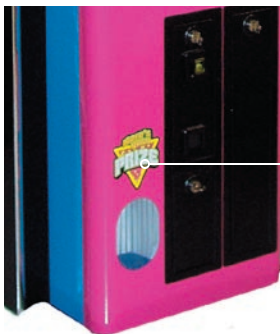

Decal Get Prize GS  
999-2041









# 11. PARTS

## Playfield

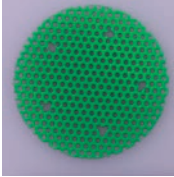
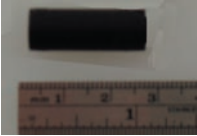
(P 1/3)

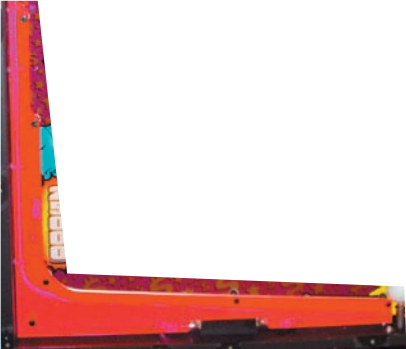



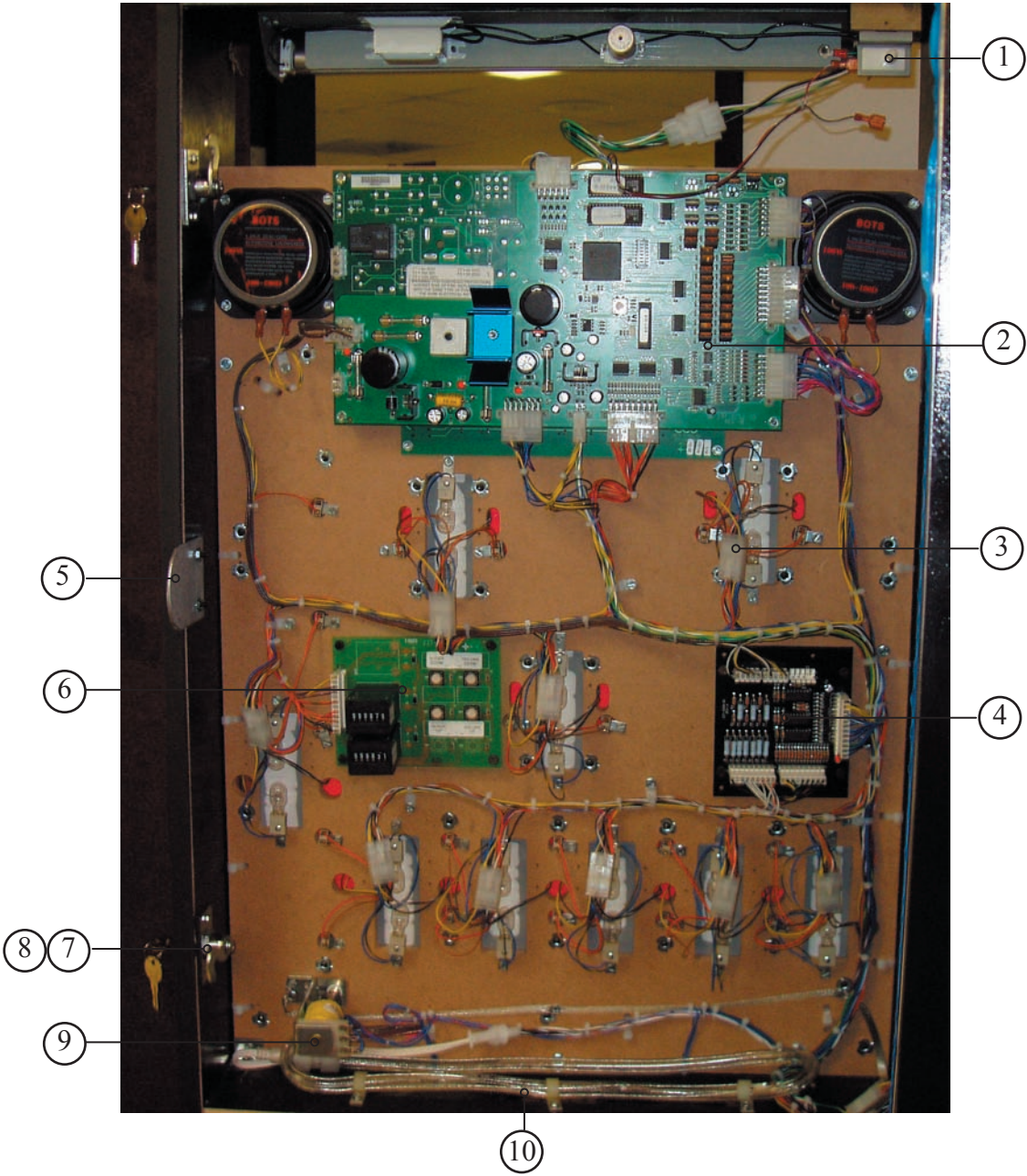

Item Number	Part Number	Description	Picture
1	Local Purchase	15" Coolwhite Fluorescent Bulb and Fixture	
2	Local Purchase	4" 4Ohm 100W speaker	
3	999-2046	Speaker Grill	
4	999-2049	Playfield Standoff	
5	999-2042	Playfield White Sensor	
6	999-2043	Playfield Black Sensor	
7	999-2044	Playfield Ball Guide Lower	
8	999-2045	Playfield Ball Guide Right	

Item Number	Part Number	Description	Picture
9	999-2050	Plunger Shaft and Ball	
10	999-2052	Plunger Lower Spring	
11	999-2051	Plunger Guide	
12	999-2053	Plunger Upper Spring	
13	Local Purchase	Plunger Washer .62in outside .4in inside .03in thick	
14	Local Purchase	Plunger E-Ring .67in outside .038in thick	
15	998-0208	8 Digit LED Display	
16	999-2047	Ball Guide Upper	

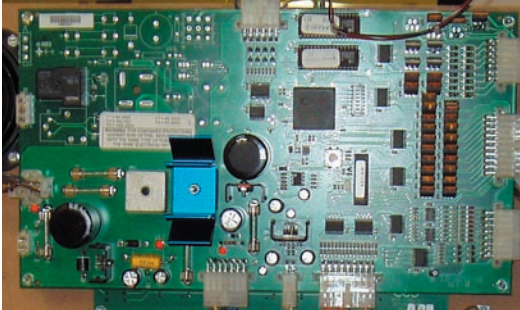
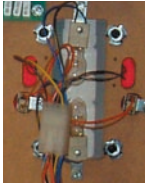
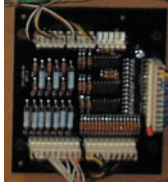
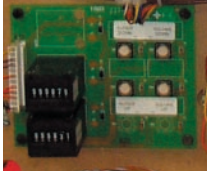

**Inside Door**

**(P 2/2)**

Item Number	Part Number	Description	Picture
1	999-2054	Door Switch	
2	998-0210	Gameboard CPU GS	
3	998-0213	Sensor Harness no bulbs	
4	998-0211	Light Control Board	
5	999-2055	Door Position Plate	No Picture Available
6	998-0212	Meter and Control Board	
7	999-2062	Key and Latch GS	No Picture Available
8	999-2063	Key Latch Plate	No Picture Available
9	998-0209	Gate Solenoid	
10	999-0264	Rope Light GS	
11	Local Purchase	Bulb C912	
12	Local Purchase	Bulb SLI 512 12V 20P	No Picture Available

## SuperBall Bin

(P 1/1)



NOTE: To access the Superball bin, you need to reach in through the coin door and unlatch the two latches located on the right and left insides located in front of the bin. After unsecuring these latches the yellow rest area can be raised up and pulled forward to remove. Then the Superball bin can be lifted out.

NOTE: Ballhole goes on the right side looking into the bin on reassembly.

Item Number	Part Number	Description	Picture
1	999-2048	Ball Bin	
2	999-2056	Stirer Holddown Ring	
3	999-2060	Superball Stirer Short Spring	
4	999-2061	Superball Stirer Long Spring	
5	999-2057	Superball Stirer Guide	
6	999-2058	Superball Stirer Body	
7	999-2059	Superball Stirer	

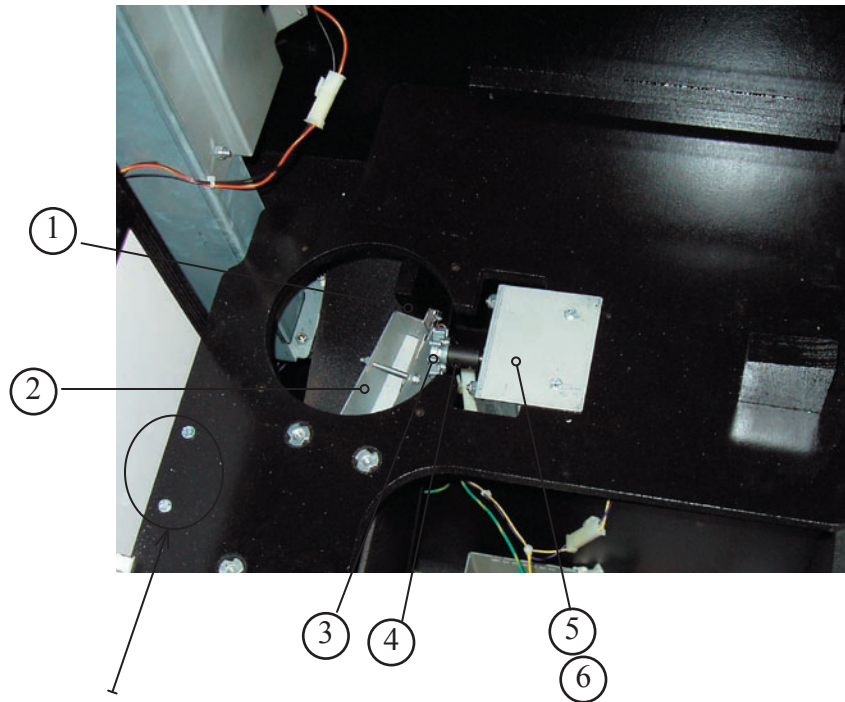



NOTE: This shelf is removed by unscrewing the two hex headed screws located on the left of the image then lifted out.

ITEM NO.	PART NO.	DESCRIPTION	NOTE
1	999-2065	Superball Switch	
2	999-2066	Superball Tunnel	
3	999-2067	Stirer Motor Gear	
4	999-2068	Stirer Motor Coupler	
5	999-2069	Stirer Motor Bracket	
6	998-2070	Stirer Motor	

Misc Parts

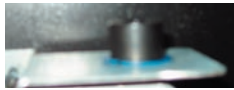
(P 1/1)

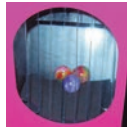
Item Number	Part Number	Description	Picture
1	998-2075	Auger Cap	
2	999-2071	Auger Bracket	No Picture Available
3	999-2079	Auger Screw	No Picture Available
4	999-2072	Auger Rod	No Picture Available
5	999-2073	Auger Motor	No Picture Available
6	999-2074	Auger Coupler	No Picture Available
7	998-0214	Transformer 16V40Amp Small	No Picture Available
8	998-0215	Transformer 12.6V8Amp Large	No Picture Available
9	999-2078	Rear Wheel	
10	999-2076	Rear Handle	No Picture Available
11	HAPP:40-0401-00	Slim Validator Door	No Picture Available
12	Happ:40-0400-00	Slim Coin Door	No Picture Available
13	999-1585	Leg Leveler	No Picture Available
14	999-2077	Prize Chute Flap	

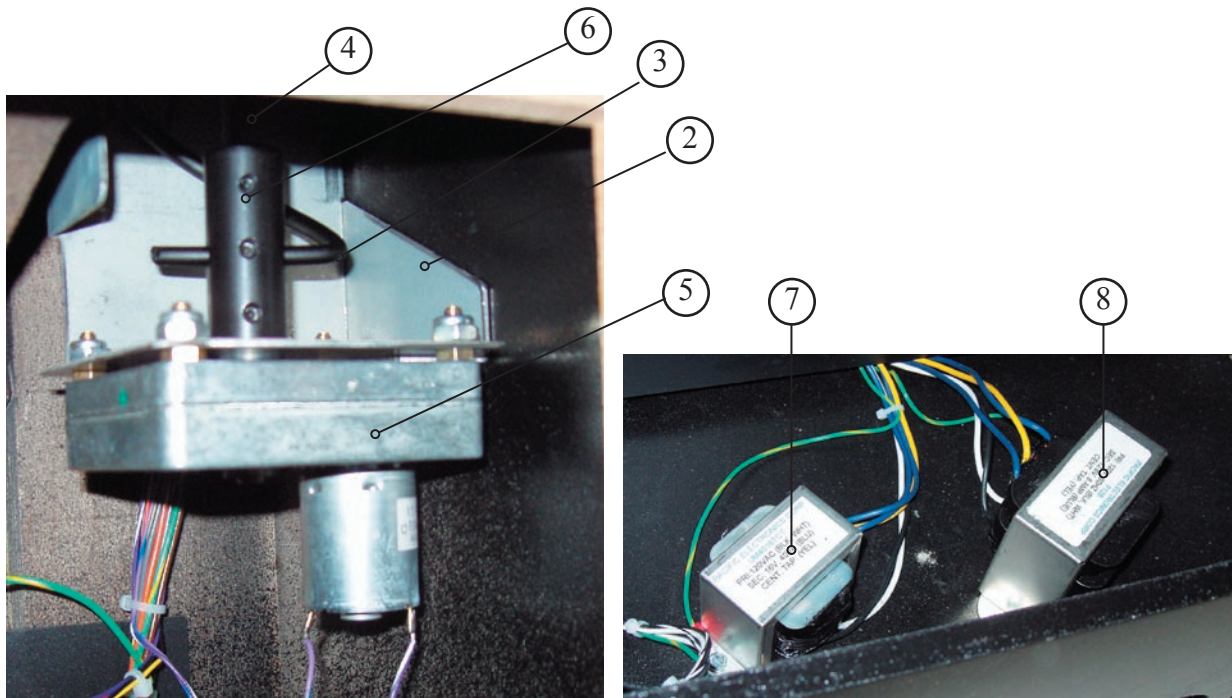



## Warranty

Your new Sega Product is covered for a period of 90 days from the date of shipment. This certifies that the Printed Circuit Boards, Power Supplies and Monitor are to be free of defects in workmanship or materials under normal operating conditions. This also certifies that all Interactive Control Assemblies are to be free from defects in workmanship and materials under normal operating conditions. No other product in this machine is hereby covered.

Sellers sole liability in the event a warranted part described above fails shall be, at its option, to replace or repair the defective part during the warranty period. For Warranty claims, contact your Sega Distributor.

Should the Seller determine, by inspection that the product was caused by Accident, Misuse, Neglect, Alteration, Improper Repair, Installation or Testing, the warranty offered will be null and void.

Under no circumstances is the Seller responsible for any loss of profits, loss of use, or other damages.

This shall be the exclusive written Warranty of the original purchaser expressed in lieu of all other warranties expressed or implied. Under no circumstance shall it extend beyond the period of time listed above.



**SEGA AMUSEMENTS USA, INC.**

45133 Industrial Drive  
Fremont, CA 94538  
**(415) 701-6580** phone  
**(415) 701-6594** fax

## Free Manuals Download Website

<http://myh66.com>

<http://usermanuals.us>

<http://www.somanuals.com>

<http://www.4manuals.cc>

<http://www.manual-lib.com>

<http://www.404manual.com>

<http://www.luxmanual.com>

<http://aubethermostatmanual.com>

Golf course search by state

<http://golfingnear.com>

Email search by domain

<http://emailbydomain.com>

Auto manuals search

<http://auto.somanuals.com>

TV manuals search

<http://tv.somanuals.com>