

111 00 00 124

USER'S GUIDE

P46728

P46729

P46730

P46731

P46732

P46738

P52730

P52731

RECEIVED SEP 2 6 1997

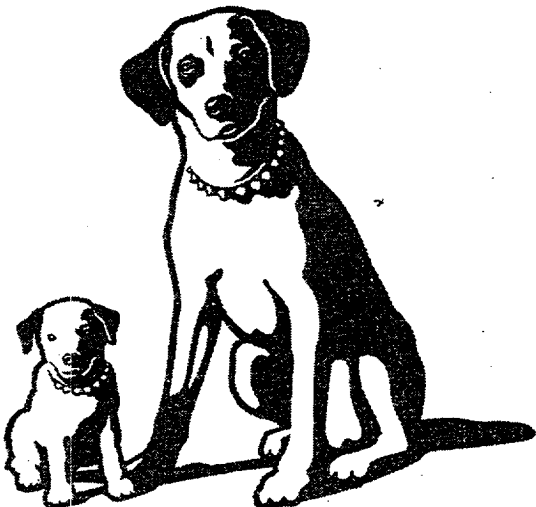

REF

COLOR TV

Safety Precautions

WARNING

To reduce the risk of fire or shock hazard, do not expose this TV to rain or moisture.

WARNING

RISK OF ELECTRIC SHOCK
DO NOT OPEN

TO REDUCE THE RISK OF ELECTRIC SHOCK, DO NOT REMOVE COVER (OR BACK). NO USER SERVICEABLE PARTS INSIDE. REFER SERVICING TO QUALIFIED SERVICE PERSONNEL.



This symbol indicates "dangerous voltage" inside the product that presents a risk of electric shock or personal injury.



This symbol indicates important instructions accompanying the product.

Cautions

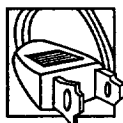

CAUTION:

To prevent electric shock, match wide blade of plug to wide slot, fully insert.

ATTENTION:

Pour éviter les chocs électriques, introduire la lame la plus large de la fiche dans la borne correspondante de la prise et pousser jusqu'au fond.

Operate TV only on 120 volts, 60 Hz AC power (normal house power) .

FCC Regulations state that unauthorized changes or modifications to this equipment may void the user's authority to operate it.

Note To Cable TV Installer

This reminder is provided to call your attention to Article 820-40 of the National Electrical Code (Section 54 of the Canadian Electrical Code, Part 1) which provides guidelines for proper grounding and, in particular, specifies that the cable ground shall be connected to the grounding system of the building as close to the point of cable entry as practical.

Product Registration

Mail Your Registration Card Today

- A *Product Registration Card* is packed with your set. Please fill out the card and return it immediately.
- Your prompt submission of this card confirms your right to the protection available under the terms and conditions of the warranty and also allows us to contact you should it ever become necessary.
- With your card on file, we can also help you in the event of loss or theft by verifying your ownership.
- If you did not receive a *Product Registration Card*, please contact your dealer.

Attach Your Sales Receipt Here and File at Home for Future Reference

- To obtain warranty parts and service, you must show your sales receipt (or evidence of purchase) to your Authorized TV Servicer.
- Tape or staple your sales receipt to this manual so you will have it handy should service ever be needed. File it at home for future reference. **Do not mail your sales receipt to us.**

Record Vital Information Here

- No other set has the same serial number as yours. You will find the serial number and the model number on the back of your set.
- Make sure you record both numbers below so that you will have them in case your set is stolen or if you need a complete description for identification.

Model: _____

Serial: _____

Purchase Date: _____

Dealer Name/Address/Phone: _____

Thank you for choosing RCA
Congratulations on your purchase of an RCA TV. You have selected a high-quality, precision-engineered instrument designed to give you years of enjoyment.

About This Manual

To take full advantage of all the features and benefits of this unique TV, be sure to read this owner's manual carefully and then keep it for future reference.

Table of Contents

Safety Precautions	Inside Front Cover
Product Registration	Inside Front Cover
First-Time Operation	2-5
Operating Instructions	
Front Panel Controls	6
TV On-Screen Status Displays	7
Remote Control	
• Installing Batteries	8
• Basic Operation Theory	9
• TV Functions	10-11
Picture-in-Picture	12-13
<i>VIDEO</i> Menu- General Instructions	14
• Color Convergence	15
<i>AUDIO</i> Menu- General Instructions	16
• Sound Retrieval System-SRS(●)	17
<i>SETUP</i> Menu- General Instructions	18
• Setting Closed Captioning	19
• Setting the Sleep Timer	20
• Setting the Alarm	21
• Labeling Channels	22
• Parental Control	23
• Channel Memory (Autoprogramming Channels)	24
• Channel Memory (Erasing/Adding Channels)	24
• Changing Antenna Input	25
• Setting up VCR Channels	26
• Setting up Cable Box Channel	27
Detailed Connections	
Tips to Read Before Connecting Components	28
Monitor Panel	29
Antenna and Cable Connections	
• Home Antenna Connections	30
• Cable-TV Connections	31-32
• Programming Remote to Control a Cable	33
• Cable-TV Operation	34
Component Connections	
• Standard VCR	35-36
• S-VHS (Super VHS) VCR	36
• Remote Buttons That Control RCA VCRs	37
• Controlling Other Brands of VCRs	38
• Camcorder	39
• Computers and Other Equipment	40
• Audio Amplifier	41
• Programming Remote to Control Audio Equipment	42
• Speaker Connections	43
Reference Section	
Optional Accessories and Order Form	44-46
Cleaning and Care	47
Trouble Checks	48-50
Limited Warranty	51
Index (Alphabetical Subject Reference)	52

First-Time Operation

The steps below will help you get your TV connected and working quickly.

1. Unpack TV and accessories.

Shown here are the accessories that came packed with your TV.

2. Install batteries in remote control.

Details are on page 8.

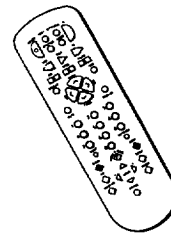

Remote Control

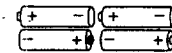

Four AAA Batteries for Remote

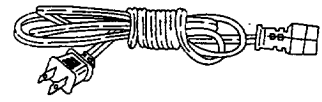

Power Cord

Caution Always move TV from either end. The TV could tip if pushed or pulled from the center of the front or back. Position the TV by rolling the right side close to its final location then swinging the left side back to its final location. Do not push on the screen.

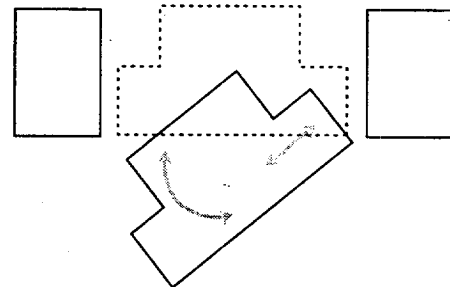

3. Position TV in room.

A major benefit of a Projection Color Television is its large viewing screen. To receive full benefit of the expanded screen size, placement of the TV in the viewing room is important. The illustrations suggest the "best viewing areas" relating to the TV's screen.

You will see the best picture if you sit directly in front of the TV about 10-18 feet from the screen. Picture brightness will decrease if you sit to the extreme left or right of the TV.

Your Projection TV is designed to provide a watchable picture when viewed within the full 160° horizontal viewing area.

During daylight hours, you may also see some reflection on the screen from exterior light sources. If so, you may wish to use drapes or screens to reduce reflection or consider a different placement of the TV.

CAUTION: Inadequate or poor ventilation may cause overheating, damage, or the risk of fire hazard.

This projection TV is equipped with ventilation openings in the cabinet back and bottom to allow heat generated during operation to be released. Inadequate air flow to these openings may result in failures due to overheating, damage to your TV, and the risk of fire hazard.

When locating and installing your projection television receiver, read and carefully follow the instructions contained in the "Installation" section in the enclosed safety pamphlet.

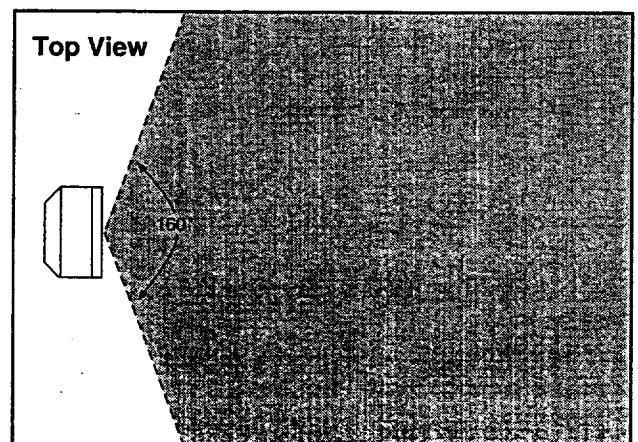
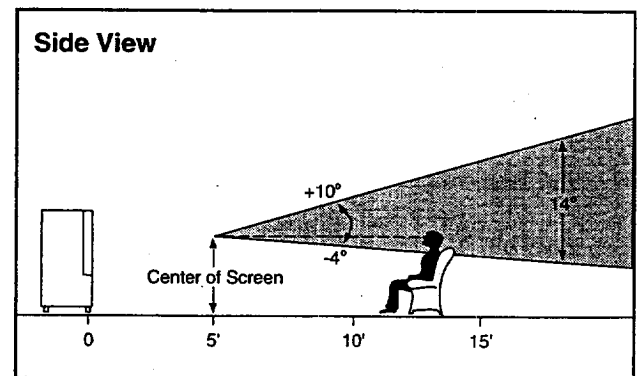

First-Time Operation (continued)

4. Connect antenna or cable-TV system.

Most antenna or cable-TV systems can be connected as show here.

- Details for connecting a home antenna to your TV are on page 30.
- Details for connecting a cable-TV system to your TV are on pages 31.
- Details for connecting a VCR to your TV are on pages 35-36.

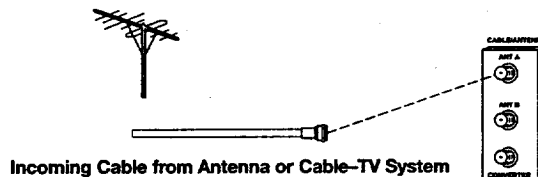

5. Attach power cord.

First attach the flat end of the power cord completely into the connector on the back of your TV, and then plug the other end into a wall outlet.

6. Turn on TV, adjust the volume, and select a channel.

- Press the *TV* button on the remote to turn on the TV. When using the remote, remember to point it at the front of the TV.
- Press the *VOL* up or down button to adjust the volume to a desired level.
- Press the *CHAN* up or down button to select a channel in memory. You can also press two number buttons to select a channel. To select a 3-digit cable channel (up to channel 128), press and hold number button 1 until 1-- appears on the screen. Then press the other two numbers. Channels 2-13 were programmed into the channel memory for you at the factory, so pressing *CHAN* up or down stops at these channels only. When you start the AutoProgramming feature (described below), your set automatically scans through all channels and place only the active channels for your area into its channel memory.
- Details about using the remote are on page 8-11.

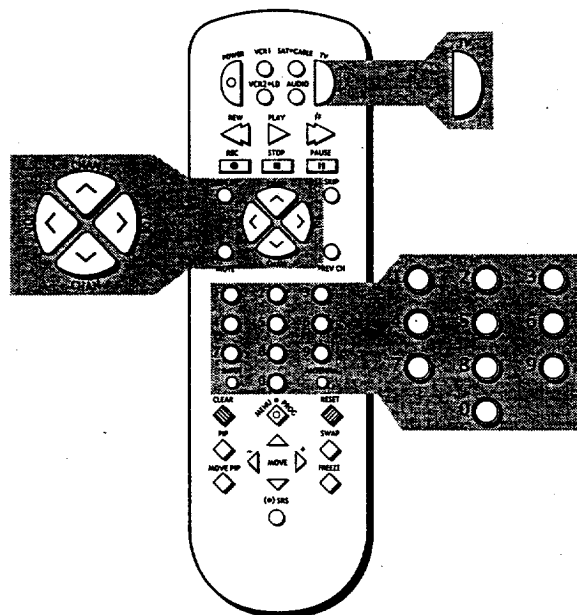

7. Converge Colors if Necessary.

If you notice colored rings or halos around objects in the picture, you may need to converge the colors. Over a period of time, the picture tubes can drift out of alignment due to normal bumps and vibrations or moving the TV. Details for converging the colors are on page 15.

First-Time Operation (continued)

8. AutoProgram the TV's channel memory.

To start the TV autoprogramming itself, press the **MENU•PROG** button repeatedly to select **SETUP MENU** and then press **+** to display the setup functions. Repeatedly press **MENU•PROG** again to select the **AUTOPROGRAM** function, and then press **+**. Details are on page 24.

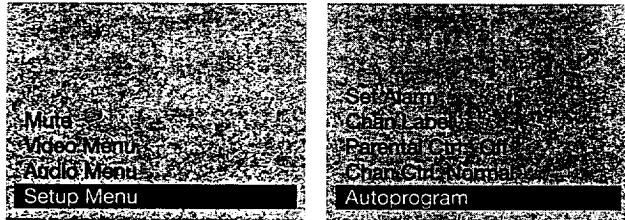

You can also add and erase channels from memory as desired. Press **MENU•PROG** repeatedly to select the **SETUP MENU**, then press **+** to display the setup functions.

Press **MENU•PROG** repeatedly to select (highlight) the **CHAN MEM** function. Select the desired channel number by pressing the **CHAN** up or down button or by pressing the two corresponding number buttons.

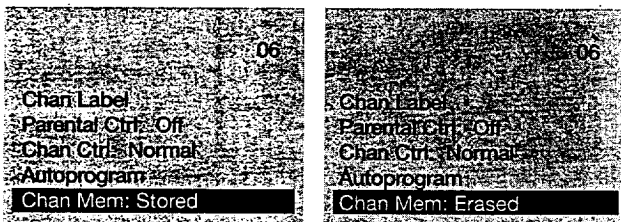

Then press **+** to add a channel, or press **-** to erase a channel. Details are on page 24.

9. Set the clock.

1. Repeatedly press the **MENU•PROG** button to select the **SETUP MENU** and then press **+**. Press **MENU•PROG** repeatedly again to select the **CLOCK SET** display.

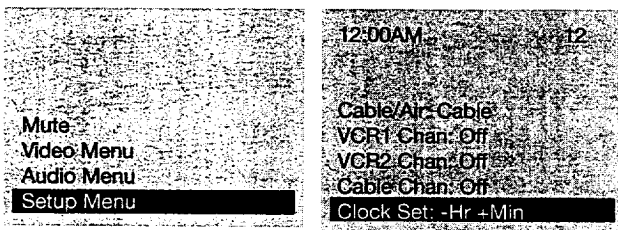

2. Press and hold the **-** button to select the correct hour (including AM or PM). Press and hold the **+** button to select the correct minute. The correct time will now appear on the screen whenever you change channels or press the **TV** or **DISPLAY** button.

Note: If power is interrupted for an extended time, you will need to reset the clock.

First-Time Operation (continued)

10. Review menus.

1. To see the video menu, repeatedly press **MENU•PROG** button to select **VIDEO MENU** and then press **+**. Repeatedly press **MENU•PROG** to select desired function and then press **+** or **-** to adjust it. Details are on page 14.

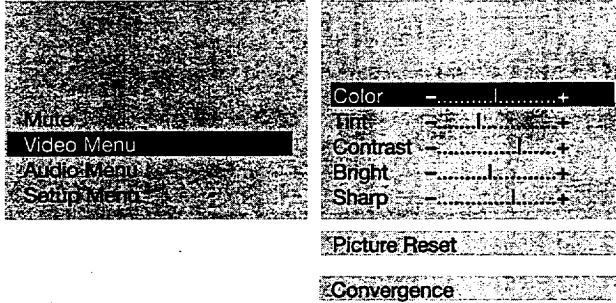

2. To see the audio menu repeatedly press **MENU•PROG** to select the **AUDIO MENU** and then press **+** or **-** to adjust it. Details begin on page 16.

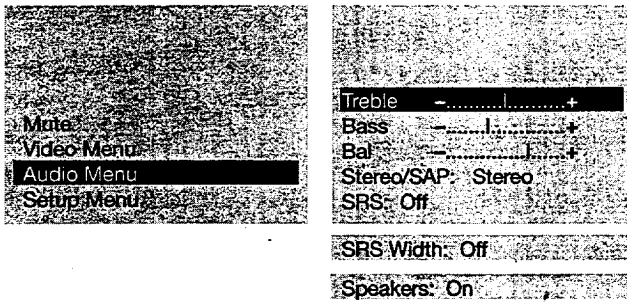

3. To see the setup menu, repeatedly press **MENU•PROG** to select **SETUP MENU** and then press **+**. Repeatedly press **MENU•PROG** to select desired function and then press **+** or **-** to adjust it. Details begin on page 18.

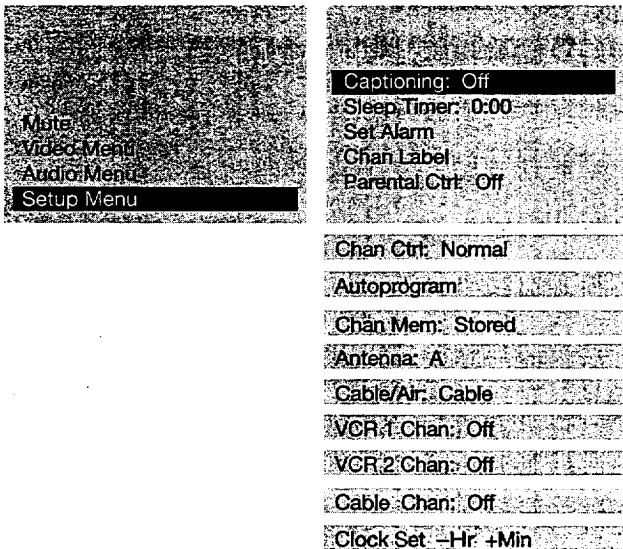

Review other features.

Later, after you feel comfortable with your TV and remote control, you can review the detailed control descriptions and special features covered in this manual.

You can use the rest of this manual as a reference guide to review detailed information about each operating control and function. The alphabetical index in the back will help you quickly locate desired information.

Front Panel Controls

Shown here is the front panel control. You can use either the front panel controls or the remote control to operate the TV. When using the remote control, point it toward the screen.

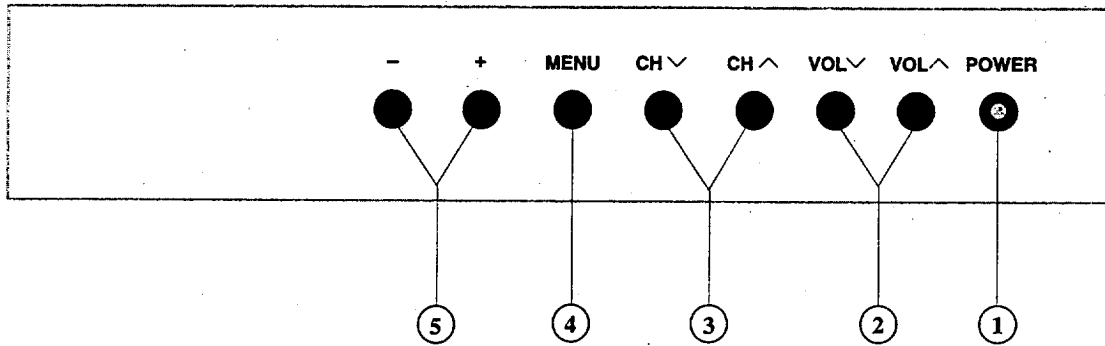

① **POWER Button**

- Press once to turn on TV.
- Press again to turn off TV.
- On some models, an indicator on the *POWER* button will light whenever the TV is turned on.

② **VOL (Volume) Buttons**

- Press *VOL* up to increase volume, or press *VOL* down to decrease volume.
- The volume display will automatically appear on the screen when you press the *VOL* buttons.

③ **CH (Channel) Buttons**

- Press *CH* up to see the next higher channel in memory.
- Press *CH* down to see the next lower channel in memory.
- You can add or erase channels in memory as desired. Details are on page 24.

④ **MENU Button**

- Press repeatedly until the menu you want to display is selected, then press + or -. Next press *MENU* repeatedly to select the function you want to adjust and then press + or - to adjust the setting.
- Details about using each function begin on page 14.

⑤ **- and + Buttons**

Use these buttons after you have pressed the *MENU* button to enter or adjust functions.

TV On-Screen Status Displays

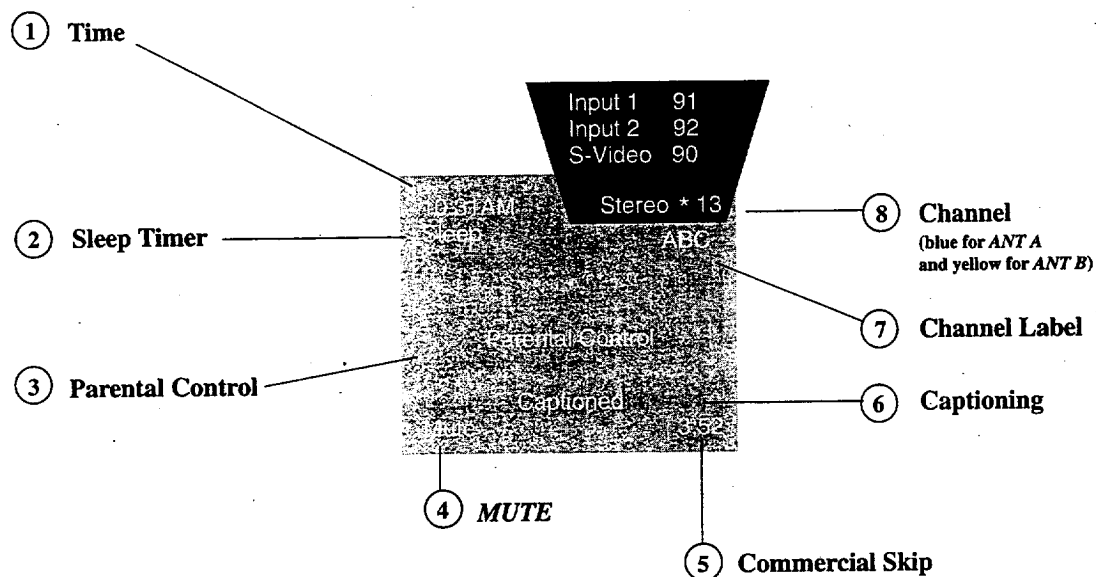

① Time Display

This display appears (after the clock is set) whenever you change channels or press the remote's *TV* or *DISPLAY* button.

② Sleep Timer (*SLEEP*)

This display appears when the *SLEEP TIMER* function has been activated. Details are on page 20.

③ *PARENTAL CONTROL*

This display appears to let you know the channel you have tuned is locked-out and not viewable because the *PARENTAL CONTROL* function is activated. Details are on page 23.

④ *MUTE*

This display appears when the TV's sound is muted. It is not displayed when closed captioning is turned on. Details are on page 11.

⑤ Commercial Skip

This display is a count-down timer that appears whenever the commercial skip function is activated. Details are on page 10.

⑥ Captioning

This display appears if *CAPTIONS 1* is turned on and the TV program uses closed captioning. Details are on page 19.

⑦ Channel Label

This display appears when you label a channel. Details are on page 22.

⑧ Channel

This display shows the TV's channel number whenever you change channels or press the remote's *TV* or *DISPLAY* button

When the channel numbers are blue, you are watching the signals from the *ANT A* antenna input. If you change the *ANTENNA: A/B* function to *B*, the color of the channel numbers will change to yellow to let you know you are watching the signals from the *ANT B* input.

The word *STEREO* appears next to the channel number if the *STEREO/SAP* function is set to *STEREO* and the channel you've tuned is broadcasting stereo. An asterisk will appear behind the word stereo (*STEREO**) if that stereo channel is also broadcasting *SAP* (Second Audio Program). Details about stereo and *SAP* are on page 16.

Channels 90, 91, and 92 are used to see the signals coming from other devices like VCRs or camcorders that are connected to the *INPUT* jacks on the back of the TV.

- When you select channel 91, the words *INPUT 1* appear to let you know you are now watching whatever signal is coming in through the TV's *INPUT 1* jacks.
- When you select channel 92, the words *INPUT 2* appear to let you know you are now watching whatever signal is coming in through the TV's *INPUT 2* jacks.
- When you select channel 90, the word *S-VIDEO* appears to let you know you are now watching whatever signal is coming in through the TV's *S-VIDEO* connector.

Remote Control Operation

Before attempting to operate your remote control, install the batteries as shown here.

The remote control produces an invisible (infrared) beam that travels in a straight line much as the beam of a flashlight. For this reason, when operating the remote control, you must point it directly at the front of the TV without objects between that can block the infrared light beam.

Your remote control is designed to be very rugged and will withstand a considerable drop. If it receives an extreme blow, the case is designed to slightly separate at the seam rather than fracture. If this happens, simply squeeze the case where it separated until it snaps back together. The operation of the remote will probably not be affected.

Installing/Replacing Batteries

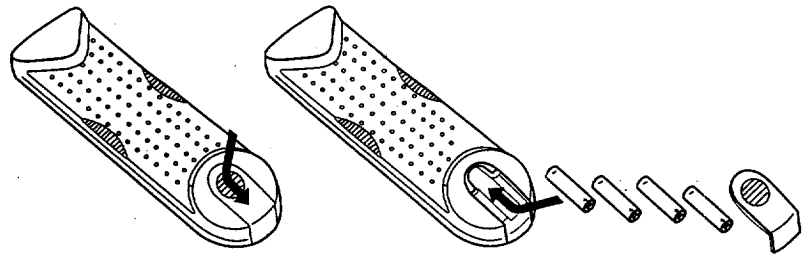

1. Turn the remote control face down.
2. Press down on the ridged area of the battery cover and slide it off.
3. Install four "AAA" batteries in the battery compartment as shown. Make sure you insert the negative (-) end of each battery first.
4. Replace the cover and turn remote over—face up.

Notes:

- Never place anything heavy on top of the remote control or lay it upside-down. This may accidentally depress the buttons for a long time and discharge the batteries.
- Replace the batteries when the TV fails to respond to the remote control.
- If you programmed your remote to control other components, you may have to reprogram the code numbers when you change the batteries. Try not to press any buttons while changing batteries.

Remote Control Operation (continued)

Basic Operation Theory

Step 1

First press one of these five component buttons to tell remote which component you want to control. You can program most of these buttons to control most brands of equipment.*

Step 2

Then press *POWER* button to turn on that component.

Note: The TV and some other components will automatically turn on when you press the component button in step 1. Press this button to turn the component off.

Step 3

These function buttons can now be used to control the basic functions of the component you selected in step 1. To control a different component, first press its component button (*VCR1*, *VCR2•LD*, *SAT•CABLE*, *AUDIO*, or *TV*), and then press the desired function button.

Note: Not all components have functions that can be controlled by these buttons, but you can experiment with your particular models to discover exactly which buttons will control it.

* The *TV* button automatically controls your TV – no additional programming is required. Details for programming the *VCR1* and *VCR2•LD* buttons to control other brands of VCRs are on page 38. Details for programming the *AUDIO* button to control audio equipment are on page 42. Details for programming the *SAT•CABLE* button to control cable boxes or an RCA satellite receiver are on page 33.

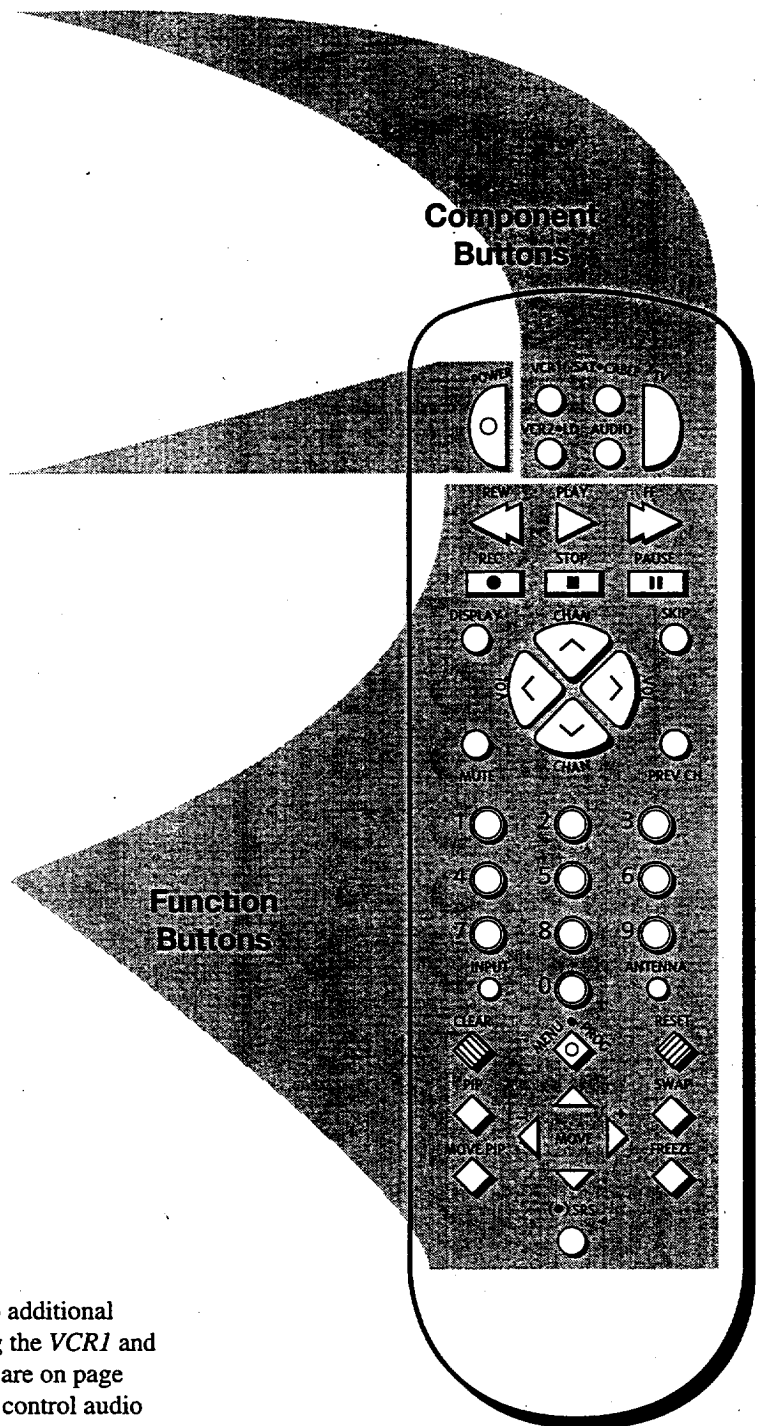

Remote Control Operation (continued)

Only the buttons that are used to control the TV are described here. The rest of the buttons are used to operate VCRs (pages 37-38), a satellite receiver or cable-TV boxes (page 33), and audio equipment (page 42).

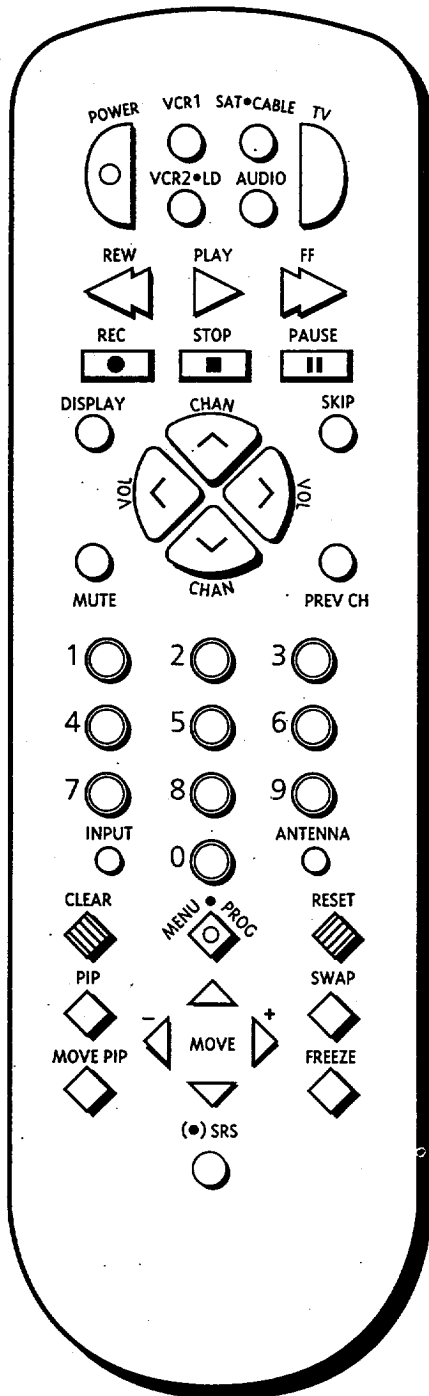

TV Button

- Turns on TV and puts remote in "TV Mode" so that the other remote buttons will control the TV.
- Displays time (if clock has been set) and channel number on the TV screen.

Important Note: Some buttons on the remote control will not control the TV unless the remote is in the "TV Mode". If another component button (such as *VCR2•LD*) is pressed, the remote will go into the "VCR Mode" and will control a compatible VCR. To get back into the "TV Mode", simply press the button labeled *TV*. The remote will go back into the "TV Mode" and will control the TV again.

POWER Button

- Press *POWER* to turn off TV.

CHAN Buttons

- Press *CHAN* up to select the next higher channel in channel memory.
- Press *CHAN* down to select the next lower channel in channel memory.
- You can add or erase channels in memory as desired. Details are on page 24.

VOL Buttons

- Press *VOL* up to increase volume.
- Press *VOL* down to decrease volume.

DISPLAY Button

- Displays time (if clock has been set) and channel number on the TV screen.
- Quickly removes menus and displays from the screen.

SKIP (Commercial Skip) Button

- Use this button when you want to scan other channels during a program break.
- When a break occurs, press *SKIP* once before changing channels. The TV will count down 30 seconds on the screen and then automatically switch channels back to the original channel.
- Press *SKIP* twice if you want the TV to count down 60 seconds. Each additional press will add another 30 seconds to the countdown time (up to five minutes) and then each additional press will add another 60 seconds to the countdown time (up to 60 minutes).
- To cancel, press *CLEAR*. The countdown clock will disappear from the screen, and the TV will stay tuned to the present channel.

Remote Control Operation (continued)

MUTE Button

- Press *MUTE* to quickly reduce sound to minimum level without affecting the picture. This is especially useful during telephone calls or other interruptions.
- When the sound is muted, the word *MUTE* will be displayed on the screen.
- To restore sound, press *MUTE* again or press *VOL up*.

PREV CH (Previous Channel) Button

- Pressing the *PREV CH* button causes the TV to change back to the last tuned channel. This is useful should you want to monitor two channels.
- To operate, select the first channel you wish to watch. Then select the other channel by pressing two number buttons (for example, press 0 then 6 for channel 6). The TV will now change back and forth between the two channels each time you press the *PREV CH* button.

Number Buttons (0-9)

- These buttons let you directly access any channel number—even if the channel is not in the channel memory.
- To select a channel, press two number buttons (first one, then the other). For example, press 0 then 6 for channel 6. Press 1 then 3 for channel 13.
- To select a 3-digit cable channel (like 127), press and hold number button 1 until 1-- appears on the screen. Then press the other two numbers.

Note: Your TV will tune up to channel 128. Check with your cable company to determine which channels are available in your area.

INPUT Button

- Lets you quickly view signals from the *INPUT* jacks. Pressing this button switches the TV from its current channel directly to channel 90, then channel 91, then channel 92.
- Channel 90 lets you see the signals coming from a device that is connected to the *S-VIDEO* connector. Channel 91 accesses the *INPUT 1* jacks and channel 92 accesses the *INPUT 2* jacks.

ANTENNA Button

- Because your TV has two different antenna inputs on the back (labeled *ANT A* and *ANT B*) you can connect more than one antenna or signal source. Press the *ANTENNA* button to switch from one input to the other.
- The color of the channel numbers on the screen indicates which antenna input you are watching. The channel numbers are blue for *ANT A* and yellow for *ANT B*. If the channel numbers are blue, you are watching whatever is connected to the *ANTENNA A* input on the back of your TV. If the channel numbers are yellow, you are watching whatever is connected to the *ANT B* input on the back of the TV. Details are on page 25.

CLEAR Button

- Pressing *CLEAR* clears the screen of all on-screen display messages except *MUTE* and *PARENTAL CONTROL*.

RESET Button

- Press *RESET* to return the picture adjustments to the original settings.

MENU•PROG Button and -/+ Buttons

- Press *MENU•PROG* repeatedly until the menu you want to display is selected, then press + or -. Next press *MENU•PROG* repeatedly to select the function you want to adjust and then press + or - to adjust the setting. Details about using each function begin on page 14.

Arrow Buttons

- Pressing the arrow -/+ buttons lets you adjust functions in the menu system.

Picture-in-Picture Buttons

- Press *PIP* to activate the picture-in-picture feature.
- Press *PIP* again to deactivate the picture-in-picture feature.
- Press *FREEZE* to freeze the small picture.
- Press *MOVE PIP* to move the small picture to the next corner.
- Press *SWAP* to switch the small picture with the large picture.
- Details are on pages 12-13.

SRS (●)* Button

- Press repeatedly to change settings of *SRS (●)* function (Sound Retrieval System).
- Details are on pages 16-17.

* SRS, Sound Retrieval System, and the SRS logo (●) are registered trademarks of SRS Labs, Inc.

Picture-in-Picture (PIP)

After you connect another video source (like a VCR) to your TV, you'll be able to display two different programs on the TV at the same time.

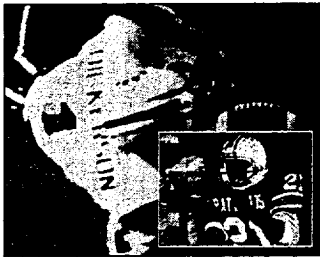

Two Football Games



Surveillance System

Starting Picture-in-Picture (PIP)

- 1 Connect another video source (such as a VCR or camcorder) to *INPUT 1* or *INPUT 2* on your TV (as shown on pages 35-36).
- 2 Turn on the TV and select a channel.
- 3 Press the *PIP* button on the remote. A little picture will appear on the screen. The little picture and the big picture will be the same.

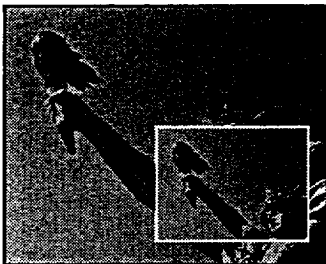

Note: The remote must be in the "TV mode" when you press the *PIP* button. To put remote in "TV mode", press the *TV* button.

- 4 To get a picture from the other source (VCR, camcorder, etc.), first turn on the other source, and then select TV channel 90, 91, or 92 (explained at top of next column). The picture from the other source will appear in the little picture.

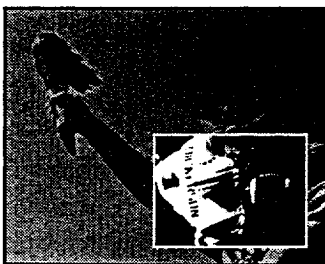

Picture from TV

Picture from VCR

- If the other source is connected to the TV's *INPUT 1* jacks, select TV channel 91 to see the signal. If you have programmed the *VCR1* (or *VCR2•LD*) button to automatically select channel 91 as described on page 26, press *VCR1* (or *VCR2•LD*).
- Select channel 92 if the other source is connected to the TV's *INPUT 2* jacks. If you have programmed the *VCR1* (or *VCR2•LD*) button to automatically select channel 92 as described on page 26, press *VCR1* (or *VCR2•LD*).
- Select channel 90 if the other source is connected to the TV's *S-VIDEO* connector. (Remember to also connect the regular video cable to the *VIDEO INPUT 1* jack for picture-in-picture viewing.). The TV automatically minimizes any annoying differences in tint between the small and large picture by electronically coupling the *S-VIDEO* input to the *INPUT 1* input. If you have programmed the *VCR1* (or *VCR2•LD*) button to automatically select channel 90 as described on page 26, press *VCR1* (or *VCR2•LD*).

Changing Channels (PIP)

To change channels on the picture from the TV, press the *TV* button on the remote, and then press either the *CHAN* up or down button or two number buttons.

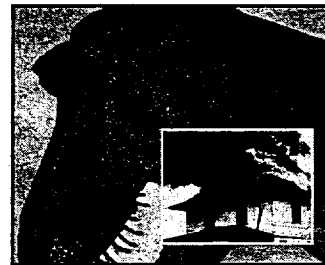

Picture from TV

To change channels on the picture coming from the VCR, press the *VCR1* or *VCR2•LD* button (if you've programmed one of these buttons to control the VCR as described on page 38) and then press either the *CHAN* up or down button or two number buttons. You can also change the VCR's picture by pressing the *CHAN* buttons on the front of the VCR.

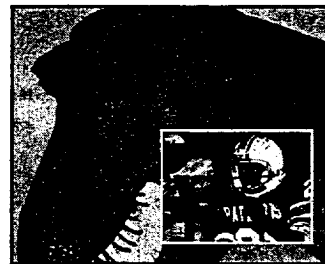

Picture from VCR





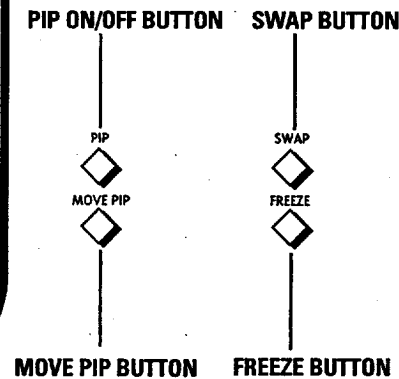
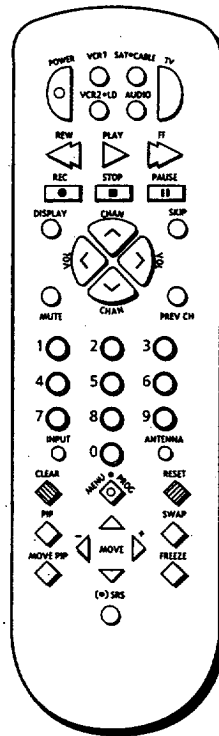

Additional Features (PIP)

Whenever the picture-in-picture feature is activated, the small picture can be moved, frozen, or switched with the main picture as desired. *Details are on the next page.*

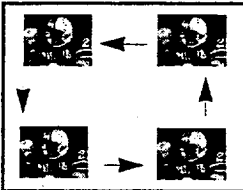
Picture-in-Picture (continued)

Whenever you have the picture-in-picture (PIP) feature activated as described on the previous page, you can move, freeze, or switch the big and little pictures as desired.



PIP Buttons	What they do when TV is in PIP mode	
<p>MOVE PIP</p> 		<p>Press and release <i>MOVE PIP</i> to move the small picture to the next corner.</p>
<p>SWAP</p> 		<p>Press <i>SWAP</i> to switch the small picture with the main picture.</p>
<p>FREEZE</p> 		<p>Press <i>FREEZE</i> to freeze the small picture. Press <i>FREEZE</i> again to return to an action picture.</p>
<p>PIP</p> 		<p>Pressing the <i>PIP</i> button will cancel <i>PIP</i> and remove the little picture from the screen.</p>

VIDEO MENU - General Instructions

1. Repeatedly press **MENU•PROG** to select **VIDEO MENU** and then press **+** or **-** to display the video menu.

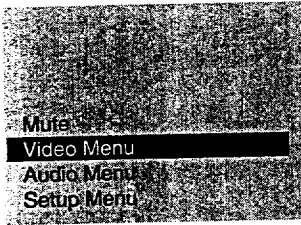

2. Repeatedly press **MENU•PROG** to select function, then press **+** or **-** to adjust it.

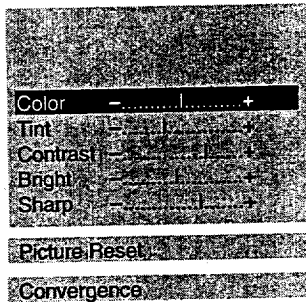

The **COLOR** function adjusts the amount of color in the picture. Press **+** to increase color or press **-** to decrease color.

The **TINT** function adjusts the color of flesh tones. Press **+** to add more red tint, or press **-** to add more green tint.

The **CONTRAST** function adjusts the overall brightness and contrast of the picture. Press **+** to increase contrast, or press **-** to decrease contrast.

The **BRIGHTNESS** function adjusts the brightness of the dark portions of the picture. Press **+** to increase brightness, or press **-** to decrease brightness.

The **SHARPNESS** function adjusts picture sharpness. Press **+** to increase sharpness, or press **-** to decrease sharpness.

The **PICTURE RESET** function lets you quickly change all the video functions (shown above) back to the factory settings. Press either **+** or **-** to reset the video functions.

The **CONVERGENCE** function allows you to precisely align the beams of the three projection picture tubes (red, green, blue) for optimum picture detail. Press the **+** button to display the pattern and **VOL** up or down to align the colors. See next page for details.

The video menu will automatically disappear from the screen if you do not press **+** or **-** within a few seconds.

Via remote control, your TV will "remember" which function you displayed last—even after the menu has disappeared from the screen. So, if you want to adjust the same function again, simply press the **+** or **-** button on the remote control. The last function you adjusted will reappear on the TV screen.

CAUTION Take extreme caution if you plan to display video games or computer screens on your TV. If a fixed (non-moving) pattern is left on the screen for several hours, the image can be permanently imprinted onto the screen. For this reason, we do not recommend connecting video games, computers, or similar devices to your TV. Keeping the TV's **BRIGHTNESS** and **CONTRAST** functions at low settings will help delay the imprinting but it is often too easy for someone in your family to leave the pattern displayed too long and imprint the screen. These types of imprints are not covered by your warranty because they are the result of misuse.

Adjusting for a Color Picture that Pleases You

1. Decrease color to minimum. This will leave a black-and-white image on the screen.
2. Adjust contrast until the picture pleases you.
3. Adjust brightness until the black parts of the picture appear black. You may need to wait until the picture shows something you're sure is black to make this adjustment. Be careful not to lose the details in darkly shaded areas.
4. Increase color until you reach a pleasing level of intensity.
5. Adjust tint until flesh tones or other color objects appear natural.
6. Adjust sharpness for a pleasing level of picture sharpness. (For weak signals, the picture may be more pleasing with sharpness decreased.)

Custom Picture Memory for Input Channels

The channel numbers you select to see signals from components (like a VCR) that are connected to the **INPUT** jacks on the back of the TV are called input channels. Selecting channel 90 lets you see the signal coming from whatever component is attached to the **S-VIDEO** connector, channel 91 lets you see the signal from the **INPUT 1** jacks, and channel 92 lets you see the signal from the **INPUT 2** jacks. Your TV is equipped with a custom picture memory for these input channels. When the TV is tuned to one of these channels (90, 91, 92), you can change the picture settings for that component's signal as desired without changing the settings of any other channel. This is very useful because you'll be able to adjust for the best picture from each of your components and the TV will remember those settings automatically the next time you tune that input channel.

Color Convergence Adjustments

Your projection TV has three color projection tubes—one for red, one for green, and one for blue. When mixed together in the proper proportion, the output of these three color tubes can produce many colors. To produce these colors, however, the beams must be precisely aligned over each other so that the colors can be mixed. The process of aligning these picture beams is called setting the “convergence”.

Over a period of time, the picture tubes can drift out of alignment due to normal bumps and vibrations or moving the TV. If you move your TV or if, after a time, you notice colored rings or halos around objects in the picture, you may want to converge (align) the colors.

To simplify convergence, an on-screen menu is provided that allows you to display a test pattern of four lines on the screen. Properly converged, the lines appear white—which is actually a combination of the outputs of the three color tubes. The position of the green lines is stationary. The positions of the red and blue lines are adjustable. When properly adjusted, the red and blue lines should lie directly over the green lines to produce single white lines.

Converging (Aligning) the Colors

(with remote only)

1. Turn on the TV and select a channel that is active in your area. Allow the TV to operate at least ten minutes before converging.
2. Repeatedly press the *VIDEO* button until the *CONVERGENCE* function is selected.



3. Then press the + button to display the pattern.

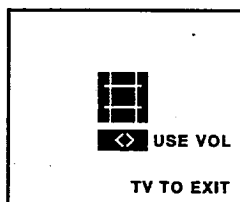

4. When properly converged, all three colors in the pattern (red, blue, and green) should align to form white lines. If you see any red or blue lines in the pattern, you can move them to align with the green lines by pressing the *VOL* up or down button.

5. Press the + button to select the arrow color and direction, then press the *VOL* up or down button to move the lines.

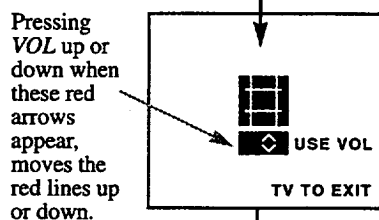
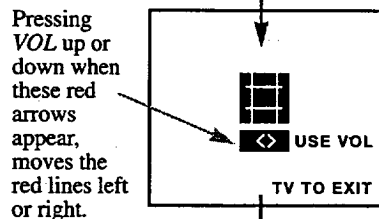
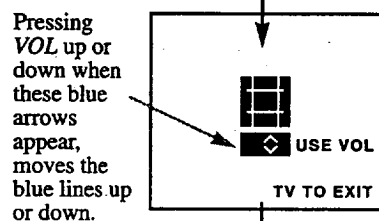
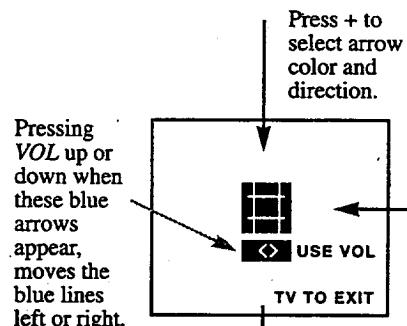

Note: You can also press the - button to return to a previous screen. Pressing - displays the arrows in reverse order than shown above.

6. When finished, press the *TV* button to remove the pattern from the screen.

AUDIO MENU - General Instructions

1. Repeatedly press **MENU•PROG** to select **AUDIO MENU** and then press **+** or **-** to display the audio menu.

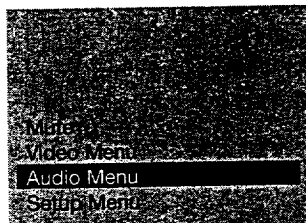

2. Repeatedly press **MENU•PROG** to select function, then press **+** or **-** to adjust it.

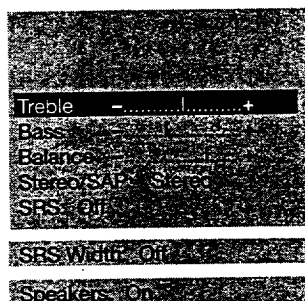

The **TREBLE** function adjusts the high frequency audio. Press **+** to increase treble or press **-** to decrease treble.

The **BASS** function adjusts the low frequency audio. Press **+** to increase bass, or press **-** to decrease bass.

The **BALANCE** function adjusts the left/right balance of sound from the speakers. When adjusting the **BALANCE** function, sit in your normal viewing seat while pressing the **+** and **-** buttons until the sound seems to originate from a point halfway between the speakers. Press **+** to increase sound from the right speaker, or press **-** to increase sound from the left speaker.

The **STEREO/SAP** function lets you choose either **MONO** (monaural), **STEREO**, or **SAP** audio (if available) by pressing **+** or **-**. When a station is broadcasting stereo and the **STEREO/SAP** function is set to **STEREO**, the stereo indicator (**STEREO**) will appear on the screen before the channel number. Normally you can leave the **STEREO/SAP** function set to **STEREO** and your TV will then automatically reproduce either monaural or stereo audio—whichever is broadcast. Some TV stations that broadcast stereo also broadcast another sound channel called **SAP** (Second Audio Program) which is sometimes used to offer the program in another language. Your TV lets you know when **SAP** audio is available by displaying an asterisk (*) on the screen after the stereo indicator like this (**STEREO***). If you want to listen to the **SAP** channel when the asterisk appears, change the **STEREO/SAP** function to its **SAP** setting. The **SAP** setting will only appear in the function when **SAP** is available. Your TV will then reproduce the **SAP** audio until you change channels or return the **STEREO/SAP** function back to **STEREO**.

Note: Some TV stations transmit a “pilot” signal that makes your TV think it’s receiving stereo, even though the broadcast signal is monaural. The pilot signal will make the stereo indicator (**STEREO**) appear on the screen next to the channel number, however, you will not be able to hear stereo sound. If this happens, check with the TV station to inquire whether the program being broadcast is in true stereo or monaural audio.

The **SRS: ON/OFF** function lets you add greater depth and dimension to stereo broadcasts. You can turn this function on and off as desired by pressing **+** or **-** to change the setting between **ON** and **OFF**. You may prefer to leave this function set to **ON**. Your TV will then automatically process the stereo signals whenever a stereo broadcast is received (or whenever a stereo tape is played through a stereo VCR that is connected to the TV’s audio/video jacks labeled **INPUT**). Details are on page 17.

The **SRS WIDTH** function lets you enhance the perceived audio separation that occurs when the above **SRS** function is **ON**. Pressing **+** or **-** changes the setting between **NORMAL** and **ENHANCE**. Details are on page 17.

The **SPEAKERS** function lets you turn off the TV’s internal speakers by pressing **+** or **-** to change the setting between **ON** and **OFF**. You will probably want to leave the TV’s speakers turned on unless you connect an amplifier (with its own set of speakers) to the appropriate jacks on the back of the TV as described on page 43.

The audio menu will automatically disappear from the screen if you do not press **+** or **-** within a few seconds.

Via remote control, your TV will “remember” which function you displayed last—even after the menu has disappeared from the screen. So, if you want to adjust the same function again, simply press the **+** or **-** button on the remote control. The last function you adjusted will reappear on the TV screen.

Sound Retrieval System – SRS (●)

Your TV includes a feature called SRS (●)* (Sound Retrieval System) which brings dimensional realism to both stereo and mono broadcasts.

When the SRS ON/OFF function is set to ON and the STEREO/SAP function is set to STEREO, your TV electronically increases the audio separation of the speakers so you can perceive a more spacious stereo sound effect. If a stereo signal is not present, you can set the SRS ON/OFF function to its SYNTH STEREO setting to synthesize and process the mono signal.

When the SRS ON/OFF function is set to ON, you can also change the next menu item called SRS WIDTH between NORMAL or ENHANCED. When this function is set to ENHANCED, the perceived audio separation will be greater. Try both settings and select the one you prefer for your room acoustics.

Note: Some material (audio) will be more affected than others.

SRS (●) allows you to hear multiple sound sources. Audio frequencies are processed to establish directional cues which gives the impression that sound is coming from all parts of the room. External speakers are not required, but the addition of high quality external speakers optimizes the sound performance of your TV.

* SRS, Sound Retrieval System, and the SRS logo (●) are registered trademarks of SRS Labs, Inc.

Turning On SRS (●)

1. Repeatedly press the MENU•PROG button to select AUDIO MENU, press +, and then repeatedly press MENU•PROG again to select SRS ON/OFF function.

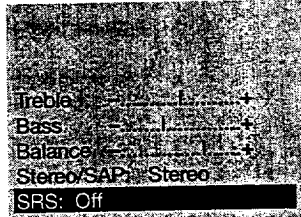

Note: You can also change the SRS ON/OFF function between ON and OFF without going through the menu by pressing the SRS button on the remote.

2. Repeatedly press the + button to change the setting between OFF, ON, and SYNTH STEREO.

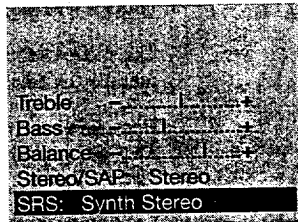
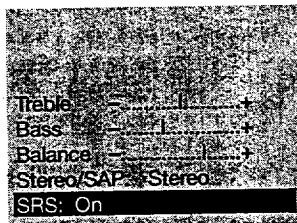

- If the broadcast you are receiving is stereo audio, select ON. The STEREO/SAP function must be set to STEREO before you can hear SRS (●) sound with this setting.
- If the broadcast you are receiving is mono audio, select SYNTH STEREO.
- If you do not want SRS (●), select OFF.

3. Press MENU•PROG button to select next menu item called SRS WIDTH. Pressing + or – will change the setting between NORMAL and ENHANCED. Try both settings and select the one you prefer.

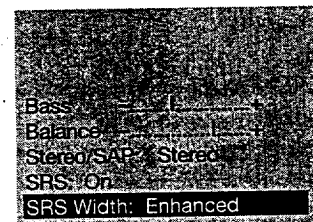
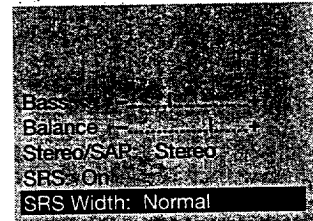

Note: After turning SRS or synthetic stereo on, you may find it desirable to readjust the VOLUME, BASS, and TREBLE controls to optimize the sound. The SRS effect, tonal balance, and volume level will vary from channel to channel depending on the production qualities of the program material.

SETUP MENU – General Instructions

1. Repeatedly press **MENU•PROG** to select **SETUP MENU** and then press + or – to display the setup menu.

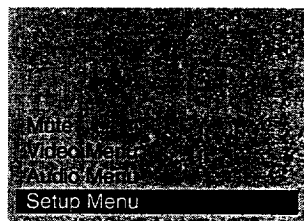

2. Repeatedly press **MENU•PROG** to select function, then press + or – to adjust it.

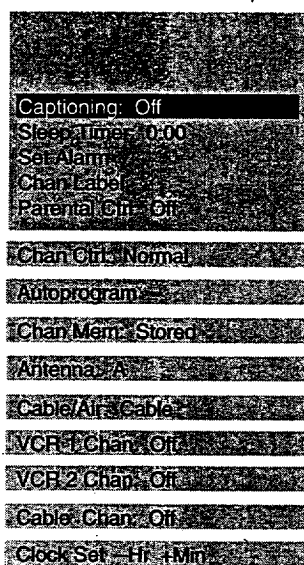

The setup menu will automatically disappear from the screen if you do not press + or – within a few seconds.

Via remote control, your TV will “remember” which function you displayed last—even after the menu has disappeared from the screen. So, if you want to adjust the same function again, simply press the + or – button on the remote control. The last function you adjusted will appear on the TV screen.

The **CAPTIONING** feature lets you display as text on the screen the audio portion of certain programs encoded with the Closed Captioning (CC) information. Two types of closed captioning are available: Captions 1 and Captions 2. Select Captions 1 for full translation of the primary language in your area. Captions 2 is used for an alternate service, such as secondary language translation or simplified English. Two Text modes are also supported.

By setting the **SLEEP TIMER**, you can program your TV to turn itself off after a certain period of time. This is useful whenever you want to watch TV for an hour or so before going to sleep. Press the + or – button to select the length of time you want the TV to stay on.

You can program your TV to turn on and/or off at the times you choose by setting the **ALARM** function.

CHAN LABEL lets you program names (or labels) for the channel numbers. The names you select will then appear on the screen whenever the channel number is displayed.

The **PARENTAL CONTROL** feature lets you lock out any channels between 1 and 99 that you don't want your children to watch. Pressing + or – switches this function from **OFF** to **ON**. When this function is set to **ON**, channels that have been locked out with the **CHAN CTRL** function cannot be viewed. When this function is set to **OFF**, all channels can be viewed.

The **CHAN CTRL** (Channel Control) function works hand-in-hand with the **PARENTAL CONTROL** function. It lets you select the channels you want to lock out. First select the channel number you want to lock out and then press + to change this function from **NORMAL** to **LOCKED**. When the **PARENTAL CONTROL** function is set to **ON**, the channels you locked with this function cannot be viewed.

When you press + or – to start the **AUTOPROGRAM** function, the TV will automatically cycle through all channels and place the active channels for your area in its channel memory. Pressing the **CHANNEL** up or down buttons will then allow you to scan only active channels.

The **CHAN MEM** function allows you to erase and add channels to channel memory as desired.

Because your TV has two separate antenna inputs on the back labeled **ANT A** and **ANT B**, you can connect two different signal sources, if desired. By pressing + to change the **ANTENNA** function, you can switch back and forth between the two signal sources. Each time you press +, the antenna input will change.

The **CABLE/AIR** function tells your TV whether you have a cable-TV system or a home antenna connected to the TV. Your TV is so automatic that you will probably never need to change this function. When your TV autoprograms, it automatically adjusts the **CABLE/AIR** setting for you. If you should ever need to override the automatic setting, press + or – to change it.

The **VCR 1 CHAN** function lets you program to which channel the TV will automatically tune when you press the **VCR 1** button on the remote.

The **VCR 2 CHAN** function lets you program to which channel the TV will automatically tune when you press the **VCR 2** button on the remote.

The **CABLE CHAN** function lets you program to which channel the TV will automatically tune when you press the **DSS•CABLE** button on the remote.

After you set the clock, you will be able to see the on-screen time display whenever you change channels or press the **DISPLAY** or **TV** button on the remote control. To set the clock when this function is selected, first press and hold – to set the correct hour (including AM and PM). Then press and hold + to set the correct minutes.

Setting Closed Captioning

The **CAPTIONING** feature lets you display the audio portion of a program as text on the TV screen. This is useful to the hearing impaired or anyone who wants to watch a program without the sound.

There are four types of closed captioning transmissions available: *Captions 1*, *Captions 2*, *Text 1* and *Text 2*. *Captions 1* displays the full translation of the primary language in your area. *Captions 2* may be used as a second source for secondary languages, simplified English, or other translations transmitted in your area.

The Text modes, *Text 1* and *Text 2*, display on-screen boxes containing the text of general information not necessarily related to the program being watched.

Note: Closed Captioning is not available on all channels or at all times. Only specific programs encoded with Closed Captioning information (CC) are applicable.

When *Captions 1* is available, the word "Captioned" appears on the screen when you change channels or press the **TV** or **DISPLAY** button on the remote. The word "Captioned" does not appear to tell you if *Captions 2* or either Text mode is available.

Setting Closed Captioning (with or without remote)

1. Repeatedly press **MENU•PROG** to select **SETUP MENU**, and then press **+** or **-** to display setup functions. **CAPTIONING** will be highlighted since it is the first function in the setup menu.

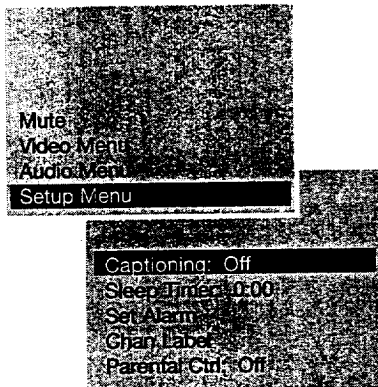

4. The screen will begin to display the TV program's audio portion as text if the program has captioning.

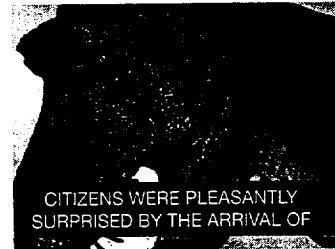

2. Press the **+** or **-** button to select the type of closed captioning: Off, Captions 1, Captions 2, Text 1 or Text 2.

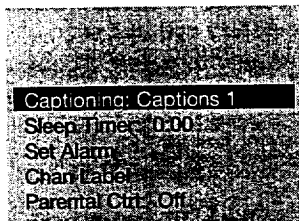

3. When finished, the display will automatically disappear from the screen in a few seconds. To make it disappear more quickly, press the **CLEAR** button.

Turning Captioning Off

To turn off the closed captioning feature, enter the **CAPTIONING** function and press the **+** or **-** button until the screen shows "Off."

Setting the Sleep Timer

By setting the Sleep Timer, you can program your TV to turn itself off after a certain period of time (up to four hours).

This is useful whenever you want to watch TV for an hour or so before going to sleep.

Setting Sleep Timer (with or without remote)

1. Repeatedly press *MENU•PROG* to select *SETUP MENU*, and then press + or – to display setup functions. Press *MENU•PROG* to select *SLEEP TIMER*.

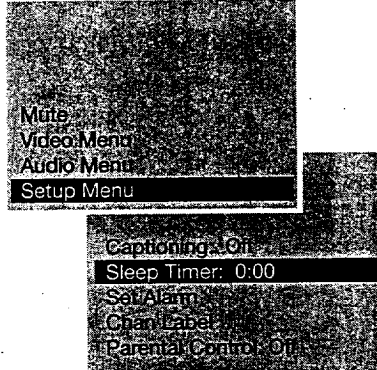

2. Press the + or – button to select the length of time (up to four hours) you want the TV to stay on.

Each time you press the + or – button, the time will increase 30 minutes (up to 4 hours). Then the time display will start over.

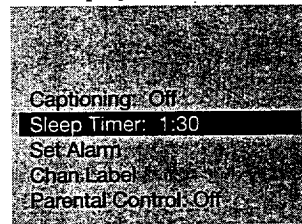

3. When finished, the display will automatically disappear from the screen in a few seconds. To make it disappear more quickly, press the *CLEAR* button.

4. The sleep timer will begin to count down to zero. The word “*SLEEP*” will appear on the screen whenever you change channels or press the remote’s *TV* or *DISPLAY* button to let you know the sleep timer is activated.

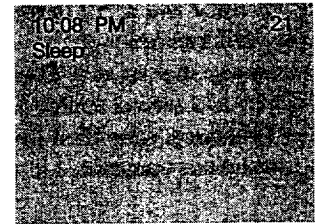

The amount of time remaining before the TV shuts itself off will appear in the sleep timer menu whenever you display the *SLEEP TIMER* function.

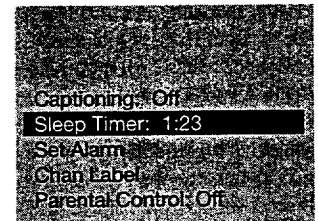

1 hour
and
23 minutes
remaining

5. When the sleep timer counts down to 0:00, the sleep timer display will appear on the screen for a few seconds. Then the TV will turn itself off.

If you want the TV to stay on when this display appears, press the + button on the remote to add more time to the *SLEEP TIMER* display.

Clearing Sleep Timer

To cancel the sleep timer, enter the *SLEEP TIMER* function and then press the + or – button until the screen shows 0:00.

Setting the Alarm

By setting the alarm, you can program the TV to turn on and/or off by itself.

After the *ON TIME* is set and the *ALARM ON/OFF* function is set to *ON*, the TV will automatically turn on each day at the time you selected and remain on until the *OFF TIME* is reached. If no *OFF TIME* has been programmed, the TV will remain on until you turn it off.

The *ALARM ON/OFF* function lets you easily deactivate or reactivate the alarm without having to reset the *ON TIME* and *OFF TIME*.

When the alarm time is reached, the set will turn on at whatever volume you left it when you last turned it off. So if you want the TV to come on loudly at the *ON TIME*, be sure the TV is playing loudly when you turn off the TV for the last time.

When the *ALARM ON/OFF* function displays *SET CLOCK*, you will need to set the clock time before you will be able to turn on the alarm function. Details for setting the clock are on page 4.

IMPORTANT NOTE: During extended power failures the alarm function will be disabled. The alarm *ON TIME* and *OFF TIME* will stay set but the *ALARM ON/OFF* function will be set to *OFF* and will display *SET CLOCK* to inform you that the clock must be reset to the correct time. Once the clock has been reset you can reactivate the *ALARM* function by changing the *ALARM* function to *ON*.

Setting the Alarm

1. Repeatedly press *MENU•PROG* to select *SETUP MENU*, and then press + or – to display setup functions. Press *MENU•PROG* to select *SET ALARM* function, and then press + or – to display the alarm settings.

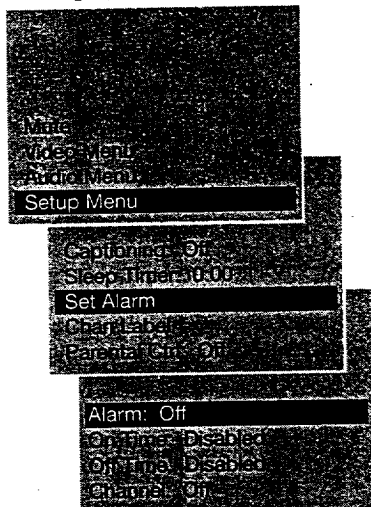

2. When the first *ALARM* function is selected, pressing + or – will switch the setting between *ON* and *OFF*. Set this function to *ON* if you want to activate the alarm. When this function is set to *OFF*, the alarm is deactivated and the TV will not turn on or off by itself.

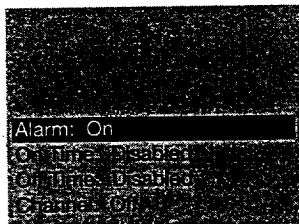

Note: If *SET CLOCK* is displayed next to *ALARM*, you will need to set the clock time before you will be able to turn on the alarm function. Details for setting the clock are on page 3.

3. Press *MENU•PROG* to select the next function called *ON TIME*. If you want the TV to turn on by itself, enter the desired time by first pressing – to select the hour (including AM and PM) and then pressing + to select the minutes. If you only want the TV

to turn off by itself and not turn on, you can disable the *ON TIME* by pressing – until the word *DISABLED* appears.

Note: Remember to check the AM/PM setting. Midnight is 12:00 AM and noon is 12:00 PM.

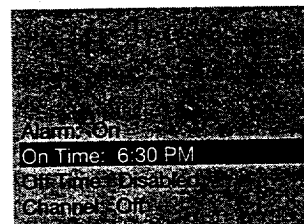

4. Press *MENU•PROG* to select the next function called *OFF TIME*. If you want the TV to turn off by itself, enter the desired time by first pressing – to select the hour (including AM and PM) and then pressing + to select the minutes. If you only want the TV to turn on by itself and not turn off, you can disable the *OFF TIME* by pressing – until the word *DISABLED* appears.

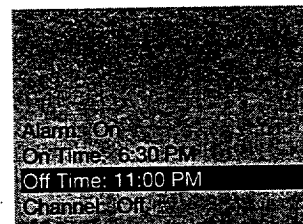

5. Press *MENU•PROG* to select the next function called *CHANNEL*. This function lets you program which channel the TV will tune when it turns on at the *ON TIME*. Press *CHAN* up or down to select the channel, and then press + or – to enter it into the *CHANNEL* function.

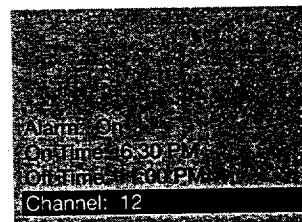

Note: The TV will change to the channel that you select. This will help you to confirm that it is indeed the channel you want the TV to turn on to.

Labeling Channels

The labeling feature lets you program names (or labels) for the channel numbers. The name you program will then appear on the screen below the channel number whenever the channel number is displayed.

Each name can contain up to four characters, and you'll be able to assign up to 64 names. After 64 names or labels have been entered, the TV will display this message to let you know no more channels can be labeled: *CHAN LABEL: FULL*.

Listed below are the letters and characters from which you'll be able to choose when programming the channel labels:

A B C D E F G H I J K L M
 N O P Q R S T U V W X Y Z
 (blank space) ! " # \$ % & ' ()
 á + , - . / 0 1 2 3 4 5 6 7 8 9 : ;
 < = > ? @

You must use your remote control to create or erase labels.

Labeling Channels (with remote only)

1. Repeatedly press *MENU•PROG* to select *SETUP MENU*, and then press + or - to display setup functions. Repeatedly press *MENU•PROG* to select *CHAN LABEL* function.

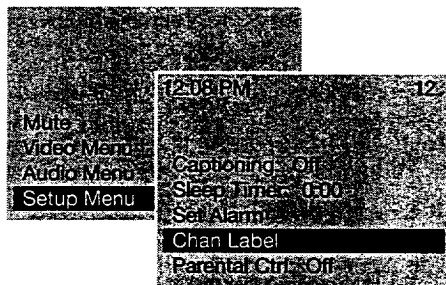

2. Press + to enter the *CHAN LABEL* function. Four blank letter frames will appear under the channel number.

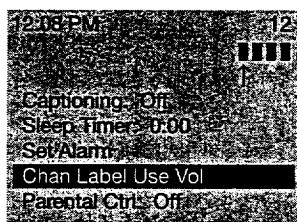

3. Select the channel number you want to label by pressing the *CHAN* up or down button (or by pressing two number buttons).

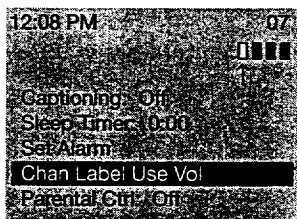

4. Press and hold the *VOL* up or down button until the letter or character you want appears on the screen. Pressing *VOL* up sequences through the characters in alphabetical order. Pressing *VOL* down sequences the letters in reverse order.

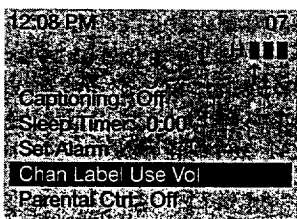

5. Then press + to move to the next letter frame. Pressing - moves you back to the previous letter frame.

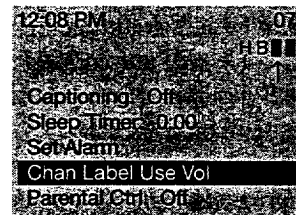

6. Repeat steps 4 and 5 until the name is complete. You can now label another channel, if desired, by selecting the channel number and repeating steps 4 and 5.

7. When finished, the display will automatically disappear from the screen in a few seconds. Your labels will remain in memory until you erase them. They are not affected by power failures.

Erasing Labels

To erase a channel label, first follow steps 1, 2, and 3 above, and then press *CLEAR* on the remote control.

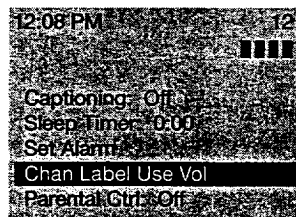

Note: Autoprogramming new channels into the channel memory does not affect the channel labels that are already entered.

Parental Control

The *PARENTAL CTRL* and *CHAN CTRL* functions let you lock any channels you choose so they cannot be viewed by your children.

Channels that have been locked can be viewed only when the *PARENTAL CTRL* function is set to *OFF*. This can only be done with the remote control—it can not be changed with the buttons on the front of the TV. Therefore, after you turn on *PARENTAL CTRL*, you simply hide the remote control so that your children can not watch the locked channels. An optional simplified remote (shown on page 45) is also available that your children can use. The simplified remote does not allow access to the locked channels.

The locked-out channels will remain unviewable even if the TV is unplugged or the channels are autoprogrammed again. The only way to view locked channels is to use the supplied remote control to set the *PARENTAL CTRL* function to *OFF*.

Note: Channels above 99 cannot be locked.

Activating Parental Control (with remote only)

The *PARENTAL CTRL* and the *CHAN CTRL* functions work hand-in-hand. The instructions below will first tell you how to turn parental control on or off with the *PARENTAL CTRL* function and then how to lock desired channels with the *CHAN CTRL* function.

1. Repeatedly press *MENU•PROG* to select *SETUP MENU*, and then press + or – to display setup functions. Repeatedly press *MENU•PROG* to select the *PARENTAL CTRL* function.

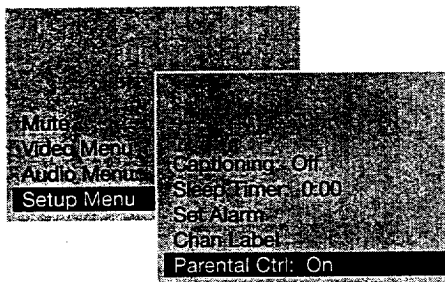

- When this function is set to *ON*, *PARENTAL CTRL* is activated and any channels you locked with the *CHAN CTRL* function will not be viewable.
- When this function is set to *OFF*, *PARENTAL CTRL* is deactivated and all channels are viewable.

2. To lock channels, press the *MENU•PROG* button to select the *CHAN CTRL* function.

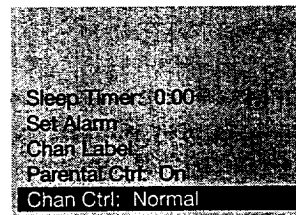

Select a channel you want to lock by pressing *CHAN* up or down. Then press +. The *CHAN CTRL* setting will change from *NORMAL* to *LOCKED* when that channel is locked. To return the channel to *NORMAL*, press the – button.

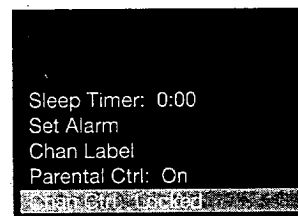

Repeat step 2 for each channel you want to lock.

If the *PARENTAL CTRL* function is set to *ON* while you are locking out channels, each channel will go blank as you lock it.

When the *PARENTAL CTRL* function is set to *ON* and a channel which has been locked out is tuned, the TV will display the words - *PARENTAL CONTROL* to let your kids know you have locked it.

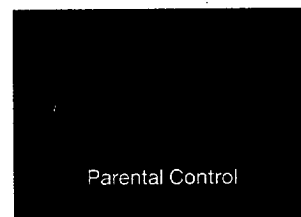

Programming Channel Memory

The channel memory is the list of TV channel numbers your TV will stop on when you press the *CHAN* up or down button. You can program any list of channels into the channel memory.

The quickest way to program your channel memory is to use the *AUTOPROGRAM* function. If you use the *AUTOPROGRAM* function, your TV will automatically cycle through all channels and place active channels into the channel memory.

First follow the instructions to autoprogram channels, and then add or erase individual channels as desired.

Notes:

- The AutoProgram feature will place into memory active TV channels that have a valid signal at the time you autoprogram your TV.
- An active channel may be missed occasionally if its signal is very weak or if the channel happens to be "off the air" when the TV is autoprogrammed.
- An inactive channel may be included in the channel memory if there happens to be some sort of "noise" or "stray signal" on the channel when the TV is autoprogrammed.
- Signals from other components connected to the *INPUT* jacks can not be autoprogrammed. Channel 91 (which accesses *INPUT 1* jacks) was added to the channel memory at the factory and will remain in the channel memory until you erase it. Channel 92 (*INPUT 2*) and Channel 90 (*S-VIDEO* connector) can be added to channel memory if desired.
- Only channels 1-99 can be stored in channel memory.

1. AutoProgramming Channels into Channel Memory (with or without remote)

1. Connect home antenna(s) or cable-TV to your set.
2. After you have turned on the TV and adjusted the volume, repeatedly press *MENU•PROG* to select *SETUP MENU*, and then press + or - to display the setup functions. Repeatedly press *MENU•PROG* to select the *AUTOPROGRAM* function.
3. Press either + or - to begin autoprogramming. The TV will first program all channels for *ANT A* input and then program all channels for *ANT B* input (even if you only have one antenna input connected).

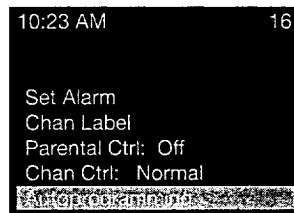
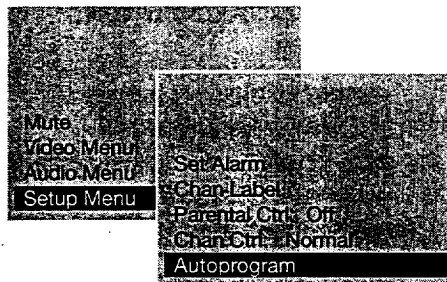

4. When the TV is finished cycling, you can check to see which channels are in memory by pressing the *CHAN* up or down button.

2. Erasing/Adding Channels in Channel Memory (with or without remote)

1. To erase or add a channel, repeatedly press *MENU•PROG* to select *SETUP MENU*, and then press + or - to display the setup functions. Repeatedly press *MENU•PROG* to select *CHAN MEM* function.
2. Then select the desired channel number by pressing *CHAN* up or down (or the two corresponding number buttons on the remote).
3. Press + to add the channel to memory, or press - to erase the channel from memory.

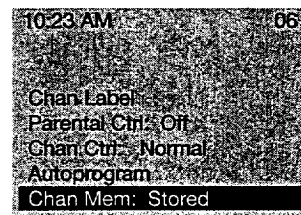
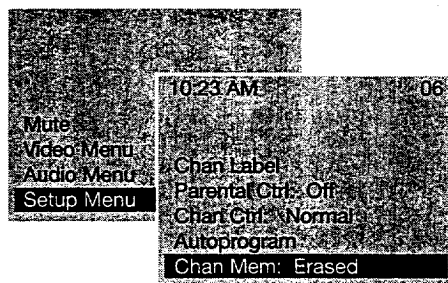

3. Adding Video Input Channels to Channel Memory (with remote)

If you have a video device connected to the *S-VIDEO* or *INPUT* jacks on the back of the TV, you can view its signal either by directly selecting channel 90 (for *S-VIDEO* connector), channel 91 (for *INPUT 1* jacks), or channel 92 (for *INPUT 2* jacks) with the number buttons on the remote or by adding those channels to the channel memory.

Adding channels 90, 91, and 92 to channel memory allows access to the video inputs at the TV by pressing the *CHAN* up and down buttons as well as by using the remote control.

Changing Antenna Input

Your TV has two separate antenna inputs on the back (labeled *ANT A* and *ANT B*) that allow you to connect two different signal sources if desired. For example, you can connect a cable-TV system to one input and a home antenna to the other input.

By changing the *ANTENNA: A/B* display in the *SETUP* menu, you can switch back and forth between the two signal sources.

Listed below are some other common uses of the two antenna inputs:

- connecting a cable-TV system (or antenna) to one input and a VCR to the other.
- connecting a cable-TV system (or antenna) to one input and a video game to the other.
- connecting a double-trunk cable system to both inputs.
- connecting a cable-TV converter/decoder box that scrambles only premium channels. Connection details are on pages 31-32.
- connecting a cable-TV system to one input and an antenna (VHF/UHF) to the other. This allows you to tune in local stations that are not included on your cable system. Remember to change the *CABLE/AIR* function as described on page 18 if using your set like this.

The Channel Memory is the list of channels your TV will stop on when you press the *CHAN* up or down buttons. Your TV provides two separate Channel Memories—one for *ANT A* input and one for *ANT B* input. This allows you to add or delete channels into each channel memory as desired.

When you use the *AUTOPROGRAM* function, the TV automatically checks both inputs and sets up a separate channel memory for each.

Changing Antenna Input

(with remote)

1. Press the *ANTENNA* button on the remote control to switch from the *ANT A* input to the *ANT B* input. The color of the channel numbers will change from blue to yellow to let you know you are now watching whatever signal is connected to the *ANT B* jack on the back of the TV.

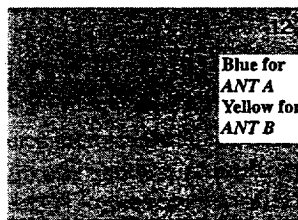

2. Press the *ANTENNA* button again to switch back to *ANT A*. The color of the channel numbers will change back to blue to let you know you are now watching whatever signal source is connected to the *ANT A* jack.

(without remote)

1. Repeatedly press *MENU* to select *SETUP MENU* and then press + or - to display setup functions. Repeatedly press *Menu* to select *ANTENNA: A/B* function.

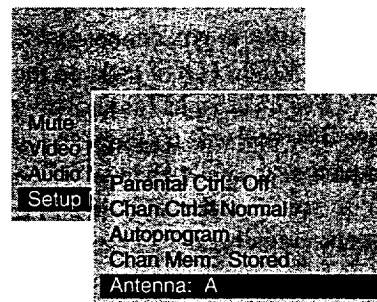

2. Press the - or + button to change the setting. The screen display will change from A to B to let you know you are now watching whatever signal is connected to the *ANT B* jack on the back of the TV. The color of the channel numbers will change from blue to yellow.

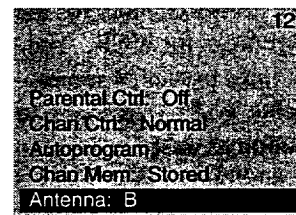

3. Press the - or + button again to switch back to *ANT A*. The screen display will change back to *ANTENNA: A* to let you know you are now watching whatever signal source is connected to the *ANT A* jack on the back of the TV.

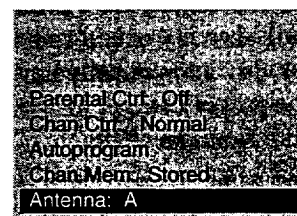

Setting Up VCR Channels

The *VCR 1 CHAN* function lets you program to which channel the TV will automatically tune when you press the *VCR1* button on the remote. This is handy if you connect a VCR to your TV. You will no longer have to remember to which input jacks the VCR is connected because the TV will remember for you.

For example, if you connect a VCR's *AUDIO/VIDEO OUT* jacks to the TV's *INPUT 1* jacks (as shown on page 35), you will no longer have to remember to select channel 91 on the TV to see what the VCR is playing. By entering channel 91 next to the *VCR 1 CHAN* function, the TV will automatically tune to channel 91 each time you press the *VCR1* button on the remote.

This function is especially convenient if you have a compatible VCR that can be operated by the *VCR1* button on the remote. Pressing *VCR1* will then not only turn on the VCR but also automatically tune the TV to the proper channel for viewing the picture from the VCR. You can program most brands of remote-controllable VCRs to respond to the *VCR1* button as described on page 38.

The *VCR 2 CHAN* function works the same way. It lets you program to which channel the TV will automatically tune when you press the *VCR2•LD* button on the remote. You can program most brands of remote-controllable VCRs to respond to the *VCR2•LD* button as described on page 38. Pressing the *VCR2•LD* button will then not only turn on the VCR but also automatically tune the TV to the proper channel for viewing the picture from the VCR.

Note: Pressing the *VCR1* or *VCR2•LD* button does not change between *ANT A* and *ANT B* antenna inputs. Press the *ANTENNA* button on the remote control to change antenna inputs if necessary.

Setting Up VCR Channels (with or without remote)

1. Repeatedly press *MENU•PROG* to select *SETUP MENU*, and then press + or - to display the setup functions. Repeatedly press *MENU•PROG* to select the *VCR 1 CHAN* function.

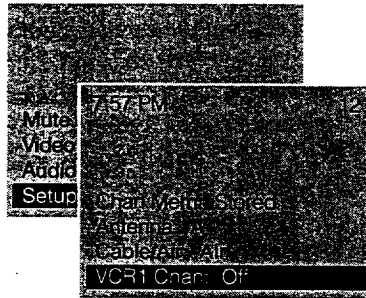

2. Enter the channel number you want to program by pressing two digit buttons on the remote control. (The channel number you enter is the channel to which the TV will tune automatically when you later press the *VCR1* button on the remote.)

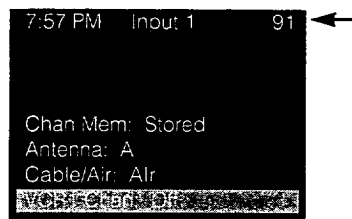

3. Press the + button to program the channel number you selected into the TV's memory.

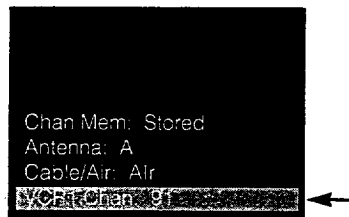

Note: Pressing the - button here will turn off this feature and display *VCR 1 CHAN: OFF* again.

4. If you have another VCR connected to the TV, press *MENU•PROG* to select the *VCR 2 CHAN* function.

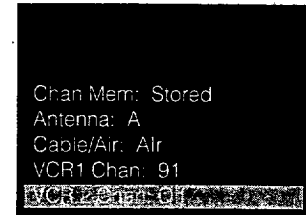

5. Enter the channel number you want to program by pressing two digit buttons on the remote control. (This is the channel number to which the TV will tune automatically when you later press the *VCR2•LD* button on the remote.) See the notes below if you are unsure about which channel number to enter.

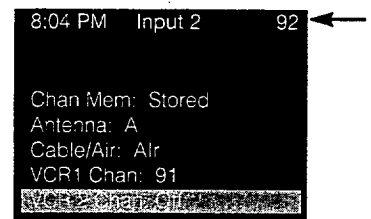

6. Press the + button to program the channel number you selected into the *VCR 2 CHAN* function memory.

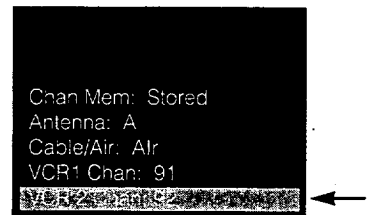

Note: Pressing the - button here will turn off this feature and display *VCR 2 CHAN: OFF* again.

Notes about Entering Channel Number:

- Enter channel 91 if VCR is connected to the TV's audio and video *INPUT 1* jacks.
- Enter channel 92 if VCR is connected to the TV's audio and video *INPUT 2* jacks.
- Enter channel 90 if you have a Super-VHS VCR that is connected to the TV's *S-VIDEO* connector and *INPUT 1* audio jacks (labeled *L* and *R/MONO*).
- Enter channel 03 (or 04) if you did not use any audio/video cables and connected the VCR to the TV's round antenna jack labeled *ANT A* or *ANT B*. Enter the same channel number (03 or 04) as the position of the VCR's *CH3/CH4* switch. This is the channel to which you must tune your TV for viewing signals from your VCR.
- Refer to pages 35-36 if you want to review details about connecting your VCR to your TV.

Setting Up Cable Box Channel

The *CABLE CHAN* function lets you program to which channel the TV will automatically tune when you press the *SAT•CABLE* button on the remote. This is handy if you want to connect a satellite receiver or other satellite receiver, or if your cable company requires you to connect a cable box to your TV. You will no longer have to remember the output channel of the RCA DSS® receiver or cable box because the TV will remember for you.

For example, if you connect a cable box to the TV's *CABLE/ANTENNA* connector (as shown on page 31), you will no longer have to remember to select channel 2, 3, or 4 on the TV to see what's coming from the cable box. By entering the cable box's output channel (usually 02, 03, or 04) next to the *CABLE CHAN* function, the TV will automatically tune to that channel each time you press the *SAT•CABLE* button on the remote.

This function is especially convenient if you have a remote-controllable cable box that can be operated by the *SAT•CABLE* button on the remote (as described on page 33). Pressing the *SAT•CABLE* button will then not only switch the remote to cable mode but will also automatically tune the TV to the proper channel for viewing the picture from the cable box.

Setting Up Cable Box Channel (with or without remote)

1. Repeatedly press *MENU•PROG* to select the *SETUP MENU*, and then press + or – to display the setup functions. Repeatedly press *MENU•PROG* to select the *CABLE CHAN* function.

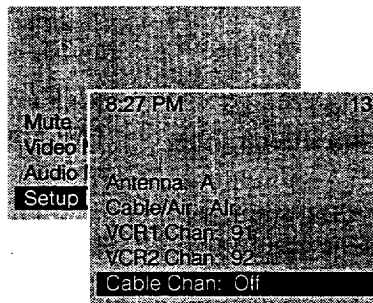

2. Enter the channel number you want to program by pressing two digit buttons on the remote control. (The channel number you enter is the channel to which the TV will tune automatically when you later press the *SAT•CABLE* button on the remote.) The TV will change to the channel you select. This will help you to confirm that it is indeed the channel you want the TV to automatically tune. Most cable boxes output their signals on either channel 02, 03, or 04.



3. Press the + button to program the channel number you selected into the *CABLE CHAN* function memory.

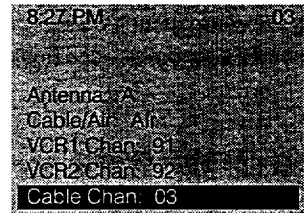

Note: Pressing the – button here will turn off this feature and display *CABLE CHAN: OFF* again.

Tips to Read Before Connecting Components

Compatible Components

A wide variety of compatible RCA Video Cassette Recorders (VCRs), camcorders, and audio components are available. Check with your RCA dealer for details.

Other brands of components can also be connected to your TV. Refer to the component's owner's manual for the manufacturer's recommended hookup instructions.

Stacking Arrangements

If you are connecting several components and plan to use a component rack, follow these general rules when arranging your components.

- If the components are arranged horizontally, allow at least an inch or two of space between them so air can circulate freely. This will also provide some space between the audio devices to minimize interference.
- If components are arranged vertically on shelves, place the Stereo Amplifier at the top so that heated air rising from it will not pass around the other components.
- Do not block the ventilation holes in the components. If components are placed on rugs or deep-pile mats, the ventilation holes in the bottoms may be blocked and overheating could result.
- Some VCRs may cause interference in TVs. When placing a VCR under your TV, try to keep at least 18 inches between the bottom of the TV and the top of the VCR. If interference is present when the VCR is used on top of the TV or at the 18-inch distance below the set, move the VCR beside the TV. If moving the VCR does not solve the interference problem, try plugging the VCR into a different wall socket.

Plugging in Power Cords

Do not plug any power cord into a wall outlet until you are finished making connections.

Many components have "convenience outlets" on their back panels so you can plug power cords from other components into a "convenience outlet" instead of a wall outlet. Usually these outlets will be labeled either "switched" or "unswitched".

- If the outlet is labeled "switched", that means power to the outlet will be switched off when the component's power button is switched off.
- If the outlet is labeled "unswitched", that means power will always be available at that outlet, even when the component is turned off.

Depending on the size of your system, you may prefer to use an extension cord or a "multiple adapter" to get enough outlets for all your components.

The power cords on your RCA components are "polarized" (one blade is wider than the other). Be sure the extension cord or multiple adapter is also polarized. The plug should fit in the outlet only one way.

Turning Off Power Before Connecting Components

Always turn off power to all components before you connect or disconnect any cables. This will protect your components from possible electrical surges that could damage your equipment.

This is a good practice for all your audio and video components—TVs, VCRs, audio systems, computers, etc.

Positioning Cables to Avoid Hum

The possibility of picking up hum (interference noise) in the audio/video cables will be reduced if you keep them away from the back of the TV. Route the cables to the sides of the TV's back panel instead of straight down the middle.

All cable plugs should be firmly seated in the jacks where they connect to the equipment. If a plug is not connected firmly, audio hum or smeared video may result.

If your antenna cable is flat twin-lead cable, try to keep it away from the audio/video cables as much as possible. Excess flat, twin-lead cable should be cut off instead of coiled behind the TV. Round, coaxial, antenna cable is usually shielded and can be coiled or placed next to audio/video cables without causing interference.

Positioning Speakers to Avoid Interference

Placing external speakers with unshielded magnets too close to the TV may result in the speaker magnets affecting the quality of the picture. Such speakers should be located at least eight inches away.

If unshielded speakers are too close to the TV, colored streaks will appear along the sides of the picture. If this happens, turn off the TV for several minutes while moving the speakers farther away. Then turn the TV back on.

Monitor Panel

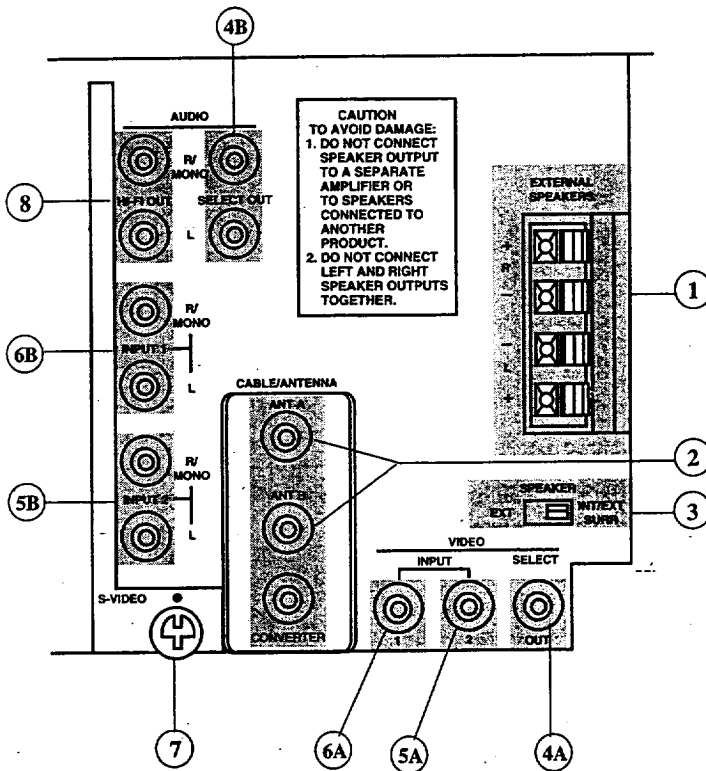

- ① **EXTERNAL SPEAKERS Terminals**—permit direct connection of auxiliary speakers. Connection details are on page 41.
- ② **CABLE/ANTENNA Connectors**—used when attaching either a home antenna or a cable-TV system to your TV. Connection details are on pages 30-32.
- ③ **SPEAKER Switch**—when you connect additional speakers to the *EXTERNAL SPEAKERS* terminals on the TV, this switch lets you optimize the sound for the speaker location you choose.
 - If you place the speakers on each side of the TV, put switch in *EXT* position. If the left side of the switch is labeled *EXT*, the internal audio from the TV's speakers will be muted.
 - If you place the speakers behind the viewer (at the back of the room), put switch in *INT/EXT SURR* position. This maintains normal volume level of the TV's internal speakers and a surround signal to rear speakers.
 - Details about connecting speakers to the TV are on page 43.

IMPORTANT: Always place switch in *INT/EXT SURR* position if no external speakers are used (or if external speakers are ever disconnected).

- ④A ④B **SELECT OUT Jacks**—provide fixed-level audio and video output from whatever is displayed on the TV screen (see notes below). Provide audio and video signals suitable for recording. Can be used for several applications such as:
 - VCR editing with two or three VCRs (page 36).
 - recording TV programs onto a camcorder (page 39).
 - recording cable-TV programs onto a VCR that is not cable-ready (page 36).
 - recording audio onto an audio cassette tape recorder (page 41).

Notes

- Remember that whatever you want to record must be displayed on the TV screen during recording.
- Video signals from the *S-VIDEO* connector can not be recorded from the *SELECT OUT VIDEO* jack. To record from an S-VHS component connected to the *S-VIDEO* connector, you must also connect the video cable to the *VIDEO INPUT 1* jack and then select channel 91 on the TV screen.
- On-screen displays such as menus and status displays can not be recorded from this jack.
- Special features such as picture-in-picture can not be recorded from this jack.

- ⑤A ⑤B **INPUT 2 Jacks**—provide for direct connection of video devices (like VCRs) or compatible home computers and TV games with video/audio outputs. To see the signals from a device that is connected to the *INPUT 2* jacks, tune your TV to channel 92.
- ⑥A ⑥B **INPUT 1 Jacks**—provide for direct connection of video devices (like VCRs) or compatible home computers and TV games with video/audio outputs. To see the signals from a device that is connected to the *INPUT 1* jacks, tune your TV to channel 91.
- ⑦ **S-VIDEO Connector**—provides for direct S-VHS video connection from S-VHS VCR or camcorder. Remember to also connect the S-VHS VCRs or camcorder's audio jack(s) to the TV's *INPUT 1 LEFT* and/or *R/MONO* audio jacks. This is necessary because S-Video cables only carry the super video (picture), not the audio signal. Connection details are on pages 36 and 39. Signals from S-VHS devices connected to the TV's *S-VIDEO* connector and *INPUT 1* audio jack(s) can be viewed by pressing the TV button followed by 9 then 0 on the remote control—(or by scanning to TV channel 90 if you have added "90" to channel memory as described on page 24).

Note: If you want to use the *SELECT OUT* jacks, remember to also connect the S-VHS component's regular video cable to the *VIDEO INPUT 1* jack, and then tune to channel 91.
- ⑧ **HI FI OUT Jacks**—feed volume-controlled stereo audio out from whatever is displayed on the TV screen. Allow connection of audio amplifier and lets you adjust sound

Home Antenna Connections

Follow one of the steps below to connect an indoor or outdoor antenna to your TV (only if you do not have a cable-TV system). You can connect the antenna to either *ANT A* or *ANT B* as explained on page 25.

A If the antenna cable coming from your home antenna is a 75-ohm round coaxial cable that carries only VHF (channels 2-13), only UHF (channels 14-69), or VHF and UHF channels, connect it to your set like this:

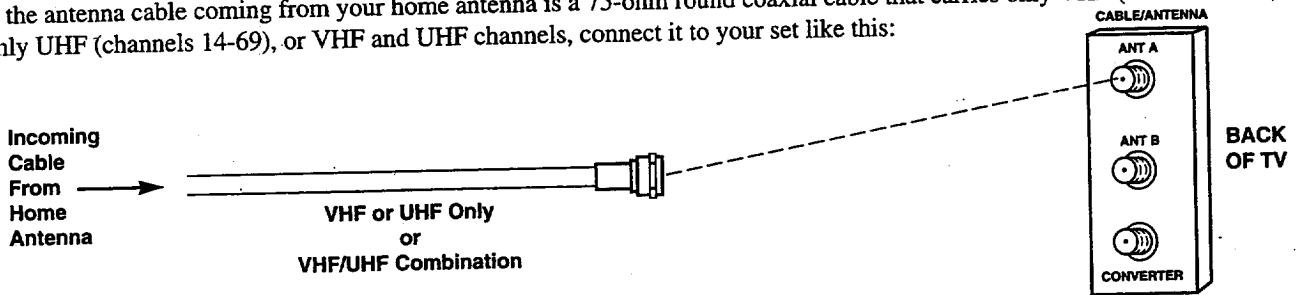

-OR-

B If the antenna cable coming from your home antenna is a 300-ohm flat twin lead that carries only VHF (channels 2-13), only UHF (channels 14-69), or VHF and UHF channels, connect it to your set like this:

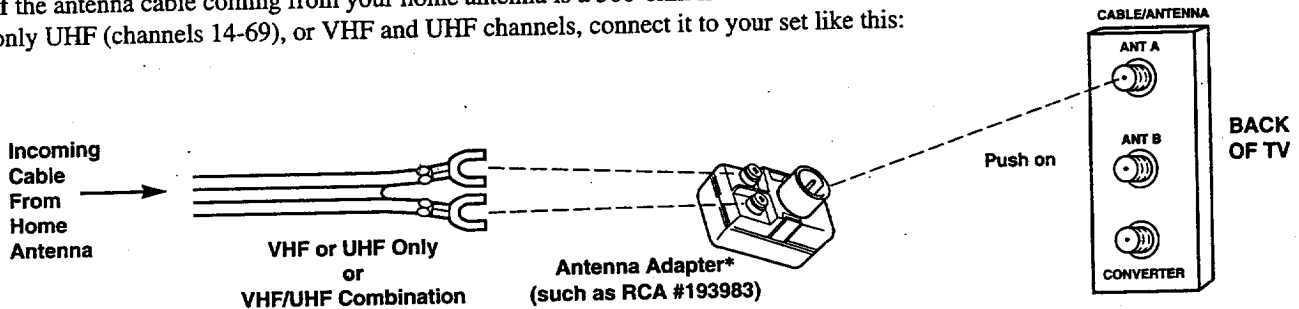

-OR-

C If the antenna cables coming from your home antenna(s) are a 75-ohm round coaxial cable that carries VHF (channels 2-13) and a 300-ohm flat twin-lead cable for UHF (channels 14-69), connect them to your set like this:

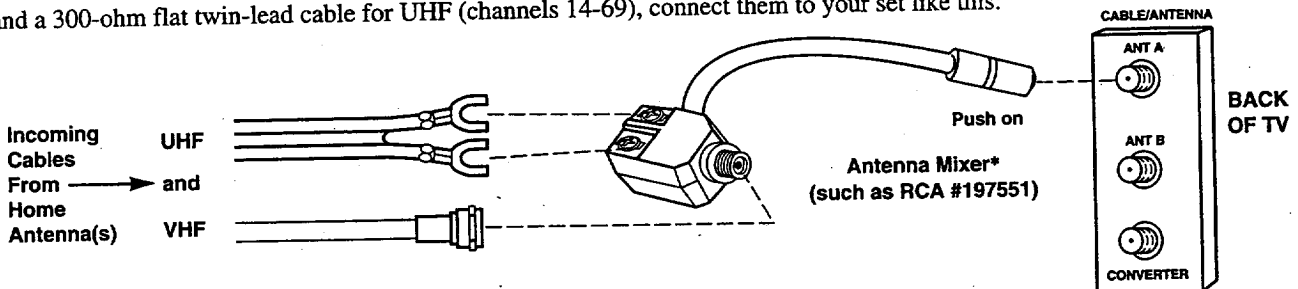

-OR-

D If the antenna wires coming from your home antenna(s) are two 300-ohm flat twin-lead cables as shown here, connect them to your set like this:

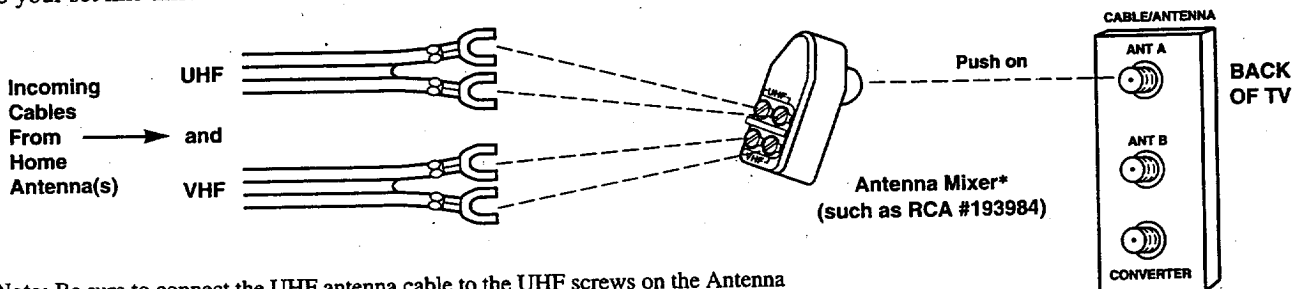

Note: Be sure to connect the UHF antenna cable to the UHF screws on the Antenna Mixer and the VHF antenna cable to the screws marked VHF.

* Optional accessories are available from most dealers or electronics supply stores.

Cable-TV Connections

Follow one of these steps to connect a cable-TV system to your TV instead of a home antenna. Since cable-TV systems vary, you may wish to consult your local cable-TV company for additional information. You can connect the cable-TV system to either *ANT A* or *ANT B* as explained on page 25.

A Follow this diagram if your cable company does not require a converter/decoder box (no scrambled channels):

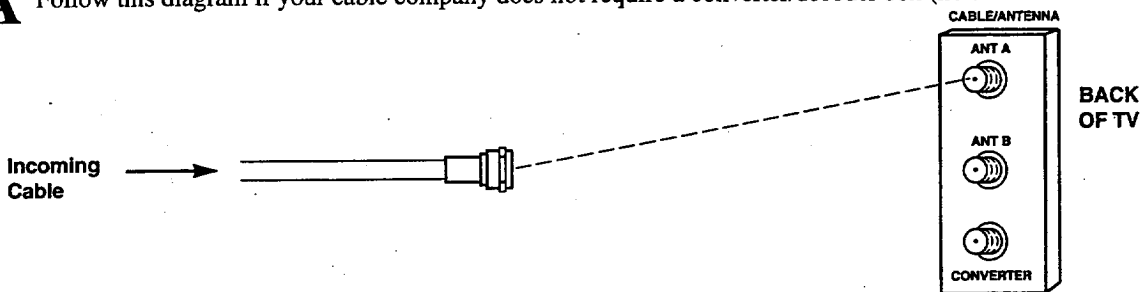

B Follow this diagram if your cable company requires a converter/decoder box that can be controlled by remote control. Most brands of remote-controllable boxes can be controlled by the remote that came packed with your TV. Details for programming your TV's remote to also control the converter/decoder box are on page 33. See diagram D if you want to connect a VCR.

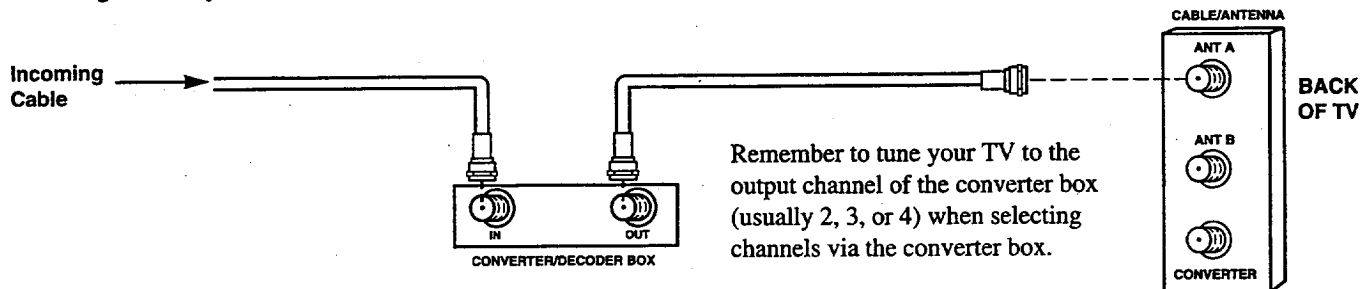

C Follow this diagram if your cable company requires a converter/decoder box that cannot be controlled by remote control.

Scrambled Cable-TV Channels

Some cable-TV decoders require that you manually switch from regular to scrambled channels on the decoder whenever you wish to view the premium pay channels. By connecting the decoder to the *ANT A* input and *CONVERTER* output on the TV as shown here, you can switch between the scrambled and unscrambled channels using the remote control.

To change the incoming signal from *ANT A* to *ANT B*, simply press the *ANTENNA* button on the remote. Each time you press the *ANTENNA* button, the channel numbers will change color on the screen to show which antenna signal you are watching.

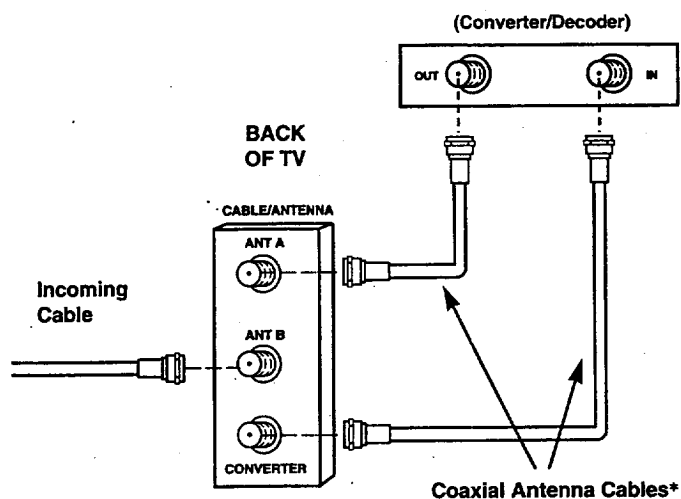

Nonscrambled cable channels will come thru the *ANT B* input whenever the channel numbers are yellow. The scrambled channel from the decoder box will come thru the *ANT A* input whenever the channel numbers are blue. Be sure to leave the decoder box set to the scrambled channel, and remember to tune your TV to the output channel of the converter box (usually 2, 3, or 4).

* Optional accessories are available from most RCA dealers and electronics supply stores.

Cable-TV Connections (continued)

D Follow this diagram if your cable company requires a converter/decoder box for premium channels and you also want to connect a VCR.

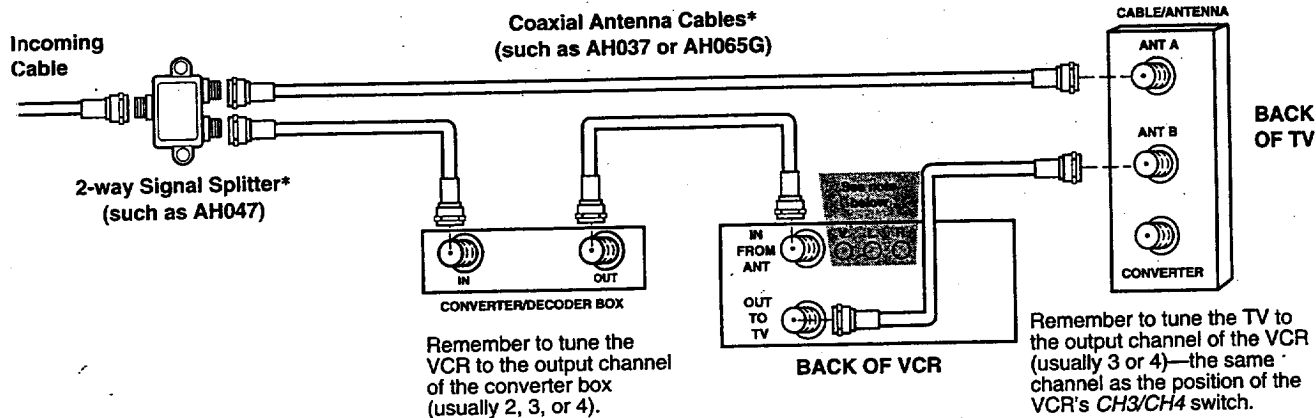

Most cable companies that require use of a converter/decoder box only require the box for scrambled premium channels like HBO or Showtime. All the other cable-TV channels can usually be viewed without the converter box. Therefore, by using a signal splitter, you can send the incoming cable-TV signals directly to the TV and also thru the converter/decoder box and VCR as shown above.

You can easily switch between the signals coming into the *ANT A* jack and the *ANT B* jack by pressing the *ANTENNA* button on the remote control. The channel numbers will change color to let you know which antenna signal you are watching. When the numbers are blue, you are seeing the *ANT A* signals. When the numbers are yellow, you are seeing the *ANT B* signals.

The cable-TV channels that are not scrambled can then be seen whenever the TV is receiving the *ANT A* signals. The cable-TV channels that are scrambled can then be seen thru the converter box and then thru the VCR whenever the TV is receiving the *ANT B* signals. Most VCRs will feed the signal thru their antenna jacks even when the VCR is turned off. This allows you to watch scrambled channels from the converter box without having to turn on the VCR.

This connection can be useful because it will let you record a scrambled channel on the VCR at the same time you are watching a non-scrambled channel thru the *ANT A* jack on the TV.

For picture-in-picture viewing, be sure to also connect the audio and video cables from the VCR to the TV as shown on pages 35-36. The VCR must be turned on and tuned to the output channel of the cable box (usually 2, 3, or 4) for picture-in-picture viewing.

* Optional accessories are available from most RCA dealers and electronics supply stores.

Note: If you have a stereo VCR, be sure to also connect the *AUDIO* and *VIDEO OUT* jacks on the VCR to the *AUDIO* and *VIDEO IN* jacks on the TV as shown on page 35. These additional audio/video connections are required for picture-in-picture operation and for stereo playback from the VCR. To see the signals from the VCR that are going into the *INPUT* jacks, select TV channel 91 if you connected the VCR to the *INPUT 1* jacks or select channel 92 if you connected the VCR to the *INPUT 2* jacks. Select TV channel 90 if you have an S-VHS VCR connected to the TV's *S-VIDEO* connector.

Programming Remote to Control a Satellite Receiver or Cable Box

The universal remote is preprogrammed to control an satellite receiver. If your cable box has its own remote to change channels, you will probably be able to program the TV's remote to control both the TV and the cable box.

The TV's remote is designed to control several brands of cable boxes. To program the remote, press and hold the **SAT•CABLE** button, then the two-digit code number for your brand of cable box. Refer to the chart below to find the code number for your cable box. Press the **POWER** button next to confirm operation.

You may need to try each of the code numbers listed for your brand until you find the one that works.

After the TV's remote is programmed, you'll be able to turn on the cable box by pressing **SAT•CABLE**, then **POWER**. You can change channels on the cable box by pressing the **CHAN** buttons whenever the remote is in the "cable" mode. To put the remote in the "cable" mode, press the **SAT•CABLE** button. Press the **TV** button to put the remote back into the TV mode so the remote buttons will control the TV again.

Programming Remote To Control Cable Box (with remote only)

1. Refer to the chart below to find the code number that corresponds to the brand name of your cable box. Keep this number in mind. If more than one number is listed, you may need to try each one separately until you find the one that works.
2. Press and hold the **SAT•CABLE** button on remote.
3. Press two number buttons (first one, then the other) to enter the code number for your brand of cable box.
Note: You must press the two number buttons while pressing the **DSS•CABLE** button.
4. Point the remote at the cable box and press the **POWER** button to test the code number.
 - If the right number was entered, the cable box should turn on. Pressing the **CHAN** buttons should then also change channels on the cable box.
 - If the cable box does not react to the remote (or if the remote turns on the cable box but does not change channels), repeat steps 1 thru 4 with another code number.

Operating Notes:

- After the remote is programmed, it will turn on the cable box whenever you press **SAT•CABLE** and then **POWER**. To turn off the cable box, press **SAT•CABLE**, then **POWER**.
- To change channels on the cable box, press **SAT•CABLE** then **CHAN** up or down.
- You may have to reprogram the remote control if you change its batteries. Try not to press any buttons while changing batteries.
- Depending on the age, brand, model, and type of equipment, some models may not be able to respond to the remote.

Brand of Cable-TV Box	Code Number(s)	Brand of Cable-TV Box	Code Number(s)
ABC.....	22,46,53,54	Randtek.....	07,08
Anvision.....	07,08	RCA.....	00,27
Cablestar.....	07,08	Regal.....	03,12,13
Diamond.....	56	Regency.....	02,33
Eagle.....	07,08	Samsung.....	44
Eastern International.....	02	Scientific Atlanta.....	03,22,35,63,64
General Instrument.....	46	Signature.....	46
GI 400.....	04,05,15,23,24,25,30,36	Sprucer.....	27
Hamlin.....	03,12,13,34,48	Starcom.....	46
Hitachi.....	37,43,46	Stargate 2000.....	58
Jerrold.....	04,05,15,23,24,25,30,36,45,46,47,62,65	Sylvania.....	11,59
Macom.....	37,43	Teknika.....	06
Magnavox.....	07,08,19,21,26,28,29,32,33,40,41	Texscan.....	10,11,59
NSC.....	09	Tocom.....	17,21,49,50,55
Oak.....	01,16,38	Unika.....	31,32,41
Oak Sigma.....	16	Universal.....	51,52,60
Panasonic.....	03,27,39,61	Viewstar.....	07,08,19,,21,26,28,29,32,33,40,41
Philips.....	07,08,19,21,26,28,29,32,33,40,41	Warner Amex.....	44
Pioneer.....	18,20,44	Zenith.....	14,42,57,61

Note: Refer to the information sheet packed with your remote control for the latest list of brand names and code numbers. Because this list is constantly growing, the information sheet packed with your remote control may be a later version of this list and contain additional brands and/or code numbers.

Cable-TV Operation

Your new TV is designed to receive up to 181 channels in the U.S.A. including 125 non-scrambled cable channels (see chart below). To use this TV on a cable-TV system, confirm that the cable-TV system is properly connected to your TV. Since cable systems vary, you may wish to consult your local cable-TV company for additional information.

If your cable-TV company follows EIA/NCTA channel-identification standards, most of the channels offered by your cable company will be identified by channel numbers that are identical to those on your TV. For example, if your cable-TV system has programs on cable channel 20, you can choose this channel by selecting channel 20 on your TV.

If your cable company offers cable channels 90, 91, or 92 you can tune them by selecting the TV channels shown below.

If your cable company offers this cable channel:	Tune your TV to this channel:
90	126*
91	127*
92	128*

* To tune cable channels 100 through 128, press and hold number button 1 until 1-- appears on the screen. Then enter the other two numbers.

Some cable-TV companies do not follow the EIA/NCTA standards and instead assign their own channel identification. For example, some use the standard broadcast channel numbers (2-13) for channels 2-13, but identify their other channels with letters. If your cable company does not follow the EIA/NCTA standards, ask them for a cross reference that shows to which channels you should tune your TV to receive their cable-TV channels.

Not all cable-TV channels will be active on your particular cable-TV system. Also some cable companies may require the use of a decoder with their cable-TV system. Consult your cable company or local dealer for details.

Scrambled Cable-TV Channels

Some cable companies offer "premium-pay" channels in which the signal is scrambled. Descrambling these signals for normal viewing requires the use of a descrambler device (cable box) which is generally provided by the cable company.

How you connect the cable box to your TV depends upon whether or not the cable box can be controlled by remote control. The TV's remote can also control most brands of cable boxes, so if your cable box is remote controllable, you may want to connect it as shown in Diagram B on page 31. Instructions for programming the TV's remote to control the cable box are on page 33.

If your cable box cannot be controlled by remote control, you will still be able to remotely control "unscrambled" channels with the connection shown in Diagram C on page 31.

Since cable systems vary, you may wish to consult your local cable company for additional information.

The chart below lists the "total" channel and cable count.

Channels	Off Air	Cable
• Low VHF A-8 (Channel 01)	—	1
• VHF (Channels 2-13)**	12**	12**
• UHF (Channels 14-69)	56	—
• Low Midband A-5 thru A-1 (Channels 95-99)***	—	5***
• Midband (Channels 14-22 or A-I)	—	9
• Superband (Channels 23-36 or J-W)	—	14
• Hyperband (Channels 37-64 or W+1 to W+28)	—	28
• Ultraband (Channels 65-94 and 100-125 or W+29 to W+84)	—	56
Total Capability**	68	125

** VHF is only counted once in total channel count because you can receive channels 2-13 on both "off-air" and "cable" channels. Therefore the total channel count for "off-air" and "cable" is 181 channels (68+125-12=181).

*** Channels 95, 96, and 97 are not applicable in Canada. Therefore the total number of channels for Canada is 178 (68+122-12=178).

VCR Connections

Standard VHS VCR (Not S-VHS)

(These connections allow you to record TV programs *and* play back tapes.)

Preferred Method for Areas with Good Reception

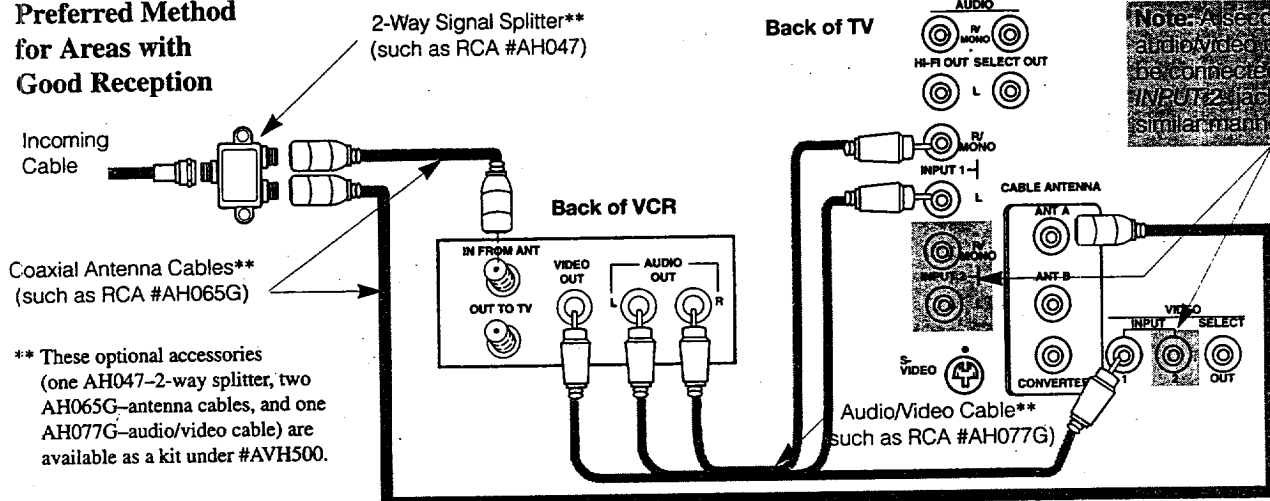

** These optional accessories (one AH047-2-way splitter, two AH065G-antenna cables, and one AH077G-audio/video cable) are available as a kit under #AVH500.

Shown here is the preferred method of connecting a VCR to your TV. This method uses a 2-way signal splitter to run separate signals to the VCR and TV. This way you can view either TV programs or VCR tapes and not be concerned about the position of the VCR's TV/VCR switch.

Note: When connected this way, the audio/video connections from the VCR to the TV are required in order for you to watch tapes being played by the VCR and for picture-in-picture operation.

Operation:

- If the VCR is connected to *INPUT 1* jacks as shown, select channel 91 on the TV to view whatever the VCR is playing.
- If you connect a second audio/video device to *INPUT 2*, select channel 92 on the TV to view whatever the second device is playing.

Note: You can program your TV to automatically select the proper VCR input channel (91 or 92) when you press the *VCR 1* or *VCR2•LD* button. Details are on page 26.

Simplified Method

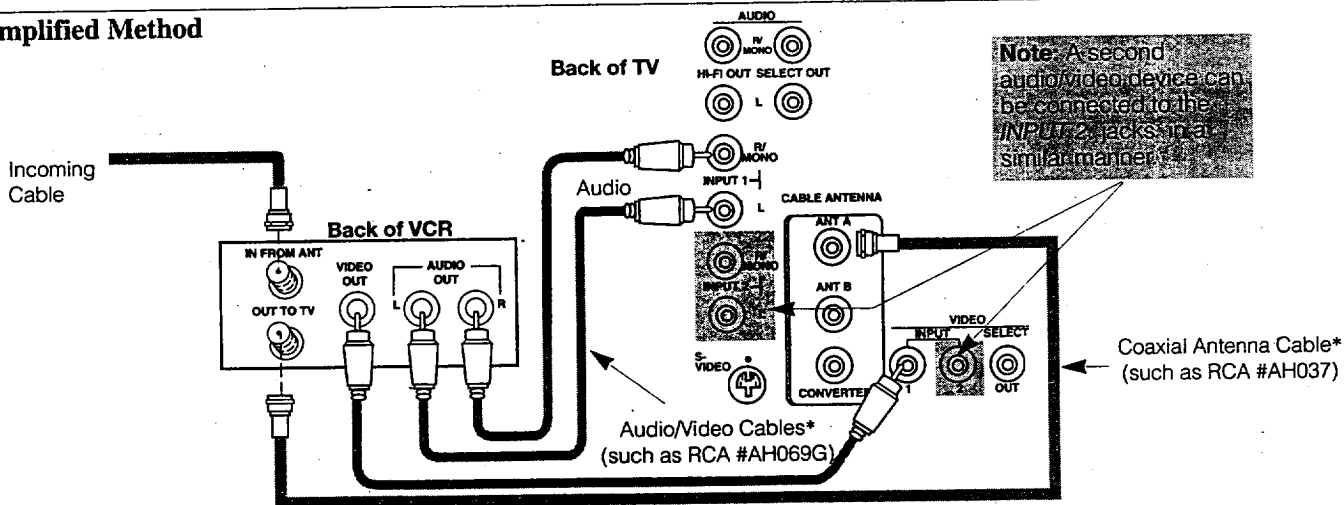

Shown here is a simplified method of connecting a VCR to your TV. The preferred method (using a 2-way signal splitter) is shown above.

Note: The audio/video connections from the VCR to the TV are optional; however, these additional connections usually produce a better-quality picture during VCR playback. These connections are required, however, for stereo playback from stereo VCRs and for picture-in-picture operation.

* Optional accessories are available from most RCA dealers and electronics supply stores.

Operation:

- If the VCR is connected to *INPUT 1* jacks as shown, select channel 91 on the TV to view whatever the VCR is playing.
- If you connect a second audio/video device to *INPUT 2*, select channel 92 on the TV to view whatever the second device is playing.

Note: You can program your TV to automatically select the proper VCR input channel (91 or 92) when you press the *VCR 1* or *VCR2•LD* button. Details are on page 26.

Special Recording onto VCR

(This connection only allows you to record on the VCR whatever is currently being displayed on the TV screen)

This is not a common application for recording with your VCR, but you may find it useful in certain situations. This connection will let you record onto the VCR whatever is being displayed on the TV screen such as a TV program. You'll also be able to record signals from another VCR (or similar device) that is connected to the TV's *INPUT 1* or *2* jacks.

The TV must remain turned on during recording. If you change channels on the TV, the channel change will be recorded on the VCR tape unless you pause the VCR during recording.

Because your TV is cable-compatible, this application may be used to record cable-TV programs from the TV onto a VCR that is not cable-compatible.

You may also want to use this connection to dub or edit VCR tapes with two or three VCRs. By connecting one VCR (or camcorder) to the *INPUT 1* jacks and another VCR (or camcorder) to the *INPUT 2* jacks, you'll be able to selectively edit and record whatever is playing on the TV screen onto a third VCR (or camcorder) connected as shown here to the *SELECT OUT* jacks.

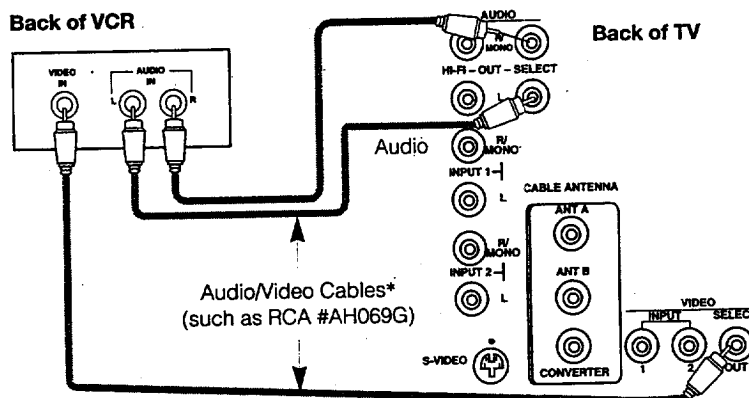

To see the signal from a device connected to the *INPUT 1* jacks, select channel 91. Select channel 92 to see the signal from a device connected to the *INPUT 2* jacks.

Notes: Signals from the *S-VIDEO* connector do not come thru the *SELECT OUT* jacks. To record from an *S-Video* component, remember to also connect the regular video cable to the *VIDEO INPUT 1* jack and then tune to channel 91.

You will not be able to record the picture-in-picture inset picture or any of the menus or status displays.

S-VHS (Super VHS) VCR

(This connection allows you to record TV programs and play back tapes.)

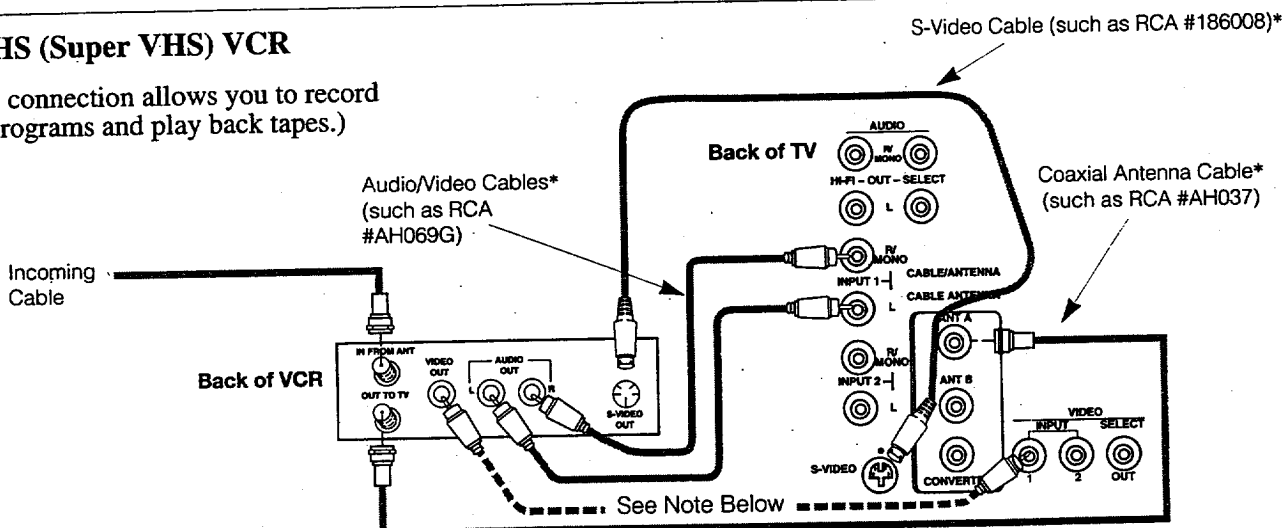

Shown here is one method of connecting your S-VHS VCR to your TV. Connect the *S-VIDEO OUT* connector on the back of the VCR to the *S-VIDEO* connector on the back of your TV using an S-Video cable: Remember to connect the audio cables from the VCR to the *INPUT 1 LEFT* and *R/MONO* jacks on the back of the TV. The S-Video cable carries only video.

Note: Remember to also connect the video cable for picture-in-picture viewing or if you plan to use the *SELECT OUT* jacks for

* Optional accessories are available from most RCA dealers and electronics supply stores.

recording. When recording from *SELECT OUT* jacks, tune the TV to channel 91 to see the signal from the S-VHS VCR. When displaying picture-in-picture, the TV automatically minimizes any annoying differences in tint between the small and large picture by electronically coupling the *S-VIDEO* input to the *VIDEO 1* input.

Operation: If the S-VHS VCR is connected as shown above, tune the TV to channel 90 to view whatever the VCR is playing. The word *S-VIDEO* will appear on the TV when you select Channel 90.

Remote Buttons That Control RCA VCRs

The digital remote control that came packed with your TV controls your TV *and* up to two compatible RCA VCRs.

To control a compatible RCA VCR, first press the *VCR1* or *VCR2•LD* button to put the remote in the "VCR mode". The buttons shown below will then control the VCR.

Selected models of RCA VCRs have a switch that lets you determine which VCR will be controlled by the *VCR1* button,

and which VCR by the *VCR2•LD* button. Other models have an on-screen menu that lets you determine if it will be controlled by *VCR1* or *VCR2•LD*. Additional information about controlling two RCA VCRs is in the note on the next page.

If you have another brand of VCR, you can probably also program your remote to control it. Details are on the next page.

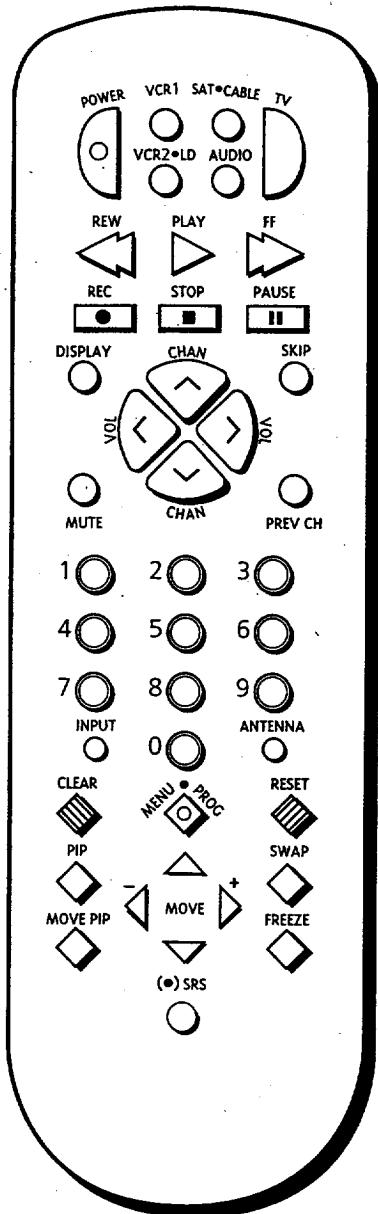

Notes:

- The six VCR buttons grouped together (*PLAY*, *PAUSE*, *STOP*, *REW*, *FF*, and *REC*) control the VCR even if the remote is in the "TV Mode".
- The *ANTENNA*, *MENU•PROG*, *CLEAR*, and *DISPLAY* buttons are for RCA VCRs only.

VCR1 and *VCR2•LD* Buttons

- Press to turn on VCR and put remote in "VCR Mode".
- Press the *TV* button to put remote back into "TV Mode".

POWER Button

Press to turn off VCR.

REW (Rewind) Button

- Press while VCR is stopped to rewind tape.
- Press while VCR is playing to search backward.

PLAY Button

Press to start tape playing.

FF (Fast Forward) Button

- Press while VCR is stopped to fast forward tape.
- Press while VCR is playing to search forward.

REC (Record) Button

Press to record.

STOP Button

Press to stop whatever VCR is doing: Playing, Recording, Rewinding, or Fast Forwarding.

PAUSE Button

- Press to pause play or record mode.
- Press again to release pause.

DISPLAY Button

Press to bring VCR's displays to TV screen.

CHAN (Channel) Buttons

Press to select the next higher or lower channel in VCR channel memory.

Number Buttons

- Press two numbers to select channel.
- Press a "0" before a single-digit channel number.

CLEAR Button

Used when setting the VCR's clock and timer.

MENU•PROG Button

Used when setting the clock and programming the timer.

ANTENNA Button

Same as *VCR* or *TV/VCR* button on front of VCR.

Controlling Other Brands of VCRs

The digital remote control that came packed with your TV controls your TV and up to two compatible VCRs, including most models of most other brands.

To program the remote, press and hold *VCR1* (or *VCR2•LD*) and the two-digit code number for your brand of VCR.

Note About Controlling Two VCRs

- This remote can control two VCRs independently as long as each VCR operates on a different remote transmitting code.
- Some newer VCRs are capable of working on either of two remote codes. These VCRs have either a switch labeled *VCR1/VCR2* or an on-screen display titled *REMOTE VCR1/VCR2*. You can then set your new VCR to respond to the remote's *VCR2•LD* button and your older VCR to respond to the *VCR1* button.
- Some older VCRs have a *NORM/UNIFIED* switch that can also respond to either the *VCR1* or *VCR2•LD* button on the remote. Place this switch in the *UNIFIED* position for the VCR to respond to the *VCR1* button or in the *NORM* position for the *VCR2•LD* button. In the *NORM* position, you must program the *VCR2•LD* button to respond to code number 05.
- If neither of your VCRs have switchable code capabilities, you still may be able to use the *VCR1/VCR2* feature to control two VCRs of the same brand since many older VCRs use remote codes that are different than newer VCRs. You may want to experiment to see what works with your particular VCRs.

Programming Remote To Control Other Brands of VCRs

1. Refer to the chart below to find the code number that corresponds to the brand name of your VCR. Keep this number in mind. If more than one number is listed, you may need to try each one separately until you find the one that works.
2. Press and hold the *VCR1* or *VCR2•LD* button on remote (depending on which button you want to program for that VCR). You can program each button to control a different VCR.
3. Press two number buttons (first one, then the other) to enter the code number for your brand of VCR. **Note:** You must press the two number buttons while holding the *VCR1* or *VCR2•LD* button.
4. Point the remote at the VCR and press the *POWER* button to test the code number. If nothing happens, try pressing *VCR1* or *VCR2•LD* (whichever button you are programming).
 - If the right number was entered, the VCR should turn on.
 - If the VCR does not react to the remote, repeat steps 1 thru 4 with another code number.

Note: Some older VCRs do not have an *POWER* switch on their remote controls and cannot be turned on and off remotely. If you have this type of VCR, you can test the code number by pressing the *CHAN* button instead of the *POWER* button. Make sure the VCR is already turned on when you test the code number.

Operating Notes:

- After the remote is programmed, it will turn on the VCR whenever you press *VCR1* (or *VCR2•LD*) and then *POWER*. Some VCRs turn on automatically when you press *VCR1* or *VCR2•LD*.
- You'll be able to control the VCR whenever the remote is in the "VCR mode". To put the remote in the "VCR mode", press the *VCR1* or *VCR2•LD* button (depending on which button you programmed). The other VCR buttons (such as *PLAY*, *PAUSE*, *STOP REW*, *FF*, and *REC*) will control the VCR when the remote is in the "VCR mode".
- To turn off the VCR, press *VCR1* (or *VCR2•LD*), then *POWER*.
- You may need to reprogram the remote when you change the batteries. Try not to press any buttons when changing batteries.
- Depending on the age, brand, model, and type of equipment, some models may not be able to respond to the remote.

VCR Brand	Code(s)	VCR Brand	Code(s)	VCR Brand	Code(s)
Aiwa.....	15	JVC.....	02,14,16,30,46,74	Samsung.....	07,13,22,32,42
Akai.....	03,17,22,23,63,66	Kenwood.....	02,14,16,30,44,46	Sanyo.....	02,12
Audio Dynamics.....	14,16	Magnavox.....	08,29,53,56	Scott.....	04,13,41,49,68
Broksonic.....	10	Marantz.....	02,08,14,16,29,30,44,46,61	Sears.....	02,05,09,12,18,19,35,43,48
Candle.....	07,09,13,44,45,46,52	Marta.....	09	Sharp.....	06,24,27,39,45
Canon.....	08,53	Memorex.....	08,09,12,15	Shintom.....	17,26,31,55
Capehart.....	01	MGA.....	04,27	Sony.....	17,26,38
Citizen.....	07,09,13,44,45,46,52	Minolta.....	05,35	Sylvania.....	08,15,29,53,56
Craig.....	07,12	Mitsubishi.....	04,05,27,35,40	Symphonic.....	15
Curtis Mathes.....	00,07,08,14,1	Montgomery Ward.....	06	Tashiko.....	09
.....	5,44,46,53,64,67	Multitech.....	07,15,31,32	Tatung.....	30
dbx.....	14,16	NEC.....	02,14,16,30,44,46,59,61,64	Teac.....	15,30,69
Electrohome.....	27	Panasonic.....	08,53,75	Tecnics.....	08
Emerson.....	08,09,10,13,15,20,23,27,	Pentax.....	05,35,44	Teknika.....	08,09,15,21
.....	34,41,42,47,49,57,62,65,67,68,70	Philco.....	08,29,53,56	Toshiba.....	05,13,19,48,49
Fisher.....	02,12,18,19,43,48,58	Philips.....	08,29	Vector Research.....	14,16,44
Funai.....	15	Pioneer.....	05,16,33	Video Concepts.....	14,16,44
GE.....	00,07,08,32,53	ProScan.....	00	Wards.....	05,06,07,08,09,12,
Goldstar.....	09,14,46,60	Quasar.....	08,53	13,15,25,27,31,35
Hitachi.....	05,15,35,36	RCA.....	00,05,07,08,28,35,37,54,69	Yamaha.....	02,14,16,30,46
JCPenney.....	02,05,07,08,14,1	Realistic.....	02,06,08,09,12,1	Zenith.....	11,17,26,72
.....	6,30,35,51,53	5,19,27,43,53		

Note: Refer to the information sheet packed with your remote control for the latest list of brand names and code numbers. Because this list is constantly growing, the information sheet packed with your remote control may be a later version of this list and contain additional brands and/or code numbers.

Camcorder Connections

S-VHS or Standard VHS Camcorder

(This connection allows you to play back tapes in the camcorder and watch them on the TV.)

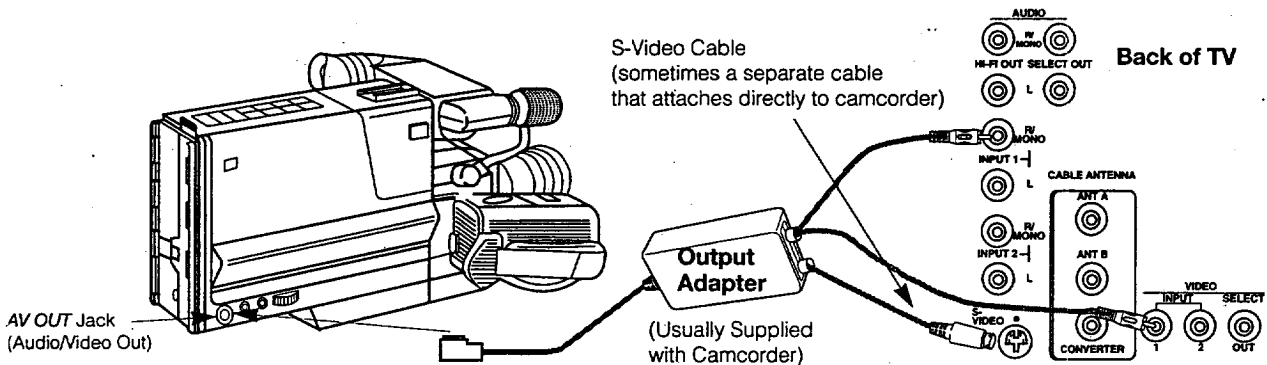

An S-VHS or standard camcorder can be connected directly to your TV. If you have an S-VHS camcorder, connect the S-VIDEO cable to the S-VIDEO connector on your TV. If you have a standard VHS camcorder, connect the video cable to the VIDEO INPUT 1 jack on the back of your TV. With either video connection, attach the audio cable to the INPUT 1 R/MONO audio jack.

Notes: When the adapter's S-Video Cable is connected to the S-VIDEO connector, the video plug does not have to be connected. However, you may prefer to plug it in anyway to keep it out of the way. The S-VHS video will automatically override the VIDEO INPUT 1 signal when you select Channel 90. Be sure to connect the video cable; however, for

picture-in-picture viewing or if you plan to use the SELECT OUT jacks for recording. When recording from the SELECT OUT jacks, tune to channel 91 to see the signal from the camcorder. When displaying picture-in-picture, the TV automatically minimizes any annoying differences in tint between the small and large picture by electronically coupling the S-VIDEO input to the VIDEO 1 input.

Operation:

- If the camcorder is connected to the VIDEO INPUT 1 jack (instead of the S-VIDEO connector), select channel 91 on the TV to view whatever the camcorder is playing.
- If the camcorder is connected to the S-VIDEO connector and INPUT 1 audio jack, select channel 90 on the TV to view whatever the camcorder is playing.

S-VHS or Standard VHS Camcorder

(This connection allows you to record onto the camcorder whatever is currently being displayed on the TV screen.)

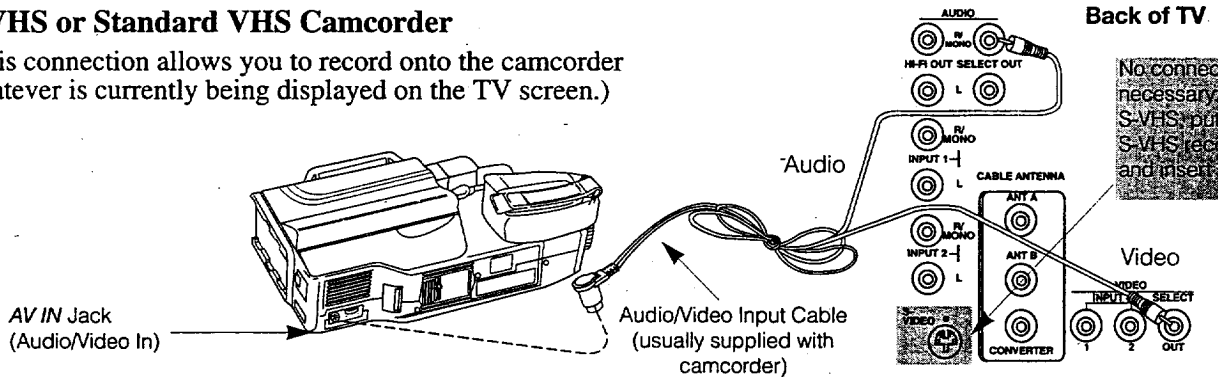

This connection will let you record onto the camcorder whatever is being displayed on the screen such as a TV program. You'll also be able to record signals from a VCR (or similar device) that is connected to the TV's INPUT 1 or 2 jacks.

Note: You will not be able to record the picture-in-picture inset picture or any menus or status displays.

The TV must remain turned on during recording. If you change channels on the TV, the channel change will be recorded on the camcorder tape unless you pause the camcorder during recording.

You may also want to use this connection to dub or edit VCR tapes with two or three camcorders (or VCRs). By connecting one camcorder (or VCR) to the INPUT 1 jacks and another camcorder (or VCR) to the INPUT 2 jacks, you'll be able to

selectively edit and record whatever is playing on the TV screen onto a third camcorder (or VCR) connected as shown here to the SELECT OUT jacks.

If you connect a surveillance system to your monitor, you'll be able to record what the camera is displaying on the TV screen by connecting a camcorder (or VCR) to the SELECT OUT jacks as shown here.

To see the signal from a device connected to the INPUT 1 jacks, select channel 91. Select channel 92 to see the signal from a device connected to the INPUT 2 jacks.

Note: Signals from the S-VIDEO connector do not come thru the SELECT OUT jacks. To record from an S-VHS component, remember to also connect its regular video cable to the VIDEO INPUT 1 jack and then tune the TV to channel 91.

Component Connections

Computers and Other Equipment with Audio/Video Outputs

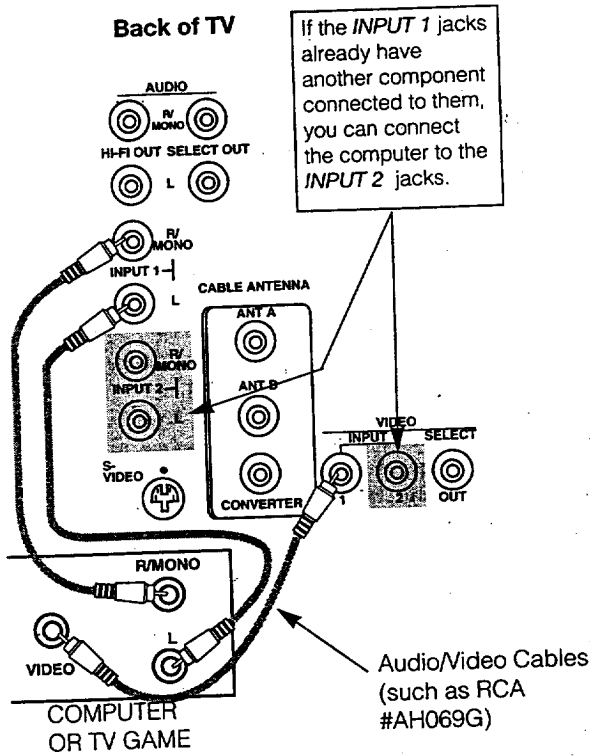

Your TV can also be used as a display device for many video games and home computers. If your game or computer has a normal NTSC (American Standard) *VIDEO* output, it can be connected directly to either the *INPUT 1* or *INPUT 2* jacks on the TV as shown here.

If the computer or other device has monaural audio output (only one *AUDIO OUT* jack instead of *L* and *R*), connect it to the TV's *R/MONO* jack. This will enable the TV to reproduce the sound through both the left and right speakers.

To View Signals From Computer

- If you connected the computer to the TV's *INPUT 1* jacks, select channel 91 on the TV so you can see whatever signal is coming from the computer.
- If you connected the computer to the TV's *INPUT 2* jacks, select channel 92 on the TV so you can see whatever signal is coming from the computer.

Component Connections (continued)

Amplifier or Cassette Tape Deck

Audio Amplifier

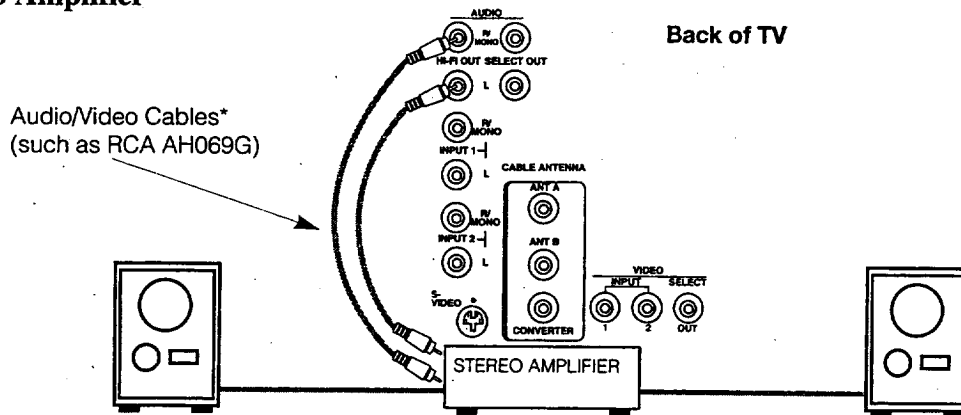

If your stereo amplifier is not part of a "system" that has its own remote, connect it to the TV as shown here.

Note: If the stereo amplifier is part of a system that has its own remote, you may choose to connect it to the TV as shown below using the *SELECT OUT* jacks.

With the connection shown here, you'll be able to change and mute volume with the TV's remote control. You'll also be able to remotely control bass and treble functions.

Connection:

Connect the "L" and "R" *HI F I OUT* jacks to the corresponding input jacks on the stereo amplifier (such as *AUX*, *TUNER*, or *CD*). Do not use the *PHONO* inputs. If your amplifier is not stereo (mono), connect it to the TV's *R/MONO* jack. Consult the amplifier's owner's manual for the manufacturer's recommended hookup.

Operation:

If desired, turn off TV's internal speakers as described on page 11. Adjust the amplifier for normal listening. Then control sound with the *VOL* and *MUTE* buttons on the TV's remote.

Audio Cassette Recorder or Amplifier

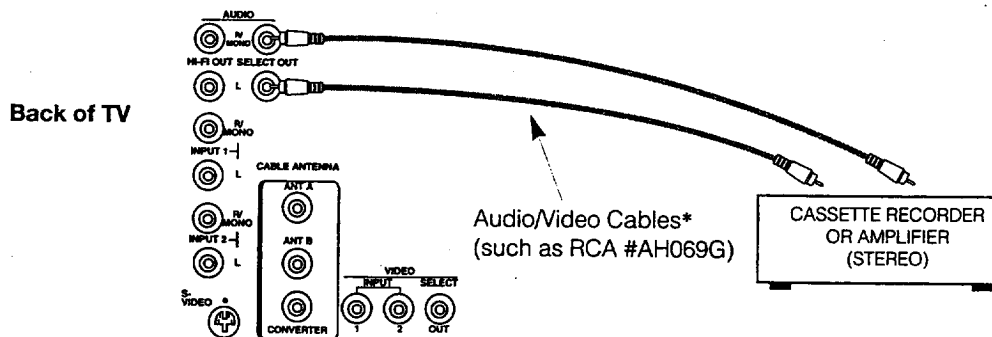

If your stereo amplifier is part of a "system" that has its own remote control, connect it to the *SELECT OUT* jacks as shown here. The "fixed level" audio signal present at these jacks is also ideal for connecting an audio cassette recorder to record audio from the TV. This constant audio signal is not affected by pressing the *VOL* buttons on the TV's front panel or the TV's remote control.

Connection:

Connect *SELECT OUT* "L" and "R" to the corresponding input jacks on the stereo amplifier or audio cassette recorder.

If your amplifier is not stereo (mono), connect it to the TV's *R/MONO* jack. Consult the equipment's owner's manual for the manufacturer's recommended hookup.

Operation:

Select a TV channel and turn down the sound on the TV, or turn off TV's internal speakers as described on page 16. Adjust sound with controls on the amplifier or cassette recorder. If the amplifier or cassette recorder is part of a "system" that has its own remote, use the system's remote to adjust sound.

Programming Remote to Control Audio Equipment

The digital remote control that came packed with your TV is also capable of controlling a compatible audio component.

To program the remote press and hold the **AUDIO** button and then enter the two-digit code number for your brand of audio equipment.

Programming Remote to Control Audio Equipment

1. Refer to the chart below to find the code number that corresponds to the brand name of your audio equipment. If more than one number is listed, you may need to try each one separately to find the one that works.
2. Press and hold the **AUDIO** button on remote (depending on which button you want to program).
3. Press two number buttons (first one, then the other) to enter the code number for your brand of audio equipment.
Note: You must press the two number buttons while holding the **AUDIO** button.
4. Point the remote at the audio equipment and press the **POWER** button to test the code number.
 - If the right number was entered, the audio equipment will turn on.
 - If the audio equipment does not react to the remote, repeat steps 1 thru 4 with another code number.

Operating Notes:

After the **AUDIO** button is programmed, the buttons described below will operate the basic functions of the audio equipment. Depending on the age, brand, model, and type of audio equipment, some models may not be able to respond to all the function buttons listed below. You will want to experiment with each button to determine the exact function for your component.

- **POWER:** Press to turn on component. Press again to turn off. Some components will turn on automatically when you press this button.
- **VOL:** Press to change volume level.
- **CHAN:** Press to select the next higher or lower channel in the component's channel memory.
- **Number Buttons:** Press two numbers to directly select a channel.
- **PLAY:** Press to start component playing.
- **PAUSE:** Press to pause play or record. To release pause, press again.
- **STOP:** Press to stop whatever the component is doing: playing, recording, rewinding, etc.
- **REW (Rewind):** Press while component is stopped to rewind tape.
- **FF (Fast Forward):** Press while component is stopped to fast forward tape.
- **REC (Record):** Press to start recording.
- **ANTENNA:** Performs various functions depending on the type of equipment. Experiment with this button.

Audio Equipment	Type of Audio Equipment and Code(s)					
	AMP	AM/FM	CD	TAPE	PHONO	AUX
Dimensia		03	07	06	05	04
RCA	24	03	07,43,44	06	05	04,54

Note: Refer to the information sheet packed with your remote control for the latest list of brand names and code numbers. Because this list of brand names is continually growing, the information sheet packed with your remote control may be a later version of this list and contain additional brands and/or code numbers.

Speaker Connections

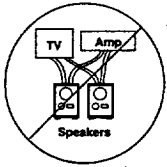

Caution: Do not connect external speakers to more than one audio source at a time. You can connect a set of speakers to either the TV or the Amplifier *but not to both at the same time*. If you connect the same speakers to both the TV and the amplifier, you will damage your equipment.

Connecting Speakers to Back of TV

If you connect an amplifier or receiver to your TV, connect the speakers to the amplifier /receiver instead of the TV.

If you do not connect an amplifier or receiver to your TV, you can connect external speakers to the TV to enhance the TV's sound.

The diagram below shows how to connect external speakers to the speaker terminals on the back of the TV.

1. Remove the vinyl covering and twist the wire core.
2. Press and hold the lever down while inserting the wire core into the hole. Be sure to connect (+) to (+) and (-) to (-) as explained in the note below.
3. Release the lever.

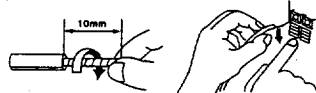

Notes:

- After releasing the lever, pull gently on the wire and check that it is connected securely to its terminal.
- Do not allow the wire core to protrude from its terminal or contact other wires or terminals. If the cores of two wires touch each other, damage to components could result.

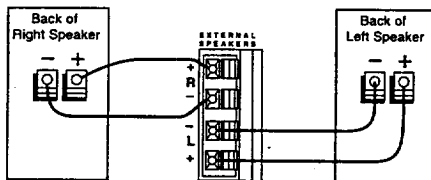

The speaker switch on the back of the TV allows you to use the external speakers two ways:

- To enhance the sound from the TV, place the speakers in the front of the viewing area (usually beside the TV), and slide the speaker switch to *EXT*. This provides full power to the external speakers for a "fuller" sound. The internal audio from the TV's speakers will be turned off.



- To obtain a "surround sound" effect, place the external speakers in the rear of the viewing area, and slide the speaker switch to *INT/EXT SURR*. This provides full power to the TV's internal speakers for the front sound and a surround signal to the rear speakers.

Helpful Hints:

- External speakers placed next to the TV will sound better the higher quality they are.
- Very efficient small "bookshelf" or "compact" speakers will give good results for surround-sound use.
- Surround effect can often be improved by experimenting with rear speaker placement.
- Surround-encoded movies (broadcast or tape) give the best surround effect, but regular stereo and mono programs will also benefit.

Connecting Speakers to Back of Amplifier or Receiver

If you connect an Amplifier or Receiver to your TV, connect the speakers to the Amplifier/Receiver instead of the TV. Sound from the TV will then come through the Amplifier/Receiver and the TV's internal speakers. You can turn off the TV's internal speakers with the *SPEAKERS: ON/OFF* function described on page 16.

The diagram here shows how to connect external speakers to the speaker terminals on the back of a typical Amplifier/Receiver. Check the owner's manual for your Amplifier/Receiver if its speaker terminals look different than those shown.

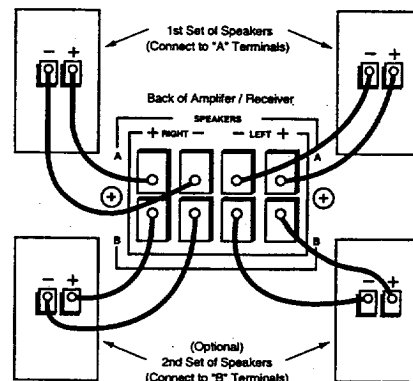

Notes:

- After connecting speaker wire, pull it gently and check that it is connected securely to its terminals.
- Do not allow the wire core to protrude from its terminal or contact other wires or terminal. If the cores of two wires touch each other, damage to components could result.

Important: When connecting the speaker wire, make sure you connect the (+) terminal on the TV to the (+) terminal on the speaker. One side of the speaker wire is usually marked with a white stripe to help you connect (+) to (+) and (-) to (-). If the (+) and (-) terminals are not matched properly, the speakers will not be in phase, causing reduction in low frequencies (bass).

Accessories

Compatible Components

A wide variety of compatible Video Cassette Recorders (VCRs), camcorders, and audio components are available. Check with your dealer for details. Other components can also be connected to your TV. Refer to the component's owner's manual for the manufacturer's recommended hookup instructions.

General Cable Information

Antenna (or cable-TV) connections are made with either coaxial antenna cable or twin-lead cable. Coaxial cables are shielded so they are less susceptible to hum or interference from adjacent cables.

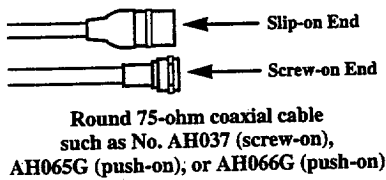

Most audio/video connections between components can be made with shielded audio and video cables that have RCA-type phono connections. When connecting components to each other, be sure that you always connect left outputs to left inputs and right outputs to right inputs. If a component has only one output (mono), connect it to the *RMONO* input jack.



Standard Audio/Video Cable with RCA-type phono plugs (such as No. AH069G)

To connect S-VHS (Super-VHS) components, an S-Video cable is required.



S-Video Cable (such as No. VAA020)

The following accessories are available from most dealers in case you want to position your components farther apart or need additional cables.

Antenna Cables

Screw-on Antenna Cable

Attaches to the round antenna connectors (called 75-ohm F-type) on the back of your VCR or TV. The ends screw onto the connectors for a secure connection.

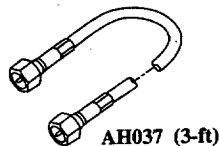

Push-on Antenna Cable

Attaches to the round antenna connectors (called 75-ohm F-type) on the back of your VCR or TV. Ends push on for a quick connection.

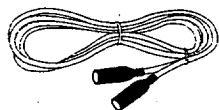

Gold-Tipped Cables
AH065G (6-ft)
AH066G (10-ft)

Audio/Video Cables

Audio/Video Cable

Shielded cable for connecting *AUDIO* and *VIDEO* jacks. Has an RCA-type phono plug on each end.

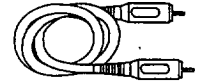

Gold-Tipped Cables
AH069G (3-ft)
AH070G (5-ft)

Stereo Audio Cable

Double gold-tipped cable generally used for connecting stereo audio components.

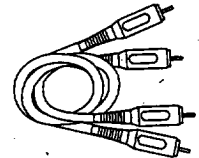

Gold-Tipped Cable
AH072G (3-ft)

Stereo VCR Dubbing Cable

Triple cable that lets you connect the *VIDEO* and *AUDIO* jacks of stereo components.

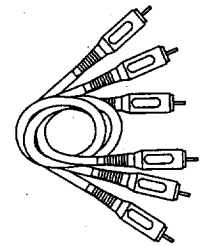

Gold-Tipped Cable
AH077G (6-ft)

Monaural VCR Dubbing Cable

Double cable that lets you connect the *VIDEO* and *AUDIO* jacks of two VHS VCR's to duplicate tapes. Can also be used to connect a VCR to your TV. Cable is color-coded and shielded. Has RCA-type phono plugs on each end.

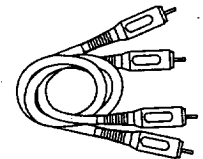

Gold-Tipped Cable
AH075G (6 ft)

S-Video Cable

Has multipin S-connector on each end for connecting S-VHS components to your TV. When connecting an S-VHS component to the *S-VIDEO* jack on your TV, remember to also connect the left and right audio cables to the *INPUT 1* jacks because the S-Video cable carries only the picture, not the sound.



VAA020 (8-ft)

Accessory Order Form

Remote Control (233063)

This is the remote that came packed with your TV. You can use the order form to order it direct by mail if desired.

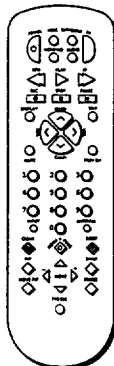

Simple Touch™ Remote Control (206800)

This is an optional remote that can be used to turn your set on/off, change channels, and adjust volume. It is a simplified remote that can be used to control basic functions.



Accessory Order Form (Tocom # 1508388A)

Description	Part No.	Price	Qty	Total
Screw-on Antenna Cable (3-ft)	AH037	\$ 3.95		
Signal Splitter	AH047	\$ 3.99		
Gold-Tipped Antenna Cable (6-ft)	AH065G	\$ 6.99		
Gold-Tipped Antenna Cable (10-ft)	AH066G	\$ 8.99		
Gold-Tipped Audio/Video Cable (3-ft)	AH069G	\$ 5.99		
Gold-Tipped Audio/Video Cable (5-ft)	AH070G	\$ 7.99		
Gold-Tipped Stereo Audio Cable (3-ft)	AH072G	\$ 8.99		
Gold-Tipped Dubbing Cable (6-ft)	AH075G	\$10.99		
Gold-Tipped Dubbing Cable (6-ft)	AH077G	\$14.99		
VCR Connection Kit	AVH500	\$32.95		
S-VHS Video Cable (8-ft)	VAA020	\$29.95		
Replacement Power Cord (5 1/2-ft)	187802	\$10.15		
Antenna Adapter	193983	\$ 6.95		
Antenna Mixer	193984	\$10.73		
Antenna Mixer	197551	\$10.95		
Replacement Remote Control CRK70D2	233063	\$41.00		
Simple Touch™ Remote	206800	\$38.15		

✂ Detach Here

Prices are subject to change without notice

Total Merchandise (\$10 Minimum Order)..... \$ _____
Sales Tax \$ _____

We are required by law to collect the appropriate sales tax for each individual state, county, and locality to which the merchandise is being sent.

Shipping, Handling, and Insurance..... \$ 5.00
Total Amount Enclosed..... \$ _____

Use VISA or MasterCard preferably. Money order or check must be in U.S. currency only. No COD or CASH.

All accessories are subject to availability.
Where applicable, we will ship a superseding model.

Note: All specifications and descriptions of accessories are subject to change without notice.

Please complete other side also

Accessory Order Form (continued)

Charge your order on your VISA
or MasterCard by
filling in below

USE YOUR CREDIT CARD

IMPORTANT: Copy complete account number
from your VISA card



My card expires:

IMPORTANT: Copy complete account number
from your MasterCard



Copy Number
above your
name on
MasterCard

My card
expires:

AUTHORIZED SIGNATURE

Prices are subject to change without notice.

PLEASE

Print or type your name and
address clearly. This will be your
mailing label.

A complete and correct order will
save you days of waiting.

Name: _____

Street: _____

_____ Apt: _____

City: _____

State: _____ Zip: _____

To order accessories, contact your local dealer.
If a dealer is not nearby, you can also follow the directions
below to order by telephone or direct-by-mail.

United States and Canada Orders

To place your order by phone, have your Visa or MasterCard
ready and call the toll-free number listed below between 8AM
and 8PM Eastern Standard Time. **Use this number only to
place an order for accessory items listed on this order
form.**

1 - 800 - 338 - 0376

Most times your order will be shipped UPS within 72 hours
of receipt. If ever it is not possible to ship within 30 days, we
will notify you with an update on your order and an option to
cancel.

To place your order by mail, detach and mail the completed
order form with credit card information, money order, or
check in U.S. currency (made payable to Thomson Consumer
Electronics, Inc.) to the following address:

Video Accessories
PO Box 8419
Ronks, PA 17573

**For more information on these accessories (or current
prices), write to the following address:**

Video Accessories Customer Service
Thomson Consumer Electronics, Inc.
Distributor & Special Products
2000 Clements Bridge Rd
Deptford, NJ 08096-2088

International Orders

This offer is valid only in the 50 United States and Canada.
For international orders, please send your request for
quotation (not an order) to:

International Customer Service
Thomson Consumer Electronics, Inc.
Distributor & Special Products
2000 Clements Bridge Rd
Deptford, NJ 08096-2088 USA

Detach Here

Please make sure that both sides of this form have
been filled out completely.

Cleaning and Care

Dust TV as required, using a soft cloth or the dusting attachment of your vacuum cleaner. Occasionally vacuum the ventilation slots in the cabinet to help assure adequate ventilation. Take care not to scratch the plastic surfaces.

If your TV's cabinet has a textured finish, do not use furniture polish. Because textured finishes are porous, using furniture polish will mar their appearance. They can be easily cleaned with a damp, soft cloth.

To clean the screen, you can wipe it with a damp soft cloth. (A very diluted, mild soap can be used on the screen if it is extremely dirty.) You can also use a non-abrasive glass cleaner like Windex® or Glass Plus® with a soft cloth. Be sure to apply cleaner to a cloth. Do not put cleaner directly on the screen.

Do not use strong cleaners, polishes, or chemically-treated cloths to clean the screen or cabinet.

Never place drinks or vases with water on top of your TV.

Trouble Checks

Troubles sometimes are caused by simple "faults" that you can easily correct without the help of a service technician by first checking a few basic remedies.

Before you call or take your unit to an Authorized RCA TV Servicenter, look below for the type of trouble you are experiencing. Then perform the simple checks and adjustments listed for that trouble.

If your unit is still in warranty, these checks and adjustments could save you time and the cost of an unneeded trip to the servicer. They also could save you the cost of a diagnosis not covered by your warranty.

If your unit is out of warranty, these checks and adjustments could save you the cost of an unneeded diagnosis. If service should be necessary, the warranty explains how to get it.

Trouble	Checks and Adjustments
TV will not turn on	<ul style="list-style-type: none"> • Check to make sure TV is plugged in. • Check the wall receptacle (or extension cord) to make sure it is "live" by plugging in something else. • Maybe batteries in remote control are "dead". Try replacing batteries. • Maybe remote is not aimed at remote sensor. Press <i>POWER</i> button on TV. • Make sure power cord is fully inserted into back of TV.
Controls don't work	<ul style="list-style-type: none"> • If using remote control, make sure remote is in "TV Mode" by first pressing the <i>TV</i> button. • Try unplugging set for two minutes and then turning it on again. • Make sure power cord is fully inserted into back of TV.
Intermittent or no remote	<ul style="list-style-type: none"> • Maybe something is between the remote and the remote sensor. • Maybe the remote is not aimed directly at the component (TV or VCR) you are trying to control. • Maybe remote is not in "TV Mode". Press the <i>TV</i> button so remote will control TV. • Maybe batteries in remote are weak or dead. Try replacing batteries. • Maybe batteries are installed incorrectly. Try replacing batteries correctly. • Remove batteries and hold down one or more buttons for several seconds. Re-install the batteries and try remote again.
Turns off while playing	<ul style="list-style-type: none"> • <i>SLEEP TIMER</i> function may have been activated. • <i>ALARM OFF</i> function may have been activated. • Electronic protection circuit may have been activated because of a power surge. Wait 30 seconds and then turn on again. If this happens frequently, the voltage in your house may be abnormally high. • Make sure power cord is fully inserted into back of TV.
Turns on unexpectedly	<ul style="list-style-type: none"> • <i>ALARM ON</i> function may have been activated.
Alarm does not turn off TV at correct time	<ul style="list-style-type: none"> • Check <i>ALARM ON/OFF</i> function. Must be set to <i>ON</i>. • Check to make sure <i>CLOCK</i> function is set to the correct time.
Blank Screen	<ul style="list-style-type: none"> • Maybe Channel 90, 91, or 92 selected, but device connected to those <i>INPUT</i> jacks is not turned on. • Try another channel.
No sound, picture okay	<ul style="list-style-type: none"> • Maybe sound is muted. Try pressing <i>VOL</i> up button to restore sound. • Maybe TV's speakers are turned off. Check <i>SPEAKERS ON/OFF</i> function. • Check position of <i>SPEAKER</i> switch on back of TV.

continued on next page

Trouble Checks

Trouble	Checks and Adjustments
Can't select certain channel	<ul style="list-style-type: none"> • Channel may not be in Channel Memory. Try pressing number buttons. • If using VCR, check to make sure <i>TV/VCR</i> switch on VCR is in correct position. • To select cable channels 100 thru 128, press number button 1 until 1-- appears. Then press other two number buttons. <i>CABLE/AIR</i> function must be in <i>CABLE</i> mode to select channels higher than 69. • Channel may be locked-out with Parental Control feature.
Noisy stereo reception	<ul style="list-style-type: none"> • May be a weak station. Change <i>STEREO/SAP</i> function to <i>MONO</i> setting instead of <i>STEREO</i>.
No picture, no sound but power light is on	<ul style="list-style-type: none"> • Maybe someone changed <i>CABLE/AIR</i> function to wrong position. • Maybe a vacant channel is tuned. • For Channels 90, 91, and 92, make sure the component connected to those <i>INPUT</i> jacks is turned on in order to see the picture. • If watching VCR (connected only through antenna input), make sure TV is tuned to channel 3 or 4—same as <i>CH3/CH4</i> switch on VCR. Also check to make sure <i>TV/VCR</i> switch on VCR is in correct position.
Sound okay, picture poor	<ul style="list-style-type: none"> • Check antenna connections. • Try adjusting <i>SHARPNESS</i> function to improve weak signals.
Picture okay, sound poor	<ul style="list-style-type: none"> • Try another channel. • Try adjusting <i>VOLUME</i>, <i>BASS</i>, and <i>TREBLE</i> controls. • If station is sending stereo, try changing <i>STEREO/SAP</i> function to <i>MONO</i> setting for clearer sound. • Try adjusting <i>SRS</i> (●) controls to turn <i>SRS</i> (●) off or on.
No stereo on known stereo station	<ul style="list-style-type: none"> • Make sure <i>STEREO/SAP</i> function is in <i>STEREO</i> mode.
Can't get two channels in Pix-in-Pix	<ul style="list-style-type: none"> • If using the <i>VCR1</i> or <i>VCR2•LD</i> button, make sure it is programmed to select the proper video input channel as described on page 26. • If using an S-VHS component, make sure its regular <i>VIDEO</i> cable is connected to <i>INPUT 1 VIDEO</i> jack on the TV. • If using a VCR, make sure the <i>AUDIO</i> and <i>VIDEO OUT</i> jacks on the VCR are connected to the TV's <i>AUDIO</i> and <i>VIDEO IN</i> jacks.
No picture while using Pix-in-Pix, with S-VHS VCR or camcorder	<ul style="list-style-type: none"> • If you have an S-VHS VCR (or camcorder) connected, you must also connect a cable from the VCR's <i>VIDEO OUT</i> jack to the TV's corresponding <i>VIDEO IN</i> jack in addition to the S-VHS cable.
Small picture does not have color.	<ul style="list-style-type: none"> • The small picture will not have color if the large picture signal does not have the color burst reference. All color signals and some black-and-white signals are sent with color burst information. Try changing channels of the large picture.
Remote no longer controls cable box, VCR or audio equipment	<ul style="list-style-type: none"> • Try not to press any buttons on the remote while changing its batteries. You may have to reprogram the proper code into the remote.

Trouble Checks

Trouble	Checks and Adjustments
No closed captioning	<ul style="list-style-type: none">• Turn on the <i>CAPTIONING</i> function.• TV program does not have closed captioning.
Black bars appear on the screen	<ul style="list-style-type: none">• Turn off the <i>CAPTIONING</i> function.

Limited Warranty

What your warranty covers:

- Any defect in material or workmanship.

For how long after your purchase:

- One year for labor charges.
- One year for parts.
- Two years for picture tube.

The warranty period for rental units begins with the first rental.

What we will do:

- Pay any Authorized RCA Television Servicenter the labor charges to repair your television.
- Pay any Authorized RCA Television Servicenter for the new or, at our option, rebuilt replacement parts and picture tube required to repair your television.

How you get service:

- Request home service from any Authorized RCA Television Servicenter. To identify your nearest Authorized RCA Television Servicenter, ask your Dealer, look in the Yellow Pages, or call 1-800-336-1900.
- Show the service technician your evidence of purchase date.

What your warranty *does not* cover:

- Customer instruction. (Your Owner's Manual clearly describes how to install, adjust, and operate your television. Any additional information should be obtained from your Dealer.)
- Installation and related adjustments.
- Signal reception problems not caused by your television.
- Damage from misuse or neglect.
- Remote control batteries.
- A television that has been modified or incorporated into other products or is used for institutional or other commercial purposes.
- A television purchased or serviced outside the USA.
- Acts of God, such as but not limited to lightning damage.

Product Registration:

- Please complete and mail the *Product Registration Card* packed with your set. It will make it easier to contact you should it ever be necessary. The return of the card is not required for warranty coverage.

How state law relates to this warranty:

- This warranty gives you specific legal rights, and you also may have other rights that vary from state to state.

If you purchased your television in outside the United States:

- This warranty does not apply. See your dealer for warranty information.

Index

+ and - Buttons	4,5,6,11,20-27	HI FI OUT Jacks	29,41	Sleep Timer, Clearing	20
Accessories	44,45,46	Home Antenna	30	Sound Retrieval System (•).....	11,17
Adding Channels to Memory	24	INPUT Button.....	11	SPEAKER Switch	29,43
ALARM Function.....	18,21	Installing Batteries.....	8	Speaker Connections	43
Amplifier	41	Interference.....	28	SPEAKERS Function.....	16,43
Antenna Adaptor.....	30	Labeling Channels	22	SRS (•) Button	11
ANT Button	11,25	Last Function Memory	16,18	SRS (•) Function.....	16,17
Antenna Connections.....	30	Locking Out Channels	23	SRS WIDTH Function.....	16,17
Antenna Function	25	Memory (Channel)	18,24,26	SRS:ON/OFF Function.....	16,17
AUDIO Button	9,42	MENU•PROG Button.....	4,5,6,11	STEREO Indicator.....	7,17
AUDIO MENU.....	5,16,17	Mode, TV	10,12	STEREO/SAP Function	16,17
AUTOPROGRAM Function	4,18,24	Monitor Panel	29	STOP Button.....	37
BALANCE Function	16	MONO Position.....	16	SWAP Button.....	11,13
BASS Function.....	16	MOVE PIP Button.....	13	Theory, Remote Control	8
Batteries (Remote).....	8	MUTE Button	11	Time Display	7
Best Picture.....	14	NORM/UNIFIED Switch.....	38	TINT Adjustment	14
Brand Lists.....	33,38,42	OFF TIME Function.....	21	TREBLE Function.....	16
BRIGHTNESS Adjustment	14	ON TIME Function	21	Trouble Checks.....	48-50
Buttons, Remote	10,11,37	On-Screen Displays	7	TV Button.....	3,6,7,10,12,18
Buttons, VCR.....	37	Optional Accessories	45,46,47	TV Mode.....	10,12
CABLE CHAN Function.....	18,27	Order Form (Accessories)	45,46	VCR 1 CHAN Function	18,26
Cable Box Setup	33	PARENTAL CONTROL Display.....	7,23	VCR 2 CHAN Function	18,26
Cable-TV	31,33,34	PARENTAL CTRL Function.....	18,23	VCR Channel Setup.....	26
CABLE/AIR Function.....	18,26	PAUSE Button	37,42	VCR Connections	35,36
CABLE/ANTENNA Connector	29,30	PICTURE RESET Function	14	VCR Mode.....	37
Camcorder	39	Picture Adjustments.....	14	VCR1 Button	9,26,37
Care.....	47	Picture Memory	14	VCR2•LD Button	9,26,37
Cassette Tape Deck.....	41	Picture-in-Picture.....	12,13	VIDEO MENU	5,14
CHAN CTRL Function	18,23	Picture-in-Picture Buttons	11,12,13	Video Game Caution	1
CHAN LABEL Function.....	22	PIP Button.....	11,12,13	Video Input Channels	23,30,35,36,37
CHAN MEM Function	4,18,24	PLAY Button	37	VOL (Volume) Buttons	3,10
Channel Labeling.....	22	POWER Button	6,10,37	Warranty	51
Channel Memory	18,24,26	Power Cord	28	Warranty Registration	
Channels 90,91,92	7,11,14,24,26,29,34	Power Failures	4,21	Card	Inside Front Cover
Channels above 99	3,11	Power Indicator.....	6		
Chart (Cable Channels)	32	Precautions (Safety)	Inside Front Cover		
CLEAR Button	11,19,20,22,35	PREV CH Button.....	11		
Closed Captioning	19	Product Registration	Inside Front Cover		
CLOCK SET Function	4,21	Programming Remote.....	33,38,42		
COLOR Adjustment	14	REC (Record) Button	37		
Color Convergence	13	Registration Card.....	Inside Front Cover		
Commercial Skip	10	Remote Control	8-11,37		
Commercial Skip Display.....	7	Remote Sensor.....	8		
Computers.....	40	Repair.....	51		
CONTRAST Adjustment	14	REW (Rewind) Button	37		
Controls (Front Panel)	6	Safety Precautions	Inside Front Cover		
Controls (Remote)	8-11	SAP	16		
CONVERTER Jack	33	SAT•CABLE Button.....	9,33		
Custom Picture Memory.....	14	Scrambled Channels	31,34		
Decoder Box	31	SELECT OUT Jacks.....	29,39,41		
Deleting Channels from Memory	24	Service	51		
DISPLAY Button	7,11	SET CLOCK Display	4,21		
Erasing Channels from Memory.....	24	Setting Sleep Timer	20		
Erasing Labels	22	SETUP MENU	4,5,18,20-27		
EXTERNAL SPEAKERS Terminals	43	SHARPNESS Adjustment.....	14		
FF (Fast Forward) Button.....	37	SKIP Button.....	10		
FREEZE Button.....	11	SLEEP Display	7,20		
Front Panel Controls.....	6	SLEEP TIMER Function.....	18,20		
Function Buttons.....	9	Sleep Timer Display	20		



CREATING A GREENER FUTURE

At Thomson Consumer Electronics we are dedicated to the preservation of our natural heritage and to a healthy and safe way of life for current and future generations. This is a global effort which encompasses every THOMSON facility throughout the world.

We believe that clean air, clean water, a protected earth, and healthy people are not only practical and desirable goals, but achievable ones as well. Our Corporate Environmental, Health and Safety Charter acknowledges our commitment to protect these precious assets and provides a challenging vision and guideline for conducting our business.

THOMSON CONSUMER ELECTRONICS

Below are a few examples of Thomson's achievements in our efforts to preserve our natural resources.

THE EARTH

Thomson reclaims millions of pounds of hazardous waste annually, diverting it from landfills.

Thomson treats millions of pounds of waste water sludge annually and renders it non-hazardous.

Thomson recycles over 50 million pounds of non-hazardous material annually that otherwise would have been treated as trash, an overall recovery rate of 50%.

Thomson globally recycles millions of pounds of broken television picture tube glass annually through both internal and external reclaim processes.

THE AIR

Thomson has replaced solvent-based paints at many locations resulting in an 80% reduction in toxic air emissions for equivalent material used.

Thomson has eliminated the use of ozone-depleting substances at television manufacturing facilities around the world.

Thomson collects and returns over 1.5 million pounds of glass and furnace dust to the glass making process annually.

Thomson has launched worldwide energy savings programs which contribute to efforts to reduce air emissions from electrical generating facilities.

THE WATER

Thomson recovers over 2 million pounds of fine glass particles from process water each year and recycles them back into its glass furnaces.

Thomson's state-of-the-art waste water treatment plants filter out over 26 million pounds of solids from process water each year.

Thomson's U.S. glass factory recycles 2,500 gallons of water per minute and cleans 2.6 million gallons of water per day.

Thomson is researching new processes and is developing new manufacturing equipment and technologies to further reduce large volume water use.

Thomson has also increased its usage of recycled materials for packaging of our products. For example, in the U.S. and Mexico our television plants use recycled content in our television cartons and instruction booklets. The inks used for the print on cartons and instruction booklets are soy based. For a free brochure regarding Thomson's Environmental Health and Safety Programs, write to Thomson Consumer Electronics' address below, attention Environmental Programs: INH340.

Please do not send any products to the Indianapolis address listed in this manual or on the carton. This will only add delays in service for your product.

THOMSON CONSUMER ELECTRONICS

10330 North Meridian Street
Indianapolis, IN 46290

©1996 Thomson Consumer Electronics, Inc.
Trademark(s)® Registered
Marca(s) Registrada(s)
Printed in USA
TOCOM 1508388A

The following materials were used in printing this publication:



Free Manuals Download Website

<http://myh66.com>

<http://usermanuals.us>

<http://www.somanuals.com>

<http://www.4manuals.cc>

<http://www.manual-lib.com>

<http://www.404manual.com>

<http://www.luxmanual.com>

<http://aubethermostatmanual.com>

Golf course search by state

<http://golfingnear.com>

Email search by domain

<http://emailbydomain.com>

Auto manuals search

<http://auto.somanuals.com>

TV manuals search

<http://tv.somanuals.com>