

RCA

USER'S GUIDE

camcordercamcordercamcor
dercamcordercamcordercam
cordercamcordercamcorder
camcordercamcordercamcor
dercamcordercamcordercam
cordercamcordercamcorder
camcordercamcordercamcor
dercamcordercamcordercam
cordercamcordercamcorder
camcordercamcordercamcor
dercamcordercamcordercam
cordercamcordercamcorder
camcordercamcordercamcor
dercamcordercamcordercam
cordercamcordercamcorder
camcordercamcordercamcor
dercamcordercamcordercam
cordercamcordercamcorder
camcordercamcordercamcor
dercamcordercamcordercam
corderca morder
camcor derca
mcord erc
am cor
de rca
m cord
er cam
co rd
e r



CC6372/CC6392

Important Safety Information

Be sure to read all the safety information before you begin to use this product.

WARNING: To reduce the risk of fire or shock hazard, do not expose camcorder or AC adapter/charger to rain or moisture.

CAUTION

RISK OF ELECTRIC SHOCK
DO NOT OPEN



This symbol indicates “dangerous voltage” inside the product that presents a risk of electric shock or personal injury.

ATTENTION

RISQUE DE CHOC ELECTRIQUE
NE PAS OUVRIR



This symbol indicates important instructions accompanying the product.

TO REDUCE THE RISK OF ELECTRIC SHOCK, DO NOT REMOVE THE COVER (OR BACK). NO USER-SERVICEABLE PARTS ARE INSIDE. REFER SERVICING TO QUALIFIED SERVICE PERSONNEL.

Cautions

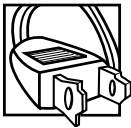

CAUTION: To prevent electric shock, match wide blade of plug to wide slot, fully insert.

ATTENTION: Pour éviter les chocs électriques, introduire la lame la plus large de la fiche dans la borne correspondante de la prise et pousser jusqu'au fond.

To reduce risk of injury, charge only rechargeable batteries recommended by the manufacturer for this camcorder. Other types of batteries may burst causing damage and personal injury.

FCC Regulations state that unauthorized changes or modifications to this equipment may void the user's authority to operate it.

Product Registration

Please fill out the product registration card and return it immediately. Returning this card allows us to contact you if needed.

Keep your sales receipt for proof of purchase to obtain warranty parts and service and attach it here. Record the serial number and model numbers located on the bottom of the camcorder.

Model No: CC6372/CC6392

Serial No: _____

Purchase Date: _____

Purchased From: _____

Assistance

We want to make sure you enjoy your new camcorder. If you have any questions, call:

Camcorder Exchange Warranty.....800-283-6503 (pages 81-82)

Customer Service.....800-336-1900 (page 80)

Accessories..... 800-338-0376 (pages 67-72)

Table of Contents

Assistance	3	Recording	24
First-Time Operation	3	Time-Remaining Display	24
Power Your Camcorder	12	Select a Tape Length	24
Adapter/Charger	12	Use the LCD Monitor or Viewfinder to See What You Record	26
Rechargeable Battery	13	Use the LCD Monitor	26
Charge the Battery	14	Use the Viewfinder	27
Battery Level Indicator	15	LCD Monitor and Viewfinder	
Battery Care and Storage	15	Displays	28
Optional Car Cord Adapter	16	AutoShot™ Mode	32
Date and Time Display	17	Five-Second Record Feature	33
Install the Clock Lithium Cell	17	Tally Light	33
Set the Date and Time	18	Quick Review Feature	33
Record <i>AUTO DATE</i> , Date, Time, and Title Displays	20	Camera Edit Feature	33
Videocassettes	22	Flying Erase Head	33
Erase Protection – Safety Tab	22	<i>MENU/DISPLAY</i> Button	33
Recording and Playback		Zooming	34
Speeds and Times	22	Use the Zoom Lever (<i>W</i> and <i>T</i>)	34
Insert and Remove Cassettes	23	Digital Zooming	34
Cassette Care and Storage	23	Tele Macro Zooming	35
		Focusing	36
		Auto Focus	36
		Manual Focus	37

Table of Contents

White Balance	38
Auto White Balance	38
Manual White Balance	38
Exposure Control	40
Manual Exposure	40
Auto Exposure	40
Steady Pix™ Feature	41
Fade or Wipe In or Out	42
<i>P.</i> (Program) <i>AE</i> Button	44
16X9 Mode	45
Preset Titles	46
Select a Language for the Title	46
Record a Preset Title	47
Self-Timer Recording	48
Animation Recording	50
Time-Lapse Recording	52
Tally Light (Turn On or Off)	54
Demo Mode	55
Attach the Shoulder Strap	56
Recording Tips	57
Use the LCD Monitor or Viewfinder for Playback	58
To Play Back a Tape	59
Playback Features	60
Position the Tape	60
Visual Search	60
Stop-Action Pause	60
Time Counter	61
Tracking	61
Use the Cassette Adapter	62
Playback on TV (or VCR) with Audio/Video Inputs	64

Traveling Tips	66
Optional Accessories	67
Using the Optional AC088 Tripod	69
Order Form for Camcorder Models CC6372 and CC6392	71
Trouble Checks	73
Specifications	77
Clean the Camcorder	78
Clean the Camcorder's Lens	78
Clean the Camcorder's LCD Monitor	78
Clean the Camcorder's Viewfinder	78
Proper Care and Storage	79
Things to Avoid	79
Customer Assistance and Service	80
Limited Warranty	81
Index	83
Information to User	89

First-Time Operation

This section describes the steps necessary to set up your camcorder to record. Refer to the other sections for detailed operation and feature options.

Assistance

The toll-free numbers are available to help you with any problem you may encounter.

Camcorder Exchange Warranty.....800-283-6503

Customer Service..... 800-336-1900

Accessories..... 800-338-0376

1. Unpack the camcorder and accessories.

- Save the packing materials and box in case you ever need to ship or store your camcorder.
- The items shown below are packed with your camcorder. If any are missing or appear damaged, contact your dealer immediately.

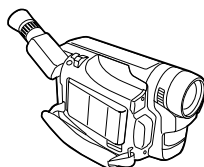

Model CC6372* or Model 6392*

(*Your camcorder may appear slightly different than the one shown.)

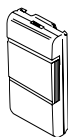

**Model CC6372
Rechargeable Nickel
Cadmium Battery
Part No FB1260**

**WARNING: NICKEL
CADMIUM BATTERY
MUST BE RECYCLED
OR DISPOSED OF
PROPERLY.**

**Model CC6392
Rechargeable Nickel
Metal Hydride Battery
Part No 244265**



**AC Adapter/Charger
and DC Cable**

**Part No. 244269
Part No. 244268**

Caution: Do not use this adapter/charger for any purpose other than charging the FB1260, or 244265 battery pack or supplying power to the camcorder.

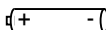

**Cassette Adapter Battery
(Size "AA" 1.5 Volt)**

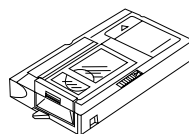

**Cassette Adapter
Part No. 244270**

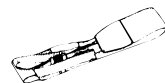

**Shoulder Strap
Part No. ACS091**



**Clock Cell
3-Volt Micro Lithium
Cell – such as CR2025 –
available from most local
drug stores and camera
shops. Use of other cells
present a risk of fire or
explosion.**

CAUTIONS: Lithium cell must be disposed of properly. Never handle punctured or leaking cell. May cause burns or personal injury.

Keep out of the hands of children. Can cause death or injury if swallowed. If swallowed, consult a physician immediately for emergency treatment.

The lithium cell used in this device may explode resulting in a fire or chemical burn if mistreated. Do not recharge, disassemble, heat above 212°F (100°C), or incinerate.

Never use metallic tweezers to hold the cell, and never short circuit the + and – sides of the cell.

(continued on next page)

First-Time Operation

2. Attach the adapter/charger.

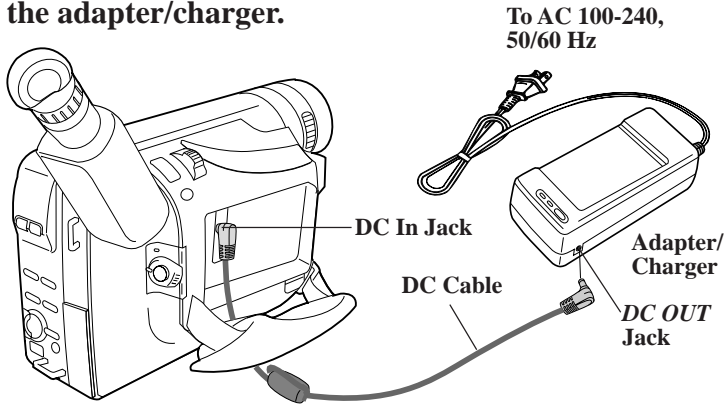

Since the battery must be charged before it can be used the first time, attach the adapter/charger to the camcorder.

- Connect one end of the DC cable to the *DC OUT* jack on the adapter/charger.
- Connect the other end of the DC cable to the DC in jack on the camcorder *as shown above*.
- Plug the adapter/charger's plug into an operating outlet.

3. Adjust the handstrap to fit your hand.

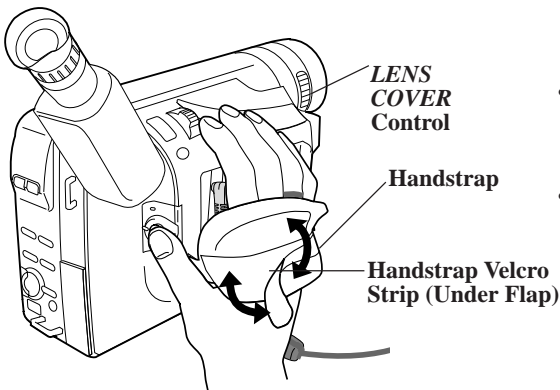

- Lift the flap on the handstrap and separate the velcro strip.
- Insert your hand, adjust the strap to fit snugly, refasten the strap, and close the flap.

4. Rotate *LENS COVER* control to open lens cover.

First-Time Operation

5. Insert a tape.

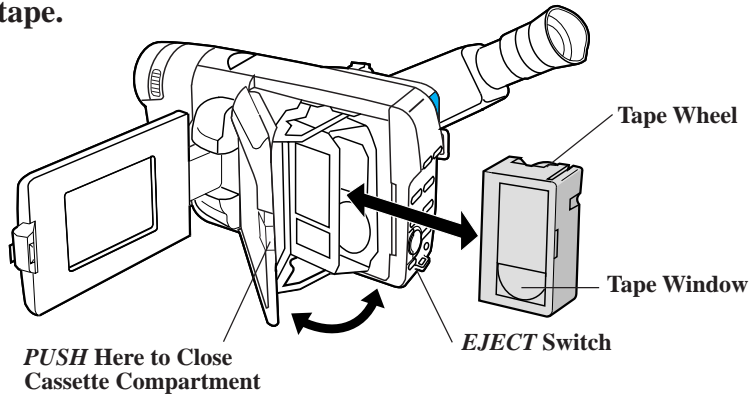

- Open the LCD monitor at least 60° before opening the cassette holder.
- Slide the *EJECT* switch. The cassette holder opens automatically.
- Turn the tape wheel on the cassette to remove any slack from the tape.
- Insert the cassette with the tape wheel facing up and the tape window facing out.
- Press on the area labeled *PUSH* until the cassette holder locks into place.

6. Select a recording speed.

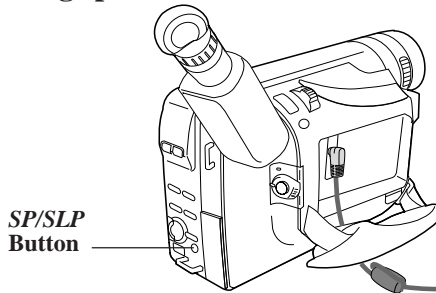

Select SP or SLP recording speed. Press *and hold* the *SP/SLP* button to select a recording speed. The tape speed you select (*SP* or *SLP*) appears in the viewfinder or on the LCD monitor.

- SP – Standard play provides the best picture, but the shortest recording time (20 minutes with a TC-20 tape).
- SLP – Extended play provides three times the recording time as SP (60 minutes with a TC-20 tape). SLP has slightly more picture noise in normal playback.

(continued on next page)

First-Time Operation

7. Set **POWER** (*CAMERA MAN/CAMERA AUTO/OFF/VCR*) switch to **CAMERA AUTO**.

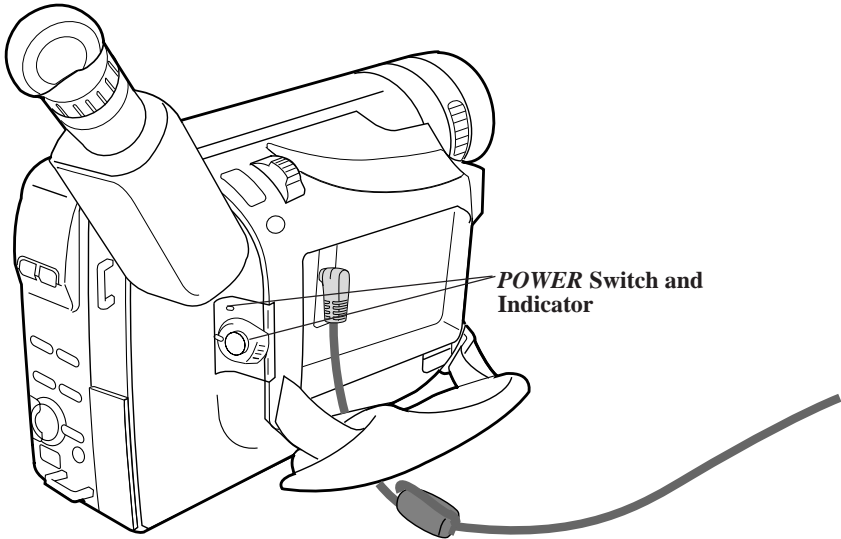

- The power indicator lights and the camcorder enters record-pause.
 - appears in the viewfinder or on the LCD monitor when the camcorder is in record-pause.
- The position of this switch tells the camcorder whether you want to record (*CAMERA MAN* or *CAMERA AUTO*), turn the power off (*OFF*), or play back tapes (*VCR*).
- *CAMERA AUTO* places the camcorder in the AutoShot™ mode. In the AutoShot™ mode, the focus, exposure, and white balance are automatically controlled by the camcorder. Many of the special effects do not operate in this mode. *Details on page 32.*
- *CAMERA MAN* allows you to control many of the special features of the camcorder.
- The camcorder automatically turns off if it remains in record-pause for five minutes. Set the *POWER* switch to *OFF* and then back to *CAMERA*.

First-Time Operation

8. Use the Monitor or Viewfinder to See What You Record

You can see what you record on the color LCD monitor or in the viewfinder. When the LCD monitor is open more than 60°, the viewfinder is automatically turned off. When you close the LCD monitor, the viewfinder is automatically turned on.

To enable both you and the person you're recording to see what's being recorded, you can rotate the LCD monitor completely around 180° so the front of the monitor faces the person you're recording. The viewfinder turns on automatically when you turn the LCD monitor all the way around so it faced forward.

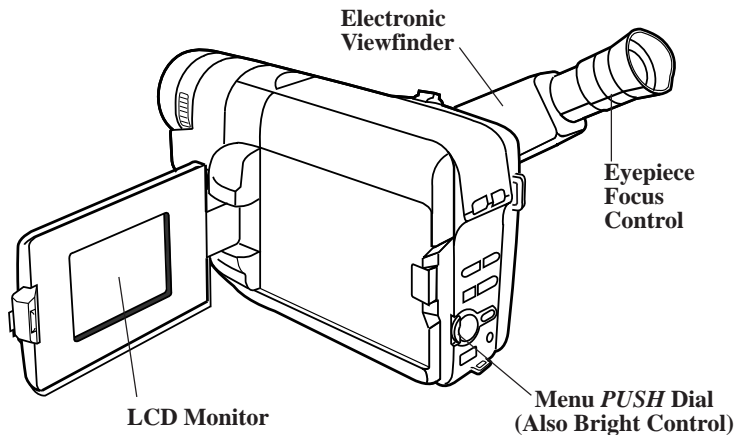

Use the LCD Monitor

- Make sure the monitor is open at least 60°. The viewfinder turns off.
- You can tilt the monitor 180° up or 90° down for convenient viewing.
- Rotate the menu *PUSH* dial to adjust the brightness of the image in the monitor.

- Turn the eyepiece focus control to adjust the focus of the viewfinder for your vision.

Use the Viewfinder

- Close the monitor. If the monitor is open more than 60°, the viewfinder turns off.
- Adjust the viewfinder for a comfortable viewing position.

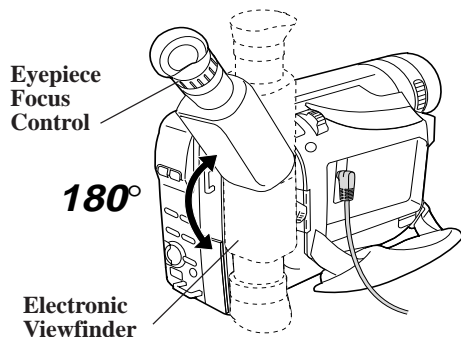

(continued on next page)

First-Time Operation

9. Select a tape length.

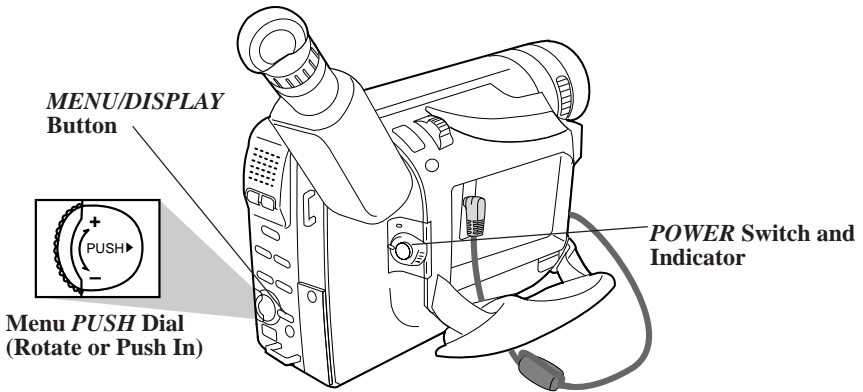

1. Set the *POWER* switch to *CAMERA MAN*.
2. Press the *MENU/DISPLAY* button to display the menu in the viewfinder or on the LCD monitor.

D. ZOOM	<input checked="" type="checkbox"/> ON
TELE MACRO	<input type="checkbox"/> OFF
TAPE LENGTH	T30
REC TIME	<input type="checkbox"/> OFF
INT. TIME	<input type="checkbox"/> OFF
TALLY LAMP	<input type="checkbox"/> ON
DATE/TIME	
TITLE LANG.	ENGLISH
DEMO MODE	<input type="checkbox"/> OFF
▶RETURN	

3. Rotate the menu *PUSH* dial to highlight *TAPE LENGTH*.

D. ZOOM	<input type="checkbox"/> ON
TELE MACRO	<input type="checkbox"/> OFF
TAPE LENGTH	<input checked="" type="checkbox"/> T30
REC TIME	<input type="checkbox"/> OFF
INT. TIME	<input type="checkbox"/> OFF
TALLY LAMP	<input type="checkbox"/> ON
DATE/TIME	
TITLE LANG.	ENGLISH
DEMO MODE	<input type="checkbox"/> OFF
▶RETURN	

4. Press the menu *PUSH* dial in to display the *TAPE LENGTH* menu.

TAPE LENGTH	
T20	
T30	
T40	
EXIT	

5. Rotate the menu *PUSH* dial to highlight the type of tape you are using.

- Select *T20* for a tape with 20 minutes or less recording time in SP.
- Select *T30* for a tape with 30 minutes recording time in SP.
- Select *T40* for a tape with 40 minutes recording time in SP.

6. Press the menu *PUSH* dial **twice** to select the tape length and remove the menus.

- *Details are on pages 24-25.*

First-Time Operation

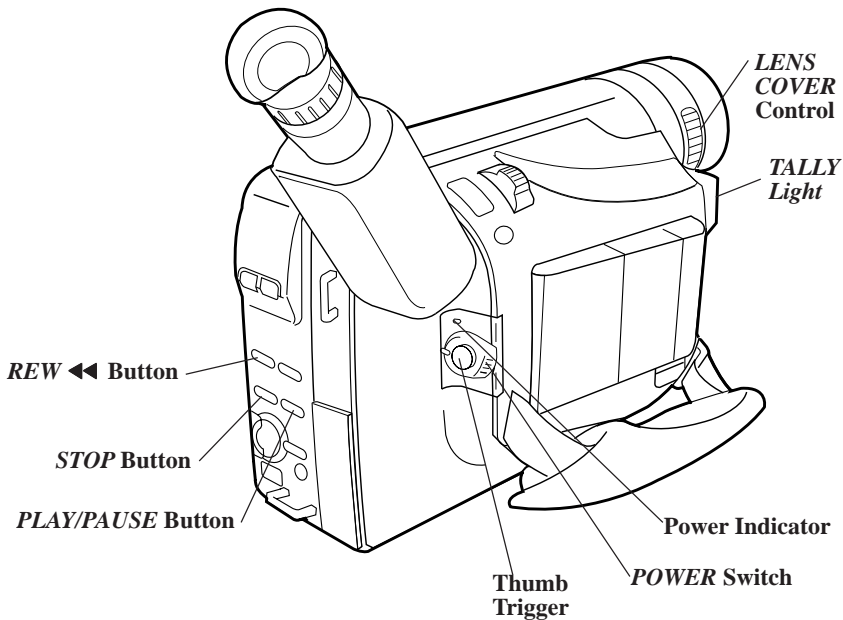

10. Start and stop recording.

- Place the *POWER* switch in *CAMERA AUTO*.
- Press and release the thumb trigger to start recording. **REC** appears in the viewfinder or on the LCD monitor, and the tally light lights while the camcorder is recording.
- Press and release the thumb trigger again to stop recording. The camcorder is now in the record-pause mode. **..** appears in the viewfinder or on the LCD monitor.

11. Play back what you have recorded.

- Set the *POWER* switch to *VCR*.

- Press *REW* ◀◀ to rewind the tape.
- Press *PLAY/PAUSE* to play back the tape.
- Press *STOP* when you are finished playing back the tape.
- *Details on LCD monitor and viewfinder playback are on pages 58-59.*

12. Set the *POWER* switch to *OFF* to turn off the camcorder.

The power indicator turns off.

13. Close the LCD monitor and lens cover.

(continued on next page)

First-Time Operation

14. Review camcorder operating controls.

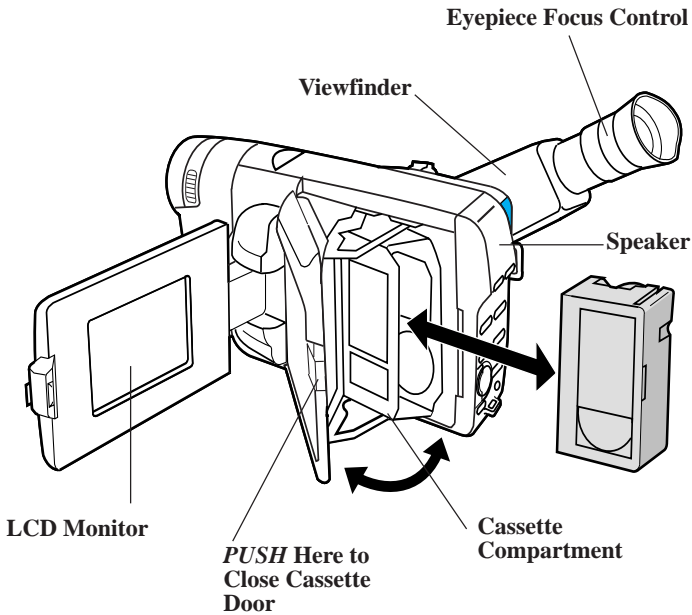
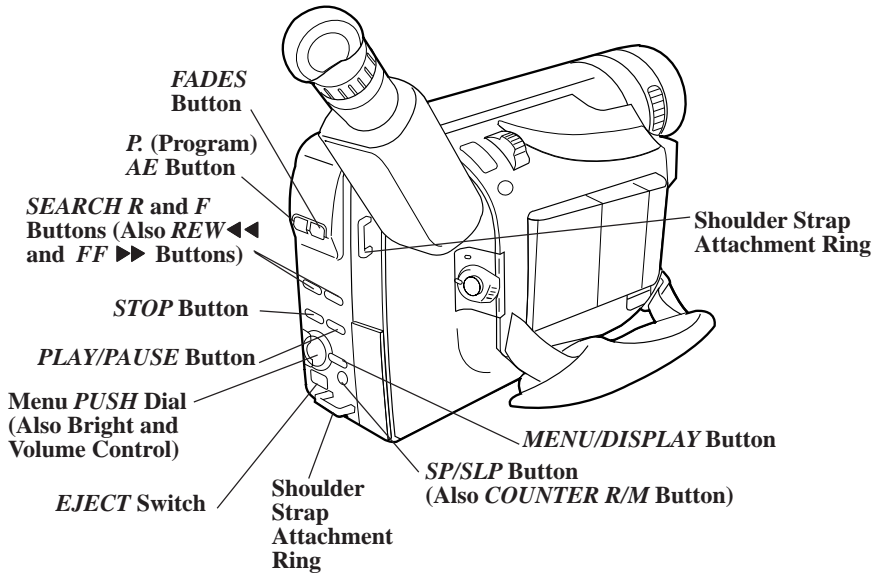

(continued on next page)

First-Time Operation

14. Review camcorder's operating controls. (continued)

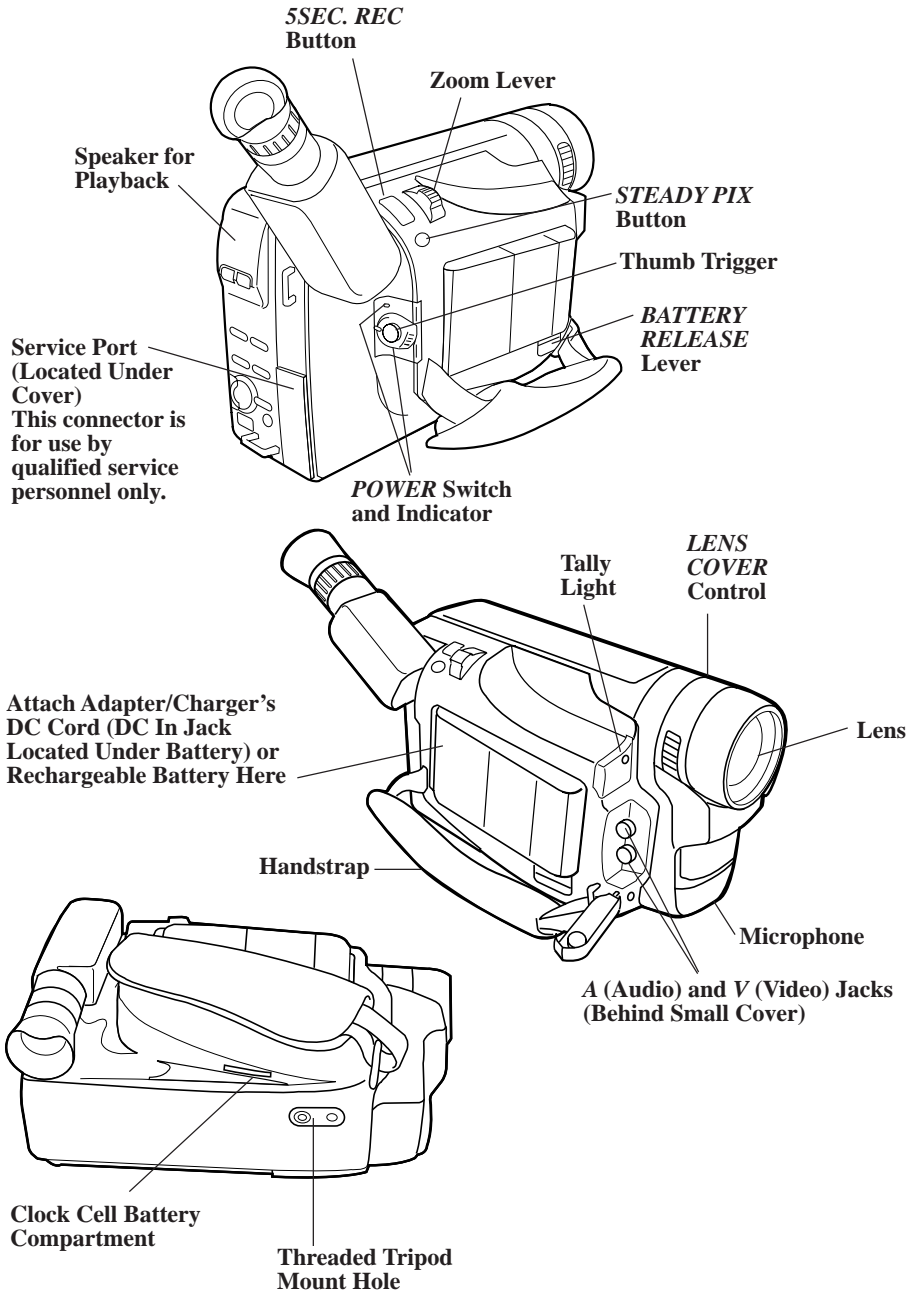

Power Your Camcorder

Adapter/Charger

The adapter/charger attaches to the camcorder and lets you power your camcorder directly from standard household power. The adapter/charger operates on 100-240 volts, 50/60 Hz, so it can be used virtually anywhere in the world to power the camcorder or recharge the battery.

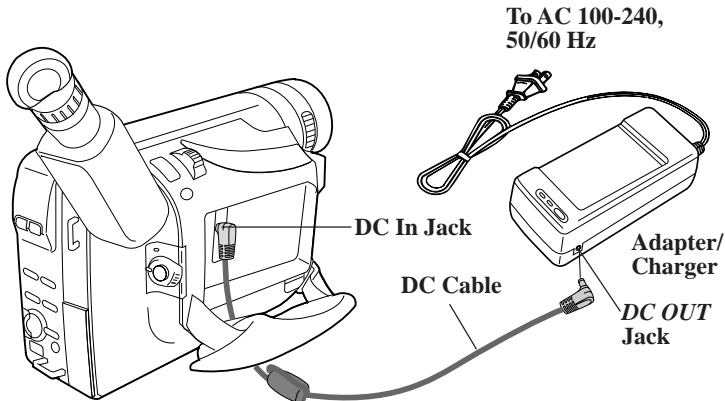

Attach Adapter/Charger

1. Connect one end of the DC cable to the *DC OUT* jack on the adapter/charger.
2. Connect the other end of the DC cable to the DC in jack on the camcorder *as shown above*.
3. Plug the adapter/charger's plug into the nearest AC outlet (100-240V, 50/60Hz).

CAUTION: Do not use this adapter/charger for any other purpose other than charging the FB1260 or 244265 battery pack or supplying power to the camcorder.

Remove Adapter/Charger

1. Unplug the adapter/charger from the wall outlet.
2. Remove the DC cable from the adapter/charger and camcorder.

Using an Optional Plug Adapter

An optional plug adapter might be required in some countries.

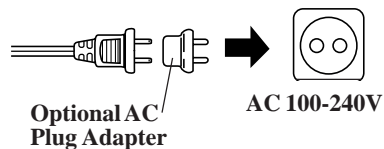

1. Plug the adapter/charger's plug into the AC plug adapter.
2. Plug the AC plug adapter into the AC outlet.

Power Your Camcorder

Rechargeable Battery

The battery must be charged *as described on the next page* before it can be used the first time. Initial charging takes approximately 70 minutes for the FB1260 and 140 minutes for the 244265. When fully charged, the FB1260 supplies approximately 50-55 minutes and the 244265 supplies approximately 100-115 minutes of operating time – depending on how much you use the monitor, zoom, and pause. Conserve battery power by turning the camcorder off during recording breaks.

Note: Use the small marker switch on the top of the battery to help remind yourself to charge the battery. It has no other purpose.

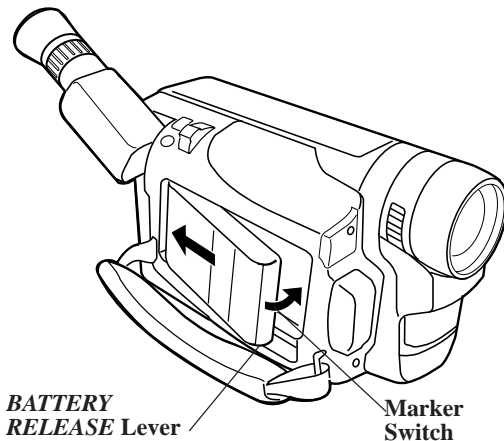

Battery Safety Precautions

Do not short the battery's terminals.

Do not attempt to disassemble or modify the battery. There are no user-serviceable parts inside.

Use the battery only with specified adapter/chargers and camcorders.

Throwing the battery into a fire or exposing it to excessive heat – over 149°F (65°C) could be hazardous.

Attach the Charged Battery

If the DC cable is attached to the camcorder, remove it before attaching the battery. Also, install the lithium clock cell before attaching the battery. *Details are on page 17.*

1. Hook the battery to the side of the camcorder *as shown above*.
2. Press the battery down until it locks into place.

3. Set the *POWER* switch to *CAMERA*. The power indicator lights.

Remove the Battery

Slide and hold the *BATTERY RELEASE* lever down while removing the battery.

ATTENTION: The RBRC seal on the FB1260 battery used in your Thomson Consumer Electronics product indicates that we are participating in a program to collect and recycle Nickel Cadmium batteries throughout the United States. Please call 1-800-8-BATTERY for information or contact your local recycling center.



Power Your Camcorder

Use the Battery to Power Your Camcorder (continued)

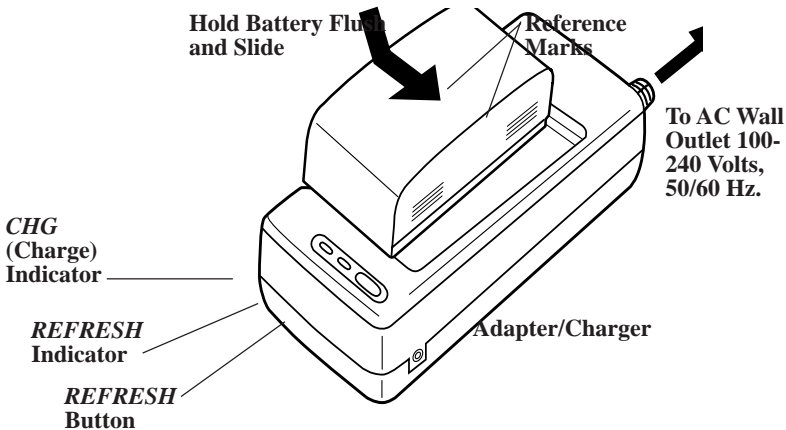

Caution: When a battery is attached to the adapter/charger, do not turn them upside down. The battery may fall off and be damaged or cause injury.

Charge the Battery

If the DC cable is attached to the *DC OUT* jack on the adapter/charger, remove it.

1. Align reference mark on battery with mark on adapter/charger.
2. Hold the battery flush against the adapter/charger and slide it in the direction of the arrow.
3. Plug adapter/charger into nearest AC outlet (100-240V, 50/60Hz).
4. If the battery is properly connected, the *CHG* indicator flashes.

Note: If you try to charge a battery that has not been charged for a long period of time, it may take a few minutes for the *CHG* indicator to flash.

5. After the battery is charged, the *CHG* indicator stops flashing and lights.

6. Remove the charged battery by sliding it off the adapter/charger.
7. Attach the charged battery to the camcorder.

Use the *REFRESH* Button

The battery provides increased operation time if you “refresh” it after five chargings. The refresh feature “refreshes” the battery by completely discharging it.

1. Attach battery to adapter/charger.
2. Press *REFRESH*. The *REFRESH* indicator lights and the battery begins discharging.
3. When discharging is completed, the *REFRESH* indicator turns off, and

Power Your Camcorder

Use the Battery to Power Your Camcorder (continued)





the *CHG* indicator flashes. The battery now charges.

4. After the battery is charged, the *CHG* (charge) indicator stops flashing and lights.
5. Remove the battery from the adapter/charger.

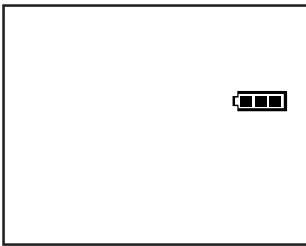
Battery Level Indicator

The battery level indicator appears in the viewfinder or on the LCD monitor and shows you the amount of power in the rechargeable battery.



- When  appears, the battery is fully charged.
- As the power is used  and  appear.
- When the battery power is almost gone,  flashes in the viewfinder. The camcorder turns off automatically after a few seconds. Set the *POWER* switch to *OFF* to turn off the camcorder before replacing the battery.

The battery level indicator is not recorded on the tape.

Battery Care and Storage

- Recharging takes approximately 70 minutes for the FB1260 and 140 minutes for the 244265 depending on the battery's condition.
- Refreshing takes approximately 3-1/2 hours for the FB1260 and 7 hours for the 244265 depending on the battery's condition.
- After repeated charging and use, operation time gradually decreases. When operation time is too short to be useful, it is time to replace the battery.
- If the battery discharging must be stopped in the middle, remove the battery from the adapter/charger before unplugging it from the AC outlet.
- If the battery pack become too hot, remove it from the charger and let it cool down.
- Let a hot battery cool down before attaching it to the AC adapter/charger.

Power Your Camcorder

Optional Car Cord Adapter

The optional DCC08 car cord *shown on page 67* allows you to power your camcorder from the cigarette lighter socket of a car, truck, or RV. It converts 12-volts to a 6-volt output.

Note: Consult the installation and operating instructions enclosed with the DCC08 for complete operating instructions.

Cautions: The DCC08 is designed to be used only with vehicles having negative ground electrical systems.

Use only car cord adapter DCC08 with this camcorder. Use of any other car cord adapter might damage the camcorder and void your warranty.

Use the DCC08 Car Cord Adapter

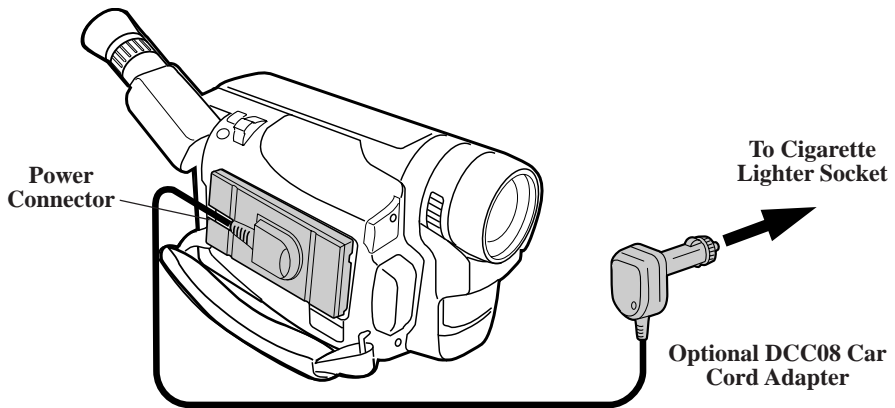

1. Set the *POWER* switch to *OFF* to turn off the camcorder. The power indicator on the camcorder turns off.
2. If the battery or DC cable is attached to the camcorder, remove it.
3. Hold the bottom of the power connector flush against the camcorder, and press the connector down until it locks into place *as shown above*.
4. Take the vehicle's cigarette lighter out of the socket.
5. Insert the car cord's cigarette lighter plug into the vehicle's cigarette lighter socket. The power indicator on the car cord adapter lights.
6. Set the *POWER* switch to *CAMERA* to turn on the camcorder. The power indicator on the camcorder lights.

Caution: Make sure the camcorder's power is turned off before removing the car cord's plug from the cigarette lighter socket.

Date and Time Display

Install the Clock Lithium Cell

The clock cell indicator  flashes for a few seconds in the viewfinder or on the LCD monitor when you turn on the camcorder if the cell is not installed or needs replacing.

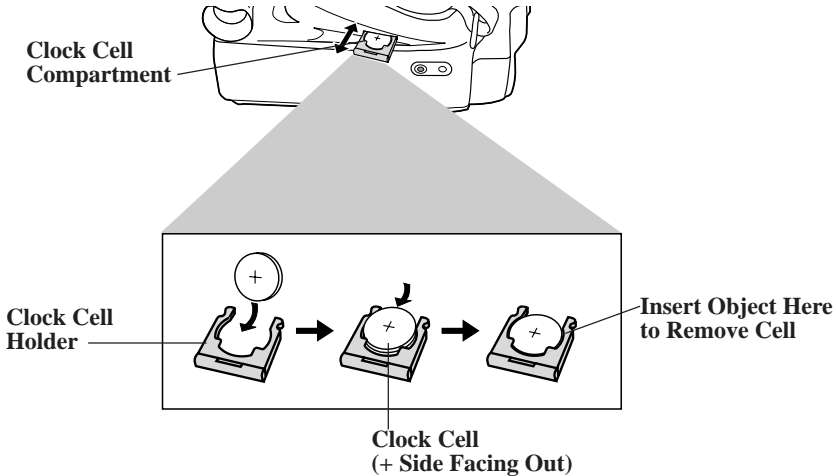

1. Make sure camcorder is turned off, and remove any power supply attached to the camcorder.
2. Pull the clock cell holder out of the clock cell compartment.
3. Insert the clock cell with the “+” terminal facing out, and press it in.
4. Place the clock cell holder into the clock cell compartment. Be sure to insert the holder fully into the compartment.

To Remove Lithium Cell

To remove battery, insert a pointed nonmetallic object between battery and clock cell holder and lift.

Cautions: Lithium cell battery. Replace only with 3-volt lithium cell – such as CR2025. Use of other cell presents a risk of fire or explosion. Must be disposed of properly. Never handle punctured or leaking cell. May cause burns or personal injury.

Keep out of the hands of children. Can cause death or injury if swallowed. If swallowed, consult a physician immediately for emergency treatment.

The lithium cell used in this device may explode resulting in a fire or chemical burn if mistreated. Do not recharge, disassemble, heat above 212°F (100°C), or incinerate.

Never use metallic tweezers to hold the cell, and never short the + and – sides of the cell.

Date and Time Display

Set the Date and Time

You must set the correct date and time before you can display and record it on your tapes. The clock cell must be installed *as shown on the previous page* before you can set the date.

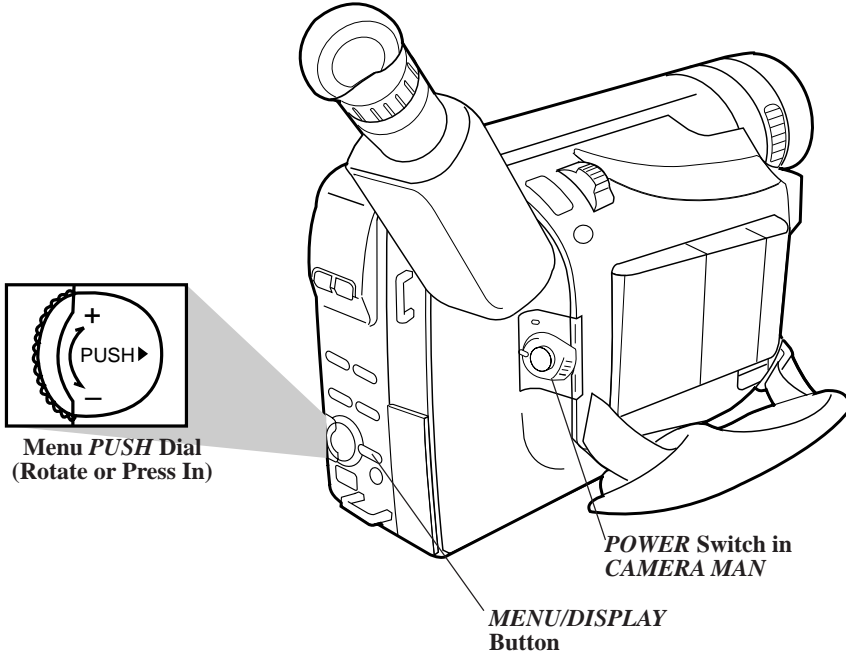

1. Set the *POWER* switch to *CAMERA MAN*.
2. Press the *MENU/DISPLAY* button to display the menu in the viewfinder or on the LCD monitor.
3. Rotate the menu *PUSH* dial to highlight *DATE/TIME*.

D. ZOOM	ON
TELE MACRO	OFF
TAPE LENGTH	T30
REC TIME	OFF
INT. TIME	OFF
TALLY LAMP	ON
DATE/TIME	
TITLE LANG.	ENGLISH
DEMO MODE	OFF
▶RETURN	

D. ZOOM	ON
TELE MACRO	OFF
TAPE LENGTH	T30
REC TIME	OFF
INT. TIME	OFF
TALLY LAMP	ON
DATE/TIME	
TITLE LANG.	ENGLISH
DEMO MODE	OFF
▶RETURN	

Date and Time Display

Set the Date and Time (continued)

4. Press the menu *PUSH* dial in to display the *DATE/TIME* menu.

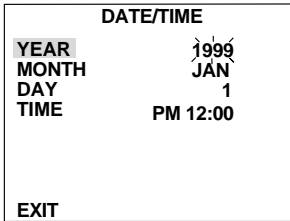

5. Rotate the menu *PUSH* dial to highlight *YEAR*. Press the menu *PUSH* dial in. When *YEAR* starts flashing, rotate the menu *PUSH* dial to select the year. When the correct year appears, press the menu *PUSH* dial in to set the year.
6. Repeat step 5 to set the *MONTH* and *DAY*.
7. Rotate the menu *PUSH* dial to highlight *TIME*.

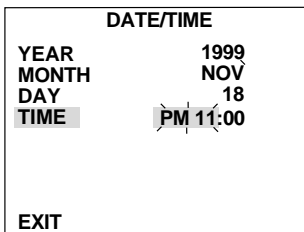

8. Press the menu *PUSH* dial in. When the hour starts flashing, rotate the menu *PUSH* dial to set the hour including *AM* or *PM*.
9. Press the menu *PUSH* dial in. When the hour stops flashing and the minutes start flashing, rotate the menu *PUSH* dial to set the minutes.

10. Press the menu *PUSH* dial in. When none of the settings are flashing, rotate the menu *PUSH* dial to highlight *EXIT*.

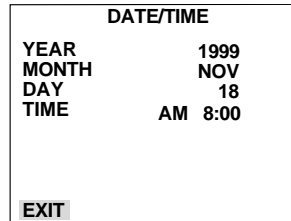

11. Press the menu *PUSH* dial in *twice* to remove the menus.

Notes: If you decide to return the date and time to the previous settings while the *DATE/TIME* menu is displayed, rotate the menu *PUSH* dial to highlight *EXIT*, and press. Press the menu *PUSH* dial again to remove the menus.

To display and record the date and/or time, see the following pages.

Date and Time Display

Record *AUTO DATE*, Date, Time, and Title Displays

You must install the clock cell and set the date and time (*as shown on the previous pages*) before the you can select and record the correct date and time.

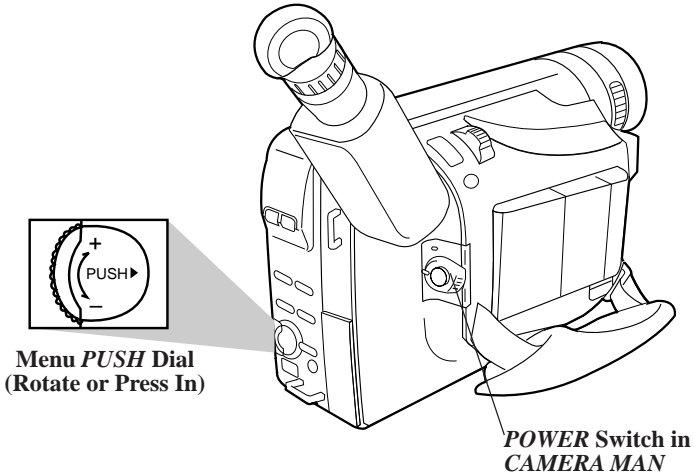

Select *AUTO DATE*, Date, Time, or Date and Time to Record on Your Tape

1. Attach a power supply and set *POWER* switch to *CAMERA MAN*.
The power indicator lights.
Note: *AUTO DATE* is selected when the *POWER* switch is set to *CAMERA AUTO*.
2. Press the menu *PUSH* dial in to display the menu in the viewfinder or on the LCD monitor.

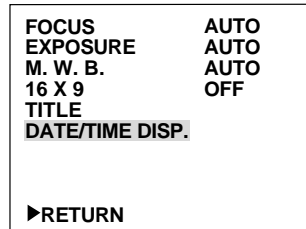

4. Press the menu *PUSH* dial in to display the *DATE/TIME DISP.* menu.

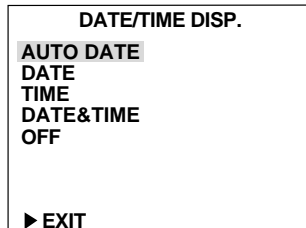
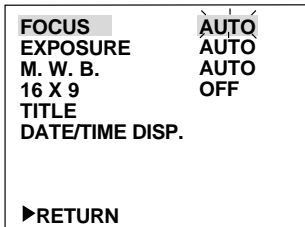

3. Rotate the menu *PUSH* dial to highlight *DATE/TIME DISP.*

Date and Time Display

Record *AUTO DATE*, Date, Time, and Title Displays (continued)

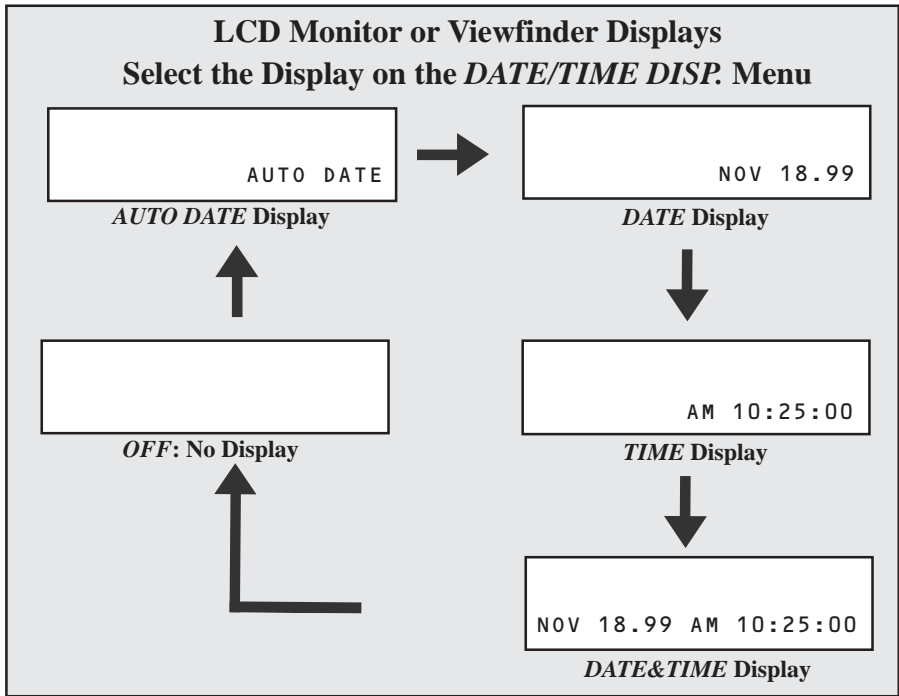

5. Rotate the menu *PUSH* dial to highlight the date/time display you want to record

- **AUTO DATE:** The date is automatically recorded for approximately five seconds and then *AUTO DATE* is displayed whenever:
 - The date is set or changed.
 - This display mode is selected.
 - The tape is changed or the tape compartment opened.
 - This display is selected whenever the *POWER* switch is set to *CAMERA AUTO*.
 - **DATE Display:** The date is displayed and recorded.
 - **TIME:** The time is displayed and recorded.
 - **DATE and TIME Display:** The date and time are displayed and recorded.
 - **OFF:** No display is displayed or recorded.
6. Press the menu *PUSH* dial in to select the date/time display you want to record.
7. Press the menu *PUSH* dial in to remove the menu.
8. Press the thumb trigger to begin recording.

Videocassettes

Make sure you select good quality tapes for your camcorder. Use of poor quality tapes or tapes that have been damaged or mishandled can contaminate the video heads, resulting in a snowy picture or no picture at all during playback. Because there is no control over the type of tape purchased or rented by consumers, head cleaning is not covered under warranty. It is considered normal maintenance.

Erase Protection – Safety Tab

You can use your videocassettes over and over again. To erase a previous recording, just record over it.

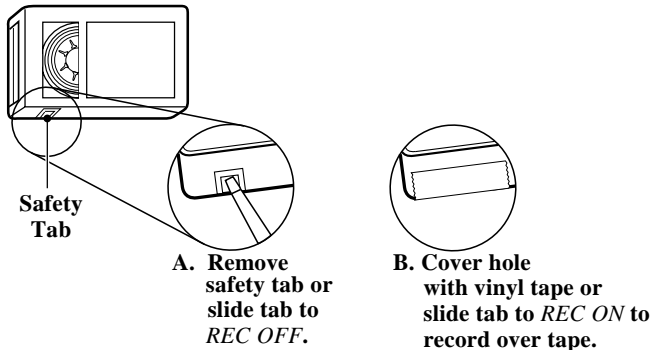

Recording and Playback Speeds and Times

The camcorder records and plays back in standard speed (SP) or extended play (SLP). Select the recording speed by pressing *and holding* the *SP/SLP* button. The selected speed is displayed on the LCD monitor or in the viewfinder. Listed below are the maximum SP and SLP recording times for popular VHS-C cassettes.

- SP – Standard play provides the best picture (less picture noise), but the shortest recording time (20 minutes with a TC-20 tape).
- SLP – Extended play provides three times the recording time as SP (60 minutes with a TC-20 tape). SLP has slightly more picture noise than SP in normal playback. This might not be noticeable.

Cassette	Recording Time	
	SP	SLP
TC-20	20 Min.	60 Min.
TC-30	30 Min.	90 Min.
TC-40	40 Min.	120 Min.

Videocassettes

Insert and Remove Cassettes

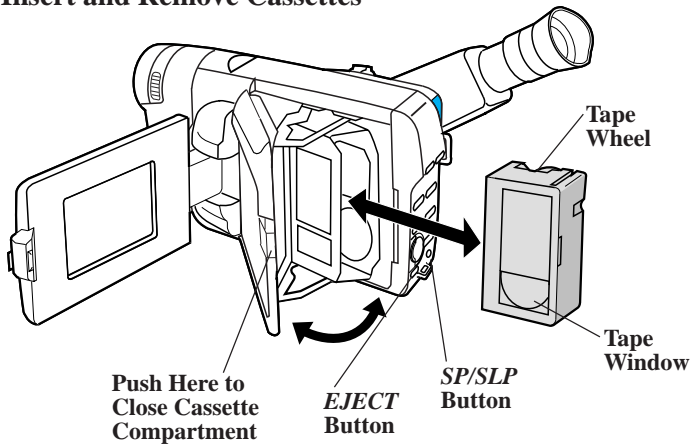

Caution: Insert the cassette only one way with the tape wheel facing up and the tape window facing out. The cassette should slide easily into the holder. Do not force the cassette.

Before inserting a cassette, turn the tape wheel on the side of the cassette in the direction shown to remove any slack in the tape.

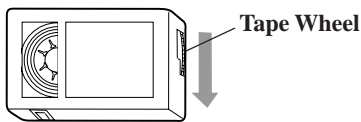

1. Open the LCD monitor at least 60° before opening the cassette holder.
2. Slide *EJECT*. The cassette holder opens automatically.
3. Insert the cassette with the tape wheel facing up and tape window facing out.
4. Press on the area labeled *PUSH* until the cassette holder locks into place.

Cassette Care and Storage

- When you are finished with a cassette, rewind it, remove it from the camcorder, and label it.
- Store cassettes vertically in their protective cases at normal room temperatures. Do not leave your camcorder or cassettes in a car or outdoors for an extended period. Excessive heat or cold might damage your cassettes.
- Keep the cassette away from strong magnetic fields such as electric motors and other devices.
- Keep dust from entering the cassette compartment. All dust is abrasive and causes excessive wear on the tape and the camcorder's recording or playback heads.
- Do not use cassettes with damaged or spliced tape.
- Do not use a cassette if it has been damaged or exposed to moisture. The tape might jam and/or damage your camcorder.

Recording

Time-Remaining Display

The approximate time remaining on the tape in the camcorder for the tape speed you select is displayed. You must set the correct tape length in the *TAPE LENGTH* feature of the menu before the camcorder can correctly calculate time remaining.

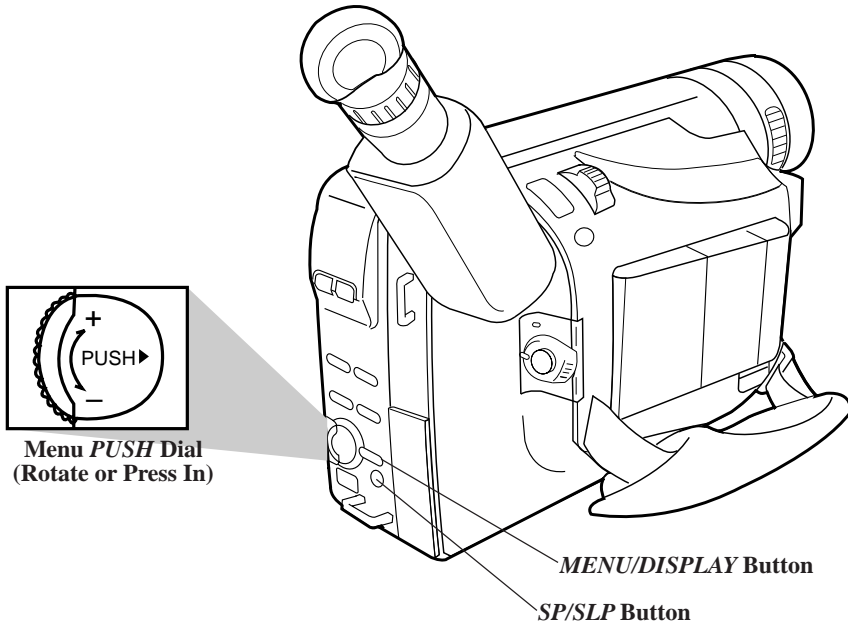

Select a Tape Length

1. Set the *POWER* switch to *CAMERA MAN.*
2. Press *and hold* the *SP/SLP* button to select a tape speed.
3. Press the *MENU/DISPLAY* button to display the menu in the viewfinder or on the LCD monitor.

D. ZOOM	ON
TELE MACRO	OFF
TAPE LENGTH	T30
REC TIME	OFF
INT. TIME	OFF
TALLY LAMP	ON
DATE/TIME	
TITLE LANG.	ENGLISH
DEMO MODE	OFF
▶RETURN	

4. Rotate the menu *PUSH* dial to highlight *TAPE LENGTH*.

Time-Remaining Display (continued)

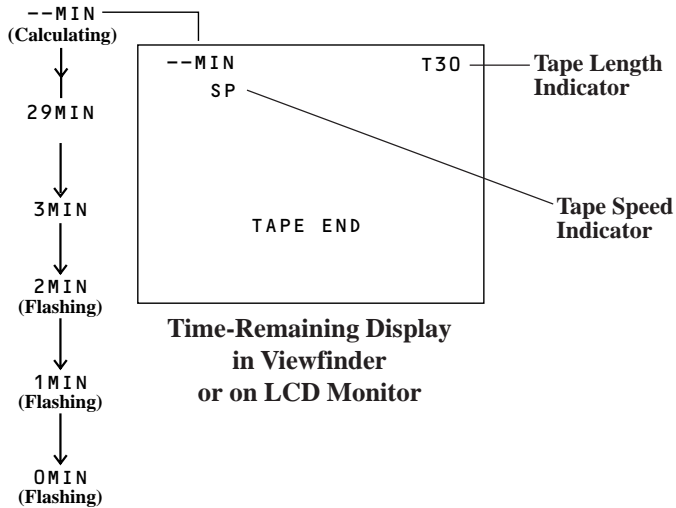

D. ZOOM	ON
TELE MACRO	OFF
TAPE LENGTH	T30
REC TIME	OFF
INT. TIME	OFF
TALLY LAMP	ON
DATE/TIME	
TITLE LANG.	ENGLISH
DEMO MODE	OFF
▶RETURN	

- Press the menu *PUSH* dial in to display the *TAPE LENGTH* menu.

TAPE LENGTH	
T20	
T30	
T40	
EXIT	

- Rotate the menu *PUSH* dial to highlight the type of tape you are using.
 - Select *T20* for a tape with 20 minutes or less recording time in SP.
 - Select *T30* for a tape with 30 minutes recording time in SP.
 - Select *T40* for a tape with 40 minutes recording time in SP.
- Press the menu *PUSH* dial in **twice** to select the tape length and remove the menus.

Recording

Use the LCD Monitor or Viewfinder to See What You Record

You can see what you are recording on the LCD monitor or in the viewfinder. When the LCD monitor is open more than 60°, the viewfinder turns off. When you close the LCD monitor, the viewfinder turns on. To enable both you and the person you're recording to see what's being recorded, rotate the LCD monitor completely around 105° so the front of the monitor faces the person you're recording. The viewfinder turns on automatically when you turn the monitor all the way around.

Use the LCD Monitor

The camcorder's LCD monitor is a miniature color monitor that displays the picture seen by the camcorder when recording or playing back a tape.

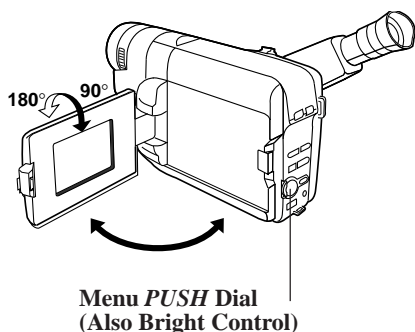

Cautions: Do not force the monitor to rotate completely around. This damages the monitor and/or the camcorder.

When carrying the camcorder with the shoulder strap, close the monitor to prevent possible damage to the monitor from bumping against your body as you move.

1. Open the LCD monitor.
Make sure the monitor is open at least 60°. The viewfinder turns off.
2. You can tilt the monitor up 180° or down 90° for convenient viewing.
 - Tilt the monitor down to record from a high angle, such as over a crowd.
 - Tilt the monitor up to record from a low angle, such as when you are kneeling.
3. Adjust the brightness of the image by turning the bright control (menu *PUSH* dial). This does not affect the brightness of the recording you are making.

- Turn the dial toward + to brighten the image.
 - Turn the dial toward – to darken the image.
4. When you are finished, close the monitor and lock it into place.

Notes: When recording on a bright sunny day, the LCD monitor might be hard to see. Use the viewfinder.

The LCD monitor is manufactured using high-precision technology. However, there may be some tiny black dots and/or bright dots (red, blue, or green in color) that appear on the screen. These points are a normal result of the manufacturing process. These dots won't appear on the video you are recording. Over 99.99% are operational for effective use.

Recording

Use the LCD Monitor or Viewfinder to See What You Record

(continued)

Use the Viewfinder

The camcorder's viewfinder is a miniature monitor that displays the picture seen by the camcorder when recording. When the LCD monitor is open more than 60°, the viewfinder turns off.

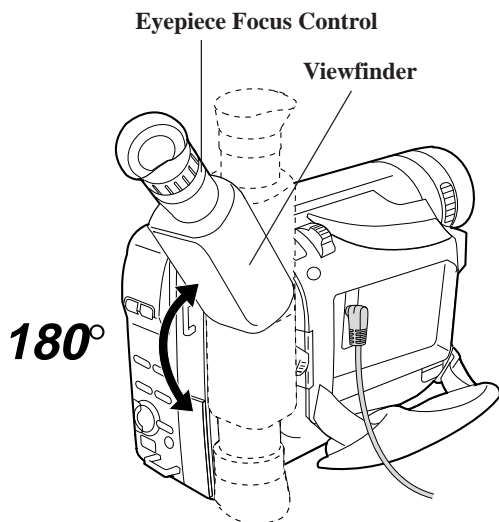

Cautions

Do not force the viewfinder to rotate completely around. This will damage the viewfinder and/or the camcorder.

When carrying the camcorder with the shoulder strap, put the viewfinder down and in to help prevent possible damage to the viewfinder from bumping against your body as you move.

Adjust Viewfinder for Convenient Viewing

For convenient viewing, rotate the viewfinder up or down.

Eyepiece Focus Control

The eyepiece focus control lets you set the focus of the viewfinder for your vision. If you wear eyeglasses, you probably can operate the camcorder without them.

It is easiest to set the correct focus by focusing on one of the viewfinder's on-screen displays. Look through the viewfinder and adjust the eyepiece focus control for your vision.

The eyepiece focus control does not affect the focus of the picture actually recorded by the camcorder.

LCD Monitor and Viewfinder Displays

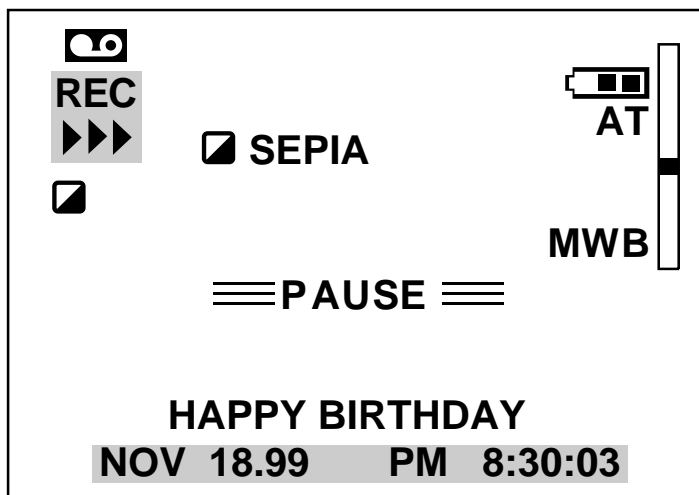

Several displays appear on the LCD monitor or in the viewfinder to aid in the operation of the camcorder. You can press *and hold* the *MENU/DISPLAY* button for more than one second to remove or display the battery level indicator, tape-length indicator, and tape-remaining display.



Battery Level Indicator ()

- This indicator shows the amount of power left in the rechargeable battery.
- This indicator flashes when the battery is almost empty.

Cassette Warning



- The  indicator flashes when the *POWER* switch is set to *CAMERA* and there is no cassette in the camcorder.
- The  indicator flashes when the *POWER* switch is set to *CAMERA* and the safety tab is set to *REC OFF* or removed from the cassette.

AUTO DATE, Date, Time, or Date and Time

Display the *DATE/TIME DISP.* menu to display *AUTO DATE*, Date, Time, or the Date and Time





- These displays are recorded when they are displayed. If you do not want to record one of them, select *OFF* in the menu.
- *Details are on pages 20-21.*

P. (Program) *AE* Button Special Effect Indicators

-  *SEPIA*
This indicator appears when you select  *SEPIA* to give your recordings a brown-tone like old photographs.

Recording

LCD Monitor and Viewfinder Displays (continued)

-  **SPORTS**
This indicator appears when you select  **SPORTS** to record fast-moving action, such as sporting events.
- **SD:SHADOW**
This indicator appears when you select **SD:SHADOW** to darken the picture and reduce glare.
- **HZ:HAZE**
This indicator appears when you select **HZ:HAZE** to soften the picture and give it a misty white effect.
-  **TWILIGHT**
This indicator appears when you select **TWILIGHT** to record scenes at twilight, fireworks, etc.
-  **1/2000**
This indicator appears when you select **1/2000** to record faster-moving action than the **SPORTS** mode.
-  **NEGA POSI**
This indicator appears when you select **NEGA POSI** to reverse the colors and create a negative image.
- *Details are on page 44.*







Preset Titles

- The preset title selected in the **TITLE** menu appears here. It will be recorded on the tape when it appears.
- *Details are on pages 46-47.*







M. W. B. (Manual White Balance Indicators)

The indicator for the manual white balance selected in the **MWB** menu

appears here.

-  appears when you select  **FINE** to record outdoors on a sunny day.
-  appears when you select  **CLOUD** to record outdoors on a cloudy day.
-  appears when you select  **HALOGEN** to record using halogen or tungsten lighting.
- **MWB** appears when you select **MWB** to adjust the color temperatures.
- *Details are on pages 38-39.*

Status Displays

- The  indicator appears when the camcorder is recording.
- The  **PAUSE**  indicator appears during record-pause.
-  appears when the camcorder plays back a tape.
-  appears during play-pause.
-  appears during fast forward and flashes during forward search.
-  appears during rewind and flashes during reverse search.

(AT or MT) Tracking Indicator

- **AT** appears during automatic tracking.
- **MT** appears during manual tracking.

Zoom Indicator (4X)

The zoom indicator appears here when you use the zoom lever.

Recording

LCD Monitor and Viewfinder Displays (continued)

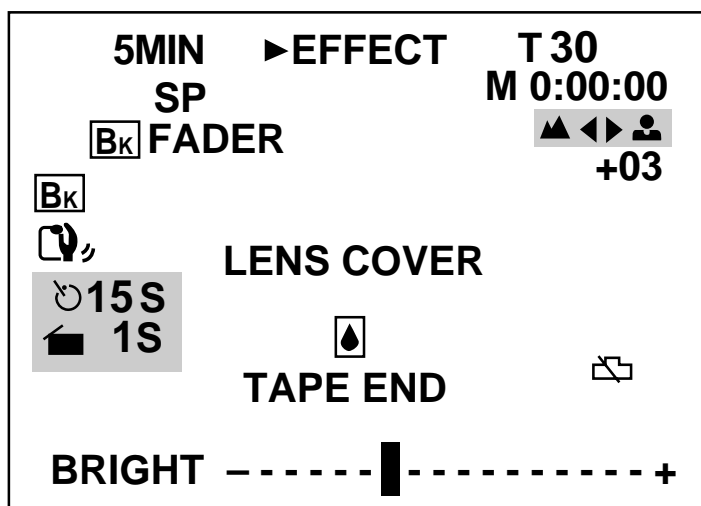

BRIGHT (or VOLUME) Indicator

These indicators appear during playback.

- The **BRIGHT** indicator appears when you adjust the brightness of the monitor with the bright control (also menu **PUSH** dial).
- The **VOLUME** indicator appears when you adjust the volume of the speaker with the VOL control (also zoom lever).

Dew Warning (🌫)

The dew indicator appears when excessive moisture (condensation) has entered the camcorder. The camcorder will not operate when this indicator appears. Place the camcorder in a warm, dry area until this indicator disappears.

Exposure Indicators (+03)

This indicator appears when you are adjusting brightness manually using the

EXPOSURE menu. Make sure the **POWER** switch is set to **CAMERA MAN**.

- *Details are on pages 40-41.*

Fade and Wipe Indicators ([Bk] FADER)

Press the **FADES** button to display the indicator for the fade or wipe you want to select.

- **[Bk] FADER** appears for black fade.
- **[🏠] MOSAIC** appears for mosaic fade.
- **DOOR** appears for door wipe.
- **[🕒] SCROLL** wipe appears for scroll wipe.
- *Details are on pages 42-43.*

Focus Indicators (▲▶▶⊞)

These indicators appear when you are adjusting focus manually using the **FOCUS** menu. Make sure the **POWER** switch is set to **CAMERA MAN**.

- The focus indicators (▲▶▶⊞) flash when the auto-focus system cannot operate properly.

LCD Monitor and Viewfinder Displays (continued)

- appear when you have selected *MENU* in the *FOCUS* menu.
- and flash while you adjust manual focus and and flash when you cannot adjust the focus any farther.
- *Details are on pages 36-37.*

Lithium Cell ()

- This indicator appears for a few seconds when you turn on the camcorder and the clock cell is missing or needs to be replaced.
- *Details are on page 17.*

Self-Timer, Animation, Time-Lapse, and Five-Second Recording Indicators

(15S and 5S)

- 5S appears when you press the 5SEC. REC button for five-second recording. *Details are on page 33.*
- The interval time selected for self-timer or time-lapse recording (15S, 30S, 1MIN, or 5MIN) appears here. *Details are on pages 48-49 and 52-53.*
- The recording time selected for animation or time-lapse recording (1/4S, 1/2S, 1S, or 5S) appears here. *Details are on pages 50-51 and 52-53.*

Steady Pix™ Indicator ()

- Press the *STEADY PIX* button to turn Steady Pix on or off.
- The steady pix indicator () appears when Steady Pix is turned on.
- *Details are on page 41.*

Tape Length (T30)

The tape length (T20, T30, or T40) selected in the *TAPE LENGTH* menu appears here.

- *Details are on pages 24-25.*

Tape Speed Indicators (SP or SLP)

The tape speed selected with the *SP/SLP* button appears here.

- *Details are on page 22.*

Time Counter (M0:00:00)

- The time counter appears during playback. It is not recorded.
- An “M” appears in front of the time counter when memory-stop is on.
- *Details are on page 61.*

Time-Remaining Display (5MIN)

The approximate time remaining on the tape is automatically displayed. The correct tape length must be set in the *TAPE LENGTH* menu.

- *Details are on pages 24-25.*

Warnings and Information

- *LENS COVER* briefly flashes to remind you to open the lens cover. *LENS COVER* might flash when the camcorder is used in dark areas -- even if the lens cover is open.
- *TAPE END* appears when the end of the tape is reached during recording or a cassette is inserted with its tape already at the end.

Recording

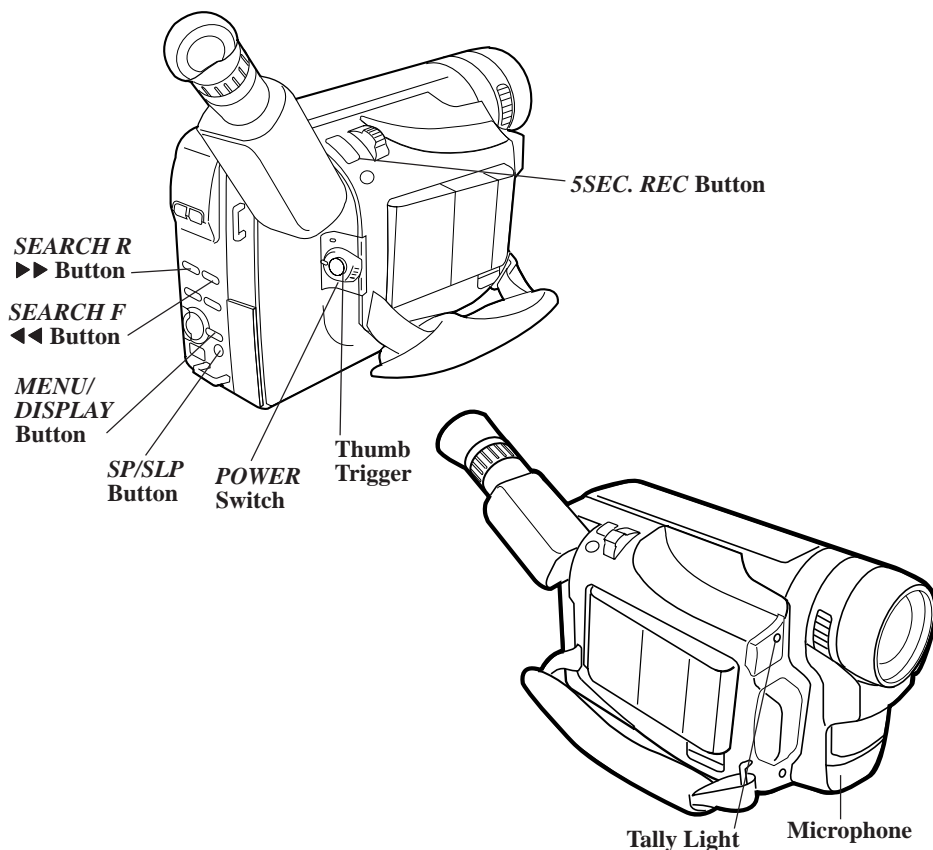

AutoShot™ Mode

The **POWER** switch lets you select automatic or manual control of several features.

To Turn on the AutoShot™ Mode

1. Set the **POWER** switch to **CAMERA AUTO**. The power indicator lights and the camcorder enters record-pause. **≡ PAUSE ≡** appears in the viewfinder.
2. Press the thumb trigger to start recording.

- The camcorder automatically controls focus, exposure, and white balance.
- The **MENU/DISPLAY** button and menu **PUSH** dial will not operate.
- **AUTO DATE** is selected for the date and time display.

To Turn Off the AutoShot™ Mode

1. Set the **POWER** switch to **CAMERA MAN**.

Recording

Five-Second Record Feature

The five-second record feature allows you to record for five seconds providing short scene transitions.

1. Set *POWER* switch to *CAMERA AUTO* or *CAMERA MAN*.
2. Make sure the *SP/SLP* switch is set to *SP*. Press *and hold* to change.
3. Press *5SEC. REC* to display  *5S* in the viewfinder or on the LCD monitor.
4. Press the thumb trigger to start recording. The camcorder records for five seconds and enters record-pause.

To Turn Off the Five-Second Record Mode

1. Press the *5SEC. REC* button to remove  *5S* from the viewfinder or LCD monitor.

Tally Light

The tally light lights when the camcorder is recording. The tally light flashes during self-timer and time-lapse recording.

The tally light must be set to *ON* in the *TALLY LAMP* menu. See page 54 for details.



Quick Review Feature

Press and release *SEARCH R*  when the camcorder is in record-pause to review the last few seconds of a recording. The *POWER* switch must be set to *CAMERA AUTO* or *CAMERA MAN*.

The camcorder plays back the last few seconds of the recording, returns the tape to its previous position, and returns to record-pause.

Camera Edit Feature

The camera edit feature allows you to position the tape when the camcorder is in record-pause. Set *POWER* switch to *CAMERA AUTO* or *CAMERA MAN*.

- Press and hold *SEARCH R*  to visually search the recorded tape in reverse.
- Press and hold *SEARCH F*  to visually search forward on the recorded tape.

Release the button to return the camcorder to record-pause at that point on the tape. Press the thumb trigger to start recording at this point.

Flying Erase Head

A separate erase head is mounted on the spinning headwheel (hence the term “flying”). This allows you to make clean edits without the “glitches” or “rainbow noise” that might occur at the beginning or the end of recordings.

MENU/DISPLAY Button

Press *and hold* the *MENU/DISPLAY* button for more than one second to remove or display the battery level indicator, tape-length indicator, and tape-remaining display in the viewfinder or on the LCD monitor.

Recording

Zooming

You can zoom in and out for close ups or wide-angle shots just by moving the zoom lever on the camcorder. The camcorder automatically focuses when you zoom at most distances. Digital zooming allows you to zoom up to 50 times.

To record a close-up of a small subject closer than three feet. Turn on the *TELE MACRO* feature in the menu. You can record a small subject at a distance of approximately 23 inches.

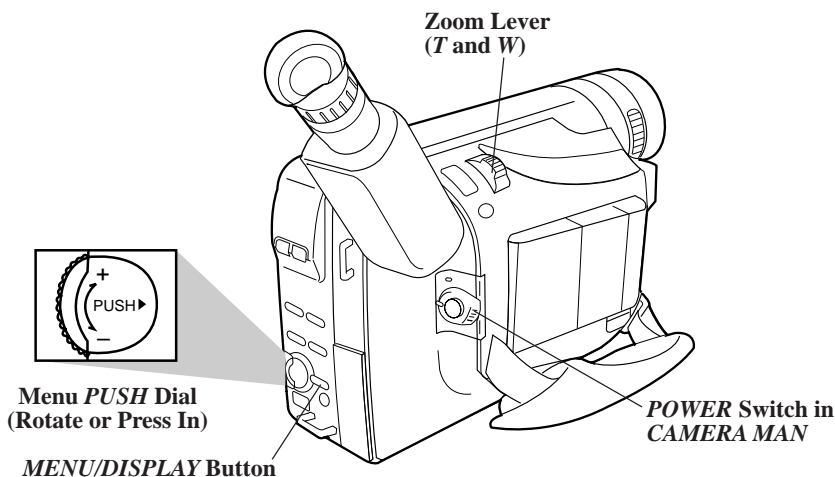

Use the Zoom Lever (W and T)

1. To zoom in or out (up to 16 times), rotate the zoom lever.
 - To move the lens in the telephoto (close-up) direction, rotate the zoom lever toward *T*.
 - To move the lens in the wide angle direction, rotate the zoom lever toward *W*.
 - The zoom level indicator appears in the viewfinder or on the LCD monitor during zooming.

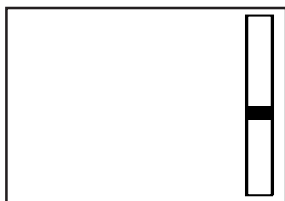

Digital Zooming

Digital zooming lets you zoom up to 50 times.

1. Set the *POWER* switch to *CAMERA MAN*.
2. Press the *MENU/DISPLAY* button to display the menu in the viewfinder or on the LCD monitor. *D. ZOOM* is highlighted.

D. ZOOM	ON
TELE MACRO	OFF
TAPE LENGTH	T30
REC TIME	OFF
INT. TIME	OFF
TALLY LAMP	ON
DATE/TIME	ON
TITLE LANG.	ENGLISH
DEMO MODE	OFF
▶RETURN	

Recording

Zooming (continued)

3. Press the menu *PUSH* dial in to display the *D. ZOOM* menu.

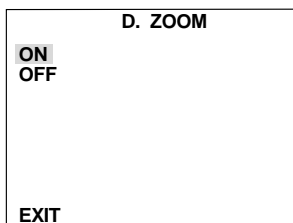

4. Rotate the menu *PUSH* dial to highlight *OFF* or *ON*.

- Select *ON* to turn digital zooming on.
- Select *OFF* to turn digital zooming off.

5. Press the menu *PUSH* dial *twice* to turn digital zooming on or off and remove the menus from the viewfinder or on the LCD monitor.

Notes: As the zoom level increases, the picture gradually becomes less sharp. Digital zooming is recommended mainly for special effects.

Tele Macro Zooming

1. Set the *POWER* switch to *CAMERA MAN*.
2. Press the *MENU/DISPLAY* button to display the menu in the viewfinder or on the LCD monitor. *D. ZOOM* is highlighted.

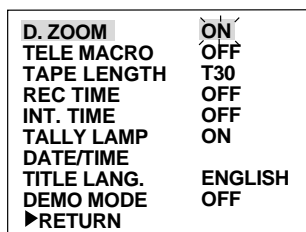

3. Rotate the menu *PUSH* dial to highlight *TELE MACRO*.

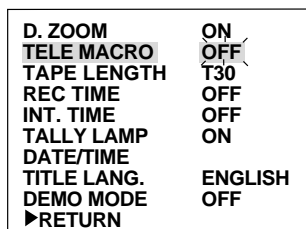

4. Press the menu *PUSH* dial in to display the *TELE MACRO* menu.

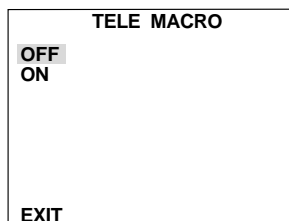

5. Rotate the menu *PUSH* dial to highlight *ON* or *OFF* and press the dial in.
 - Select *ON* if you want to record a small subject within approximately 23 inches.
 - Select *OFF* for normal zooming.
6. Press the menu *PUSH* dial *twice* to turn tele macro zooming on or off and remove the menus.

Recording

Focusing

The camcorder adjusts focus automatically under normal conditions. You might need to focus manually under certain conditions.

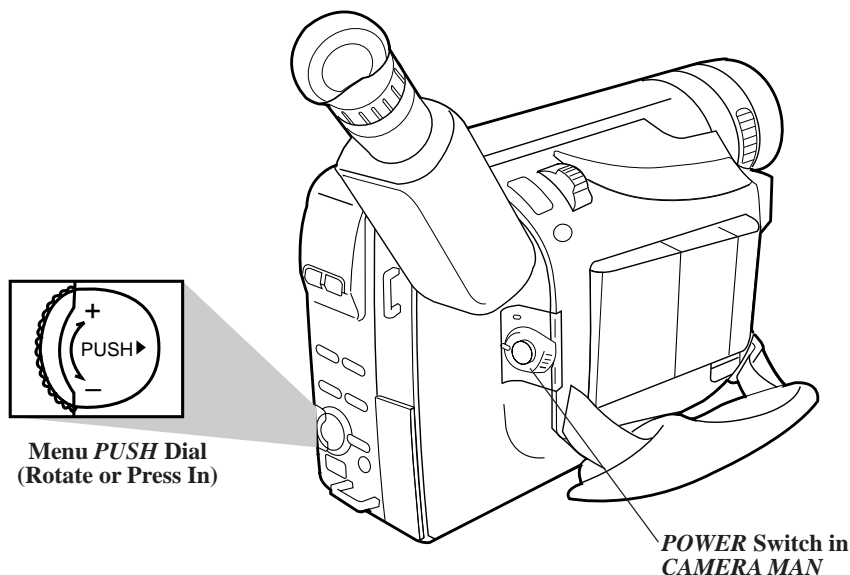

**Menu *PUSH* Dial
(Rotate or Press In)**

***POWER* Switch in
*CAMERA MAN***

Auto Focus

During auto focus the camcorder focuses on the object located in the center area of the viewfinder.

- Set the *POWER* switch to *CAMERA AUTO* to turn on the auto focus feature. No focus indicator appears in the viewfinder or on the LCD monitor.

Notes: The low-contrast indicator (▲ ■) in the viewfinder or LCD

monitor indicates the auto-focus system might not operate correctly due to low illumination, low or no contrast, repeated patterns, or two subjects at different distances overlapping.

Use tele macro zooming when recording a subject close to the lens or the camcorder may zoom out to focus.

The lens must be clean for the camcorder to focus accurately.

Recording

Focusing (continued)

Manual Focus



You might need to focus manually under certain conditions.

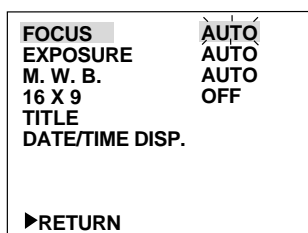

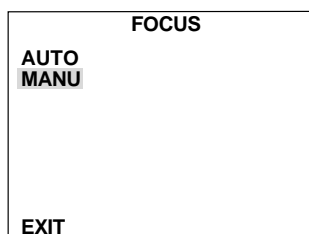

1. Set the *POWER* switch to *CAMERA MAN*.
2. Rotate the zoom lever to *T* to zoom in on the subject and center the subject in the viewfinder or on the LCD monitor.
3. Press the menu *PUSH* dial in to display the menu in the viewfinder or on the LCD monitor. *FOCUS* is highlighted.



4. Press the menu *PUSH* dial in to display the *FOCUS* menu.



5. Rotate the menu *PUSH* dial to highlight *MANU* and press the dial in.   appears in the viewfinder or on the LCD monitor. The focus is locked at this point.

6. Adjust the focus for a subject nearer or farther away.
 - Rotate the menu *PUSH* dial up to focus on a subject farther away.  flashes while you are adjusting the focus and  flashes when you cannot adjust the focus any more.
 - Rotate the menu *PUSH* dial down to focus on a subject nearer.  flashes while you are adjusting the focus and  flashes when you cannot adjust the focus any more.
7. Press the menu *PUSH* dial *twice* to remove the menus.

Notes: To return to auto focus, select *AUTO* in the *FOCUS* menu or set the *POWER* switch to *CAMERA AUTO*.

Conditions Requiring Manual Focus

- When recording a subject through a window.
- When recording a subject having a close foreground and a background that is far away.
- When recording in low-light situations.
- When recording two subjects at different distances that overlap in the same scene.
- When the subject is not in the center of the scene.
- When recording a scene with fast motions, like a tennis swing.

Recording

White Balance

Making colors look natural is what white balance is all about. This is achieved by adjusting the way the camcorder “sees” and records the light source in the scene you record. Your camcorder is equipped with automatic white balance. You might want to adjust white balance manually under certain conditions, such as recording an object with various shades of the same color or when recording a predominantly red or brown object outdoors.

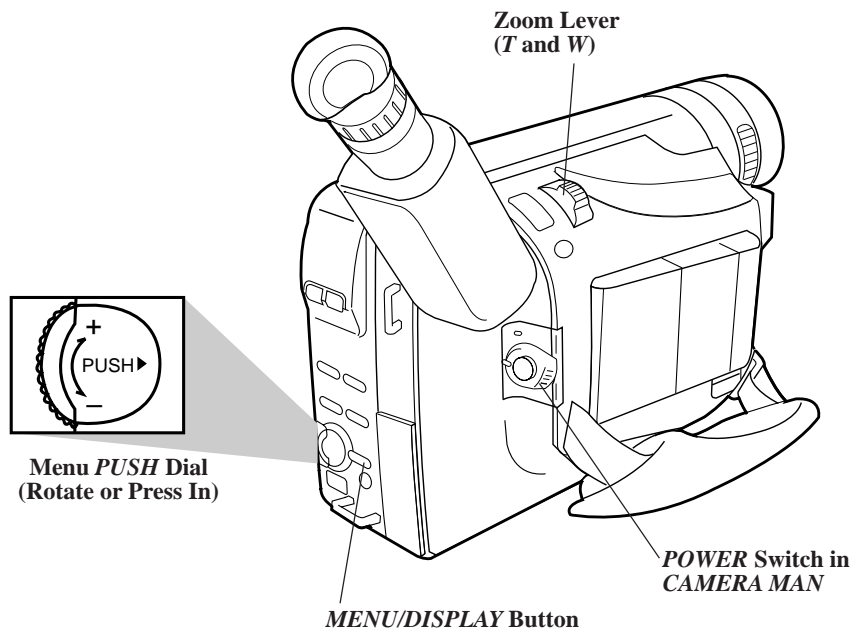

Auto White Balance

During auto white balance, the camcorder adjusts the white balance.

- Set the *POWER* switch to *CAMERA AUTO* to turn on the automatic white balance feature. No indicator appears in the viewfinder or on the LCD monitor.

Manual White Balance

1. Set the *POWER* switch to *CAMERA MAN*.
2. Press the menu *PUSH* dial in to display the menu in the viewfinder or on the LCD monitor. *FOCUS* is highlighted.

White Balance (continued)

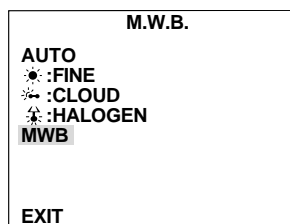
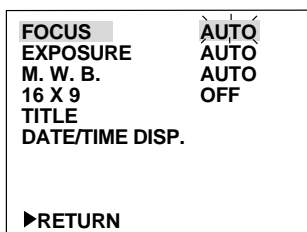

3. Rotate the menu *PUSH* dial to highlight *M. W. B.* and press the dial in to display the *M.W.B.* menu.

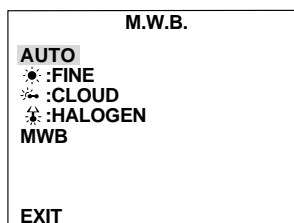

4. Rotate the menu *PUSH* dial to highlight the white balance you want to use.
 - No indicator appears when you select *AUTO* white balance.
 - Select ☀:*FINE* when recording outdoors on a sunny day.
 - Select ☁:*CLOUD* when recording outdoors on a cloudy day.
 - Select 💡:*HALOGEN* when recording using halogen or tungsten lighting.
 - Select *MWB* when shooting subjects with different color temperatures and adjust the white balance as follows:

Note: Connecting your camcorder to a color TV monitor may be helpful when making white balance adjustments.

- A. Point camcorder at a white, flat object such as a piece of white paper.
- B. While *MWB* is highlighted, press and hold the menu *PUSH* dial until *MWB* starts flashing. The *MWB* indicator flashes while the camcorder is adjusting white balance and stops flashing when it is ready to record.

Note: To change the tint for special recording, substitute colored paper for white. The white balance is adjusted based on the color.

Red paper – deeper green
Blue paper – orange
Yellow paper – deeper purple

5. Press the menu *PUSH* dial *twice* to select a white balance and remove the menus.

Notes: To return to auto white balance, select *AUTO* in the *M.W.B.* menu or set the *POWER* switch to *CAMERA AUTO*.

Recording

Exposure Control

The camcorder controls the iris for you when the *POWER* switch is set to *CAMERA AUTO*. The camcorder adjusts brightness automatically under normal conditions. You might need to adjust brightness manually when the background is too bright or too dark in comparison with the subject.

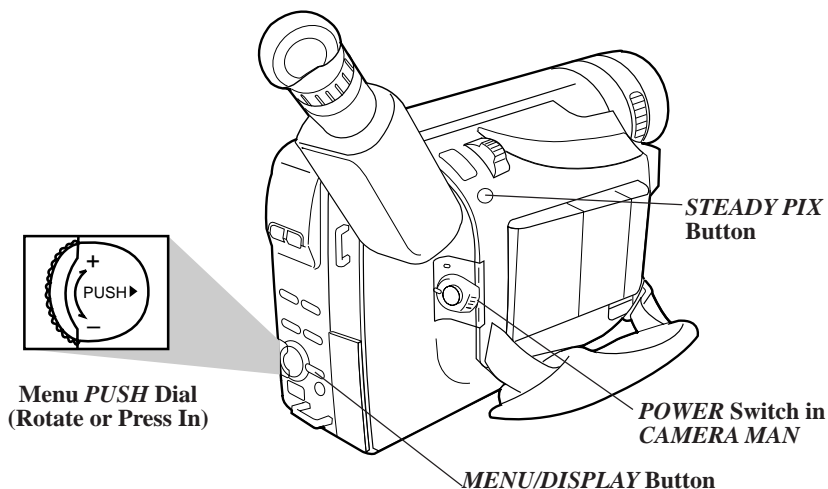

Auto Exposure

The camcorder adjusts the iris for the best possible picture during auto exposure.

- Set the *POWER* switch to *CAMERA AUTO* to turn on the automatic exposure feature. No indicator appears in the viewfinder or on the LCD monitor.

Manual Exposure

You may need to adjust exposure manually under certain conditions, such as those listed on the next page.

1. Set the *POWER* switch to *CAMERA MAN*.
2. Press the menu *PUSH* dial in to display the menu in the viewfinder or on the LCD monitor. *FOCUS* is highlighted.

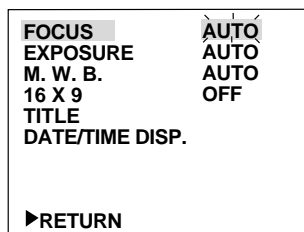

Exposure Control (continued)

3. Rotate the menu *PUSH* dial to highlight *EXPOSURE*, and press the dial in to display the *EXPOSURE* menu.

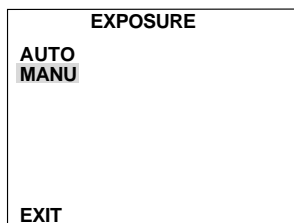

4. Rotate the menu *PUSH* dial to highlight *MANU* (manual) and press the dial in. The exposure indicator (00) appears.
5. Adjust the exposure for a dark or bright subject. The exposure you select appears.
 - To brighten the image, rotate the menu *PUSH* dial up. You can adjust the exposure to +06.
 - To darken the image, rotate the menu *PUSH* dial down. You can adjust the exposure to -06.
6. Press the menu *PUSH* dial in *twice* to select an exposure and remove the menus.

Notes: To return to auto exposure, select *AUTO* in the *EXPOSURE* menu or set the *POWER* switch to *CAMERA AUTO*.

Conditions Requiring Manual Exposure

- When recording with a bright background or reverse lighting.
- When recording with a very dark background or very bright subject.
- When recording a reflective natural background — such as a beach or when skiing.

Steady Pix™ Feature

The steady pix feature corrects slight shaking of images during some recording modes.

- While zooming in on a distant subject.
- When recording an approaching small subject.
- When recording while walking or riding in a vehicle.
- When recording through a vehicle's window.

To Use the Steady Pix™ Feature

- Press the *STEADY PIX* button to turn steady pix on. The steady pix indicator (Ⓢ) appears in the viewfinder or on the LCD monitor.
- Press the *STEADY PIX* button to turn the steady pix feature off. The steady pix indicator (Ⓢ) disappears.

Notes: Turn steady pix off when using a tripod.

There is a small change in the picture size when using steady pix.

Accurate stabilization may not be possible if hand shake is excessive or when shooting the following:

- Subjects with vertical or horizontal stripes.
- Dark or dim subjects.
- Subjects with excessive backlighting.
- Scenes with movement in various directions.
- Scenes with low-contrast backgrounds.

Recording

Fade or Wipe In or Out

You can add a professional touch to your recordings when you fade or wipe in and out of scenes. The picture gradually appears or disappears. The speed of the fade or wipe is controlled by the camcorder.

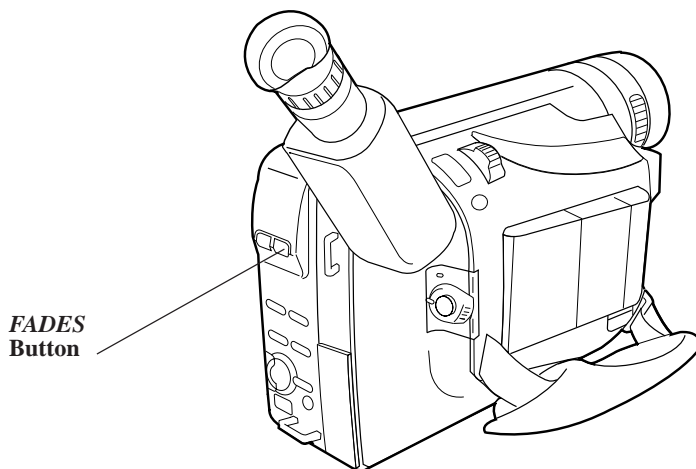

To Fade or Wipe In or Out

1. Set the *POWER* switch to *CAMERA MAN*.
2. Repeatedly press the *FADES* button. The indicator for the fade or wipe you select will appear.

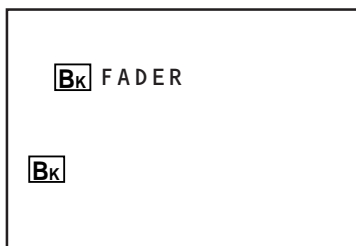

- Select **Bk** *FADER* to fade in and out to/from a black screen.
- Select **■** *MOSAIC* to fade in and out to/from a mosaic effect.

- Select **□** *DOOR* wipe to have the scene wipe in with a black screen moving from the center out to the side or wipe out moving from the side into the center.
- Select **▭** *SCROLL* wipe to have the scene wipe in with a black screen from the bottom to the top or wipe out from the top to the bottom.
- Select *OFF* if you do not want to fade or wipe in or out.

3. Press the thumb trigger to start or stop recording. The camcorder fades in or out of the scene.

Note: The screen becomes slightly reddish if fade is used with the sepia feature.

If the haze feature is selected, **Bk** *FADER* fades in and out from a white screen.

Recording

Fade or Wipe In or Out (continued)

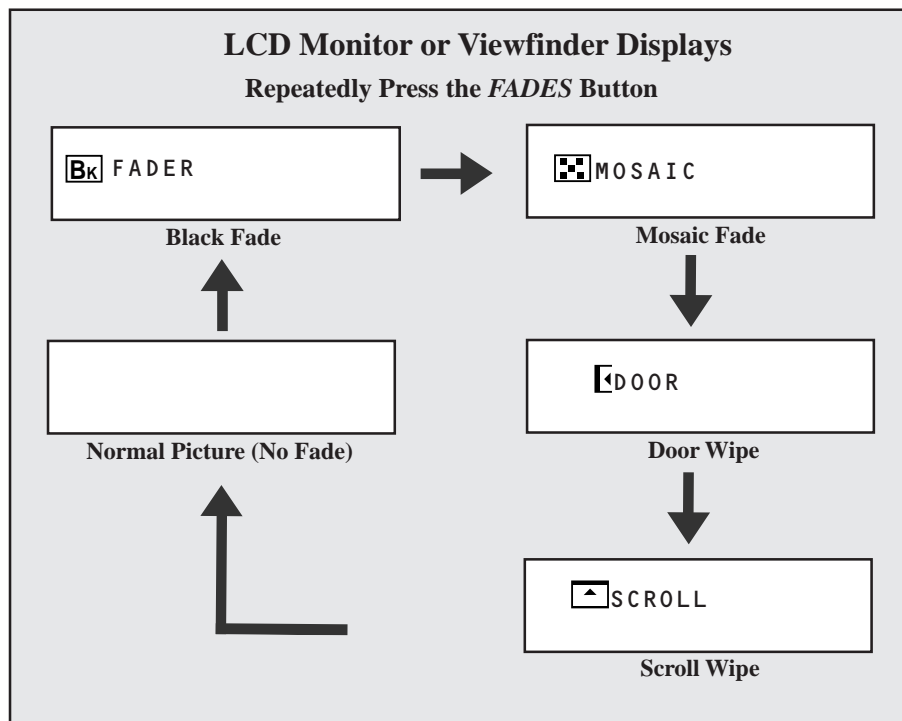

Fade or Wipe In

1. Press the thumb trigger to pause recording.
2. Repeatedly press *FADES* to select the fade or wipe you want to use.

Note: The last fade or wipe used appears the first time you press *FADES*.

3. Press the thumb trigger to start recording. The picture and sound gradually appear in place of the blank screen.

Fade or Wipe Out





1. During recording, repeatedly press *FADES* to select a fade or wipe.
Note: The last fade or wipe used appears the first time you press *FADES*.
2. Press *FADES* to stop recording. The picture and sound gradually disappear.

Recording

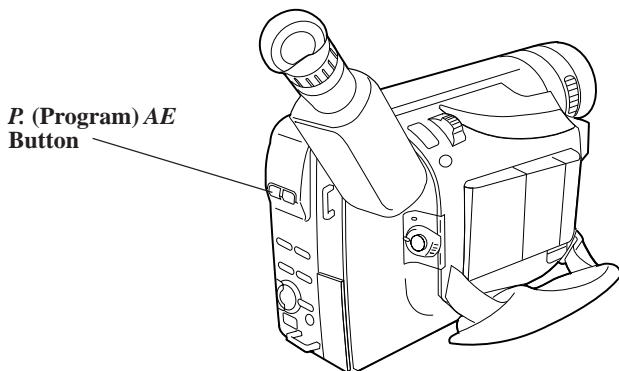
P. (Program) AE Button

The *P.* (Program) *AE* button lets you select one of several different effects. Press the button to select the effect you want. The name and indicator for the effect appears briefly and then the indicator remains.



Indicator and Name	Uses
 <i>SEPIA</i>	Picture is recorded in sepia (brownish red) and offers the vintage look of old movies.
 <i>SPORTS</i>	Use to capture fast-moving action with less blurring. Use when playing back a recording on a VCR featuring special effects, such as pause or slow motion.
<i>SD:SHADOW</i>	Use to counter effects of glare and darken the picture with a black mist.
<i>HZ:HAZE</i>	Use to soften the image and give the picture a misty white effect.
 <i>TWILIGHT</i>	Use for twilight scenery, fireworks, etc. to make them look more natural and dramatic.
 <i>2 S 1/2000</i>	Sets shutter speed to 1/2000. Use to record faster moving action than sports mode with less blurring. Use when playing back a recording on a VCR featuring special effects, such as pause or slow motion.
 <i>NEGA POSI</i>	Use to reverse the color (create a negative image).
<i>OFF</i>	Use to turn off all special effects.

Recording

16X9 Mode

The camcorder has a wide recording mode that lets you make recordings compatible with the 16X9 format. When 16X9 is activated, the camcorder records black bars at the top and bottom of the picture to produce the wide-screen effect. This is also known as “letterbox” recording.

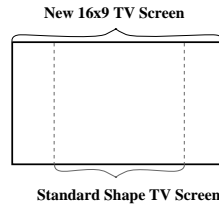
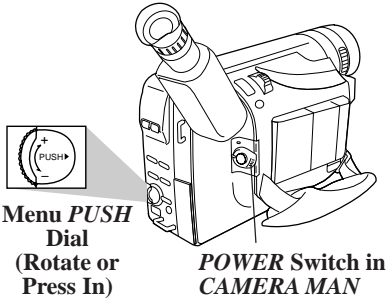

Caution: Do not use this mode unless you have a compatible 16 X 9 TV. When played on a regular TV, black bars appear in the picture.

1. Set the *POWER* switch to *CAMERA MAN*.
2. Press the menu *PUSH* dial in to display the menu in the viewfinder or on the LCD monitor. *FOCUS* is highlighted.
4. Rotate the menu *PUSH* dial to highlight *OFF* or *ON*.
 - Select *ON* to record 16X9.

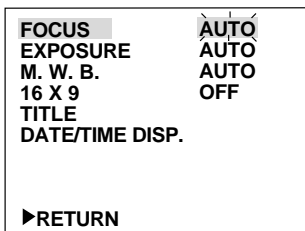

- Select *OFF* to turn off 16X9.

3. Rotate the menu *PUSH* dial down to highlight *16X9* and press it in to display the *16X9* menu.

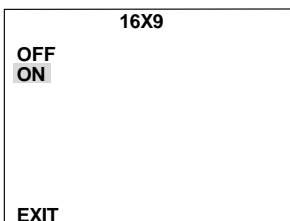

5. Press the menu *PUSH* dial in *twice* to turn 16X9 on or off and remove the menus.

Recording

Preset Titles

The title feature lets you choose one of eight preset titles. You can also choose the language for your titles.

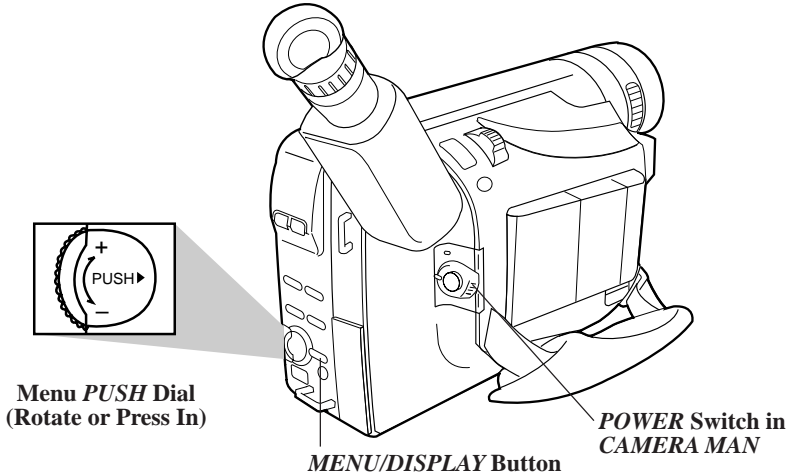

Select a Language for the Title

You can select English, French, or Spanish to record your preset titles.

1. Set the *POWER* switch to *CAMERA MAN*.
2. Press the *MENU/DISPLAY* button to display the menu in the viewfinder or on the LCD monitor. *D. ZOOM* is highlighted.

D. ZOOM	ON
TELE MACRO	OFF
TAPE LENGTH	T30
REC TIME	OFF
INT. TIME	OFF
TALLY LAMP	ON
DATE/TIME	
TITLE LANG.	ENGLISH
DEMO MODE	OFF
▶RETURN	

highlight *TITLE LANG.* and press the menu *PUSH* dial in to display the *TITLE LANG.* menu.

TITLE LANG.
ENGLISH
FRENCH
SPANISH
EXIT

3. Rotate the menu *PUSH* dial down to
4. Rotate the menu *PUSH* dial to highlight the language you want to use to record the preset title, and press the dial in to select the language and return to the menu.
5. Press the menu *PUSH* dial twice to select the language and remove the menus.

Recording

Preset Titles (continued)

Record a Preset Title

1. Set the *POWER* switch to *CAMERA MAN*.
2. Press the menu *PUSH* dial in to display the menu in the viewfinder or on the LCD monitor. *FOCUS* is highlighted.

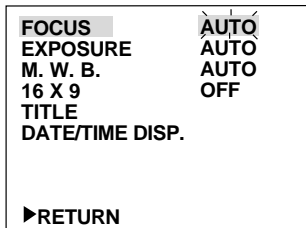

3. Rotate the menu *PUSH* dial down to highlight *TITLE*.

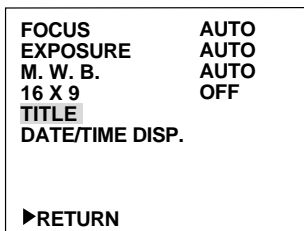

4. Press the menu *PUSH* dial in to display the *TITLE* menu.

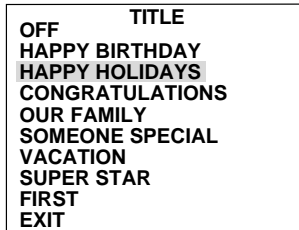

5. Rotate the menu *PUSH* dial down to highlight the title you want to record, and press the dial twice to select the title and remove the menus.
6. Start recording. The title you selected is superimposed and recorded on your tape.

To Stop Recording the Title

1. Set the *POWER* switch to *CAMERA MAN*.
2. Press the menu *PUSH* dial in to display the menu in the viewfinder or on the LCD monitor. *FOCUS* is highlighted.
3. Rotate the menu *PUSH* dial down to highlight *TITLE* and press the dial in to display the *TITLE* menu.
4. Rotate the menu *PUSH* dial down to highlight *OFF* and press the dial in *twice* to turn off the title and remove the menus.

Recording

Self-Timer Recording

You can set the self-timer to delay recording so you can be in the scene when recording begins.

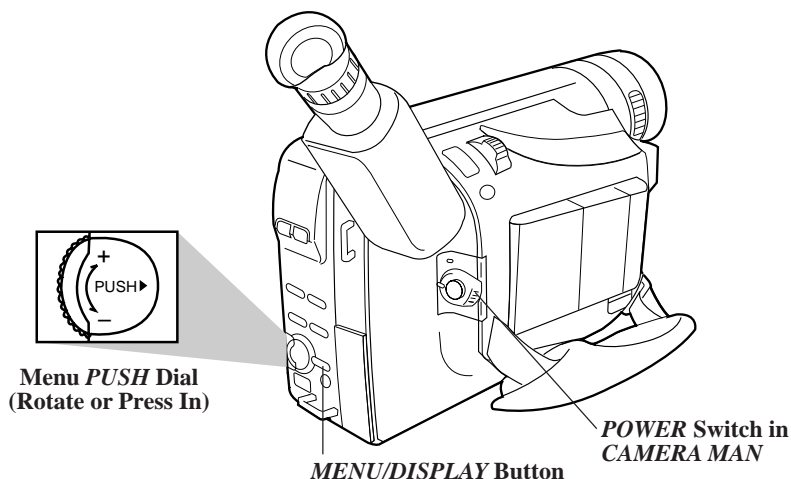

To Set the Self Timer

1. Set the *POWER* switch to *CAMERA MAN*.
2. Press the *MENU/DISPLAY* button to display the menu in the viewfinder or on the LCD monitor. *D. ZOOM* is highlighted.

D. ZOOM	ON
TELE MACRO	OFF
TAPE LENGTH	T30
REC TIME	OFF
INT. TIME	OFF
TALLY LAMP	ON
DATE/TIME	
TITLE LANG.	ENGLISH
DEMO MODE	OFF
▶RETURN	

Recording

Self-Timer Recording (continued)

3. Rotate the menu *PUSH* dial down to highlight *INT. TIME* and press the dial in to display the *INT. TIME* menu.

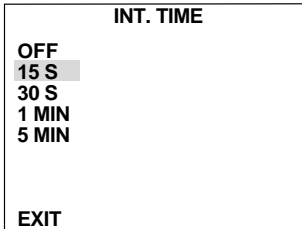

4. Rotate the menu *PUSH* dial to highlight the desired time (*15S*, *30S*, *1 MIN*, or *5 MIN*).
 - Select *15S* to delay the recording for 15 seconds.
 - Select *30S* to delay the recording for 30 seconds.
 - Select *1 MIN* to delay the recording for one minute.
 - Select *5 MIN* to delay the recording for five minutes.
 - Select *OFF* if you do not want the camcorder to delay recording.
5. Press the menu *PUSH* dial *twice* to exit the menu.
6.  and the amount of delayed recording time appear in the viewfinder or on the LCD monitor.

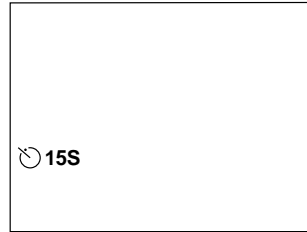

7. Press the thumb trigger to start recording.

Note: The tally light flashes. About five seconds before recording begins, the tally light starts flashing faster. When the camcorder starts recording, the tally light stops flashing.
8. To stop self-timer recording, press the thumb trigger.

Note: To turn off self-timer recording before it starts, press the thumb trigger and set the interval time on the *INT. TIME* menu to *OFF*.

Recording

Animation Recording

You can produce an illusion of movement for an otherwise stationary scene or object by shooting a series of pictures of slightly different poses (such as cartooning).

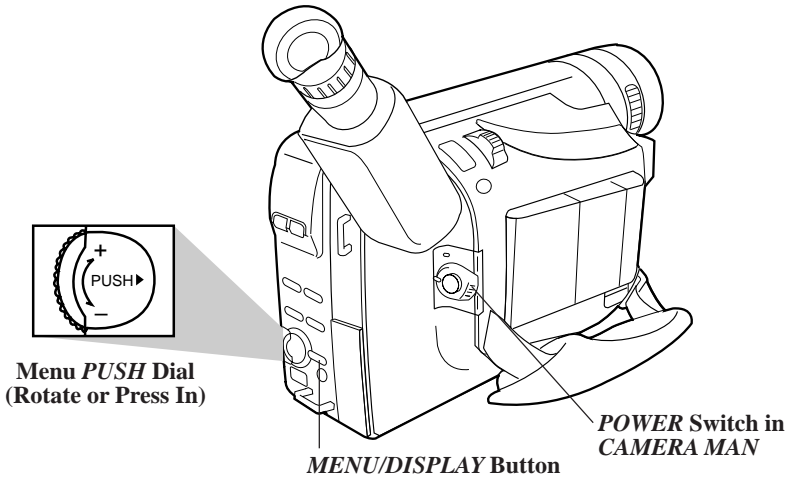

To Record Using Animation

1. Set the *POWER* switch to *CAMERA MAN*.
2. Press *and hold* *SP/SLP* to select *SP*. *SP* appears in the viewfinder or on the LCD monitor.
3. Press the *MENU/DISPLAY* button to display the menu in the viewfinder or on the LCD monitor. *D. ZOOM* is highlighted.

D. ZOOM	ON
TELE MACRO	OFF
TAPE LENGTH	T30
REC TIME	OFF
INT. TIME	OFF
TALLY LAMP	ON
DATE/TIME	
TITLE LANG.	ENGLISH
DEMO MODE	OFF
▶RETURN	

Recording

Animation Recording (continued)

4. Rotate the menu *PUSH* dial down to highlight *REC TIME* and press the dial in to display the *REC TIME* menu.

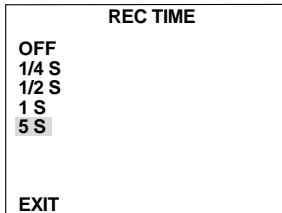

5. Rotate the menu *PUSH* dial to highlight the amount of time you want the camcorder to record.

- Select *1/4S* to record for 1/4 second.
- Select *1/2S* to record for 1/2 second.
- Select *1S* to record for one second.
- Select *5S* to record for five seconds.
- Select *OFF* if you do not want to record for a selected amount of time.

6. Press the menu *PUSH* dial *twice* to exit the menu.

7.  and the amount of recording time appear in the viewfinder or on the LCD monitor.

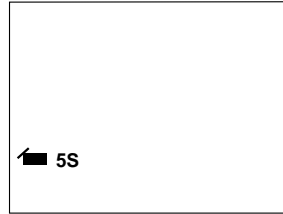

8. Press the thumb trigger to start recording.

Note: The recording stops automatically after the selected period of recording time. You might want to take two to five shots of the subject in the same position.

9. Move the subject and repeat step 8 for the desired number of shots.

Note: Fade does not operate during animation or time-lapse recording.

To Stop Animation Recording

Set the *REC TIME* in the menu to *OFF*.

Recording

Time-Lapse Recording

You can make automatic recordings at preset time intervals. The recording shows subtle changes (such as shifts in cloud formations or plant growth) when it remains focused on an object.

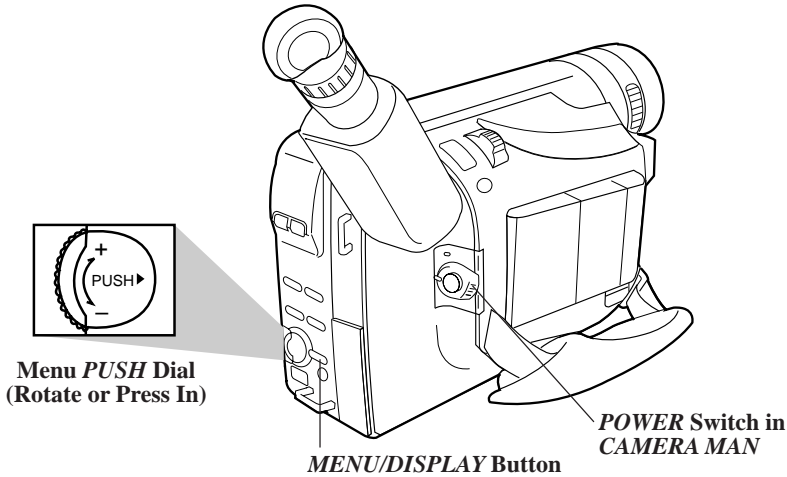

Menu *PUSH* Dial
(Rotate or Press In)

MENU/DISPLAY Button

POWER Switch in
CAMERA MAN

To Record Using Time Lapse

1. Set the *POWER* switch to *CAMERA MAN*.
2. Press and hold *SP/SLP* to select *SP*.
SP appears in the viewfinder or on the LCD monitor.
3. Press the *MENU/DISPLAY* button to display the menu in the viewfinder or on the LCD monitor. *D. ZOOM* is highlighted.

D. ZOOM	ON
TELE MACRO	OFF
TAPE LENGTH	T30
REC TIME	OFF
INT. TIME	OFF
TALLY LAMP	ON
DATE/TIME	
TITLE LANG.	ENGLISH
DEMO MODE	OFF
▶RETURN	

4. Rotate the menu *PUSH* dial down to highlight *INT. TIME* and press it in to display the *INT. TIME* menu.

Recording

Time-Lapse Recording (continued)

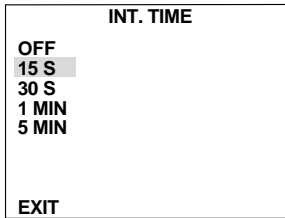

5. Rotate the menu *PUSH* dial down to highlight the desired time between recordings (*15S*, *30S*, *1 MIN*, or *5 MIN*).

- Select *15S* to delay the recording for 15 seconds.
- Select *30S* to delay the recording for 30 seconds.
- Select *1 MIN* to delay the recording for one minute.
- Select *5 MIN* to delay the recording for five minutes.
- Select *OFF* if you do not want the camcorder to delay recording.

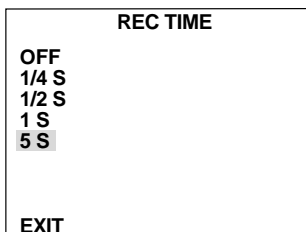

6. Press the menu *PUSH* dial in to display the menu again. Rotate the menu *PUSH* dial to highlight *REC TIME* and press it in to display the *REC TIME* menu.



7. Rotate the menu *PUSH* dial to highlight the amount of time you want the camcorder to record.

- Select *1/4S* to record for 1/4 second.
- Select *1/2S* to record for 1/2 second.
- Select *1S* to record for one second.
- Select *5S* to record for five seconds.
- Select *OFF* if you do not want to record for a selected amount of time.

8. Press the menu *PUSH* dial *twice* to exit the menus.

 and the amount of recording time and  and the amount of interval time between recordings appear in the viewfinder or on the LCD monitor.

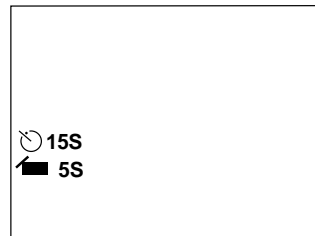

9. Press the thumb trigger to start recording.

Note: The camcorder starts and stops recording the selected amount of time. The tally light flashes with the flash speed increasing five seconds before recording begins.

Note: Fade does not operate during animation or time-lapse recording.

To Stop Time-Lapse Recording

Set the *REC TIME* and *INT. TIME* in the menus to *OFF*.

Recording

Tally Light (Turn On or Off)

You can turn the tally light on or off using the menu.

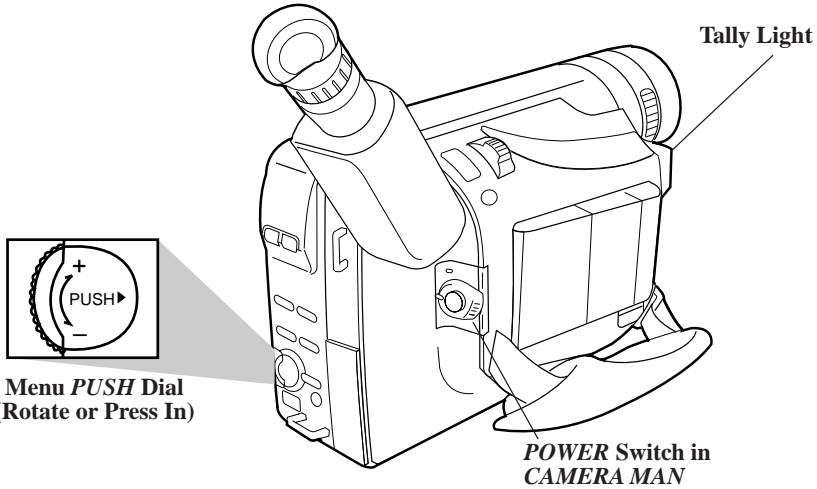

To Turn the Tally Light On or Off

1. Set the *POWER* switch to *CAMERA MAN*.
2. Press the *MENU/DISPLAY* button to display the menu in the viewfinder or on the LCD monitor. *D. ZOOM* is highlighted.

D. ZOOM	ON
TELE MACRO	OFF
TAPE LENGTH	T30
REC TIME	OFF
INT. TIME	OFF
TALLY LAMP	ON
DATE/TIME	
TITLE LANG.	ENGLISH
DEMO MODE	OFF
▶RETURN	

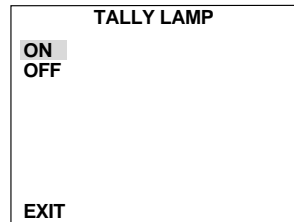

3. Rotate the menu *PUSH* dial down to highlight *TALLY LAMP* and press it in to display the *TALLY LAMP* menu.
4. Rotate the menu *PUSH* dial to highlight *OFF* or *ON*. Press the *MENU* dial twice to select *ON* or *OFF* and remove the menu.
 - Select *ON* if you want the tally light to light during recording.
 - Select *OFF* if you do not want the tally light to light during recording.

Recording

Demo Mode

You can turn on the *DEMO* mode in the *MENU* to have a demonstration of some of the camcorder's features.

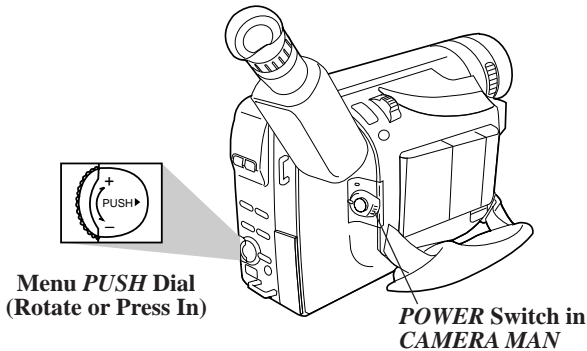

To Turn the Demo Mode On

1. Set the *POWER* switch to *CAMERA MAN*.
2. If a cassette is inserted, remove the safety tab or set it to *REC OFF*.
3. Press the *MENU/DISPLAY* button to display the menu in the viewfinder or on the LCD monitor. *D. ZOOM* is highlighted.

D. ZOOM	ON
TELE MACRO	OFF
TAPE LENGTH	T30
REC TIME	OFF
INT. TIME	OFF
TALLY LAMP	ON
DATE/TIME	
TITLE LANG.	ENGLISH
DEMO MODE	OFF
▶RETURN	

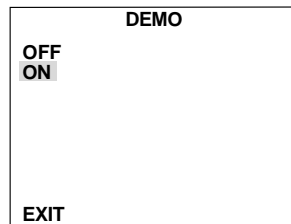

5. Rotate the *MENU* dial to highlight *OFF* or *ON*. Press the *PUSH* dial twice to select *ON* or *OFF* and remove the menus.
 - Select *ON* if you want the camcorder to demonstrate some of the recording features.
Note: Zoom is the only feature that operates during the demo mode.
 - Select *OFF* if you do not want a demonstration.

4. Rotate the menu *PUSH* dial down to highlight *DEMO MODE* and press it in to display the *DEMO* menu.

To Turn the Demo Mode Off

Turn off the camcorder.

Recording

Attach the Shoulder Strap

The camcorder's shoulder strap is designed to let you carry the camcorder from your shoulder and – when you are ready to shoot – bring the camcorder to shooting position in one quick movement.

To Attach the Shoulder Strap

1. If the strap keeper is over a double section of the strap, slide the strap keeper off the end of the strap. Replace the keeper on the strap between the buckle and the end of the strap *as shown*.

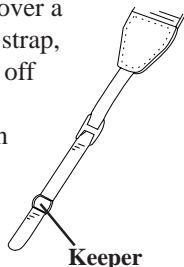

3. Thread the end of the strap back through the keeper and buckle making sure it is threaded under the outer strap. Make sure the strap is not twisted.

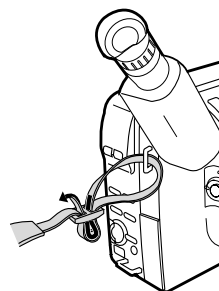

2. Loop the end of the strap over the top of the shoulder strap attachment ring.

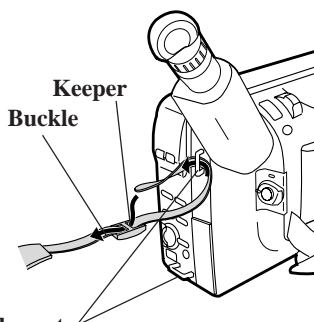

Attachment Rings

4. Attach the other end of the strap to the other shoulder strap attachment ring.
5. Adjust the shoulder strap to the desired length.
6. Slide both keepers up snugly against the shoulder strap attachment rings to prevent the strap from slipping.

Cautions: When carrying the camcorder with the shoulder strap, you may find it convenient to close the LCD monitor and rotate the viewfinder down. This helps prevent possible damage to the monitor or viewfinder from bumping against your body as you move. Make sure the shoulder strap is firmly attached before using it to carry the camcorder.

Recording Tips

- Try to make sure indoor scenes are well-lit. This improves picture quality and color reproduction.
- Do not move the camcorder rapidly from side-to-side while recording. A steady, gradual “pan” avoids blurring and “jitter”.
- Use the viewfinder or LCD monitor to make sure the camcorder is level while recording so that your scene isn’t “tilted.”
- Do not bump or tap the camcorder’s microphone while recording because this sound will be recorded.
- Include close-ups of individuals when taping family outings or group functions.
- Fading in and out of scenes makes your videos appear more professional.
- Learn to use the special production effects available with your camcorder to add variety to your recordings.
- Be aware of video and audio backgrounds. Background details barely noticed while you are taping may show up as visual “clutter” on your recording. Background noises (especially TV sets, radios, household appliances, traffic sounds, etc.) might detract from the sound you want to record.
- Avoid long “still” shots of landmarks and scenic attractions. Recordings are more interesting if they include people and details. “Local color” gives travel videos lasting appeal. Consider recording a familiar or landmark scene from an unfamiliar vantage point.

Playback

Use the LCD Monitor or Viewfinder for Playback

You can view tapes in the LCD monitor or the viewfinder. You can hear the sound from the tapes on the built-in speaker.

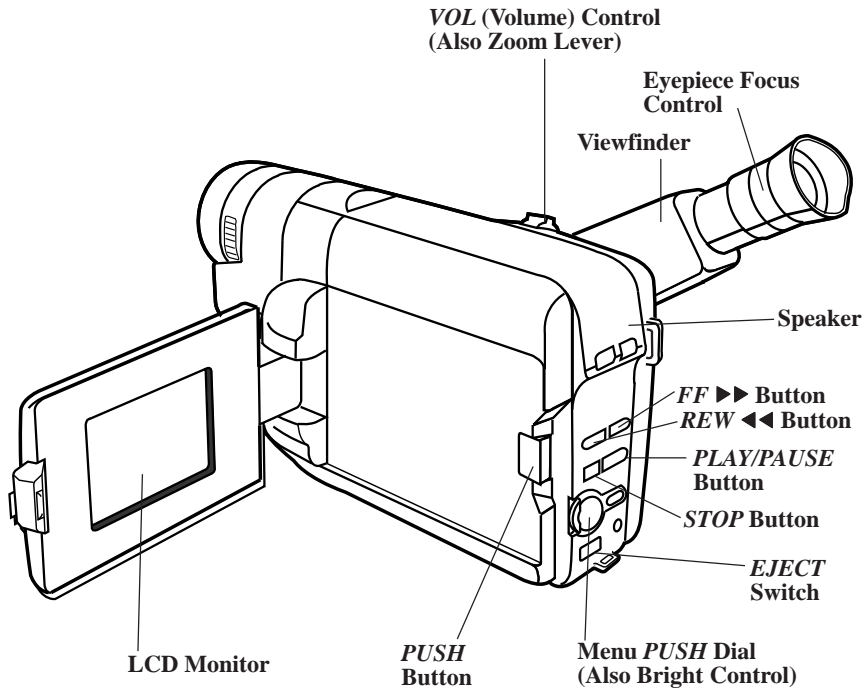

Use the LCD Monitor or Viewfinder for Playback (continued)

To Play Back a Tape

1. Attach a power supply.

Attach the adapter/charger, charged battery, or optional car cord.

2. Insert a tape.

- Open the LCD monitor. Open the monitor at least 60° before opening the cassette compartment.
- Slide *EJECT* switch to the left to open the cassette compartment.
- Turn the tape wheel on the cassette to remove any slack from the tape.
- Insert the cassette with the tape wheel facing up and the tape window facing out.
- Press on the *PUSH* button to lock the cassette compartment closed.

3. Set the *POWER* switch to *VCR*.

The power indicator lights.

4. Use the LCD monitor or viewfinder to see what you are playing back.

Use the LCD Monitor

- Make sure the monitor is open 60°. The viewfinder turns off.
- Rotate the monitor to a comfortable viewing position (180° up and around or 90° down).
- Adjust the brightness of the image by turning the Bright control (also menu *PUSH* dial).
- Adjust the speaker volume with the *VOL* (volume) control (also zoom lever).

Use the Viewfinder

- Make sure the monitor is closed and locked. The viewfinder turns on.
 - Adjust the viewfinder for a comfortable viewing position.
 - Turn the eyepiece focus control to adjust the focus of the viewfinder for your vision.
- #### 5. Press the *PLAY/PAUSE* button to begin playback.
- The ► indicator appears in the viewfinder or on the LCD monitor during playback.
 - If necessary, adjust tracking.
 - During playback, use the playback features *on the following pages*.
- #### 6. Press the *STOP* button when you are finished.

Playback Features

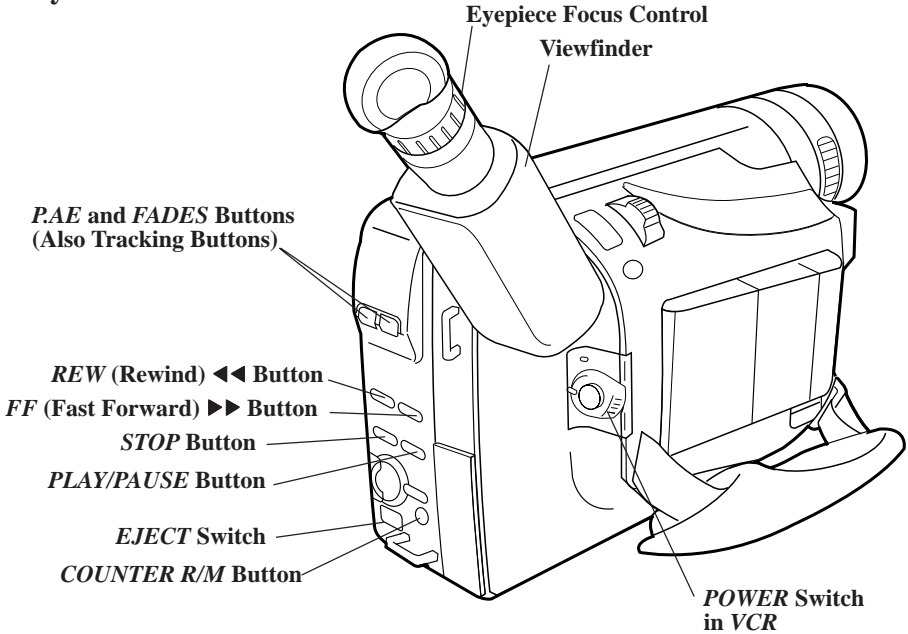

Position the Tape

Set *POWER* switch to *VCR* and press *STOP*.

- Press and quickly release the *REW* (rewind) ◀◀ button or *FF* (fast forward) ▶▶ button to rewind or fast-forward the tape.
- Press *STOP* to stop the tape.

Visual Search

- During playback, press and release *REW* (rewind) ◀◀ button or *FF* (fast forward) ▶▶ button if you want to search the tape visually in forward or reverse.
- Press *PLAY/PAUSE* to return to normal playback.
- For brief searching, press and hold *REW* (rewind) ◀◀ button or *FF* (fast

forward) ▶▶ button for more than two seconds. Release the button to return to normal playback.

Stop-Action Pause

- During playback, press *PLAY/PAUSE* to “stop the action” and view one frame of the tape.
- Press *PLAY/PAUSE* to return to normal playback.

Caution: Pause is designed for momentary interruptions and should not be used for an extended period of time. If the camcorder remains in pause for more than five minutes, it enters the stop mode and turns off to prevent excessive tape wear.

Playback Features (continued)

Time Counter

The time-counter display shows the actual time elapsed when playing back a segment of tape. The memory-stop feature helps locate a certain point on the tape. Turn memory stop on to stop the tape automatically during rewind or fast forward when the time counter reaches *M 0:00:00*.

To Use the Memory-Stop Feature

1. Locate the place on the tape you want to return to, set the *POWER* switch to *VCR*, and press *COUNTER R/M* for more than two seconds to reset the counter to *0:00:00*.
2. Press *COUNTER R/M* for less than one second to turn the time counter's memory-stop feature on or off. When memory stop is on, an *M* appears before the time counter.



Time Counter With Memory Stop Turned On

3. Continue to play the tape. When you want to return to the place you marked, press the *STOP* button.
4. Press *REW* ◀◀. The tape rewinds to the time counter reading of *M 0:00:00*.

Tracking

During playback, streaks may appear in the playback picture. Press both tracking buttons (*PAE* and *FADES* buttons) to activate manual tracking mode. Press either button again until the streaks disappear. *MT* appears during manual tracking.

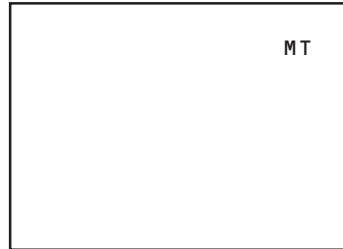

Manual Tracking Indication in Viewfinder or on LCD Monitor

Press both tracking buttons again to turn automatic tracking back on. *AT* flashes in the viewfinder for a few seconds and then disappears.

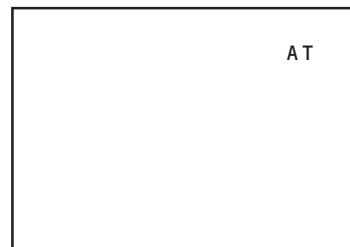

Auto Tracking Indication in Viewfinder or on LCD Monitor

Note: The tracking buttons may have no effect on tapes recorded on other camcorders or VCRs.

Use the Cassette Adapter

The camcorder uses a smaller size cassette, but records in standard VHS format. The cassette adapter allows you to play your VHS-C cassettes in a VCR just like other standard VHS cassettes.

Insert the VHS-C cassette into the cassette adapter. Insert the cassette adapter into the VHS VCR like a normal VHS cassette.

Install Cassette Adapter's Battery

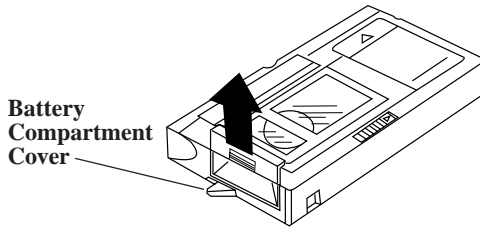

1. Remove battery compartment cover.
2. Install supplied "AA" battery so positive (+) and negative (-) ends align properly with (+) and (-) terminals in battery compartment.
3. Replace battery compartment cover.

Notes: Replace the battery when the load time becomes much longer than normal.

Remove the battery from the cassette adapter if it is not used for a month or more. This prevents possible damage from battery leakage. If leakage occurs, wipe up the liquid inside the compartment and replace the battery with a new one.

Insert Cassette into Cassette Adapter

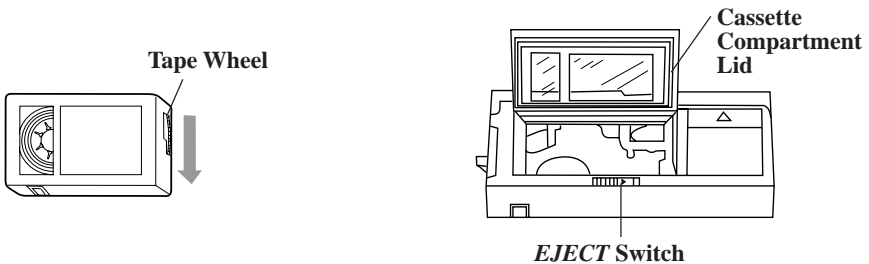

1. Before inserting the cassette into the adapter, remove any slack in the tape by turning the tape wheel on the side of the cassette.
2. Slide *EJECT* to the right to open the cassette compartment lid.
3. Insert the cassette with the tape window on the left and facing up. Allow the cassette to drop into the adapter. **Do not force the cassette.**

Playback

Use the Cassette Adapter (continued)

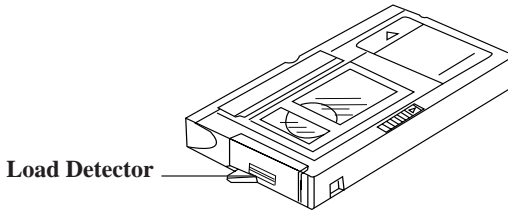

4. Gently close the cassette compartment lid until it locks into place. Make sure the cassette reel area under the adapter is free to turn while the cassette is loading.

Note: You should hear a whirring sound while the tape loads. The adapter's load detector will automatically retract into the adapter.

Caution: If the load detector is still extending from the side of the cassette adapter after you have attempted to load the cassette, loading is not complete. Try to load the cassette again. Attempting to insert the cassette adapter into a VCR with the load detector extending may cause damage to the adapter and/or VCR.

Remove Cassette from Cassette Adapter

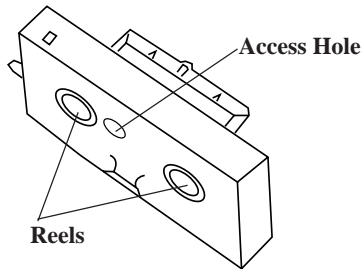

1. Slide the adapter's *EJECT* switch to the right. The load detector extends from the side and the whirring sound indicates the tape is being released before the adapter's cassette compartment lid opens.
2. Use the access hole on the bottom of the adapter to push the cassette up and remove it from the adapter.
3. Gently close the adapter's cassette compartment lid.

Caution: Do not touch the reels during loading and unloading. It could cause injury or damage the cassette adapter or tape.

Playback on TV (or VCR) with Audio/Video Inputs

To connect your camcorder to a TV monitor (or VCR) with audio/video inputs, you need an optional audio/video cable, such as VH83 *shown on page 68*. If your TV is already connected to a VCR, attach the camcorder to the VCR and watch what the camcorder is recording or playing on the TV.

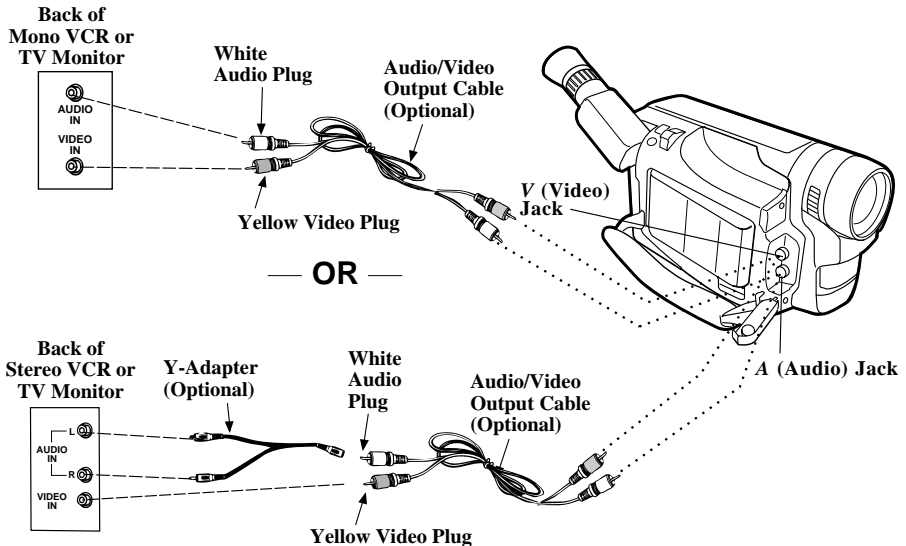

Installation

1. Attach the white plug on one end of the audio/video cable to the **AUDIO IN** jack on the TV (or VCR).
2. Attach the yellow plug to the **VIDEO IN** jack on the TV (or VCR).
3. Attach the white plug on the other end of the audio/video cable to the **A** (audio) jack (located under the small cover) on the side of the camcorder.
4. Attach the yellow plug to the yellow **V** (video) jack on the camcorder.

Notes: If your cable does not have white and yellow plugs, attach the same color to the audio jacks.

If your TV (or VCR) has stereo **AUDIO IN** jacks, attach the plug to the one labeled **MONO**. If one is not labeled **MONO**, you need a Y-adaptor, such as AH25, *shown on page 68* to hear both channels.

Playback

Playback on TV (or VCR) with Audio/Video Inputs (continued)

Playback Operation and How to Copy Tapes on the VCR

1. A. Camcorder connected directly to TV: Turn on the TV and tune it to the video input channel.
 - During playback, use the playback features on pages 60-61.
- B. Camcorder connected to VCR that is already connected to TV: Turn on VCR and place it in the “line” or “camera mode”. (If your VCR does not have a “line” or “camera mode”, consult the VCR owner’s manual.) Operate the TV as you normally do to see the signal coming from the VCR.
2. Set the *POWER* switch to *VCR* to turn on the camcorder. The power indicator lights.
3. Press *PLAY/PAUSE*.
4. To copy what the camcorder is playing, place a blank cassette in the VCR, and press the VCR’s *RECORD* button.

Note: Make sure the memory-stop feature is turned off (press *COUNTER R/M*) or the camcorder enters play-pause when the counter reaches *M 0:00:00*.
5. Press *STOP* when you are finished.

Caution: The unauthorized recording of copyrighted material may infringe the rights of others.

Viewing What the Camcorder is Seeing (or Recording)

1. A. Camcorder connected directly to TV: Turn on the TV, and tune it to the video input channel.
- B. Camcorder connected to VCR that is already connected to TV: Turn on VCR and place it in the “line” or “camera mode”. (If your VCR does not have a “line” or “camera mode”, consult the VCR owner’s manual.) Operate the TV as you normally do to see the signal coming from the VCR.
2. Set the *POWER* switch to *CAMERA*.

Note: Turn the TV’s volume down to prevent a high-pitched squeal caused by feedback.
3. Press the thumb trigger to begin recording. You can watch what the camcorder is seeing (or recording) on the TV screen.

Traveling Tips

- Write down your camcorder's serial number and keep it separate from the camcorder when traveling. If your camcorder is lost or stolen, you will be able to identify it.
- Use extra care to avoid damage to your camcorder and accessories when operating them at a beach or pool. Spray, sand, and dust should be avoided. If your lens has been exposed to the elements, clean it only with proper lens cleaning supplies.
- Make sure you have any plug adapters that you might need before taking your camcorder to other countries. Consult your dealer for advice.
- Carry your camcorder in a carrying case when traveling. *See the next page* for a case designed especially for this camcorder. An ordinary suitcase or carry bag does not offer the protection your camcorder needs. Treat your camcorder as carry-on luggage to protect it from rough handling.

Optional Accessories

We invite you to take a look at some great ideas for sparking creativity and adding to the fun of using your compact VHS camcorder. The following pages have a selection of accessories to help make your memorable moments look and sound even better.

These accessories are designed to make the process of recording and watching your videos more enjoyable.

To order accessories, contact your local Dealer.

If a dealer is not nearby, all accessories are available through toll-free ordering or by using the order form *on page 71*.

AC201A Soft Carrying Case

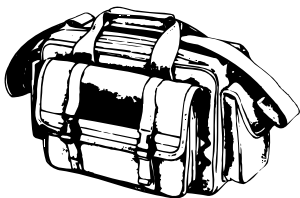

Custom compact soft case designed especially to provide protection and utility for your compact VHS camcorder and most accessories. Rugged fabric lined with soft non-abrasive material and generous padding. Has three outside pockets with storage for lens filters, adapters, batteries, and tapes.

DCC08 Car Cord Adapter

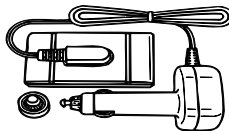

Do not use any other car cord with this camcorder.

This car cord adapter enables you to operate your camcorder from your car, truck, or RV by plugging the car cord directly into the vehicle's cigarette lighter socket. The DCC08 is designed specifically to convert power from a 12-volt battery to a 6-volt output.

Optional Accessories

FB1260 Rechargeable Battery

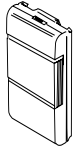

This rechargeable, 1-hour, nickel-cadmium battery is designed specifically for long life. The FB1260 can be recharged with the AC adapter/charger that came with your camcorder.

244265 Rechargeable Battery

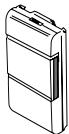

This rechargeable 2-hour, nickel metal hydride battery is designed specifically for long life. The FB1260 is a 1-hour nickel cadmium battery. The 244265 powers your camcorder approximately twice as long as the FB1260 (depending on how much you use zoom and pause). The 244265 can be recharged with the AC adapter/charger that came with your camcorder.

All specifications and descriptions of accessories are subject to change without notice.

CPS91 AC Battery Charger

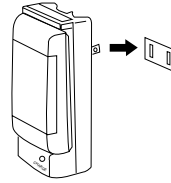

The CPS91 battery charger plugs directly into an AC outlet and charges the FB1260 and 244265 camcorder batteries.

Because the CPS91 operates on 100-240 Volts, 50/60 Hz, it can be used virtually anywhere in the world. A plug adapter might be required in some countries. Charging takes approximately seven hours for the FB1260 (1-hour battery), and 13 hours for the 244265 (2-hour battery).

VH83 Audio/Video Cable

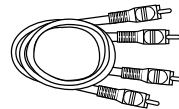

This six foot audio/video cable can be used to connect the camcorder to a TV monitor or VCR for tape playback or copying tapes.

AH25 Y-Adapter



This Y-adapter allows you to connect your camcorder's mono audio cable to a stereo TV or VCR.

Optional Accessories

Using the Optional AC088 Tripod

Mounting the camcorder on a tripod, such as AC088, keeps the camcorder steady and produces excellent video results.

This tripod's fluid-effect head provides smooth camera pan and tilt. The quick-release mount makes it easy to attach or remove the camcorder. The grooved, tubular 3-section leg design folds down to 26" when not in use. Rubber feet allow for sure footing.

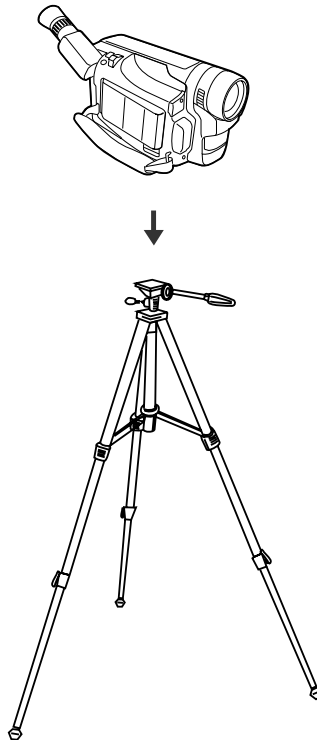

Cautions: Before using a tripod, make sure it is stable enough to hold the camcorder without falling over. Do not transport the camcorder attached to the tripod.

When attaching your camcorder to a tripod, be careful not to force the tripod screw into the camcorder's tripod mounting hole.

The tripod screw should not protrude into the camcorder more than approximately three-eighth (3/8) inch. Forcing the screw could damage the mounting hole on the bottom of the camcorder.

Accessory Order Form

To order accessories, contact your local Dealer.

If a dealer is not nearby, you can also follow the directions below to order by telephone or direct-by-mail.

United States and Canada Orders

To place your order by phone, have your Visa, MasterCard, or Discover card ready and call the toll-free number listed below between 8 AM and 10 PM (EST) Monday through Friday or between 9AM and 5PM (EST) Saturday.

Use this number only to place an order for accessory items listed on this order form.

1-800-338-0376

To place your order by mail, detach and mail the completed order form with credit card information, money order, or check in U.S. currency (made payable to Thomson Consumer Electronics, Inc.) to the following address:

Video Accessories
PO Box 8419
Ronks, PA 17573

Accessory Order Form

Order Form for Camcorder Models CC6372 and CC6392

Description	Part No.	Price	Qty.	Total
Super Lightweight Tripod	AC088	\$ 39.95		
Soft Camcorder Case	AC201A	\$ 39.95		
Shoulder Strap	ACS091	\$ 12.95		
Y-Adapter	AH25	\$ 2.95		
AC Battery Charger	CPS91	\$ 59.95		
Car Cord Adapter	DCC08	\$ 89.95		
Rechargeable Battery (Standard)	FB1260	\$ 49.95		
Audio/Video Cable	VH83	\$ 5.95		
Rechargeable Battery (Extended)	244265	\$ 89.95		
DC Cable and AC Adapter/Charger	244268 244269	\$ 28.35 \$ 97.20		
Cassette Adapter	244270	\$ 72.75		

Prices are subject to change without notice.

Total Merchandise \$ _____

Sales Tax \$ _____

We are required by law to collect the appropriate sales tax for each individual state, county, and locality to which the merchandise is being sent.

Shipping and Handling \$ **5.00**

Total Amount Enclosed \$ _____

Use VISA, MasterCard, or Discover.

Money order or check must be in U.S. currency only. No COD or cash.

Detach Here



Please complete other side also

Accessory Order Form

Charge your order on your VISA, MasterCard,
or Discover Card by filling in below

USE YOUR CREDIT CARD

IMPORTANT: Copy complete account number from your VISA card

Expiration date:



IMPORTANT: Copy complete account number from your MasterCard

Copy Number above your name on MasterCard

Expiration date:



IMPORTANT: Copy complete account number from your Discover Card

Expiration date:



AUTHORIZED SIGNATURE

Prices are subject to change without notice.

Print or type your name and
address clearly.

A complete and correct order will
save you days of waiting.

↓

Name: _____
Street: _____
_____ Apt: _____
City: _____
State: _____ Zip: _____

Please make sure that both sides of this form have been filled out completely.

- Allow 4 weeks for delivery.
- All accessories are subject to availability.

Detach Here 

Trouble Checks

Troubles sometimes are caused by simple “faults” that you can easily correct without the help of a service technician by first checking a few basic remedies.

Before you call or take your camcorder to an Authorized RCA Camcorder Service Center, look below for the type of trouble you are experiencing. Then perform the simple checks and adjustments listed for that trouble.

If service should be necessary, the warranty information lists what your warranty covers and explains how to get service.

Trouble	Checks and Adjustments
No power	<ul style="list-style-type: none"> • Set the <i>POWER</i> switch to <i>CAMERA</i> or <i>VCR</i> to turn on the camcorder. The power indicator lights. • If using battery, it might need to be recharged. • If using AC adapter/charger, make sure it is plugged into a working outlet.
Won't record or playback	<ul style="list-style-type: none"> • If using AC adapter/charger, make sure it is plugged into a working outlet. • If the dew indicator () flashes on the monitor or in the viewfinder, there is moisture in the camcorder. Wait until the dew indicator no longer appears before operating the camcorder. • Make sure <i>POWER</i> switch is set to correct position for desired operation. • There might not be a cassette in the camcorder. • Try ejecting and reinserting the cassette. • The cassette tape might be broken, try another cassette. • You might have reached the end of the cassette, try rewinding it.
Won't playback	<ul style="list-style-type: none"> • <i>POWER</i> switch must be set to <i>VCR</i> position.
Won't record	<ul style="list-style-type: none"> • Safety tab removed or closed. (See page 22.) • <i>POWER</i> switch must be set to <i>CAMERA</i>.
No picture	<ul style="list-style-type: none"> • Open lens cover.
Camcorder turns itself off	<ul style="list-style-type: none"> • Set <i>POWER</i> switch to <i>OFF</i> and then to <i>CAMERA</i> or <i>VCR</i> to turn back on. If camcorder is left in record-pause or play-pause for several minutes, it turns off to prevent tape wear.

Trouble Checks

Trouble	Checks and Adjustments
Tape stops during rewind or fast forward	<ul style="list-style-type: none"> • Time-counter memory might be on. Whenever an “M” appears with the time-counter display, the camcorder stops rewinding (or fast forwarding) when counter reads <i>M 0:00:00</i>. Press <i>REW ◀◀</i> or <i>FF ▶▶</i> again to continue rewinding or fast forwarding, or press <i>COUNTER R/M</i> to turn off the memory-stop feature.
Camcorder remains in pause mode	<ul style="list-style-type: none"> • Press <i>PLAY/PAUSE</i> to return to normal playback.
Dew indicator flashes in viewfinder	<ul style="list-style-type: none"> • If the dew indicator () flashes, there is moisture in the camcorder. Wait until indicator no longer appears before operating the camcorder.
Poor auto-focus operation	<ul style="list-style-type: none"> • Subject is dark or behind glass. Auto-focus may not work under these conditions. Place <i>POWER</i> switch in <i>CAMERA MAN</i> and focus manually. <i>See pages 36-37.</i> • Subject not in center of viewfinder (or monitor) or two subjects are at different distances. Place <i>POWER</i> switch in <i>CAMERA MAN</i> and focus manually. <i>See pages 36-37.</i> • Lens is smudged, and image appears unfocused.
Viewfinder displays are out of focus	<ul style="list-style-type: none"> • Lens is smudged and image appears unfocused. • Eyepiece focus control is misadjusted.
Picture is too dark or subject too dark	<ul style="list-style-type: none"> • For best results, only use higher shutter speeds outdoors. Press <i>P. AE</i> button to select <i>SPORTS</i> or <i>1/2000</i>. <i>See page 44.</i> • Place <i>POWER</i> switch in <i>CAMERA MAN</i> and adjust the exposure manually. <i>See pages 40-41.</i>
Sound is too low or distorted	<ul style="list-style-type: none"> • Subject was too far from camcorder.
Picture recorded with special effect	<ul style="list-style-type: none"> • Place <i>POWER</i> switch in <i>CAMERA AUTO</i>.
Colors do not look natural on recording	<ul style="list-style-type: none"> • Try adjusting white balance. <i>See pages 38-39.</i>
Title recorded on tape	<ul style="list-style-type: none"> • Title is recorded when it appears in viewfinder or on the LCD monitor. Remove the title. <i>See pages 46-47.</i>

Trouble Checks

Trouble	Checks and Adjustments
Date and/or time are recorded on tape	<ul style="list-style-type: none"> • Displays are recorded on tape whenever they appear in the viewfinder or LCD monitor. Remove them when recording. <i>See pages 20-21.</i> • When <i>AUTO DATE</i> is selected (<i>POWER</i> switch in <i>CAMERA AUTO</i>), date display is automatically recorded when you begin recording or change the cassette. <i>See pages 20-21.</i>
Date and/or time are incorrect	<ul style="list-style-type: none"> • Clock lithium cell battery might need replacing. <i>See page 17.</i> • Date or time might need to be set. <i>See pages 18-19.</i>
Cannot set <i>REC</i> or <i>INT. TIME</i> for animation or time-lapse recording	<ul style="list-style-type: none"> • Make sure there is a tape in the camcorder. • Check tape speed setting. Tape speed must be set to <i>SP</i> for time-lapse or animation recording. • Make sure <i>POWER</i> switch is not set to <i>CAMERA AUTO</i> to display the menu. <i>See pages 50-53.</i>
Cannot record at beginning of tape using animation or time-lapse recording	<ul style="list-style-type: none"> • Record for at least five seconds at beginning of tape to start tape running smoothly. • Use fade-in feature before starting to record at beginning of tape.
Tally light does not light during recording	<ul style="list-style-type: none"> • <i>TALLY LAMP</i> feature set to <i>OFF</i> in the <i>TALLY LAMP</i> menu. <i>See page 54.</i>
Vertical white lines appear when shooting bright object	<ul style="list-style-type: none"> • This might occur when the background extremely contrasts with the subject.
Error number (<i>E01</i> , <i>E02</i> , etc.) appears in viewfinder	<ul style="list-style-type: none"> • Try disconnecting power source. Wait ten seconds and then connect power source again. If error number does not disappear from viewfinder or LCD monitor, consult your Authorized RCA Camcorder Service Center.
Streaks in picture during playback or play-pause	<ul style="list-style-type: none"> • Adjust tracking with <i>P.AE</i> and <i>FADES</i> buttons. <i>See page 61.</i>

Trouble Checks

Trouble	Checks and Adjustments
Bright, crystal-shaped spots appear in viewfinder or on LCD monitor	<ul style="list-style-type: none">• Sunlight is directly entering the lens.
Colored bright spots appear on LCD monitor	<ul style="list-style-type: none">• Black spots or bright spots of light (red, green, or blue) might appear on the LCD monitor. These spots are not recorded on the tape and are not due to a defect in the unit.
Back of LCD monitor is hot	<ul style="list-style-type: none">• The light used to illuminate the LCD monitor causes it to be hot. Close the LCD monitor and turn off the camcorder to let it cool down.
Rechargeable battery runs down sooner than expected	<ul style="list-style-type: none">• If battery has not been used for some time, completely drain the battery's power and recharge it.• Battery run times are measured when the camcorder is recording continuously. You can check your battery by first fully charging it and then aiming the camcorder at a clock and recording the picture of the clock. When the recording stops, play the last recorded section and note the clock time. A one-hour battery should give you about 60 minutes of recording time. In practical use, you might not be able to record for the full time because the camera uses battery power when it is waiting between recordings (record-pause) and zooming.

Specifications

General

Power requirement: 6VDC
Power consumption: CC6372
Viewfinder on: 6 watts
LCD monitor on: 6.5 watts
LCD monitor and Viewfinder on:
7.1 watts
Power consumption: CC6392
Viewfinder on: 6 watts
LCD monitor on: 6.5 watts
LCD monitor and Viewfinder on:
7.1 watts

Weight: CC6372: 1.9 lbs. (880g)

Weight: CC6392: 1.9 lbs. (860g)

Dimensions – Including Viewfinder:

CC6372
3-5/16" (W) x 4-11/16" (H) x 7-13/16" (D)
99 (W) x 119 (H) x 198 (D) mm
CC6392
3-5/16" (W) x 4-11/16" (H) x 7-13/16" (D)
100 (W) x 119 (H) x 198 (D) mm

Video Recorder Section

Format: VHS-C
Record/playback system:
Four video record/playback heads
One flying erase head
Video signal: EIA standard
NTSC color

Viewfinder

CC6372: 0.5" B/W electronic viewfinder
CC6392: 0.55" Color electronic viewfinder

LCD Monitor

CC6372: 2.5" diagonally measured
LCD/TFT active matrix system
CC6392: 3" diagonally measured
LCD/TFT active matrix system

Camera Section

Image sensor: 1/4" CCD imager
Lens: F1.6, f=3.9 to 62.4mm
16:1 power zoom lens
50:1 digital zoom
Filter diameter: 40.5 mm

Tripod Mount

One 1/4" x 20 threaded hole

AC Adapter/Charger

Power requirement: 100-240 V, 50/60 Hz.
Power consumption: 23 watts
Weight: .71 lbs. (300g)
Dimensions:
5-9/16"(W) x 1-11/16"(H) x 2-11/16"(D)
140 (W) x 42 (H) x 68 (D) mm

Service Port

3.5 mm, 4 pole, mini-head jack

Care and Maintenance

Clean the Camcorder

To clean the camcorder's exterior, remove any power source connected to the camcorder and gently wipe it with a clean soft cloth.

Caution: Use of strong cleaning products, such as those containing alcohol or benzine, might damage the camcorder.

Clean the Camcorder's Lens

To clean the camcorder's lens, blow it with a blower brush and gently wipe the lens with cleaning tissue and commercially prepared cleaning solution designed for use on camera lens. Improper cleaning might scratch the lens.

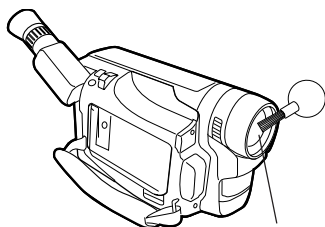

Lens

Caution: Do not touch the lens with your fingers. The oil from your skin might damage the lens.

Clean the Camcorder's LCD Monitor

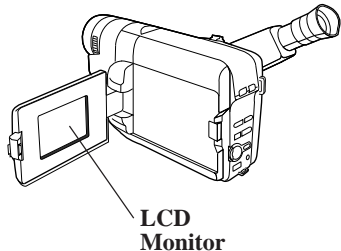

LCD
Monitor

To clean the camcorder's LCD monitor, use a clean, soft cloth to carefully wipe the monitor. Improper cleaning might scratch the monitor.

Clean the Camcorder's Viewfinder

You can remove the viewfinder eyepiece for cleaning.

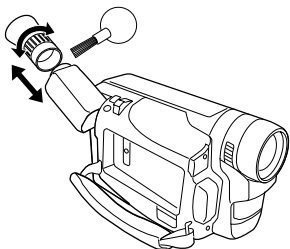

1. Turn the eyepiece counterclockwise and pull it out.
2. Remove dust using a blower brush.
3. Reattach the eyepiece by aligning the reference marks, and then turn the eyepiece clockwise until it clicks.

Proper Care and Storage

- Keep dust and grit from entering the camcorder's cassette door. Dust and grit are abrasive and cause excessive wear to both the camcorder's recording/playback heads and cassettes.
- Always close the lens cover when the camcorder is not in use.
- Before handling your camcorder, make sure your hands and face are free from any chemical products such as suntan lotion, as it might damage the finish.
- The camcorder might be damaged by improper storage or handling. Do not subject the camcorder to swinging, shaking, or dropping.
- Do not store the camcorder in temperatures below -22°F (-30°C) or above 149°F (65°C).
- When the camcorder is not in use, always remove the cassette and AC adapter/charger or battery.
- Retain the original carton for future storage or shipping purposes.

Things to Avoid

- Do not attempt to disassemble your camcorder. There are no user-serviceable parts inside.
- Avoid operating your camcorder immediately after moving it from a cold location to a warm location. Give the camcorder 1-1/2 to 2 hours to reach a stable temperature before inserting a cassette. When the camcorder is moved from cold to warm, condensation might cause the tape to stick to the headwheel and damage the headwheel or tape.
- Do not aim your camcorder at the sun or other bright objects.
- Do not leave your camcorder in direct sunlight for extended periods of time. The resulting heat buildup might permanently damage the camcorder's internal parts.
- Do not operate the camcorder in extremely humid environments.
- Do not operate the camcorder near the ocean as salt water or salt water spray might damage the internal parts of the camcorder.
- Do not operate the camcorder for extended periods in temperatures below 40°F (4°C) or above 95°F (35°C).
- Do not expose the camcorder or adapter/charger to rain or moisture. If any component becomes wet, turn off the power and take the unit to an Authorized RCA Camcorder Service Center.
- Do not use an adapter/charger or batteries other than the ones specified for the camcorder. Use of the wrong accessories might cause damage to the camcorder.

Customer Assistance and Service

You can reach Thomson at the following number:

800-283-6503
(Toll free inside U.S.A.)

Our toll-free Camcorder number operates from 8 a.m. to 5 p.m., CST Monday – Friday for U.S. customers only

Thomson provides a toll-free telephone number to help you with any problems you may encounter with your camcorder. Many can be diagnosed over the phone, and if necessary, repair or replacement will be arranged. Please have your camcorder model/serial number and date of purchase ready when you call. If your unit is out of warranty, we will quote the cost of a repair or replacement unit to you.

Returning equipment to Thomson for repair or exchange

If we are unable to resolve your problem over the phone, we will gladly service your unit or exchange it for a new or refurbished camcorder. Refer to the limited warranty on the reverse side to learn about your specific rights and responsibilities.

Always consult Thomson and get a Return Authorization number before returning anything! Obtain a Return Authorization (RA) number from the telephone representative before returning your equipment to avoid delays, accounting errors, or even loss of your unit.

Important information to customers who ship defective equipment to Thomson Consumer Electronics

The Thomson representative who authorized the return of your equipment will give you an RA number over the phone. They will also provide you with instructions on where and how to return your Camcorder. Write the number in large, clear characters on the outside of the box. To avoid confusion and misunderstandings, shipments without an RA number clearly visible on the outside of the box will be returned to you at your expense.

Include a brief note describing the problem and any conversations about the problem you have had with Thomson personnel.

Include your name, address and model/serial number of your Camcorder. These numbers

are located on the bottom of your unit.

If your Camcorder is within the warranty period, please provide a copy of the bill of sale to verify purchase date. Use the original box and packing material to protect the equipment from damage in shipment.

For your protection, insure all shipments for full replacement value and use a reliable shipper. Thomson assumes no responsibility for warranty shipments from the customer to the factory if not shipped in the manner prescribed by Thomson.

Limited Warranty

What your warranty covers:

- Any defect in materials or workmanship.

For how long after your purchase:

- 90 days for labor charges.
- One year for parts.

The warranty period for rental units begins with the first rental or 45 days from date of shipment to the rental firm, whichever comes first.

What we will do:

During the initial 90 days

- Exchange your camcorder with a new or refurbished unit, or repair your camcorder. The option will be ours. There will be no cost to you.

After the 90 days and within one year

- Exchange your camcorder with a new or refurbished unit, or repair your camcorder. The option will be ours. Parts will be provided at no charge, but you will be responsible for the cost of labor required for the repair.

How you get service:

- Call 1-800-283-6503 and have your unit's date of purchase and model/serial number ready. The model/serial number information is on the bottom of your camcorder.
- A representative will troubleshoot your problem over the phone. If the representative determines that you should receive a replacement unit, you will be provided with a Return Authorization (RA) number and the location of a nearby exchange point if one exists. No returns will be accepted without the RA number.

To receive a replacement Camcorder before you return yours:

Option I

1. Provide your Discover, MasterCard, or Visa account number and expiration date

to our phone representative. This is for security purposes. If we receive your unit, excluding all accessories, within 14 days from the date you were provided the RA number, only items not covered by warranty will be charged to your account. **IF YOUR UNIT IS NOT RECEIVED WITHIN 14 DAYS, THE SUGGESTED RETAIL VALUE OF THE CAMCORDER WILL BE CHARGED TO YOUR CREDIT CARD.** This amount, less \$10.00 handling, will be credited if the unit is subsequently received.

2. We will send you a replacement unit.
3. Ship the unit back to us, excluding all accessories, using the replacement unit's carton. Shipping instructions will be included in the carton along with your RA number which will allow you to easily ship the unit back to us. **Make sure you insure your shipment in case of damage or loss.** Include with the shipment:
 - Evidence of purchase date, such as a bill of sale to verify your unit's warranty eligibility.
 - A brief note describing your camcorder's problem.
 - Your name, address and phone number.

Return transportation, storage, handling, and insurance costs are your sole responsibility. We accept no liability in case of damage or loss.

Option II

1. We will send a replacement unit to the exchange point.
2. The exchange location will notify you of its arrival.
3. Take your unit, excluding all accessories, and your evidence of purchase date, such as a bill of sale, to the exchange location and you will be provided the new or refurbished unit.
4. If the repairs were covered by your warranty, you will not be billed.

Limited Warranty

To receive a replacement unit after we have received your unit:

1. **Write the RA number on the outside of the carton used to return the unit. Make sure you insure your shipment in case of damage or loss.**
2. Carefully pack the unit, excluding all accessories, using the original box and packing material if possible.
3. Include with the shipment:
 - Evidence of purchase date, such as a bill of sale, to verify your unit's warranty eligibility.
 - A brief note describing your camcorder's problem.
 - Your name, address and phone number.

Return transportation, storage, handling, and insurance costs are your sole responsibility. We accept no liability in case of damage or loss.

4. The representative will advise the address to mail a cashier's check or money order for payment if there are any out of warranty labor or parts charges and you elect not to use your credit card.
5. Upon receipt of your product, a new or refurbished unit will be shipped to you.

To have your Camcorder repaired by an Authorized RCA Camcorder Service Center:

- Check with your dealer or call 1-800-336-1900 for the Authorized RCA Camcorder Service Center nearest you.
- Take your unit to the Authorized RCA Camcorder Service Center of your choice.
- Show the Authorized RCA Camcorder Service Center representative evidence of purchase date, such as a bill of sale.
- Pick up your camcorder when repairs are complete.

What your warranty does not cover:

- Adjustment of customer controls.

- Damage from misuse or neglect.
- A unit that has been modified or incorporated into other products or is used for institutional or other commercial purposes.
- Batteries for remote control and clock.
- Cleaning of video/audio heads.
- Camcorders purchased or serviced outside the U.S.A.
- Return transportation, storage and handling costs of your unit, including insurance for loss or damage.
- Acts of God, such as but not limited to lightning damage.

Product Registration:

- Please complete and mail the Product Registration Card packed with your camcorder. It will make it easier to contact you should it ever be necessary. The return of the card is not required for warranty coverage.

How State Law relates to warranty:

- This warranty gives you specific legal rights and you also may have other rights that vary from state to state.

If you purchased your camcorder outside the United States:

- This warranty does not apply. Contact your dealer for warranty information.

Index

16X9 recording 45
5SEC. REC button 11, 31, 33

A

A (audio) and V (video) jacks 11, 64

Accessories

- included 3
- optional 67
- order form 71

Adapter/charger

- charging battery 14
- using 4, 12

Animation indicator 31, 51

Animation recording 50

Assistance 1, 3

Assistance, customer 80

Attach shoulder strap, 56

Audio/video jacks 64

AUTO DATE display 20, 21

Auto date feature 32

Auto exposure 40

Auto focus 36

Auto white balance 38

AutoShot™ feature 6, 32

B

Battery

- attaching and removing 13
- care and storage 15
- charging 14
- refreshing 14

Battery, installing in cassette adapter 62

Battery level indicator 15, 28, 33

BATTERY RELEASE lever 11, 13

Bright control 26, 59

C

Camcorder, cleaning 78

Camcorder controls 10

Camera edit feature 33

Car cord adapter 16

Care and maintenance

- cleaning the camcorder viewfinder 78
- cleaning the LCD monitor 78
- proper care and storage 79
- things to avoid 79

Care and storage

- battery 15
- camcorder 79
- cassette 23

Cassette

- adapter 62
- care and storage 23
- compartment 10
- door 10
- inserting and removing 23
- tape wheel 23
- warning 28, 33

Cautions i

Checks and adjustments 73

Cleaning the camcorder's lens 78

Cleaning the LCD monitor 78

Clock cell battery compartment 11, 17

Clock cell indicator 17, 31

Copy tapes 65
COUNTER R/M button 61, 65
Customer assistance and service 80

D

Date and time display 21
 recording 20
 setting 18
DATE/TIME DISP. menu 20
DATE/TIME menu
 8, 35, 37, 46, 49, 52, 54
DC cable 12, 13, 14, 16
DC in jack 4, 11, 12
Demo mode 55
DEMO MODE menu 55
Design specifications 77
Dew warning 30
Digital zooming 34
Displays in LCD monitor and viewfinder
 28, 29, 30, 31
Displays, status 29

E

EJECT button 5, 10, 23, 59
Erase protection 22
Exposure control 40, 41
Exposure indicators 30, 41
Eyepiece focus control 7, 10, 27

F

Fade and wipe indicators 30, 42
Fade/wipe feature 42, 43
FADES button 10, 30, 42, 43, 61
Fast forward indicator 29
FF button 10, 60
First recording 9
First time operation 3
Five-second recording 33
Five-second recording indicator 31, 33
Flying erase head 33
Focus indicators 30, 37
Focusing 36, 37

H

Handstrap 4

I

Indicators
 animation 31, 51
 AUTO DATE display 28
 battery level 15, 33
 cassette warning 28, 33
 clock cell 17, 31
 date and time 28
 exposure 30, 41
 fade and wipe 30, 42
 five-second recording 31, 33
 focus 30, 37

Index

interval time 49, 53
LENS COVER 31
manual white balance 29
P. (program) AE 28, 44
record time 51, 53
REFRESH 14
self-timer 31
special effects 28
steady pix 31, 41
TAPE END 31
tape length 31, 33
tape speed 31
tape-remaining 31, 33
time counter 31
time display 28
time-lapse 31, 53
title display 28
tracking 29
white balance 39
zoom level 29, 34

Information to user 89

Inserting and removing cassettes 23

Interval time indicators 49, 53

L

LCD monitor 5, 7, 9, 10, 23, 26, 59

displays 28

playback 58

turn displays on or off 33

use to record 26

use when recording 7, 27

Lens 11

Lens cover 9

LENS COVER control 4

LENS COVER indicator 31

Letterbox recording 45

Lithium cell indicator 17, 31

Lithium cell, inserting and removing 17

Low-contrast indicator 36

M

M.W.B. menu 39, 41

Manual exposure 40

Manual focus 37

Manual white balance 38

Manual white balance indicators 29

Memory stop 61

Menu 8, 20

Menu PUSH dial

8, 10, 18, 19, 20, 21, 24, 25, 26,
32, 35, 37, 38, 40, 45, 46, 47, 49
51, 52, 53, 54, 55

MENU/DISPLAY button

8, 10, 18, 28, 32, 33, 34, 35,
46, 48, 50, 52, 54, 55

Microphone 11, 32

O

Operating controls 11

Optional accessories 67

Optional plug adapter 12

Order form, accessories 71

P

- P. (program) AE button 10, 28, 44, 61
- P. (program) AE indicators 28, 44
- Pause indicator 6, 9, 29
- Pause, stop-action 60
- Play indicator 29
- PLAY/PAUSE button 9, 10, 59, 60, 65
- Playback
 - first 9
 - LCD monitor 58
 - on TV (or VCR) with audio/video inputs 64
 - using cassette adapter 62
 - viewfinder 58
- Playback features
 - memory-stop 61
 - position the tape 60
 - stop-action pause 60
 - time counter 61
 - tracking 61
 - visual searching 60
- Playback on TV (or VCR) with audio/video in jacks 64
- Playback speeds 22
- Plug adapter, optional 12
- Power indicator 6, 9, 11, 16, 32
- POWER switch
 - 6, 8, 9, 11, 13, 15, 16, 18, 20, 21, 24, 28, 30, 32, 33, 34, 35, 36, 37, 38, 40, 42, 45, 46, 47, 48, 50, 52, 54, 55, 59, 60, 61, 65
- Powering your camcorder
 - using adapter/charger 12
 - using optional car cord adapter 16
 - using rechargeable battery 13

- Preset titles 46
- Problem solving 73
- Product registration i
- PUSH button 5, 10, 23, 59

Q

- Quick review feature 33

R

- RBRC seal 13
- REC TIME menu 51
- Record date and time display 20
- Record time indicators 51
- Recording
 - time-lapse 52, 53
- Recording, first 9
- Recording indicator 9, 29
- Recording speeds 5, 22
- Recording tips 57
- REFRESH button 14
- REFRESH indicator 14
- Registration i
- REW button 9, 10, 60, 61
- Rewind indicator 29

S

- Safety information i
- Safety precautions, battery 13
- Safety tab 22

Index

SEARCH buttons 10, 33
Search indicators 29
Self-timer 49
Self-timer indicator 31
Self-timer recording 48
Service port 11
Shoulder strap, attach 56
Shoulder strap attachment rings 10, 56
Shutter speed indicator 44
SLP tape speed 5, 22
Solving problems 73
SP tape speed 5, 22
SP/SLP button 10, 22, 24, 31, 33, 50, 52
Special effect indicators 28
Specifications 77
Speeds, recording and playback 22
Sports feature 44
Status displays 29
STEADY PIX button 11, 31, 41
Steady pix feature 41
Steady pix indicator 31
STOP button 9, 10, 59, 60, 61, 65
Stop-action pause 60

T

TALLY LAMP menu 33
Tally light 9, 11, 32, 33, 49, 54
Tally light feature 33, 54
Tape copying 65
TAPE END indicator 31
Tape, inserting 5
Tape length indicators 31
TAPE LENGTH menu 24, 25, 31

Tape length, set 24
Tape speed indicators 31
Tape wheel 5
Tape-length indicator 33
Tape-remaining display 33
TELE MACRO menu 35
Tele macro zooming 35
Things to avoid 79
Thumb trigger
 11, 21, 32, 33, 49, 51, 53, 65
Time counter 61
Time display 21
Time-counter display 31
Time-lapse indicator 31, 53
Time-lapse recording 52, 53
Time-remaining display 24, 25, 31
Tips
 recording 57
 travel 66
TITLE LANG. menu 46
TITLE menu 29, 47
Tracking 59
Tracking buttons 61
Tracking indicators 29, 61
Travel tips 66
Tripod mount hole 11
Tripod, using 69
Trouble checks 73
TWILIGHT indicator 29

U

Unpack camcorder and accessories 3

V

- Videocassettes 22
- Viewfinder 7, 10, 27, 59
 - adjust for viewing 27
 - displays 28, 29, 30, 31
 - displays (turning on and off) 33
 - eyepiece focus control 27
 - playback 58
 - use to record 7, 26
- Visual searching 60
- VOL control 59

W

- White balance feature 38
- White balance indicators 39
- Wipe/fade feature 42

Z

- Zoom buttons 37
- Zoom level indicator 29, 34
- Zoom lever 11, 29, 34
- Zooming 34
 - digital 34
 - tele macro 35

Information to User

This equipment has been tested and found to comply with the limits for a Class B digital device pursuant to Part 15 of the FCC Rules. These limits are designed to provide reasonable protection against harmful interference in a residential installation. This equipment generates, uses, and can radiate radio frequency energy and, if not installed and used in accordance with the instructions, may cause harmful interference to radio communications. However, there is no guarantee that interference will not occur in a particular installation. If this equipment does cause harmful interference to radio or television reception, which can be determined by turning the equipment off and on, the user is encouraged to try to correct the interference by one or more of the following measures:

- Reorient or relocate the receiving antenna.
- Increase the separation between the equipment and receiver.
- Connect the equipment into an outlet on a circuit different from that to which the receiver is connected.
- Consult the dealer or an experienced radio/TV technician for help.

Alterations or modifications carried out without appropriate authorization may invalidate the user's FCC right to operate the equipment.

This Class B digital apparatus meets all requirements of the Canadian Interference — Causing Equipment Regulations.

Cet appareil numérique de la classe B respecte toutes les exigences du Règlement sur le matériel brouilleur du Canada.

 **THOMSON CONSUMER ELECTRONICS**
10330 N Meridian Street
Indianapolis, IN 46290

©1999 Thomson Consumer Electronics, Inc.
Trademark(s)[®] Registered
Marca(s) Registrada(s)
Printed in Japan
TOCOM 15407870

Free Manuals Download Website

<http://myh66.com>

<http://usermanuals.us>

<http://www.somanuals.com>

<http://www.4manuals.cc>

<http://www.manual-lib.com>

<http://www.404manual.com>

<http://www.luxmanual.com>

<http://aubethermostatmanual.com>

Golf course search by state

<http://golfingnear.com>

Email search by domain

<http://emailbydomain.com>

Auto manuals search

<http://auto.somanuals.com>

TV manuals search

<http://tv.somanuals.com>