

CC638/639

USER'S GUIDE

TRUST



VHSC

C A M C O R D E R

Important Safety Information

Be sure to read all the safety information before you begin to use this product.

WARNING: To reduce the risk of fire or shock hazard, do not expose camcorder or AC adapter/charger to rain or moisture.

CAUTION

RISK OF ELECTRIC SHOCK
DO NOT OPEN



This symbol indicates “dangerous voltage” inside the product that presents a risk of electric shock or personal injury.

ATTENTION

RISQUE DE CHOC
ELECTRIQUE NE PAS OUVRIIR



This symbol indicates important instructions accompanying the product.

TO REDUCE THE RISK OF ELECTRIC SHOCK, DO NOT REMOVE THE COVER (OR BACK). NO USER-SERVICEABLE PARTS ARE INSIDE. REFER SERVICING TO QUALIFIED SERVICE PERSONNEL.

Cautions

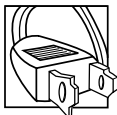

CAUTION: To prevent electric shock, match wide blade of plug to wide slot, fully insert.

ATTENTION: Pour éviter les chocs électriques, introduire la lame la plus large de la fiche dans la borne correspondante de la prise et pousser jusqu'au fond.

To reduce risk of injury, charge only rechargeable batteries recommended by the manufacturer for this camcorder. Other types of batteries may burst causing damage and personal injury.

FCC Regulations state that unauthorized changes or modifications to this equipment may void the user's authority to operate it.

Product Registration

Please fill out the product registration card and return it immediately. Returning this card allows us to contact you if needed.

Keep your sales receipt for proof of purchase to obtain warranty parts and service and attach it here. Record the serial and model numbers located on the bottom of the camcorder.

Model No: CC638/CC639

Serial No: _____

Purchase Date: _____

Purchased From: _____

Assistance

We want to make sure you enjoy your new camcorder. If you have any questions, call:

Camcorder Exchange Warranty.....800-283-6503 (pages 106-107)

Customer Service.....800-336-1900 (page 105)

Accessories.....800-338-0376 (pages 92-97)

Table of Contents

Safety Informationi

Product Registrationi

Table of Contents1-2

First-Time Operation

• Assistance3

• Unpack Camcorder &
Accessories3

• Attach the Adapter/Charger.....4

• Insert a Tape4

• Adjust Handstrap5

• Open Lens Cover5

• Turn on Camcorder.....5

• Select a Recording Speed6

• Set the Mode Select Dial7

• Adjust Viewfinder and
Eyepiece Focus Control.....7

• Start and Stop Recording.....8

• Play Back Your Recording8

• Turn off the Camcorder8

• Close Lens Cover8

• Review Camcorder's
Operating Controls9-11

Powering Your Camcorder

• Using Adapter/Charger.....12

• Using Rechargeable Battery.....13-15

• Using Optional Car Cord Adapter...16

Remote Controls

• Model CC639

• Install Battery Cell17

• Remote Sensor.....17

• Buttons18-19

• Model CC638

• Buttons20-21

• Install Battery Cell22

• Remote Sensor.....22

Recording Tips.....23

Video Cassettes.....24-25

Recording

• Making a Recording26-27

• LCD Panel28

• Viewfinder29

• Viewfinder Displays.....30-33

• Flying Erase Head34

• Auto Head Cleaner34

• Tally Light34

• Microphone.....34

• External Microphone Jack.....34

• Quick Review35

• Camera Edit.....35

Mode Select Dial

• Full *AUTO* Mode.....36

• Exposure Control.....37

• Focusing (Auto and Manual) ..38-39

(continued on next page)

Table of Contents

Recording (continued)

- Snapshot Feature40-41
- Electronic Image Stabilizer (EIS)....42
- Auto Pause Feature.....43
- Electronic Indexing43
- White Balance44-45
- Recording Menu
 - To Display Recording Menu.....46
 - Tape Remaining Display.....47
 - Set Tape Length47
 - Zooming.....48-49
 - Gain Up (Slow Shutter).....50
 - Color Filter51
 - Titler52-53
 - Date and Time Display
 - Set the Date and Time54
 - Install the Clock Lithium Cell ...55
 - Select Date or Date and Time You Want to Record56-57
 - Sub Menu
 - Change a Feature In the Sub Menu.....58
 - Tally Light59
 - Set *JLIP* Identification Number .59
 - Self Timer60-61
 - Animation Recording62-63
 - Time-Lapse Recording64-65
- Fading or Wiping In or Out.....66-67
- Production Effects68-69
- Audio Dubbing (Remote Only)..70-71
- Edit Insert (Remote Only).....72-73
- Built-in Color Enhancement Light74-75
- Attaching the Shoulder Strap.....76
- Traveling Tips77

Playback

- Using the Cassette Adapter78-79
- Viewfinder Playback80
- Playback Features
 - Visual Searching81
 - Tape Positioning81
 - Stop-Action Pause.....81
 - Time Counter82
 - Tracking83
- Playback on TV (or VCR) With *AUDIO/VIDEO IN* Jacks84-85
- Model CC639 Only
 - Programming Remote to Operate Compatible VCR86-87
 - Copying Tapes Using Programmable Synchro Edit88-89
- Playback on TV Without Audio/Video Inputs.....90-91

Optional Accessories.....92-97

- Accessory Order Form95-97

Trouble Checks98-101

Care and Maintenance102-103

Information to User.....104

Customer Assistance and Service .105

Limited Warranty106-107

Specifications108

Index (Alphabetical)109-113

First-Time Operation

This section describes only the basic steps necessary to set up your camcorder to record. Refer to the other sections for detailed operation and feature options.

Assistance

The toll-free numbers are available to help you with any problem you may encounter.

Camcorder Exchange Warranty800-283-6503
Customer Service800-336-1900
Accessories800-338-0376

1. Unpack the camcorder and accessories.

- Save the packing materials and box in case you ever need to ship or store your camcorder.
- The items shown below are packed with your camcorder. If any are missing or appear damaged, contact your dealer immediately.

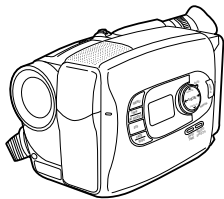

Model CC638 or CC639*

*Your camcorder may look slightly different from the one shown in this manual.

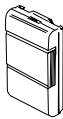

Rechargeable 6-Volt Battery
Part No. FB1260

WARNING:
NICKEL CADMIUM
BATTERY MUST BE
RECYCLED OR
DISPOSED OF
PROPERLY.

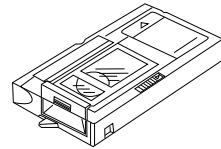

Cassette Adapter
Part No. 232845



AC Adapter/Charger
Part No. 221400
and DC Cable
Part No. 233087

Caution: Do not use this adapter/charger for any purpose other than charging the FB1260 or FB120 battery pack or supplying power to the camcorder.

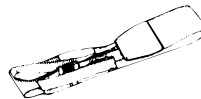

Shoulder Strap
Part No. ACS091

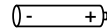

Cassette Adapter Battery
(Size "AA" 1.5 Volt)



Model CC639 Only:
Edit Cable
Part No. 233088

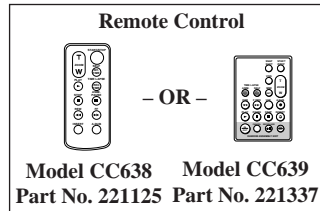

Clock and Remote Cells
3-Volt Micro Lithium Cells
– such as CR2025 – available from most local drug stores and camera shops. Use of other cells present a risk of fire or explosion.

Cautions: Lithium cell batteries. Must be disposed of properly. Never handle punctured or leaking cells. May cause burns or personal injury. Keep out of the hands of children. Can cause death or injury if swallowed. If swallowed, consult a physician immediately for emergency treatment. The lithium cells used in these devices may explode resulting in a fire or chemical burn if mistreated. Do not recharge, disassemble, heat above 212°F (100°C), or incinerate. Never use metallic tweezers to hold the cell, and never short circuit the + and – sides of the cell.

First-Time Operation

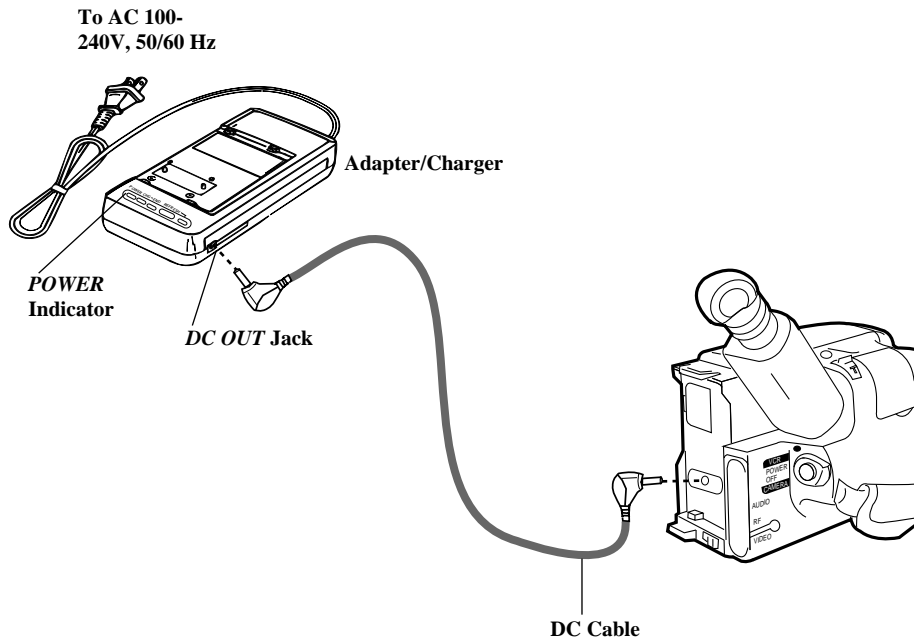

2. Attach the adapter/charger.

Since the battery must be charged before it can be used the first time, attach the adapter/charger to the camcorder.

- A. Connect one end of the DC cable to the *DC OUT* jack on the adapter/charger.
- B. Connect the other end of the DC cable to the DC in jack on the camcorder *as shown above*.
- C. Plug the adapter/charger's plug into an operating outlet. The adapter/charger's *POWER* indicator will light

3. Insert a tape.

- Slide *EJECT*.
- Turn the tape wheel on the cassette to remove any slack from the tape.
- Insert the cassette with the tape wheel facing up and the tape window facing out.
- Press on the area labeled *PUSH* until the cassette door locks into place.

First-Time Operation

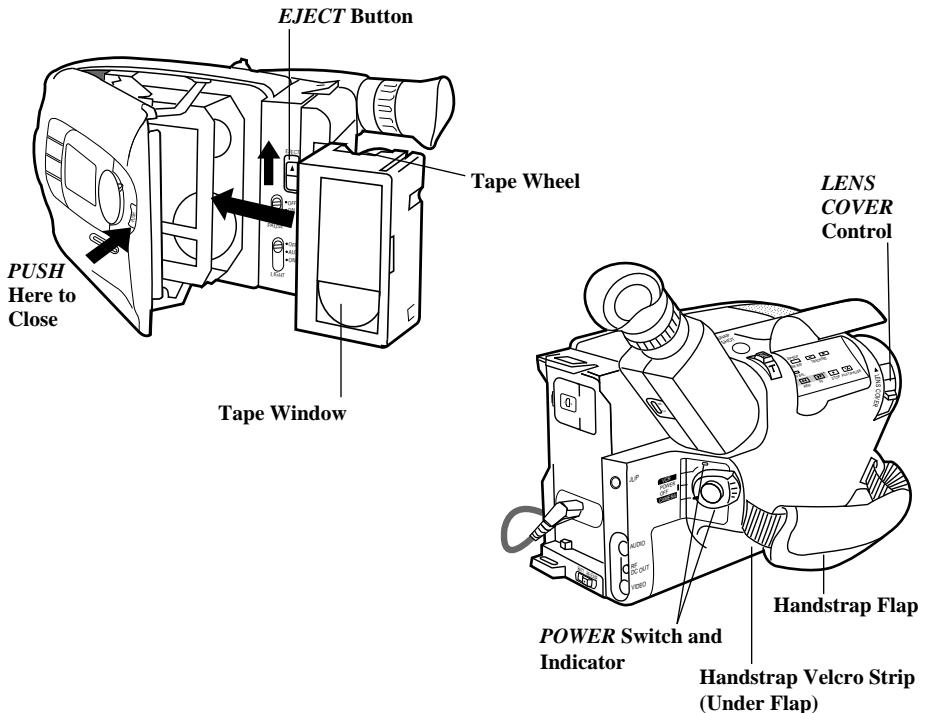

4. Adjust the handstrap to fit your hand.

- Lift the flap on the handstrap and separate the velcro strip.
- Insert your hand, adjust the strap to fit snugly, refasten the strap, and close the flap.

5. Slide **LENS COVER** control to open lens cover.

6. Place **POWER (CAMERA/OFF/VCR)** switch in **CAMERA**.

- The power indicator will light and the camcorder will enter record pause. \equiv PAUSE \equiv appears in the viewfinder when the camcorder is in record pause.
- The position of this switch tells the camcorder whether you want to record (**CAMERA**), turn the power off (**OFF**), or play back tapes (**VCR**).
- The camcorder will automatically turn off if it remains in record pause for five minutes without performing zoom or other operations. Place **POWER** in **OFF** and then back in **CAMERA**.

(continued on next page)

First-Time Operation

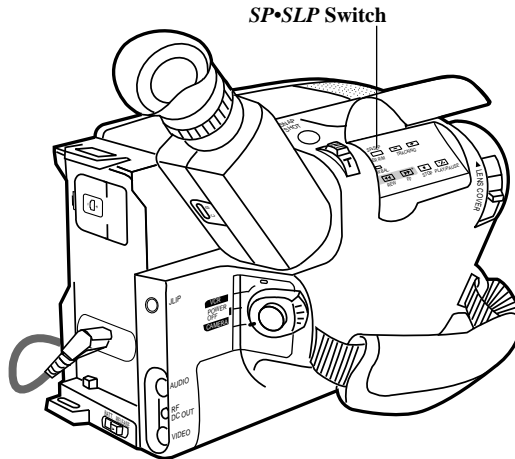

7. Select a recording speed.

Repeatedly press the *SP•SLP* switch to select a recording speed. The indicator for the speed selected appears in the viewfinder and LCD panel.

Select SP or SLP recording speed.

- SP – Standard play provides the best picture, but the shortest recording time (20 minutes with a TC-20 tape).
- SLP – Extended play provides three times the recording time as SP (60 minutes with a TC-20 tape). SLP has slightly more picture noise in normal playback.

Note: The length of the tape you are using must be selected in the recording menu for the camcorder to correctly calculate the recording time remaining on the tape. *Details are on page 47.*

First-Time Operation

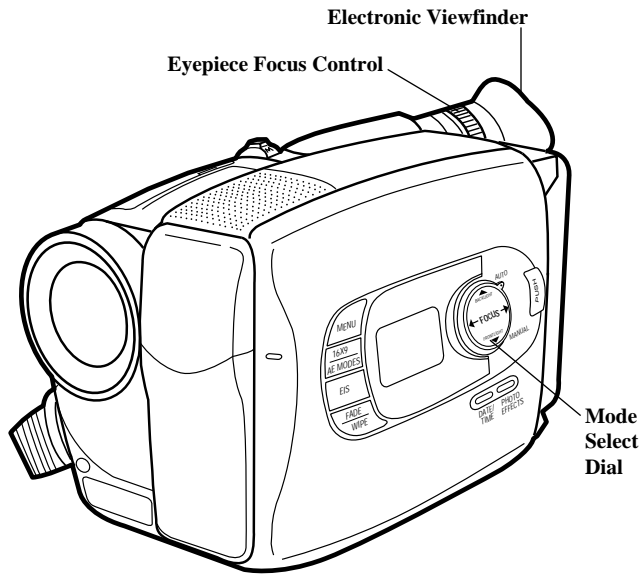

8. Set the mode select dial to *AUTO*.

- This places the camcorder in the full *AUTO* mode.
- In the *AUTO* mode, the focus, exposure, and white balance are automatically controlled by the camcorder.
- Many of the special effects do not operate in the *AUTO* mode. *Details on page 36.*

9. Adjust the viewfinder and eyepiece focus control.

- Pull out and rotate the viewfinder into a comfortable operating position.
- Turn the eyepiece focus control to adjust the focus of the viewfinder for your vision.

(continued on next page)

First-Time Operation

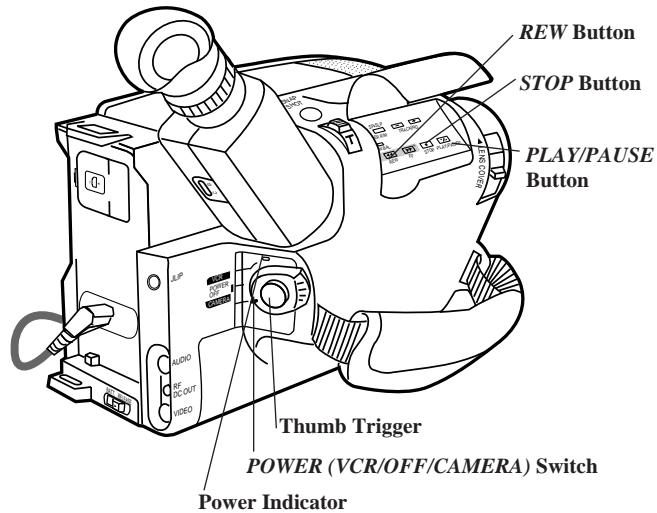

10. Start and stop recording.

- Press and release the thumb trigger to start recording. **REC ►►►** appears in the viewfinder, and the tally light will light when the camcorder is recording.
- Press and release the thumb trigger again to stop recording. The camcorder is now in the record-pause mode (≡ PAUSE ≡ appears in the viewfinder).

11. Play back what you have recorded.

- Place the **POWER** switch in **VCR**.
- Press **REW** to rewind the tape.
- Press **PLAY/PAUSE** to play back the tape in the viewfinder.
- Press **STOP** when you are finished playing back the tape.
- *Details on viewfinder playback are on page 80.*

12. Place the **POWER** switch in **OFF** to turn off the camcorder.

The power indicator will turn off.

13. Close the lens cover.

First-Time Operation

14. Review camcorder's operating controls.

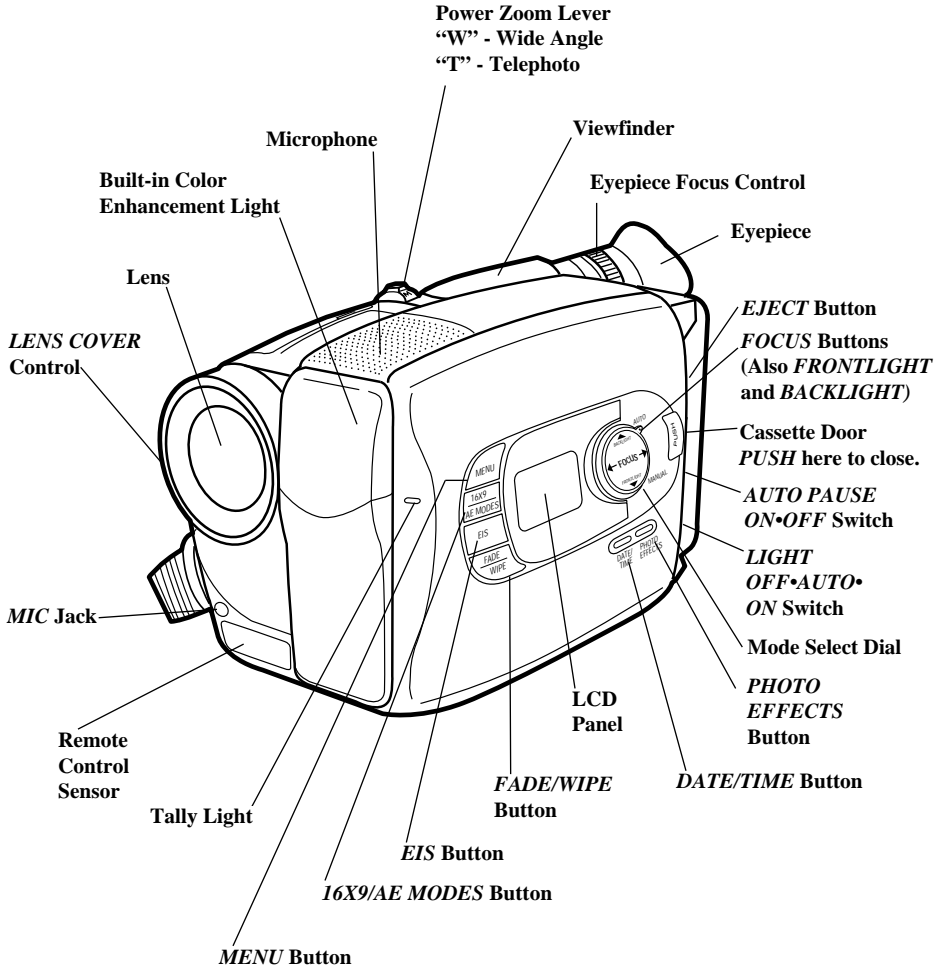

(continued on next page)

First-Time Operation

14. Review camcorder's operating controls. (continued)

Model CC639 Only:
B (Bright) and C (Color) Controls
on Bottom of Viewfinder
See Trouble Checks for details.

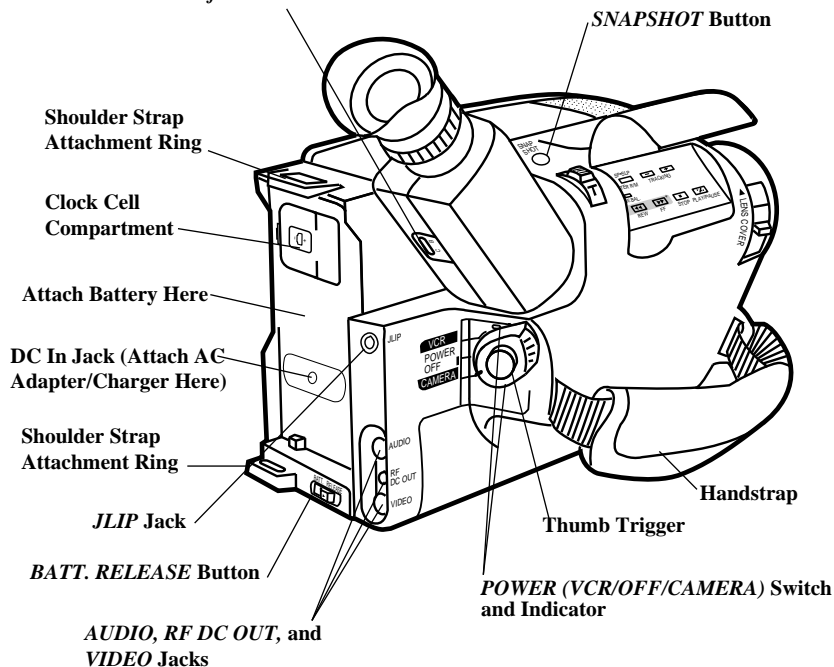

First-Time Operation

14. Review camcorder's operating controls.

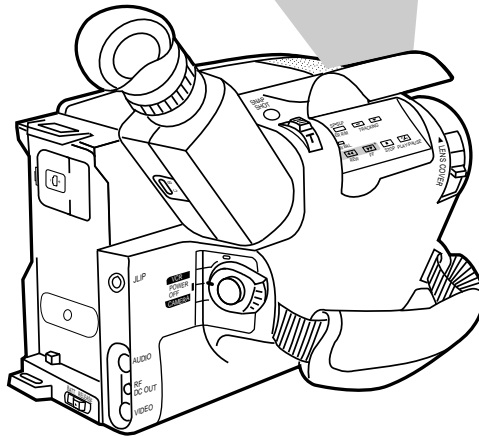
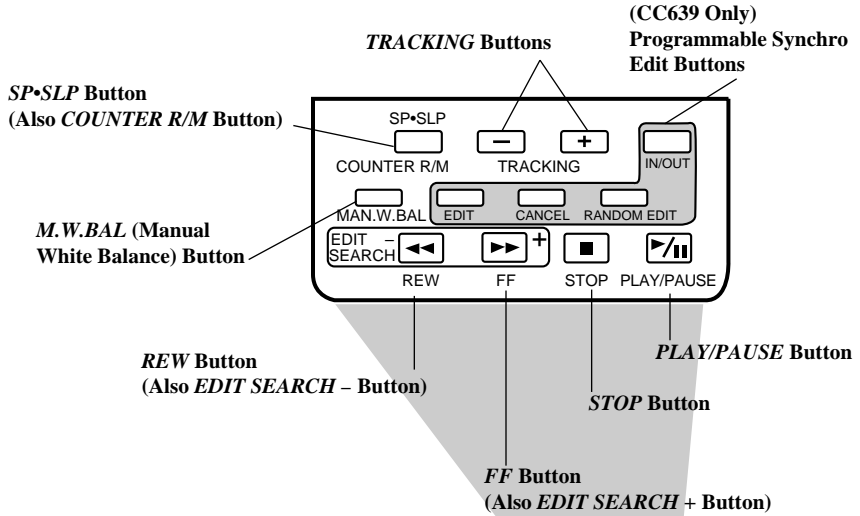

Powering Your Camcorder

Using the Adapter/Charger to Power Your Camcorder

The adapter/charger attaches to the camcorder and lets you power your camcorder directly from standard household power. The adapter/charger operates on 100-240 volts, 50/60 Hz, so it can be used virtually anywhere in the world to power the camcorder or recharge the battery.

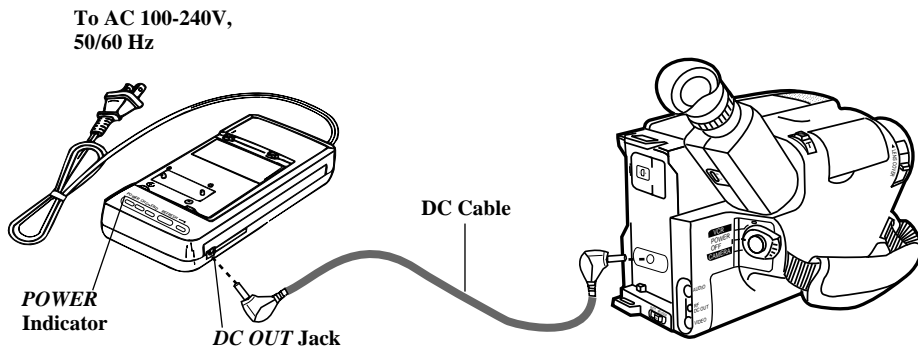

Attach Adapter/Charger

1. Connect one end of the DC cable to the *DC OUT* jack on the adapter/charger.
2. Connect the other end of the DC cable to the DC in jack on the camcorder as shown above.
3. Plug the adapter/charger's plug into the nearest AC outlet (100-240V, 50/60Hz).
4. If the adapter/charger is properly connected, its *POWER* indicator will light.

Caution: Do not use this adapter/charger for any other purpose other than charging the FB1260 or FB120 battery pack or supplying power to the camcorder.

Remove Adapter/Charger

1. Unplug the adapter/charger from the wall outlet.
2. Remove the DC cable from the adapter/charger and camcorder.

Using an Optional Plug Adapter

An optional plug adapter may be required in some countries.

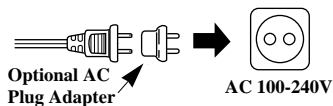

1. Plug the adapter/charger's plug into the AC plug adapter.
2. Plug the AC plug adapter into the AC outlet.

Powering Your Camcorder

Using the Battery to Power Your Camcorder

The battery must be charged *as described on the next page* before it can be used the first time. Initial charging will take approximately 70 minutes. When fully charged, the battery should supply about 55 minutes of operating time (depending on how much you use the light, zoom, and pause). Conserve battery power by turning the camcorder off during recording breaks.

Note: The small marker switch on top of the battery is for use as a personal reminder to help you remember to recharge the battery. It has no other function.

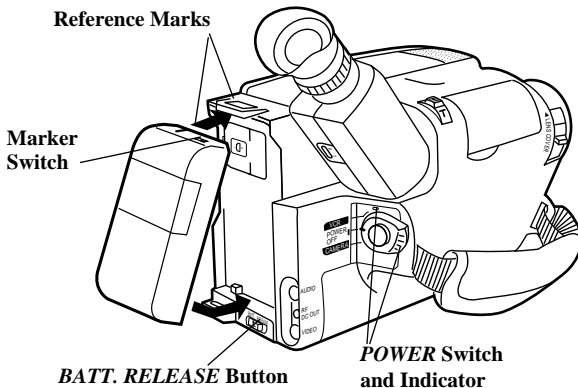

Battery Safety Precautions

Do not short the battery's terminals.

Do not attempt to disassemble or modify the battery. There are no user-serviceable parts inside.

Use the battery only with specified adapter/chargers and camcorders.

Throwing the battery into a fire or exposing it to excessive heat – over 149°F (65°C) could be hazardous.

Attach the Charged Battery

If the DC cable is attached to the camcorder, remove it before attaching the battery. Also, install the lithium clock cell before attaching the battery pack.

Details on page 55.

1. Align the reference mark on the battery with mark on back of camcorder.
2. Hold the top of the battery flush against the camcorder and press the bottom of

the battery down until it locks into place.

3. Place the *POWER* switch in *CAMERA*. The power indicator will light.

Remove the Battery

Press and hold *BATT. RELEASE* on the camcorder while removing the battery.

ATTENTION: The RBRC seal on the battery used in your Thomson Consumer Electronics product indicates that we are participating in a program to collect and recycle Nickel Cadmium batteries throughout the United States. Please call 1-800-8-BATTERY for information or contact your local recycling center.



Powering Your Camcorder

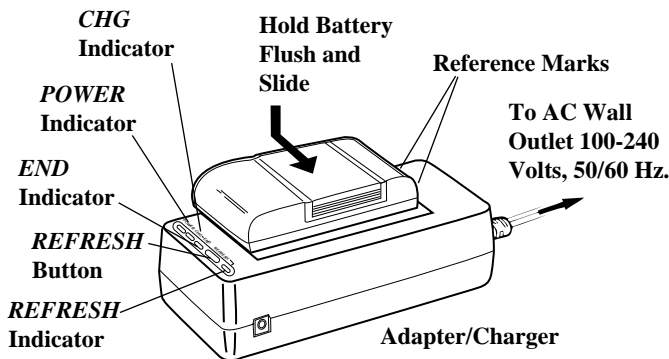

Caution: When a battery is attached to the adapter/charger, do not turn them upside down. The battery may fall off and be damaged or cause injury.

Charge the Battery

If the DC cable is attached to the *DC OUT* jack on the adapter/charger, remove it up.

1. Align reference mark on battery with mark on adapter/charger.
2. Hold the battery flush against the adapter/charger and slide it in the direction of the arrow.
3. Plug adapter/charger into nearest AC outlet (100-240V, 50/60Hz).
4. If the battery is properly connected, the adapter/charger's *CHG* (charge) indicator will light.
Note: If you try to charge a battery that has not been charged for a long period of time, it may take a few minutes for the *CHG* indicator to light.
5. After the battery is charged, the *END* indicator will light.
6. Remove the charged battery by sliding it off the adapter/charger.
7. Attach the charged battery to the camcorder.

Use the *REFRESH* Button

The battery will provide increased operation time if you "refresh" it after five chargings. The refresh feature "refreshes" the battery by completely discharging it.

1. Attach battery to adapter/charger.
2. Press *REFRESH*. The *REFRESH* indicator will light and the battery will begin discharging.
3. When discharging is completed, the *REFRESH* indicator will turn off, and the *CHG* indicator will light. The battery will then charge.
4. After the battery is charged, the *END* indicator will light. Remove the battery from the adapter/charger.



Powering Your Camcorder

Battery Level Indicator

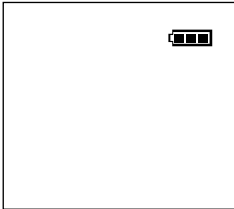
The battery level indicator appears in the viewfinder and display panel and shows you the amount of power in the rechargeable battery.



Battery Level Indicator
in Viewfinder

- As the power is used  and  appear.
- When the battery power is almost gone,  flashes in the viewfinder. The camcorder will turn off automatically after a few seconds. Place the *POWER* switch in *OFF* to turn off the camcorder before replacing the battery.

The battery level indicator will not be recorded on the tape when it appears in the viewfinder.

Battery Care and Storage

- Recharging takes approximately 70 minutes depending on the battery's condition.
- Refreshing takes approximately 210 minutes depending on the battery's condition.
- After repeated charging and use, operation time will gradually decrease. When operation time becomes too short to be useful, it is time to replace the battery.
- If the battery discharging must be stopped in the middle, remove the battery from the adapter/charger before unplugging it from the AC outlet.
- Let a hot battery cool down before attaching it to the adapter/charger.
- The battery will also provide better service if its power is completely drained before storing it for long periods of time (30 days or more).
- The battery should be charged in the temperature range of 50-95°F (10-35°C) to prevent damage.
- Do not operate the battery at temperatures below 32°F (0°C) or above 104°F (40°C). The battery may be damaged if operated at temperatures above 122°F (50°C). Operation time will decrease at extremely low temperatures.
- Store the battery at normal room temperature.

Powering Your Camcorder

Optional Car Cord Adapter

The optional DCC08 car cord *shown on page 92* allows you to power your camcorder from the cigarette lighter socket of a car, truck, or RV. It converts 12-volts to a 6-volt output.

Note: Consult the installation and operating instructions enclosed with the DCC08 for complete operating instructions.

Cautions: The DCC08 is designed to be used only with vehicles having negative ground electrical systems.

Use only car cord adapter DCC08 with this camcorder. Use of any other car cord adapter may damage the camcorder and void your warranty.

Using the DCC08 Car Cord Adapter

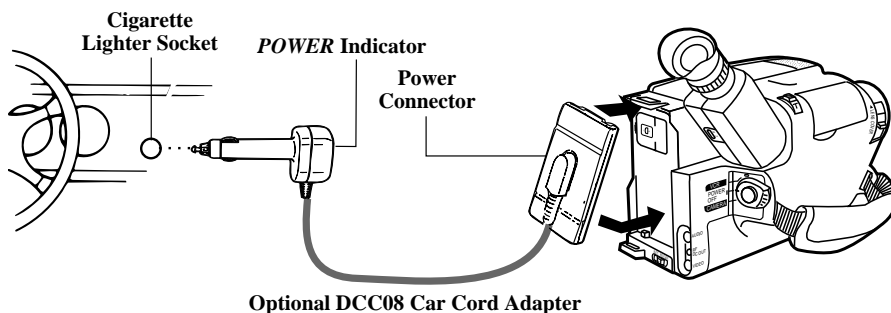

1. Place the *POWER* switch in *OFF* to turn off the camcorder. Power indicator on the camcorder turns off.
2. If the battery or DC cable is attached to the camcorder, remove it.
3. Hold the top of the power connector flush against the camcorder and press the bottom of the power connector down until it locks into place.
4. Take the vehicle's cigarette lighter out of the socket.
5. Insert the car cord's cigarette lighter plug into the vehicle's cigarette lighter socket. The *POWER* indicator on the car cord adapter will light.
6. Place the *POWER* switch in *CAMERA* to turn on the camcorder. The power indicator on the camcorder lights.

Caution: Make sure the camcorder's power is turned off before removing the car cord's plug from the cigarette lighter socket.

Model CC639 Only: Remote Control

Model CC639 Only: Lithium Cell Installation

The remote's lithium cell is packed separately. Install it as follows:

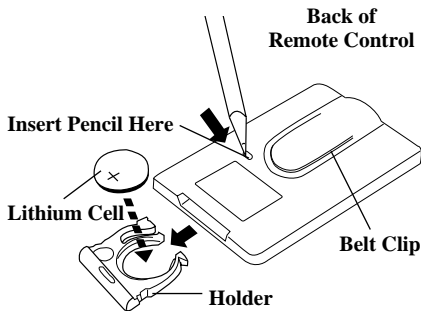

Cautions: Lithium cell battery. Replace only with 3-volt lithium cell – such as CR2025. Use of other cell presents a risk of fire or explosion. Must be disposed of properly. Never handle punctured or leaking cell. May cause burns or personal injury.

Keep out of the hands of children. Can cause death or injury if swallowed. If swallowed, consult a physician immediately for emergency treatment.

The lithium cell used in this device may explode resulting in a fire or chemical burn if mistreated. Do not recharge, disassemble, heat above 212°F (100°C), or incinerate.

Never use metallic tweezers to hold the cell, and never short circuit the + and – sides of the cell.

1. Turn remote over, insert a pencil or paper clip in the small hole, and slide it in the direction of the arrow while removing the holder.
2. Insert the lithium cell into the holder with its positive (+) terminal facing up.
3. Slide the cell in the holder back into the remote until it clicks into place.

Notes: Never place anything heavy on top of the remote or lay it upside-down. This may accidentally depress the buttons for a long time and discharge the lithium cell.

Replace the cell when the camcorder fails to respond to the remote.

Remove the cell from the remote if it will not be used for a month or more. This will prevent possible damage from cell leakage. If leakage occurs, wipe up the liquid inside the compartment and replace the cell.

Remote Sensor

The remote operates the camcorder by infrared light, so it is protected from electrical and sound interference. However, the remote must be aimed directly at the camcorder's remote sensor. There cannot be any obstructions between them.

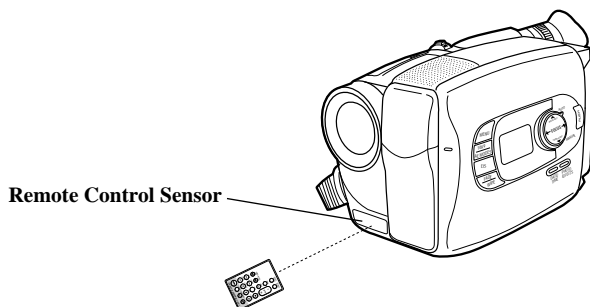

Notes: The camcorder may not respond to the remote if its sensor is exposed to direct sunlight or strong artificial light.

You can program the remote to also operate a compatible VCR while copying or editing tapes. *Details are on pages 86-87.*

Model CC639 Only: Remote Control

A brief description of Model CC639 remote button's functions is given here. Many of the buttons perform the same functions as the corresponding controls on the camcorder.

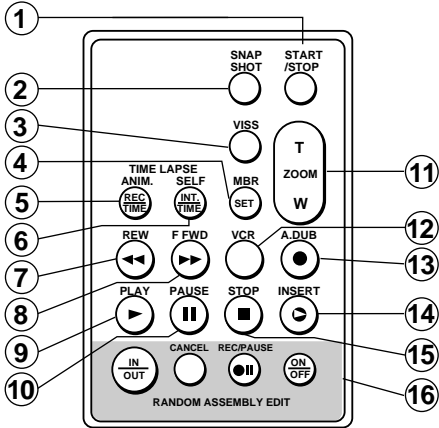

1 **START/STOP Button**

When the *POWER* switch is in *CAMERA*, press *START/STOP* to start and stop recording.

Note: If the camcorder is left in record pause for more than five minutes, power will turn off.

2 **SNAPSHOT Button**

When the *POWER* switch is in *CAMERA*, press *SNAPSHOT* to record using the snapshot mode selected with the *PHOTO EFFECTS* button. See pages 40-41.

3 **VISS Button**

When the *POWER* switch is in *CAMERA*, press *VISS* to insert an index mark. See page 43.

4 **MBR SET Button**

This button is used to program the remote to control a compatible VCR. See pages 86-87.

5 **TIME LAPSE ANIM. (Animation)/REC TIME Button**

When the *POWER* switch is in *CAMERA*, press to set amount of recording time for interval and animation recording.

6 **TIME LAPSE SELF/INT. (Interval) TIME Button**

When the *POWER* switch is in *CAMERA*, press to activate the self-timer or select an amount of interval time for interval recording.

7 **REW (Rewind) Button**

Camcorder's *POWER* switch in *CAMERA*:

- When the camcorder is in record pause, press and hold *REW* to visually search the tape in reverse. Release *REW* to return to record pause.

Camcorder's *POWER* switch in *VCR*:

- When the camcorder is stopped, press *REW* to rewind the tape.
- When a tape is playing, press and release *REW* to visually search the tape in reverse. Press *PLAY* to return to normal playback. For brief searching, press and hold *REW* for at least two seconds to visually search in reverse. Release *REW* to return to normal playback.

Model CC639 Only: Remote Control

8 **F FWD (Fast Forward) Button**

Camcorder's *POWER* switch in *CAMERA*:

- With camcorder in record pause, press and hold *F FWD* to visually search forward on the tape. Release *F FWD* to return to record pause.

Camcorder's *POWER* switch in *VCR*:

- When the camcorder is stopped, press *F FWD* to fast forward the tape.
- When a tape is playing, press and release *F FWD* to visually search forward on the tape. Press *PLAY* to return to normal playback. For brief searching, press and hold *F FWD* for at least two seconds to visually search forward. Release *F FWD* to return to normal playback.

9 **PLAY Button**

Press *PLAY* when the Camcorder's *POWER* switch is in *VCR* to begin playback.

10 **PAUSE Button**

During playback, press *PAUSE* to produce a stop-action picture. Press *PAUSE* or *PLAY* to return to normal playback.

Caution: Pause is designed for momentary interruptions and should not be used for an extended period of time. If the camcorder remains in pause for more than five minutes, it will automatically enter the stop mode and then turn off.

11 **ZOOM (T and W) Buttons**

Camcorder's *POWER* switch in *CAMERA*:

- Press *T* to move the lens in the telephoto (close-up) direction.
- Press *W* to move the lens in the wide-angle direction.

12 **VCR Button**

This button is used to control a compatible VCR. See pages 86-87.

13 **A. (Audio) DUB Button**

Used for dubbing audio. See pages 70-71.

14 **INSERT Button**

Used for dubbing video. See pages 72-73.

15 **STOP Button**

When the camcorder's *POWER* switch is in *VCR*, press *STOP* to stop playback, rewind, or fast-forward operation.

16 **RANDOM ASSEMBLY EDIT Buttons (IN/OUT, CANCEL, REC/PAUSE, and ON/OFF)**

These buttons are used during editing with a compatible VCR. See pages 86-89.

Model CC638 Only: Remote Control

Model CC638 Only: A brief description of Model CC638 remote button's functions is given here. Many of the buttons perform the same functions as the corresponding controls on the camcorder. The lithium cell must be installed *as shown* on page 22.

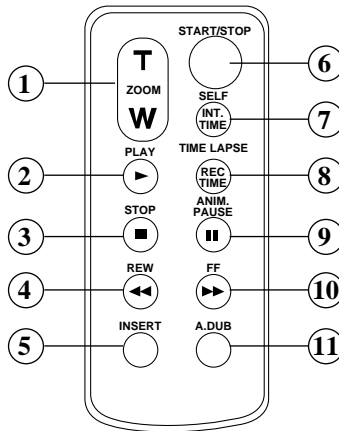

1 ZOOM (T and W) Buttons

Camcorder's *POWER* switch in *CAMERA*:

- Press *T* to move the lens in the telephoto (close-up) direction.
- Press *W* to move the lens in the wide-angle direction.

2 PLAY Button

Press *PLAY* when the camcorder's *POWER* switch is in *VCR* to begin playback.

3 STOP Button

When the camcorder's *POWER* switch is in *VCR*, press *STOP* to stop playback, rewind, or fast-forward operation

4 REW (Rewind) Button

Camcorder's *POWER* switch in *CAMERA*:

- When the camcorder is in record pause, press and hold *REW* to visually search the tape in reverse. Release *REW* to return to record-pause.

Camcorder's *POWER* switch in *VCR*:

- When the camcorder is stopped, press *REW* to rewind the tape. Press *STOP* to stop rewinding tape.
- When a tape is playing, press and release *REW* to visually search the tape in reverse. Press *PLAY* to return to normal playback. For brief searching, press and hold *REW* for at least two seconds to visually search in reverse. Release *REW* to return to normal playback.

Model CC638 Only: Remote Control

5 **INSERT Button**

Used for dubbing video. See pages 72-73.

6 **START/STOP Button**

When the *POWER* switch is in *CAMERA*, press *START/STOP* to start and stop recording.

Note: If the camcorder is left in record pause for more than five minutes, power will turn off.

7 **TIME LAPSE SELF/INT. (Interval) TIME Button**

When the *POWER* switch is in *CAMERA*, press to activate the self-timer or select an amount of interval time for interval recording.

8 **TIME LAPSE ANIM. (Animation)/REC TIME Button**

When the *POWER* switch is in *CAMERA*, press to set amount of recording time for interval and animation recording.

9 **PAUSE Button**

During playback, press *PAUSE* to produce a stop-action picture. Press *PLAY* or *PAUSE* to return to normal playback.

Caution: Pause is designed for momentary interruptions and should not be used for an extended period of time. If the camcorder remains in pause for more than five minutes, it will automatically enter the stop mode and then turn off.

10 **FF (Fast Forward) Button**

Camcorder's *POWER* switch in *CAMERA*:

- With camcorder in record pause, press and hold *FF* to visually search forward on the tape. Release *FF* to return to record pause.

Camcorder's *POWER* switch in *VCR*:

- When the camcorder is stopped, press *FF* to fast forward the tape. Press *STOP* to stop forwarding the tape.
- When a tape is playing, press and release *FF* to visually search forward on the tape. Press *PLAY* to return to normal playback. For brief searching, press and hold *FF* for at least two seconds to visually search forward. Release *FF* to return to normal playback.

11 **A. (Audio) DUB Button**

Used for dubbing audio. See pages 70-71.

Model CC638 Only: Remote Control

Model CC638 Only: Install Lithium Cell

The remote's lithium cell is packed separately. Install it as follows:

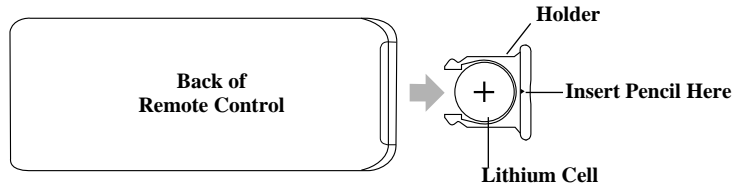

Cautions: Lithium cell battery. Replace only with 3-volt lithium cell – such as CR2025. Use of other cell presents a risk of fire or explosion. Must be disposed of properly. Never handle punctured or leaking cell. May cause burns or personal injury.

Keep out of the hands of children. Can cause death or injury if swallowed. If swallowed, consult a physician immediately for emergency treatment.

The lithium cell used in this device may explode resulting in a fire or chemical burn if mistreated. Do not recharge, disassemble, heat above 212°F (100°C), or incinerate.

Never use metallic tweezers to hold the cell, and never short circuit the + and – sides of the cell.

1. Turn remote over, insert a pencil or paper clip in small hole and remove battery holder.
2. Insert battery in battery holder so positive (+) terminal faces up.
3. Replace battery holder in remote until it clicks into place.

Notes: Never place anything heavy on top of the remote control or lay it upside-down.

Replace battery when camcorder fails to respond to remote.

Remove battery from remote if it will not be used for a month or more. This will prevent possible damage from battery leakage. If leakage occurs, wipe up liquid inside compartment and replace battery.

Remote Sensor

The remote operates the camcorder by infrared light, so it is protected from electrical and sound interference. However, the remote must be aimed directly at the camcorder's remote sensor. There cannot be any obstructions between them.

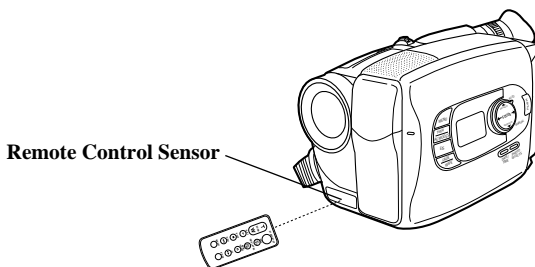

Note: The camcorder may not respond to the remote if its sensor is exposed to direct sunlight or strong artificial light.

Recording

Recording Tips

- In case of fire or theft, make a video recording of your home and contents to store in a safe place.
- Try to make sure indoor scenes are well-lit. Use the built-in light. This improves picture quality and color reproduction.
- Do not move the camcorder rapidly from side-to-side while recording. A steady, gradual “pan” avoids blurring and “jitter”.
- Use the viewfinder to make sure the camcorder is level while recording or your scenes will appear “tilted”.
- Do not bump or tap the camcorder’s microphone while recording because this sound will be recorded.
- Include close-ups and snapshots of individuals when taping family outings or group functions.
- Fading or wiping in and out of scenes will make your videos appear more professional.
- Learn to use the special production effects available with your camcorder to add variety to your recordings.
- Be aware of video and audio backgrounds. Background details barely noticed while you are taping may show up as visual “clutter” on your recording. Background noises (especially TV sets, radios, household appliances, traffic sounds, etc.) can detract from the sound you want to record.
- Avoid long “still” shots of landmarks and scenic attractions. Recordings are more interesting if they include people and details. “Local color” will give travel videos lasting appeal. Consider recording a familiar or landmark scene from an unfamiliar vantage point.

Video Cassettes

We recommend that our cassettes be used with your camcorder. Use of poor quality tapes or tapes that have been damaged or mishandled can contaminate the video heads, resulting in a snowy picture or no picture at all during playback. Because there is no control over the type of tape purchased or rented by consumers, head cleaning is not covered under warranty. It is considered normal maintenance.

The automatic head-cleaning system minimizes the need for accessory cleaners or cleaning by a Servicer. This system is activated whenever you insert or remove a cassette.

Erase Protection – Safety Tab

You can use your video cassettes over and over again. To erase a previous recording, just record over it.

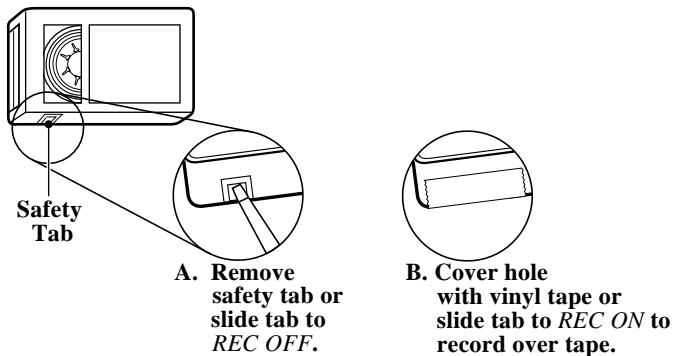

Recording and Playback Speeds and Times

The camcorder records and plays back in standard speed (SP) or extended play (SLP). Select the recording speed using the *SP•SLP* switch. The selected speed will be displayed in the viewfinder and display panel. Listed below are the maximum SP and SLP recording times for popular VHS-C cassettes.

- SP – Standard play provides the best picture (less picture noise), but the shortest recording time (20 minutes with a TC-20 tape).
- SLP – Extended play provides three times the recording time as SP (60 minutes with a TC-20 tape). SLP has slightly more picture noise than SP in normal playback. This may not be noticeable.

Cassette	Recording Time	
	SP	SLP
TC-20	20 Min.	60 Min.
TC-30	30 Min.	90 Min.
TC-40	40 Min.	120 Min.

Video Cassettes

Inserting and Removing Cassettes

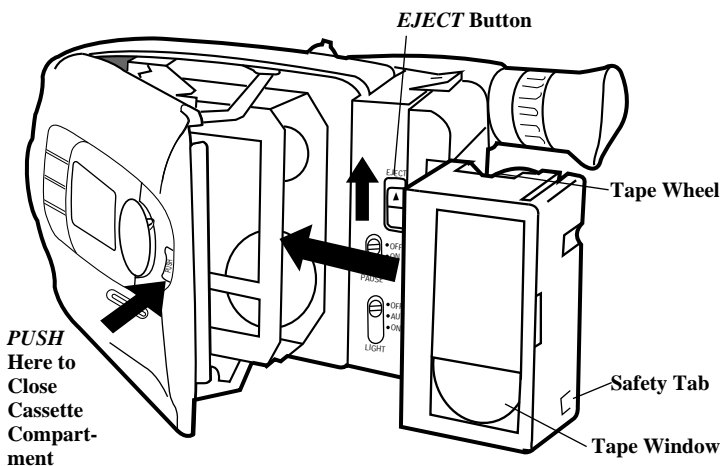

Caution:

Insert the cassette only one way with the tape wheel facing up and the tape window facing out. The cassette should slide easily into the compartment. Do not force the cassette.

Before inserting a cassette, turn the tape wheel on the side of the cassette in the direction shown to remove any slack in the tape.

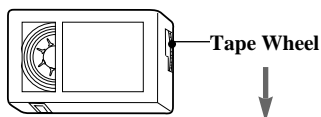

1. Attach a power supply. Then slide and release *EJECT* to open the cassette compartment.
2. Insert or remove the cassette.
3. Close the cassette compartment door by pressing on the area labeled *PUSH* until it locks into place.

Cassette Care and Storage

- When you are finished with a cassette, rewind it, remove it from the camcorder, and label it.
- Store cassettes vertically in their protective cases at normal room temperatures. Do not leave your camcorder or cassettes in a car or outdoors for an extended period. Excessive heat or cold may damage your cassettes.
- Keep the cassette away from strong magnetic fields such as electric motors and other devices.
- Keep dust from entering the cassette compartment. All dust is abrasive and will cause excessive wear on the tape and the camcorder's recording or playback heads.
- Do not use cassettes with damaged or spliced tape.
- Do not use a cassette if it has been damaged or exposed to moisture. The tape may jam and/or damage your camcorder.

Recording

Making a Recording

The steps below tell you how to make a recording and suggest using some of the recording features. Each feature is described in detail on the following pages.

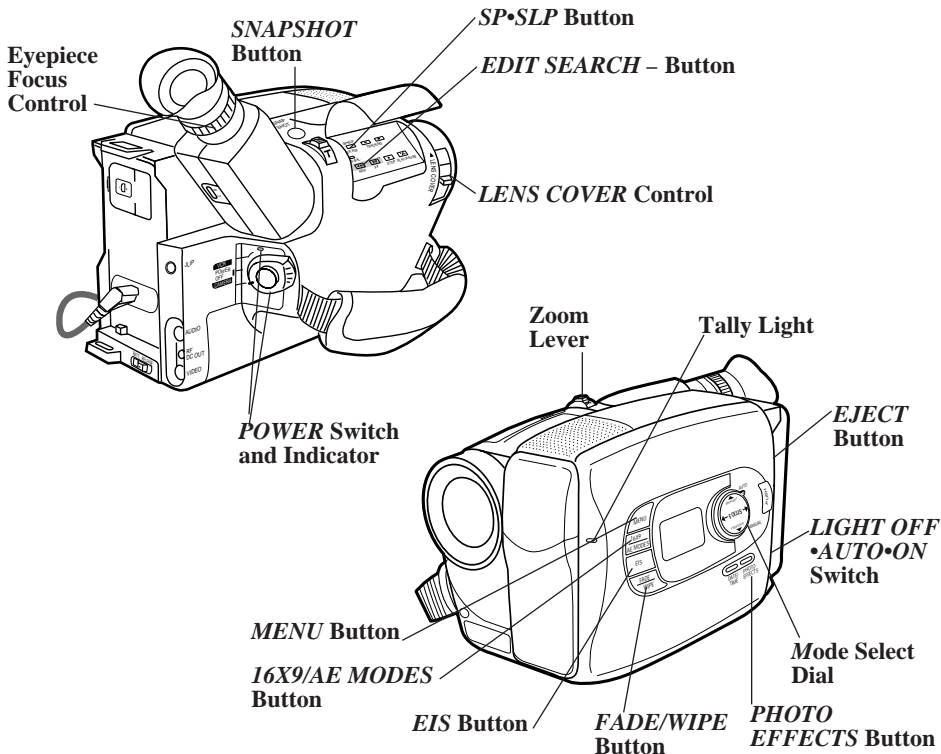

1. Attach a power supply.

Attach the adapter/charger, charged battery, or optional DC car cord.

2. Insert a tape.

- Slide *EJECT*.
- Turn the tape wheel on the cassette to remove any slack from the tape.
- Insert the cassette with the tape wheel facing up and the tape window facing out.

3. Slide the *LENS COVER* control to open the lens cover.

4. Place the *POWER (CAMERA/OFF/VCR)* switch in *CAMERA*.

The power indicator will light and the camcorder will enter record pause.
≡ PAUSE ≡ appears in the viewfinder.

5. Adjust the viewfinder and eyepiece focus control for your vision.

6. Select a recording speed and tape length.

- A. Place the *SP•SLP* switch in *SP* or *SLP* to select a recording speed.
- B. Make sure the mode select dial is in *MANUAL*.

Recording

- C. Press the *MENU* button and use the ▼ in the center of the mode select dial to highlight *TAPE LENGTH*. Use ◀ and ▶ to select the length of the tape you are using (*T20*, *T30*, or *T40*) so the camcorder can correctly calculate the time remaining. Press the *MENU* button again to remove the menu.

7. Place the *LIGHT OFF•AUTO•ON* switch in *AUTO*.

The light will turn on automatically when you need more light.

8. Select a production special effect to add variety to your recordings.

- A. Make sure the mode select dial is in *MANUAL*.
- B. Press the *16X9/AE MODES* button to display the production effects menu in the viewfinder.
- C. Repeatedly press the *16X9/AE MODES* button to select one of the production effects.
- Select *Cinema* (16X9 effect), *Sepia* (brown-tone effect), *Sports* (fast moving action), *Back Lit* (subject in strong back light), *Front Lit* (subject in spotlight), *Classic Film* (flickering old-time movie), *Strobe*, or *Slow Shutter* (dark locations).
 - The effect is automatically activated, and its indicator appears in the viewfinder.
 - *Details are on pages 68-69.*

9. Add fades and wipes.

- A. Make sure the mode select dial is in *MANUAL*.
- B. Press the *FADE/WIPE* button to display the fade menu in the viewfinder.

- C. Repeatedly press the *FADE/WIPE* button to select a fade or wipe.

- Select *Black Fader*, *Blue Fader*, *Mosaic Fader*, *Door Wipe*, *Scroll Wipe*, *Window Wipe*, *Dissolve*, or *Auto Select*.
- The effect is automatically activated, and its indicator appears in the viewfinder.
- *Details are on pages 66-67.*

10. Start and stop recording.

- Press and release the thumb trigger to start recording. *REC ▶▶▶* appears in the viewfinder and the tally light will light when the camcorder is recording.
- Press and release the the thumb trigger again to stop recording. The camcorder is now in record pause. *≡ PAUSE ≡* appears in the viewfinder.
- The camcorder will automatically turn off if it remains in record pause for five minutes. Place the *POWER* switch in *OFF* and then back in *CAMERA*.

11. Use the zoom and *SNAPSHOT* features.

- Zoom in and out using the zoom *T* and *W* lever.
- Press the *PHOTO EFFECTS* button to select a type of snapshot effect (pin-up, frame, full, multi-4, or multi-9). Press *SNAPSHOT* to add snapshots to your recording.

12. Review what you have recorded.

- Press and quickly release *EDIT SEARCH* – to review the last few seconds of your recording.

13. When you are finished, place *POWER* switch in *OFF* and close the lens cover.

Recording

LCD Panel

The LCD panel on the side of the camcorder displays what the camcorder is doing.

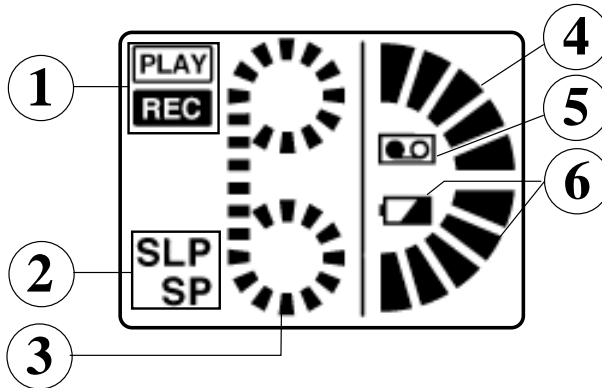

① Status Indicators

The status of the camcorder appears here.

- *PLAY* appears here when the camcorder's *POWER* switch is in *VCR*.
- *REC* appears here when the camcorder's *POWER* switch is in *CAMERA*.

② Tape Speed Indicator (*SP* or *SLP*)

The tape speed selected with the *SP*•*SLP* switch appears here.



③ Cassette Moving Indicator

This indicator shows the cassette is moving.

④ Tape Remaining

- Shows the amount of tape time remaining.

⑤ Cassette Warning

- The  indicator appears when there is a cassette in the camcorder.
- The  indicator flashes when the power dial is set to *CAMERA* or *VCR* and there is no cassette in the camcorder.

⑥ Battery Level Indicator

- This indicator shows how much power is left in the rechargeable battery.
- This indicator flashes when the battery is almost empty.

Recording

Viewfinder

The camcorder's viewfinder is a miniature monitor that displays the picture seen by the camcorder when recording.

Adjust Viewfinder for Convenient Viewing

For convenient viewing, you can slide the viewfinder out from the camcorder and rotate it up and down.

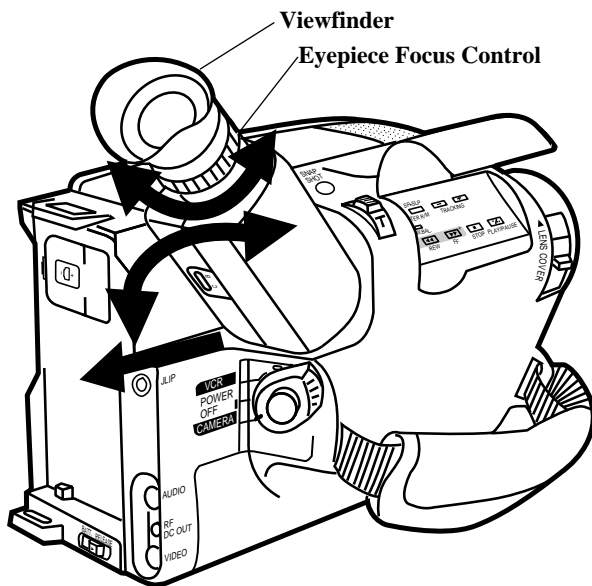

Cautions

Do not force the viewfinder to rotate completely around. This will damage the viewfinder and/or the camcorder.

When carrying the camcorder with the shoulder strap, put the viewfinder down and in. This helps prevent possible damage to the viewfinder from bumping against your body as you move.

Eyepiece Focus Control

The eyepiece focus control lets you set the focus of the viewfinder for your personal vision. If you wear eyeglasses, you probably can operate the camcorder without them.

It is easiest to set the correct focus by focusing on one of the viewfinder's on-screen displays.

Look through the viewfinder and adjust the eyepiece focus control for your vision.

The eyepiece focus control does not affect the focus of the picture actually recorded by the camcorder.

Recording

Viewfinder Displays

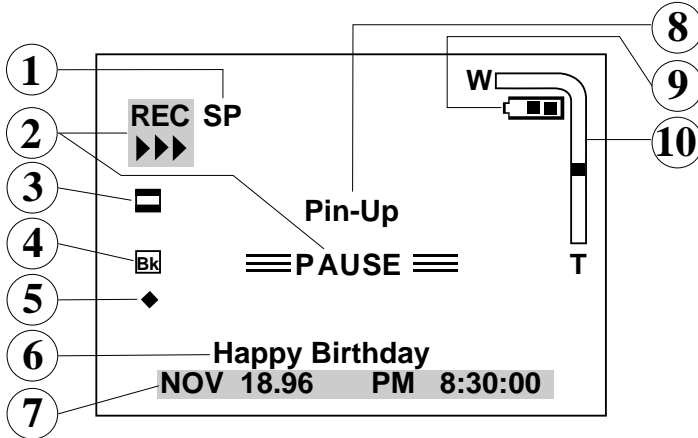

1 Tape Speed Indicators (*SP* or *SLP*)

The tape speed selected with the *SP*• *SLP* button appears here.

• *Details on page 24.*

2 Status Displays

• The *REC* ►►► indicator appears when the camcorder is recording.

• The ≡*PAUSE*≡ indicator appears during record pause.

3 Production Effects Indicators

The indicator for the production effect selected with the *16X9/AE MODES* button appears here. When the mode select dial is in *AUTO*, *Cinema* is automatically selected. Place the mode select dial in *MANUAL* to select the other effects.

• □ appears when you select *Cinema* to “letterbox” record with black bars so you can play back your recordings on a 16X9 TV.

• ◼ appears when you select *Sepia* to give your recordings a brown-tone like old photographs.

• ⌘ appears when you select *Sports* to record fast moving action, such as sporting events.

• ◻ appears when you select *Back-Lit* to make a subject appear brighter that appears too dark because of backlighting.

• ◻ appears when you select *Front-Lit* to darken a subject that appears too bright because of front lighting.

• 🎞 appears when you select *Classic Film* to record in black and white with strobe images to create the vintage look of film being shown on a movie projector.







• 📷 appears when you select *Strobe* to make your recordings look like a series of snapshots.

• ⌘ appears when you select *Slow Shutter* to record areas that are normally too dark to record.

• *Details are on pages 68-69.*

4 Fade, and Wipe Indicators

The indicator for the fade or wipe scene transition selected with the *FADE/WIPE* button appears here. When the mode select dial is in *AUTO*, *Black Fader* is automatically selected. Place the mode select dial in *MANUAL* to select the other fades or wipes.

-  appears when you select *Black Fade* and fade in and out from a black screen.
-  appears when you select *Blue Fade* and fade in and out from a blue screen.
-  appears when you select *Mosaic Fade* and fade in and out with a mosaic effect.
-  appears when you select *Door Wipe* and wipe in from a black screen opening to the sides or wipe out from the center to the sides leaving a black screen.
-  appears when you select *Scroll Wipe* and wipe in from a black screen from the bottom to the top or wipe out from the top to the bottom leaving a black screen.
-  appears when you select *Window Wipe* and wipe in from a black screen from the center to the corners or wipe out from the corners to the center leaving a black screen.
-  appears when you select *Dissolve* and the new scene gradually appears as the old one dissolves.
- -- appears when you select *Auto Select* and the camcorder selects one of six different wipes.
- *Details are on pages 66-67.*

5 Change Indicator (◆)

This indicator will appear to let you know that an item in the recording menu has been changed from the original factory setting.

6 Title

The preset title you select or the title you create will appear in this area.

- The title will be recorded on your tape when it appears.
- *Details are on pages 52-53.*

7 Date or Date and Time

The date, time, or date and time appears in this area of the viewfinder when you press the *DATE/TIME* button.

- These displays will be recorded on your tape when they appear.
- *Details are on pages 56-57.*

8 Snapshot Indicator (*Pin-Up, Frame, Full, Multi4, or Multi9*)

The indicator for the type of snapshot selected with the *PHOTO EFFECTS* button appears here.

- Press the *SNAPSHOT* button to take a snapshot.
- *Details are on pages 40-41.*

9 Battery Level Indicator

- This indicator shows power left in the rechargeable battery.
- This indicator flashes when the battery is almost empty.
- *Details are on page 15.*

10 Zoom Indicator

The zoom indicator appears here when you use the zoom lever.

- *Details on page 48.*

(continued on next page)

Recording

Viewfinder Displays (continued)

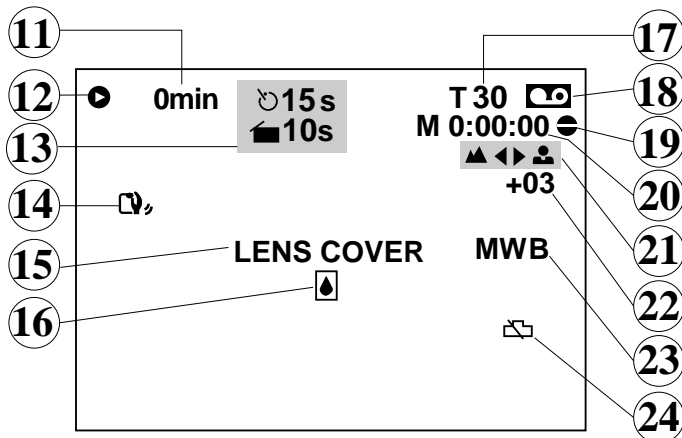



11 Time Remaining Display

The approximate time remaining on the tape is automatically displayed here. The correct *TAPE LENGTH* must be set in the recording menu. *Details are on page 47.*

12 Edit Insert

-  appears during edit insert. *Details are on pages 72-73.*

13 Self-Timer, Animation, and Time-Lapse Indicators

- The interval time selected for self-timer or time-lapse recording ( 15S, 30S, 1min, 5min) appears here. *Details are on pages 60-61 and 64-65.*
- The rec time selected for animation or time-lapse recording ( 1/4S, 1/2S, 1S, or 5S) appears here. *Details are on pages 62-65.*

14 Electronic Image Stabilizer ()

This indicator appears when the electronic image stabilizer is turned on with the *EIS* button. *See page 42 for details.*

15 Warnings and Information

- **LENS COVER:** When you turn on the camcorder, this indicator briefly flashes to remind you to open the lens cover.
- **LENS COVER:** This indicator may flash when the camcorder is used in dark areas — even if the lens cover is open.
- **AUTO PAUSE** appears when the auto pause feature is turned on with the *AUTO PAUSE ON/OFF* button. *Details are on page 43.*
- **INDEX** appears when an index mark is being made on the tape. *Details are on page 43.*
- **TAPE END** appears when the end of the tape is reached during recording or a cassette is inserted with its tape already at the end.

Recording



16 Dew Warning ()

The dew indicator appears when excessive moisture (condensation) has entered the camcorder. The camcorder will not operate when this indicator appears. Place the camcorder in a warm, dry area until this indicator disappears.



17 Tape Length

The tape length (T20, T30, or T40) selected with the *Tape Length* feature on the recording menu appears here. *Details are on page 47.*

18 Cassette Warning

- The  indicator appears when a cassette is in the camcorder.
- The  indicator flashes when the *POWER* dial is set to *CAMERA* and there is no cassette in the camcorder.

19 Audio Dub

-  appears during audio dubbing. *Details are on pages 70-71*
- The pause indicator () appears with  when the camcorder is paused during dubbing.

20 Elapsed Time-Counter

- The time counter appears during playback. It is not recorded.
- An “M” appears in front of the time counter when memory-stop is on.
- *Details are on page 82.*

21 Manual Focus Indicators ()



These indicators appear when focus is adjusted manually using the *FOCUS* ◀ or ▶ button. The mode select dial must be in *MANUAL*.

- Manual focus lock indicators (◀▶) appear when focus is moving toward near or far.
- Low-contrast indicators () flash when the auto-focus system cannot focus properly.
- *Details are on pages 38-39.*

22 Exposure Indicator

This indicator appears when you are adjusting brightness manually using the *FRONTLIGHT* or *BACKLIGHT* button. The mode select dial must be in *MANUAL*. *Details are on page 37.*

23 White Balance Indicators

If you adjust white balance manually, the indicator (*MWB*, , , or ), for the mode you select appears here. The mode select dial must be in *MANUAL*. *Details are on pages 40-41.*

24 Lithium Cell ()

- This indicator flashes for a few seconds when you first turn on the camcorder and the time and date have not been set.
- This indicator also appears when the clock cell is missing or it needs to be replaced. *Details are on page 55.*

Recording

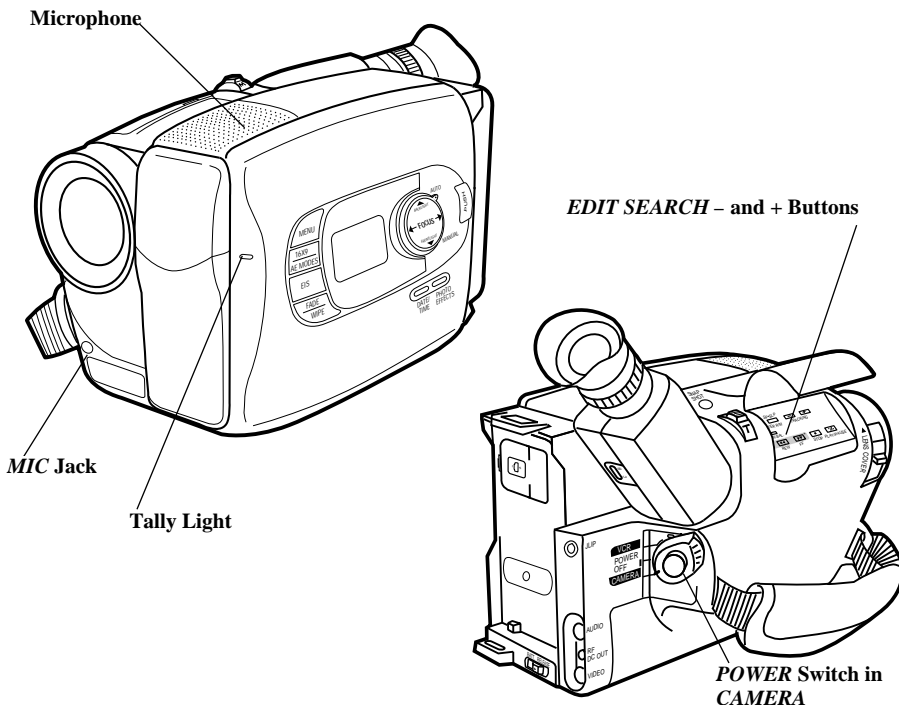

Flying Erase Head

A separate erase head is mounted on the spinning headwheel (hence the term “flying”). This allows you to make clean edits without the “glitches” or “rainbow noise” that may occur at the beginning or the end of recordings.

Auto Head Cleaner

The camcorder has an automatic head-cleaning system. Whenever a cassette is inserted or removed, this system is activated.

The head-cleaning system minimizes the need for accessory cleaners or cleaning by a Servicenter.

Tally Light

The tally light lights when the camcorder is recording.

The tally light can be turned on or off using the recording menu. *See page 59 for details.*

Microphone

The microphone picks up the sound during a recording. It is more sensitive to sounds coming from the direction the lens is pointed.

External MIC (Microphone) Jack

The camcorder has an external MIC (microphone) jack for attaching an optional microphone.

Model CC639's Remote

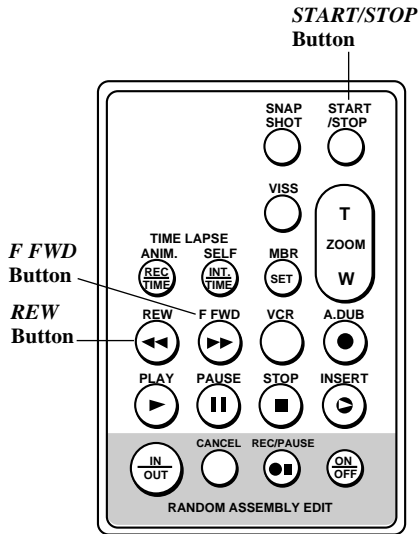

Model CC638's Remote

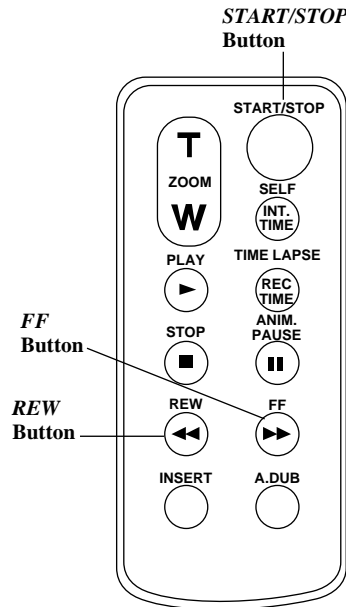

Quick Review Feature

Press and release *EDIT SEARCH* – (*REW* on remote) when the camcorder is in record pause to review the last few seconds of a recording. The *POWER* switch must be in *CAMERA*.

The camcorder will play back the last few seconds of the recording, return the tape to its previous position, and return to record pause.

Camera Edit Feature

The camera edit feature allows you to position the tape when the camcorder is in record pause. Place *POWER* switch in *CAMERA*.

- Press and hold *EDIT SEARCH* – (*REW* on remote) to visually search the recorded tape in reverse.
- Press and hold *EDIT SEARCH* + (*F FWD* or *FF* on remote) to visually search forward on the recorded tape.

Release the button to return the camcorder to record pause at that point on the tape. Press the thumb trigger (*START/ STOP* on remote) to start recording at this point.

Recording

Mode Select Dial

The mode select dial lets you select automatic or manual control of several features. The center of the dial lets you focus manually and control the iris. The arrow buttons are also used with the menus.

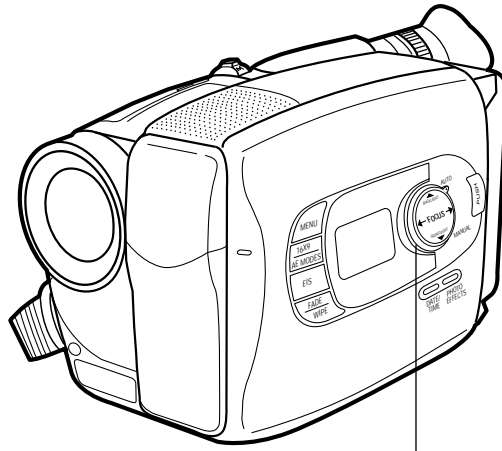

Mode Select Dial

Full *AUTO* Mode

1. Place the *POWER* dial in *CAMERA*.
 - The power indicator will light and the camcorder will enter record pause. \equiv PAUSE \equiv appears in the viewfinder.
2. Place the mode select dial in *AUTO*.
3. Press the thumb trigger to start recording.
 - The camcorder will control the focus, exposure, and white balance for you.
 - The only scene transitions that you can use is the black fader.
 - The only production special effects you can use is cinema.
 - Menu changes cannot be made.

Recording

Exposure Control

When the mode select dial is in *AUTO*, the camcorder controls the iris for you. Under normal conditions, the camcorder will adjust brightness automatically. You may need to adjust brightness manually when the background is too bright or too dark in comparison with the subject.

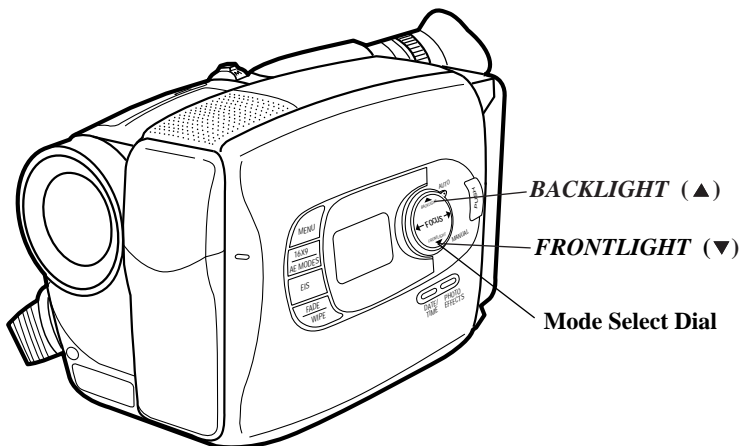

Manual Exposure

1. Place the *POWER* dial in *CAMERA*.
 - The power indicator will light and the camcorder will enter record pause. \equiv PAUSE \equiv appears in the viewfinder.
2. Place the mode select dial in *MANUAL*.
 - Press *BACKLIGHT* to brighten the image.
 - Press *FRONTLIGHT* to darken the image.
 - The exposure level indicator (± 0 to δ) appears in the viewfinder.

To Turn Off Manual Exposure

Press both *BACKLIGHT* and *FRONTLIGHT* at the same time or place the mode select dial in *AUTO*.

Conditions Requiring Manual Exposure

- When recording with a bright background or reverse lighting.
- When recording with a very dark background or very bright subject.
- When recording a reflective natural background — such as a beach or when skiing.

Recording

Focusing

Under normal conditions, the camcorder can adjust focus automatically. Under certain conditions, you may need to focus manually.

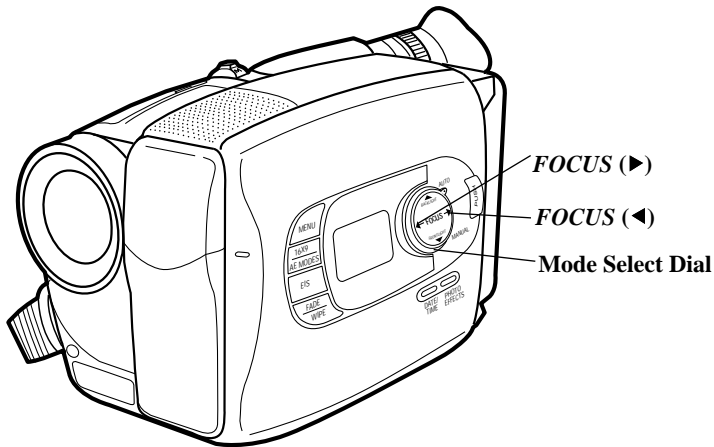

Auto Focus

During auto focus the camcorder will focus automatically on the object located in the center area of the viewfinder.

- Place the mode select dial in *AUTO* to turn on the auto focus feature.

Note: The low-contrast indicator (▲ ▲) in the viewfinder indicates the auto-focus system may not operate correctly due to low illumination, low or no contrast, repeated patterns, or two subjects at different distances overlapping.

Focus Lock Feature

The focus lock feature is useful when objects pass between your subject and the camcorder or your main subject is not located in the center of the viewfinder.

1. Place the mode select dial in *MANUAL*.
2. Center the main object in the viewfinder.
3. Press *FOCUS* ◀ or *FOCUS* ▶ to focus on the main subject. (▲ ▲) appears in the display panel and viewfinder.
4. Press *FOCUS* ◀ and *FOCUS* ▶ together (or place mode select dial in *AUTO*) to turn auto focus back on.

Recording

Manual Focus

Under certain conditions, such as those listed, you may need to focus manually.

1. Set the mode select dial to *MANUAL*.
2. Slide the power zoom lever toward *T* to zoom in on your subject. To maintain proper focus throughout the zoom range, you must zoom in on the subject before adjusting the focus.
3. Press *FOCUS ◀* or *FOCUS ▶* to display a clear picture in the center of the viewfinder.
The ▲ ● indicators appear in the viewfinder. The ◀ or ▶ indicator will flash. When the focus cannot be adjusted any farther, the ▲ indicator will flash. When the focus cannot be adjusted any closer, the ● indicator will flash.
4. Release the *FOCUS ◀* or *FOCUS ▶* to lock in the manual focus.
5. Press *FOCUS ◀* and *FOCUS ▶* together (or place mode select dial in *AUTO*) to turn auto focus back on.

Conditions Requiring Manual Focus

- When recording a subject through a window.
- When recording a subject having a close foreground and a background that is far away.
- When recording two subjects at different distances that overlap in the same scene.
- When the subject is not in the center of the viewfinder.
- When recording in low-light situations.
- When recording a scene with fast motions, like a tennis swing.

Recording

Snapshot Feature

The snapshot feature lets you take a snapshot or snapshots like a regular camera. You can select one of five different types of snapshots. You can also record a series of still pictures similar to serial photographs.

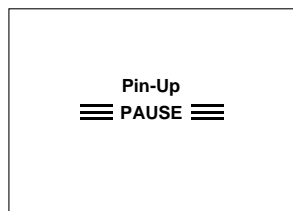
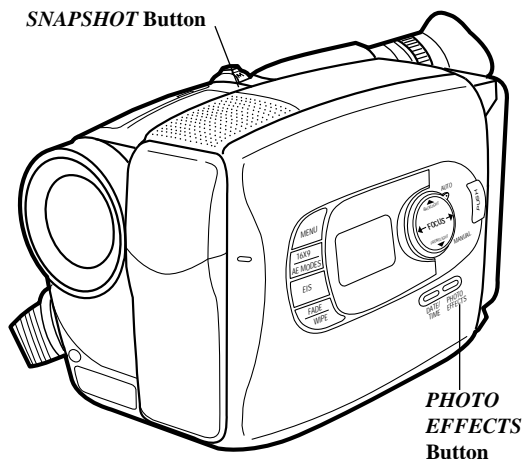

Viewfinder Display

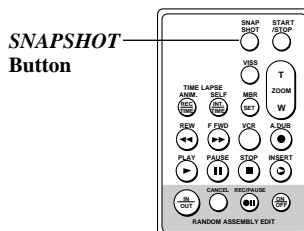

Model CC639's Remote

To Add Snapshots to Your Tape

1. Repeatedly press *PHOTO EFFECTS* on the camcorder to select the type of snapshot you want.

- Select *Pin-Up* to have the scene appear with a white dimensional frame on a blue background.
- Select *Frame* to have a white frame around the entire scene.



Recording

- Select *Full* to take a snapshot of the entire scene.



- Select *Multi 4* to have four snapshots with white dimensional frames appear on a blue background.



- Select *Multi 9* to have nine snapshots with white dimensional frames appear on a blue background.



2. Press and release the *SNAPSHOT* button.

- If the camcorder is in record pause, the sound effect of a shutter closing is recorded with a four second snapshot. The camcorder then returns to record/pause.
- If the camcorder is recording, the sound effect of a shutter closing is recorded with a four second snapshot. The camcorder then returns to normal recording.

Note: If you are using the *Frame* or *Full* mode, the normal recording gradually appears over the snapshot.

If you are using the *Pin-Up*, *Multi 4*, or *Multi 9* mode, the normal recording wipes in from the center of the viewfinder.

3. **Serial Snapshots (Camcorder Only):**

Press and hold the *SNAPSHOT* button on the camcorder to take snapshots seconds apart. This gives the effect of serial photography.

Note: When using the serial snapshot feature, the shutter sound and the appearance of the snapshots may not match.

Recording

Electronic Image Stabilizer (EIS)

The electronic image stabilizer helps compensate for unstable images caused by camera shake that can be created by recording out of a moving vehicle or while walking.

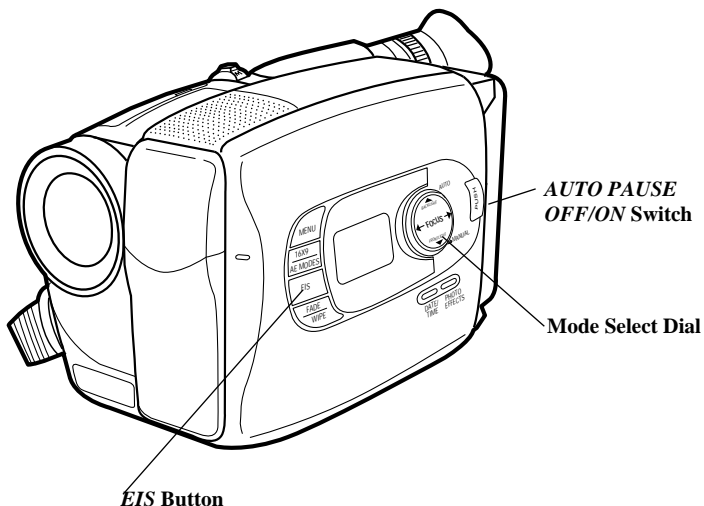

To Turn On EIS

1. Place the *POWER* switch in *CAMERA*.
2. Press the *EIS* button. The EIS indicator appears in the viewfinder.

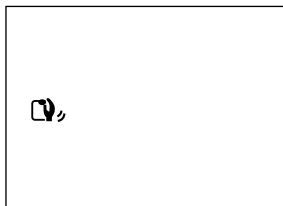

EIS Indicator in Viewfinder

Notes: EIS does not operate when slow shutter is activated. The  flashes letting you know EIS is not functioning.

Turn off EIS when using a tripod.

Stabilization may not be possible if hand shake is excessive or when shooting the following:

- Subjects with vertical or horizontal stripes.
- Low contrast subjects or backgrounds or dark or dim subjects.
- Subject with excessive backlighting.
- Scenes with movements in various directions.

To Turn Off EIS

Press the *EIS* button. The EIS indicator disappears from the viewfinder.

Recording

Auto Pause Feature

The auto pause system places the camcorder in record pause when it is tilted approximately 90 degrees up or down or turned upside down.

To Turn On the Auto Pause System

- Slide *AUTO PAUSE OFF/ON* switch to *ON*.

If the camcorder is tilted approximately 90 degrees up or down, turned upside down, or turned on its side during recording, it will automatically enter record pause. *AUTO PAUSE* appears in the viewfinder.

To Turn Off the Auto Pause System

- Slide *AUTO PAUSE OFF/ON* switch to *OFF*.

The camcorder will record in any position.

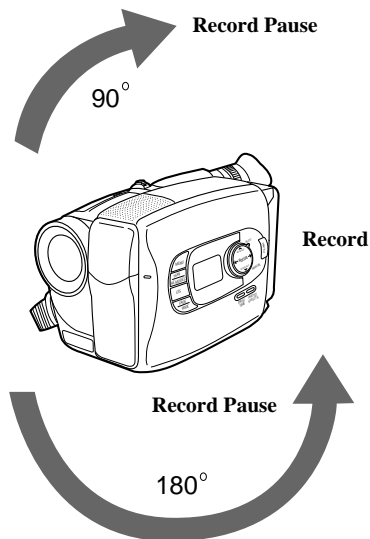

Electronic Indexing

An index mark is automatically recorded at the beginning of a recording after a cassette is inserted. When you play back the indexed tape in a VCR that has a compatible indexing feature called “VHS Index Search System”, the invisible marks can be located automatically. See VCR owner’s manual.

Record an Index Mark – CC639 Remote Only

- Press *VISS* on the remote during recording.
- Press *VISS* during record pause to make an index mark on the tape when you start recording.

INDEX flashes in the viewfinder when an index mark is recorded.

Note: No other function can be performed during index recording.

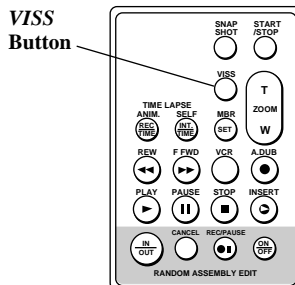

Model CC639's Remote

Recording

Press the *MAN.W.BAL* (Manual White Balance) Button to Display in Viewfinder

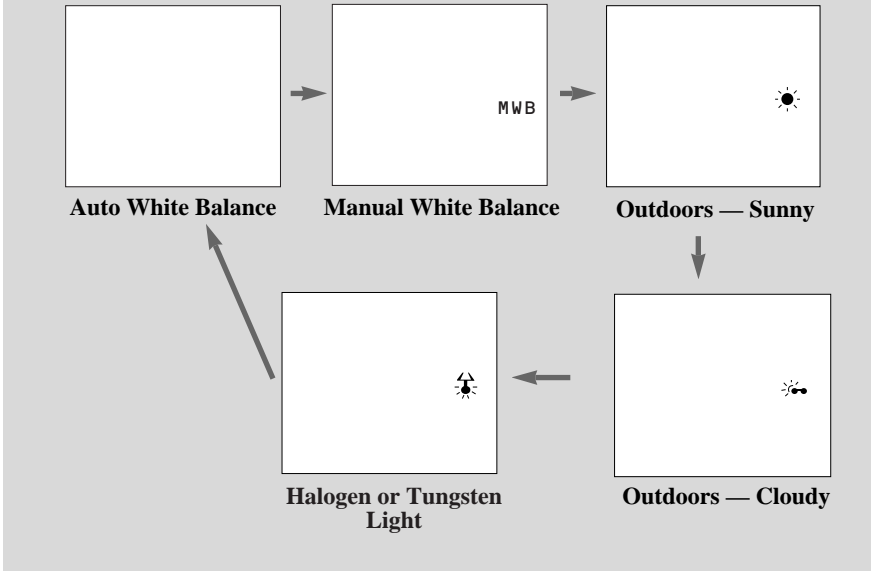

- A. Point camcorder at a white, flat object such as a piece of white paper.
- B. Press and hold *MAN.W.BAL* for at least three seconds.

The *MWB* indicator will flash while the camcorder is adjusting white balance and stop flashing when it is ready to record.

Note: To change the tint for special recording, substitute colored paper for white. The white balance is adjusted based on the color.

Red paper – deeper green
Blue paper – orange
Yellow paper – deeper purple

- Select ☀ when recording outdoors on a sunny day.
 - Select ☁ when recording outdoors on a cloudy day.
 - Select ⚡ when recording using halogen or tungsten lighting.
4. To have camcorder automatically control white balance, repeatedly press *MAN.W.BAL* until no white balance indicator appears in viewfinder (or place mode select dial in *AUTO*).

Recording

Recording Menu

The main recording menu lets you select and set several recording features: *Shift Zoom* (digital zooming), *Tele Macro* (close-up), *Gain Up* (light adjustment), *Color Filter*, *Tape Length*, *Title*, and *Date/Time*. The *Sub Menu* lets you turn the tally light on or off, set interval and recording times for self-timer, animation, and time-lapse recording, and set an ID number.

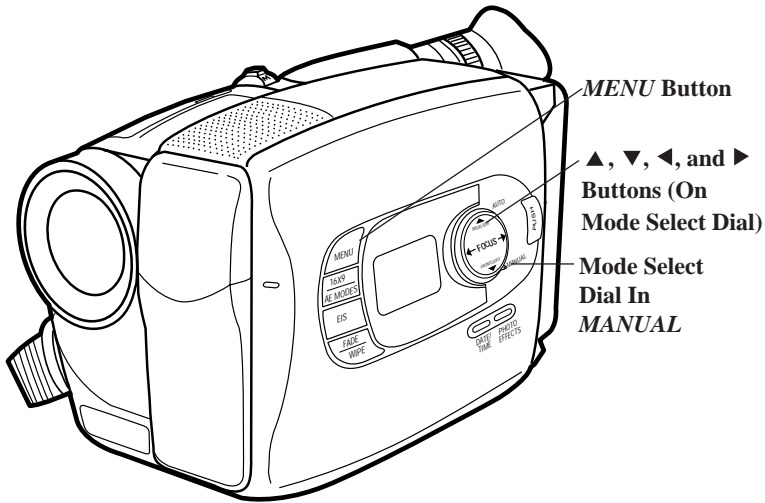

To Display the Recording Menu

1. Make sure the mode select dial is in *MANUAL*.
2. Press the *MENU* button. The recording menu will appear in the viewfinder.
3. Press ▲ or ▼ on the mode select dial to highlight the feature you want to adjust.
4. Press ◀ or ▶ on the mode select dial to select the option you want for that feature.
5. Press *MENU* to exit the menu.

Shift Zoom	OFF
Tele Macro	OFF
Gain Up	AGC
Color Filter	NOR.
Tape Length	T20
Title	
Date/Time	
Sub Menu	

Recording Menu in Viewfinder

Note: If you want to change another feature, repeat steps 3 and 4.

Recording

Recording Menu — Tape Time-Remaining Display

The approximate time remaining on the tape in the camcorder is automatically displayed in the viewfinder. The *Tape Length* feature in the recording menu must be set correctly for the length tape you are using before the camcorder can correctly calculate time remaining.

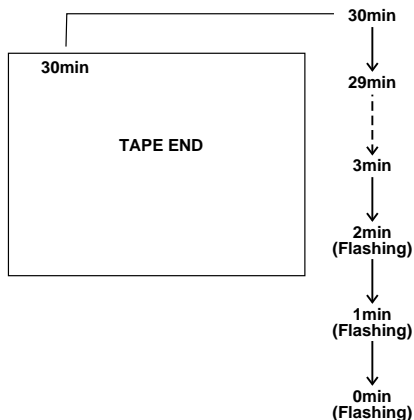
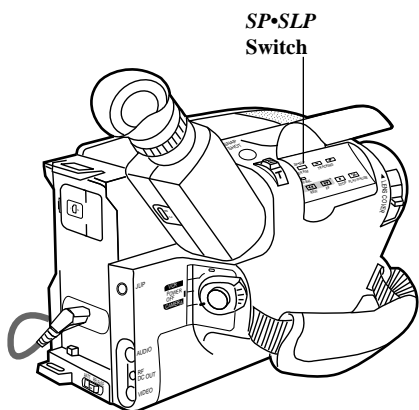

Set the Tape Length

1. Make sure the mode select dial is in *MANUAL*.
2. Press the *MENU* button. The recording menu will appear in the viewfinder.

Shift Zoom	OFF
Tele Macro	OFF
Gain Up	AGC
Color Filter	NOR.
Tape Length	T20
Title	
Date/Time	
Sub Menu	

3. Press **▲** or **▼** on the mode select dial to highlight *Tape Length*.
4. Press **◀** or **▶** on the mode select dial to select the length of tape you are using:

- Select *T20* if you are using a tape with 20 minutes recording time in SP speed.
- Select *T30* if you are using a tape with 30 minutes recording time in SP speed.
- Select *T40* if you are using a tape with 40 minutes recording time in SP speed.

5. Press *MENU* to exit the menu.

Notes: The time-remaining indicator will start flashing when the remaining tape time reaches two minutes.

TAPE END appears when the tape reaches its end during recording or a cassette is loaded with its tape already at the end.

Recording

Zooming

You can zoom in and out for close ups or wide-angle shots just by sliding the zoom lever on the camcorder or pressing the button on the remote. The camcorder can automatically focus when you zoom at most distances.

If you want to record a close-up of a small subject closer than three feet, you can turn on the *Tele Macro* feature in the recording menu. This feature allows you to record a small subject at a distance of approximately 23 inches.

You can extend the amount of zooming by 5 or 14 times the normal zoom using the *Shift Zoom* feature in the recording menu.

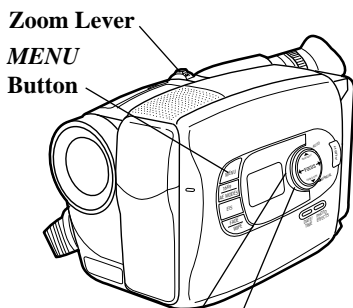

▲, ▼, ◀, and ▶
Buttons (On
Mode Select Dial)

Mode Select
Dial In
MANUAL

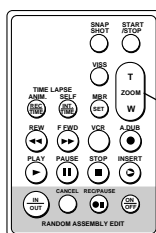

Model CC639's Remote

Zoom
Buttons
(T and W)

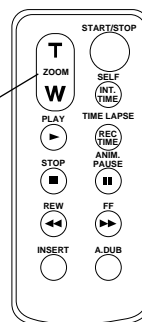

Model CC638's Remote

Using the Zoom Lever

1. To zoom in or out, slide the zoom lever on the camcorder or press the button on the remote.
 - To move the lens in the telephoto (close-up) direction, slide the zoom lever toward T.
 - To move the lens in the wide angle direction, slide the lever toward W.

Zoom speed varies on the camcorder according to how far you zoom in or out.

The zoom level indicator appears in the viewfinder.

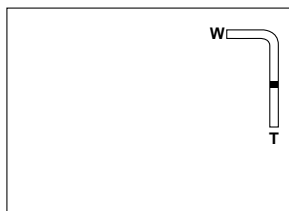

Zoom Indicator
in Viewfinder

Recording

Recording Menu — *Tele Macro Zooming Feature*

To Turn on Tele Macro

1. Make sure the mode select dial is in *MANUAL*.
2. Press the *MENU* button. The recording menu will appear in the viewfinder.
3. Press ▲ or ▼ on the mode select dial to highlight *Tele Macro*.
4. Press ◀ or ▶ on the mode select dial to select *OFF* or **◆ON**.
 - Select **◆ON** if you want to record a small subject within approximately 23 inches.
 - Select *OFF* for normal zooming.
5. Press *MENU* to exit the menu.

Shift Zoom	OFF
Tele Macro	OFF
Gain Up	AGC
Color Filter	NOR.
Tape Length	T20
Title	
Date/Time	
Sub Menu	

Note: Depending on the position of the zoom, the lens may go out of focus.

Recording Menu — *Shift Zoom (Zoom Magnification)*

To Set the Zoom Ratio

1. Make sure the mode select dial is in *MANUAL*.
2. Press the *MENU* button. The recording menu will appear in the viewfinder.
3. Press ▲ or ▼ on the mode select dial to highlight *Shift Zoom*.
4. Press ◀ or ▶ on the mode select dial to select *OFF*, **◆50x** or **◆140x** zoom magnification.
 - Select *OFF* for normal zooming.
 - Select **◆50x** to zoom up to 50 times the normal size.
 - Select **◆140x** to zoom up to 140 times the normal size.
5. Press *MENU* to exit the menu.

Shift Zoom	OFF
Tele Macro	OFF
Gain Up	AGC
Color Filter	NOR.
Tape Length	T20
Title	
Date/Time	
Sub Menu	

3. Press ▲ or ▼ on the mode select dial to highlight *Shift Zoom*.

Recording

Recording Menu — *Gain Up* (Slow Shutter)

The gain up feature allows you to take bright and natural recordings even in areas with low or poor lighting.

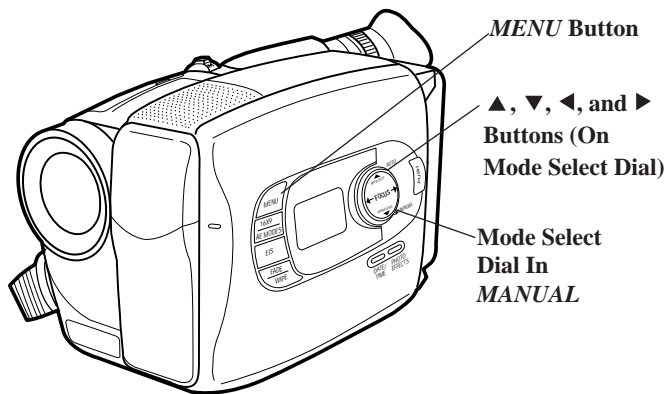

To Set *Gain Up*

1. Make sure the mode select dial is in *MANUAL*.
2. Press the *MENU* button. The recording menu will appear in the viewfinder.

Shift Zoom	OFF
Tele Macro	OFF
Gain Up	AGC
Color Filter	NOR.
Tape Length	T20
Title	
Date/Time	
Sub Menu	

3. Press ▲ or ▼ on the mode select dial to highlight *Gain Up*.
4. Press ◀ or ▶ on the mode select dial to select ◆ *A*⌘, ◆ *OFF*, or *AGC*.
 - Select ◆ *A*⌘ to have the shutter speed automatically adjusted from 1/30 to 1/60 second.

Notes: Shooting a subject in low or poor lighting at 1/30 second shutter speed provides a brighter image than in the *AGC* mode, but the subject's movements are not as smooth or natural.

When the *LIGHT OFF/AUTO/ON* switch is in *ON* or *AUTO*, the ◆ *A*⌘ is disabled.

- Select ◆ *OFF* when lighting is not a problem.
 - Select *AGC* to have recording appear brighter and movements more natural and smooth than when recording in the auto (◆ *A*⌘) mode. However, the overall appearance may be “jagged”.
5. Press *MENU* to exit the menu.

Recording

Recording Menu — *Color Filter*

This feature allows you to record adding a red or blue tint to the recording.

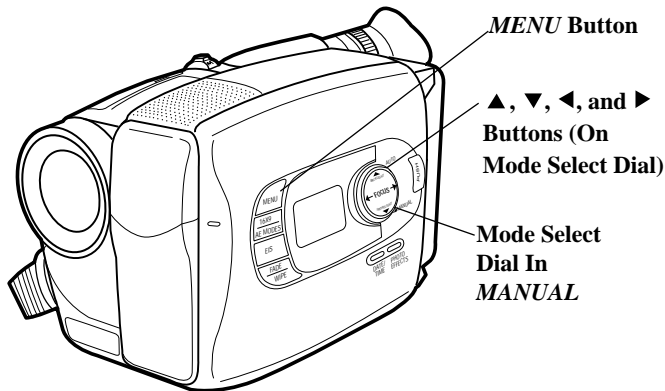

To Set *Color Filter*

1. Make sure the mode select dial is in *MANUAL*.
2. Press the *MENU* button. The recording menu will appear in the viewfinder.

Shift Zoom	OFF
Tele Macro	OFF
Gain Up	AGC
Color Filter	NOR.
Tape Length	T20
Title	
Date/Time	
Sub Menu	
3. Press ▲ or ▼ on the mode select dial to highlight *Color Filter*.
4. Press ◀ or ▶ on the mode select dial to select *NOR.*, *RED*, or *BLUE*.
 - Select *NOR.* for normal recording
 - Select *RED* to add a reddish tint to your recording.
 - Select *BLUE* to add a bluish tint to your recording.
5. Press *MENU* to exit the menu.

Recording

Recording Menu — *Title*

The title feature lets you choose one of eight preset titles or create your own title — up to 18 characters. The clock cell battery must be installed *as shown on page 55* before you can create or store your own title.

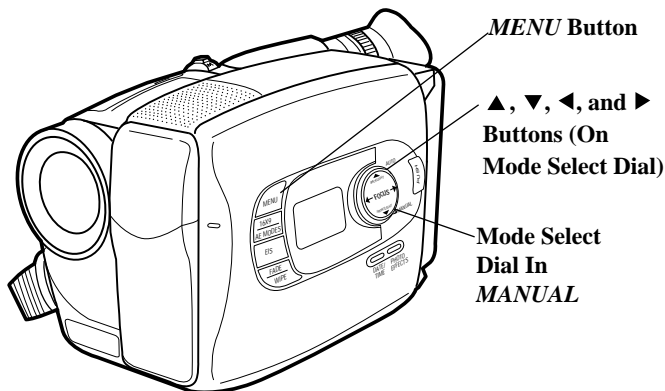

To Add a Preset Title to Your Recordings

1. Make sure the mode select dial is in *MANUAL*.
2. Press the *MENU* button. The recording menu will appear in the viewfinder.
4. Press ▶ on the mode select dial to display the title menu.

Shift Zoom	OFF
Tele Macro	OFF
Gain Up	AGC
Color Filter	NOR.
Tape Length	T20
Title	
Date/Time	
Sub Menu	

OFF
Happy Birthday
Happy Holidays
Congratulations
Our Family
Someone Special
Vacation
Super Star
First
(Set Character)

3. Press ▲ or ▼ on the mode select dial to highlight *Title*.
5. Press ▲ or ▼ on the mode select dial to highlight the preset title you wish to use.
6. Press *MENU* to display the title in the viewfinder. It will be superimposed on your tape during recording.

Recording

To Create Your Own Title

1. Make sure the mode select dial is in *MANUAL*.
2. Press the *MENU* button. The recording menu will appear in the viewfinder.

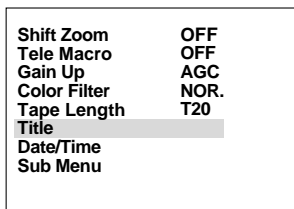

3. Press \blacktriangle or \blacktriangledown on the mode select dial to highlight *Title*.
4. Press \blacktriangleright on the mode select dial to display the title menu.

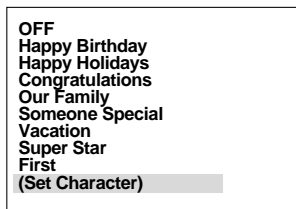

5. Press \blacktriangle or \blacktriangledown on the mode select dial to highlight *(Set Character)*.
6. Press \blacktriangleright on the mode select dial to display the set character menu.

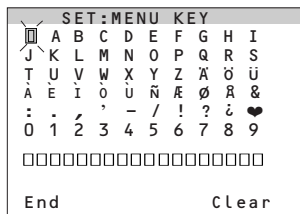

Note: If you wish to erase a previous title, highlight *Clear*, and press *MENU*.

7. Press \blacktriangleleft , \blacktriangleright , \blacktriangle , or \blacktriangledown on the mode select dial to highlight the character you wish to use.
8. Press *MENU* to enter the character in your title.
9. Repeat steps 7 and 8 until you have completed your title (up to 18 characters).

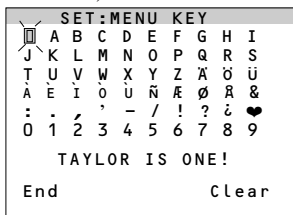

Note: To correct a character, highlight the character you want to correct, highlight the character you want to replace it with, and press *MENU*.

10. When you are finished, press \blacktriangleleft , \blacktriangleright , \blacktriangle , or \blacktriangledown on the mode select dial to highlight *End*.
11. Press *MENU* to return to the title menu, or press *MENU* twice to remove all menus from the screen and display and record your title.

To Turn Off a Title

1. Display the title menu and use the \blacktriangle or \blacktriangledown on the mode select dial to highlight *OFF*.

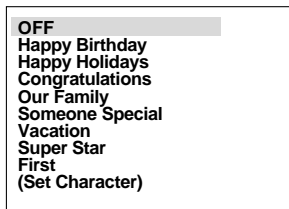

2. Press *MENU* to remove the title menu from the screen.

Recording

Recording Menu — Date/Time Display

The date and time must be set before it can be displayed and recorded on your tapes. The clock cell must be installed *as shown on the next page* before the date can be set and recorded.

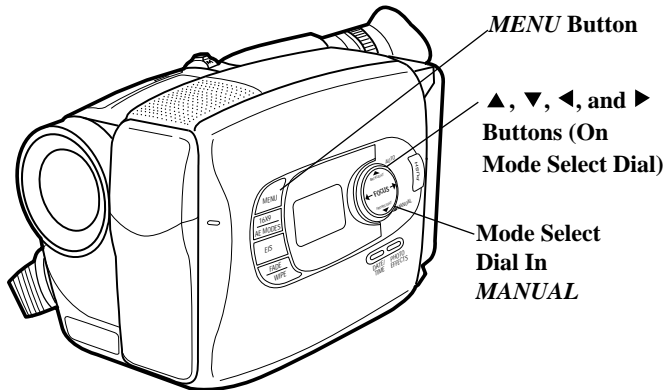

To Set the Date and Time

1. Make sure the mode select dial is in *MANUAL*.
2. Press the *MENU* button. The recording menu will appear in the viewfinder.
3. Press ▲ or ▼ on the mode select dial to highlight *Date/Time*.
4. Press ▶ on the mode select dial to display the date and time screen.
5. Press ▲ or ▼ to enter the correct month. Press ▲ to go forward or ▼ to go back.
6. Press ▶ on the mode select dial to start the day flashing.
7. Repeat steps 5 and 6 to set the year, hour (including AM and PM), and minutes.

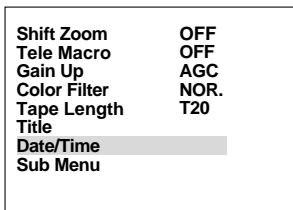

8. Press ◀ or ▶ to highlight *Set*.
9. Press the *MENU* button. The camcorder's internal clock will start and you will return to the recording menu.

Notes: Press *MENU* twice to start the clock and remove all the menus from the viewfinder.

If you enter an invalid date, *Input Error* appears in the viewfinder. Press ▲, ▼, ◀, or ▶ and enter the correct day.

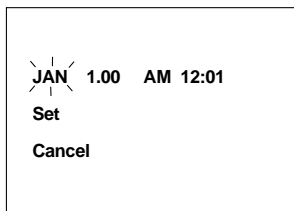

Recording

Date/Time Display — Install the Clock Lithium Cell

The clock cell indicator  will flash for a few seconds in the viewfinder when you turn on the camcorder if the cell has not been installed or needs to be replaced.

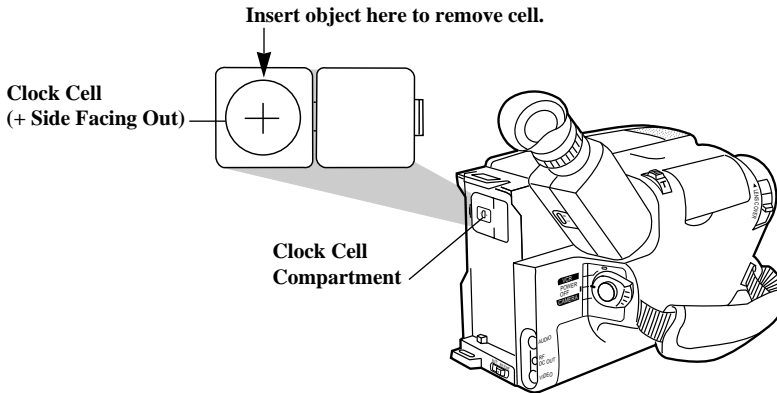

1. Make sure camcorder is turned off, and remove any power supply attached to the camcorder.
2. Press release tab of clock cell compartment cover and open the compartment.
3. Insert the clock cell with the "+" terminal facing out.
4. Close the compartment cover. It will click into place.

To remove battery

To remove battery, insert a pointed non-metallic object between battery and compartment and lift.

Cautions: Lithium cell battery. Replace only with 3-volt lithium cell – such as CR2025. Use of other cell presents a risk of fire or explosion. Must be disposed of properly. Never handle punctured or leaking cell. May cause burns or personal injury.

Keep out of the hands of children. Can cause death or injury if swallowed. If swallowed, consult a physician immediately for emergency treatment.

The lithium cell used in this device may explode resulting in a fire or chemical burn if mistreated. Do not recharge, disassemble, heat above 212°F (100°C), or incinerate.

Never use metallic tweezers to hold the cell, and never short circuit the + and – sides of the cell.

Recording

Date/Time Display

The clock cell must be installed and the date and time set before they can be selected and recorded.

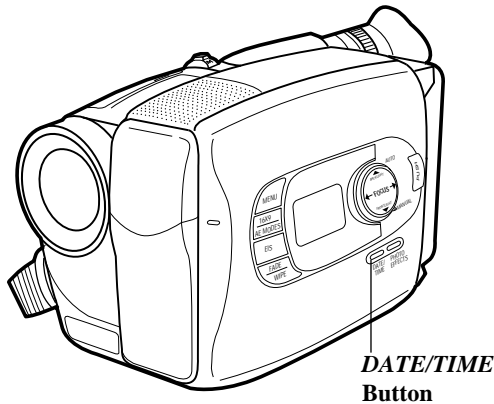

To Select the Date or Date and Time You Want to Record On Your Tape

1. Attach a power supply and place *POWER* switch in *CAMERA*. The power indicator will light.
 2. Repeatedly press *DATE/TIME* to select the date, time, or date and time you want to record.
- **Date Display:** The date will be displayed and recorded.
 - **Time:** The time will be displayed and recorded.
 - **Date and Time Display:** The date and time will be displayed and recorded.
 - **Date and Time Off:** No date or time will be displayed or recorded.

Recording

Date/Time Display

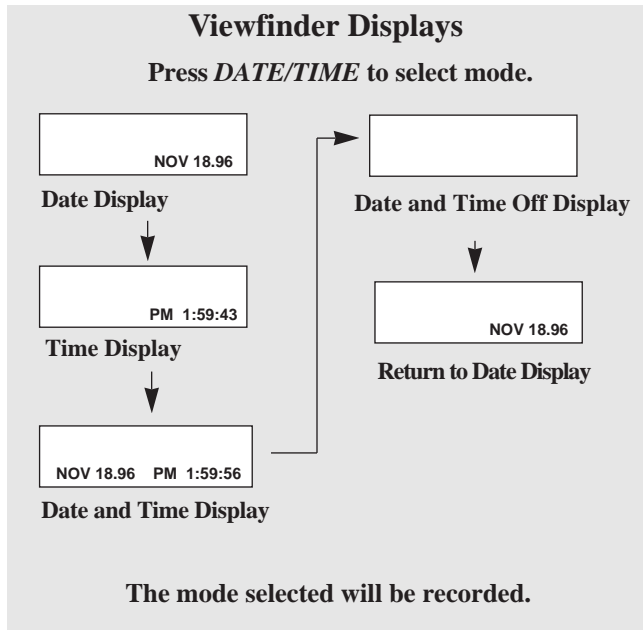

To Record the Date or Date and Time on Your Tape

1. Place the camcorder in record pause.
2. Repeatedly press the *DATE/TIME* button to display the date, time, or date and time you have previously stored in the viewfinder.
3. Begin recording.
4. Press the *DATE/TIME* button to remove the display from the viewfinder when you are finished recording it.
5. To record the display again, place the camcorder in record pause and press the *DATE/TIME* button to select the mode you want to record.

Note: If you do not want to record a date or time, press *DATE/TIME* to select the date and time off mode.

Recording

Recording Menu — *Sub Menu*

The sub menu lets you turn the tally light on or off, set interval and recording times for the self-timer, time-lapse recording, or animation recording. You can also set a JLIP ID number for a device (such as a personal computer).

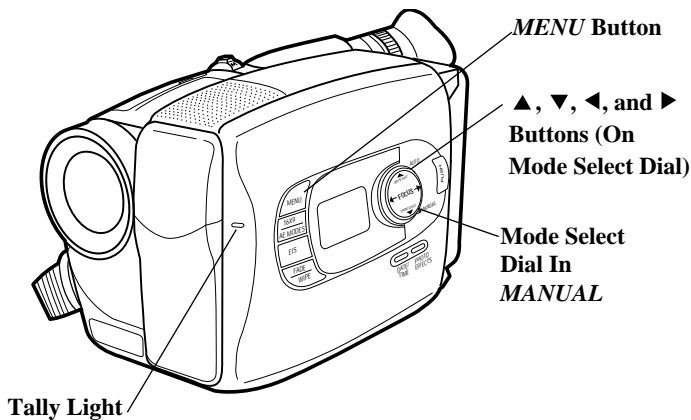

To Change a Feature in the Sub Menu

1. Make sure the mode select dial is in *MANUAL*.
2. Press the *MENU* button. The recording menu will appear in the viewfinder.

Tally	ON
Interval Timer	OFF
Rec Time	OFF
JLIP ID NO.	07

Shift Zoom	OFF
Tele Macro	OFF
Gain Up	AGC
Color Filter	NOR.
Tape Length	T20
Title	
Date/Time	
Sub Menu	

3. Press ▲ or ▼ on the mode select dial to highlight *Sub Menu*.
4. Press ▶ on the mode select dial to display the sub menu.
5. Press ▲ or ▼ on the mode select dial to highlight the item you want to adjust.
6. Press ▶ on the mode select dial to start the highlighted item flashing.
7. Press ▲ or ▼ on the mode select dial to adjust the highlighted item. Press ◀ to stop the item flashing.
- Note:** If you want to change another feature, repeat steps 5, 6, and 7.
8. Press *MENU* to exit the menu, or press ◀ to return to the main recording menu.

Recording

Tally Light

To Turn the Tally Light *ON* or *OFF*

1. Follow steps 1-4 *on the previous page*.
2. Press ▲ or ▼ on the mode select dial to highlight *Tally*.
3. Press ► on the mode select dial to start *Tally* flashing.
4. Press ▲ or ▼ on the mode select dial to turn the tally light *ON* or *OFF*.
 - Select *ON* to have the tally light turn on during recording.
 - Select *OFF* if you do not want the tally light to light.
5. Press ◀ to stop *Tally* flashing.
6. Press *MENU* to exit the menu.

Tally	ON
Interval Timer	OFF
Rec Time	OFF
JLIP ID NO.	07

Set the *JLIP ID NO.*

The camcorder has a *JLIP* (Joint Level Interface Protocol) connector that may be used in the future to connect a device, such as a home computer.

To Select a *JLIP ID NO.*

1. Follow steps 1-4 *on the previous page*.
2. Press ▲ or ▼ on the mode select dial to highlight *JLIP ID NO.*
3. Press ► on the mode select dial to start *JLIP ID NO.* flashing.
4. Press ▲ or ▼ on the mode select dial to a number from 01 to 99.
5. Press ◀ to stop *JLIP ID NO.* flashing.
6. Press *MENU* to exit the menu.

Tally	ON
Interval Timer	OFF
Rec Time	OFF
JLIP ID NO.	07

Recording

Self-Timer

The self-timer lets you set the camcorder to delay recording so you can be in the scene when recording begins.

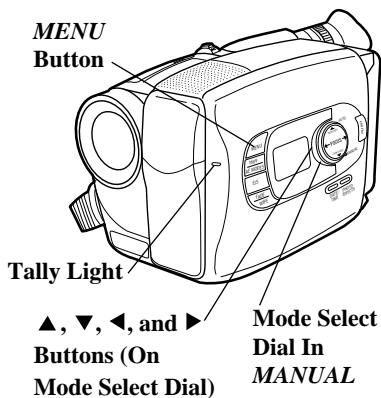

Tally	ON
Interval Timer	OFF
Rec Time	OFF
JLIP ID NO.	07

Interval Timer Options

15S
↓
30S
↓
1min
↓
5min

To Set the Self-Timer

1. Place the *POWER* dial in *CAMERA*. The power indicator will light.
2. Place mode select dial in *MANUAL*.
3. Press the *MENU* button. The recording menu will appear in the viewfinder.
4. Press ▲ or ▼ on the mode select dial to highlight *Sub Menu*.
5. Press ▶ on the mode select dial to display the sub menu.
6. Press ▲ or ▼ on the mode select dial to highlight *Interval Timer*.

Shift Zoom	OFF
Tele Macro	OFF
Gain Up	AGC
Color Filter	NOR.
Tape Length	T20
Title	
Date/Time	
Sub Menu	

Tally	ON
Interval Timer	OFF
Rec Time	OFF
JLIP ID NO.	07

7. Press ▶ on the mode select dial to start *Interval Timer* flashing.

Recording

8. Press ▲ or ▼ on the mode select dial to select the amount of time you want the recording delayed.
 - Select *15S* to delay the recording for 15 seconds.
 - Select *30S* to delay the recording for 30 seconds.
 - Select *1min* to delay the recording for one minute.
 - Select *5min* to delay the recording for five minutes.
 - Select *OFF* if you do not want the camcorder to delay recording.
9. Press ◀ to stop *Interval Timer* flashing.

10. Press *MENU* to exit the menu. ☺ and the amount of delayed recording time appear in the viewfinder.

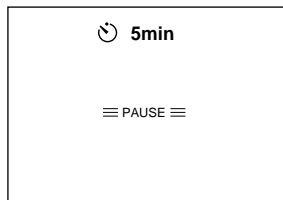

**Self-Timer Indicator
in Viewfinder**

11. Press the thumb trigger to start recording.

Note: The tally light flashes. About five seconds before recording begins, the tally light will start flashing faster.

Self-Timer — Using Remote

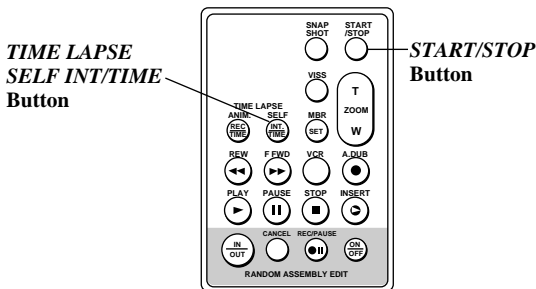

Model CC639's Remote

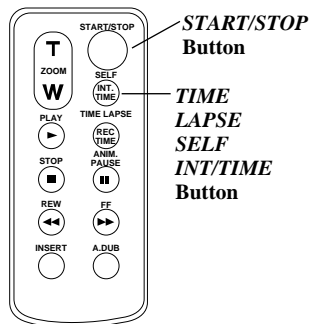

Model CC638's Remote

1. Place the *POWER* dial on the camcorder in *CAMERA*. The power indicator will light.
2. Press the *TIME LAPSE SELF INT/TIME* button. ☺ and the

amount of delayed recording time appear in the viewfinder.

3. Press the *START/STOP* button to start recording.

Recording

Sub Menu — Animation Recording

Animation recording produces an illusion of movement for an otherwise stationary scene or object by shooting a series of pictures of slightly different poses (such as cartooning).

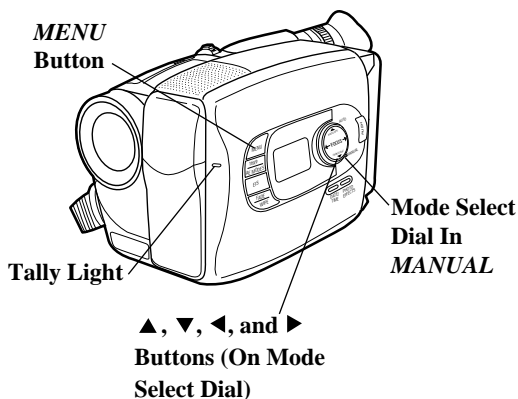

Tally	ON
Interval Timer	OFF
Rec Time	OFF
JLIP ID NO.	07

Recording Time Options

1/4S
↓
1/2S
↓
1S
↓
5S

To Record Using Animation

1. Place the *POWER* dial in *CAMERA*. The power indicator will light.
2. Place mode select dial in *MANUAL*.
3. Press the *MENU* button. The recording menu will appear in the viewfinder.

Shift Zoom	OFF
Tele Macro	OFF
Gain Up	AGC
Color Filter	NOR.
Tape Length	T20
Title	
Date/Time	
Sub Menu	

4. Press ▲ or ▼ on the mode select dial to highlight *Sub Menu*.
5. Press ▶ on the mode select dial to display the sub menu.

Tally	ON
Interval Timer	OFF
Rec Time	OFF
JLIP ID NO.	07

6. Press ▲ or ▼ on the mode select dial to highlight *Rec Time*.
7. Press ▶ on the mode select dial to start *Rec Time* flashing.
8. Press ▲ or ▼ on the mode select dial to select the amount of time you want the camcorder to record.
 - Select *1/4S*, *1/2S*, *1S*, or *5S* to have the camcorder record for 1/4 second, 1/2 second, one second, or five seconds.
 - Select *OFF* to turn off the recording time.

Recording

9. Press **◀** to stop *Rec Timer* flashing.
10. Press **MENU** to exit the menu. **▶** and the amount of recording time appear in the viewfinder.

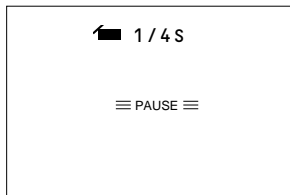

11. Press the thumb trigger to start recording.

Note: The recording stops automatically after the selected period of recording time. You may want to take two to five shots of the subject in the same position.

12. Move the subject and repeat step 11 for the desired number of shots.

Animation Recording — Using the Remote

**TIME LAPSE ANIM.
REC/TIME Button**

**START/STOP
Button**

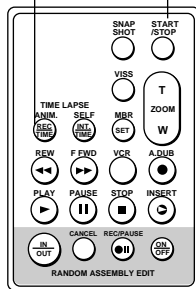

Model CC639's Remote

**START/STOP
Button**

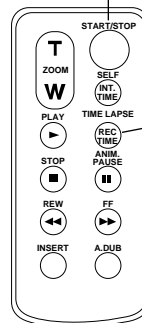

**TIME
LAPSE
ANIM.
REC/TIME
Button**

Model CC638's Remote

1. Place the **POWER** dial on the camcorder in **CAMERA**. The power indicator will light.
2. Press the **TIME LAPSE ANIM. REC/TIME** button. **▶** and the

amount of recording time appear in the viewfinder.

3. Press the **START/STOP** button to start recording.

Recording

Sub Menu — Time-Lapse Recording

Time-lapse recording makes automatic recordings at preset time intervals. The recording will show subtle changes (such as shifts in cloud formations or plant growth) when it remains focused on an object.

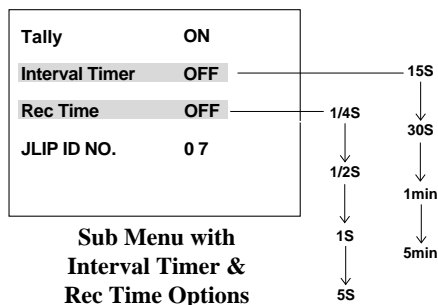
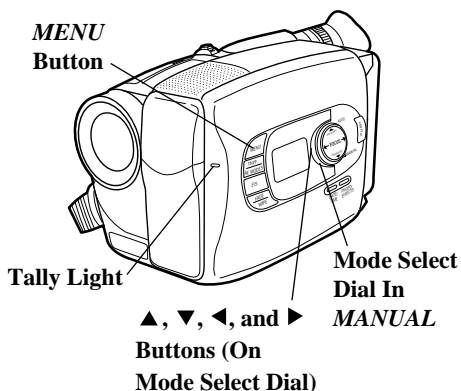

To Record Using Time Lapse

1. Place the *POWER* dial in *CAMERA*. The power indicator will light.
2. Place mode select dial in *MANUAL*.
3. Press the *MENU* button. The recording menu will appear in the viewfinder.

Shift Zoom	OFF
Tele Macro	OFF
Gain Up	AGC
Color Filter	NOR.
Tape Length	T20
Title	
Date/Time	
Sub Menu	

4. Press ▲ or ▼ on the mode select dial to highlight *Sub Menu*.
5. Press ▶ on the mode select dial to display the sub menu.
6. Press ▲ or ▼ on the mode select dial to highlight *Rec Time*.
7. Press ▶ on the mode select dial to start *Rec Time* flashing.

8. Press ▲ or ▼ on the mode select dial to select the amount of time you want the camcorder to record.

- Select *1/4S*, *1/2S*, *1S*, or *5S* to have the camcorder record for 1/4 second, 1/2 second, one second, or five seconds.
- Select *OFF* to turn off the recording time.

9. Press ◀ to stop *Rec Time* flashing.

10. Press ▲ or ▼ on the mode select dial to highlight *Interval Timer*.

11. Press ▶ on the mode select dial to start *Interval Timer* flashing.

12. Press ▲ or ▼ on the mode select dial to select the amount of time you want between recordings.

- Select *15S*, *30S*, *1min*, or *5min* to set the intervals between recording to 15 seconds, 30 seconds, one minute, or five minutes.
- Select *OFF* to turn off the *Interval Timer*.

Recording

- Press ◀ to stop *Interval Timer* flashing.
- Press *MENU* to exit the menu. ▶ and the amount of recording time, and ⌚ and the amount of interval time appear in the viewfinder.

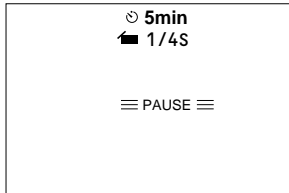

- Press the thumb trigger to start recording.

Notes: The camcorder will start and stop recording the selected amount of time.

The tally light flashes with the flash speed increasing five seconds before recording begins.

Time-Lapse Recording — Using the Remote

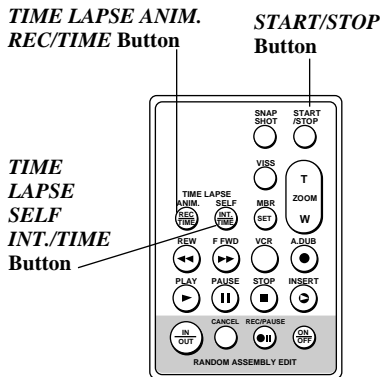

Model CC639's Remote

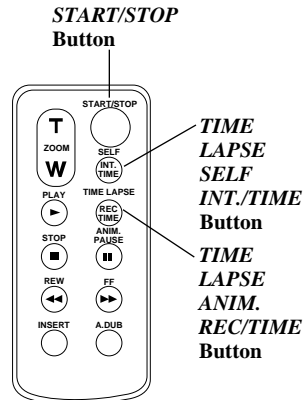

Model CC638's Remote

- Place the *POWER* dial on the camcorder in *CAMERA*. The power indicator will light.
- Press the *TIME LAPSE ANIM. REC/TIME* button. ▶ and the amount of recording time appear in the viewfinder.
- Press the *TIME LAPSE SELF INT./TIME* button. ⌚ and the interval time appear in the viewfinder.
- Press the *START/STOP* button to start recording.

Recording

Fading or Wiping In and Out

You can add a professional touch to your recordings when you use the fade or wipe features. The picture gradually appears on a black or white screen and disappears leaving a black or white screen. The speed of the fade or wipe is automatically controlled by the camcorder.

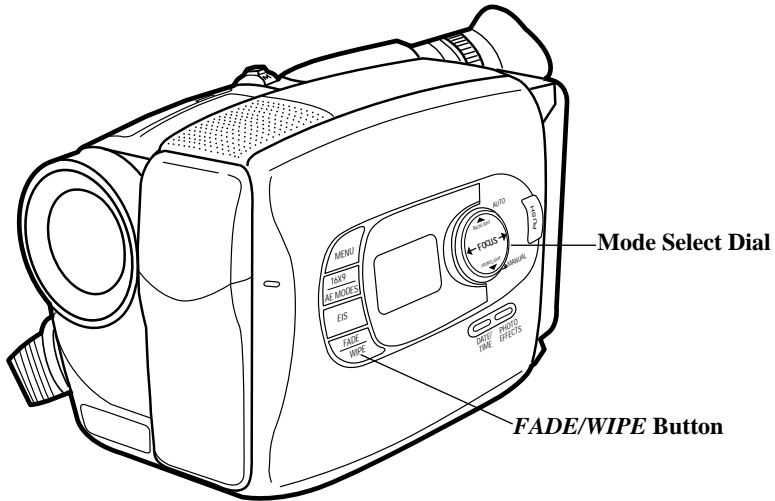

To Fade or Wipe

1. Place the *POWER* dial in *CAMERA*.
The power indicator will light.
2. Place mode select dial in *AUTO* or *MANUAL*.

- **Mode Select Dial in *AUTO***

Press the *FADE/WIPE* button to turn the black fader on or off.

[Bk] appears in the viewfinder.

Note: This is the only fade you can use in *AUTO*.

- **Mode Select Dial in *MANUAL***

Press the *FADE/WIPE* button to display the fade/wipe menu.

OFF		
1	[Bk]	Black Fader
2	[C]	Blue Fader
3	[M]	Mosaic Fader
4	[D]	Door Wipe
5	[S]	Scroll Wipe
6	[W]	Window Wipe
7	[P]	Dissolve
8	--	Auto Select

Note: The fade/wipe menu will not appear if the *Shift Zoom* magnification feature on the recording menu is turned on.

Recording

- Press *FADE/WIPE* to highlight the fade or wipe you want to select.

Note: The fade or wipe you select is automatically activated and the fade/wipe menu is removed from the viewfinder in approximately two seconds.









- Press the thumb trigger to start recording and fade or wipe in.

Note: If you select a fade or wipe during recording, press the thumb trigger to fade or wipe out.

To Turn Off Fade or Wipe

Press *FADE/WIPE* to highlight *OFF*.

Note: The fade or wipe will be turned off and the menu will automatically be removed from the viewfinder in approximately two seconds.

Indicator	Menu	Function
	<i>Black Fader</i>	Fades in or out on a black screen.
	<i>Blue Fader</i>	Fades in or out on a blue screen.
	<i>Mosaic Fader</i>	Fades in or out with a full screen mosaic effect.
	<i>Door Wipe</i>	Wipes in from a black screen opening to the sides. Wipes out from the center towards the sides leaving a black screen.
	<i>Scroll Wipe</i>	Wipes in from a black screen from the bottom to the top. Wipes out from the top to the bottom leaving a black screen.
	<i>Window Wipe</i>	Wipes in from a black screen from the center out to the corners. Wipes out from the corners toward the center leaving a black screen.
	<i>Dissolve*</i>	New scene gradually appears as the old one dissolves. You must stop and start recording within five minutes.
	<i>Auto Select*</i>	The camcorder automatically selects one of 6 wipes when you start recording.

* The *Dissolve* and *Auto Select* modes require a previous scene stored in memory. The indicator for the mode selected will flash in the viewfinder if there is no stored image. You must stop and start recording within five minutes without turning off the camcorder's power or the stored scene will be erased. The sound for the last recorded scene is not stored in memory.

Recording

Production Effects

You can add a professional touch to your recordings when you use some of the production effects while recording.

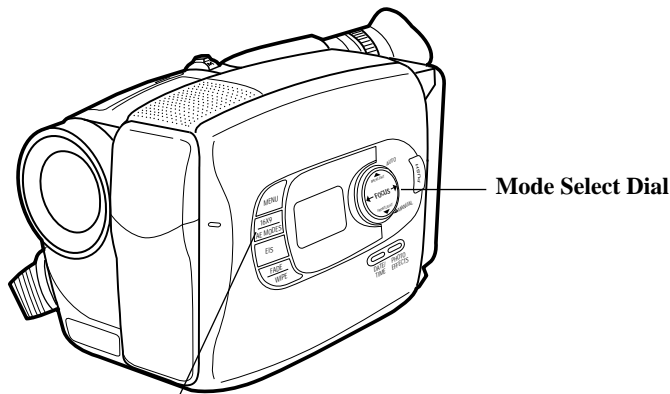

16X9/AE MODES Button

To Use a Production Effect

1. Place the *POWER* dial in *CAMERA*.
The power indicator will light.
2. Place mode select dial in *AUTO* or *MANUAL*.

- **Mode Select Dial in *AUTO***

Press the *16X9/AE MODES* button to turn the *Cinema* mode on or off.

appears in the viewfinder.

Note: This is the only production effect you can use in *AUTO*.

- **Mode Select Dial in *MANUAL***

Press the *16X9/AE MODES* button to display the production effect menu.

OFF	
1	<input type="checkbox"/> Cinema
2	<input type="checkbox"/> Sepia
3	<input type="checkbox"/> Sports
4	<input type="checkbox"/> Back-Lit
5	<input type="checkbox"/> Front-Lit
6	<input type="checkbox"/> Classic Film
7	<input type="checkbox"/> Strobe
8	<input type="checkbox"/> Slow Shutter

Note: The production effects are described on the next page.

3. Press *16X9/AE MODES* to highlight the effect you want to select.

Note: The effect you select is automatically activated and the menu is removed from the viewfinder in approximately two seconds.

4. Press the thumb trigger to start recording with the effect you selected.

Notes: When *Sepia* or *Classic Film* effects are activated, pressing *MAN.W.BAL* has no effect.

When *Slow Shutter* is activated, auto focus may not function properly.

When *Slow Shutter* is activated, bright spots may appear on the screen.









Certain effects cannot be used together with other functions. When an effect not suitable in the current situation is selected, its indicator flashes in the viewfinder.

Recording

To Turn Off a Production Effect

Press **16X9/AE MODES** to highlight **OFF**.

Note: The effect will be turned off and the menu will automatically be removed from the viewfinder in approximately two seconds.

Indicator	Menu	Function
	<i>Cinema</i>	The camcorder records black bars at the top and bottom of the picture to produce the wide-screen effect. This is also known as “letter box” recording. Use when you play back your recordings on a 16X9 TV.
	<i>Sepia</i>	Gives your recording a brownish tint like old photos. Combine with cinema mode for a classic look.
	<i>Sports</i>	Use to clearly capture fast-moving action with less blurring. Use when playing back the recording on a VCR featuring special effects, such as pause or slow motion.
	<i>Back-Lit</i>	Use when the subjects are in front of a window or with the sun to their back. Compensates for subjects appearing too dark because of backlighting.
	<i>Front-Lit</i>	Use when there is a strong front light on the subject such as spotlights. Compensates for subjects appearing too light because of strong front lighting.
	<i>Classic Film</i>	Faster strobe images in black-and-white that offer the vintage look of a film being shown on a movie projector. Use it with cinema mode to add an authentic movie theater look.
	<i>Strobe</i>	Your recording looks like a series of snapshots.
	<i>Slow Shutter</i>	Light sensitivity lets you light dark subjects or areas brighter than they would be under good natural lighting. Use only in dark areas. Your picture takes on a strobe-like effect. If the image is out of focus, adjust the focus manually. The manual focus indicator may flash. Use a tripod for better stability.

Recording

Audio Dubbing (Remote Only)

Audio dubbing lets you record new sound (audio) in place of previously recorded audio.

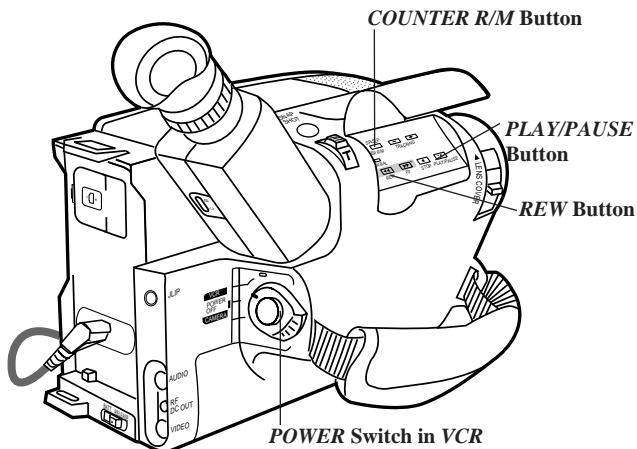

To Audio Dub

1. Place the tape with safety tab intact into the camcorder.
2. Place *POWER* switch in *VCR*.
3. Locate the place you want the audio dubbing to stop and press *PLAY/PAUSE* (*PAUSE* on remote).
4. Press *COUNTER R/M* for more than two seconds on the camcorder to set the time counter back to 0:00:00.
5. Press *COUNTER R/M* again for less than one second to turn on memory stop (*M*).
6. Press *REW*, locate the place you want audio dubbing to begin, and press *PLAY/PAUSE* (*PAUSE* on remote) exactly at the beginning of the scene.

(continued on next page)

Recording

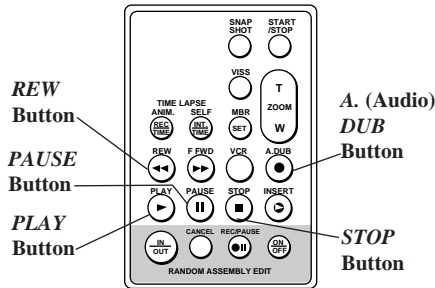

Model CC639's Remote

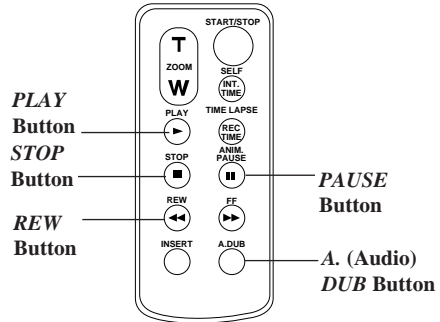

Model CC638's Remote

- Press and hold *A.DUB* while pressing and releasing *PAUSE* on the remote to place the camcorder in audio dub standby.  appears in the viewfinder.



- Press *PLAY* on the remote to start audio dubbing.  appears in the viewfinder.

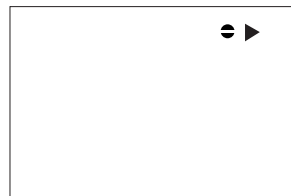

The new audio will be recorded in place of the old audio.

When the counter reading of M 0:00:00 is reached, audio dubbing stops, and the camcorder enters audio dub standby.

- Press *STOP* to end audio dubbing.

Recording

Edit Insert (Remote Only)

Edit insert lets you record new video in place of previously recorded video without replacing the audio.

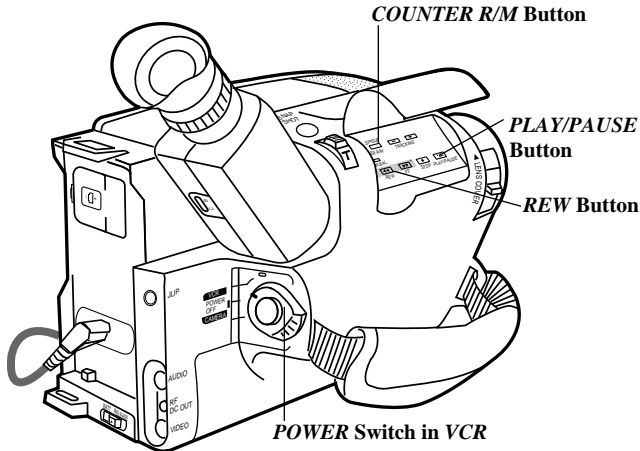

To Edit Insert

1. Place the tape with safety tab intact into the camcorder.
2. Place *POWER* switch in *VCR*.
3. Locate the place you want the edit insert to stop and press *PLAY/PAUSE* (*PAUSE* on remote).
4. Press *COUNTER R/M* for more than two seconds on the camcorder to set the time counter back to 0:00:00.
5. Press *COUNTER R/M* again for less than one second to turn on memory stop (*M*).
6. Press *REW*, locate the place you want edit insert to begin, and press *PLAY/PAUSE* (*PAUSE* on remote) exactly at the beginning of the scene.

(continued on next page)

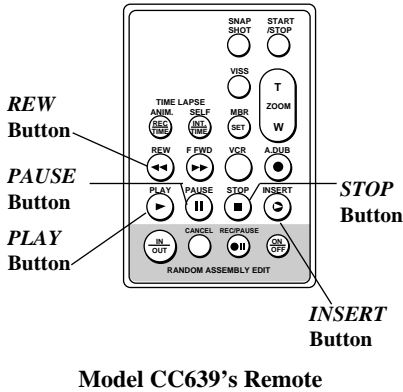

Recording

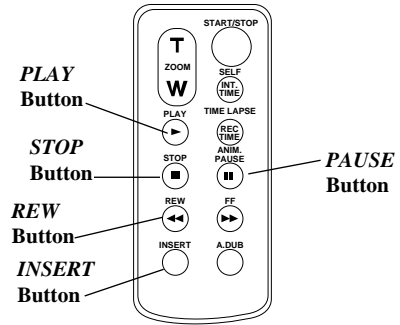

Model CC639's Remote



Model CC638's Remote

- Press and hold *INSERT* while pressing and releasing *PAUSE* on the remote to place the camcorder in edit insert standby.  and  appear in the viewfinder.

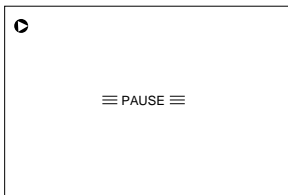

To check your tape positioning, you can press *EDIT SEARCH* – or + on the camcorder.

- Press *START/STOP* on remote (thumb trigger on camcorder) to start edit insert.  appears in the viewfinder. New video is recorded over the previous video. When the counter reading of M 0:00:00 is reached, edit insert stops and the camcorder enters edit standby.

- Press *STOP* to end edit insert.

Notes: The camcorder may stop slightly before or after the edit out point and there may be slight distortion at this point.

If a fade/wipe effect was used during edit insert, wait ten seconds after pressing *STOP* to perform other operations.

Recording

Built-In Color Enhancement Light

The built-in color enhancement light will automatically add more light when needed. The *POWER* switch must be in *CAMERA* to operate the video light.

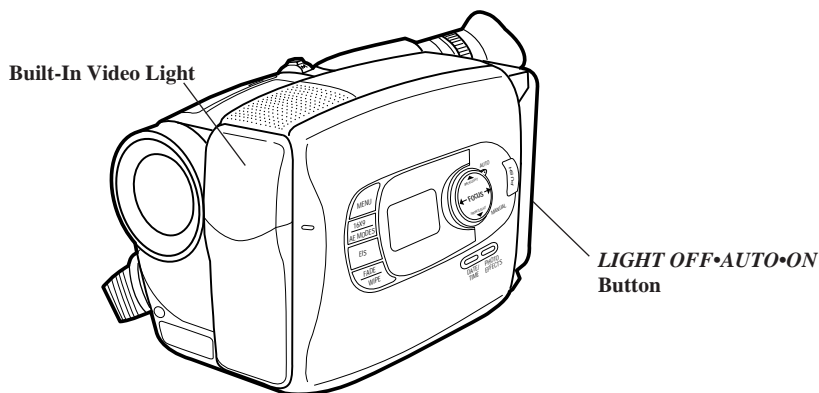

To Use the Light

Set the *LIGHT OFF•AUTO•ON* switch.

- Set to *ON* to turn the light on.
Note: We recommend you set white balance to the indoor mode () when using the light.

- Set to *AUTO* to have the light come on automatically when the camcorder senses there is insufficient light for the best recording.

Notes: If the lighting condition is unstable the light may turn on and off. Set the light to *ON* or *OFF*.

The light may stay on during high speed shutter recording.

- Set to *OFF* to turn the light off. Turn the light off when you are not recording to save battery power.

Note: When the light is turned on, the camcorder may turn off if the battery's power is low even though the battery level indicator is not flashing.

Cautions:

Do not operate the video light closer than one foot to people or other objects.

The video light becomes very hot. Do not touch it during operating or right after using it. Serious injury may result.

Do not place the camcorder in a carrying case right after using the light.

Never operate the video light close to flammable or explosive material.

(continued on next page)

Recording

Replacing the Bulb

We recommend you consult your dealer or Servicenter to replace the bulb. If you replace the bulb, use only part #233430 to replace the entire bulb assembly. Carefully follow the instructions below.

Cautions

The video light and bulb need to cool for approximately 30 minutes after the camcorder has been used before the bulb assembly is replaced.

Do not touch the light bulb with your fingers. If the bulb is accidentally touched, wipe it with a soft cloth. A dirty bulb may cause smoke and have a reduced service life.

To Replace the Bulb Assembly

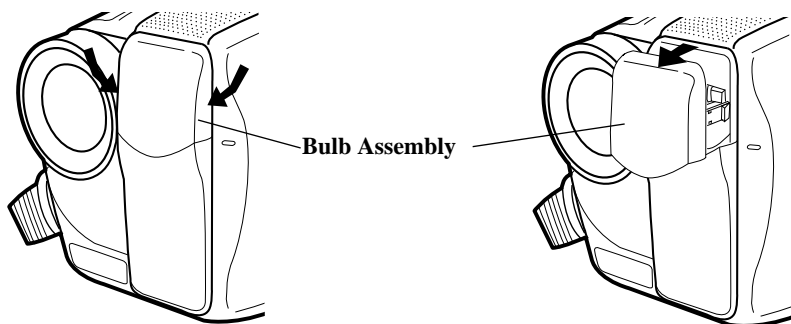

1. Pull on the sides of the bulb assembly and remove it from the camcorder *as shown*.

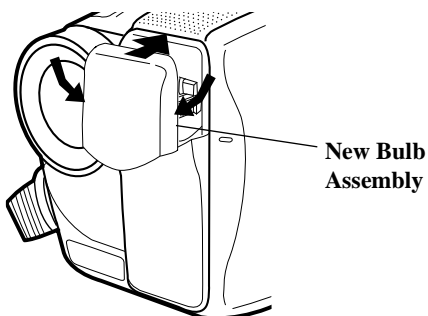

2. Place the the new bulb assembly into the camcorder *as shown*.

Recording

Attaching the Shoulder Strap

The camcorder's shoulder strap is designed to let you carry the camcorder from your shoulder and – when you are ready to shoot – bring the camcorder to shooting position in one quick movement.

To Attach the Shoulder Strap

1. If the strap keeper is over a double section of the strap, slide the strap keeper off the end of the strap. Replace the keeper on the strap between the buckle and the end of the strap as shown.

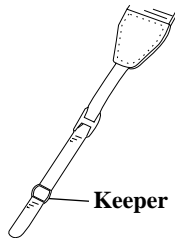

2. Loop the end of the strap over the top of the shoulder strap attachment ring.

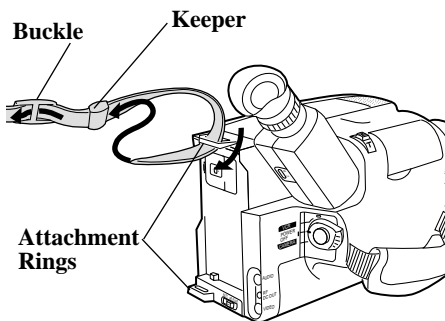

3. Thread the end of the strap back through the keeper and buckle making sure it is threaded **under** the outer strap. Make sure the strap is not twisted.

4. Attach the other end of the strap to the other shoulder strap attachment ring.

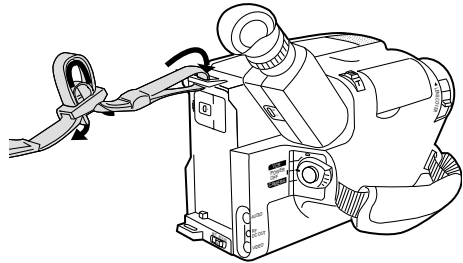

5. Adjust the shoulder strap to the desired length.
6. Slide both keepers up snugly against the shoulder strap attachment rings to prevent the strap from slipping.

Cautions: When carrying the camcorder with the shoulder strap, you may find it convenient to rotate the viewfinder down and slide it to the front. This helps prevent possible damage to the viewfinder from bumping against your body as you move.

Make sure the shoulder strap is firmly attached before using it to carry the camcorder.

Traveling Tips

- Write down your camcorder's serial number and keep it separate from the camcorder when traveling. If your camcorder is lost or stolen, you will be able to identify it.
- Use extra care to avoid damage to your camcorder and accessories when operating them at a beach or pool. Spray, sand, and dust should be avoided. If your lens has been exposed to the elements, clean it only with proper lens cleaning supplies.
- Make sure you have any plug adapters that you may need before taking your camcorder to other countries. Consult your dealer for advice.
- Carry your camcorder in a carrying case when traveling. *See page 92* for a case designed especially for this camcorder. An ordinary suitcase or carry bag does not offer the protection your camcorder needs. Treat your camcorder as carry-on luggage to protect it from rough handling.

Playback

Using the Cassette Adapter

The camcorder uses a smaller size cassette, but records in standard VHS format. The cassette adapter allows you to play your VHS-C cassettes in a VCR just like other standard VHS cassettes.

Insert the VHS-C cassette into the cassette adapter. Insert the cassette adapter into the VHS VCR like a normal VHS cassette.

Install Cassette Adapter's Battery

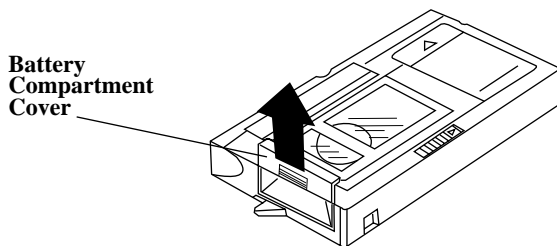

1. Remove battery compartment cover.
2. Install supplied "AA" battery so positive (+) and negative (-) ends align properly with (+) and (-) terminals in battery compartment.
3. Replace battery compartment cover.

Notes: Replace the battery when the load time becomes much longer than normal.

Remove the battery from the cassette adapter if it will not be used for a month or more.

This will prevent possible damage from battery leakage. If leakage occurs, wipe up the liquid inside the compartment and replace the battery with a new one.

Insert Cassette into Cassette Adapter

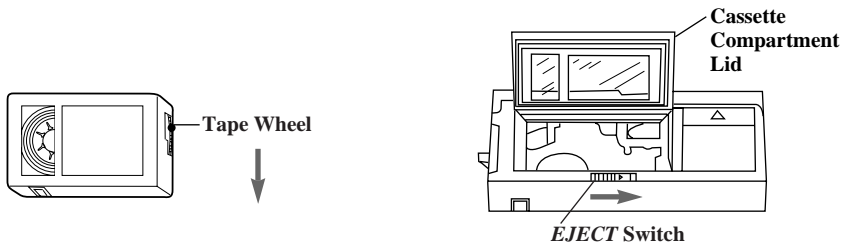

1. Before inserting the cassette into the adapter, remove any slack in the tape by turning the tape wheel on the side of the cassette.
2. Slide *EJECT* to the right to open the cassette compartment lid.

3. Insert the cassette with the tape window on the left and facing up. Allow the cassette to drop into the adapter. **Do not force the cassette.**

(continued on next page)

Playback

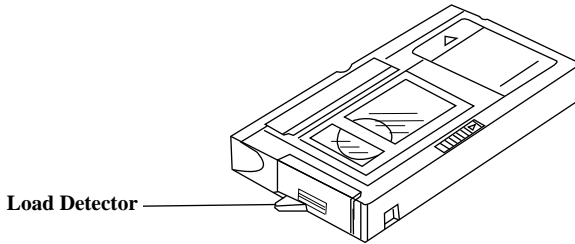

4. Gently close the cassette compartment lid until it locks into place. Make sure the cassette reel area under the adapter is free to turn while the cassette is loading.

Note: You should hear a whirring sound while the tape loads. The adapter's load detector will automatically retract into the adapter.

Caution: If the load detector is still extending from the side of the cassette adapter after you have attempted to load the cassette, loading is not complete. Try to load the cassette again. Attempting to insert the cassette adapter into a VCR with the load detector extending may cause damage to the adapter and/or VCR.

Remove Cassette from Cassette Adapter

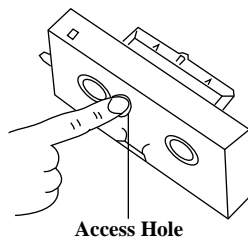

1. Slide the adapter's *EJECT* switch to the right. The load detector will extend from the side and the whirring sound indicates the tape is being released before the adapter's cassette compartment lid opens.
2. Use the access hole on the bottom of the adapter to push the cassette up and remove it from the adapter.
3. Gently close the adapter's cassette compartment lid.

Playback

Viewfinder Playback

Viewfinder playback is the simplest way to watch tapes using the camcorder.

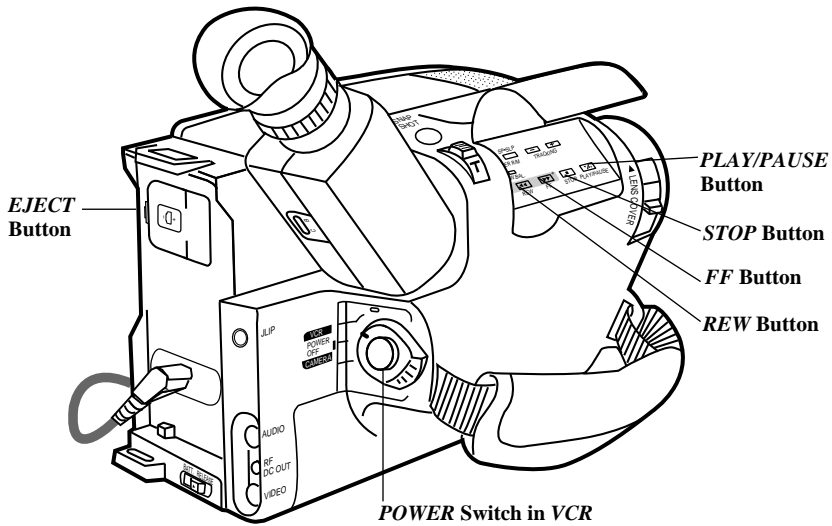

To Play Back a Tape

1. Place *POWER* switch in *VCR*. The power indicator will light.
2. Slide *EJECT* and insert the cassette you want to play back. Close the cassette compartment.
3. Press *PLAY/PAUSE* to begin playback. If necessary, adjust tracking.
4. Press *STOP* when you are finished.

During playback, use the playback features *on the next pages*.

Playback

Playback Features

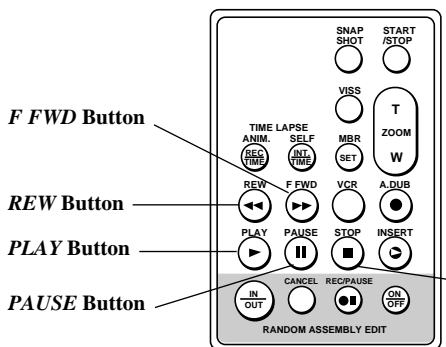

Model CC639's Remote

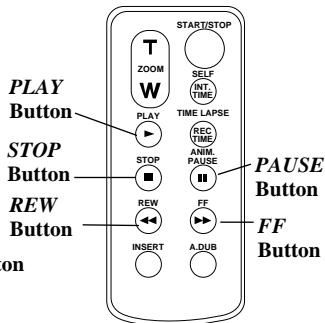

Model CC638's Remote

Visual Searching

- During playback, press and release **FF** (*F FWD* on remote) or **REW** if you want to search the tape visually in forward or reverse.
- Press **PLAY/PAUSE** on the camcorder (or **PLAY** on the remote) to return to normal playback.
- For brief searching, press and hold **FF** (*F FWD* on remote) or **REW** for more than two seconds.
- Release the button to return to normal playback.

Tape Positioning

- Place **POWER** switch in **VCR** and press **STOP**.
- Press and quickly release **REW** or **FF** (*F FWD* on remote) to rewind or fast-forward the tape.
 - Press **STOP** to stop the tape.

Stop-Action Pause

- During playback, press **PLAY/PAUSE** (or **PAUSE** on remote) to “stop the action” and view one frame of the tape.
- Press **PLAY/PAUSE** on the camcorder (or **PLAY** on the remote) to return to normal playback.

Caution: Pause is designed for momentary interruptions and should not be used for an extended period of time. If the camcorder remains in pause for more than five minutes, it will automatically enter the stop mode and then turn off to prevent excessive tape wear.

Playback

Playback Features (Continued)

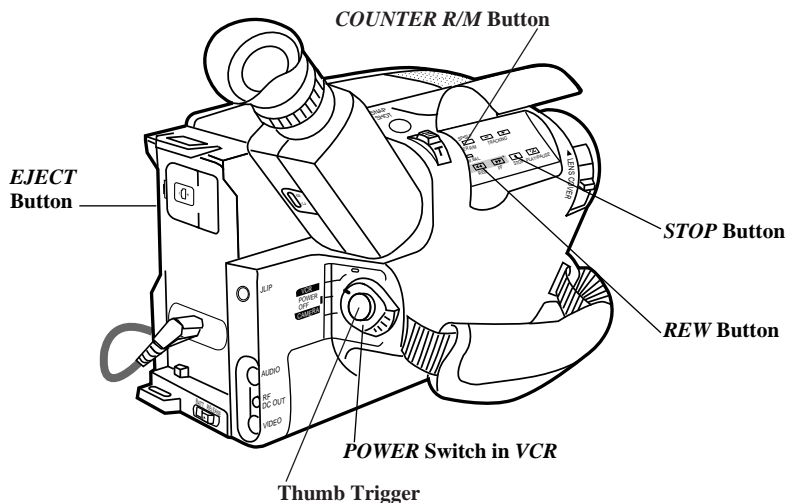

Time Counter

The time-counter display shows the actual time elapsed when playing back a segment of tape. The memory-stop feature helps locate a certain point on the tape. When memory stop is on, the tape will stop automatically during rewind or fast forward when the time counter reaches *M 0:00:00*.

To Use the Memory-Stop Feature

1. Locate the place on the tape you want to return to, place the *POWER* switch in *VCR*, and press *COUNTER R/M* for more than two seconds to reset the counter to 0:00:00.
2. Continue to play the tape. When you want to return to the place you marked, press the *STOP* button.
3. Press *REW*. The tape will rewind to the time counter reading of *M 0:00:00*.

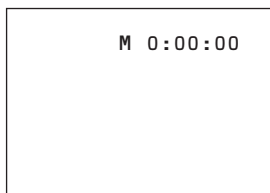

**Time Counter With
Memory Stop Turned On**

Playback

Playback Features (Continued)

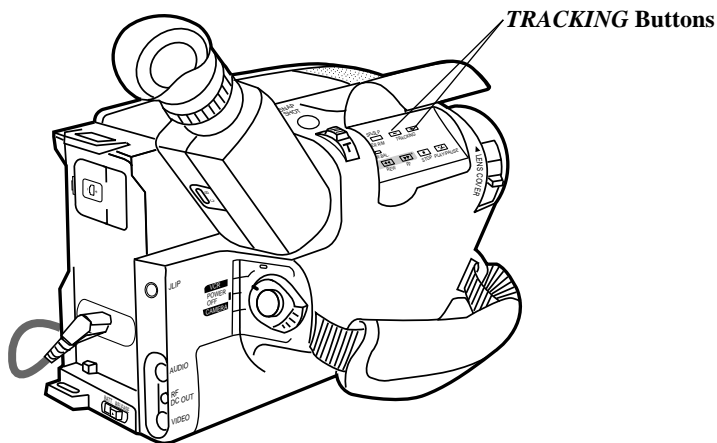

Tracking

During playback, streaks may appear in the playback picture. Press either *TRACKING* button to move the streaks up or down and out of the picture.

- During stop-action playback, pressing one *TRACKING* button may reduce picture “jitter” (picture bouncing up and down). Some “jitter” is normal.

Simultaneously press both *TRACKING* buttons to return tracking to its preset center.

Note: The *TRACKING* buttons may have no effect on tapes recorded on other camcorders or VCRs.

Playback

Playback on TV (or VCR) with *AUDIO/VIDEO IN* Jacks

To connect your camcorder to a TV monitor (or VCR) with *AUDIO/VIDEO IN* jacks, you will need an optional audio/video cable such as VH83 shown on page 94.

If your TV is already connected to a VCR, you can attach the camcorder to the VCR and watch what the camcorder is recording or playing on the TV.

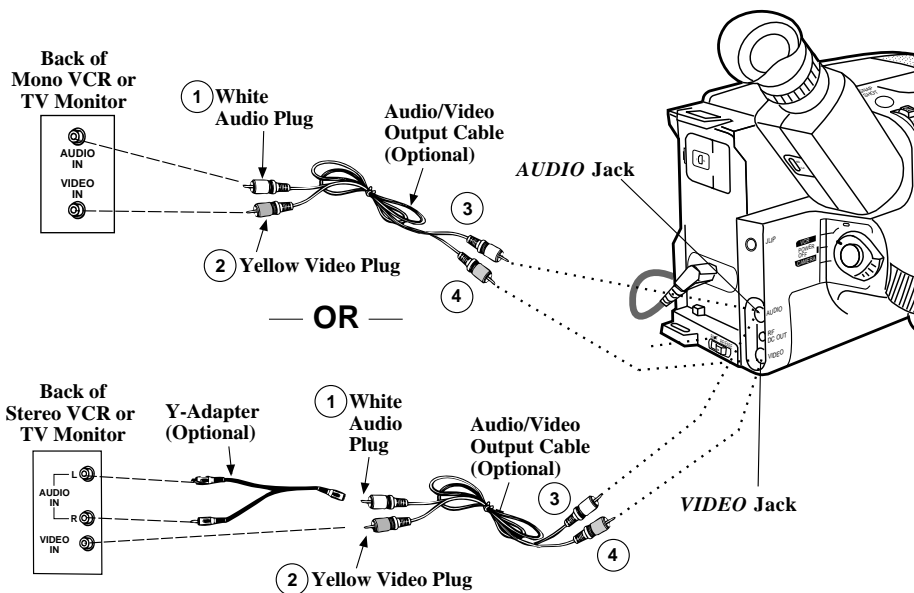

Installation

- ① Attach the white plug on one end of the audio/video cable to the *AUDIO IN* jack on the TV (or VCR).
- ② Attach the yellow plug to the *VIDEO IN* jack on the TV (or VCR).
- ③ Attach the white plug on the other end of the audio/video cable to the *AUDIO* jack (located under the small cover) on the back of the camcorder.
- ④ Attach the yellow plug to the yellow *VIDEO* jack on the camcorder.

Notes: If your cable does not have white and yellow plugs, just be sure to attach the same color to the audio jacks.

If your TV (or VCR) has stereo *AUDIO IN* jacks, attach the plug to the one labeled *MONO*. If one is not labeled *MONO*, you may need a Y-adaptor, such as AH25, shown on page 94 to hear both channels.

Playback

Playback Operation and How to Copy Tapes on the VCR

1. A. Camcorder connected directly to TV: Turn on the TV and tune it to the video input channel.
B. Camcorder connected to VCR that is already connected to TV: Turn on VCR and place it in the “line” or “camera mode”. (If your VCR does not have a “line” or “camera mode”, consult the VCR owner’s manual.) Operate the TV as you normally do to see the signal coming from the VCR.
2. Place the *POWER* switch in *VCR* to turn on the camcorder. The power indicator will light.
3. Press *PLAY/PAUSE*.
 - If noise bars appear on the screen, press *TRACKING* – or +.
- During playback, use the playback features *on pages 81-82*.
4. To copy what the camcorder is playing, place a blank cassette in the VCR, and press the VCR’s *RECORD* button.
Notes: Press *EDIT* to start camcorder playback when copying tapes to improve picture reproduction.
Make sure the memory-stop feature is turned off (press *COUNTER R/M*) or the camcorder will enter play pause when the counter reaches *M 0:00:00*.
5. Press *STOP* when you are finished.

Caution: The unauthorized recording of copyrighted material may infringe the rights of others.

Viewing What the Camcorder is Seeing (or Recording)

1. A. Camcorder connected directly to TV: Turn on the TV, and tune it to the video input channel.
B. Camcorder connected to VCR that is already connected to TV: Turn on VCR and place it in the “line” or “camera mode”. (If your VCR does not have a “line” or “camera mode”, consult the VCR owner’s manual.) Operate the TV as you normally do to see the signal coming from the VCR.
2. Place the *POWER* switch in *CAMERA*.
Note: When the camcorder is used as a camera, turn the TV’s volume down to prevent a high-pitched squeal caused by feedback.
3. Press the thumb trigger to begin recording. You can watch what the camcorder is seeing (or recording) on the TV screen.

Note: The remote control will operate the camcorder.

Playback

Model CC639 Only: Programming Remote to Operate Compatible VCR

The CC639's remote can be programmed to operate the camcorder and the basic functions of a compatible VCR for easy tape editing. After the remote has been programmed, you can control the VCR by pressing and holding *VCR* while pressing one of the function buttons (*REW*, *F FWD*, *STOP*, *PAUSE*, or *PLAY*).

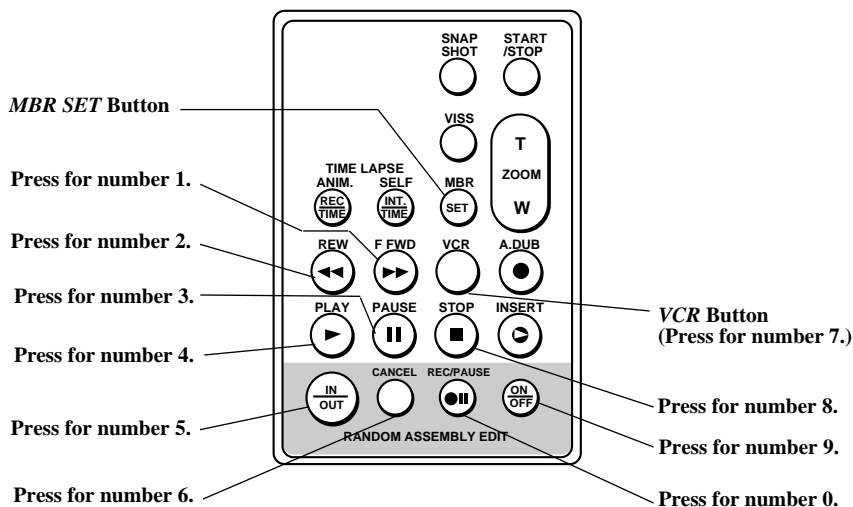

Remote Control

Playback

Refer to the chart below to find the code numbers that correspond to your brand of VCR. Try each two-digit code number separately until you find the correct one. Press the buttons on the remote corresponding to the code numbers.

1. Turn on the VCR.
2. Make sure the lithium cell is installed in the remote. The remote will need to be reprogrammed when you change the lithium cell.
3. Press and hold *MBR SET* while pressing two digits for the code. Then release *MBR SET*.
4. Test the code number by pressing and holding *VCR* while pressing one of the function buttons (*REW*, *F FWD*, *STOP*, *PAUSE*, or *PLAY*). If the VCR does not perform the function, repeat step 3 with another code number.

Chart of VCR Code Numbers

VCR Brand *	Code(s)
RCA	02, 04, 09, 87, 88
GE	02, 04, 09, 22
JVC	01, 07, 08
Magnavox	03, 22, 52, 58
Zenith	28
Panasonic	04, 22, 25, 28, 27
Sharp	23, 29
Toshiba	80, 82
Hitachi	87, 88
Mitsubishi	85, 86
Akai	81, 84
Sony	70, 72, 83, 89
Sanyo	50, 73, 78, 79
NEC	75, 76

* The remote may not be able to control every model VCR of the brands listed.

Playback

Model CC639 Only: Copying Tapes Using Programmable Synchro Edit

You can program the camcorder with up to eight segments of a prerecorded tape. The camcorder will automatically copy these segments on a compatible VCR.

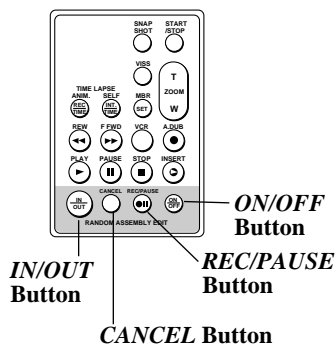

1. Connect the camcorder to a VCR as shown on pages 84-85 .
2. Insert the prerecorded tape in the camcorder. Place the *POWER* switch in VCR.
3. Turn on VCR and place it in the “line” or “camera mode”. (If your VCR does not have a “line” or “camera mode”, consult the VCR owner’s manual.) Operate the TV as you normally do to see the signal coming from the VCR.
4. Playback the pre-recorded tape and then, press *RANDOM EDIT* on the camcorder or *ON/OFF* on remote. The edit screen will appear in the viewfinder.

	IN	OUT
1	---	---
2		
3		
4		
5		
6		
7		
8		
COUNTER	0:00:00	
TOTAL	0:00:00	

Display in Viewfinder

5. Locate the beginning of the first segment you want to program. The edit screen appears on the TV.
6. Press *IN/OUT* to enter the time counter reading in the display.
7. Locate the end of the segment, and press *IN/OUT* to enter the time counter reading in the display.
8. Repeat steps 5-7 to enter each segment (up to eight). *TOTAL* shows recording time for all the segments.

	IN	OUT
1	0:10:00	0:12:30
2	0:22:00	0:25:00
3	---	---
4		
5		
6		
7		
8		
COUNTER	0:25:00	
TOTAL	0:05:30	

Display in Viewfinder and on TV Screen

9. Press *CANCEL* to erase the last *IN* or *OUT* point. Each press will erase the last entry.
10. Connect one end of the edit cable (supplied) to the *JLIP* jack on the camcorder and the other end to the VCR or remote.
 - If the VCR has a 3.5 mm *EDIT*, *EDIT IN*, *EDIT IN/OUT*, *SYNC*, or *PAUSE* jack, attach the small plug to the jack.

Note: If the VCR’s jack is not 3.5 mm, you will need an adapter.
 - If the VCR does not have a small jack, attach the plug on the other end

Playback

Copying Tapes Using Programmable Synchro Edit

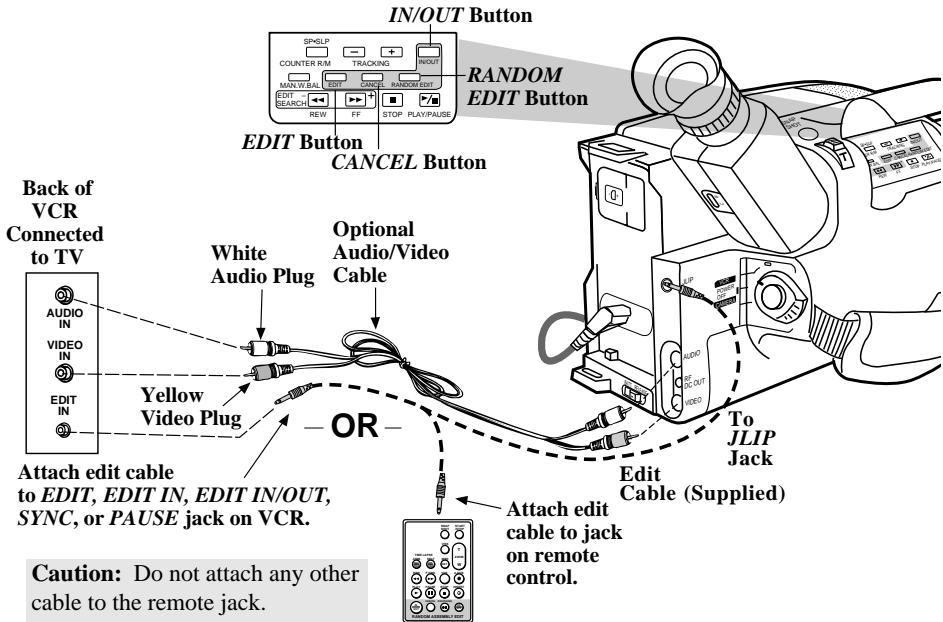

- of the edit cable to the small jack on the remote.
11. Point the remote at the VCR's remote sensor and press *REC/PAUSE*. The VCR will enter record pause. If the VCR does not enter record pause, place it in record pause using the VCR's controls.

Note: The remote must be programmed for your brand of VCR as shown on pages 86-87.

12. Press *EDIT* on the camcorder. The programmed scenes will be copied.

Notes: Keep the remote aimed at the VCR's remote sensor.

The display will be superimposed on the TV screen while the camcorder searches forward for the next scene.

13. After all the programmed scenes have been copied, the camcorder will enter play pause, and the VCR will enter record pause. Press *STOP* on the camcorder and VCR to end programmable synchro edit.

Notes: To copy the tape from a specified location to the end, just enter one *IN* point. The camcorder will copy everything from that point to the end of the tape.

A segment must be over one second in length and have at least 15 seconds of recording before it on the tape.

Search time between segments cannot be over five minutes.

IN and *OUT* points cannot be blank portions of tape.

To ensure correct operation, leave at least 15 seconds open between scenes.

Playback

Playback on a TV Without Audio/Video Inputs

To connect your camcorder to a TV without audio/video inputs, you will need an optional 1CVA147C RF output adapter and an optional coaxial RF cable, such as VH82 or VH90 shown on page 94. If your TV has *AUDIO* and *VIDEO IN* jacks (or is connected to a VCR), refer to pages 84-85.

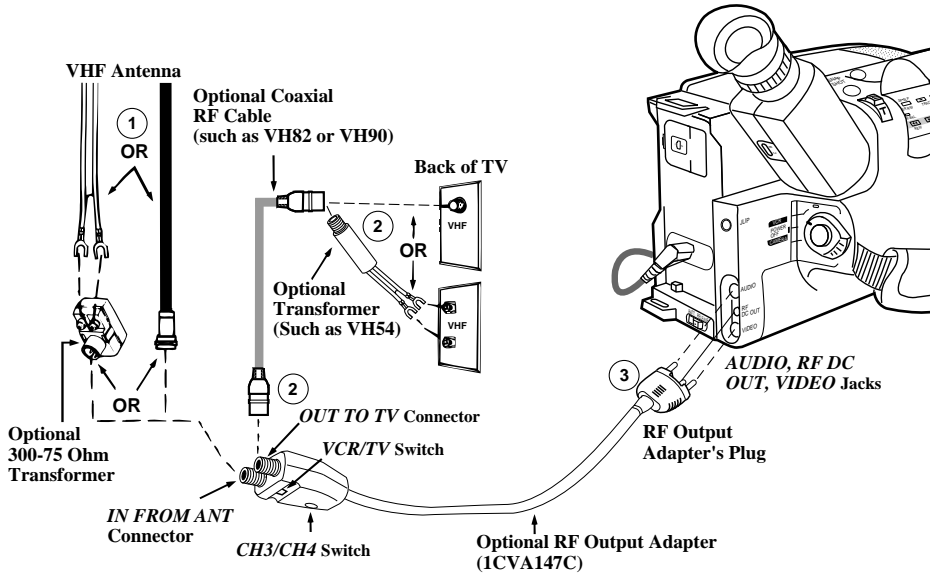

Installation

- 1 Disconnect the VHF antenna from your TV. Connect the antenna to the *IN FROM ANT* connector on the RF output adapter if you are going to leave the adapter connected to the TV.

Note: If your VHF antenna is the flat twin-lead type attached by two screws, you will also need an optional 300/75 ohm transformer.

- 2 Attach one end of the optional coaxial RF cable to the *OUT TO TV* connector on the adapter, and attach the other end to the VHF input on your TV as shown.

Note: If your TV has 300 ohm screw terminals, you will need a 75/300 ohm transformer, such as VH54, shown on page 94.

- 3 Attach the RF output adapter's plug to the *AUDIO, RF DC OUT, and VIDEO* jacks located under the small cover on the back of the camcorder.

Playback

Playback Operation

1. Set the *CH3/CH4* switch on the RF output adapter to channel 3 or 4.
2. Turn on the TV, and tune it to the same channel you selected with the RF output adapter's *CH3/CH4* switch.
3. Place adapter's *VCR/TV* switch in *VCR*.
4. Place *POWER* in *VCR*. Power indicator will light.
5. Press *PLAY/PAUSE* on the camcorder.
 - During playback, use the playback features *described on pages 81-82*.
 - If noise bars appear on the screen, adjust tracking *as described on page 83*.
6. Press *STOP* on the camcorder when you are finished.

Viewing What the Camcorder Is Recording

1. Turn on the TV and tune it to channel 3 or 4. When the camcorder is used as a camera, turn the TV's volume down to prevent a high-pitched squeal caused by feedback.
2. Set the *CH3/CH4* switch on the RF output adapter to the same channel you selected on the TV.
3. Place adapter's *VCR/TV* switch in *VCR*.
4. Place *POWER* in *CAMERA*. Power indicator will light.
5. Press the thumb trigger to begin recording. You can watch what the camcorder is seeing (or recording) on the TV screen.

Note: The remote will also operate the camcorder.

Normal TV Viewing

For normal TV viewing, you may leave the RF output adapter hooked up to the TV. Disconnect the adapter's plug from

the camcorder and place the adapter's *VCR/TV* switch in *TV*.

Note to Cable TV Installer

This reminder is provided to call your attention to Article 820-40 of the National Electrical Code (Section 54 of Canadian Electrical Code, Part I), that provides guidelines for proper grounding and, in particular, specifies that the cable ground shall be connected to the grounding system of the building as close to the point of cable entry as practical.

Optional Accessories

We invite you to take a look at some great ideas for sparking creativity and adding to the fun of using your compact VHS camcorder. The following pages have a selection of accessories to help make your memorable moments look and sound even better.

These accessories are designed to make the process of recording and watching your videos more enjoyable.

To order accessories, contact your local Dealer.

If a dealer is not nearby, all accessories are available through toll-free ordering or by using the order form *on page 95*.

AC201A Soft Carrying Case

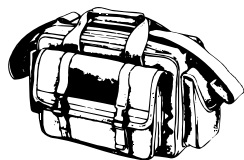

Custom compact soft case designed especially to provide protection and utility for your compact VHS camcorder and most accessories. Rugged fabric lined with soft non-abrasive material and generous padding. Has three outside pockets with storage for lens filters, adapters, batteries, and tapes.

DCC08 Car Cord Adapter

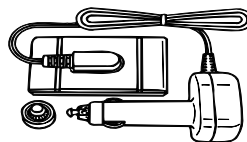

Do not use any other car cord with this camcorder.

This car cord adapter enables you to operate your camcorder from your car, truck, or RV by plugging the car cord directly into the vehicle's cigarette lighter socket. The DCC08 is designed specifically to convert power from a 12-volt battery to a 6-volt output.

Optional Accessories

FB1260 and FB120 Rechargeable Batteries

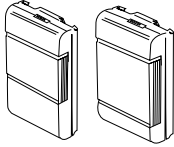

These rechargeable nickel-cadmium batteries are designed specifically for long life. The FB1260 is the same battery that came packed with your camcorder. The FB120 powers your camcorder twice as long as the FB1260 (with video light off – depending on how much you use zoom and pause). Both can be recharged with the AC adapter/charger that came with your camcorder.

CPS91 AC Battery Charger

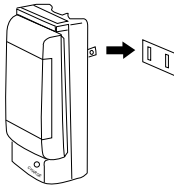

The CPS91 battery charger plugs directly into an AC outlet and charges the FB1260 and FB120 camcorder batteries. Because the CPS91 operates on 100-240 Volts, 50/60 Hz, it can be used virtually anywhere in the world. A plug adapter may be required in some countries. Charging takes approximately seven hours for the FB1260 (1-hour battery) and 13 hours for the FB120 (2-hour battery).

All specifications and descriptions of accessories are subject to change without notice.

Using the Optional AC088 Tripod

Mounting the camcorder on a tripod, such as AC088, will keep the camcorder steady and produce excellent video results.

This tripod's fluid-effect head provides smooth camera pan and tilt. The quick-release mount makes it easy to attach or remove the camcorder. The grooved, tubular 3-section leg design folds down to 26" when not in use. Rubber feet allow for sure footing.

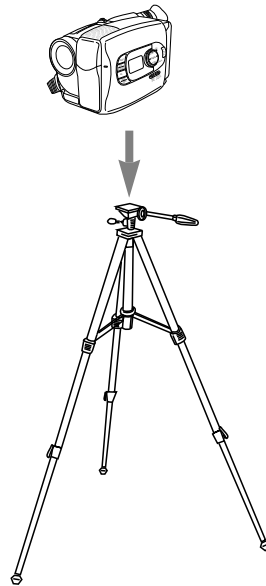

Cautions: Before using a tripod, make sure it is stable enough to hold the camcorder without falling over. Do not transport the camcorder attached to the tripod.

When attaching your camcorder to a tripod, be careful not to force the tripod screw into the camcorder's tripod mounting hole.

The tripod screw should not protrude into the camcorder more than approximately three-eighths (3/8) inch. Forcing the screw could damage the mounting hole on the bottom of the camcorder.

Optional Accessories

1CVA147C RF Output Adapter

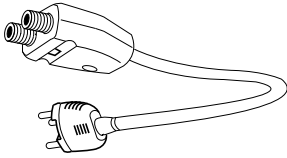

This RF output adapter is used with a coaxial RF cable, such as VH82 or VH90, to connect your camcorder to a standard TV (one without audio/video inputs) for playback. If your antenna cable is the flat twin-lead type attached by two screws, you will also need a 300-to-75 ohm transformer. If your TV has 300 ohm antenna screw terminals, you will need an optional 75-to-300 ohm transformer such as VH54.

Coaxial RF Cables

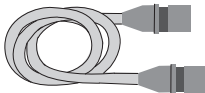

VH82 (6-ft)
VH90 (12-ft)

These RF cables are used with the RF output adapter to connect your camcorder to a standard TV (one without audio/video input jacks) for playback. If your TV has 300 ohm antenna screw terminals, you will need an optional 75-to-300 ohm transformer such as VH54. If your antenna cable is the flat twin-lead type attached by two screws, you will also need an optional 300-to-75 ohm transformer.

VH54 Cable Transformer

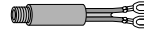

This 75-to-300 ohm transformer is used to connect a standard 75-ohm antenna cable (such as VH82 or VH90) to the 300 ohm screw terminals on a TV.

VH83 Audio/Video Cable

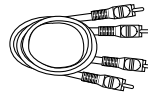

This six foot audio/video dubbing cable can be used for copying tapes from the camcorder to another VCR or camcorder.

AH25 Y-Adapter



This Y-adapter allows you to connect your camcorder's mono audio cable to a stereo TV or VCR.

All specifications and descriptions of accessories are subject to change without notice.

Accessory Order Form

Order Form for Camcorder Model CC638/CC639

Description	Part No.	Price	Qty.	Total
Super Lightweight Tripod	AC088	\$ 39.95		
Soft Camcorder Case	AC201A	\$ 39.95		
Shoulder Strap	ACS091	\$ 12.95		
Y-Adapter	AH25	\$ 2.95		
AC Battery Charger	CPS91	\$ 59.95		
Car Cord Adapter	DCC08	\$ 89.95		
Rechargeable Battery (Extended)	FB120	\$ 89.95		
Rechargeable Battery (Standard)	FB1260	\$ 49.95		
75-300 Cable Transformer	VH54	\$ 2.95		
Coaxial RF Cable	VH82	\$ 6.95		
Audio/Video Cable	VH83	\$ 5.95		
Coaxial RF Cable	VH90	\$ 7.95		
RF Output Adapter	1CVA147C	\$ 59.95		
Model CC638: Remote Control	221125	\$ 39.95		
Model CC639: Remote Control	221337	\$ 49.95		
AC Adapter/Charger and DC Cable	221400	\$ 96.45		
	233087	\$ 24.95		
Cassette Adapter	232845	\$ 49.95		
Model CC639: Edit Cable	233088	\$ 13.95		
Bulb Assembly	233430	\$ 44.95		

Prices are subject to change without notice.

Total Merchandise.....\$ _____

Sales Tax\$ _____

We are required by law to collect the appropriate sales tax for each individual state, county, and locality to which the merchandise is being sent.

Shipping and Handling.....\$ **5.00**

Total Amount Enclosed\$ _____

Use VISA, MasterCard, or Discover.
Money order or check must be in U.S.
currency only. No COD or cash.

Detach Here



Please complete other side also

Accessory Order Form

Charge your order on your VISA,
MasterCard, or Discover Card by
filling in below

USE YOUR CREDIT CARD



IMPORTANT: Copy complete account number
from your VISA card

My card expires:



IMPORTANT: Copy complete account number
from your MasterCard

Copy Number
above your
name on
MasterCard

My card
expires:



IMPORTANT: Copy complete account number
from your Discover Card

My card expires:

AUTHORIZED SIGNATURE

Prices are subject to change without notice.

Print or type your name and
address clearly. This will be
your mailing label.



A complete and correct
order will save you days
of waiting.

Name: _____

Street: _____

_____ Apt: _____

City: _____

State: _____ Zip: _____

Please make sure that both sides of this form
have been filled out completely.

- Allow 4 weeks for delivery.
- All accessories are subject to availability.

Detach Here

Accessory Order Form

To order accessories, contact your local Dealer.

If a dealer is not nearby, you can also follow the directions below to order by telephone or direct-by-mail.

United States and Canada Orders

To place your order by phone, have your Visa, MasterCard, or Discover card ready and call the toll-free number listed below between 8AM and 8PM (EST) Monday through Friday or between 9AM and 5PM (EST) Saturday.

Use this number only to place an order for accessory items listed on this order form.

1 – 800 – 338 – 0376

To place your order by mail, detach and mail the completed order form with credit card information, money order, or check in U.S. currency (made payable to Thomson Consumer Electronics, Inc.) to the following address:

Video Accessories
PO Box 8419
Ronks, PA 17573

Trouble Checks

Troubles sometimes are caused by simple “faults” that you can easily correct without the help of a service technician by first checking a few basic remedies.

Before you call or take your camcorder to an Authorized RCA Camcorder Servicenter, look below for the type of trouble you are experiencing. Then perform the simple checks and adjustments listed for that trouble.

If service should be necessary, the warranty information lists what your warranty covers and explains how to get service.



Trouble	Checks and Adjustments
No power	<ul style="list-style-type: none"> • Place the <i>POWER</i> switch in <i>CAMERA</i> or <i>VCR</i> to turn on the camcorder. The power indicator will light. • If using battery, it may need to be recharged. • If using AC adapter/charger, make sure it is plugged into a working outlet.
Won't record or playback	<ul style="list-style-type: none"> • If using AC adapter/charger, make sure it is plugged into a working outlet. • If the dew indicator () flashes in the viewfinder, there is moisture in the camcorder. Wait until the dew indicator no longer appears before operating the camcorder. • Make sure <i>POWER</i> switch is in correct position for desired operation. • There may not be a cassette in the camcorder. • Try ejecting and reinserting the cassette. • The cassette tape may be broken, try another cassette. • You may have reached the end of the cassette, try rewinding it.
Won't playback	<ul style="list-style-type: none"> • <i>POWER</i> switch must be in <i>VCR</i> position.
Won't record	<ul style="list-style-type: none"> • Safety tab has been removed or closed. (See page 24.) • <i>POWER</i> switch must be in <i>CAMERA</i>.
No picture	<ul style="list-style-type: none"> • Open lens cover.
Camcorder turns itself off	<ul style="list-style-type: none"> • Place <i>POWER</i> switch to <i>OFF</i> and then <i>CAMERA</i> or <i>VCR</i> to turn back on. If camcorder is left in record pause or play pause for several minutes, it will turn itself off to prevent tape wear.

Trouble Checks

Trouble	Checks and Adjustments
Camcorder does not respond to remote control	<ul style="list-style-type: none"> • Aim remote at camcorder's remote control sensor. • Remote's lithium cell battery may be installed incorrectly. <i>See pages 17 and 22.</i> • Remote control's lithium cell battery may need replacing. • Remote control sensor on camcorder exposed to direct sunlight or strong artificial light.
Tape stops during rewind or fast forward	<ul style="list-style-type: none"> • Time-counter memory may be on. Whenever an "M" appears with the time-counter display, the camcorder will stop rewinding (or fast forwarding) when counter reads <i>M 0:00:00</i>. Press <i>REW</i> or <i>FF</i> again to continue rewinding or fast forwarding, or press <i>COUNTER R/M</i> to turn off the memory-stop feature.
Camcorder remains in pause mode	<ul style="list-style-type: none"> • Press <i>PLAY/PAUSE</i> to return to normal playback.
Sound is too low or distorted	<ul style="list-style-type: none"> • Subject was too far from camcorder.
Dew Indicator flashing in viewfinder	<ul style="list-style-type: none"> • If the dew indicator () flashes in the viewfinder, there is moisture in the camcorder. Wait until this indicator no longer appears before operating the camcorder.
Poor auto-focus operation	<ul style="list-style-type: none"> • Subject is dark or behind glass. Auto-focus may not work under these conditions. Place mode select dial in <i>MANUAL</i> and focus manually. <i>See pages 38-39.</i> • Subject is not in center of viewfinder or two subjects are at different distances. Place mode select dial in <i>MANUAL</i> and focus manually. <i>See pages 38-39.</i> • Auto focus is automatically turned off when some effects are selected with the production special effects menu. <i>See pages 68-69.</i>

(continued on next page)

Trouble Checks

Trouble	Checks and Adjustments
Viewfinder displays are out of focus	<ul style="list-style-type: none"> • Lens is smudged, and image appears unfocused. • Eyepiece focus control is misadjusted. • Model CC639: The small controls on the bottom of the viewfinder control the brightness (<i>B</i>) and color (<i>C</i>) of the viewfinder. These controls have been set at the factory and should require no adjustment. If the brightness or color of the viewfinder ever does require adjustment, carefully use a plastic screwdriver. Make the adjustments with caution to prevent damaging the miniature controls.
Picture is too dark or subject too dark	<ul style="list-style-type: none"> • For best results, only use higher shutter speeds outdoors. Press <i>16X9/AE MODES</i> button to select sports (). See pages 68-69. • Place mode select dial in <i>MANUAL</i> and press <i>FRONTLIGHT</i> or <i>BACKLIGHT</i>. See page 37. • Turn on the built-in color enhancement light.
Picture recorded with special effect (black bars at top and bottom)	<ul style="list-style-type: none"> • Special effect selected. Press the <i>16X9/AE MODES</i> button to display the production effects menu and select <i>OFF</i>. • If the mode select dial is in <i>AUTO</i>, press the <i>16X9/AE MODES</i> button to turn off the <i>Cinema</i> mode. See pages 68-69.
Picture recorded in brown tone	<ul style="list-style-type: none"> • <i>SEPIA</i> () selected on production effects menu. Press the <i>16X9/AE MODES</i> button to display the production effects menu and select <i>OFF</i>.
Colors do not look natural on recording	<ul style="list-style-type: none"> • Try adjusting white balance. See pages 44-45. • Turn off <i>Color Filter</i> in main recording menu. See page 51.
Title recorded on tape	<ul style="list-style-type: none"> • Title is recorded whenever it appears in viewfinder. Remove the title from viewfinder. See pages 52-53.
Date and/or time were recorded on tape	<ul style="list-style-type: none"> • Displays will be recorded on tape whenever they appear in the viewfinder. Remove them from viewfinder when recording. See pages 56-57.

Trouble Checks

Trouble	Checks and Adjustments
Date and/or time are incorrect	<ul style="list-style-type: none">• Clock lithium cell battery may need replacing. <i>See page 55.</i>• Date or time may need to be set. <i>See page 54.</i>
Vertical white lines appear when shooting bright object	<ul style="list-style-type: none">• This may occur when background extremely contrasts with the subject.
Error number (<i>E01, E02, E03, etc.</i>) appears in viewfinder	<ul style="list-style-type: none">• Try disconnecting power source. Wait ten seconds and then connect power source again. If error number does not disappear from viewfinder, consult your Authorized RCA Camcorder Servicer.

Care and Maintenance

Cleaning the Camcorder

To clean the camcorder's exterior, remove any power source connected to the camcorder and gently wipe it with a clean soft cloth.

Caution: Use of strong cleaning products, such as those containing alcohol or benzine, may damage the camcorder.

Cleaning the Camcorder's Lens

To clean the camcorder's lens, blow it with a blower brush, and then gently wipe the lens with cleaning tissue and commercially prepared cleaning solution designed for use on camera lens. Improper cleaning may scratch the lens.

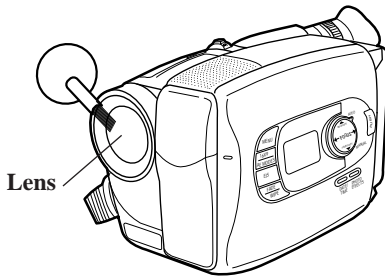

Caution: Do not touch the lens with your fingers. The oil from your skin can damage the lens.

Cleaning the Camcorder's Viewfinder

The viewfinder eyepiece can be removed for cleaning.

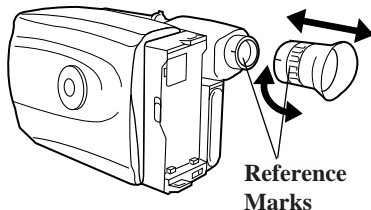

1. Turn the eyepiece counterclockwise and pull it out.
2. Remove dust using a blower brush.
3. Reattach the eyepiece by aligning the reference marks, and then turn the eyepiece clockwise until it clicks.

Care and Maintenance

Proper Care and Storage

- Keep dust and grit from entering the camcorder's cassette door. Dust and grit are abrasive and will cause excessive wear to both the camcorder's recording/playback heads and cassettes.
- Always close the lens cover when the camcorder is not in use.
- Before handling your camcorder, make sure your hands and face are free from any chemical products such as suntan lotion, as it may damage the finish.
- The camcorder can be damaged by improper storage or handling. Do not subject the camcorder to swinging, shaking, or dropping.
- Do not store the camcorder in temperatures below -22°F (-30°C) or above 149°F (65°C).
- When the camcorder is not in use, always remove the cassette and AC adapter/charger or battery.
- Retain the original carton for future storage or shipping purposes.

Things to Avoid

- Do not attempt to disassemble your camcorder. There are no user-serviceable parts inside.
- Avoid operating your camcorder immediately after moving it from a cold location to a warm location. Give the camcorder 1-1/2 to 2 hours to reach a stable temperature before inserting a cassette. When the camcorder is moved from cold to warm, condensation may cause the tape to stick to the headwheel and damage the headwheel or tape.
- Do not aim your camcorder at the sun or other bright objects.
- Do not leave your camcorder in direct sunlight for extended periods of time. The resulting heat buildup could permanently damage the camcorder's internal parts.
- Do not operate the camcorder in extremely humid environments.
- Do not operate the camcorder near the ocean as salt water or salt water spray may damage the internal parts of the camcorder.
- Do not operate the camcorder for extended periods in temperatures below 40°F (4°C) or above 95°F (35°C).
- Do not expose the camcorder or adapter/charger to rain or moisture. If either component becomes wet, turn off the power and take the unit to an Authorized RCA Camcorder Servicenter.
- Do not use an adapter/charger or batteries other than the ones specified for the camcorder. Use of the wrong accessories may cause damage to the camcorder.

Information to User

This equipment has been tested and found to comply with the limits for a Class B digital device and RF lighting device pursuant to Part 15 and part 18 of the FCC Rules. These limits are designed to provide reasonable protection against harmful interference in a residential installation. This equipment generates, uses, and can radiate radio frequency energy and, if not installed and used in accordance with the instructions, may cause harmful interference to radio communications. However, there is no guarantee that interference will not occur in a particular installation. If this equipment does cause harmful interference to radio or television reception, which can be determined by

turning the equipment off and on, the user is encouraged to try to correct the interference by one or more of the following measures:

- Reorient or relocate the receiving antenna.
- Increase the separation between the equipment and receiver.
- Connect the equipment into an outlet on a circuit different from that to which the receiver is connected.
- Consult the dealer or an experienced radio/TV technician for help.

Alterations or modifications carried out without appropriate authorization may invalidate the user's FCC right to operate the equipment.

This Class B digital apparatus meets all requirements of the Canadian Interference — Causing Equipment Regulations.

Cet appareil numérique de la classe B respecte toutes les exigences du Règlement sur le matériel brouilleur du Canada.

Customer Assistance and Service

You can reach Thomson at the following number:

800-283-6503

(Toll free inside U.S.A.)

Our toll-free Camcorder number operates from 8 a.m. to 5 p.m., CST Monday – Friday for U.S. customers only

Thomson provides a toll-free telephone number to help you with any problems you may encounter with your camcorder. Many can be diagnosed over the phone, and if necessary, a replacement unit can be shipped to you. Please have your camcorder model/serial number and date of purchase ready when you call. If your unit is out of warranty, we will quote the cost of an exchange unit to you.

Returning equipment to Thomson for repair or exchange

If we are unable to resolve your problem over the phone, we will gladly service your unit or exchange it for a new or refurbished camcorder. Refer to the limited warranty on the reverse side to learn about your specific rights and responsibilities.

Always consult Thomson and get a Return Authorization number before returning anything! Obtain a Return Authorization (RA) number from the telephone representative before returning your equipment to avoid delays, accounting errors, or even loss of your unit.

Important information to customers who ship defective equipment to Thomson Consumer Electronics

The Thomson representative who authorized the return of your equipment will give you an RA number over the phone. They will also provide you with instructions on where and how to return your camcorder. Write the number in large, clear characters on the outside of the box. To avoid confusion and misunderstandings, shipments without an RA number clearly visible on the outside of the box will be returned to you at your expense.

Include a brief note describing the problem and any conversations about the problem you have had with Thomson personnel. Include your name, address

and model/serial number of your camcorder. These numbers are located on the bottom of your unit. If your camcorder is within the warranty period, please provide a copy of the bill of sale to verify purchase date. Use the original box and packing material to protect the equipment from damage in shipment.

For your protection, insure all shipments for full replacement value and use a reliable shipper. Thomson assumes no responsibility for warranty shipments from the customer to the factory if not shipped in the manner prescribed by Thomson.

Limited Warranty

What your warranty covers:

- Any defect in materials or workmanship.

For how long after your purchase:

- 90 days for labor charges.
- One year for parts.

What we will do:

During the initial 90 days

- Exchange your camcorder with a new or, at our option, a refurbished unit or at your option, repair your camcorder at no cost to you.

After the 90 days and within one year

- Exchange your camcorder with a new or, at our option, a refurbished unit or at your option, repair your camcorder. Parts will be provided at no charge, but you will be responsible for the cost of labor required for the repair.

How you get service:

- Call 1-800-283-6503 and have your unit's date of purchase and model/serial number ready. The model/serial number information is on the bottom of your camcorder.
- A representative will troubleshoot your problem over the phone. If the representative determines that you should receive a replacement unit, you will be provided with a Return Authorization (RA) number and the location of a nearby exchange point if one exists. No returns will be accepted without the RA number.

To receive a replacement camcorder before you return yours:

If you are located near an exchange point:

1. We will send a replacement unit to the exchange point next business day delivery.
2. The exchange location will notify you of its arrival.
3. Take your unit, including all accessories, and your bill of sale

which validates date of purchase to the exchange location and you will be provided the new or refurbished unit.

4. If the repairs were covered by your warranty, you will not be billed.

If you are not located near an exchange point:

1. Provide your Discover, MasterCard or Visa account number and expiration date to our phone representative. This is for security purposes. If we receive your unit including all accessories within 14 days from the date you were provided a Return Authorization number, only items not covered by warranty will be charged to your account. **IF YOUR UNIT INCLUDING ALL ACCESSORIES IS NOT RECEIVED WITHIN 14 DAYS, THE SUGGESTED RETAIL VALUE OF THE CAMCORDER AND/OR ACCESSORIES WILL BE CHARGED TO YOUR CREDIT CARD.** This amount will be credited if the unit is subsequently received.
2. We will send you a replacement unit next business day delivery.
3. You will receive an invoice packed with the replacement product, but will not be charged for the unit portion of the invoice amount if we receive your unit including all accessories within 14 days from the date you were provided the RA number. Any labor and parts charges not covered by our warranty will be included and charged against your account.
4. Ship the unit back to us along with all accessories included with your camcorder using the replacement unit's carton. Shipping instructions will be included in the carton along with your RA number, which will allow you to easily ship the unit back to us. **Make sure you insure your**

Limited Warranty

shipment in case of damage or loss.

Include with the shipment:

- A copy of your dated bill of sale to verify your unit's warranty eligibility.
- A brief note describing your camcorder problem.
- Your name, address and phone number.

Return transportation, storage, and handling costs and insurance are your sole responsibility. We accept no liability in case of damage or loss.

To receive a replacement unit after we have received your unit:

1. Write the RA number on the outside of the carton used to return the unit.

Make sure you insure your shipment in case of damage or loss.

2. Carefully pack the unit along with all accessories included with your camcorder, using the original box and packing material if possible.
3. Include with the shipment:
 - A copy of your dated bill of sale to verify your unit's warranty eligibility.
 - A brief note describing your camcorder problem.
 - Your name, address and phone number.

Return transportation, storage, and handling costs, and insurance are your responsibility. We accept no liability in case of damage or loss.

4. Include a cashier's check or money order for payment if there are any out of warranty labor or parts charges which were indicated by the representative, and you elected not to use your credit card.
5. Upon receipt of your product, a new or refurbished unit will be shipped to you next day delivery.

To have your Camcorder repaired by an Authorized RCA Camcorder Servicenter:

- Check with your dealer or call 1-800-336-1900 for the Authorized RCA Camcorder Servicenter nearest you.
- Take your unit to the Authorized RCA Camcorder Servicenter of your choice.
- Show the Authorized RCA Camcorder Servicenter representative your sales receipt or other, evidence of purchase.
- Pick up your camcorder when repairs are complete.

What your warranty does not cover:

- Adjustment of customer controls.
- Damage from misuse or neglect.
- A unit that has been modified or incorporated into other products or is used for institutional or other commercial purposes.
- Battery for clock and other features.
- Cleaning of video/audio heads.
- Camcorders purchased or serviced outside the U.S.A.
- Return transportation, storage and handling costs of your unit, including insurance for loss or damage.
- Acts of God, such as but not limited to lightning damage.

Product Registration:

- Please complete and mail the *Product Registration Card* packed with your camcorder. It will make it easier to contact you should it ever be necessary. The return of the card is not required for warranty coverage.

How State Law relates to warranty:

- This warranty gives you specific legal rights and you may have other rights that vary from state to state.

If you purchased your Camcorder outside the United States:

- Contact your dealer for warranty information.

Specifications

General

Power requirement: 6VDC

Power consumption:

Model CC638: 5.7 watts (normal)

Model CC639: 5.9 watts (normal)

Weight: Model CC638: 1.74 lbs. (800g)

Model CC639: 1.7 lbs. (780g)

Dimensions – Including Viewfinder

Model CC638: 4-3/8"(W) x 4-1/2"(H) x 9"(D)

111 (W) x 113 (H) x 226(D) mm

Model CC639: 4-3/8"(W) x 4-1/2"(H) x 8-1/2"(D)

111 (W) x 113(H) x 206(D) mm

Video Recorder Section

Format: VHS-C

Record/Playback System:

Four video record/playback heads

One flying erase head

Video Signal: EIA Standard NTSC
color

Viewfinder

Model CC638: .5" Black & White

Model CC639: .55" Color – 113K Pixel

Camera Section

Image Sensor: 1/4" CCD Imager

Tripod Mount: One 1/4" x 20 threaded
hole

Lens: F1/1.2

14:1 (4.1-57.4 mm)

Filter Diameter: 46 mm

AC Adapter/Charger

Power requirement: 100-240 V, 50/60 Hz.

Power consumption: 23 watts

Weight: .7 lbs. (320g)

Dimensions: 6"(W) x 1.7"(H) x 2.7"(D)

150 (W) x 42(H) x 68(D) mm

Index

16X9/AE MODES

Button9,26-27,30,68-69

Blue Fader67

Bulb Assembly, Replace for Light . . .75

—A—

A. (Audio) *DUB*

Button18-19,20-21,71

Accessories, Included3

Accessories, Optional92-97

Accessory, Order Form95-97

Adapter/Charger, Using4,12

AE Modes Indicators30,68-69

Animation Indicators32,62-63

Animation Recording62-63

Assistance1,3,105,Back Cover

Audio Dubbing32-33,70-71

Audio Dubbing Indicator32-33,71

AUDIO, RF DC OUT, and VIDEO

Jacks4,10,12,70,72,84,89,90

Audio/Video Cable (Optional) .84-85,89

Auto Head Cleaner34

Auto Mode7,36

Auto Pause Feature43

AUTO PAUSE Indicator32,43

AUTO PAUSE OFF•ON Switch . .9,43

Auto Select Fade and Wipe Feature .67

—B—

B (Bright) Control10,100

Back Lit Feature69

BACKLIGHT Button9,32-33,37

BATT. RELEASE Button10,13

Battery Level Indicator15,28,32

Battery Marker Switch13

Battery Safety Precautions13

Battery, Care and Storage15

Battery, Using Rechargeable . . .13-15

Black Fader67

—C—

C (Color) Control10,100

Camcorder Lens, Cleaning102

Camcorder, Cleaning102

Camcorder, Powering12-16

Camcorder, Turning On5

Camcorder, Unpacking3

CAMERA/OFF/VCR Switch

.5,8,10,13,15,16,

.18-19,26-27,28,35,41

.42,44,56,60-70,72,80,88-89

CANCEL Button11,19,88-89

Car Cord Adapter, Optional16

Care and Maintenance102-103

Care and Storage of Battery15

Cassette Adapter78-79

Install Battery78

Cassettes, Care and Storage25

Cassette Door4,9

Cassette, Inserting4

Cassettes, Inserting and Removing .4,25

Cassette Moving Indicator28

Cassette Warning28,32-33

CautionsInside Front Cover

Charging the Battery14

Checking Problems98-101

Cinema Feature69

Classic Film Feature69

Cleaning Camcorder102

Clock Cell Compartment10,55

Clock Cell Warning32-33,55

Clock Cell, Installing55

Color Enhancement Light9,74-75

Color Filter Feature51

Color Filter Indicators51

Contents1-2

Index

Controls, Camcorder 9-11
Copying Tapes 84-85,86-89
COUNTER R/M Button 11,70,72,82
Customer
 Assistance 1,3,105,Back Cover

—D—

DATE/TIME Button 9,31,56-57
Date/Time Display 30-31,54-57
DC OUT Jack 4,10,12,84,89,90
Design Specifications 108
Dew Warning 32-33
Displays, Viewfinder 30-33
Dissolve Feature 67
Door Wipe Feature 67

—E—

EDIT Button 11,85,89
Edit Insert Feature 72-73
Edit Insert Indicators 32-33,72-73
EDIT SEARCH + and -
 Buttons 11,27,35
EIS (Electronic Image Stabilizer)
 Button 30-31,42
EIS Indicator 31,42
EJECT Button 4,9,25,26,80
Electronic Image Stabilizer 42
Erase Protection 24
Exposure Control 37
Exposure Level Indicator 32-33,37
External Microphone Jack 9,34
Eyepiece Focus Control 7,9,26,29

—F—

F FWD Button 18-19,35,86-87,81
Fade Indicators 30-31

FADE/WIPE

 Button 9,26-27,30-31,66-67
Fading Feature 66-67
FF (Fast Forward)
 Button 11,20-21,35,81
First-Time Operation 3-11
Flying Erase Head 34
FOCUS Buttons 32-33,38-39
Focus Lock Feature 38
Focusing 38-39
Frame Indicator 40-41
Front Lit Feature 69
FRONTLIGHT Button 9,32-33,37
Full *AUTO* Mode 36
Full Indicator 40-41

—G—

Gain Up Feature 50
Gain Up Indicators 32-33,50

—H—

Hand Strap, Adjusting 5
Handstrap 5,10

—I—

IN/OUT Button 9,11,88-89
Included Accessories 3
INDEX Indicator 32,43
Indexing, Electronic 43
Information to User 104
INSERT Button 18-19,20-21,73
Inserting and Removing Cassettes . . . 25
Installing Clock Cell 55

Index

—J—

JLIP ID NO. on Menu59
JLIP Jack10,88-89

—L—

LCD Panel9,28
Lens9,102
LENS COVER Control5,8,9,26
LENS COVER Display32
Lens, Cleaning102
LIGHT OFF•AUTO•ON
Switch9,26-27,74
Light, Built In74-75
Limited Warranty106-107

—M—

Maintenance and Care102-103
Making a Recording26
MAN.W.BAL (Manual White Balance)
Button11,44-45
Manual Focus
Indicators32-33,38-39,44
MBR SET Button18,86-87
Memory-Stop Feature70,72,82
MENU Button9,26,46-54,58-69
MIC Jack9,34
Microphone9,34
Mode Select Dial . .7,26-27,30-31,36,37
. . .38-39,40,42,44,46-54,56,58-69
Mosaic Fader67
Multi-4 and *Multi-9* Indicators . .40-41

—O—

OFF/CAMERA/VCR Switch
.....5,8,10,13,15,16,
.....18-19,26-27,28,35,41
.....42,44,56,60-70,72,80,88-89

ON/OFF Button11,19,88-89
Operation, First-Time3-11
Optional Accessories92-97
Order Form, Accessory95-97

—P—

≡ PAUSE ≡ Indicator5,8,73
PAUSE Button18-19,20-21
.....70-71,72-73,86-87
Pause, Stop-Action81
PHOTO EFFECTS
Button9,26-27,30-31,40-41
Pin-Up Indicator40-41
PLAY Button . .18-19,20,71,73,81,86-87
PLAY Indicator28
PLAY/PAUSE
Button8,11,70,72,80
Playback78-91
Playback Features81-83
Playback on a TV With
AUDIO/VIDEO IN Jacks . . .84-85
Playback on a TV Without
Audio/Video Inputs90-91
Playback Speeds24
Playback, First8
Playback, Viewfinder80
Plug Adapter (Optional)12
POWER (CAMERA/OFF/VCR)
Switch5,8,10,13,15,16,
.....18-19,26-27,28,35,41
.....42,44,56,60-70,72,80,88-89
Powering the Camcorder12-16
Preset Titles52
Problem Solving98-101
Product Registration .Inside Front Cover
Production Effects68-69
Production Effects Indicators69
Programmable Synchro Edit . . .88-89
Proper Care and Storage103

—Q—

Quick Review Feature35

—R—

RANDOM ASSEMBLY EDIT

Buttons18-19,88-89
REC ▶▶▶ Indicator8,27,30
REC/PAUSE Button18-19,88-89
 Recording Menu – Sub Menu ...58-65
 Recording Menus46-69
 Recording Speeds6,24
 Recording Tips23
 Recording, First8
 Recording, Making a26-27
 Refreshing the Battery14
 Registration Card ..Inside Front Cover
 Remote Battery, Replacing17,22
 Remote Control (Model CC638) ..20-22
 Remote Control (Model CC639) ..17-19
 Remote Control Sensor9,17,22
 Remote, Program to Operate
 VCR86-87
 Replacing Remote Battery
 (Model CC638)22
 Replacing Remote Battery
 (Model CC639)17
REW (Rewind) Button
 8,11,18,20,35,70,73,82,86-87
 RF Output Adapter, Optional ...90-91

—S—

Safety Tab24
 Scroll Wipe Feature67
 Searching, Visual81
 Self-Timer Feature60-61
 Self-Timer Indicators32,60-61
 Sepia Feature69

Shoulder Strap Attachment Rings .10,76
 Shoulder Strap, Attaching76
 Slow Shutter Feature69
SNAPSHOT

 Button ...10,18,26-27,30-31,40-41,
 Snapshot Indicators30-31,40-41
 Snapshot Search Feature41
 Solving Problems98-101
 Specifications108
 Speeds, Recording and Playback ...6,24
 Sports Feature69
 SP•SLP Switch6,11,26
START/STOP
 Button ...18,20-21,35,61,63,65,73
 Status Displays30
 Status Indicators, LCD Panel28
STOP
 Button ...8,11,18-19,20,80,82,88-89
 Stop-Action Pause81
 Strobe Feature69
 Sub Menu – Recording Menu ...58-65

—T—

Table of Contents1-2
 Tally Light9,34,59
 Tally Light Feature on Menu59
 Tape Copying84-85,86-89
TAPE END Indicator32,47
 Tape Length Indicator32-33,47
 Tape Speed Indicators28,30
 Tele Macro Feature49
 Things to Avoid103
 Thumb Trigger8,10
 Tilt, Viewfinder29
 Time Counter32-33,82
TIME LAPSE ANIM. REC/TIME
 Button18,20-21,63,65
TIME LAPSE SELF INT.(Interval/
 TIME Button18,20-21,61

Index

Time-Lapse Indicators32,64-65
Time-Lapse Recording64-65
Time-Remaining Indicators32,47
Tips, Recording23
Tips, Traveling77
Title Display30-31,52-53
Title Feature52-53
Tracking83
TRACKING Buttons11,83
Traveling Tips77
Tripod, Using93
Trouble Checks98-101
Turning On the Camcorder5

—U—

Unpacking the Camcorder3
User Information104
Using Cassette Adapter78-79

—V—

VCR/OFF/CAMERA Switch
.5,8,10,13,15,16,
.18-19,26-27,28,35,41
.42,44,56,60-70,72,80,88-89
VCR Button18-19,86-87
VCR Code Numbers86-87
Video Cassettes24-25
Viewfinder7,9,26,29,80,102
Viewfinder Displays30-33
Viewfinder Playback80
Viewfinder, Cleaning102
VISS Button18,43
Visual Searching81

—W—

Warranty, Limited106-107
White Balance Feature44-45
White Balance Indicators32-33,45
Window Wipe Feature67
Wipe Indicators30-31,67
Wiping Feature66-67

—Z—

ZOOM Buttons18-19,20,48
Zoom Indicator30-31,48
Zoom Lever9,48
Zooming48-49

Need Assistance? We want to help!

U.S. Consumers:

Camcorder Exchange Warranty	800-283-6503
Customer Service	800-336-1900
Accessories	800-338-0376

Canadian Consumers:

English	800-522-0338
French	800-522-0445

If your camcorder needs service, please contact your dealer or the nearest Servicenter from the yellow pages. Please do not send any products to the Indianapolis address listed in this manual or on the carton. This will only add delays in service for your product.

 **THOMSON CONSUMER ELECTRONICS**
10330 N Meridian Street
Indianapolis, IN 46290

©1996 Thomson Consumer Electronics, Inc.
Trademark(s)[®] Registered
Marca(s) Registrada(s)
Printed in Japan

Part Number 96-CC638/CC639-1

Free Manuals Download Website

<http://myh66.com>

<http://usermanuals.us>

<http://www.somanuals.com>

<http://www.4manuals.cc>

<http://www.manual-lib.com>

<http://www.404manual.com>

<http://www.luxmanual.com>

<http://aubethermostatmanual.com>

Golf course search by state

<http://golfingnear.com>

Email search by domain

<http://emailbydomain.com>

Auto manuals search

<http://auto.somanuals.com>

TV manuals search

<http://tv.somanuals.com>