

# RCA

Changing Entertainment. Again.

## User's Guide

### Find Inside:

- *Connecting* ..... page 5
- *Remote Control* ..... page 10
- *KidPass* ..... page 23
- *Favorite Channel* .... page 32
- *Troubleshooting* ..... page 38



*Model 27V514T is pictured here.*

# SDTV

STANDARD DEFINITION TELEVISION



[www.rca.com/television](http://www.rca.com/television)

# Important Information

## CAUTION

RISK OF ELECTRIC SHOCK  
DO NOT OPEN



This symbol indicates that this product incorporates double insulation between hazardous mains voltage and user accessible parts. When servicing use only identical replacement parts.

Caution: To reduce the risk of electric shock, do not remove cover (or back). No user serviceable parts inside. Refer servicing to qualified service personnel.



This symbol indicates "dangerous voltage" inside the product that presents a risk of electric shock or personal injury.



This symbol indicates important instructions accompanying the product.

## WARNING

To reduce the risk of fire or electric shock, do not expose this product to rain or moisture.

The apparatus shall not be exposed to dripping or splashing and no objects filled with liquids, such as vases, should be placed on the apparatus.

Refer to the identification/rating label located on the back panel of your product for its proper operating voltage.

FCC Regulations state that unauthorized changes or modifications to this equipment may void the user's authority to operate it.

**Caution:** To prevent electric shock, match wide blade of plug to wide slot, fully insert.

**Caution:** Using video games or any external accessory with fixed images for extended periods of time can cause them to be permanently imprinted on the picture tube (or projection TV picture tubes). ALSO, some network/program logos, phone numbers, black borders (sides, top and bottom), etc. may cause similar damage. This damage is not covered by your warranty.

**Cable TV Installer:** This reminder is provided to call your attention to Article 820-40 of the National Electrical Code (Section 54 of the Canadian Electrical Code, Part 1) which provides guidelines for proper grounding and, in particular, specifies that the cable ground shall be connected to the grounding system of the building as close to the point of cable entry as practical.

### Important Stand and Base Safety Information

Choose the location for your TV carefully. Place the TV on a stand or base that is of adequate size and strength to prevent the TV from being accidentally tipped over, pushed off, or pulled off. This could cause personal injury and/or damage the TV. Refer to the Important Safety Instructions on page 1.

## Product Registration

Please fill out the product registration card (packed separately) and return it immediately. For US customers: Your RCA Consumer Electronics product can also be registered at [www.rca.com/television](http://www.rca.com/television). Registering this product allows us to contact you if needed.

## Product Information

Keep your sales receipt to obtain warranty parts and service and for proof of purchase. Attach it here and record the serial and model numbers in case you need them. These numbers are located on the product.

Model No. \_\_\_\_\_ Serial No. \_\_\_\_\_ Purchase Date: \_\_\_\_\_

Dealer/Address/Phone: \_\_\_\_\_

## IMPORTANT SAFETY INSTRUCTIONS Read before operating equipment

1. Read these instructions.
2. Keep these instructions.
3. Heed all warnings.
4. Follow all instructions.
5. Do not use this apparatus near water.
6. Clean only with a dry cloth.
7. Do not block any of the ventilation openings. Install in accordance with the manufacturer's instructions.
8. Do not install near any heat sources such as radiators, heat registers, stoves, or other apparatus (including amplifiers) that produce heat.
9. Do not defeat the safety purpose of the polarized or grounding type plug. A polarized plug has two blades with one wider than the other. A grounding type plug has two blades and a third grounding prong. The wide blade or third prong are provided for your safety. When the provided plug does not fit into your outlet, consult an electrician for replacement of the obsolete outlet.
10. Protect the power cord from being walked on or pinched, particularly at plugs, convenience receptacles, and the point where they exit from the apparatus.
11.  Only use attachments/accessories specified by the manufacturer.
12. Use only with a cart, stand, tripod, bracket, or table specified by the manufacturer or sold with the apparatus. When a cart is used, use caution when moving the cart/apparatus combination to avoid injury from tip-over.
13. Unplug this apparatus during lightning storms or when unused for long periods of time.
14. Refer all servicing to qualified service personnel. Servicing is required when the apparatus has been damaged in any way, such as if the power-supply cord or plug is damaged, liquid has been spilled or objects have fallen into the apparatus, or if the apparatus has been exposed to rain or moisture, does not operate normally, or has been dropped.
15. This product may contain lead and mercury. Disposal of these materials may be regulated due to environmental considerations. For disposal or recycling information, please contact your local authorities or the Electronic Industries Alliance ([www.eiae.org](http://www.eiae.org)).
16. **Damage Requiring Service** - The appliance should be serviced by qualified service personnel when:
  - A. The power supply cord or the plug has been damaged;
  - B. Objects have fallen or liquid has been spilled into the appliance;
  - C. The appliance has been exposed to rain;
  - D. The appliance does not appear to operate normally or exhibits a marked change in performance;
  - E. The appliance has been dropped or the enclosure damaged.
17. **Tilt/Stability** - All televisions must comply with recommended international global safety standards for tilt and stability proper ties of its cabinet design.
  - Do not compromise these design standards by applying excessive pull force to the front, or top, of the cabinet, which could ultimately overturn the product.
  - Also, do not endanger yourself, or children, by placing electronic equipment/toys on the top of the cabinet. Such items could unsuspectingly fall from the top of the set and cause product damage and/or personal injury.
18. **Power Lines** - An outdoor antenna should be located away from power lines.
19. **Outdoor Antenna Grounding** - If an outside antenna is connected to the receiver, be sure the antenna system is grounded so as to provide some protection against voltage surges and built up static charges. Section 810 of the National Electrical Code, ANSI/NFPA No. 70-1984, provides information with respect to proper grounding of the mast and supporting structure, grounding of the lead-in wire to an antenna discharge unit, size of grounding connectors, location of antenna-discharge unit, connection to grounding electrodes, and requirements for the grounding electrode. See Figure below.
20. **Object and Liquid Entry** - Care should be taken so that objects do not fall and liquids are not spilled into the enclosure through openings.
21. **Battery usage CAUTION** - To prevent battery leakage that may result in bodily injury, property damage, or damage to the unit:
  - Install all batteries correctly, with + and - aligned as marked on the unit.
  - Do not mix batteries (old and new or carbon and alkaline, etc.).
  - Remove batteries when the unit is not used for a long time.
22. Apparatus shall not be exposed to dripping or splashing and no objects filled with liquids, such as vases, shall be placed on the apparatus.

**Note to the Cable TV system installer:** This reminder is provided to call the Cable TV system installer's attention to Article 820-40 of the NEC (Section 54 of the Canadian Electrical Code, Part 1) that provides guidelines for proper grounding and, in particular, specifies that the cable ground shall be connected to the grounding system of the building, as close to the point of cable entry as practical.

### Example of Antenna Grounding as per NEC - National Electrical Code

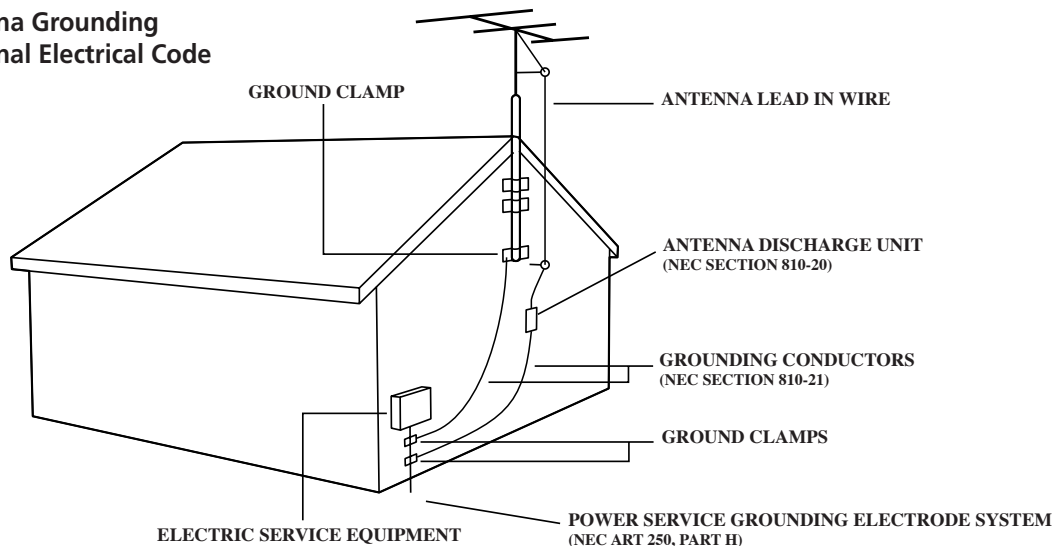

# Table of Contents

---

## Chapter 1: Connections & Setup

<b>Things to Consider Before You Connect</b> .....	<b>4</b>
Protect Against Power Surges.....	4
Protect Devices from Overheating .....	4
Position Cables Properly to Avoid Audio Interference.....	4
Use Indirect Light.....	4
<b>Get the Picture</b> .....	<b>5</b>
Receiving Digital Channels.....	5
What You Need.....	5
What You Need to Know .....	5
Receiving Analog Channels.....	6
What You Need.....	6
What You Need to Know .....	6
<b>Choose Your Connection</b> .....	<b>7</b>
S-Video Connection .....	7
<b>Using the Side Jacks</b> .....	<b>9</b>
<b>Plug in the TV</b> .....	<b>10</b>
<b>Put Batteries in the Remote</b> .....	<b>10</b>
<b>How to Use the Remote Control to Complete the Initial Setup</b> .....	<b>10</b>
<b>Turn on the TV</b> .....	<b>10</b>
<b>Complete the Initial Setup</b> .....	<b>11</b>
Choose the Menu Language.....	11
Tuning to a Channel .....	11
<b>What to Expect</b> .....	<b>12</b>
Watching TV.....	12
<b>Remote Buttons</b> .....	<b>13</b>
<b>Using the INPUT Button</b> .....	<b>14</b>
<b>Explanation of Jacks</b> .....	<b>15</b>
<b>The Front of Your TV</b> .....	<b>16</b>

## Chapter 2: Using the TV Features

<b>Channel Banner</b> .....	<b>17</b>
<b>Parental Controls and V-Chip</b> .....	<b>18</b>
How V-Chip Works.....	18
<b>Activate Parental Control</b> .....	<b>18</b>
Resetting the Password .....	18
Set V-Chip TV Programming Limits.....	19
The V-Chip Rating Screen.....	19
Blocking Age-Based Ratings .....	19
Blocking Specific Content Themes.....	20
Blocking USA V-Chip Movie Ratings.....	21
Blocking Canadian V-Chip Movie Ratings.....	22
V-Chip Exempt Program Block .....	22
Activate KidPass.....	23
Block Channel .....	23
Front Panel Lock .....	24
Change Password.....	24

# Table of Contents

---

## Chapter 3: Using the TV's Menu System

Sound Menu .....	25
Picture Menu .....	27
Setup Menu .....	28
Parental Control Menu .....	33
Time Menu.....	34
Notepad Menu .....	35

## Chapter 4: Other Information

USA V-Chip Rating System .....	36
Canadian English V-Chip Rating System .....	37
Canadian French V-Chip Rating System .....	37
Troubleshooting .....	38
Limited Warranty .....	40
Care and Cleaning.....	42
FCC Information .....	43

# Chapter 1: Connections & Setup

## Things to Consider Before You Connect

### Protect Against Power Surges

- Connect all devices before you plug any of their power cords into the wall outlet.
- Turn off the TV and/or device before you connect or disconnect any cables.
- Using a surge protector can help prevent damage to your TV from electrical power surges. In case of lightning, unplug your TV.
- Make sure all antennas and cables are properly grounded. Refer to the Important Safety Instructions packed separately.

### Protect Devices from Overheating

- Don't block ventilation holes on any of the devices. Arrange the devices so that air can circulate freely.
- Don't stack devices.
- If you place devices in a stand, make sure you allow adequate ventilation.
- If you connect an audio receiver or amplifier, place it on the top shelf so the heated air from it won't flow around other devices. Position Cables Properly to Avoid Audio Interference

### Position Cables Properly to Avoid Audio Interference

- Insert each cable firmly into the designated jack.
- If you place devices above the TV, route all cables down the side of the back of the TV instead of straight down the middle of the TV.
- If your antenna uses 300-ohm twin lead cables, do not coil the cables. Also, keep the twin lead cables away from audio/video cables.

### Use Indirect Light

Don't place the TV where sunlight or room lighting will be directed toward the screen. Use soft or indirect lighting.

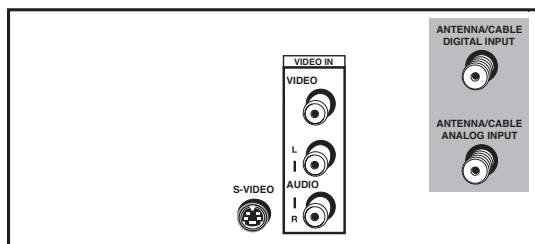

## Get the Picture

The first part of connecting your TV is to get a signal. The back panel of your TV allows you to receive analog channels by using the ANTENNA/CABLE ANALOG INPUT and digital channels by using the ANTENNA/CABLE DIGITAL INPUT. The graphic to the left shows these inputs.

**Note:** You may experience a delay of several seconds before digital pictures appear, both when you first turn on the digital signals and when you change channels. This is normal. Check with your local cable company for available content.

## Receiving Digital Channels

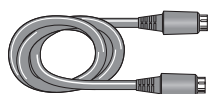

Coaxial cable

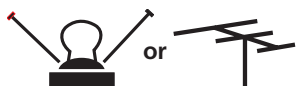

Indoor or Outdoor Antenna



or

### What You Need

- Antenna (“rabbit ears”) or outdoor antenna with a coaxial cable. Plug the antenna or coaxial cable from the wall outlet into the ANTENNA/CABLE DIGITAL INPUT to receive free off-air local digital channels.

OR

- Coaxial cable from a cable outlet. Plug the coaxial cable into the ANTENNA/CABLE DIGITAL INPUT to receive your digital cable channels.

OR

- You can use a signal splitter (shown at left) to divide the signal from one cable or antenna source to connect to both the ANTENNA/CABLE ANALOG INPUT and ANTENNA/CABLE DIGITAL INPUT jacks on the TV. When you get to the Auto Channel Search screen in the Initial Setup, make sure you set the signal type to *Both* (digital and analog).

### What You Need to Know

- This television is equipped with a QAM (Quadrature amplitude modulation) tuner that enables reception of unscrambled digital cable content. Check with your cable provider for information about content availability in your area.
- Visit [www.antennaweb.org](http://www.antennaweb.org) to get help deciding what type of antenna to use to receive the off-air local digital channels available to you. By entering where you live, this mapping program tells you what local analog and digital stations are available using a certain antenna.
- When you get to the Auto Channel Search screen in the Initial Setup, make sure you set the signal type for using a digital signal source. (You can also choose *Both*, digital and analog). To complete a channel search now, go to page 11.
- When you are ready to watch digital channels, make sure you are tuned to the Digital Input. Press the ANTENNA button to tune to the Digital Input. Go to page 13 for more information.

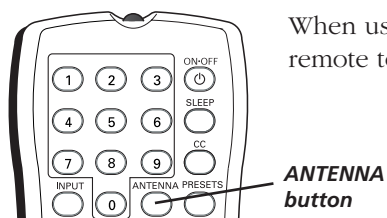

When using both of these jacks, use the ANTENNA button on the remote to toggle between the digital and analog signals.

*Continues on next page...*

# Connections & Setup

## Receiving Analog Channels

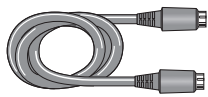

Coaxial cable

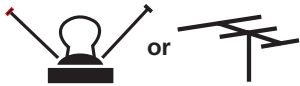

Indoor or Outdoor Antenna

### What You Need

- Antenna (“rabbit ears”) or outdoor antenna with coaxial cable. Plug the antenna or coaxial cable from the wall outlet into the ANTENNA/CABLE ANALOG INPUT to receive analog channels.
- OR
- Coaxial cable from a cable outlet. Plug the coaxial cable from the source outlet into the ANTENNA/CABLE ANALOG INPUT to receive cable channels.

### What You Need to Know

- Visit [www.antennaweb.org](http://www.antennaweb.org) to get help deciding what type of antenna to use to receive the local analog channels available to you. By entering where you live, this mapping program tells you what local analog and digital stations are available using a certain antenna.
- When you get to the Auto Channel Search screen in the Initial Setup, make sure you set the signal type for using an analog signal source. (You can also choose *Both*, digital and analog). To complete a channel search now, go to page 11.
- When you are ready to watch analog channels, make sure you are tuned to the analog input. Press the ANTENNA button to tune to the analog input. Go to page 13 for more information.

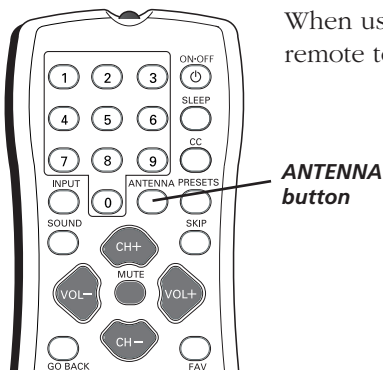

When using both of these jacks, use the ANTENNA button on the remote to toggle between the digital and analog signals.



## Choose Your Connection

There are several ways to connect your TV, depending on the devices you want to connect and the quality of the signal you want to achieve. Connections will vary according to the types of outputs jacks the devices you want to connect can accommodate.

### S-Video Connection

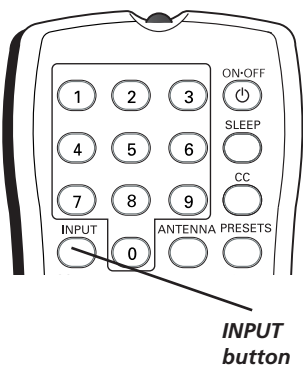
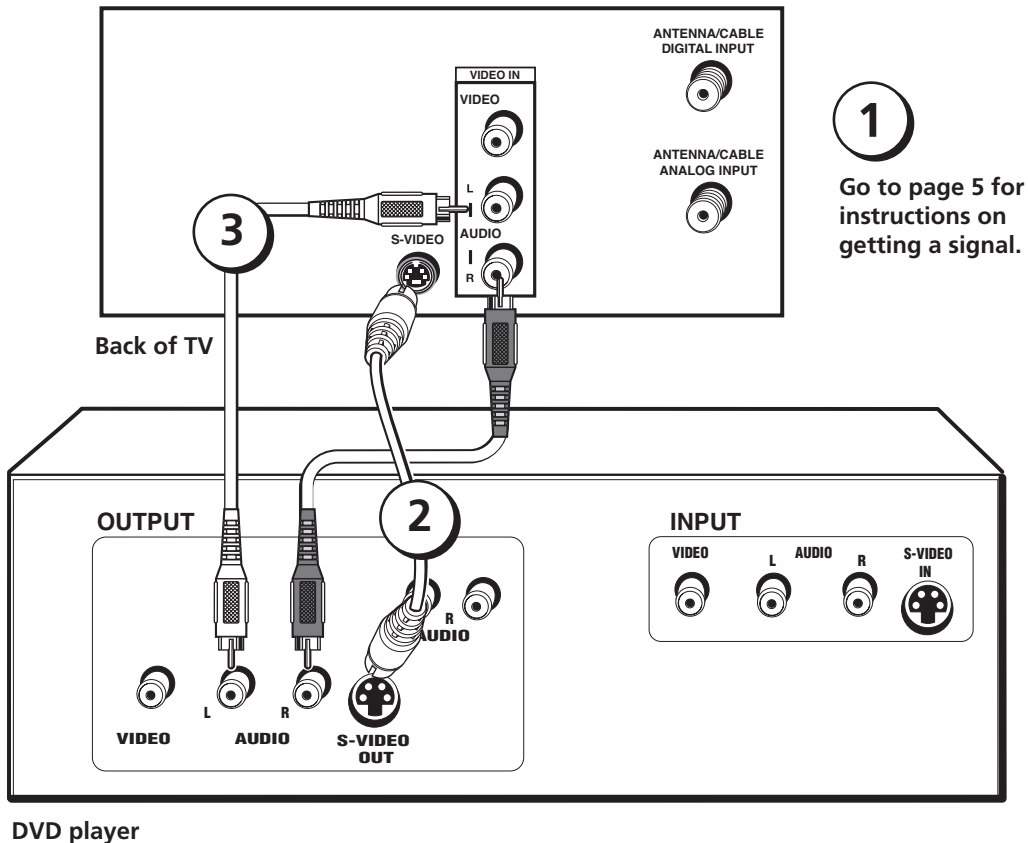

### Viewing the Picture from the Connected Device

The device in this example, a DVD player, is connected to the TV's S-Video and audio jacks located on the TV. To view this device:

1. Turn on the TV and the DVD player.
2. Use the INPUT button on the remote control to toggle through the Video Input Channels until you see *SVID* displayed in the channel banner.

**Remember:** If you use the S-Video connection described here, you cannot use the Video jack for a connection at the same time.

# Connections & Setup

---

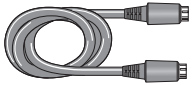

**S-Video cable**

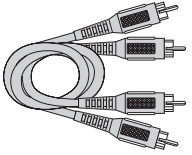

**Audio cables**

## Connecting the Device

This connection allows you to connect a device that has an S-Video jack, such as a DVD player. S-Video provides a clearer picture than the Video jack. Refer to the illustration which uses S-Video and audio cables.

Using the example of a DVD player:

1. **Connect your cable and/or antenna as described on page 5.**
2. **Connect your S-Video cables.**

S-Video cables fit into a special shaped jack which is labeled S-Video. Connect the S-Video cable to the jack on the TV and the jack on the DVD player.

3. **Connect your audio cables.**

Connect the audio (white and red) cables to the R and L Audio jacks on the TV and to the audio output jacks on the DVD player. Just match the colors.

## Using the Side Jacks

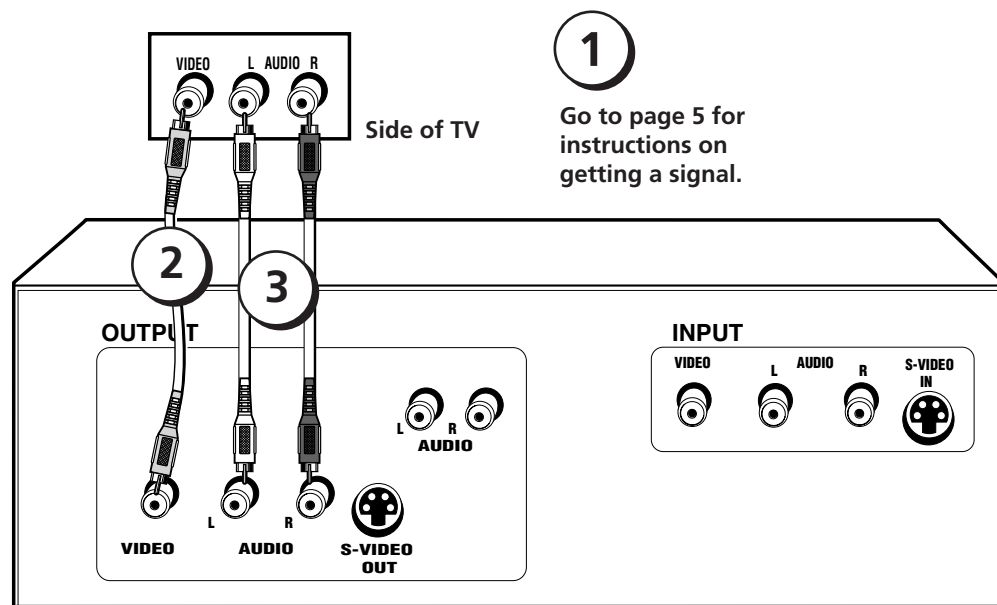

1  
Go to page 5 for instructions on getting a signal.

Video Game Console

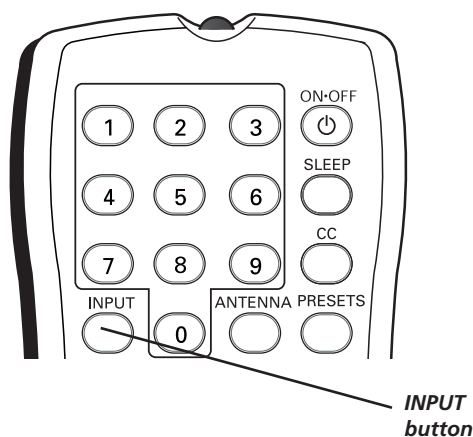

### Viewing the Picture from the Connected Device

The device in this example, a video game console, is connected to the TV's video and audio jacks located on the side of the TV. To view the video game console:

1. Turn on the TV and the video game console.
2. Use the INPUT button on the remote control to toggle through the Video Input Channels until you see *FRNT* displayed in the channel banner.

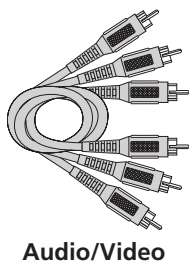

Audio/Video

### Connecting the Device

This connection allows you to connect a device such as a video game console, that has Audio/Video jacks. Refer to the illustration below which uses audio and video cables.

Using the example of a video game console:

1. Connect your cable and/or antenna as described on page 5.
2. Connect your video cable.

Video cables are usually yellow. Connect the Video cable to the Video jack on the side of the TV and the jack on the video game console.

3. Connect your audio cables.

Connect the audio (white and red) cables to the R and L Audio jacks on the side of the TV and to the audio output jacks on the video game console. Just match the colors.

# Connections & Setup

## Plug in the TV

Plug the end of the power cord into a grounded wall outlet. Insert the plug completely into the outlet.

## Put Batteries in the Remote

- Remove the battery compartment cover from the back of the remote by pushing down and sliding off the cover.
- Insert 2 fresh “AA” batteries. Make sure the polarities (+ and -) are aligned correctly to the diagram inside the battery compartment.
- Replace the cover.

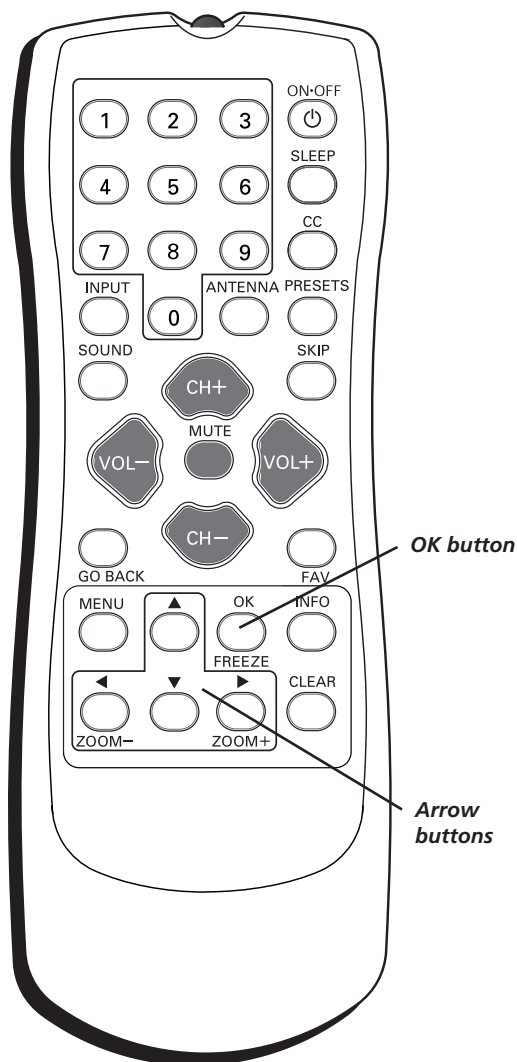

## How to Use the Remote Control to Complete the Initial Setup

The technical term is “Navigation” - how you move through the on-screen menus. The method is the same throughout the menu screens: highlight your choice and select it.

To highlight a menu item, press the arrow buttons on the remote to highlight one of the items listed on the screen. Use the up or down arrow button to move up or down. Use the right or left arrow button to move right or left.

To select the item that you’ve highlighted, press OK.

***Note:** Highlighted means that the menu item stands out from other menu items on the list (appears darker, brighter or a different color).*

## Turn on the TV

Press ON•OFF on the remote, or press POWER on the TV’s front panel.

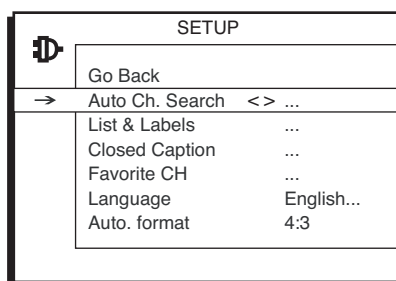

## Complete the Initial Setup

*AUTO CHANNEL SEARCH* is the first menu you should see when you turn on the TV. (It is located from this path *Main Menu/Setup/Auto Ch Search*). It allows the TV to search for all channels viewable through your digital and analog connections. This is sometimes called auto programming.

1. From the Auto Channel Search menu press the right arrow button to choose the *Signal Source* (*Digital, Analog, or Both*). The default is *Both*.
2. With the *Signal Source* chosen, press the down arrow button to select *Start* and press OK. *AUTO CHANNEL SEARCH* runs as it finds all the available channels. (This step might take 10-15 minutes depending on your content provider).
3. Once the search is complete, you can begin watching TV. For information on customizing your channels or menu options, go to Chapter 3.

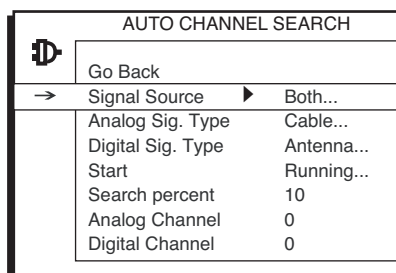

**Note:** After you complete the Auto Channel Search you may see an additional screen. "Time stored in the TV may be incorrect after a loss of power. Please check the time in the Time menu" may appear, reminding you that the time setting is incorrect. Go to page 34 for more information.

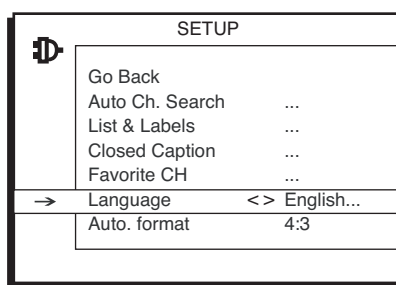

## Choose the Menu Language

To set the language, use the arrow buttons to highlight *Language*. The default language is *English*. To choose another language, press the right arrow button on the remote, choose the language and press OK.

## 12

Analog channel example entry

## Tuning to a Channel

Analog station numbers display on your TV in a rectangle as you enter the numbers. You can enter digits to access a channel. In the example below, you can enter 12 or 012 to get the same channel. To enter a one-digit channel, such as channel 8, just press 8. After entering the channel, press OK. The CLEAR button on the remote clears all entries.

## 012-1

Digital channel example entry

Digital channels can have both primary channels (like the analog channel number) and subchannels. Digital station numbers display in a larger rectangle that can contain up to eight numbers. Numbers to the left of the - (dash) are the main channel number; numbers to the right are the subchannel numbers for stations that broadcast more than one signal.

In the example to the left, press "1", press "2" (although 012 is shown in the example, pressing "0" isn't required) and then press the right arrow button to move to the subchannel. Press "1" and then "OK." The TV tunes to channel 12-1. If channel 12 is broadcasting subchannel signals, you would enter numbers that would access the other signals. (Example: 12-1, 12-2, 12-3). If the selection times out, you must start over. Once you've made all entries, press OK. The CLEAR button on the remote clears all entries.

**Notes:** You may experience a delay of several seconds before digital pictures appear, both when you first turn on the digital signals and when you change channels. This is normal. Digital channels sometimes take longer to tune.

*Continues on next page...*

# Connections & Setup

---

## Tuning to a Channel (continued)

Some channels might have been found during the channel search that are unavailable to view and you might want to get rid of these so they don't appear as you change channels. To do this go to Main Menu/Setup Menu/List & Labels. Note that removing channels from your channel list may be time consuming, so you might want to do it later. Go to page 29 for details on editing your channel list.

## What to Expect

### Watching TV

- **Remember:** If you have an analog signal connected to your ANTENNA/CABLE ANALOG INPUT, then view analog channels on your Analog Input. (The ANTENNA button on the remote tunes to the analog/digital inputs). Analog channels are sent in a 4:3 format. You can press the left arrow/ZOOM- and right arrow/ZOOM+ buttons on the remote to choose different screen formats (4:3, 16:9 or stretch). This is also known as the aspect ratio. Go to page 33 for examples of screen formats.
- **Remember:** If you have a digital signal connected to your ANTENNA/CABLE DIGITAL INPUT, then view digital channels on your Digital Input. (The ANTENNA button on the remote tunes to the analog/digital inputs). Most digital channels are sent in a 16:9 format; it depends on how the station is formatting the video. If so, you'll see gray or black bars at the top and bottom of the screen. You can press the left arrow/ZOOM- and right arrow/ZOOM+ buttons to choose different screen formats (4:3, 16:9 or stretch). This is also known as the aspect ratio.

***Note:** Digital stations in native 4:3 format (you'll see black or gray bars on the sides of the picture sent as part of the signal from the broadcaster) might not have this function.*

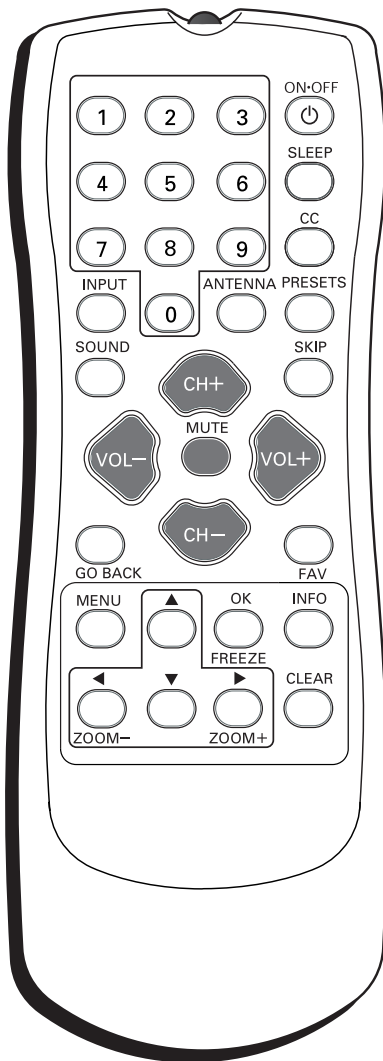

**Note:** If you need to replace your remote, call 1-800-338-0376. A shipping and handling fee will be charged upon ordering, and the appropriate sales tax. Have your Visa, MasterCard or Discover Card ready.

Your remote part number is R130A1.

## Remote Buttons

**ANTENNA** Tunes to digital and/or analog channel sources. Refer to page 5 for a full description.

**Arrow buttons** (▲, ▼, ◀, ▶) Use to highlight different items in the TV menu.

**(◀/ZOOM-, ▶/ZOOM+)** Adjusts the menu controls. During normal TV viewing, changes the screen format (aspect ratio). The zoom status appears momentarily. Refer to page 33 for more information about different formats.

**(0-9) Number buttons** Enter channel numbers (refer to the previous page), time settings (refer to page 34), labels (refer to page 29) and notepad messages (refer to page 35).

**CC** Toggles closed captioning on and off when closed-caption menu option is turned on.

**CH + or CH -** Scans up or down through all the available stations on analog and/or digital connections. Press once to change the channel up or down; press and hold to continuously change channels.

**CLEAR** Removes any menu or display from the screen and returns you to normal TV viewing.

**FAV (Favorite)** Press to browse the channels in your *Favorite List*. Refer to page 32 for more information.

**GO BACK** Returns you to the previous channel or menu.

**INFO** Brings up the channel banner. Press again to remove. Refer to page 17 for more information.

**INPUT** Toggles through the available Video Input Channels (*VID1*, *FRNT*, *SVID* and current channel).

**MENU** Brings up the *MAIN MENU* system.

**MUTE** Reduces the TV's volume to its minimum level. Press again to restore the volume.

**OK/FREEZE** When in the menu system, selects highlighted items. FREEZE is available only on some models.

**ON•OFF** Turns the TV on and off.

**PRESETS** Resets picture options to original factory settings.

**SKIP** Press once before changing channels; watch the screen for the *SKIP* box ( *SKIP 00:30* ) to appear. Press the *SKIP* button again - 30 seconds will appear. Enter the new channel number. The TV will change to the new channel and return to the original channel in 30 seconds. Press repeatedly to add more time.

**SLEEP** Allows you to activate/deactivate the sleep timer by taking you to the *Sleep Timer* menu. Refer to page 34.

**SOUND** Press to select one of the five sound settings when viewing analog signals (*Standard*, *Music*, *Speech*, *Theatre* or *Personal*). Refer to page 25 for more information.

**VOL - or VOL +** Decreases or increases the TV's volume.

# Connections & Setup

---

## Using the INPUT Button

Use the INPUT button to scroll through the available Video Input Channels to view components you have connected to the TV.

1. Make sure the component you want to view is turned ON.
2. Press INPUT to tune to an available Video Input Channel and view the component.
3. To return to the previous channel, continue pressing INPUT.



## Explanation of Jacks

This section describes the jacks you can use to make connections. There are several combinations available to connect devices to your TV.

ANTENNA/CABLE  
DIGITAL INPUT



**DIGITAL INPUT** Lets you connect a coaxial (RF) cable to receive digital programming through your cable provider. Receive off-air digital programming via an antenna. Refer to page 5 for more details.

ANTENNA/CABLE  
ANALOG INPUT



**ANALOG INPUT** Lets you connect a coaxial (RF) cable to receive analog programming through your cable provider. Receive off-air programming via an antenna. Refer to page 5 for more details.

Use the ANTENNA button to toggle between these RF inputs.



**VIDEO IN** Lets you connect devices which have Audio/Video (composite) outputs such as VCRs, DVD players, satellite receivers, cable boxes, camcorders and video game consoles. Connect the left and right audio jacks for sound.

- **VIDEO** Provides composite video connection. The video connector is usually yellow.
- **AUDIO-L** Provides left audio connection. The left audio connector is usually white.
- **AUDIO-R** Provides right audio connection. The right audio connector is usually red.

To access the device when using these jacks, use the INPUT button on your remote until *VID1* appears.

- **OR** -

S-VIDEO



**S-VIDEO** Lets you connect external devices which have S-Video outputs such as: VCRs, DVD players, satellite receivers and cable boxes. Connect the left and right audio jacks for sound. Refer to page 7 for a detailed explanation of how to connect S-Video cables to your TV.

- **AUDIO-L** Provides left audio connection. The left audio connector is usually white.
- **AUDIO-R** Provides right audio connection. The right audio connector is usually red.

To access the device when using these jacks, use the INPUT button on your remote until *SVID* appears.

**Remember:** If you use the S-Video connection described here, you cannot use the VIDEO IN connection at the same time.

# Connections & Setup

---

## The Front of Your TV

You can use the buttons and jacks on the front of your TV to operate many of the TV's features.



**FRONT (INPUT)** These jacks are located on the side of the TV. Lets you connect devices which have composite outputs such as VCRs, DVD players, satellite receivers, cable boxes, video game consoles and camcorders.

- **VIDEO** Provides composite video connection. The video connector is usually yellow.
- **AUDIO-L** Provides left audio connection. The left audio connector is usually white.
- **AUDIO-R** Provides right audio connection. The right audio connector is usually red.

To access the device when using these jacks, use the INPUT button on your remote until *FRNT* appears.

## Front Buttons

**POWER** Turns the TV on and off.

**SENSOR** Receives infrared signals from the remote.

**TV/VIDEO (INPUT)** *Model 27V414T only* Chooses between TV programming and the available Video Input Channels. Acts like the INPUT button on the remote.

**MENU** Brings up the *MAIN MENU*. In the menu system, clears the screen.

**VOLUME -/+** Decreases/increases the volume. In the menu system, acts like the left/right arrow button on the remote control and adjusts menu controls.

**CHANNEL -/+** Scans up and down through the current channel list. In the menu system, acts like the down/up arrow button on the remote control. Use to highlight items.

# Chapter 2: Using the TV's Features

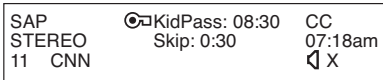

**Channel Banner menu for an analog signal.**

## Channel Banner

There are several items that might appear on-screen when you press the INFO button on the remote. This display is called the Channel Banner. The following list describes the items on the Channel Banner screen.

**SAP** Displayed when the current channel is broadcasting SAP (Second Audio Program) information. Refer to page 25 for more information.

 (lock) or  (unlock) for Parental Control (Refer to page 19).

- The lock icon is displayed when all *Parental Control* settings are active.
- The unlock icon is displayed when all *Parental Control* settings are deactivated.

**KidPass: 08:30** Corresponds to the *KidPass* function (refer to page 23). Shows the amount of time left before the TV switches off.

**CC** Displayed when Closed Captioning is available on the current channel.

**STEREO or (MONO)** *STEREO* is displayed when the current channel is broadcasting in stereo. *MONO* is displayed when the current channel is broadcasting in mono.

**Skip: 0:30** Corresponds to the SKIP button. Shows the amount of time left before the TV switches back to the previous channel. (Refer to page 13).

**07:18 am** Displays the current time.

The following **Channel Banner** display is available for analog signals only:

**11 CNN** Displays the current channel and label assigned to the channel.

The following **Channel Banner** display is available for digital signals only:

**English** Displays the audio language for digital programming. Go to the Sound menu to choose your current and default language settings. Refer to page 26 for more information.

**11-2** Displays the current channel but does not display the channel label that you entered in the *Lists and Labels* screen. Digital signals can contain the channel name and program description. If available, look for that information to be displayed below the current channel number.

 **X** Displayed when you MUTE the sound.

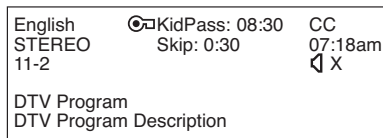

**Channel Banner menu for a digital signal.**

# Using the TV's Features

## Parental Controls and V-Chip

The choices in the *USA V-CHIP* menu involve software inside your TV (referred to as V-Chip) which allows you to block TV programs and movies based on violence, sex or other content you may believe children should not view.

Once you block programs, you can unblock programs by entering a password.

By default, the software inside your TV is turned "off." For instructions to turn on V-Chip, refer to *Activate Parental Control* below.

### How V-Chip Works

V-Chip reads the program's age-based rating (*TV-MA*, *TV-14*, etc.) and content themes (*Violence (V)*, *Adult Language (L)*, etc.). If you have blocked the rating and/or content themes that the program contains, you will receive the message: *This channel has not been approved for viewing. Change channel or press OK to enter password and temporarily deactivate the Parental Control.*

Broadcasters are not required to provide content themes, so programs received with no content themes will only be blocked if you block their age-based rating. You can also block out programs that have been given a rating of Not Rated and programs that are considered unrated.

The TV age-based ratings and content themes you can block are identified and explained in detail in Chapter 4.

The following sections give you more details about how to change the status of TV program limits.

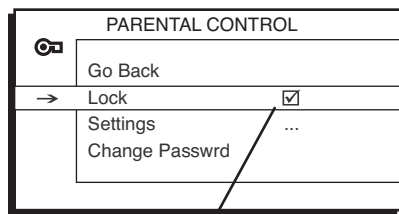

**Parental Control is locked. A password is now necessary to change settings.**

## Activate Parental Control

**Note:** The *PASSWORD* screen appears the first time you enter the *Parental Control* menu. Follow the on screen instructions to create your *PASSWORD* using the number buttons on the remote. If you forget this password, refer to the bottom of this page for instructions on how to change the password.

This feature lets you activate and deactivate parental control features.

From the *PARENTAL CONTROL* menu, press the down arrow button to highlight *Lock*.

Press the right or left arrow button to activate (box has check mark) or deactivate (box doesn't have check mark) *PARENTAL CONTROL* features.

**Remember:** If you do not activate *Parental Control* (by locking it), none of *Parental Control* features will take effect.

## Resetting the Password

If you forget your password, you can reset it. Here is how to do it:

1. Make sure the TV is off.
2. Simultaneously press and hold VOL- on the TV's front panel and CLEAR on the remote for approximately 5 seconds.
3. Enter a new password the next time you access the *PARENTAL CONTROL* menu.

# Using the TV's Features

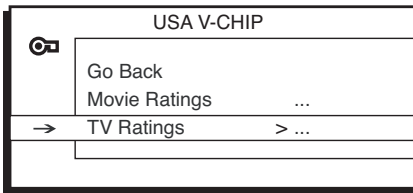

## Set V-Chip TV Programming Limits

1. Choose *Parental Control* from the *Main Menu* and press the OK button.
2. Highlight *Settings* in the next *Parental Control* screen; then, press the right arrow button.
3. Highlight *USA V-Chip*. Press the right arrow button. Then select *TV Ratings* and press the right arrow button.
4. Once you get to the *TV RATING LIMIT* screen, use the arrow buttons and OK on your remote to change the status of a TV program rating from view ( ) to block ( ) or content theme from View (V) to Block (B).

## The V-Chip Rating Screen

The following is an example of where items are located within the *TV RATING LIMIT* screen.

### Rating Status Field

Lets you select whether to view ( ) or block ( ).

### Rating Field

Lets you select from a list of age-based ratings you can block or view. Refer to chart below.

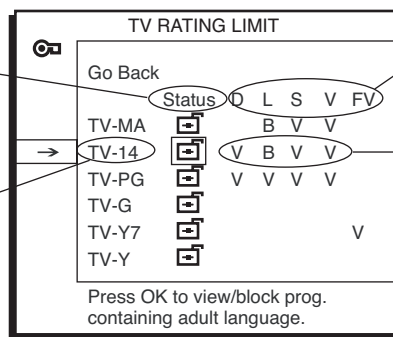

### Content Themes

Lets the content themes you can block or view. Refer to chart at top of next page.

### Content Status Fields

Lets you select which content themes to view for the selected rating and whether the status of the content theme is currently View (V) or Block (B).

Hierarchy of Age-Based Ratings	
TV-MA	Mature Audience Only
TV-14	Parents Strongly Cautioned
TV-PG	Parental Guidance Suggested
TV-G	General Audience
TV-Y7	Directed to Children 7 years and older
TV-Y	All Children

## Blocking Age-Based Ratings

You can automatically block all program ratings above a specified age-based rating level.

To block programs with higher ratings:

1. Press the up or down arrow button to scroll to the rating corresponding with the lowest rating you do not want the child to watch.
2. Press the OK button to toggle between view ( ) and block ( ). The status for the rating listed to the left and all higher ratings automatically changes to block ( ).
3. Press the up or down arrow button to highlight *Go Back* and press OK.
4. After you Block age-based ratings, you can change some of the ratings back to view ( ).

**Note:** You must remember to activate *Parental Control* for rating limits to take effect. Refer to page 18.

# Using the TV's Features

---

Content Themes	
D	Sexually explicit dialogue
L	Adult language
S	Sexual situations
V	Violence
FV	Fantasy Violence

## **Tips:**

Broadcasters are not required to provide content themes or age-based ratings.

Only the content theme status corresponding to TV-14 (L) language changes to (V) View. Higher rated content themes, such as that for TV-MA language, do not change.

---

## Blocking Specific Content Themes

You can block programs based on their content. (Content is represented by the *D*, *L*, *S*, *V* and *FV* on your screen.) When you block a content theme for a particular rating, you automatically block that content theme for higher rated programs as well.

To block program content:

1. Determine the content themes you want to block.
2. Press the down arrow button to scroll to the rating whose content theme you want to change.
3. Press the right arrow button to move the highlight to a particular content theme status.
4. Press the OK button to change its status to *B*. (In the example on the previous page, you block the language (*L*) corresponding with *TV-14*. The language for *TV-MA* is blocked as well).
5. After you Block specific content themes, you can change some of the content themes back to (*V*) view.

**Note:** You must remember to activate Parental Control for rating limits to take effect. Refer to page 18.

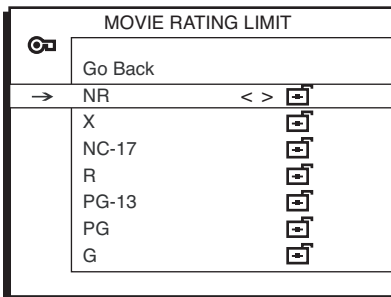
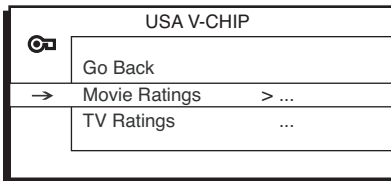
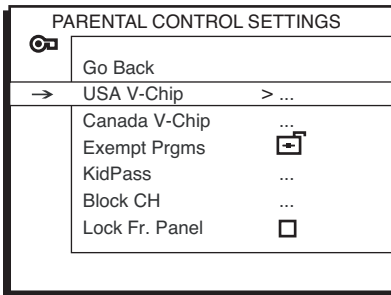
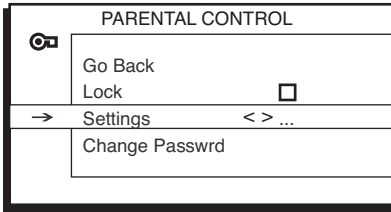

# Using the TV's Features



## Blocking USA V-Chip Movie Ratings

The *Movie Rating Limit* lets you decide which TV programs can and cannot be viewed.

To set Movie programming limits:

1. Choose *Parental Control* from the *Main Menu* and press the OK button.
2. Highlight *Settings* in the next *Parental Control* screen; then, press the right arrow.
3. Highlight *USA V-Chip*. Press the right arrow button. Then select *Movie Ratings* and press the right arrow button.
4. Once you get to the *MOVIE RATING LIMIT* screen, use the arrow buttons and OK on your remote to change the status of a TV program rating from view (  ) to block (  ) .
5. Press the OK button to change its status to block - the lock icon (  ) appears. All ratings above the one you selected change to lock.

**Notes:** You must remember to activate *Parental Control* for rating limits to take effect. Refer to page 18.

If you forget your password, you can reset it. Make sure the TV is off. Simultaneously press and hold VOL- on the TV's front panel and CLEAR on the remote for approximately 5 seconds. Enter a new password the next time you access the *PARENTAL CONTROL* menu.

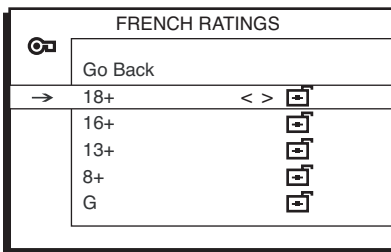
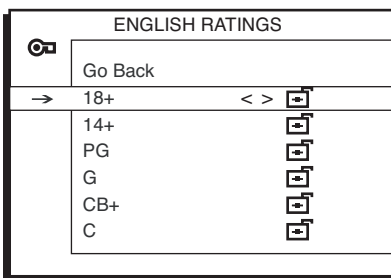
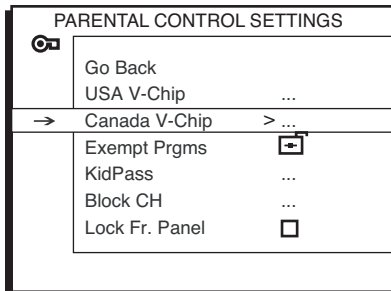
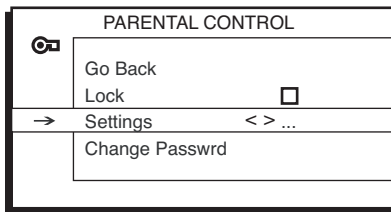

# Using the TV's Features



## Blocking Canadian V-Chip Movie Ratings

If you receive Canadian programs you can block *Canadian English* and *French V-Chip* ratings. When you block a particular rating, you automatically block the higher rated programs as well.

To block Canadian English and French program ratings:

1. Choose *Parental Control* from the *Main Menu* and press the OK button.
2. Highlight *Settings* in the next *Parental Control* screen; then, press the right arrow button.
3. Highlight *Canada V-Chip*. Press the right arrow button. Then select either *English Rating* or *French Rating* and press the right arrow button.
4. Determine the rating you want to block.
5. Once you get to the *RATING* screen for your choice, use the arrow buttons and OK on your remote to change the status of a TV program rating from view (  ) to block (  ).
6. Press the OK button to change its status to block - the lock icon (  ) appears and all ratings above the one you selected change to lock.



**Note:** You must remember to activate *Parental Control* for rating limits to take effect. Refer to page 18.

## V-Chip Exempt Program Block

The *Exempt Prgms* option lets you decide if programs that the V-Chip recognizes as unrated can be viewed. Unrated TV programs may include news, sports, political, religious, local and weather programs, emergency bulletins, public announcements and programs without ratings. The *Exempt* option applies to both USA and Canadian unrated programs, and Canadian programs rated E.

**Unlocked** All unrated programs are available.

**Locked** All unrated programs are not available.

Go to the *Parental Control* screen and pick *Settings* and press OK. In the *Parental Control Settings* screen press the down arrow button to highlight *Exempt Prgms*. Then press the right arrow button to toggle between the lock (  ) and unlock (  ) icon.

**Note:** You must remember to activate *Parental Control* for rating limits to take effect. Refer to page 18.



# Using the TV's Features

KIDPASS	
Go Back	
Current Day	Wed
→ Monday	< > 1:30
Tuesday	2:00
Wednesday	2:00
Thursday	0:30
Friday	Free
Saturday	Free
Sunday	Free

## Activate KidPass

This feature allows you to specify how much TV you want a child to watch. The choices and a brief explanation are as follows:

**Current Day** Shows the current day such as *Monday, Tuesday...* or *Sunday*. The value of *Current Day* changes automatically to the day after at 12:00 am.

**Monday to Sunday** The selected options are *Free, 00:30 to 16:00* with 30 minute steps. The settings are valid every week. Once the viewing allowance of current day is elapsed, the TV is switches off and no wake up timer event can take place for that day. If the TV is switched on while the viewing allowance of current day is elapsed, sound is muted and the *PASSWORD* menu is displayed on the screen. Make sure to set the time and calendar in your TV. Refer to page 34 for more information.

**Note:** You must remember to activate Parental Control for rating limits to take effect. Refer to page 18.

BLOCK CH	
Go Back	
→ Select CH	50
Lock	<input checked="" type="checkbox"/>

## Block Channel

**Note:** This option works differently with different connections. If you are using the *ANTENNA/CABLE DIGITAL INPUT (top jack)* you have two options: to Block All channels or none. Individual channels cannot be blocked with this connection.

If you are using the *ANTENNA/CABLE ANALOG INPUT* then Block Channel works as described below.

This option lets you block specific channels.

1. From the *PARENTAL CONTROL* menu, press the down arrow button to highlight *Block CH*.
2. Press OK to display *Block CH* options.
3. Press the down arrow button to highlight *Select CH* and enter the channel number you want to lock. Refer to page 11 for information about tuning to digital channels with the number buttons. If you would like, you can use the right and left arrow buttons to scroll through the channel numbers.
4. Press the down arrow to highlight *Lock*. Press the right or left arrow to *block* (box has check mark) or *unblock* (box doesn't have check mark) the channel selected on step 3.

In the example to the left, Channel 50 is blocked. You can block as many channels as you like using this procedure.

**Note:** You must remember to activate Parental Control for rating limits to take effect. Refer to page 18.

# Using the TV's Features

---

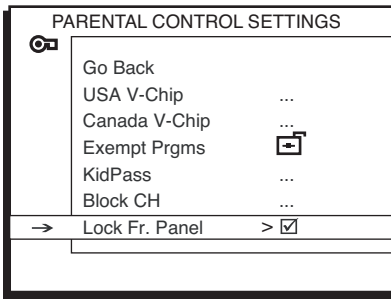

## Front Panel Lock

Selecting this option lets you *lock* (disable) or *unlock* (enable) the TV's front panel buttons. The remote still tunes to any channel; so, remember to remove access to any remote that can operate the television.

1. From the *PARENTAL CONTROL* menu, press the down arrow to highlight *Lock Fr. Panel*.
2. Press the right or left arrow button to turn on (box has check mark) or off (box doesn't have check mark) front panel lock.

## Change Password

Selecting this option lets you simply create a new password at any time. Once you enter a new password from *Change Passwrd* in the *PARENTAL CONTROL* menu, it is the password you use until you change it again.

# Chapter 3: Using the TV's Menu System

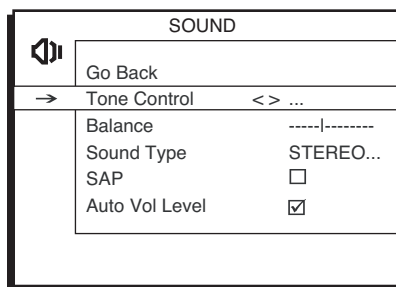

SOUND menu for analog signals.

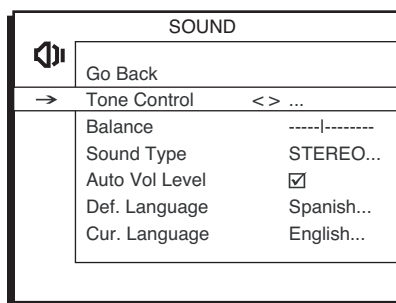

SOUND menu for digital signals.

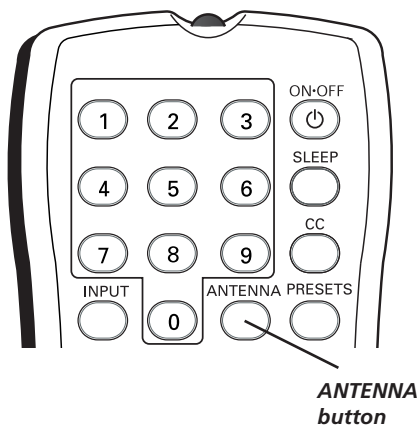

## Sound Menu

To access the Sound menu, press MENU on the remote and select *SOUND* from the *MAIN MENU*. Depending on the kind of signal you're watching, the Sound Menu will have different items available for you to adjust.

If you are watching analog programming or any video inputs, you'll see a screen similar to the example *SOUND* menu to the left.

If you're watching digital programming, you'll see the second menu to the left. The ANTENNA button on the remote toggles between analog and digital menus.

**Tone Control** Allows you to choose your desired sound mode and adjust the equalizer sliders.

- **Preset** Press the left or right arrow button to select your desired sound mode: *Personal*, *Standard*, *Music*, *Speech* and *Theatre*. When you change any equalizer slider, the Preset changes to *Personal*.
- **Treble/Bass** Press the right arrow button to increase the treble or bass output; use the left arrow button to decrease the output.

**Balance** Press the right arrow button to increase the audio output in the right speaker; press the left arrow button to increase the audio output in the left speaker.

**Sound Type** Press the right arrow button to scroll through the available audio types which control the way the sound comes through your speakers:

- **MONO** Plays the sound in mono only. Use this setting when receiving broadcasts with weak stereo signals.
- **STEREO** Splits the incoming stereo audio signal into left and right channels.
- **Enhanced (only available for analog signals)** Makes the sound simulate surround sound.

**Note:** Most TV programs and recorded materials have stereo audio. The word *STEREO* appears on the channel banner when you tune to a program that is broadcast in stereo.

**SAP (Second Audio Program) (only available for analog broadcasts)** Plays the program's audio in a second language, if one is available. The TV displays the word *SAP* in the channel banner when you tune to a program that is broadcast with SAP information. SAP audio is broadcast in mono. SAP is also used to broadcast a program's audio with descriptions of the video for the visually impaired. Press the right arrow button to turn *SAP* on or off.

# Using the TV's Menu System

---

**Auto Vol Level (Auto Volume Level)** Reduces the annoying blasts in volume during commercial breaks. Eliminates the need to constantly adjust volume control. Press the right arrow button to turn on or off.

The following items are available for digital broadcasts only:

**Def. Language (Default Digital Channel Audio Language)** Press the right arrow button to choose the language you prefer for dialog on digital channels. If your preferred language is being broadcast with a program, the TV will play it. If not, then the TV will play the default audio for the program (usually English in the U.S.). The default digital channel audio language options are *English, Spanish, German, Italian, Japanese, Chinese* and *Korean*.

**Cur. Language (Current Digital Channel Audio Language)** Press the right arrow button to choose the audio language available for the program you're watching. The language you choose becomes your preferred audio language for all channels on the digital tuner until you turn the TV off. If the language you choose here is not being broadcast with a program, then the TV will play the default audio for the program (usually English in the U.S.).

# Using the TV's Menu System

PICTURE	
Go Back	
→ Picture Preset	<> Soft...
Pict. Enhanc.	High...
Color Warmth	Normal...
Brightness	----- -----
Contrast	----- -----
Color	----- -----
Sharpness	----- -----
Tint	----- -----

## Picture Menu

The *PICTURE* menu options apply to the video for the main TV and Video Input Channels. As you scroll through the options available, the background image will change to fit that choice. Choose the setting that is best for your programs.

Press the left or right arrow button to toggle among the choices listed below:

**Picture Preset** Press the right arrow button to scroll through the available picture preset settings: *Soft*, *Natural*, *Bright* or *Personal*.

**Pict Enhanc. (Picture Enhancement)** Improves unstable or poor quality video pictures. Press the right arrow button to scroll through the options: *Off*, *Middle* or *Highb*.

**Color Warmth** Press the right arrow button to scroll through the color adjustments:

- **Cool** For a more blue palette of colors.
- **Normal** Standard picture color. This is the default setting.
- **Warm** For a more red palette of colors.

**Brightness** Adjusts the brightness of the picture.

**Contrast** Adjusts the difference between the light and dark areas of the picture.

**Color** Adjusts the richness of the color.

**Sharpness** Adjusts the crispness of the edges in the picture.

**Tint** Adjusts the balance between the red and green levels.

When you change any of these picture settings, the *Picture Preset* changes to *Personal*. Use the left or right arrow button to make adjustments. To return to the *PICTURE* menu, press the up or down arrow button.

# Using the TV's Menu System

SETUP	
Go Back	
→ Auto Ch. Search <> ...	
List & Labels	...
Closed Caption	...
Favorite CH	...
Language	English...
Format	4:3

AUTO CHANNEL SEARCH	
Go Back	
→ Signal Source <> Digital...	
Digital Signal Type	Cable...
Start	...
Search percent	0
Digital Channel	0

**AUTO CHANNEL SEARCH menu for digital signals.**

## Setup Menu

**Auto Ch. Search (Auto Channel Search)** Allows you to choose your signal type and begin an Auto Channel Search.

Press the left or right arrow button to choose among the signal sources below:

- **Both** If you have connected both coaxial inputs on the back panel of your TV, you can choose to do your Auto Channel Search on both connections at one time by making this choice. Refer to page 5 for a complete explanation of these connections.
- **Digital** Choose if you are connected to the *ANTENNA/CABLE DIGITAL INPUT* jack.
- **Analog** Choose if you are connected to the *ANTENNA/CABLE ANALOG INPUT* jack.

Now use the down arrow button to choose a signal type.

- **Digital Signal Type** Choose between *Cable* or *Antenna* if you are connected to the *ANTENNA/CABLE DIGITAL INPUT* jack. If you chose *Both* above, then you'll need to choose a signal type for your digital and analog connections.
- **Analog Signal Type** Choose between *Cable* or *Antenna* if you are connected to the *ANTENNA/CABLE ANALOG INPUT* jack. If you chose *Both* above, then you'll need to choose a signal type for your digital and analog connections.

After you have made the selections above, use the down arrow button to highlight *Start*.

- **Start** Press the right arrow button to start the search. Searches for channels the TV is receiving and stores them in the channel list. Go to page 11 (*Auto Channel Search*) for more information.
- **Search percent** Number displayed indicates how much of the search has been completed on a digital signal.
- **Analog Channel** Shows the channel numbers as they are being searched.
- **Digital Channel** Shows the number of channels found as they are being searched.

# Using the TV's Menu System

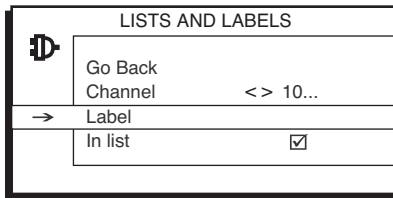

**List & Labels** Edit the channels in the list or choose labels for each channel. Select *Lists & Labels* from the *SETUP* menu and press the right or left arrow button.

- **Channel** Press the right or left arrow button to select the channel number that you want to give a label. Press the down arrow button to highlight *Label*.
- **Label** For example, if channel 12 has the call letters WXYZ, you can use this feature to label it WXYZ so it appears on-screen as part of the Channel Banner.

1. Press the right arrow button to highlight the first space.
2. Use the number buttons on your remote to spell out your new label. For example, above the number button 7 is the label PQRS. The letter P is typed by pressing the number 7 button one time; the letter Q is typed by pressing the number 7 two times; the letter R is three times and the letter S is four times.
3. Move spaces with the right and left arrow buttons.
4. Use the up arrow button to highlight *Go Back* and press OK to exit this menu when you have finished.

- **In List** This option allows you to keep or delete a channel from the channel list. Follow the procedure for *Channel* (see above) to select the channel. Then highlight *In list* and press the right arrow button to add the check mark. The channel is added to the list. To delete the channel use the right arrow button to turn the check mark off. Use the up arrow button to highlight *GO BACK* or press *OK* to exit.

**Note:** If you want to add deleted channels to the channel list, run the *Auto Channel Search* (refer to page 28).

# Using the TV's Menu System

---

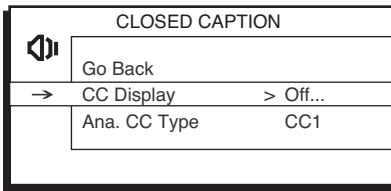

**CLOSED CAPTION menu for analog signals.**

**Closed Caption** Many programs are encoded with closed-captioning information, which lets you display the audio portion of a program as text on the TV screen. Closed captioning is not available on all channels at all times. Only specific programs encoded with closed-captioning information are applicable. When a program is closed-captioned, *CC* is displayed in the Channel Banner. Refer to page 17 for more information. Press the left or right arrow button to toggle among the choices below:

The following **Closed Caption** options are available for analog signals:

- **CC Display** Lets you choose the way closed-captioning information is shown on the screen.
  - Off** No captioning information displayed.
  - On** Captioning information always appears, when available.
  - Muted=On** Displays captioning information, when available, whenever the TV's sound is muted by pressing the MUTE button. The captioning information is not displayed when the sound is not muted.
- **Ana. CC Type (Analog Closed Caption Type)** Choose which captioning mode is used for displaying captioning information. If you are unsure of the differences among the modes, you may prefer to leave the closed-captioned mode set to *CC1*, which displays complete text of the program in the primary language in your area.



# Using the TV's Menu System

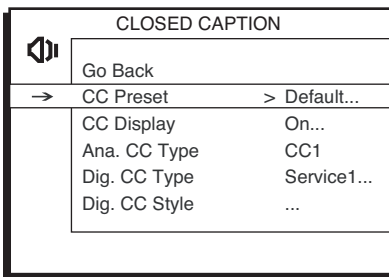

**CLOSED CAPTION menu for digital signals**

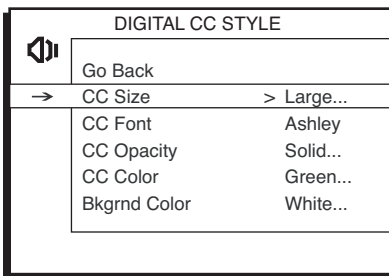

**Notes:** The styles shown above only appear on digital content (ANTENNA/CABLE DIGITAL INPUT) jack. If a digital station doesn't carry digital closed captioning, you won't see these changes.

If you're tuned to an analog station you won't see these changes.

The following **Closed Caption** options are available for digital signals:

- **CC Preset** Lets you select between the *Default* and *Custom* options.
  - Default** Captioning information displays using settings sent with the broadcaster's signals (e.g., size, color, font).
  - Custom** Available after you have changed the *Dig. CC Style* settings as described below.
- **CC Display** Lets you choose the way closed captioning information is shown on the screen.
  - Off** No captioning information displayed.
  - On** Captioning information always appears, when available.
  - Muted=On** Displays captioning information, when available, whenever the TV's sound is muted by pressing the MUTE button. The captioning information is not displayed when the sound is not muted.
- **Dig. CC Type (Digital Closed-Caption Type)** Lets you select a closed caption service mode (1-6) for digital channels.
  - Service 1 and Service 2** These choices are for the primary and secondary languages, respectively
  - Service 3 and Services 4, 5, 6** These choices are additional caption sources that may be available.
- **Dig. CC Style (Digital Closed-Caption Style)** When *CC Preset* (above) is set to *Custom*, you can customize the following display options:
  - CC Size** Lets you set the size of the digital closed-caption text - *Standard, Large* or *Small*.
  - CC Font** Lets you select a character design for the digital closed-caption text. A font is a complete assortment of type of a given design. You can choose from a variety of fonts (Ashley, Floridian etc.).
  - CC Opacity** Lets you set the appearance of the space behind the digital closed-caption text: *Solid, Translucent, Transparent* or *Flashing*.
  - CC Color** Lets you choose the color of the digital closed-captioned text: *White, Black, Red, Green, Blue, Yellow, Magenta* or *Cyan*.
  - Bkgrd Color (Background Color)** Lets you choose the color of the area of the screen behind the digital closed-captioned text: *White, Black, Red, Green, Blue, Yellow, Magenta* or *Cyan*.

"Monotype" is a trademark of Monotype Imaging, Inc. registered in the U.S. Patent and Trademark Office and may be registered in certain other jurisdictions.

"iType" is a trademark of Monotype Imaging, Inc. and may be registered in certain other jurisdictions.

"Floridian", "Plate Gothic", and "Screen" are trademarks of The Monotype Corporation and may be registered in certain other jurisdictions.

"Ashley" is a trademark of The Monotype Corporation Registered in the U.S. Patent and Trademark Office and may be registered in certain other jurisdictions.

*Continues on next page...*

# Using the TV's Menu System

You have many choices available to customize the digital closed-caption display. In order to help you decide which view you like, try this:

1. In the Setup Menu for Closed Caption, turn your CC Display ON.
2. In the same menu, go to Dig. CC Style and change any setting.
3. Press CLEAR until you have cleared the menu system.
4. If you do not have a signal with closed-captioning on the TV screen at this time, change to another digital station that does have closed-caption display.
5. Return to SETUP/Closed Caption/Dig. CC Style options.
6. Now your TV is displaying custom closed-captioning. As you change size, font, opacity, caption color or background color, you will be able to see the change it will make to the closed-caption display by waiting for new text to scroll onto the screen.

Not all digital stations carry digital closed captioning. If your digital station doesn't carry digital closed captioning, you won't see these changes. You'll see the station's default style for analog closed captioning.

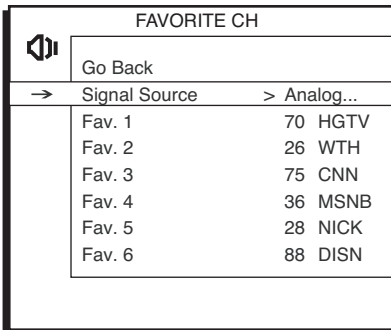

FAVORITE CH		
Go Back		
→	Signal Source	> Analog...
	Fav. 1	70 HGTV
	Fav. 2	26 WTH
	Fav. 3	75 CNN
	Fav. 4	36 MSNB
	Fav. 5	28 NICK
	Fav. 6	88 DISN

**FAVORITE CH menu for analog signals.**

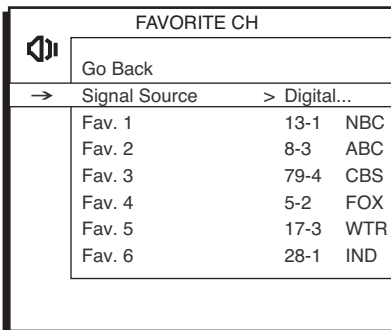

FAVORITE CH		
Go Back		
→	Signal Source	> Digital...
	Fav. 1	13-1 NBC
	Fav. 2	8-3 ABC
	Fav. 3	79-4 CBS
	Fav. 4	5-2 FOX
	Fav. 5	17-3 WTR
	Fav. 6	28-1 IND

**FAVORITE CH menu for digital signals.**

***Favorite CH (Favorite Channel)*** Lets you store up to six of your preferred channels for each signal source into a favorite list. Find your favorites easily by pressing the FAV button on the remote. There is one list for the analog channels and a separate list for the digital channels.

To set your favorite channels, go to the *Favorite CH* option under the *SETUP* menu and press OK. Use the right arrow button to select *Analog* or *Digital* signal type (the TV will switch to that signal). Use the down arrow button to select *Fav. 1* and use the right and left arrow buttons to scroll through the channel numbers to find your favorite. Set as many favorites as you would like (up to six). If you have entered channel labels for a channel, it will appear to the right.

As you watch TV, you can now press the FAV button on your remote to call up your favorite list channels in the order in which you entered them.

This feature can be very helpful for persons with limited finger dexterity or young children, since it avoids the need to remember the channel numbers and press multiple number combinations.

# Using the TV's Menu System



gray or  
black  
bars

16 : 9 Format



Stretch format (stretched  
vertically to fill the 4 : 3 screen)

**Language** Lets you select your preferred language for the menus, which you should have set in the Initial Setup. (Refer to page 11 for more information about setup). You can change the language at any time by using the right or left arrow buttons to scroll through the language (*English, Spanish and French*).

**Format** This feature is designed for the different signal formats.

**4 : 3** This is a full TV screen display which is for traditional TV programs.

**16 : 9** This is for digital signals, DVD or video programs that are in 16 : 9 screen size. There are gray or black bars on the top and bottom on the screen.

**Stretch** The image is stretched vertically to fill the TV screen (for digital content only).

**Note:** *The right arrow/Zoom+ and left arrow/Zoom- buttons on the remote change the TV's screen format.*

## Parental Control Menu

The *PARENTAL CONTROL* menu was explained in Chapter 2. Go to page 18 for more information.

# Using the TV's Menu System

TIME	
Go Back	
Sleep Timer	00:45
→ Time	08:25am
Calendar	...
Wake-up Timer	<input checked="" type="checkbox"/>
Wake-up Time	08:15am
Wake-up Ch	05
Recurrence	Once...
Turn-Off Timer	<input checked="" type="checkbox"/>
Turn-Off Time	10:00pm
Recurrence	Daily...

## Time Menu

When entering the *TIME* menu the *PASSWORD* screen appears first if parental controls have been set. You must enter your password which is the same one you created in the *PARENTAL CONTROL* menu.

**Sleep Timer** Lets you set the TV to turn off after a given time. Press the right arrow button to add 15 minutes to the clock (up to four hours).

**Time** To set the time, enter it manually. If it is 8:25, for example, you must first press the number 0 on the remote, then number 8, then 2 and then 5. Use the OK button to choose between *AM* and *PM*.

**Calendar** Enables you to set the date easily.

**Wake-Up Timer** Lets you set the TV to turn on (at a specific time).

*Notes: Unless Wake-Up Timer is set to On, the next three options (Wake-Up Time, Wake-up Ch and Recurrence) aren't available.*

*When the TV turns on by the Wake-Up Timer and no remote or front panel buttons are pressed for 2 hours, the TV will turn itself off.*

**Wake-Up Time** Lets you set the time you want the TV to turn itself on.

**Wake-Up Ch (Wake-Up Channel)** Lets you select a specific channel the TV tunes to when the *Wake-up Timer* is set.

**Recurrence** Lets you select how often the *Wake-Up Timer* feature takes effect: *Once* or *Daily*.

**Turn-Off Timer** Lets you set the TV to turn itself off.

**Turn-Off Time** Lets you set the time you want the TV to turn itself off.

**Recurrence** Lets you select how often the *Turn-Off Timer* feature takes effect: *Once* or *Daily*.

*Note: Unless the time is set, none of the time related items above are available.*

# Using the TV's Menu System

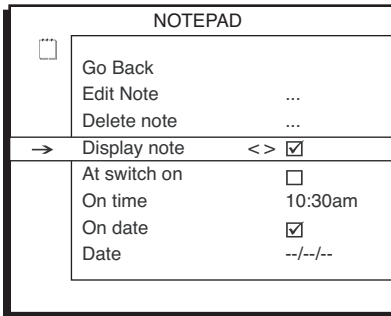
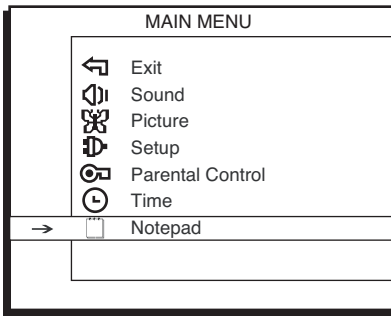

## Notepad Menu

Lets you enter messages that will appear on you TV screen at times you select. From the *MAIN MENU* select *Notepad* and press OK.

**Edit note** Follow the procedure below to enter a message into the notepad:

1. Use the number buttons to spell out your new label.  
For example, above the number button 7 is the label **PQRS**. The letter **P** is typed by pressing the number 7 button one time; the letter **Q** is typed by pressing the number 7 two times; the letter **R** is three times and the letter **S** is four times.
2. The left arrow button is used to delete the unwanted text and the right arrow button is for the blank space.
3. The up arrow button is pressed to toggle the entry mode between uppercase or lowercase letters.
4. When completed, press the OK button to save the note.

**Delete note** Lets you delete the whole message.

**Display note** Enables you to display (the box has check mark) or not to display (the box doesn't have check mark) the message on the screen.

**At switch on** If the box is checked, the stored message will be displayed on the screen the next time the TV is turned on.

**On time** Enables you to display the message at a time you specify. Use the OK button to choose between *AM* and *PM*.

**On date** Allows you to display the message on a date you specify.

**Date** Lets you set the date when the message will be displayed.

## Chapter 4: Other Information

### USA V-Chip Rating System

<b>TV-MA</b>	<b>(Mature Audience Only)</b> Specifically designed to be viewed by adults and may be unsuitable for children under 17. It contains one or more of the following content themes: crude indecent language (L), explicit sexual activity (S), or graphic violence (V).
<b>TV-14</b>	<b>(Parents Strongly Cautioned)</b> Contains some material that many parents would find unsuitable for children under 14. Parents are strongly urged to exercise greater care in monitoring this program and are cautioned against letting children under the age of 14 watch unattended. This program contains one or more of the following content themes: intensely suggestive dialogue (D), strong coarse language (L), intense sexual situations (S), or intense violence (V).
<b>TV-PG</b>	<b>(Parental Guidance Suggested)</b> Contains material that parents may find unsuitable for younger children. Many parents may want to watch it with their younger children. The program contains one or more of the following content themes: some suggestive dialogue (D), infrequent coarse language (L), some sexual situations (S), or moderate violence (V).
<b>TV-G</b>	<b>(General Audience)</b> Most parents would find this program suitable for all ages. It contains little or no sexual dialogue (D) or situations (S), no strong language (L), and little or no violence (V).
<b>TV-Y7</b>	<b>(Directed to Children 7 years and older)</b> Designed for children ages 7 and above. It may be more appropriate for children who have acquired the developmental skills needed to distinguish between make-believe and reality. Themes and elements in this program may include mild fantasy violence (FV) or comedic violence, or may frighten children under the age of 7.
<b>TV-Y</b>	<b>(All Children)</b> Themes and elements in this program are designed for a young audience, including children from ages 2-6. It is not expected to frighten younger children.

### Canadian English V-Chip Rating System

<b>18+</b>	<b>(Adults)</b> Programming intended for adults 18 and older. It may contain elements of violence, language, and sexual content which could make it unsuitable for viewers under 18. Violence Guidelines: May contain violence integral to the development of the plot, character or theme, intended for adult audiences. Other Content Guidelines: May contain graphic language and explicit portrayals of nudity and/or sex.
<b>14+</b>	<b>(Viewers 14 and over)</b> Programming contains themes or content which may not be suitable for viewers under the age of 14. Parents are strongly cautioned to exercise discretion in permitting viewing by pre-teens and early teens. Violence Guidelines: May contain intense scenes of violence. Could deal with mature themes and societal issues in a realistic fashion. Other Content Guidelines: May contain scenes of nudity and/or sexual activity. There could be frequent use of profanity.
<b>PG</b>	<b>(Parental Guidance)</b> Programming intended for a general audience but which may not be suitable for younger children (under the age of 8). Parents may consider some content inappropriate for unsupervised viewing by children aged 8-13. Violence Guidelines: Depictions of conflict and/or aggression will be limited and moderate; may include physical, fantasy, or supernatural violence. Other Content Guidelines: May contain infrequent mild profanity, or mildly suggestive language. Could also contain brief scenes of nudity.

## Canadian English V-Chip Rating System (continued)

<b>G</b>	<b>(General Audience)</b> Programming considered acceptable for all age groups. While not designed specifically for children, it is understood younger viewers may be part of the audience. Violence Guidelines: Will contain very little violence, either physical or verbal or emotional. Will be sensitive to themes which could frighten a younger child, will not depict realistic scenes of violence which minimize or gloss over the effects of violent acts. Other Content Guidelines: There may be some inoffensive slang, no profanity and no nudity.
<b>C8+</b>	<b>(Children 8 and Older)</b> Programming generally considered acceptable for children 8 years and over to watch on their own. Violence Guidelines: Violence will not be portrayed as the preferred, acceptable, or only way to resolve conflict or encourage children to imitate dangerous acts which they may see on television. Any realistic depictions of violence will be infrequent, discreet, of low intensity and will show the consequences of the acts. Other Content Guidelines: There will be no profanity, nudity or sexual content.
<b>C</b>	<b>(Children)</b> Programming intended for children under age 8. Violence Guidelines: Careful attention is paid to themes which could threaten children's sense of security and well being. There will be no realistic scenes of violence. Depictions of aggressive behavior will be infrequent and limited to portrayals that are clearly imaginary, comedic or unrealistic in nature. Other Content Guidelines: There will be no offensive language, nudity or sexual content.

## Canadian French V-Chip Rating System

<b>18+</b>	<b>(Adults)</b> Programming is for adults only. This program contains sustained violence or extremely violent scenes. 16+ (Viewers 16 and over) Programming is not suitable for those under age 16. This program contains frequent scenes of violence or intensely violent scenes.
<b>13+</b>	<b>(Viewers 13 and over)</b> Programming may not be suitable for children under the age of 13. This program either contains several violent scenes or one or more scenes that are violent enough to affect them. Viewing in the company of an adult is therefore strongly recommended for children under the age of 13.
<b>8+</b>	<b>(Viewers 8 and over)</b> Not recommended for young children. This program is suitable for most audiences, but it contains mild or occasional violence that could upset young children. Viewing in the company of an adult is therefore recommended for young children (under the age of 8) who do not distinguish between reality and imagination.
<b>G</b>	<b>(General Audience)</b> This program is suitable for audiences of all ages. It contains no violence, or any violence that it does contain is either minimal or is presented in a humorous manner, as a caricature, or in an unrealistic way.

# Other Information

---

## Troubleshooting

Most problems you encounter with your TV can be corrected by consulting the following troubleshooting list.

**Note for U.S. customers:** *If you prefer, we can provide you with the name of an Authorized Service Representative who will visit your home for a fee to install your electronic entertainment system and to instruct you in its operation. For details about this service, call 1-888-206-3359. For additional assistance while using your RCA product, please visit [www.rca.com/customersupport](http://www.rca.com/customersupport).*

### TV Problems

---

#### TV won't turn on

- Make sure the TV is plugged in.
- Check the wall receptacle (or extension cord) to make sure it is "live" by plugging in something else.
- Something might be wrong with your remote control. Press the POWER button on the front of the TV. If the TV turns on, check the remote control.
- The Front Panel Lock may be *on*. Go to page 24 for more information.

#### Buttons don't work

- The Front Panel Lock may be *on*. Go to page 24 for more information.

#### TV turns off unexpectedly

- *Sleep* timer might have been activated. Go to page 34 for instructions.
- *Turn Off-Timer* might have been activated. Go to page 34 for instructions.
- *KidPass* might have been set. Go to page 23 for instructions.
- Electronic protection circuit may have been activated because of a power surge. If this happens frequently, the voltage in your house may be abnormally high or low.

#### TV turns on unexpectedly

- *Wake-Up Timer* might have been set. Go to page 34 for instructions.

#### Blank screen

- You may be on an inactive channel. Try another channel.
- Make sure devices connected to the TV are turned on.
- If you've connected another device (such as a camcorder or DVD player) make sure you select the Video Input Channel that is used for that device. Use the INPUT button to toggle through the available Video Input Channels.

#### Digital tuning delayed

- You may experience a delay of several seconds before digital pictures appear, both when you first turn on the digital signals and when you change channels. This is normal.

#### No sound, picture okay

- Maybe the sound is muted. Try pressing the volume up button to restore sound.
- If using S-Video, remember to also connect the device's left and right audio output jacks to the TV's AUDIO input jacks.



## Can't select certain channel

- Channel may be blocked or not approved through *PARENTAL CONTROLS*.
- If using a VCR, check to make sure the TV/VCR button on the VCR is in the correct mode (press the TV/VCR button on your VCR).

## Noisy stereo reception (analog channels only)

- May be a weak station. Change the *Sound Type* to *Mono*. Go to page 25 for more instructions.

## No picture, no sound but TV is on

- Maybe the *signal type* is set wrong. Go to page 11 for more instructions.
- You may have the wrong video input channel selected. Use the ANTENNA button to toggle through the available video input channels.

## Sound okay, picture poor (analog channels only)

- Check antenna connections. Make sure all of the cables are firmly connected to the jacks.
- Try adjusting sharpness to improve weak signals. Go to page 27 for more instructions.

## Black box appears on the screen

- Closed caption might be on. Check *CC* in the *SETUP* menu. Go to page 30 for more instructions.

## ***The Remote Control Doesn't Work***

---

- Something might be between the remote and the remote sensor on the device. Make sure there is a clear path and point directly at the TV.
- Maybe batteries in the remote are weak, dead or installed incorrectly. Put new batteries in the remote.

## ***Problems with Parental Controls***

---

### Can't select a certain channel

- The channel may be blocked or not approved through *PARENTAL CONTROL SETTINGS*.

### The rating limits don't work

- You must activate the settings. Go to page 18 for instructions.

### I don't remember my password and I want to unlock the TV

- If you forget your password, you can reset it. Make sure the TV is off. Simultaneously press and hold VOL- on the TV's front panel and CLEAR on the remote for approximately 5 seconds. Enter a new password next time you access the *PARENTAL CONTROL* menu.

### The Parental Controls won't let me watch a program even though it's not rated as violent

- Maybe the movie was given an NR (Not Rated) status. Check to see if the *Exempt Prgms* option is Locked. Refer to page 22 for instructions.

## ***How do I replace my remote***

---

- If you need to replace your remote, call 1-800-338-0376. A shipping and handling fee will be charged upon ordering, and the appropriate sales tax. Have your Visa, MasterCard or Discover Card ready. Your remote part number is R130A1.

# Other Information

---

## Limited Warranty

### What your warranty covers:

- Defects in materials or workmanship.

### For how long after your purchase:

- 90 days from date of purchase for labor charges.
- One year from date of purchase for parts.
- Two years from date of purchase for the picture tube.

### What we will do:

- Pay any Authorized RCA Television Service Center the labor charges to repair your television.
- Pay any Authorized RCA Television Service Center for the new or, at our option, refurbished replacement parts and picture tubes required to repair your television.

### How you get service:

- For screen sizes of 26" and smaller: Take your RCA television to any Authorized RCA Television Service Center and pick up when repairs are complete.
- For screen sizes larger than 26": Contact the Service Center and arrange service. If your unit is located within the geographic territory covered by an Authorized Service Center, the Authorized Service Center will either arrange for service to be performed in your home or for pick-up and return service to enable the Authorized Service Center to perform service at the Authorized Service Center. If your unit is not located within the geographic territory covered by an Authorized Service Center, you must take your unit to the Service Center location at your own expense, or pay for the cost the Service Center may charge to transport your unit to and from your home.
- To identify your nearest Authorized RCA Television Service Center, ask your dealer, visit [www.rca.com](http://www.rca.com), look in the Yellow Pages, or call 1-800-336-1900.
- Proof of purchase in the form of a bill of sale or receipted invoice which is evidence that the product is within the warranty period must be presented to obtain warranty service. For rental firms, proof of first rental is also required.

### What your warranty does not cover:

- Customer instruction. (Your Owner's Manual describes how to install, adjust, and operate your television. Any additional information should be obtained from your dealer).
- Installation and related adjustments.
- Signal reception problems not caused by your television.
- Damage from misuse or neglect.
- Batteries.
- Customer replacement fuses.
- Damage from images burnt onto the screen.
- Special, incidental or consequential damages.

- A television that has been modified or incorporated into other products or is used for institutional or other commercial purposes.
- A television purchased or serviced outside the U.S.A.
- Acts of nature, such as but not limited to lightning damage.

### **Product registration:**

- Please complete and mail the Product Registration Card packed with your TV. It will make it easier to contact you should it ever be necessary. The return of the card is not required for warranty coverage.

### **Limitation of Warranty:**

- THE WARRANTY STATED ABOVE IS THE ONLY WARRANTY APPLICABLE TO THIS PRODUCT. NO VERBAL OR WRITTEN INFORMATION GIVEN BY TTE TECHNOLOGY, INC., ITS AGENTS OR EMPLOYEES SHALL CREATE A GUARANTY OR IN ANY WAY INCREASE OR MODIFY THE SCOPE OF THIS WARRANTY.
- REPAIR OR REPLACEMENT AS PROVIDED UNDER THIS WARRANTY IS THE EXCLUSIVE REMEDY OF THE CONSUMER. TTE TECHNOLOGY, INC. SHALL NOT BE LIABLE FOR SPECIAL, INCIDENTAL OR CONSEQUENTIAL DAMAGES RESULTING FROM THE USE OF THIS PRODUCT OR ARISING OUT OF ANY BREACH OF ANY EXPRESS OR IMPLIED WARRANTY ON THIS PRODUCT. THIS DISCLAIMER OF WARRANTIES AND LIMITED WARRANTY ARE GOVERNED BY THE LAWS OF THE STATE OF INDIANA. EXCEPT TO THE EXTENT PROHIBITED BY APPLICABLE LAW, ANY IMPLIED WARRANTY OF MERCHANTABILITY OR FITNESS FOR A PARTICULAR PURPOSE ON THIS PRODUCT IS LIMITED TO THE APPLICABLE WARRANTY AND WARRANTY PERIOD SET FORTH ABOVE.

### **How state law relates to this warranty:**

- Some states do not allow the exclusion nor limitation of incidental or consequential damages, or limitations on how long an implied warranty lasts, so the above limitations or exclusions may not apply to you.
- This warranty gives you specific legal rights, and you also may have other rights that vary from state to state.

### **If you purchased your unit outside the United States or seek warranty coverage outside the United States:**

- This warranty does not apply. Contact your dealer for warranty information.

Service calls which do not involve defective materials or workmanship are not covered by this warranty. Costs of such service calls are the sole responsibility of the purchaser.

# Other Information

---

## Care and Cleaning

**CAUTION:** Turn OFF your TV before cleaning.

You can clean the TV as required, using a soft lint-free cloth. Be sure to occasionally dust the ventilation slots in the cabinet to help assure adequate ventilation.

**The TV's screen may be cleaned with a soft, lint-free cloth as well. Take care not to scratch or mar the screen. If necessary, you may use a cloth dampened with warm water. Never use strong cleaning agents, such as ammonia-based cleaners, or abrasive powder. These types of cleaners will damage the TV.**

While cleaning do not spray liquid directly on the screen, or allow liquid to run down the screen and inside the TV. Also, never place drinks or vases with water on top of the TV. This could increase the risk of fire or shock hazard or damage to the TV.

**Caution:** Using video games or any external accessory with fixed images for extended periods of time can cause them to be permanently imprinted on the picture tube (or projection TV picture tubes). ALSO, some network/program logos, phone numbers, etc. may cause similar damage. This damage is not covered by your warranty.

### FCC Information

This equipment has been tested and found to comply with the limits for a Class B digital device, pursuant to Part 15 of the FCC Rules. These limits are designed to provide reasonable protection against harmful interference in a residential installation. This equipment generates, uses, and can radiate radio frequency energy and, if not installed and used in accordance with the instructions, may cause harmful interference to radio communications. However, there is no guarantee that interference will not occur in a particular installation. If this equipment does cause harmful interference to radio or television reception, which can be determined by turning the equipment off and on, the user is encouraged to try to correct the interference by one or more of the following measures:

1. Reorient or relocate the receiving antenna.
2. Increase the separation between the equipment and receiver.
3. Connect the equipment into an outlet on a circuit different from that to which the receiver is connected.
4. Consult the dealer or an experienced radio/TV technician for help.

This Class B digital apparatus complies with Canadian ICES-003.

*This page intentionally left blank.*

*This page intentionally left blank.*

**Visit the RCA website at [www.rca.com/television](http://www.rca.com/television)**

Please do not send any products to the Indianapolis address listed in this manual or on the carton. This will only add delays in service for your product.

**TTE Technology, Inc.**

101 West 103rd Street  
Indianapolis, IN 46290

**©2006 TTE Technology, Inc.**

RCA and associated marks are trademarks of THOMSON S.A. used under license to TTE Corporation.

Printed in USA

**TOCOM 16625650**



## Free Manuals Download Website

<http://myh66.com>

<http://usermanuals.us>

<http://www.somanuals.com>

<http://www.4manuals.cc>

<http://www.manual-lib.com>

<http://www.404manual.com>

<http://www.luxmanual.com>

<http://aubethermostatmanual.com>

Golf course search by state

<http://golfingnear.com>

Email search by domain

<http://emailbydomain.com>

Auto manuals search

<http://auto.somanuals.com>

TV manuals search

<http://tv.somanuals.com>