

# IMPORTANT SAFETY INSTRUCTIONS

- Read these instructions.
- Keep these instructions.
- Heed all warnings.
- Follow all instructions.
- Do not use this apparatus near water.
- Clean only with a dry cloth.
- Do not block the ventilation openings. Install in accordance with the manufacturer's instructions.
- Do not install near any heat sources such as radiators, heat registers, stoves, or other apparatus (including amplifiers) that produce heat.
- Do not defeat the safety purpose of the polarized or grounding - type plug. A polarized plug has two blades with one wider than the other. A grounding type plug has two blades and a third grounding prong. The wide blade or the third prong are provided for your safety. If the provided plug does not fit into your outlet, consult an electrician for replacement of the obsolete outlet.
- Protect the power cord from being walked on or pinched particularly at plugs, convenience receptacles, and the point where they exit from the apparatus.
- Only use attachments/accessories specified by the manufacturer.
- Use only with a cart, stand, tripod, bracket, or table specified by the manufacturer, or sold with the apparatus. When a cart is used, use caution when moving the car/apparatus combination to avoid injury from tip-over.
- Unplug this apparatus during lightning storms or when unused for long periods of time.
- Refer all servicing to qualified service personnel. Servicing is required when the apparatus has been damaged in any way, such as power-supply cord or plug is damaged, liquid has been spilled or objects have fallen into the apparatus, the apparatus has been exposed to rain or moisture, does not operate normally, or has been dropped.

## DISC FORMATS

This unit can play **DVDs** (8cm/12cm disc) **COMPACT DIGITAL AUDIO** Audio CDs (8cm/12cm disc) **CD-R CD-RW** Compatible

**Region Management Information**  
Region Management Information: This unit is designed and manufactured to respond to the Region Management Information that is encoded on DVDs. If the region number printed on the DVD does not correspond to the region number of this unit, it cannot play that disc.

The region number of this unit is 1.

**Disc Function or Operation that is Not Available**  
When the **Ⓢ** symbol appears on the screen, it indicates that the function or operation attempted is not available at that time. This occurs because the DVD manufacturer determines the specific functions of DVDs. Certain functions may not be available on some DVDs. Be sure to read the documentation provided with the DVD.

**Icons Used on DVDs**  
Sample Icons

- Language selections for audio
- Language selections for subtitles
- Screen aspect ratio
- Multiple camera angles
- Region code indicator

**Title, Chapter and Tracks**  
DVDs are divided into "titles" and "chapters". If the disc has more than one movie on it, each movie would be a separate "title". "Chapters" are sections of titles.  
Audio CDs are divided into "tracks". A "track" is usually one song on an Audio CD.  
**Note:** Numbers identify each title, chapter, and track on a disc. Most discs have these numbers recorded on them, but some do not.

**Notes on Unauthorized Discs**  
You may not be able to play some DVDs on this unit, particularly if they were purchased from outside your geographic area made for business purposes.

## SOUND SYSTEM

**Dolby Digital**  
Dolby Digital is a technology developed by Dolby Laboratories. Soundtracks encoded in Dolby Digital can reproduce from one to 5.1 discrete channels of excellent quality audio.  
The unit automatically recognizes the Dolby Digital bitstream and provides a downmix suitable for two-channel listening. An additional Dolby Digital decoder is required for reproduction of the discrete multi-channel soundtracks available on many DVDs.  
Manufactured under license from Dolby Laboratories.  
"Dolby" and the double-D symbol are trademarks of Dolby Laboratories.

## ACCESSORIES

- Please check and identify the supplied accessories.
- To order accessories visit website <http://www.RCAav.com>
  - Remote Control (with battery).....x 2
  - AC Power Adapter.....x 2
  - Car Power Adapter.....x 1
  - Car Power Splitter.....x 1
  - Mounting Strap.....x 2
  - Audio/Video Cable.....x 1

## REMOTE CONTROL

**Using the Remote Control**

- Point the remote control at the REMOTE SENSOR located on the unit. The remote controls are color-coded. Use the remote control with the player that has the color mark corresponding to the button color of the remote control.
- When using this unit in very bright light, the infrared REMOTE SENSOR may not work properly.
- The maximum effective distance for remote operation is about 16 feet (5 meters).

**TO CHANGE REMOTE BATTERY**

- Open the battery door.
- Insert one CR2025 (3V) size battery.

**BATTERY REPLACEMENT**  
When the battery becomes weak, the operating distance of the remote control will be greatly reduced and you will need to replace the battery.

**Note:** If the remote control is not going to be used for a long time, remove the battery.

**WARNING:** Do not dispose of the battery in a fire or it may leak and/or explode.  
**WARNING:** Batteries shall not be exposed to excessive heat such as sunshine, fire or the like.  
**CAUTION:** Danger of explosion if battery is incorrectly replaced. Replace only with the same or equivalent type.

## CONTROL REFERENCE GUIDE

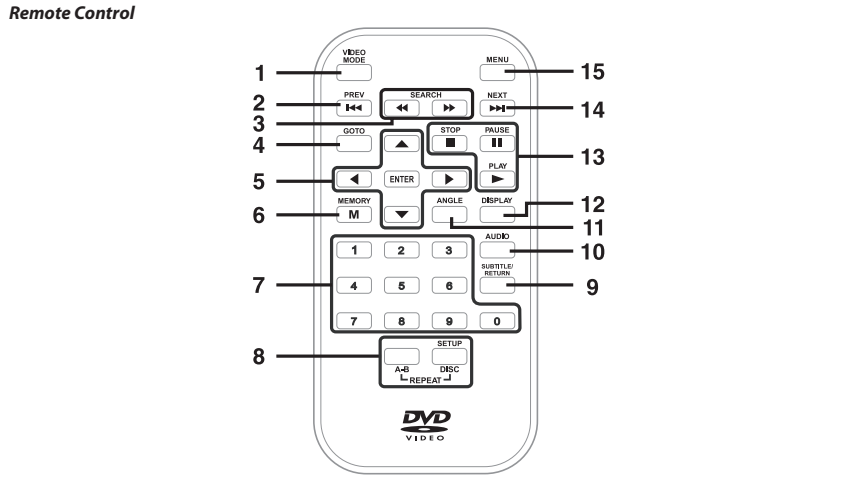

- VIDEO MODE Button**  
Adjusts Brightness, Contrast, Color or View Mode of the LCD screen.
- PREV Button**  
Goes back to current or previous chapters/tracks.
- SEARCH Buttons**  
SEARCH: Fast reverse playback.  
SEARCH: Fast forward playback.
- GOTO Button**  
Skips directly to a location on a DVD or a CD.
- Cursor (V, A, P) Buttons**  
Use to move between selections on a menu screen and adjust certain settings.
- ENTER Button**  
Confirms selections on a menu screen.
- MEMORY Button**  
Shows status information on the screen.
- Number (0 - 9) Buttons**  
Use when creating programs and locating a title/chapter or specific time.
- REPEAT A-B Button**  
Performs point-to-point repeat playback on a DVD or CD.
- REPEAT DISC Button**  
Repeats a DVD chapter or title.  
Repeats a CD track or the entire disc.
- SETUP Button**  
Opens and closes the SETUP menu while in stop mode.
- SUBTITLE Button**  
Selects one of the subtitle languages programmed on a DVD (if available).
- RETURN Button**  
Returns to normal operation after using the SETUP menu of a DVD.
- AUDIO Button**  
Selects one of the audio sound tracks programmed on a DVD or select the audio output mode on an Audio CD.
- ANGLE Button**  
Switches between multiple camera angles when the DVD you are playing has been programmed with multiple camera angles.
- DISPLAY Button**  
Shows status information on the screen.
- STOP Button**  
Stops playing a disc.
- PLAY Button**  
Starts or resumes playback of a disc.
- PAUSE Button**  
Pauses playback of a disc. Each time you press the PAUSE button the picture advances one frame on a DVD. Press the PLAY button to resume playback.
- NEXT Button**  
Advances chapters/tracks.
- MENU Button**  
Opens and closes the DVD menu.

**IMPORTANT NOTE:**  
The included remote controls have different color keys to identify which unit they operate. The remote control with GREEN keys operates the unit which has GREEN mark on the front of the unit. The remote control with BLUE keys operates the unit which has BLUE mark on the front of the unit.

## Unit

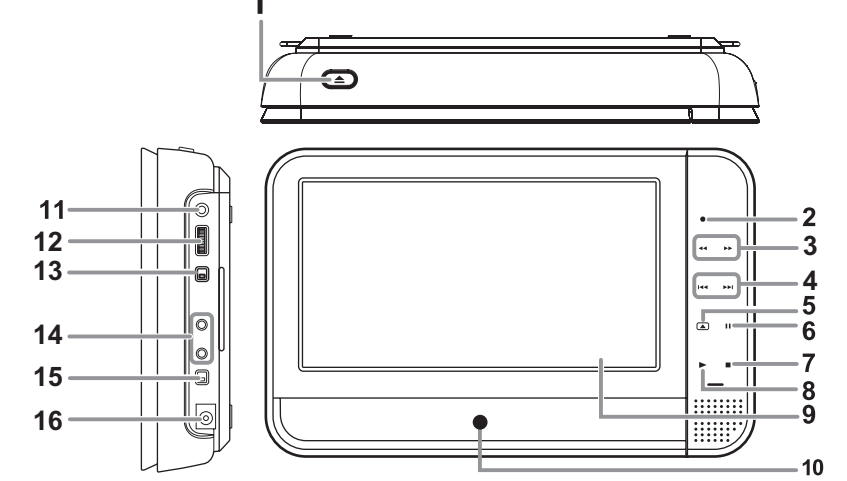

- Button**  
Press the button to open the front panel, press the inside disc switch to open the disc door.
- STANDBY Indicator**  
When the STANDBY / ON switch is slid to STANDBY position, the red light will illuminate.
- SEARCH Button**  
Performs fast reverse playback.
- PREV Button**  
Goes back to current or previous chapters/tracks.
- Flip Button**  
Flips the screen image.
- PAUSE Button**  
Pauses playback of a disc. Each time you press the PAUSE button the picture advances one frame on a DVD. Press the PLAY button to resume playback.
- STOP Button**  
Stops playing a disc.
- PLAY Button**  
Starts or resumes playback of a disc.
- LCD Screen**
- Remote Sensor**  
Receives the remote control signal.
- Headphone Jack**
- VOLUME Control**  
Adjusts the volume.
- Standby/On Switch**
- AUDIO / VIDEO IN / OUT Jacks**
- AV IN / DVD Switch**
- DC IN 9V-12V Jack**

## POWER SUPPLY

**A. Using the AC Power Adapter**  
The supplied AC power adapter operates on AC 100-120V ~50/60Hz.

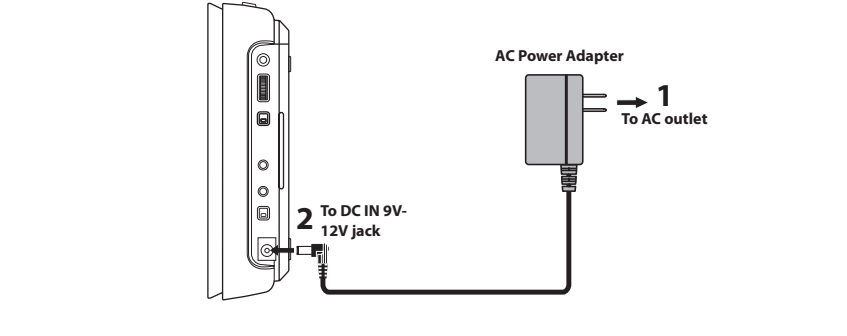

**Cautions:**

- The AC power adapter included with this unit is for its use only. Do not use it with other equipment.
- When the unit is not going to be used for long time, disconnect the AC power adapter from the AC power outlet.
- When the AC power adapter is plugged in, the apparatus is not completely disconnected from the main power supply, even when the power is turned off.

**Warning:**  
The AC power adapter is used as disconnect device and it should remain readily operable during intended use. In order to disconnect the apparatus from the mains completely, the AC power adapter should be disconnected from the mains socket outlet completely.

**B. Using the Car Power Adapter**  
The 12V car power adapter allows the unit to be used with vehicles that have a 12V, negative ground electrical system.

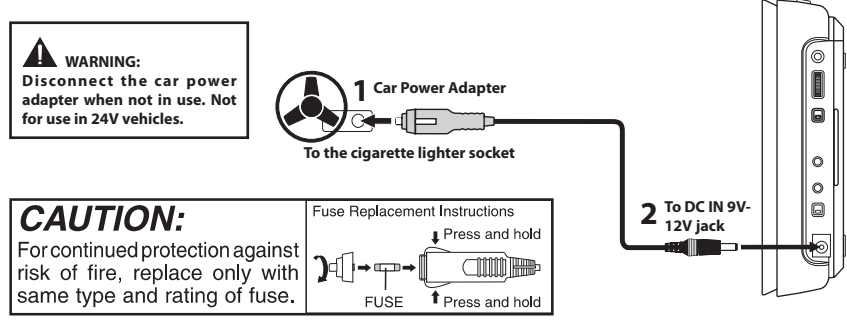

## C. Using the Car Power Splitter

The 12V car power splitter allows the units to be used with vehicles that have a 12V, negative ground electrical system.

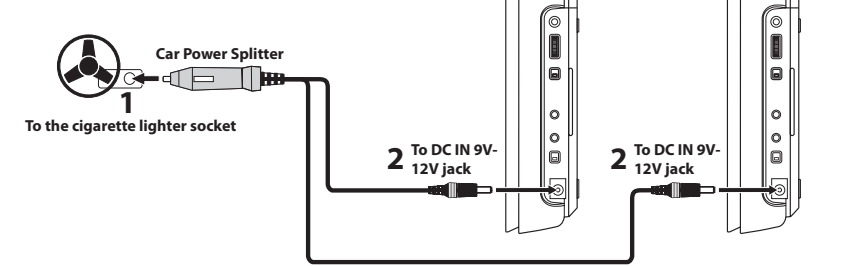

**Cautions:**

- Use the provided 12V car power adapter/splitter only. Use with other car power adapters/splitters could damage the unit.
- The 12V car power adapter/splitter included with this unit are for its use only. Do not use them with other equipment.
- In the interest of traffic safety, do not operate this unit or view videos while driving a vehicle.
- Make sure the unit is securely fastened to prevent it from falling or flying through the air in the event of an accident.
- If the inside of the cigarette lighter socket is dirty with ashes or dust, the plug section may become hot due to poor contact. Be sure to clean the cigarette lighter socket before use.
- After use, disconnect the 12V car power adapter/splitter from both the unit and cigarette lighter socket.

**Turning on the Unit**

- Slide the STANDBY / ON switch on the top of the unit to the ON position.
- The DVD logo (start-up picture) will appear on the screen.
- After use, slide the STANDBY / ON switch to the STANDBY (power off) position.

## CONNECTIONS

**A. Connecting both Units to Watch one DVD**  
You can watch the same DVD on the both units at the same time.

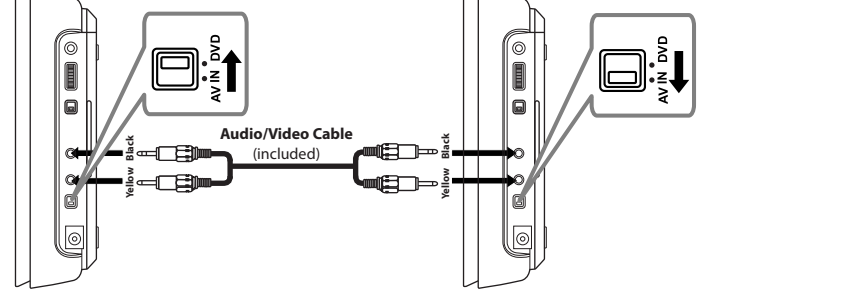

**Watching the same DVD on both units**

- Turn on the units. Slide the AV IN / DVD switch on the unit in which the DVD disc is loaded to DVD position. (Control DVD playback with this unit and its remote control.)
- Slide the AV IN / DVD switch on the other unit to AV IN position.

**B. Using Headphones / Earphones**

- Turn down the volume before connecting, and then adjust the level.
- When headphones/earphones are connected, no sound will be emitted from the unit's speaker.



## FOR DESKTOP USE

You can flip up the display for desk-top or table-top viewing.

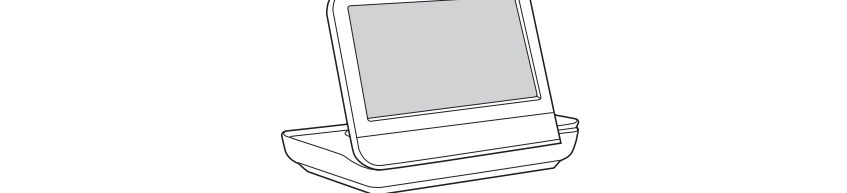

## INSTALLING IN A VEHICLE

Use the supplied mounting straps to install the units on the back of the vehicle's headrests. Tightly wrap the mounting straps around the headrest.

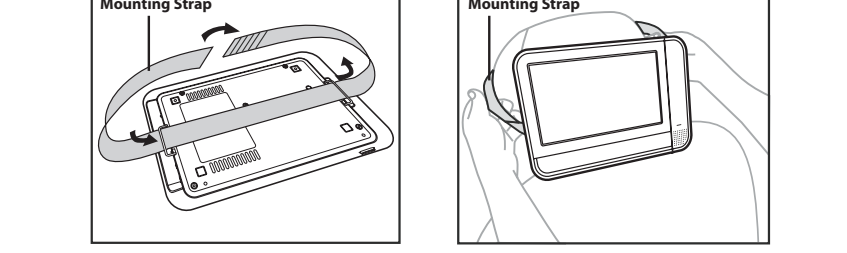

## INSTALLATION GUIDE

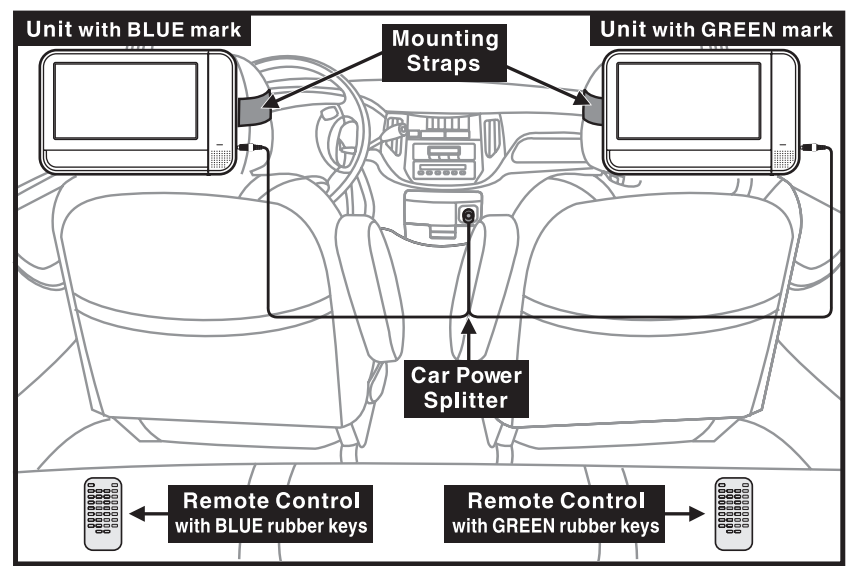

**SAFETY WARNING!**

- This unit should never be used by the vehicle's driver or left unsecured in the vehicle while driving.
- If this unit is being used in your vehicle, be sure that it is secured or held safely, and does not obstruct any safety device, including air bags or seat belts.
- All passengers should wear seat belts when using this unit in a moving vehicle.
- If in doubt, please contact your vehicle manufacturer for further advice.

## LIMITED WARRANTY

AVC MULTIMEDIA ("AVC") makes the following limited warranty. This limited warranty extends to the original consumer purchaser and is limited to non-commercial use of the product.

**One Year Parts & Labor Warranty**  
AVC products purchased in the United States are warranted to be free from defects in materials or workmanship for a period of one year from the date of their original retail purchase. If the unit fails to conform to this warranty, we will service the product using new or refurbished parts and products, at AVC's sole discretion.

During a period of one year from the effective warranty date, AVC will provide, when needed, service labor to repair a manufacturing defect at its designated Service Center. To obtain warranty service in the United States, you must first call our Customer Support Center at 1-800-506-5746 or 1-877-252-6873, during the hours listed in the box below. The determination of service will be made by AVC Customer Support. PLEASE DO NOT RETURN YOUR UNIT TO AVC WITHOUT PRIOR AUTHORIZATION. New or remanufactured replacements for defective parts or products will be used for repairs by AVC at its designated Service Center for one year from the effective warranty date. Such replacement parts or products are warranted for an additional one year from the date of repair or replacement. The Customer will be required to ship the unit to the Service Center indicated at the time Customer Support is contacted to make the necessary repairs. The customer is responsible for all transportation charges to the service facility.

**Packaging and Shipping Instruction**  
When you send the product to the AVC service facility you must use the original carton box and packing material or an equivalent as designated by AVC.

## LIMITED WARRANTY

**Your Responsibility**

- You must retain the original sale receipt to provide proof of purchase.
- These warranties are effective only if the product is purchased and operated in the U.S.A. or Canada.
- Warranties extend only to defects in material or workmanship, and do not extend to any product or parts which have been lost or discarded, or damage to product or parts caused by misuse, accident, improper operation or maintenance, or use in violation of instructions provided with the product, or to product which has been altered or modified without authorization of AVC, or to products or parts thereof which have had the serial number removed or changed.

**Out of Warranty**  
In the event your product requires repair after the limited warranty period has expired, please contact our Customer Support Center at 1-800-506-5746, 1-877-252-6873 or [www.RCAav.com](http://www.RCAav.com)  
**Hours: Monday-Thursday: 9am-7pm, Friday: 9am-5pm, Saturday: 9am-NOON Eastern time.**  
**Important:** You are responsible for any transportation, shipping or insurance relative to the return of product to our Product Returns Center.

All warranties implied by state law, including the implied warranties of merchantability and fitness for a particular purpose, are expressly limited to the duration of the limited warranties set forth above. With the exception of any warranties implied by state law as hereby limited, the foregoing warranty is exclusive and in lieu of all other warranties, guarantees, agreements and similar obligations of manufacturer or seller with respect to the repair or replacement of any parts. In no event shall AVC be liable for consequential or incidental damages.

No person, agent, distributor, dealer or company is authorized to change, modify or extend the terms of these warranties in any manner whatsoever. The time when action must be commenced to enforce any obligation of AVC arising under the warranty or under any statute, or law of the United States or any state thereof, is hereby limited to one year from the date of purchase. This limitation does not apply to implied warranties arising under state law.

This warranty gives you specific legal rights and you may also have other rights, which may vary, from state to state. Some states do not allow limitation on how long an implied warranty lasts, when an action may be brought, or the exclusion or limitation of incidental or consequential damages, so the above provisions may not apply to you.

For more information on other products and services, please visit our web site at [www.RCAav.com](http://www.RCAav.com)

**Important:** Also keep your "Bill of Sale" as proof of purchase.

Model no. .... Product name.....  
Type of set .....  
Serial no. .... Invoice no. ....  
Date purchased..... Dealer name .....

FOR SERVICE AND REPAIR, PLEASE VISIT [www.RCAav.com](http://www.RCAav.com)





### Twin Mobile DVD Players with 8" LCD screens

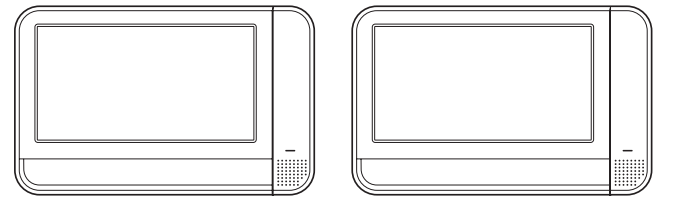

AVC Multimedia  
Markham, Ontario L3R 1E3  
http://www.RCAav.com  
Read these instructions before using your new product for the first time.

### SAFETY PRECAUTIONS

**WARNING:** TO REDUCE THE RISK OF ELECTRIC SHOCK, DO NOT REMOVE COVER (OR BACK). NO USER-SERVICEABLE PARTS INSIDE. REFER SERVICING TO QUALIFIED SERVICE PERSONNEL.

**CAUTION**  
RISK OF ELECTRIC SHOCK  
DO NOT OPEN  
DO NOT EXPOSE THIS UNIT TO RAIN OR MOISTURE  
AVIS RIQUE DE CHOC ELECTRIQUE - NE PAS OUVRI

**WARNING:** TO PREVENT FIRE OR SHOCK HAZARD, DO NOT EXPOSE THIS APPLIANCE TO RAIN OR MOISTURE. DO NOT PLACE OBJECTS FILLED WITH LIQUIDS ON OR NEAR THIS UNIT.

**CAUTION:** USE OF CONTROLS OR ADJUSTMENTS OR PERFORMANCE OF PROCEDURES OTHER THAN THOSE SPECIFIED MAY RESULT IN HAZARDOUS RADIATION EXPOSURE.

**CAUTION:** DANGER OF EXPLOSION IF BATTERY IS INCORRECTLY REPLACED. REPLACE ONLY WITH THE SAME OR EQUIVALENT TYPE.

**CAUTION**  
INVISIBLE LASER RADIATION WHEN OPEN.  
AVOID EXPOSURE TO BEAM.

**\* SEE BOTTOM OF UNIT FOR GRAPHIC SYMBOLS \***

**CLASS 1 LASER PRODUCT**

This product contains a low power laser device.

### PLAYING A DISC Basic playback

This owner's manual explains the basic instructions for operating this unit. Some DVDs are produced in a manner that allows specific or limited operation during playback. Therefore, this unit may not respond to all operating commands. THIS IS NOT A DEFECT. Please refer to the instructions accompanying the specific DVD in question for more information about the options available on that DVD.

- Playing a Disc**
- Slide the **STANDBY / ON** switch on the top of the unit to the ON position.
  - See **CUSTOMIZING THE FUNCTION SETTINGS** before proceeding to step 2.
  - Press the **STOP** button to open the front panel, press the inside disc switch to open the disc door.
  - Hold the disc by its sides and carefully place it onto the spindle with the label side facing up, pushing gently until you hear a "click".
  - Gently push the disc door closed. It takes a short while for your unit to load the disc. After loading, for most DVDs, the unit will automatically start playing or take you to the main menu.
  - If the unit does not automatically start playing the DVD, press the **PLAY** button.

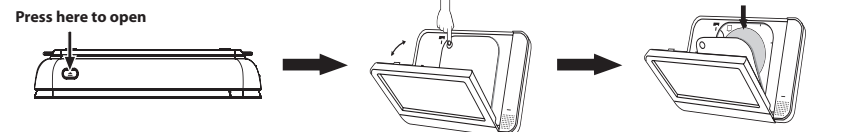

Press the **PAUSE** button. To resume normal playback, press the **PLAY** button. Each time you press the **PAUSE** button, the picture advances one frame on a DVD.

**Stopping Playback**  
Press the **STOP** button at the location where you want to interrupt playback. To resume playback at the position where the disc was stopped, press the **PLAY** button.

**Fast Forward / Fast Reverse**  
1. Press the **SEARCH** button or **SEARCH** button when a disc is playing. Each time you press the **SEARCH** button, the playback speed changes in the following sequence:

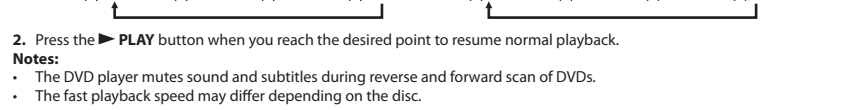

- Press the **PLAY** button when you reach the desired point to resume normal playback.
- Notes:**
  - The DVD player mutes sound and subtitles during reverse and forward scan of DVDs.
  - The fast playback speed may differ depending on the disc.

- Audio Selection**
- On some DVDs, the sound is recorded in two or more formats. Follow the directions below to select the preferred language and sound system.
- While a DVD is playing, press the **AUDIO** button to show the current audio format number.
  - Press the **AUDIO** button repeatedly to select the desired audio format.
- Notes:**
- If only one audio format is recorded on the DVD, the number does not change.
  - Some DVDs allow you to change audio selections via the disc menu only. If this is the case, press the **MENU** button and choose the appropriate language on the disc menu.
  - You can select different audio channels (Stereo, Left or Right) on an Audio CD by pressing the **AUDIO** button repeatedly.

- Subtitle Selection**
- While a DVD is playing, press the **SUBTITLE** button to display the current language setting, as shown in the example.
  - Press the **SUBTITLE** button repeatedly to select the desired subtitle language. You can turn subtitles off by pressing the **SUBTITLE** button repeatedly until "Off" is displayed.
- Notes:**
- Some DVDs are set to display subtitles automatically, and you cannot turn them off even if you set the subtitle function to off.
  - During some scenes, the subtitles may not appear immediately after you select your desired scene.
  - The number of subtitle languages recorded differs depending on the disc. If only one language is recorded, the language does not change.
  - This function can only be used for discs on which subtitles have been recorded in multiple languages.
  - Some DVDs allow you to change subtitles via the disc menu only. If this is the case, press the **MENU** button and choose the appropriate subtitle on the disc menu.

- Angle Selection**
- Some DVDs contain scenes which have been shot from a number of different angles. For these discs, the same scene can be viewed from each of these different angles.
- While you are playing a DVD with different angles recorded, press the **ANGLE** button to view the number of current angles available.
  - Press the **ANGLE** button repeatedly to change the scene to the next recorded angle.
- After approx. two seconds, playback will continue from the new angle selected.
- If no button is pressed within 10 seconds, playback continues without changing the current angle.

- Notes:**
- This function can only be used for discs on which scenes shot from multiple angles have been recorded.
  - If only one angle is recorded, "1/1" is displayed.

**Display Function**

While the disc is playing, press the **DISPLAY** button repeatedly to display information on operation status.

**Elapsed Time:** Elapsed time from the beginning of the title which is currently playing.

**Remain Time:** Remaining time of the title which is currently playing.

**Adjust the LCD Screen**

You can adjust the Brightness, Contrast, Color or View Mode of the LCD screen.

- Press the **VIDEO MODE** button.
- Press the **▲ / ▼** button to select Brightness, Contrast, Color or View Mode.
- Then press the **◀ / ▶** button to change the setting.

(For View Mode, press the **ENTER** button to change the setting.)

- Press the **VIDEO MODE** button to exit the menu.

### REPEAT PLAYBACK

- You can play a specific title or chapter repeatedly. (Title repeat, chapter repeat, A-B repeat)
- Repeating a Chapter**
- While the DVD is playing, press the **REPEAT DISC** button until the "Repeat Chapter" indicator displays on the screen. The current chapter is played repeatedly.
- Repeating a Title**
- While the DVD is playing, press the **REPEAT DISC** button until the "Repeat Title" indicator displays on the screen. The current title is played repeatedly.
- To Resume Normal Playback**
- While the DVD is playing, press the **REPEAT DISC** button until the "Repeat Off" indicator displays on the screen.

- Repeating a Single Track**
- While the CD disc is playing, press the **REPEAT DISC** button until the "Repeat single" indicator displays on the screen. The current track is played repeatedly.
- Repeating a Whole Disc**
- While the CD disc is playing, press the **REPEAT DISC** button until the "Repeat all" indicator displays on the screen. The whole disc is played repeatedly.
- To Resume Normal Playback**
- Press the **REPEAT DISC** button until the "Repeat off" indicator displays on the screen.

- Repeating a Specific Section**
- You can play a specific section repeatedly.
- While the disc is playing, press the **REPEAT A-B** button at the beginning of the section ("Rep All" is displayed) you want to play repeatedly.
  - Press the **REPEAT A-B** button again at the end of the section ("Rep A-B" is displayed).
  - The Unit will immediately begin replaying your selection.
- To Resume Normal Playback**
- While the disc is playing, press the **REPEAT A-B** button until the "RepAB Off" indicator displays on the screen.
- Notes:**
- Some discs may not permit A-B repeat operation.
  - You can not set the A-B repeat function for a segment that includes multiple camera angles.
  - You can specify a segment only within the current title or track.
  - There may be a slight difference between point A and the location where playback actually resumes depending on the disc.

### LOCATING A DESIRED SECTION

- Locating a Specific Title**
- If a DVD contains title numbers, you can locate a specific title by directly selecting its title number.
- Press the **GOTO** button.
  - Press the corresponding number button(s) for the title you want.
  - Press the **ENTER** button to confirm. Playback starts from the selected section.
- Locating a Specific Chapter**
- If you know the chapter number for the chapter that you want to play, you can locate it by directly selecting that number.
- Press the **GOTO** button.
  - Press **▲** or **▼** button to display Chapter and press the corresponding number button(s) for the chapter you want.
  - Press the **ENTER** button to confirm. Playback starts from the selected section.

- Locating a Specific Time**
- You can move to a specific location by entering its corresponding time (hours, minutes, seconds).
- Press the **GOTO** button.
  - Press **▲** or **▼** button to display Time and press the corresponding number buttons for the setting point you want.
  - Press the **ENTER** button to confirm. Playback starts from the selected section.
- Notes:**
- If the numbers you entered is not permitted by the DVD, after you press the **ENTER** button, it will restore to "--:--". You should re-enter correct numbers.
  - Some discs may not respond to this process.
  - Some scenes may not be located as precisely as you specified.
  - This method for accessing specific locations is available only within the current title of the DVD.

### DVD PROGRAMMABLE MEMORY

- Playing Titles/Chapters in a Favorite Order**
- You can combine your favorite titles/chapters and play them in the order you determine.
- When a DVD is stopped, press the **MEMORY** button, the right display appears.
  - Select the items in the order you want by pressing the number buttons. Each time you press the Cursor buttons (▲, ▼, ◀, ▶), the space is highlighted. Highlight where you want to enter, then press the corresponding number buttons.
  - Press the Cursor buttons (▲, ▼, ◀, ▶) to move the highlighted bar to Play Memory, then press the **ENTER** button. The DVD player starts memory playback.
  - To resume normal playback from memory playback
    - When a DVD is stopped, press the **MEMORY** button.
    - Press the Cursor buttons (▲, ▼, ◀, ▶) to move the highlighted bar to "Clear All", then press the **ENTER** button. All the input programs will be cleared.
    - Press the **PLAY** button to resume normal playback.
- Notes:**
- If the title or chapter numbers you entered is not permitted by the DVD, after you press the **ENTER** button, it will restore to "--:--". You should re-enter the correct numbers.
  - Some discs may not permit memory operation.
  - If you select repeat during memory playback, the DVD player repeats the current memory playback.
  - If you press the **MEMORY** button while the display appears on the TV screen, the display disappears.
  - The programmed selections will be cleared when you open the disc tray or turn off the DVD player.

### VIEWING JPG FILES

- This unit can play JPG files recorded on a CD-R or CD-ROM disc (CD-RW is not recommended).
- Viewing JPG Files**
- Press the **STOP** button to open the front panel, press the inside disc switch to open the disc door.
  - Hold the disc by its edges and gently push it onto the spindle with label side facing towards you until you hear a "click".
  - Close the disc door. A list of folders/files will appear on the screen.
  - Press the **▲** or **▼** button to select your desired file. The selected picture will appear in the lower right corner. Press the **PLAY** button to start playback. Press the **STOP** button to display a folder list.
- Notes:**
- You can press the **PAUSE** button to freeze the picture, and press the **PLAY** button to resume slide show.
  - You can press the **STOP** button to quit playback.
  - You can press the **PREV** or **NEXT** button to change the picture. Press the **PREV** button to view the previous picture. Press the **NEXT** button to view the next picture.
  - You can press the **ANGLE** button on the remote control to rotate the direction of the picture by 90°.
  - Some discs may not permit this operation.

### PLAY MODES FOR CD OR JPG DISC

- When play CD / JPG discs, you can modify the Play Modes through the Toolkit which appears on the right of below picture on the screen. Press the **◀ / ▶** button to navigate between the windows and the **▼ / ▲** button to select files/tracks or play mode items. Then press the **ENTER** button.
- In Stop mode, press the Cursor buttons (▲, ▼, ◀, ▶) to select "Edit mode" then press the **ENTER** button.
  - Use the Cursor buttons (▲, ▼, ◀, ▶) to select tracks/files shown on the left hand side of the window. Press the **ENTER** button to confirm the selected tracks/files. "✓" will appear in front of the selected tracks/files.
  - Select "Add to program" then press the **ENTER** button. "✓" will disappear from the screen. It means that the tracks/files you have selected are added into the "Program view".
  - Select "Program view" to view programmed files. To add more files by "Browser view" repeat the above steps.
  - Press the **PLAY** button to start the program playback.

The Toolkit has the following play mode items:

- Repeat (Off/Single/All):**
  - Off:** Resumes normal playback.
  - Single:** Repeats the current track/file.
  - All:** Repeats all files on the current folder or all tracks on the disc.
- Mode (Normal / Shuffle / Music Intro):**
  - Normal:** Resumes normal playback.
  - Shuffle:** Plays tracks/file in random order.
  - Music intro (for Audio CD only):** Only playbacks the first 10 seconds of all the tracks on the current folder/disc.
- Edit mode:** Program operation works only when "Edit mode" is selected.
- Program view:** To view tracks/files in the "Program view" list. It is disabled when the "Program view" list is empty.
- Add to program:** Add files/tracks to the "Program view" list. It is disabled if the "Edit mode" is not selected.
- Browser view:** To view files/tracks in the original view list.
- Clear program:** Delete the files/tracks in the "Program view" list. Select a file/track or more you want to delete in complete stop mode (press the **STOP** button twice). "✓" will appear besides the deleted file/track. Select "Clear program" and then press the **ENTER** button. It is disabled if the "Edit mode" is not selected.

**Note:**  
The program will be deleted if disc door is opened or selected files are deleted by selecting "Clear program" in "Edit mode".

### CUSTOMIZING THE FUNCTION SETTINGS

**Language**

1. Press the **SETUP** button in stop mode.

2. Press the **▶** button to select OSD Language.

3. Press the **ENTER** button, then the **▲ / ▼** button to shift and change the Language.

4. Press the **ENTER** button.

5. Press the **SETUP** or **RETURN** button to exit the menu.

**Subtitle**

1. Press the **SETUP** button in stop mode.

2. Press the **▶** button, then the **▲ / ▼** button to select Subtitle.

3. Press the **ENTER** button, then the **▲ / ▼** button to shift and change the Language.

4. Press the **ENTER** button.

5. Press the **SETUP** or **RETURN** button to exit the menu.

**Notes:**

- Some DVDs are programmed with a specific language. You may not be able to change this feature.
- Some DVDs allow you to change subtitle selections via the disc menu only. If this is the case, press the **MENU** button and choose the appropriate subtitle language from the selection on the disc menu.

**Audio**

1. Press the **SETUP** button in stop mode.

2. Press the **▶** button, then the **▲ / ▼** button to select Audio.

3. Press the **ENTER** button, then the **▲ / ▼** button until your preferred Audio is displayed.

4. Press the **ENTER** button.

5. Press the **SETUP** or **RETURN** button to exit the menu.

**Note:** Some DVDs are programmed with a specific language. You may not be able to change this feature.

**DVD Menu**

1. Press the **SETUP** button in stop mode.

2. Press the **▶** button, then the **▲ / ▼** button to select DVD Menu.

3. Press the **ENTER** button, then the **▲ / ▼** button until your preferred DVD Menu language is displayed.

4. Press the **ENTER** button.

5. Press the **SETUP** or **RETURN** button to exit the menu.

**Note:** Some DVDs are programmed with a specific language. You may not be able to change this feature.

**Video**

**Aspect Ratio**

1. Press the **SETUP** button in stop mode.

2. Press the **▶** button to select Video.

3. Press the **▶** button, then the **▲ / ▼** button to select Aspect Ratio.

4. Press the **ENTER** button, then the **▲ / ▼** button to shift and change the aspect ratio.

5. Press the **ENTER** button.

6. Press the **SETUP** or **RETURN** button to exit the menu.

**Notes:**

- The displayable picture size is preset on the DVD. Therefore, the playback picture of some DVDs may not conform to the picture size selected.
- When you play DVDs recorded in the 4:3 picture size only, the playback picture always appears in the 4:3 picture size regardless of the Aspect Ratio setting.
- Select 16:9 to conform to the LCD screen on the unit. Always be sure that your Aspect Ratio conforms to the actual TV in use if you connect the unit to a TV.

**View Mode**

1. Press the **SETUP** button in stop mode.

2. Press the **▶** button to select Video.

3. Press the **▶** button, then the **▲ / ▼** button to select View Mode.

4. Press the **ENTER** button, then the **▲ / ▼** button to shift and change the View Mode.

5. Press the **ENTER** button.

6. Press the **SETUP** or **RETURN** button to exit the menu.

**Fill**  
Fill the screen with decoded image.

**Original**  
Display image as its original size.

**Auto Fit**  
Automatically fit the decoded image on screen without distortion. Black bars will be present on top/bottom or left/right of screen.

**Pan Scan**  
Select when a standard 4:3 TV is connected. Displays pictures cropped to fill your TV screen. Sides of the picture are cut off.

**Note:** Depending on the DVD, you may not be able to view the mode as selected.

### Misc

- Use Default Settings**
- Press the **SETUP** button in stop mode.
  - Press the **▲ / ▼** button to select Misc.
  - Press the **▶** button, then press the **▲ / ▼** button to select Use Default Settings dialogue box.
  - Press the **ENTER** followed by the **◀ / ▶** button to select "Yes", then press the **ENTER** button. The original setting will be restored. The unit will exit the menu automatically and re-load the disc in the disc tray.
- Note:** It will take 3-5 seconds to reset the DVD player to the factory default.

**Screen Saver**

- Press the **SETUP** button in stop mode.
- Press the **▲ / ▼** button to select Misc.
- Press the **▶** button, then press the **▲ / ▼** button to select Screen Saver.
- Press the **ENTER** button, then press the **▲ / ▼** button to change the On/Off mode.
- Press the **SETUP** button.
- Press the **SETUP** or **RETURN** button to exit the menu.

### MAINTENANCE

- Cleaning the Disc**
- A defective or soiled disc inserted into the unit can cause sound to drop out during playback. Handle the disc by holding its inner and outer edges.
- Do NOT touch the surface of the unlabeled side of the disc.
  - Do NOT stick paper or tape on the surface.
  - Do NOT expose the disc to direct sunlight or excessive heat.
  - Clean the disc before playback. Wipe the disc from the center outward with a cleaning cloth.
  - NEVER use solvents such as benzine or alcohol to clean the disc.
  - Do NOT use irregular shaped discs (example: heart shaped, octagonal, etc.). They may cause malfunctions.

- Cleaning the Unit**
- Be sure to turn the unit off and disconnect the AC power adapter before maintaining the unit.
  - Wipe the unit with a dry soft cloth. If the surfaces are extremely dirty, wipe clean with a cloth that has been dipped in a weak soap-and-water solution and wrung out thoroughly, then wipe with a dry cloth.
  - Never use alcohol, benzine, thinner, cleaning fluid or other chemicals. Do NOT use compressed air to remove dust.

**Important Note**

- Before transporting the unit, remove any disc from the disc compartment.

### TROUBLESHOOTING GUIDE

SYMPTOM	CAUSE (AND REMEDY)
No power.	<ul style="list-style-type: none"> <li>Ensure the AC power adapter is connected.</li> <li>The unit is not turned on.</li> </ul>
The remote control does not function.	<ul style="list-style-type: none"> <li>Make sure the infrared remote sensor is not blocked.</li> <li>Make sure the plastic sheet has been removed from the remote control.</li> <li>Point the remote directly at the infrared remote sensor on the unit.</li> <li>Replace the battery in the remote control with a new one.</li> <li>Use remote control with GREEN keys with the unit which has GREEN mark. Use remote control with BLUE keys with the unit which has BLUE mark.</li> </ul>
No sound or only a very low-level sound is heard.	<ul style="list-style-type: none"> <li>Make sure ON mode was selected.</li> <li>The volume control is located on the side of the unit – please try adjusting this.</li> <li>The system is in pause mode. Press the <b>▶</b> button to return to normal play mode.</li> <li>The unit is in fast-forward or fast-reverse mode. Press the <b>▶</b> button to return to normal play mode.</li> <li>Make sure the AUDIO/VIDEO output connections are correct.</li> <li>The DTS DVD cannot be decoded to have speaker output.</li> <li>The unit is too hot; shut off the unit for 30 minutes to cool it down.</li> </ul>
No picture	<ul style="list-style-type: none"> <li>The region number of the disc doesn't match the region number of this unit.</li> </ul>
The picture is not clear	<ul style="list-style-type: none"> <li>Clean the disc.</li> <li>The disc is scratched.</li> <li>Adjust the LCD's brightness, contrast and color using the <b>VIDEO MODE</b> button on the remote control.</li> </ul>
Severe hum or noise is heard.	<ul style="list-style-type: none"> <li>The plugs and jacks are dirty. Wipe them with a cloth slightly moistened with alcohol.</li> <li>Clean the disc.</li> </ul>
The disc does not play.	<ul style="list-style-type: none"> <li>There is no disc inside ("No Disc" appears on the screen).</li> <li>Insert the disc correctly with the playback side facing down.</li> <li>Clean the disc.</li> <li>A non-DTS disc has been inserted. The unit and disc region number are incompatible.</li> <li>Condensation may have formed inside the unit due to a sudden change in temperature. Wait about an hour for it to clear and try again.</li> </ul>
The picture is up-side-down	<ul style="list-style-type: none"> <li>Press the <b>STOP</b> button located on front of player.</li> </ul>

**Specifications and external appearance are subject to change without notice.**

## Free Manuals Download Website

<http://myh66.com>

<http://usermanuals.us>

<http://www.somanuals.com>

<http://www.4manuals.cc>

<http://www.manual-lib.com>

<http://www.404manual.com>

<http://www.luxmanual.com>

<http://aubethermostatmanual.com>

Golf course search by state

<http://golfingnear.com>

Email search by domain

<http://emailbydomain.com>

Auto manuals search

<http://auto.somanuals.com>

TV manuals search

<http://tv.somanuals.com>