

VR336

USER'S GUIDE

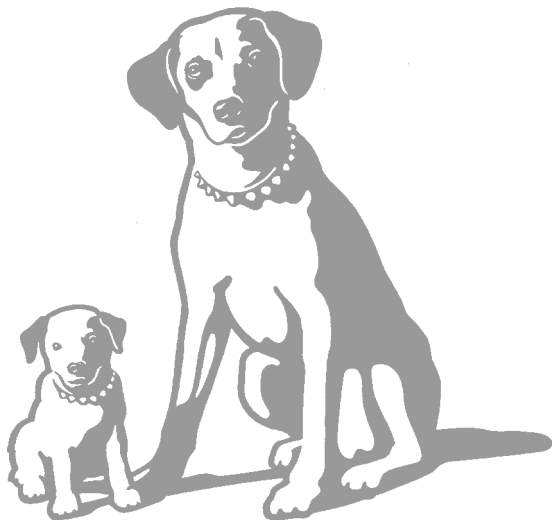

VIDEO CASSETTE **RECORDER**

RECORDER

Important Information

WARNING

To reduce the risk of fire or shock hazard, do not expose this product to rain or moisture.

WARNING

**RISK OF ELECTRIC SHOCK
DO NOT OPEN**

TO REDUCE THE RISK OF ELECTRIC SHOCK, DO NOT REMOVE COVER (OR BACK). NO USER SERVICEABLE PARTS INSIDE. REFER SERVICING TO QUALIFIED SERVICE PERSONNEL.

 This symbol indicates "dangerous voltage" inside the product that presents a risk of electric shock or personal injury.

 This symbol indicates important instructions accompanying the product.

Cautions

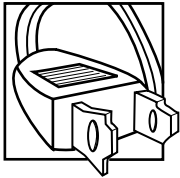

Caution: To prevent electric shock, match wide blade of plug to wide slot, fully insert.

Attention: Pour éviter les chocs électriques, introduire la lame la plus large de la fiche dans la borne correspondante de la prise et pousser jusqu'au fond.

Refer to the identification/rating label (normally located on the back of the product) for the proper operating voltage for this product.

FCC Regulations state that unauthorized changes or modifications to this equipment may void the user's authority to operate it.

Note To Cable TV Installer

This reminder is provided to call your attention to Article 820-40 of the National Electrical Code (Section 54 of the Canadian Electrical Code, Part 1) which provides guidelines for proper grounding and, in particular, specifies that the cable ground shall be connected to the grounding system of the building as close to the point of cable entry as practical.

Product Registration

Please fill out the product registration card and return it immediately. Returning this card allows us to contact you if needed.

Keep your sales receipt to obtain warranty parts and service and for proof of purchase. Attach it here and record the serial and model numbers in case you need them. The numbers are located on the back of the product.

Model No. **VR336** _____

Serial No. _____

Purchase Date: _____

Dealer/Address/Phone: _____

Table of Contents

Important Information		Commercial Scan _____	15
Warnings _____	i	Index Search _____	15
Cautions _____	i	Go-To Search _____	15
Note to Cable TV Installer _____	i		
Product Registration _____	i		
Hooking Up the VCR		Recording a Program	
Choosing a Hookup _____	2	Recordings _____	16
Antenna or Cable System Without a		Recording Speeds _____	16
Cable Box _____	3	Normal Recording	
Cable System With Cable Box to		To Make a Recording _____	16
Unscramble All Channels _____	4	Watch a TV Channel While VCR is	
Cable System With Cable Box to		Recording a Different Channel ____	16
Unscramble Pay Channels Only _____	5	Express Recording _____	17
Connecting Two VCRs for Copying Tapes _	6	Recording While You're Away	
Setting Up the VCR		Timer Recording _____	18
Startup		Select Cable Box Viewing Channel _	19
Check Accessories With VCR _____	7	Checking or Clearing Timer	
Insert Batteries in Remote _____	7	Recordings _____	20
Turn on TV _____	7	Timer Recording From the	
Turn on VCR _____	7	VCR's Line Input _____	20
Select the Language _____	8	Recording Features	
Place Channels in VCR's Memory ____	8	Recording Pause _____	20
Add or Remove Channels from		Using Two VCRs for Copying	
VCR's Memory _____	9	and Editing Tapes	
Set the Time and Date _____	9	Operating Instructions _____	21
Set the Auto TV/VCR Feature _____	9	Copying and Editing Using a	
Use TV•VCR Button _____	10	Compatible Remote _____	21
Using the Remote Control		References	
Buttons _____	11	Location of Controls	
Playing a Tape		Front Panel _____	22
Playback _____	12	Back Panel _____	23
Using the Playback Features		Display Panel _____	23
Auto Play _____	12	Trouble Checks _____	24-25
Pause for Stop Action _____	13	Specifications _____	26
Picture Search _____	13	Cleaning the VCR _____	26
Automatic Tracking _____	13	Limited Warranty _____	27
Manual Tracking _____	13	Index _____	28-29
DISPLAY Button _____	14		
Time Counter _____	14		

Choosing a Hookup

The hookups on pages 3 through 5 are divided into two hookup types: Basic (A) and Advanced (B).

The basic hookup shows the backs of TVs that have only an antenna/cable connection. It is the easier of the two and additional accessories may not be needed.

The advanced hookup shows the VCR hooked up to a TV with audio and video jacks. The advanced hookup may improve the picture quality as well as convenience of operation.

Answer the questions to choose the hookup for your VCR.

1. How does your TV receive signals?

Choose one answer from below.

- A. Outside antenna – Turn to page 3.
- B. Rabbit ears (set-top) and/or bow tie antenna – Turn to page 3.
- C. Cable System – Go to question 2.

2. What type of Cable-TV system* do you have?

Choose one answer from below.

- A. Cable without a box – Turn to page 3.
- B. Cable box to unscramble all the channels – Turn to page 4.
- C. Cable box to unscramble only pay channels, such as HBO, Showtime, Cinemax, etc. – Turn to page 5.

*You may need to contact your local cable company for assistance.

Optional Hookups

How to hook up two VCRs for copying tapes.

- A. Select a hookup by answering questions 1 and 2 above.
- B. Then, modify the connections as shown on page 6.

Antenna or Cable System Without a Cable Box

A. Basic hookup.

Use this hookup for a basic connection which requires fewer accessories.

1. **Set the CH 3◀▶4 switch on back of VCR to either channel 3 or 4.**

Tune the TV to this channel and use the TV•VCR button to watch the VCR.

2. **Connect as shown.**

This connection may require additional accessories not provided.

3. **Plug in power cords of VCR and TV.**

4. **Go to "Startup" section.**

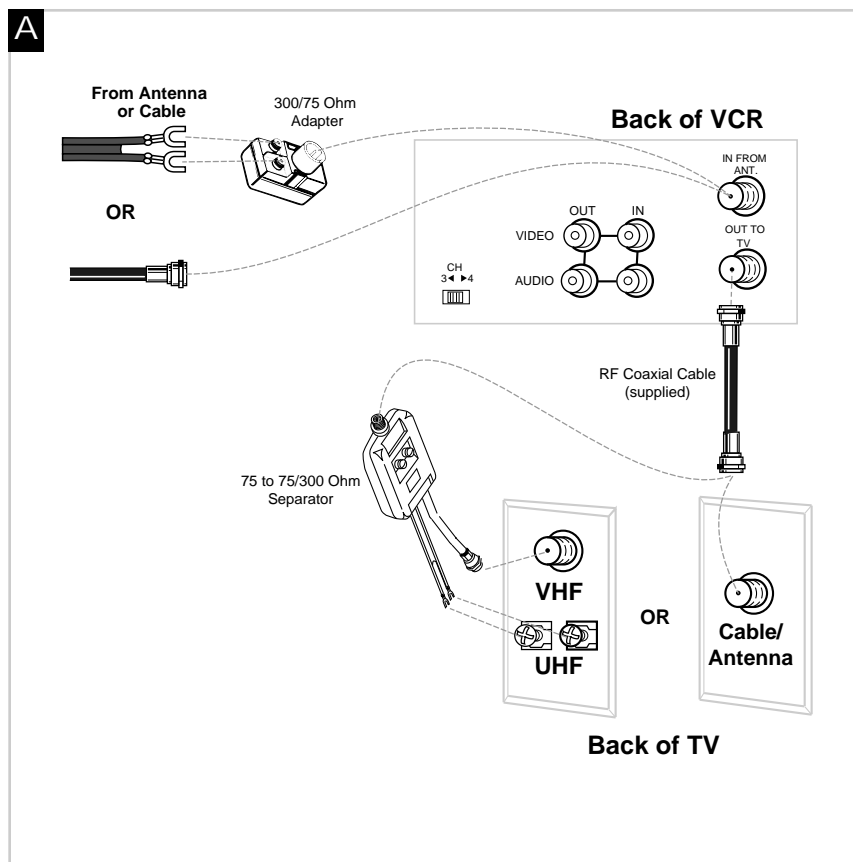

B. Advanced hookup.

Use this hookup for slightly improved picture quality and more convenient operation — use of TV•VCR button is not required.

1. **Connect as shown.**

This connection requires additional accessories not provided. A Y-adaptor may be required to hear sound from both channels if your TV is stereo.

2. **Plug in power cords of VCR and TV.**

3. **Go to "Startup" section.**

Tune the TV to its LINE (audio/video) input to watch the VCR. All pay channels are viewed through the VCR.

Set the AUTO TV/VCR feature to OFF. See *Auto TV/VCR step in "Startup" section.*

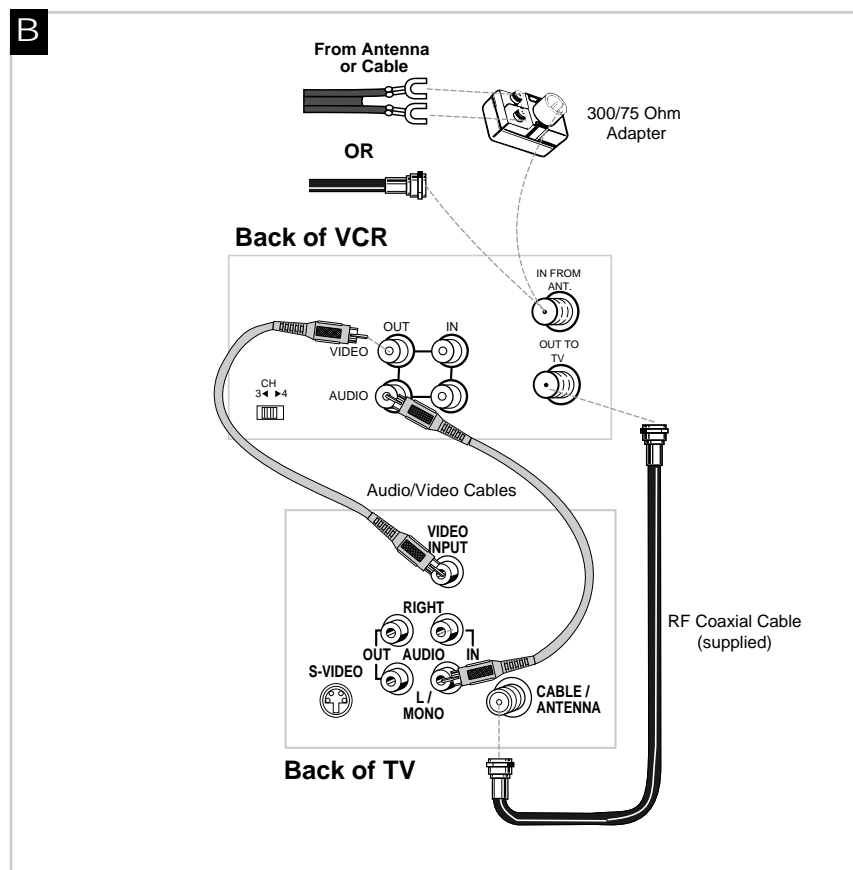

Cable System With Cable Box to Unscramble All Channels

A. Basic hookup.

Use this hookup for a basic connection which requires fewer accessories.

1. **Set the CH 3◀▶4 switch on back of VCR to either channel 3 or 4.**
Tune the TV to this channel and use the TV•VCR button to watch the VCR.
2. **Connect as shown.**
This connection may require additional accessories not provided.
3. **Plug in power cords of VCR, TV, and cable box.**
4. **Go to "Startup" section.**

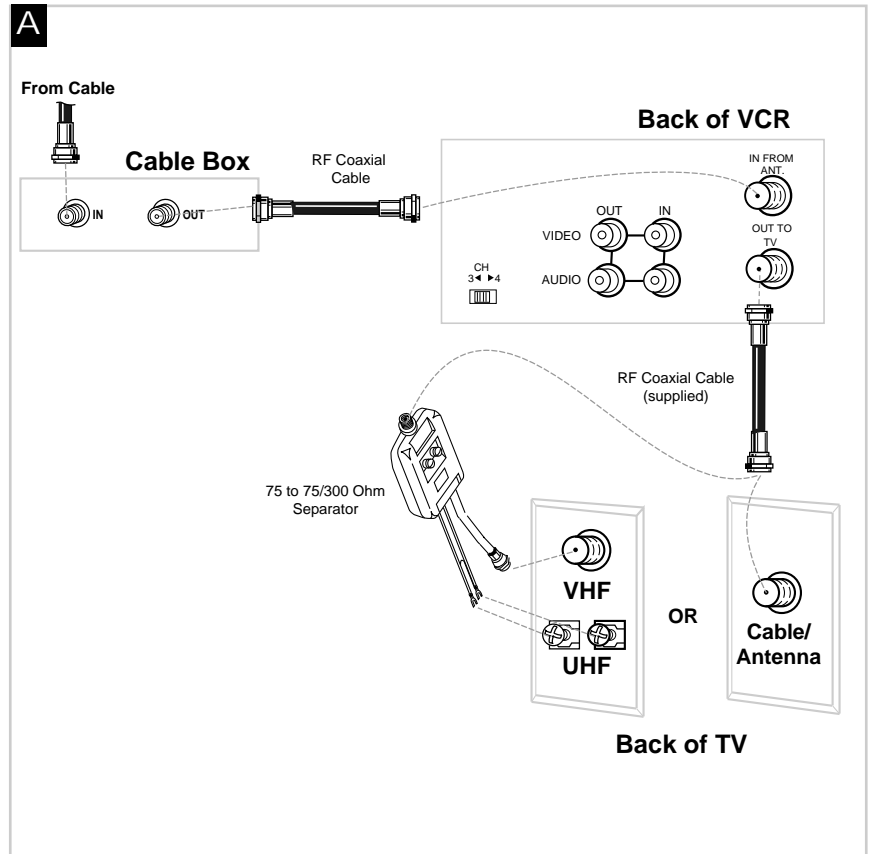

B. Advanced hookup.

Use this hookup for slightly improved picture quality and more convenient operation — use of TV•VCR button is not required.

1. **Connect as shown.**
This connection requires additional accessories not provided. A Y-adaptor may be required to hear sound from both channels if your TV is stereo.
2. **Plug in power cords of VCR and TV.**
3. **Go to "Startup" section.**
Tune the TV to its LINE (audio/video) input to watch the VCR. All pay channels are viewed through the VCR.
Set the AUTO TV/VCR feature to OFF. See Auto TV/VCR step in "Startup" section.

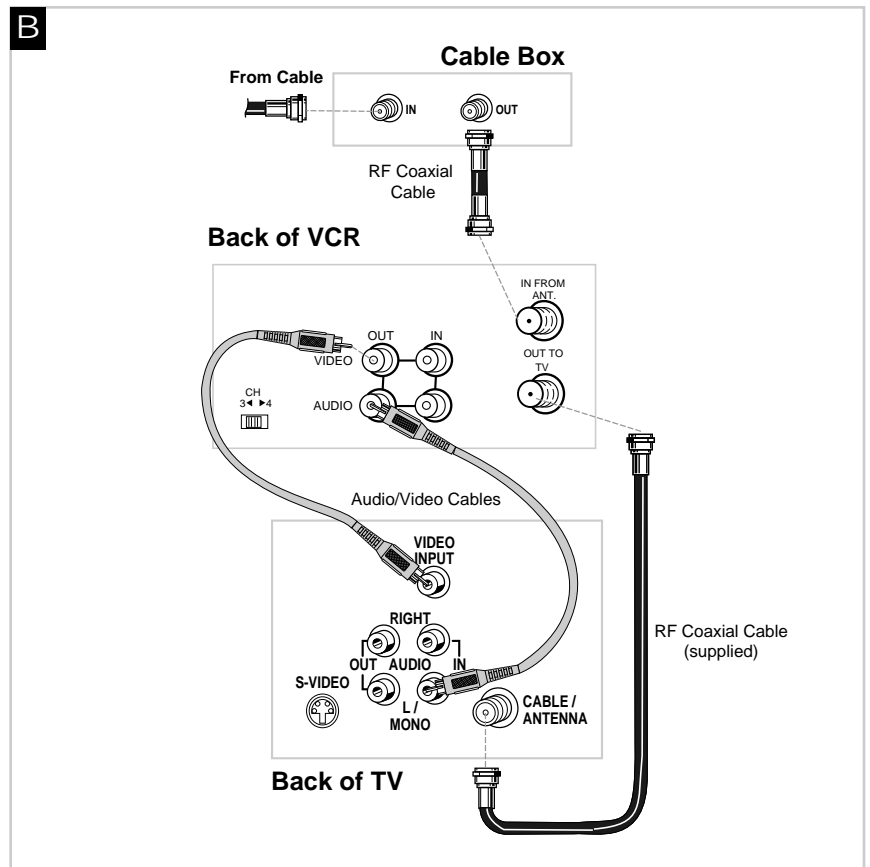

Cable System With Cable Box to Unscramble Pay Channels Only

(such as HBO, Showtime, Pay-Per-View, etc.)

A. Basic hookup.

Use this hookup for a basic connection which requires fewer accessories.

1. Set the CH 3◀▶4 switch on back of VCR to either channel 3 or 4.

Tune the TV to this channel and use the TV•VCR button to watch the VCR.

2. Connect as shown.

This connection may require additional accessories not provided.

3. Plug in power cords of VCR, TV, and cable box.

4. Go to "Startup" section.

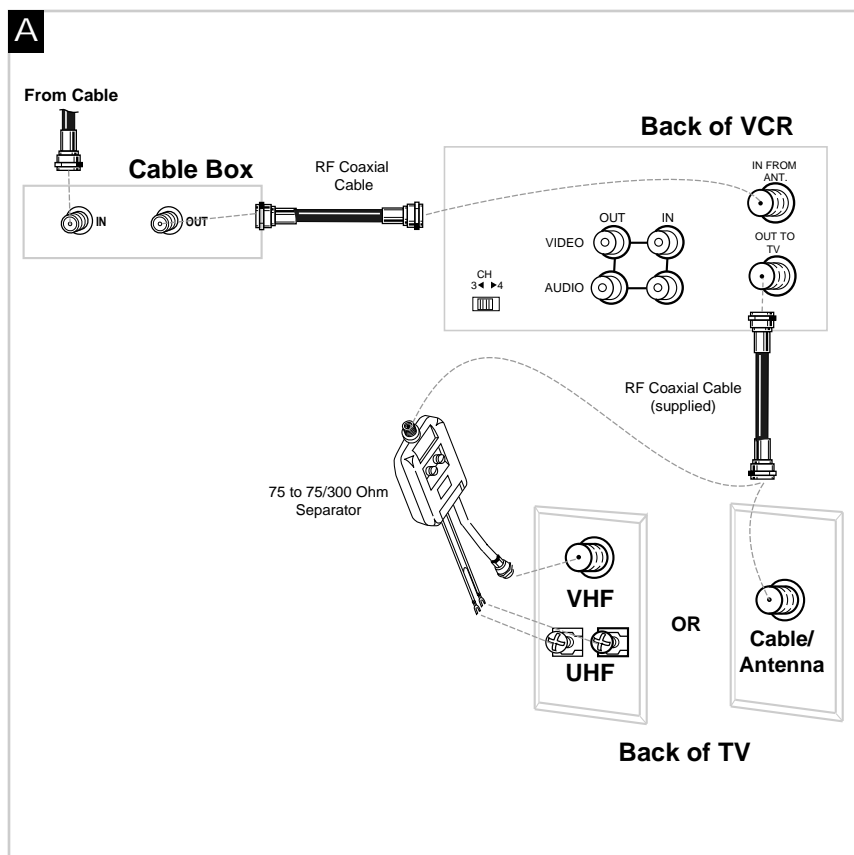

B. Advanced hookup.

Use this hookup for slightly improved picture quality and more convenient operation — use of TV•VCR button is not required.

1. Connect as shown.

This connection requires additional accessories not provided. A Y-adaptor may be required to hear sound from both channels if your TV is stereo.

2. Plug in power cords of VCR and TV.

3. Go to "Startup" section.

Tune the TV to its LINE (audio/video) input to watch the VCR. All pay channels are viewed through the VCR.

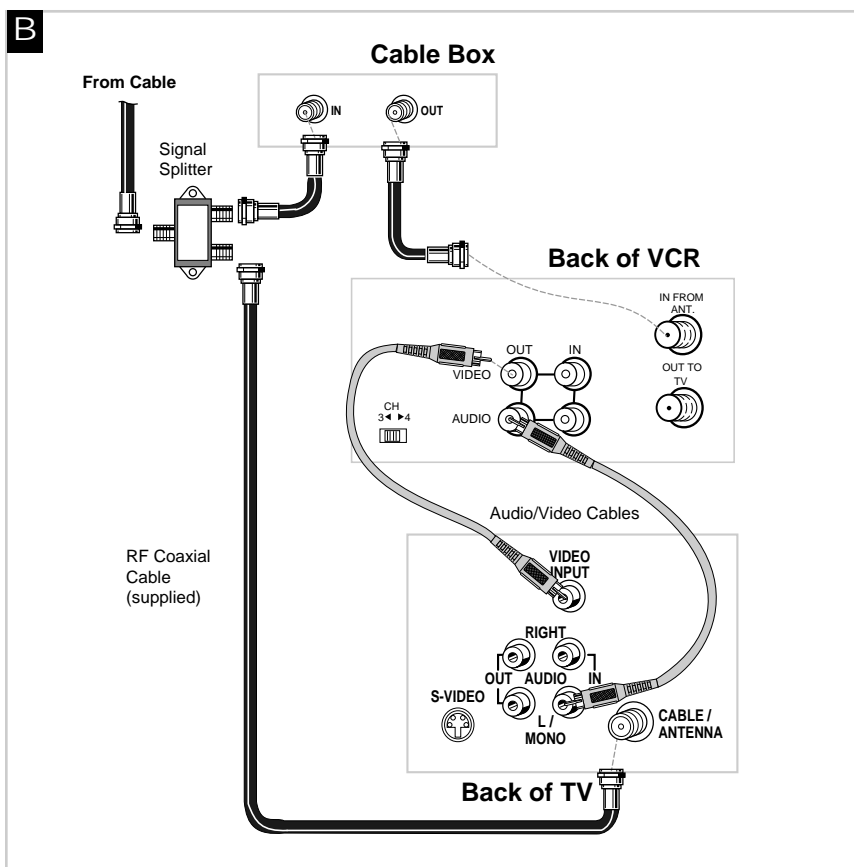

Connecting Two VCRs for Copying Tapes

Option A Hookup.

Use this hookup for a basic connection which requires fewer accessories.

1. Select a hookup from pages 2 through 5 and then modify with this connection.
2. Set the CH 3◀▶4 switch on the playback VCR to either channel 3 or 4.
Tune the recording VCR to this channel to receive the signal from the playback VCR.
3. Connect as shown.
4. Plug in power cords of VCRs and TV.
5. **Go to "Startup" section.**

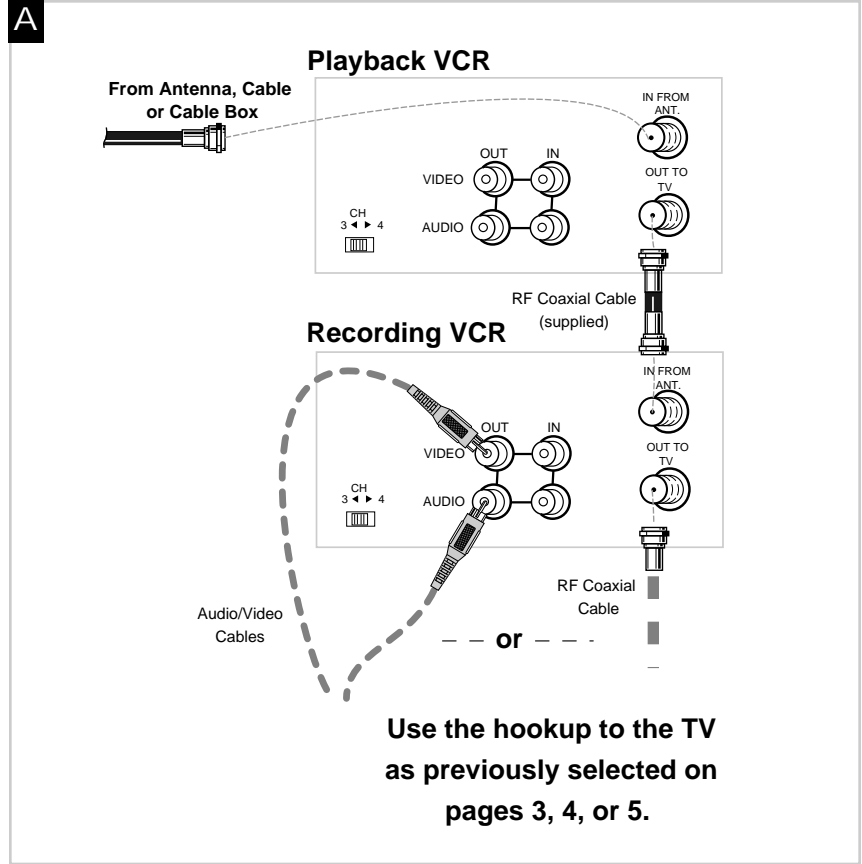

Option B Hookup.

Use this hookup for slightly improved picture quality and more convenient operation — use of TV•VCR button is not required.

1. Select a hookup from pages 2 through 5 and then modify with this connection.
2. Connect as shown.
This connection requires additional accessories not provided. A Y-adaptor may be required to hear sound from both channels if your other VCR is stereo.
3. Plug in power cords of VCRs and TV.
4. **Go to "Startup" section.**
Select the LINE (audio/video) input on the recording VCR to receive the signal from the playback VCR.

Caution: The unauthorized recording of television programs and other materials may infringe the rights of others.

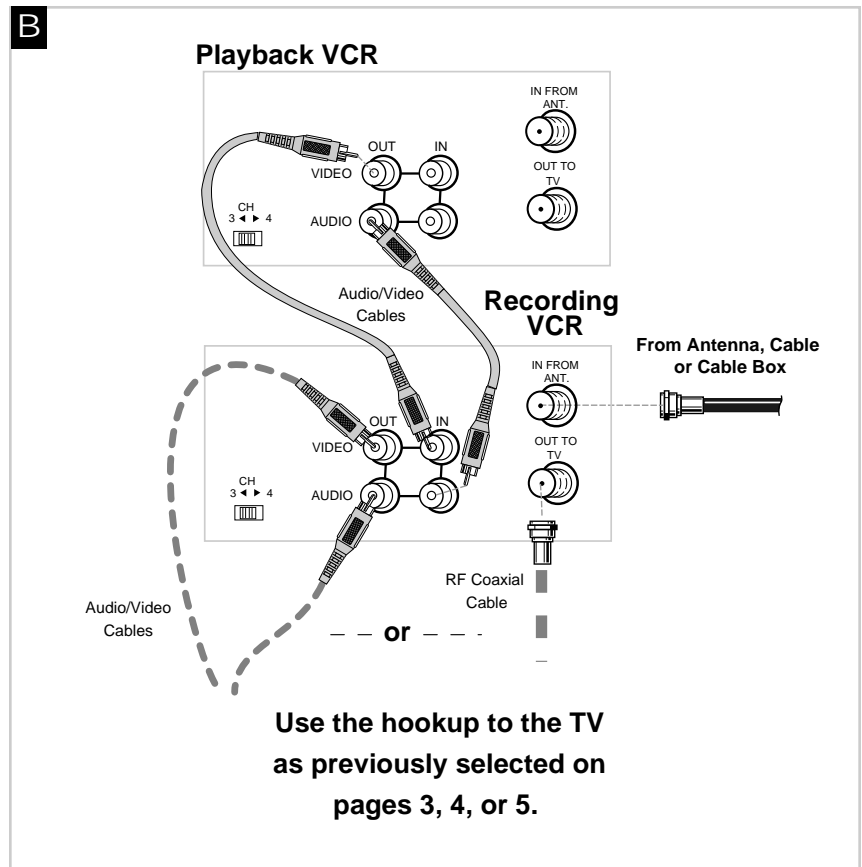

Startup

1. Check accessories with VCR.

Contact your dealer if any items are missing.

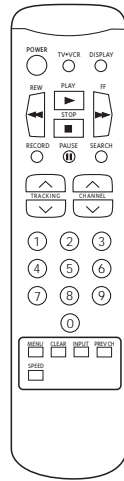

Remote
(Stock No. 233443)

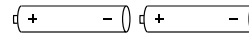

2 "AA" Batteries

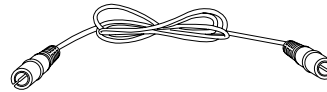

RF Coaxial Cable
(Stock No. 207417)

2. Insert batteries in remote.

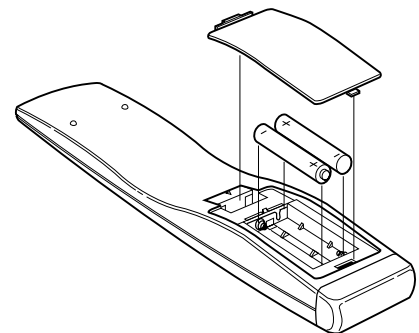
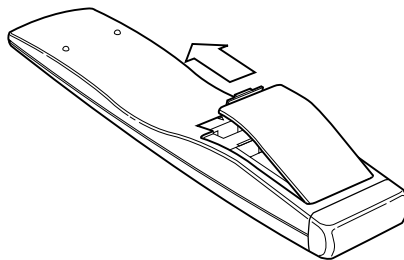

3. Turn on the TV.

- A. Turn on the TV.
- B. If you used one of the basic hookups, tune the TV to the channel selected with the 3◀▶4 switch on back of VCR.
If you used one of the advanced hookups, tune the TV to the TV's video input. (See TV owner's manual for details.)

4. Turn on the VCR.

Press POWER on the remote.

The POWER and VCR indicators light in the display panel.

Startup

5. Select the language.

The VCR displays the on-screen menus in the English, Spanish or French language. The word "Language" cycles through the different languages when the VCR Main Menu is displayed on the TV screen. The arrow indicates which language is selected.

- A. Press MENU on remote to display the VCR MAIN MENU on the TV screen.
- B. Press 5 to display the LANGUAGE or IDIOMA or LANGUE menu. (English: LANGUAGE; Spanish: IDIOMA; French: LANGUE).
 - Press 1 to have the menus displayed in English (Ingles).
 - Press 2 to have the menus displayed in Spanish (Español).
 - Press 3 to have the menus displayed in French (Français).

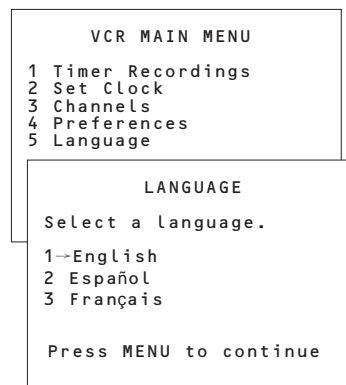

6. Place channels in the VCR's memory.

The AUTO CHANNEL SEARCH feature memorizes the channel list available through your signal type—cable or antenna. The signal type is automatically selected when you auto channel search. Also, if you change your signal system, you must perform AUTO CHANNEL SEARCH again.

Wait until the channel numbers stop changing. This takes about one to two minutes. The TV tunes to the lowest channel found. Pressing CHANNEL up or down selects only the active channels.

- A. Press MENU to display the VCR MAIN MENU on the TV screen. If this menu does not appear:
 - Make sure the TV is tuned to same channel as the CH 3/4 switch on the VCR or the TV's video input (refer to TV's manual).
 - If you use a basic hookup, check the VCR indicator in display panel — it should be on. Press TV•VCR to turn it on.
 - Check the connections.
- B. Press 3 to display the CHANNELS menu.
- C. Press 1 to begin AUTO CHANNEL SEARCH.

The VCR automatically selects the CABLE (cable TV) or ANTENNA signal. For cable connection, 125 channels are searched; for an antenna connection, 69 channels are searched.

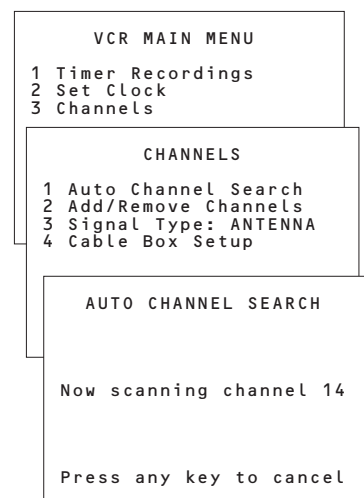

To change the Signal Type:

- A. Follow steps A-B above.
- B. Press 3 to switch the Signal Type between CABLE and ANTENNA.

Startup

7. Add or remove channels from the VCR's memory.

You may want to add or remove channels if some of the channels are not active, have weak signals, or you do not want to watch them.

We recommend channels be placed in memory using the AUTO CHANNEL SEARCH feature before adding or removing channels.

- A. Press MENU on the remote to display the VCR MAIN MENU on the TV screen.
- B. Press 3 to display the CHANNELS menu.
- C. Press 2 to display the ADD/REMOVE CHANNEL display.
- D. Follow the directions on the screen.
- E. Add or remove more channels using the CHANNEL up and down buttons.

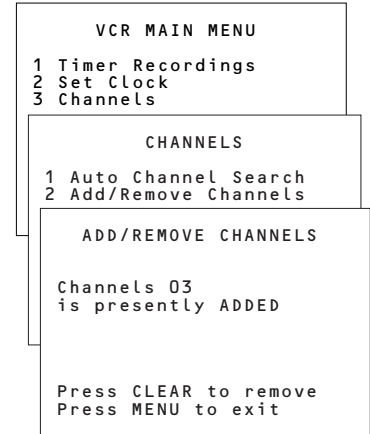

8. Set the time and date.

When you first turn on the VCR, --:-- appears in the clock area of the VCR's display panel.

- A. Press MENU on remote to display the VCR MAIN MENU on the TV screen.
- B. Press 2 to display SET TIME AND DATE.
- C. Enter the time and date with the number buttons on the remote.
 - Press 0 before single-digit numbers.
 - Example: press 0, then 5, then 0, then 7 for a time of 5:07. Press 1 for AM or 2 for PM.
 - Press CLEAR on the remote to change incorrect entries.
- D. Press MENU twice on remote to remove SET TIME AND DATE from the TV screen and start the clock.

The time and date appear on the TV screen when you press DISPLAY.

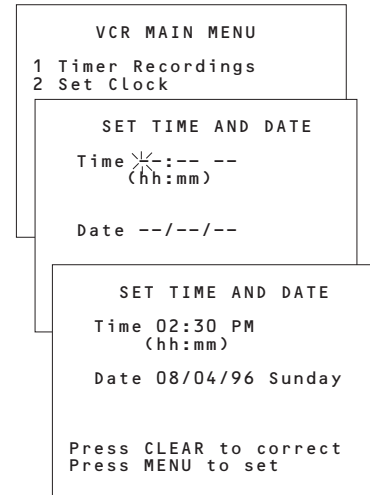

9. Set the AUTO TV/VCR feature.

Skip this step if you used one of the basic hookups.

If you connected your VCR using the TV's video input, you can prevent the VCR indicator from turning on automatically and interrupting your TV signal.

- A. Press MENU on remote to see VCR MAIN MENU on the TV screen.
- B. Press 4 to display PREFERENCES.
- C. Press 3 to select Auto TV/VCR: ON or OFF.
 - Select ON if you used one of the basic hookups and watch your VCR on channel 3 or 4 of your TV. Press the TV•VCR button to turn the VCR indicator on or off to switch between the picture coming from the VCR or television channels.
 - Select OFF if you used one of the advanced hookups and watch your VCR on the video input channel of your TV. The VCR indicator will not turn on automatically, nor interrupt the TV signal.

Pressing TV•VCR on the remote will still turn the VCR indicator on or off.

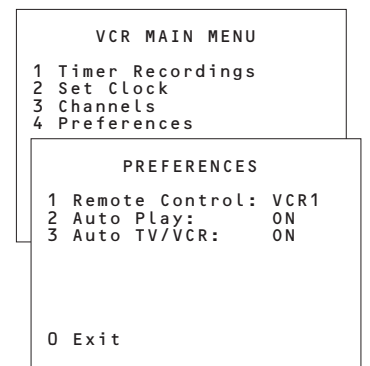

Startup

10. Use TV•VCR button.

Skip this step if you used one of the advanced hookups.

When using one of the basic hookups, the TV•VCR button lets you switch between the picture coming from the VCR or the picture from the TV channel. This button lets you record a program on the VCR while watching another channel on the TV. See *“Recording”* section for more information.

- A. Press POWER to turn on the VCR.
- B. Press TV•VCR to see the picture from the VCR.
The VCR indicator lights in the display panel.
- C. Press CHANNEL up or down to change channels on the VCR.
The channel number appears on the TV screen.
- D. Press TV•VCR to see the TV channels.
The VCR indicator does not light in the display panel. Change channels using the TV's remote.
- E. Return the TV to the VCR viewing channel — CH3 or CH4.
- F. Press TV•VCR to switch back to the picture from the VCR.

Buttons

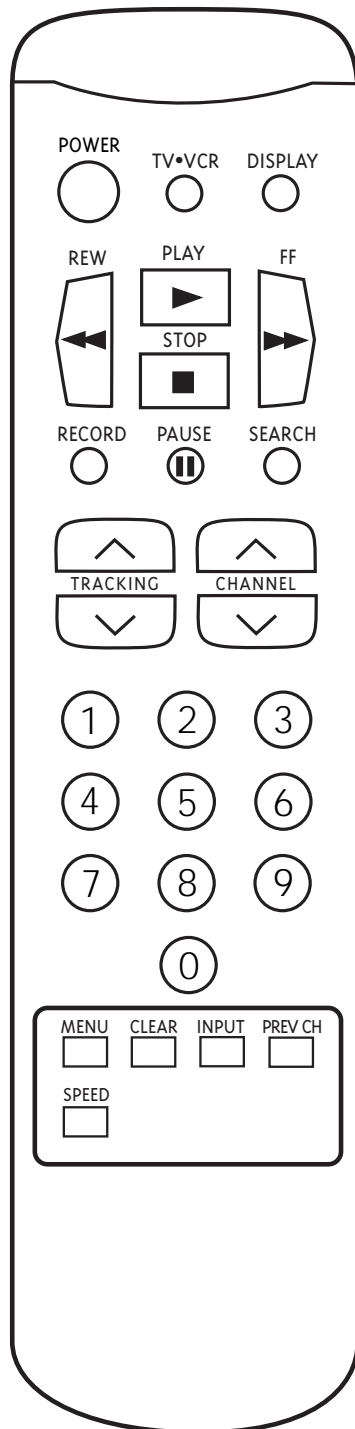

CHANNEL Up or Down

Selects next higher or lower channel in the VCR's channel memory.

CLEAR

Resets time counter to 0:00:00.

Allows you to change entries when setting the clock or VCR for a timer recording.

DISPLAY

Shows VCR operating displays on the TV screen.

Displays the time counter.

FF (Fast Forward)

Fast forwards the tape when the VCR is stopped.

Searches the picture in forward motion during playback.

INPUT

Turns the line input on or off. Line input refers to the signal coming from the component connected to the audio/video jacks on the back of the VCR.

MENU

Displays the VCR MAIN MENU on the TV screen.

Removes a menu from the screen.

Numbers (0 through 9)

Select a channel up to 99 by pressing two numbers.

Select a cable channel over 99 by pressing and holding 1 until 1-- appears on the screen. Then press the other two numbers.

POWER

Turns the VCR on and off.

PAUSE

Pauses action for viewing during playback.

Pauses recording to prevent recording of unwanted scenes.

PLAY

Plays a tape.

PREV CH (Previous Channel)

Switches between two channels.

Select one channel and then select another. Press PREV CH to switch between the two channels.

RECORD

Starts VCR recording.

Used for express recording.

See page 17.

REW (Rewind)

Rewinds the tape when the VCR is stopped.

Searches the picture in reverse motion during playback.

SEARCH

Displays INDEX and GO-TO SEARCH menus on TV.

Advances tape 60 or 120 seconds during playback.

SPEED (Tape Speed)

Selects a recording speed (SP or SLP).

STOP

Stops the normal functions such as record, playback, rewind, fast forward, and pause of the VCR.

TRACKING Up or Down

Lets you manually reduce the streaks that may appear on the picture during play or pause.

Reduces picture "jitter" during stop-action playback.

TV+VCR

Switches the picture signal so that it either comes from the VCR or the TV channel. See page 10.

Playback

To play a tape

1. Turn on the TV and tune it to channel 3, 4, or TV's video input to see the picture from the VCR.

2. Insert a tape in the VCR.

The VCR automatically turns on. The VCR indicator lights if the Auto TV/VCR feature is set to ON. The tape automatically begins playback if the safety tab on the cassette has been removed and the Auto Play feature is turned on.

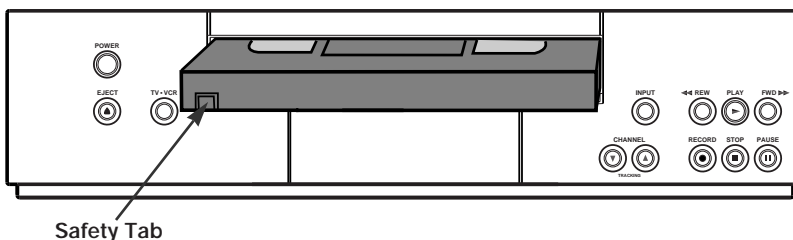

3. Press PLAY, if necessary.
4. Press TRACKING up or down to remove any streaks from the picture, if necessary. Refer to "Manual and Automatic Tracking" section.
5. Press STOP.
6. Press REW.

End of Tape

The VCR automatically rewinds the tape if it reaches the end of the tape during playback.

Power Off

If you press POWER while a tape is rewinding, the VCR turns off automatically when it is completely rewound.

7. Press EJECT on the VCR to eject the tape once it is completely rewound.

Using the Playback Features

Auto Play Feature

This feature lets you tell the VCR whether you want it to automatically start playing a tape that is inserted with the safety tab removed.

1. Press MENU on the remote to see the VCR MAIN MENU on the TV screen.
2. Press 4 to display the PREFERENCES menu.
3. Press 2 to select Auto Play: ON or OFF.
 - Select ON to have a tape with its safety tab removed start playing automatically.
 - Select OFF if you do not want a tape with its safety tab removed to start playing automatically.

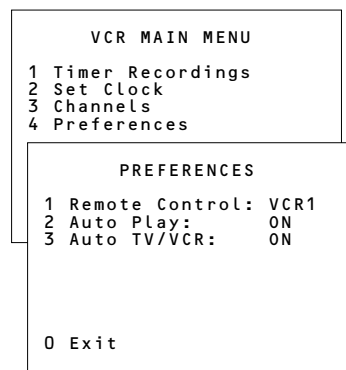

Using the Playback Features

Pause for Stop Action

This feature stops the tape in action and allows you to examine the details of the scene. Stop action works well for tapes recorded in SP or SLP speed.

1. Press PAUSE during playback to stop the action.
2. Press TRACKING up or down to reduce any jittering of the picture.
3. Press PAUSE or PLAY to return to playback.

The VCR switches from stop-action playback to stop after a few minutes.

Picture Search

You can search for a specific picture location during playback by fast forwarding or rewinding the tape. Sound is turned off during picture search. Picture search works best for tapes recorded in SP or SLP speed.

Fast Forward Search

1. During playback, press FF on the remote or FWD on the VCR to search forward at a faster-than-normal speed.
2. Press the button again or press PLAY to return to playback.

Rewind Search

1. During playback, press REW on the remote or VCR to search in reverse at a faster-than-normal speed.
2. Press the button again or press PLAY to return to playback.

Automatic Tracking

The VCR has automatic tracking which adjusts the picture when playing back a tape recorded on another VCR. Automatic tracking is turned on whenever a tape is inserted.

Manual Tracking

Occasionally, you may need to manually adjust tracking on a tape recorded on a different VCR or camcorder. Tracking is used when playing a tape, and it has no effect during recording.

- When streaks or snow appear in the picture, press TRACKING up or down on the remote or the VCR for the best possible picture.
- During pause, press TRACKING up or down on the remote to reduce any jittering of the picture.
- To turn automatic tracking back on, press both TRACKING buttons on the front of the VCR at the same time, or eject the tape and re-insert it.

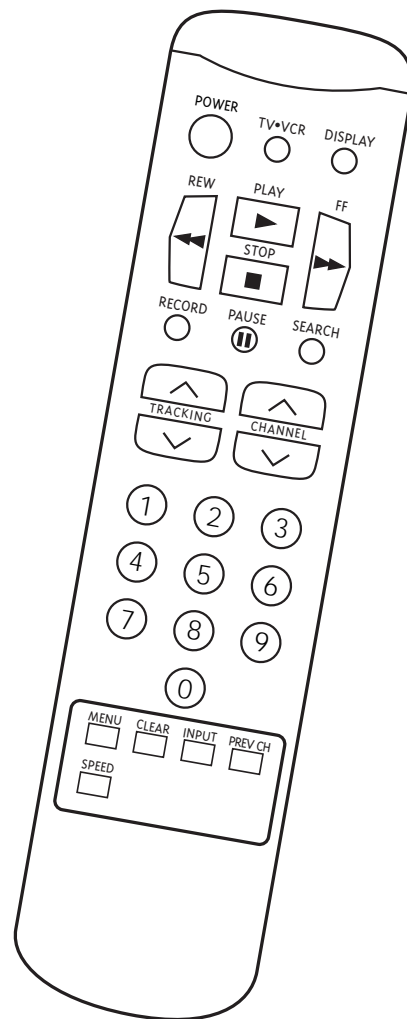

Using the Playback Features

DISPLAY Button

The DISPLAY button shows the status of the VCR channel number, time counter, date, time and tape speed on the TV screen. The time and date must be set before they can be displayed.

1. Press DISPLAY to display the status of the VCR.
If you do not press DISPLAY again, these displays will time out.
2. Press DISPLAY again to have only the time counter remain on the TV screen.
3. Press DISPLAY again to return to the normal status displays.
Turning off the VCR automatically returns the displays to normal.

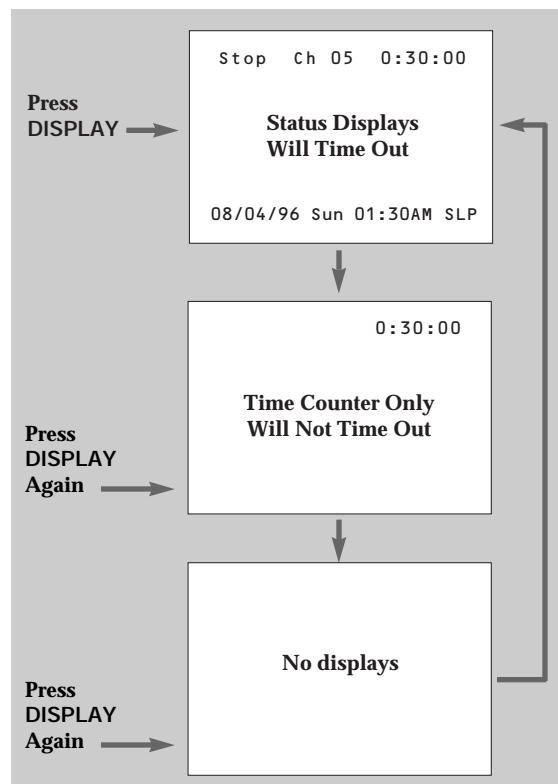

Time Counter

The time counter shows the elapsed time it takes to record a program or play back a segment of a prerecorded tape. It helps locate the beginning or end of programs you taped. The time counter resets to 0:00:00 whenever the tape is ejected from the VCR.

For example, if a 30-minute program was recorded at the beginning of the tape, you would:

1. Insert the prerecorded tape, and make sure it is rewound to the beginning. Press STOP.
2. Press DISPLAY twice to display only the time counter on the TV screen.
3. Press CLEAR to reset the time counter to 0:00:00.
4. Press F.FWD to fast forward the tape until the time counter reads 0:30:00.
5. Press STOP. This is the approximate end of the program and you can begin recording at this spot.
6. Press DISPLAY twice to remove the time counter from the screen and return to the normal displays.

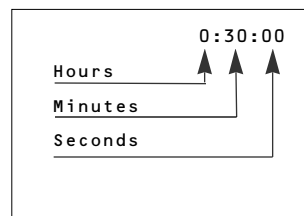

Using the Playback Features

Commercial Scan (SEARCH Button)

This is useful for scanning commercials or short program segments.

1. Press SEARCH once during playback to advance the tape approximately 60 seconds.
2. Press SEARCH twice during playback to advance the tape approximately 120 seconds.

Index Search

The VCR has a "VHS Index Search System" that automatically records an index mark on the tape every time you begin recording a program. Your VCR has two index playback features. To locate the program you want to play, select a specific index number or search by scanning.

Some index marks may be missed by the VCR.

- A mark too close to the current location on the tape.
- The mark at the beginning of a recorded segment of five minutes or less.
- The first index mark on the tape when you start searching from the beginning of the tape.

To Index Search

1. Insert the prerecorded tape and press STOP.
2. Press SEARCH on the remote to display the INDEX SEARCH menu on the TV screen.
3. Press REW or FF on the remote to scan or enter the number of index marks you want the VCR to search. Press CLEAR on the remote to correct an entry. Once the index mark or marks are found, the tape begins playback.
4. Follow the directions on the screen.

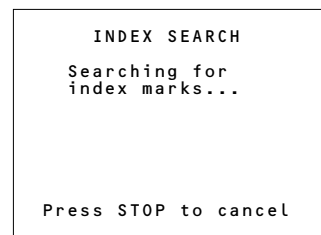
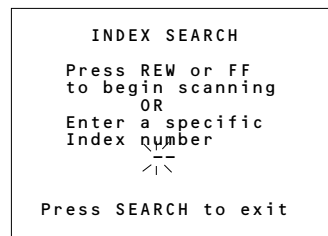

Go-To Search

The VCR searches for the time counter reading you enter and automatically begins playing back the tape.

1. Insert the prerecorded tape and press STOP.
2. Press SEARCH on the remote twice to display the GO-TO SEARCH menu on the TV screen.
3. Enter the hour(s) and minute(s) of the time counter reading you want the VCR to search. Press CLEAR on the remote to correct an entry.
4. Press REW or FF on the remote to search.
5. Press STOP to stop Go-To Searching.

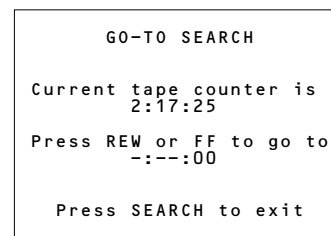

Recordings

Your VCR provides different recording options. These options are explained in this section of the manual.

Recording Speeds

Press **SPEED** on the remote to select a recording speed (SP or SLP). The speed you select appears on the TV screen. Tapes recorded in LP can be played in this VCR.

SP (Standard Play) gives the best quality recording. That is why most prerecorded, rental tapes are recorded in SP. Fewer programs can be recorded on the tape. Special effects such as pause, frame advance, slow motion, and picture search work well in this speed.

SLP (Super Long Play) gives three times the recording time of tapes recorded in SP. Special effects such as pause, frame advance, slow motion, and picture search work well in this speed.

Cassette	Recording Time	
	SP	SLP
T-120	2Hrs	6Hrs
T-160	2Hrs 40Min	8Hrs

Normal Recording

To Make a Recording

Turn on the TV and tune it to the VCR viewing channel, either 3, 4, or the TV's video input channel.

1. Insert a tape with safety tab in place.
2. If using one of the basic hookups, make sure the VCR indicator lights in the VCR's display panel. If not, press TV•VCR to turn it on.
3. Select recording speed using **SPEED** on the remote.
The tape speed indicator appears on the TV screen.
4. Select the channel to be recorded.
The channel number appears on the TV screen.
5. Press **RECORD** to begin recording.
RECORD indicator lights in the VCR's display panel while the VCR is recording.

Watch a TV Channel While VCR is Recording a Different Channel

For some cable box hookups, this recording feature may not apply. Contact your local cable company for assistance.

1. Follow steps 1 through 5 above.
2. If using one of the basic hookups, press TV•VCR to switch to the TV channel.
The VCR indicator does not light in the display panel.
3. Select the channel you want to watch with the TV's channel buttons.
4. Press **STOP** when recording is finished.

Express Recording

Express recording lets you record up to four hours without using the timer program feature. The VCR will turn off automatically at the end of the recording.

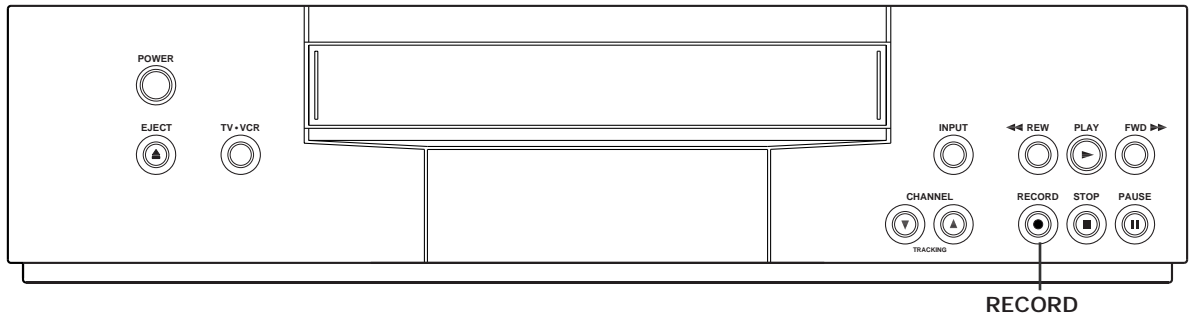

1. Turn on the VCR.
2. Insert a tape with safety tab in place.
3. Select the channel you want to record.
4. Select the desired recording speed using SPEED on the remote.
5. Press RECORD to activate recording.

6. Press RECORD repeatedly until the amount of recording time for the program is displayed in the VCR's display panel or on the TV screen.

Each press increases the time — 30 minutes up to 4 hours.
 The amount of time the VCR will record appears on the TV screen and the RECORD and TIMER indicators light in the VCR display panel.

Rec Ch 04 Record Length 0:00	Press RECORD	Recording Time
Press REC to set Length	0:30	(30 Min)
	1:00	(1 Hr)
	1:30	(1 Hr, 30 Min)
	2:00	(2 Hrs)
	3:00	(3 Hrs)
	4:00	(4 Hrs)
	0:00	(Recording Turns Off)

Display on TV Screen

Stopping a Recording in Progress

You can stop a recording by:

- Pressing and holding the STOP button for approximately three seconds.
- Pressing the RECORD button until 0:00 is displayed for the recording.

Recording While You're Away (Timer Recording)

The timer program features let you program the VCR to record up to eight different programs within a one year period. Before setting the timer, make sure that:

- The clock is set correctly.
- A tape with safety tab has been inserted with enough tape to record the program(s).
- If you receive all channels through a cable box, select a cable box viewing channel *as described on the next page*.

Setting a Timer Recording

1. Press MENU on the remote to display the VCR MAIN MENU.
2. Press 1 to display the TIMER RECORDINGS menu.
3. Press 1 to display the Create a New Program menu.
4. Press 1, 2, 3, or 4 to select type of program.
 - 1 One time — single program recorded once.
 - 2 Daily — program recorded at same time every day.
 - 3 Weekdays — program recorded at same time Monday through Friday.
 - 4 Weekly — program recorded at same time once a week.
5. Press number buttons on the remote to enter the channel number (or INPUT to select the line input), start time including AM or PM, end time, and start date of the recording. Just follow the on-screen prompts. Press CLEAR to correct an entry.

If you receive all channels from a cable box and have completed Cable Box Setup *on the next page*, the output channel of your cable box will automatically appear on the menu.
6. Select recording speed using SPEED or number button on the remote.
7. Press MENU to enter your program.

A reminder appears which times out.
PROGRAMS OVERLAP may appear on the screen if you entered two programs where the times overlap.
8. The TIMER RECORDINGS menu appears. Press 1 to enter an additional timer program, or press 0 to exit.
9. **Turn off the VCR** before recording begins.

TIMER indicator lights in the VCR display panel when the timer has been programmed.
10. **If using a cable box, leave it turned on and tuned to the channel you want to record.**

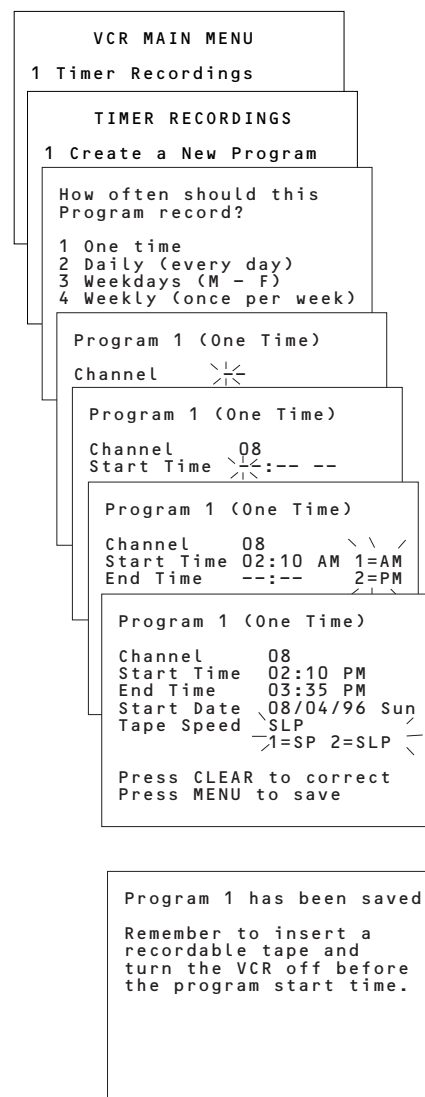

Stopping a Recording in Progress

You can stop a recording by pressing and holding the STOP button for approximately three seconds.

Recording While You're Away (Timer Recording)

Select Cable Box Viewing Channel

If you have a cable box, follow the directions below.

1. Press MENU on the remote to display the VCR MAIN MENU on the TV screen.
2. Press 3 to display CHANNELS menu.
3. Press 4 to display Cable Box Setup menu.
4. Select one of the three options:

1 ALL Channels

- Press 1 for ALL channels and then enter two numbers for the output channel of your cable box. (Valid numbers are 01-13.)
- Press CLEAR to correct an entry.
If you connected your cable box to the VCR using the cable box's AUDIO/VIDEO OUT jacks, press INPUT on the VCR to select VIDEO IN option.
- Press MENU. A message appears which will time out or press MENU to return to VCR MAIN MENU.

VCR will now automatically enter the output channel of your cable box in the Timer Recordings menu.

2 Only SOME Channels

Skip this setup if your cable box is not required for all channels.

- Press 2 for Only SOME channels.
- Press MENU to continue.

3 Cancel setup

- Press 3 to cancel the CABLE BOX SETUP feature.
- Press MENU to continue.

```
VCR MAIN MENU
1 Timer Recordings
2 Set Clock
3 Channels
```

```
CHANNELS
1 Auto Channel Search
2 Add/Remove Channels
3 Signal Type: ANTENNA
4 Cable Box Setup
```

```
CABLE BOX SETUP
Do you use your cable
box to receive ALL
channels or only SOME
channels?
1 ALL channels
2 Only SOME channels
3 Cancel setup
```

```
CABLE BOX SETUP
On what channel does
the VCR receive signals
from the cable box?
(usually 3, 4 or Video)
--
Press 01-13 or INPUT
Press MENU to cancel
```

```
CABLE BOX SETUP
The feature works only
if the cable box is used
to receive ALL channels.
Consult your User's
Manual for assistance.
Press MENU to continue
```

```
CABLE BOX SETUP
The Cable Box Setup
was canceled.
The VCR will NOT control
the cable box channel
during timer recordings.
Press MENU to continue
```

Recording While You're Away (Timer Recording)

Checking or Clearing Timer Recordings

1. Press MENU on remote to display VCR MAIN MENU on TV screen.
2. Press 1 to display the TIMER RECORDINGS menu.
3. Press 2 for Review Existing Progs. feature.
4. Press MENU to display the next program or press CLEAR to erase the program on the screen.

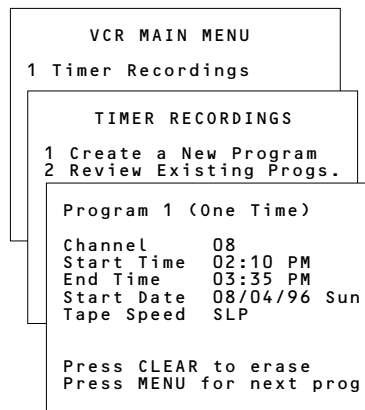

Timer Recording From the VCR's Line Input

The line input refers to the signal coming from the AUDIO and VIDEO IN jacks of the VCR. Recording from the line input is convenient if you have a satellite receiver or similar component attached to these jacks. To timer record from the component connected to the VCR's line input:

Press INPUT to enter VIDEO instead of the channel number on the TV screen during timer programming.

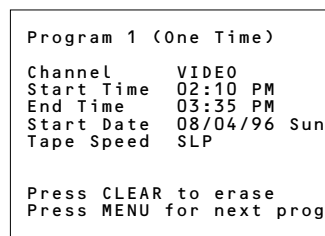

Recording Features

Recording Pause

To prevent recording short passages of unwanted material, use PAUSE during recording to stop and start recording. The VCR automatically switches from pause to stop after a few minutes.

Using Two VCRs for Copying and Editing Tapes

Operating Instructions (Refer to "Connecting Two VCRs for Copying" hookups.)

Use one VCR as the playback VCR and the other as the recording VCR.

Caution: The unauthorized recording of television programs and other materials may infringe the rights of others.

1. Turn on the TV and VCRs.
2. Tune TV to the VCR viewing channel, either 3, 4, or TV's video input.
3. If you have connected your VCR using Option A (page 6), tune recording VCR to channel 3 or 4 — the one selected on the back of the playback VCR. If you have connected your VCR using Option B (page 6), press INPUT on recording VCR to select the line input.
4. Insert the tape you want to copy into playback VCR. Insert a blank tape with safety tab in place into recording VCR.
5. Press PLAY, then PAUSE on playback VCR when you reach the point on the tape or program where you want to begin copying. If the tape was not recorded on the playback VCR, streaks may appear and you may need to adjust tracking. To prevent on-screen displays on the playback VCR from appearing on the recording, use PAUSE button to start and stop playback.
6. Press RECORD, then PAUSE, on recording VCR.
7. Press PAUSE buttons on both VCRs at the same time to begin copying the tape.*
8. Edit out segments that you do not want to copy by pressing PAUSE on recording VCR to stop copying the tape. Then locate the next segment you want to copy on the playback VCR by using FWD, REW, and PLAY. Press PAUSE on the playback VCR. Press PAUSE **at the same time** on both VCRs to resume copying.
9. Press STOP on both VCRs when you are finished.

* You may turn off the TV after the recording has started as it does not have to be on to copy a tape.

Copying and Editing Using Compatible Remote

If you have a compatible RCA, ProScan, or GE remote with VCR1 and VCR2 buttons, you can program this VCR to respond to VCR1 (VCR2). This allows you to control both VCRs with one remote for easier copying and editing.

Set the Remote Control feature of this VCR to the VCR1 or VCR2 position. The remote then controls the VCR with either the VCR1 or VCR2 button — whichever position you select in the menu.

1. Press MENU to display the VCR MAIN MENU.
2. Press 4 to display PREFERENCES.
3. Press 1 to activate the Remote Control feature.
4. Press VCR1 or VCR2 on your compatible remote to change the setting and program this VCR to respond to the VCR1 or VCR2 button — whichever you select.

Important Reminder: Remember you must press VCR1 or VCR2 on the remote — whichever you selected in the menu — before the remote will operate this VCR.

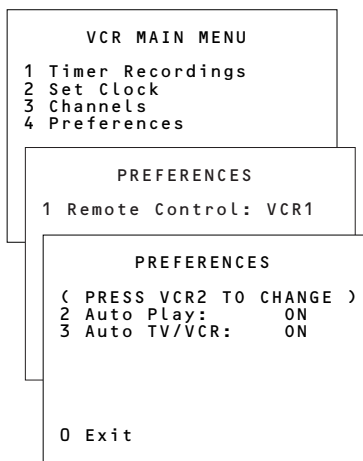

Location of Controls

Front Panel

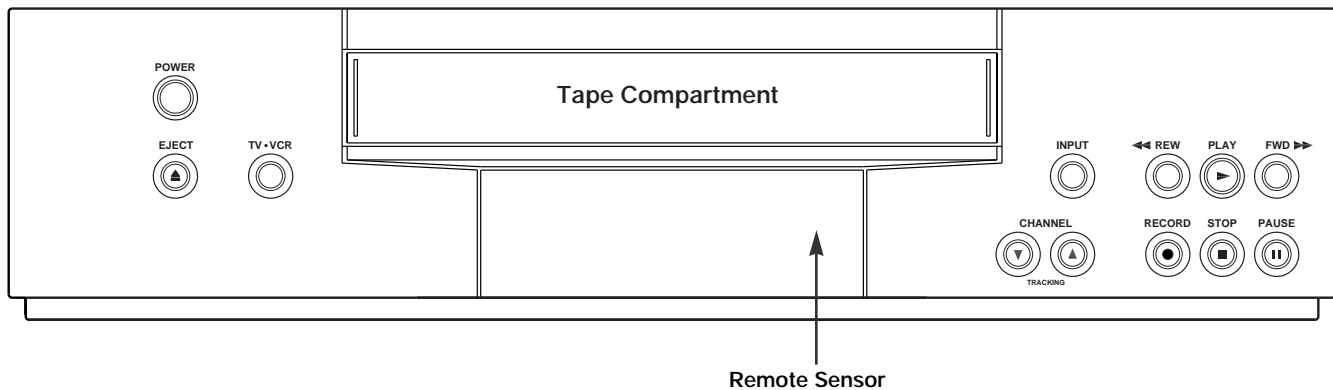

CHANNEL/TRACKING Up or Down

Selects next higher or lower channel in the VCR's channel memory.

Adjusts tracking when a tape is playing.

EJECT

Press when the VCR is stopped to eject the cassette.

FWD (Fast Forward)

Fast forwards the tape when the VCR is stopped.

Searches the picture forward during playback.

INPUT

Turns the line input on or off.

Line input refers to the signal coming from the component connected to the audio/video jacks on the back of the VCR.

PAUSE

Pauses action for viewing during playback.

Pauses recording to prevent recording of unwanted scenes.

PLAY

Plays a tape.

POWER

Turns the VCR on or off.

RECORD

Starts VCR recording.

Used for express recording.

Remote Sensor

Receives signals from the remote control.

Aim the remote at this sensor with no objects between them.

REW

Rewinds the tape when the VCR is stopped.

Searches the picture in reverse during playback.

STOP

Stops the normal functions such as record, playback, rewind, fast forward, or pause.

TV•VCR

Switches the picture signal so that it either comes from the VCR or the TV channel.
See page 10.

Location of Controls

Back Panel

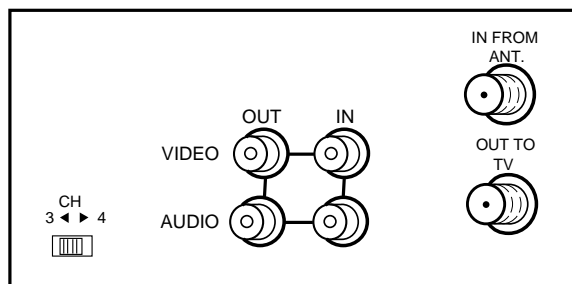

CH 3◀▶4 Switch

Selects the channel to which you will tune the TV to see the VCR picture if you connect the VCR using one of the basic hookups.

IN FROM ANT. (Antenna) Connector

Receives the signal from an antenna or cable system that is attached to this connector.

OUT TO TV Connector

Passes signal to TV using the cable supplied.

VIDEO and AUDIO IN Jacks

Receives signals from another component, like a VCR or camcorder, when it is connected to these jacks.

Use INPUT to select.

VIDEO and AUDIO OUT Jacks

Sends signals from VCR to another component, like a TV monitor or VCR, when it is connected to these jacks.

Display Panel

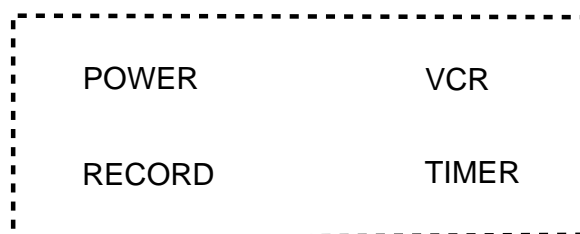

POWER Indicator

Lights when the VCR is on.

RECORD Indicator

Lights when the VCR is recording.

TIMER Indicator

Shows VCR is set for timer recording when VCR is turned off.

VCR Indicator

Press TV•VCR to turn on or off.

When using one of the basic hookups:

- With VCR indicator on, the picture comes from the VCR.
- With VCR indicator off, the picture comes from the television channels.

Trouble Checks

Sometimes problems can be easily solved by checking a few basic things. Check below before you call for help or take your VCR to an Authorized RCA VCR Servicenter.

Trouble	Here's what to try:
No power	<ul style="list-style-type: none"> • Plug VCR into an operating outlet. • Check connections.
VCR does not respond to remote	<ul style="list-style-type: none"> • Aim remote at VCR with no objects between them. • Change batteries.
Poor or no picture for normal TV viewing	<ul style="list-style-type: none"> • Press TV•VCR to turn VCR indicator off. • Switch TV to an active channel. • Check antenna connections.
Snowy or no picture during playback	<ul style="list-style-type: none"> • Press TV•VCR to turn VCR indicator on. • Check TV channel selected (3 or 4) to make sure it matches the channel selected with CH3 CH4 switch on back of VCR. • Check TV's fine tuning. • Check video cable connections between VCR and TV monitor. • Set TV monitor to video input channel. • Try another tape. • Some snow/streaks are normal during search, frame advance, slow motion, and stop action playback.
Streaks in picture during normal playback	<ul style="list-style-type: none"> • Press one of the TRACKING buttons to move streaks up or down and out of the picture. • Check tape — it may be worn out or of poor quality.
Time counter not working	<ul style="list-style-type: none"> • The time counter does not advance during unrecorded portions of tape. When an unrecorded segment of tape is encountered, the time counter will hold its count until recorded material is detected again. • A minus (-) will appear in front of the time if you rewind the tape farther back than a counter reading of 0:00:00.
Will not record or play	<ul style="list-style-type: none"> • No cassette in VCR. • Eject and re-insert cassette. • Broken tape — try another cassette. • VCR is in pause mode. Press PAUSE.
Will not record	<ul style="list-style-type: none"> • Safety tab removed from cassette. • Make sure the line input is not selected. Press INPUT to turn off the line input.
Timer recording not made or wrong program recorded	<ul style="list-style-type: none"> • Cable box was not turned on at time recording was to begin. • Program entered incorrectly (wrong channel or times). • Power interruption. Reset clock. • Check to see if time and date are correct — including AM/PM. • Program exceeded tape's length or tape was not rewound beforehand. • VCR was not turned off at the time recording was to start. • No tape in VCR or cassette's safety tab broken off.

Trouble Checks

Trouble	Here's what to try:
Rewind does not operate	<ul style="list-style-type: none">• Tape already rewound.
VCR makes noise when stopped	<ul style="list-style-type: none">• VCR is removing tape from heads. This is normal. The head cylinder inside the VCR will continue to rotate for a few minutes after you put the VCR in the stop mode.
Will not auto channel search active channels correctly	<ul style="list-style-type: none">• Check antenna connections.• Check Signal Type: CABLE/ANTENNA feature. <i>See page 8.</i>
Cannot select channels over 69	<ul style="list-style-type: none">• Cable channels over 69 can only be selected if Signal Type: CABLE/ANTENNA feature is set to CABLE. <i>Details are on page 8.</i>
Cassette with safety tab removed does not start to play automatically	<ul style="list-style-type: none">• Set Auto Play ON/OFF feature to ON. <i>Details are on page 12.</i>

Specifications

Format:	VHS
Record/Playback System:	Video: 2-Head Audio: Mono record/playback system
Video Signal System:	EIA standard: NTSC color
Antenna:	75-ohm external VHF/UHF combined antenna terminal
Tuner:	USA: 181 channels capability* (125 cable channels) Canada: 178 channels capability* (122 cable channels)
Type:	AutoProgramming frequency synthesis
Power Requirement:	120V AC, 60 Hz
Power Consumption:	17 watts
Dimensions:	3.6 inches high (91.5 mm) 15.4 inches wide (390 mm) 12.5 inches deep (318.5 mm)
Weight:	8.8 pounds (4.0 kg)
Storage Temperature Range:	- 22°F to +149°F (- 30°C to +65°C)
Operating Temperature Range:	+41°F to +104°F (+ 5°C to +40°C)

*Check your cable company's compatibility requirements.

Cleaning the VCR

Use a soft cloth or dusting attachment of your vacuum cleaner to dust your VCR. Remove dust from the ventilation holes on the top, back, sides, and bottom of the cabinet.

Plastic surfaces are easily scratched and can be marred by alcohol and various solvents. Avoid excessive use of oil-based furniture polishes since the materials used in the cabinet will accumulate more dust. We recommend using a non-abrasive, anti-static cleaner and polisher.

Limited Warranty

What your warranty covers:

- Any defect in material or workmanship.

For how long after your purchase:

- Ninety days for labor charges.
- One year for parts.

The warranty period for rental units begins with the first rental or 45 days from date of shipment to the rental firm, whichever comes first.

What we will do:

- Pay any Authorized RCA VCR Servicenter the labor charges to repair your VCR.
- Pay any Authorized RCA VCR Servicenter for the new or, at our option, refurbished replacement parts required to repair your VCR.

How you get service:

- Take your VCR to any Authorized RCA VCR Servicenter. To identify your nearest Authorized RCA VCR Servicenter, ask your dealer, look in the Yellow Pages, or call 1-800-336-1900.
- Show the service technician your evidence of purchase date.
- Pick up your VCR when repairs are completed.

What your warranty does not cover:

- Customer instruction. (Your Owner's Manual clearly describes how to install, adjust, and operate your VCR. Any additional information should be obtained from your Dealer.)
- Installation and related adjustments.
- Signal reception problems not caused by your VCR.
- Damage from misuse or neglect.
- Cleaning of video/audio heads.
- Remote control batteries.
- A VCR that has been modified or incorporated into other products or is used for institutional or other commercial purposes.
- A VCR purchased or serviced outside the USA.
- Acts of God, such as but not limited to lightning damage.

Product Registration:

- Please complete and mail the *Product Registration Card* packed with your VCR. It will make it easier to contact you should it ever be necessary. The return of the card is not required for warranty coverage.

How state law relates to this warranty:

- This warranty gives you specific legal rights, and you also may have other rights that vary from state to state.

If you purchased your VCR outside the United States:

- This warranty does not apply. Contact your dealer for warranty information.

Index

Accessories, Included	7
Add or Remove Channels from Memory	9
ADD/REMOVE CHANNEL Menu	9
Antenna Connections	2,3
AUDIO and VIDEO Jacks	3-6,20,23
Auto Play Feature	12
Auto TV/VCR Feature	9,12
Auto Channel Search Feature	8
Back Panel	23
Batteries, Inserting in Remote	7
Cable Box Viewing Channel	19
Cable System With Cable Box Connections	2,3-5
Cable System Without Cable Box Connections	2,3
Card, Registration	i
Cassette, Insert	12
CH3◀▶4 Switch	3-7,10,23
CHANNEL Up or Down Button	8,9,11,22
CHANNELS Menu	8,9
Checking Timer Programs	20
Checks, Trouble	24,25
Choosing a Hookup	2
Cleaning the VCR	26
CLEAR Button	9,11,14,15,18,20
Clearing Timer Programs	20
Commercial Scan	15
Connections	
Antenna	2,3
Cable System with Cable Box for All	
Channels	2,4
Cable System with Cable Box for Pay	
Channels Only	2,5
Cable System with No Cable Box	2,3
VCR for Tape Copying	2,6
Contents	1
Copying Tapes	21
Date and Time, Setting	9
Design Specifications	26
DISPLAY Button	11,14
Display Panel	23
Displays, Status	18
Editing Tapes	21
English	8
EJECT Button	12,22
Express Recording	17
Express Recording, Stopping	17
FF or FWD (Fast Forward)	
Buttons	11,13,15,21,22
French	8
Front Panel	22
GO-TO SEARCH Menu	15
Hook-Ups	
Antenna	2,3
Cable System with Cable Box for All	
Channels	2,4
Cable System with Cable Box for Pay	
Channels Only	2,5
Cable System with No Cable Box	2,3
VCR for Tape Copying	2,6
Indicators	
POWER	23
RECORD	23
TIMER	23
VCR	23
Idioma	8
IN FROM ANT (Antenna) Connector	3-6,23
INDEX SEARCH	15
INPUT Button	11,20-22,23
Insert Cassette	12
Language	8
Languge	8
Limited Warranty	27
Line Input, Recording From	20
Location of Controls	
Remote Control	11
VCR Back Panel	23
VCR Display Panel	23
VCR Front Panel	22
LP Speed	16
MENU Button	8-11,18-20
Normal Recording	16
Number Buttons	11
On-Screen Displays	14
Operating Instructions	
Copying Tapes	21
Express Recording	17
Normal Recording	16
Playing a Tape	12
Timer Recording	18
OUT TO TV Connector	3-6,23
PAUSE Button	11,13,20,21
Pause for Stop Action	13
Pause, Recording	20
Picture Search	13
PLAY Button	11,12,21,22
POWER Button	11,22
POWER Indicator	23
PREFERENCES Menu	9,10,12,21
PREV CH (Previous Channel) Button	11
Problems, Solving	24,25
Product Registration	i

Index

PROGRAMS OVERLAP Message	18	Table of Contents	1
RECORD Indicator	17,18,23	Tape Speed Indicators	16
RECORD Button	11,16,18,22	Tape	
Recording		Copying	21
Express	17	Editing	21
Normal	16	Playing	12
Timer	18	Time and Date, Setting	9
Watching One Program While Recording		Time Counter	14
Another	16	Timer Recording	
Recording, Normal	16	Checking and Clearing	20
Registration Card	i	Setting a Recording	18
Remote Control	11	Stopping a Recording	18
Remote Control: VCR1/VCR2 Feature	21	TIMER Indicator	23
Remote Sensor	22	TIMER RECORDINGS Menu	18
Remove or Add Channels from Memory	9	TRACKING Buttons	11,13,22
REMOVE/ADD Channel Menu	9	Trouble Checks	24,25
REW (Rewind) Button	11,13,15,21,22	Turn On VCR	7
Safety Precautions	i	TV•VCR Button	9,10,11,12,22
Safety Tab	12	VCR Controls	22,23
SEARCH Button	11,15	VCR Indicator	9,10,12,23
Search, Picture	13	VCR MAIN MENU	8,9,18,19
Sensor, Remote	22	VCR, Cleaning	26
Signal Type: CABLE/ANTENNA Feature	8	VCR, Turn On	7
SLP Speed	16	VCR1 and VCR2 Buttons	21
SP Speed	16	VCRs Memory, Placing Channels	8
Spanish	8	VCRs, Connecting for Tape Copying	6
Specifications	26	Warranty, Limited	27
SPEED Button	11,16-18,21	Watch One Channel While Recording	
Speeds, Recording	16	Another	16
Status Displays	14		
STOP Button	11,22		
Stop Action Pause	13		
Stopping			
Express Recording	17		
Timer Recording	18		

For your nearest Home Entertainment Dealer
or Authorized Servicenter
call toll-free in the U.S.A.

1-800-336-1900

Canadian Consumers –
Your toll free numbers are:

English: 1-800-522-0338

French: 1-800-522-0445

If you would like a copy of this manual in French, please follow the
instructions below:

Si un livret d'instructions en français n'est pas inclus avec votre appareil, vous
pouvez en obtenir un (indiquer le numéro de modèle, votre nom, et votre
adresse) en vous adressant à:

Thomson Consumer Electronics
Attention: Canadian Operations
P.O. Box 0944
Indianapolis, IN 46206-0944

Please do not send any products to the Indianapolis address listed
in this manual or on the carton. This will only add delays in service
for your product.

 **THOMSON CONSUMER ELECTRONICS**
10330 N. Meridian Street
Indianapolis, IN 46290

©1996 Thomson Consumer Electronics, Inc.

Trademark(s)® Registered

Marca(s) Registrada(s)

Printed in Korea

Part Number 96-VR336-1

Free Manuals Download Website

<http://myh66.com>

<http://usermanuals.us>

<http://www.somanuals.com>

<http://www.4manuals.cc>

<http://www.manual-lib.com>

<http://www.404manual.com>

<http://www.luxmanual.com>

<http://aubethermostatmanual.com>

Golf course search by state

<http://golfingnear.com>

Email search by domain

<http://emailbydomain.com>

Auto manuals search

<http://auto.somanuals.com>

TV manuals search

<http://tv.somanuals.com>