

RCA

DVD Recorder User's Guide DRC8005N

Changing Entertainment. Again.



A THOMSON BRAND

Important Information

CAUTION

RISK OF ELECTRIC SHOCK
DO NOT OPEN



This symbol indicates that this product incorporates double insulation between hazardous mains voltage and user accessible parts.



This symbol indicates "dangerous voltage" inside the product that presents a risk of electric shock or personal injury.



This symbol indicates important instructions accompanying the product.

FCC INFORMATION

This equipment has been tested and found to comply with the limits for a Class B digital device, pursuant to Part 15 of the FCC rules. These limits are designed to provide reasonable protection against harmful interference in a residential installation. This equipment generates, uses and can radiate radio frequency energy and, if not installed and used in accordance with the instructions, may cause harmful interference to radio communications. However, there is no guarantee that interference will not occur in a particular installation. If this equipment does cause harmful interference to radio or television reception, which can be determined by turning the equipment off and on, the user is encouraged to try to correct the interference by one or more of the following measures.

- Reorient or relocate the receiving antenna.
- Increase the separation between the equipment and receiver.
- Connect this equipment into an outlet on a circuit different from that to which the receiver is connected.
- Consult the dealer or an experienced radio/TV technician for help.

This class B digital apparatus meets all requirements of the Canadian Interference-Causing Equipment Regulations.

Refer to the identification/rating label located on the back panel of your product for its proper operating voltage.

Product Registration

Please fill out the product registration card and return it immediately. Returning the product registration card allows us to contact you if needed.

Keep your sales receipt to obtain warranty parts and service and for proof of purchase. Attach it here and record the serial and model numbers in case you need them. The numbers are located on the back of the DVD Recorder.

Model No. **DRC8005N** Serial No. _____
Purchase Date: _____
Dealer/Address/Phone: _____

WARNING

To reduce the risk of fire or shock hazard, do not expose this DVD Recorder to rain or moisture.

CAUTION

THIS PRODUCT UTILIZES A LASER. USE OF CONTROLS OR ADJUSTMENTS OR PERFORMANCE OF PROCEDURES OTHER THAN THOSE SPECIFIED HEREIN MAY RESULT IN HAZARDOUS RADIATION EXPOSURE. DO NOT OPEN COVERS AND DO NOT REPAIR YOURSELF. REFER SERVICING TO QUALIFIED PERSONNEL.

CAUTION

FCC Regulations state that unauthorized changes or modifications to this equipment may void the user's authority to operate it.

Note:

This DVD Recorder is designed and manufactured to respond to the Region Management Information. If the Region number of a DVD disc does not correspond to the Region number of this DVD Recorder this DVD Recorder cannot play the disc. The Region number for this DVD Recorder is Region No 1.

Note:

This device is protected by U.S. patent numbers 4,631,603 and 4,577,216 and 4,819,098 and other intellectual property rights. The use of Macrovision's copy protection technology in the device must be authorized by Macrovision and is intended for home and other limited pay-per-view uses only, unless otherwise authorized in writing by Macrovision. Reverse engineering or disassembly is prohibited.

The apparatus shall not be exposed to dripping or splashing and that no objects filled with liquids, such as vases, shall be placed on the apparatus.

**CLASS 1
LASER
PRODUCT**

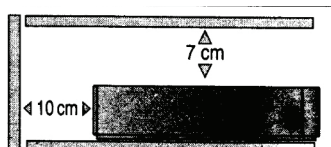
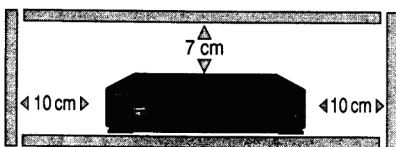

Ventilation:

You must adequately ventilate the product. Make sure there is adequate space around the DVD Recorder to provide proper air flow for ventilation. See diagram.

Table of Contents

Chapter 1: Connections and Setup

Things to consider before you connect.....	2
Choose your connection.....	3
Explanation of Jacks and Cables	4
Back of the DVD Recorder.....	4
Connection: DVD Recorder + TV + VCR (optional).....	6
Connection: DVD Recorder + TV + Cable Box	8
Connection: DVD Recorder + TV + Satellite Receiver	10
Advanced Audio Connection Information	12
Install batteries in the remote control	13
Turn on the TV and the DVD Recorder	13
Complete Interactive Setup.....	13
How to find your TV's Video Input Channel	16
What to Expect	15
Next Steps	16

Chapter 2: The Remote Control

Explanation of buttons	18
Find out if the remote can be programmed to operate your TV	19
Programming the remote to operate your TV	19
Programming the remote to operate your satellite receiver or cable box	20
Using the remote to operate other components	20
Code list for programming the remote control	21

Chapter 3: Using the Recorder's Features

Watching TV	24
The Channel Banner	24
Recording	24
Express recording.....	24
Watching one channel while you record another channel	24
Setting up Timer Recordings to record programs automatically.....	25
Conflicting Timers	25
Disc Library	26
Editing the Disc Library's Contents	26
Finding a title (movie, program, etc.) by using the Sort Feature	26
Playback	27
Using the Info Display while Playing DVD+RW and DVD+R discs.....	27
Using the Split Title Feature to Copy Camcorder Videocassette Tapes to Disc	28
Editing Recordings with the Hide Chapter Feature	28

Chapter 4: Playing Discs

Regional Coding.....	30
How to Load and Play Discs.....	30
Using Different Menus	31
Search Options	31
Playback Options.....	31
Using the On-Screen Info Display	32
Time Display	33
Selecting a Title on DVDs or a Track on Audio CDs or VCDs.....	33
Chapter Icon	33
Subtitle Icon	33
Repeat Feature	34
Changing the Audio Language	34
Changing the Camera Angle.....	35
Repeat Icon	34
Audio Icon.....	34
Camera Angle Icon.....	35
Play Mode Icon	35
IntroScan (Audio CD only)	36
PlayBack Control (PBC), Video CD only	36
Playing mp3 and/or JPEG files	37
Viewing JPEG files	42

Chapter 5: The Menu System

Overview of the Menu System	40
The Main Menu	40
Watch TV	41
Disc	41
Play Disc	41
Disc Title Menu	41
Player Menu	41
Playlist	41
Disc Options.....	42
Autoplay	42
Screen Format	42
Angle Icon	42
Disc Library	42
Timers	42
Setup.....	43
Parental Controls	43
Lock/Unlock	43
Rated Titles.....	44
Unrated Titles	44
System Options	44
Digital Output	44
SRS/TruSurround.....	44
Black Level	44
Display Dimmer	44
Audio Broadcast.....	44
Recording Options	45
Recording Quality	45
Smart Record.....	45
Disc Options	45
Languages	45
Display.....	45
Audio	45
Subtitles	45
Disc	45
Installation Menu	46
Interactive Setup	46
Channel Search	46
Clock Setup	46
Channel List	46
Memory Card Menu.....	46

Chapter 6: Additional Information

Troubleshooting.....	48
Handling Cautions.....	51
Maintenance of Cabinet	51
Front of DVD Recorder	52
Limited Warranty	53
Accessories.....	54
Copying content from a DVD+R or DVD+RW disc to a VCR videocassette	55
Copying content from a VCR videocassette to a DVD+R or DVD+RW disc	56

Chapter I: Connections and Setup

Things to consider before you connect

Protect components from overheating

- Don't block ventilation holes on any of the components. Arrange the components so that air can circulate freely.
- Don't stack components.
- When you place components in a stand, make sure you allow adequate ventilation.
- If you connect an audio receiver or amplifier, place it on the top shelf.

Position cables properly to avoid audio interference

- Insert each cable firmly into the designated jack.
- If you place components above the TV, route all cables down the side of the back of the TV instead of straight down the middle of the back of the TV.
- If your TV has an antenna that uses 300-ohm twin lead cables, do not coil the cables. Also, keep the twin lead cables away from audio/video cables.

Connection Pictures

Audio/video cables are usually bundled together. For better visibility, the connection pictures in this book show each cable separately (audio left, audio right, and video).

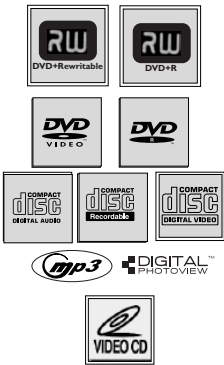

Recording: Types of discs you can use

DVD+R and DVD+RW

Playback: Types of discs you can play

- **DVD discs** – contain picture and sound (DVD-RW, video mode only; DVD-R; DVD+R; DVD+R are compatible with this player).
- **CDs (Audio CDs, CD-R, CD-RW)** – Audio CDs contain musical or sound content only. mp3 discs are CDs (CD-R or CD-RW) that contain mp3 files. This product also plays CDs that contain JPEG files and Multisession CDs.
- **Video CD (VCD) and Super Video CD (S-VCD) discs** – Like DVD video discs, VCDs contain picture and sound content. The difference is the amount of information that can be stored on the disc. VCDs typically have lower picture and sound quality than DVD discs. Super Video CDs (S-VCDs) can be used to record up to 70 minutes of digital sound and video, with MPEG-2 standard video and MPEG-1 standard audio—but you must use DVD+R or DVD+RW discs to record on your DVD Recorder not S-VCDs. Additionally, S-VCD disc compatibility is dependent on which MPEG coding software, disc design software, and disc writer software are used; and the discs themselves.

Some discs may not be compatible due to laser pickup and disc design.

Unpack the Box

Your DVD Recorder came with the following items:



DVD Recorder



2 Way Splitter (part number VH47)

You must connect the 2 Way Splitter in order to watch one program while you record another one. Not applicable with satellite or digital cable box.



Remote control and batteries (part number 261387)

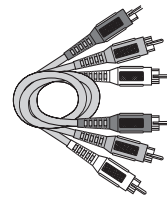

1 set of audio video cables (part number 233086)

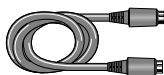

S-Video cable (part number 257982)







RF Coaxial cable (part number 221396)

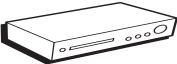
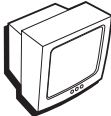
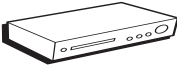
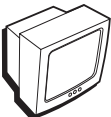

Power cord (part number 218104)

Choose Your Connection

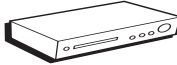
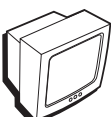
There are several ways to connect your DVD Recorder. Please use the following chart to determine which connection is best for you. Turn to the appropriate page for specific instructions.

Components			Cables Needed	Connection	Go to
 DVD Recorder	 TV		<ul style="list-style-type: none"> • Coaxial • Audio/video • S-Video 	TV	p. 6
 DVD Recorder	 TV	 Cable Box	<ul style="list-style-type: none"> • Coaxial • Audio/video • S-Video 	TV + cable box	p. 8
 DVD Recorder	 TV	 Satellite Receiver	<ul style="list-style-type: none"> • Coaxial • Audio/video • S-Video 	TV + satellite receiver	p. 10

To achieve enhanced picture quality, use the S-Video Cable (supplied) to connect your DVD Recorder to your TV if your TV has an S-Video jack available.

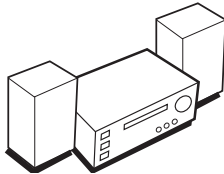

Connecting an optional audio receiver:

After you connect the DVD Recorder to your TV (choose an option above), go to page 10 for general information about connecting an audio/video receiver.

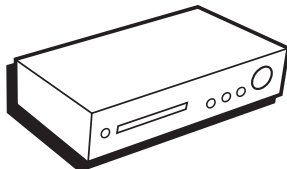

VCR Connection

go to pages 55 & 56

If you want to copy content from a DVD to a videotape or vice versa, go to pages 55 and 56 for general information.

Note: You cannot transfer copy-protected content.

Explanation of Input Jacks and Cables

This section describes the jacks and cables you can use to make connections (only S-Video and Audio/Video cables are packed with your DVD Recorder — you can purchase other cables by calling 1-800-338-0376, details are on page 55, or order online at www.rca.com, or go to your local electronics store). There are several ways to connect your DVD Recorder to your TV depending upon the cables you have and the jacks that are on the back of your TV.

Different jacks and cables provide a different level of performance. It's important to remember, we're talking about degrees of picture improvement for comparison. If your TV has Component jacks (Y, Pb, Pr), S-VIDEO, and composite video (often color-coded yellow and grouped with Audio Left and Right jacks that are white and red); Component (Y, Pb, Pr), would be considered excellent, S-Video would be very good, and the composite video jack (yellow) would be considered good.

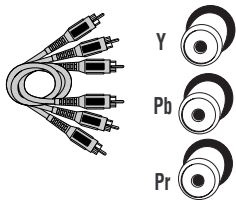

Component Video (Y, Pb, Pr) Jacks and Cables

The Y, Pb, Pr jacks provide optimum picture quality because the video is separated into three signals (two signals are dedicated to the color portion of the image, and the other signal is dedicated to the black and white part of the image).

To ensure maximum picture quality, use three video-grade cables (not supplied) for the connection. There are bundled component video cables (not supplied) sold that are color-coded to match the Y, Pb, Pr jacks (red, green, and blue). Component Video Input jacks are usually found on high-end TVs, such as HDTVs; multimedia monitors; and some of the "flat" LCD and Plasma TVs or monitors.

Note: Also, remember to connect the left and right audio cables because the Y, Pb, Pr jacks and cables carry only the picture signal, not the

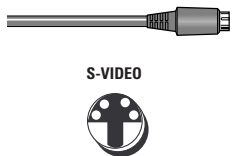

S-Video Jacks and Cables

The S-Video (separate video) jack provides better picture quality than a composite video jack (sometimes labeled VIDEO and color-coded yellow on TVs) because S-Video keeps the color (chrominance, also called chroma) part of the signal separate from the black and white (luminance) part of the picture. S-Video cables are designed to keep the color information separated. If your TV has an S-VIDEO jack, connect the DVD Recorder to the TV with an S-Video cable for a better quality picture. One S-Video cable is supplied with your DVD Recorder.

Note: Remember to connect the left and right audio cables because the S-Video cable carries only the picture signal, not the sound.

Audio/Video Jacks and Cables (RCA-type)

Audio

These jacks are used to send the audio from the disc you're playing in the DVD Recorder to the TV. The audio jacks and cables (supplied) are often color-coded (red for right audio, and white for left audio). You must connect audio cables to the AUDIO L and R jacks on the DVD Recorder and the corresponding Audio Input Jacks on the TV no matter which Video jack you connect (VIDEO; S-VIDEO; Y, Pb, Pr)

Note: If your TV has only one input for audio (mono), connect it to the left (white L/Mono) audio jack on the TV and don't connect the right audio part of the cable.

Video

The basic Video jack (usually color-coded yellow) is also referred to as composite video. Composite video doesn't keep color information separated (like S-Video), but it's better than the video quality you get from an RF coaxial cable (the type used to plug the cable feed into a TV).

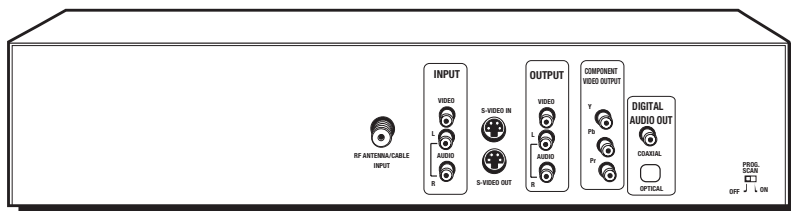
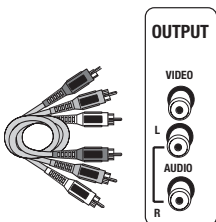

Back of the DVD Recorder

The back of your recorder might look a little overwhelming at first. This section explains what goes where and why. There are two sets of jacks on the back of your DVD Recorder — INPUT jacks and OUTPUT jacks.

Each jack is explained individually below, but the basic idea is about sending and receiving information to be played on or through your DVD Recorder and displaying that information on your TV screen. We call it Signal Flow.

INPUT The cables connected to INPUT jacks bring the signal that carries the content **INTO** the DVD Recorder, such as the cable signal (programming) from the cable company or satellite programming from a satellite receiver.

OUTPUT The cables connected to the OUTPUT jacks are sending the signal from the DVD Recorder **OUT TO** your TV so you can see it on the screen. The correct cables must be connected to the DVD Recorder's Output jacks and the corresponding Input Jacks on the TV so you can see the program on the TV. You must also tune the TV to the correct channel, called a Video Input Channel (for details, go to page 16).

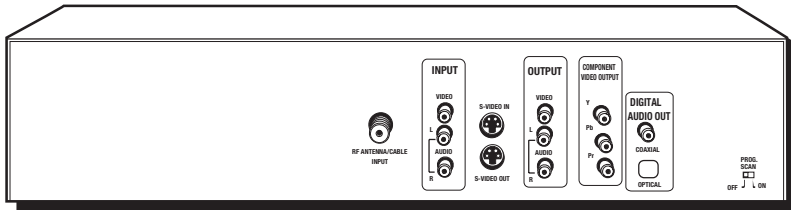

Explanation of Jacks (from left to right)

RF ANTENNA/CABLE INPUT: Connect an RF Coaxial cable from an off-air antenna, cable box, or cable outlet to this jack. The cable is sending the programming from the source to the DVD Recorder. Our connections show the cable coming from a 2Way Splitter (which enables you to watch one program on TV while you record another—not available for satellite and some cable boxes).

INPUT: These jacks receive audio and video from a compatible component, such as a satellite receiver. Another set of Input Jacks (INPUT 2) are on the front of the DVD Recorder.

VIDEO: Color coded yellow, the video cable you use with this jack provides better quality than an RF Coaxial cable but isn't as good as S-Video. Connect corresponding video cable to a compatible component such as a satellite receiver.

AUDIO L (left): Color coded white, connect corresponding audio cable to a compatible component such as a satellite receiver.

AUDIO R (right): Color coded red, connect corresponding audio cable to a compatible component such as a satellite receiver.

S-VIDEO IN: If your satellite receiver has S-VIDEO, connect the S-Video cable to this jack because it provides better picture quality than standard video (the yellow jack).

OUTPUT: These jacks send the content (audio and video) from your DVD Recorder OUT to the TV so you can see it on the TV screen and hear it through the TV's speakers. There are three video options: VIDEO, S-VIDEO, COMPONENT VIDEO OUTPUT (Y, Pb, Pr). Choose the Video Connection based on your TV's Input Jacks. For more information about jacks and cables, go to page 4. Make sure you connect the AUDIO OUTPUT jacks so you can hear the sound.

VIDEO: Color coded yellow, the video cable you use with this jack provides better quality than an RF Coaxial cable but isn't as good as S-Video.

AUDIO L (left): Color coded white, connect corresponding audio cable to TV's Audio Left Input Jack.

AUDIO R (right): Color coded red, connect corresponding audio cable to TV's Audio Right Input Jack.

S-VIDEO OUT: If your TV has S-VIDEO, connect the S-Video cable to this jack because it provides better picture quality than standard composite video (the yellow jack).

COMPONENT VIDEO OUTPUT (Y, Pb, Pr): Some high-end TVs and monitors have Component Video Input jacks. The cables that send the video signal through these Output Jacks provide the highest resolution because the video signal is divided into 3 separate parts (cables not supplied with DVD Recorder). As with VIDEO and S-VIDEO, COMPONENT VIDEO (Y, Pb, Pr) only carries the picture signal so you need to connect the audio cables so you'll hear the sound. If your TV has COMPONENT INPUT jacks, use three video grade cables to connect the DVD Recorder to these jacks on the TV to get the best picture quality.

DIGITAL AUDIO (OPTICAL and COAXIAL): Use one of these jacks to connect your DVD Recorder if you have a Dolby Digital or DTS receiver or decoder. Some receivers have either the COAXIAL or OPTICAL type of Digital Audio Input jack, and some have both. Under most conditions, optical and coaxial connections work equally well—the only difference is the type of cable you connect to the jack.

Rarely, but sometimes, coaxial digital cables (especially long ones) pick up radio frequency (RF) interference from household appliances, nearby power lines, and/or broadcast towers. If you want to use a less expensive cable, connect a coaxial cable to the COAXIAL jack if your receiver has a Coaxial input jack.



OPTICAL - connect an optical cable (SPDIF), not supplied, to the OPTICAL jack on the DVD Recorder and Digital Audio Optical Input jack on your receiver.

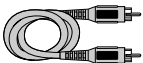

COAXIAL - connect a digital coaxial cable (not supplied) to this jack and to the Digital Audio Coaxial Input jack on your receiver. The cable is not a black coaxial cable, but an RCA-type cable.

PROG. SCAN switch – If you've connected your DVD Recorder to a TV that uses progressive scanning to display the image via the Y, Pb, Pr jacks, turn the switch to the "on" position for progressive scan playback of DVD discs. Typically, only some High Definition Televisions and high-end multimedia monitors use progressive scanning. Leave the switch in the OFF position for S-VIDEO or regular VIDEO (yellow) connections.

Note: If you turn the PROG SCAN switch on, and your TV isn't capable of progressive scanning you won't see a clear picture on the TV screen. Additionally, when playing DVDs you won't see any picture—press STOP (the main menu appears) and turn the PROG SCAN switch to the OFF position. Try playing the disc again.

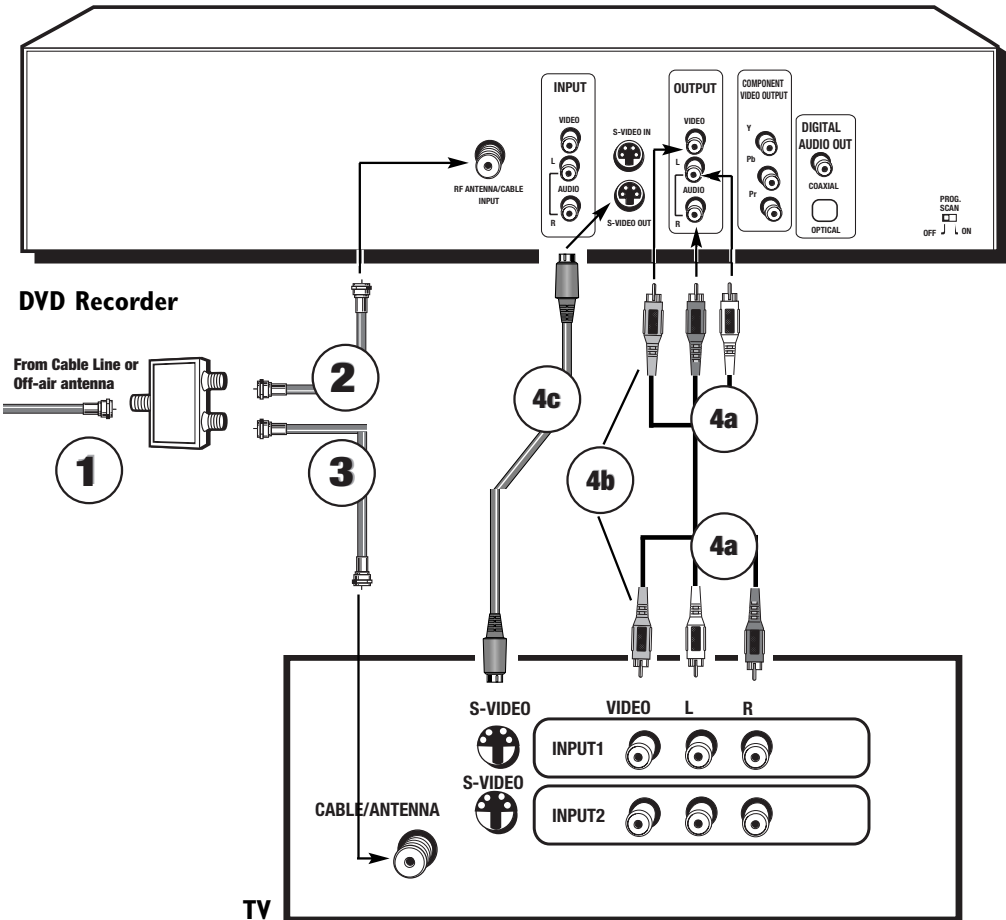

The back of your TV might look different than the one pictured here.

Details about the different kinds of cables used to connect your DVD Recorder are on page 4.

To watch one program while you record another:

Tune the TV to its Input 1 channel or Vid 1 channel
 Tune the DVD Recorder to the channel you want to record, and press RECORD.
 Use the buttons on the TV (or the TV's remote control*) to tune the TV to the channel you want to watch.

To play a disc

Tune the TV its Input 1 channel or Vid 1 channel.

If you need help finding your TV's various Video Input Channels, go to page 16.

*The remote control packed with your DVD Recorder is capable of being programmed to operate many brands and models of TVs and VCRs. For instructions, go to page 19. If the remote operates your TV, press TV and INPUT to access the Video Input Channel.

Connection: DVD Recorder + TV



**2 Way Splitter
(provided)**

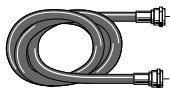

RF Coaxial cable

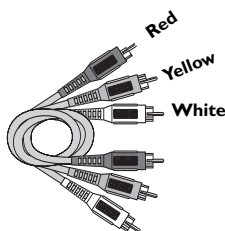

Audio video cables are usually color-coded red, white, and yellow.



If your TV has an S-Video jack, connect the S-Video cable (supplied). S-Video provides better video quality than composite video (the yellow jack) because the color part of the signal is kept separate from the black and white part of the signal.

This connection uses the 2-way splitter (provided) so you will be able to watch one program while recording another program.

1. Connect the signal (cable or antenna):

Note: Depending upon how you currently have your TV connected, you'll have to disconnect the cable from your TV's Antenna Input jack (sometimes labeled CABLE/ANTENNA) or your VCR's Input jack before you connect the cable as explained below.

Cable service: If you have cable service via a cable that comes out of the wall, connect the end of that cable to the 2 Way Splitter (provided) — connect the cable to the end of the 2 Way Splitter that only has one connector.

Note: If you have a cable box, go to page 8 for connection instructions.

Off-air antenna: If you use an off-air antenna to get TV programming, connect the antenna's RF coaxial cable to the end of the 2 Way Splitter that only has one connector.

2. Use the RF Coaxial cable that was packed with your DVD Recorder, and connect one end to the 2 Way Splitter—connect the cable to the end that has two connectors (it doesn't matter which of the two connectors you use). Connect the other end to the RF ANTENNA/CABLE INPUT jack on the back of the DVD Recorder.
3. Connect another RF Coaxial cable (not supplied) to the other connector that's available on the 2 Way Splitter. Connect the other end of this RF Coaxial cable to the TV's Antenna Input jack (sometimes labeled CABLE/ANTENNA).

Connect the DVD Recorder to the TV

4. You need to connect cables to the DVD Recorder's OUTPUT jacks to the TV's INPUT jacks in order to see the content from the DVD Recorder.

- 4a. Connect the audio cables.

A set of audio/video cables was packed with your DVD Recorder. Connect the audio cables to the OUTPUT AUDIO L (left – white) and R (right – red) jacks on the back of your DVD Recorder, and to the corresponding Audio Input jacks on your TV (sometimes labeled AUDIO IN L and R).

- 4b. Connect the video cable. The cables you use for the video determine the quality of the picture you'll see on your TV when you're playing DVDs. For more information about cables and signal quality, go to page 56. Connect the video cable (yellow) to the OUTPUT VIDEO jack on the back of your DVD Recorder, and to the Video Input jack on your TV (sometimes labeled VIDEO IN).

- 4c. If your TV has an S-Video jack, use the S-Video cable (supplied). Connect one end of the S-Video cable (supplied) to the S-VIDEO jack on the back of the TV and the other end to the S-VIDEO OUT jack on the back of the DVD Recorder.

COMPONENT OUT - Y, Pb, Pr (not shown) If your TV has Component Input jacks (Y, Pb, Pr), you can achieve even greater picture quality by connecting the DVD Recorder to the TV using these jacks (COMPONENT VIDEO OUTPUT, Y, Pb, Pr on the DVD Recorder). Component Video Cables not supplied. For more explanation, go to page 4.

Note: If your TV is capable of progressive scan, connect the DVD Recorder to the TV using the COMPONENT VIDEO OUTPUT jacks, and slide the PROG SCAN switch to the ON position to see DVD titles (movies) in progressive scan format. If you need more explanation, go to page 5.

5. Attach the AC power cord to the unit.
6. Insert the other end of the AC power cord into an AC outlet (or power strip).

Go to page 13

The back of your TV and/or Cable Box might look different than the ones pictured here.

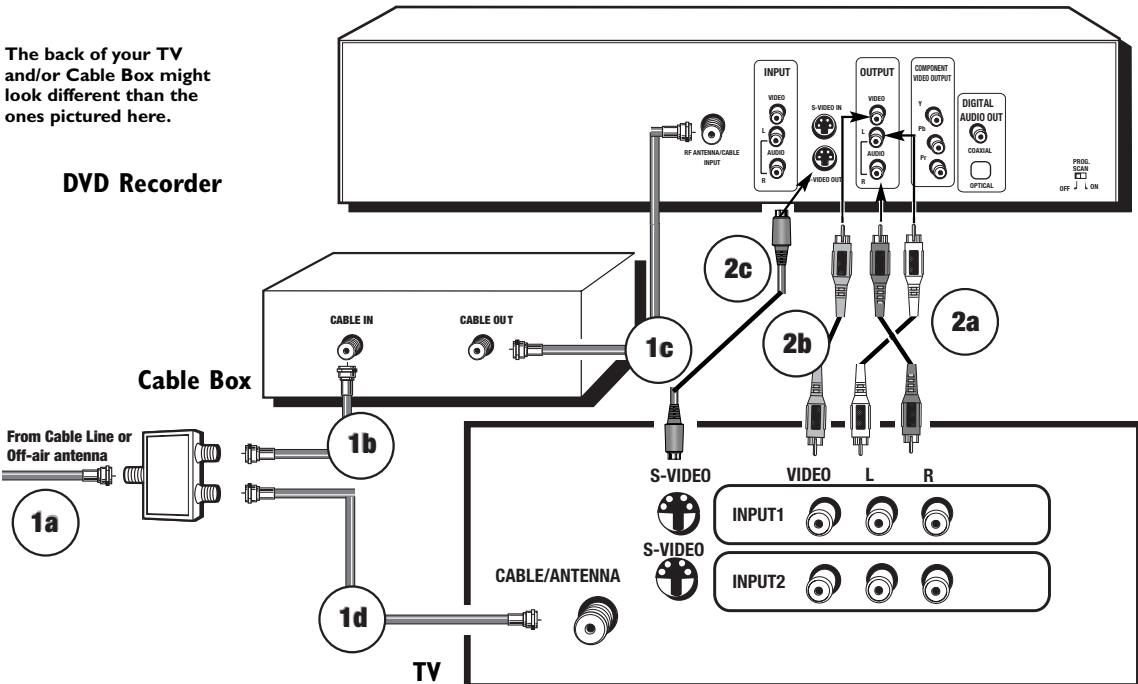

Notes about cable boxes:

If you have questions about using a cable box with the DVD Recorder, consult your cable company. RCA can only provide general instructions because cable service and cable boxes differ in various areas. This connection only shows a basic RF Coaxial Cable connection, your cable box may have Audio Video or S-Video jacks.

You must view premium cable channels through the DVD Recorder if you use this connection because the only channels being sent to the TV via the 2 Way Splitter are standard cable channels.

If you have a digital cable box, you can't split the cable signal as shown without purchasing special equipment—the 2 Way Splitter packed with the DVD Recorder is only for regular, analog cable boxes.

If you connect your components as described, you must access different Video Input Channels on your TV to see programming. If you don't know how to access Video Input Channels on your TV, go to page 16 for help. A general explanation, based on the connection shown above, follows:

To watch one program while you record another:

- Tune the TV to its Input 1 channel or Vid 1 channel.
- Tune the DVD Recorder to the cable box channel (usually channel 2, 3, or 4).
- Use the channel buttons on the cable box to tune to the channel you want to record. Press the RECORD button on the DVD Recorder.
- Use the buttons on the TV (or the TV's remote control*) to tune the TV to the channel you want to watch.

To play a disc

- Tune the TV to its Input 1 channel or Vid 1 channel.

If you need help finding your TV's various Video Input Channels, go to page 16.

*The remote control packed with your DVD Recorder is capable of being programmed to operate many brands and models of TVs. For instructions, go to page 19. If the remote operates your TV, press TV and INPUT to access the Video Input Channel.

Connection: DVD Recorder + TV + Basic Cable Box



**2 Way Splitter
(provided)**



RF Coaxial cable

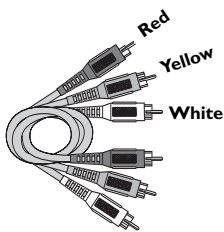

Audio video cables are usually color-coded red, white, and yellow. Red= right audio; White = left audio; Yellow = video.



If your TV has an S-Video jack, connect the S-Video cable (supplied). S-Video provides better video quality than composite video (the yellow jack) because the color part of the signal is kept separate from the black and white part of the signal.

1. Connect the 2 Way Splitter (provided) to split the cable signal

Note: Before you connect the DVD Recorder, you'll need to disconnect some of the cables first in order to re-connect them.

1a. Disconnect the RF Coaxial cable that originates from the cable signal coming into your house, and goes to the cable box. Connect this RF Coaxial cable to the 2 Way Splitter that was packed with your DVD Recorder — connect the cable to the end of the 2 Way Splitter that has only one connector.

Note: If you have a digital cable box, you can't use the 2 way splitter provided.

1b. Use the RF Coaxial cable that was packed with your DVD Recorder, and connect one end to the 2 Way Splitter — connect the cable to the end that has two connectors (it doesn't matter which of the two connectors you use). Connect the other end of this cable to the Cable Signal Input jack (sometimes labeled CABLE IN) on the cable box.

1c. Connect another RF Coaxial cable (not provided) to the cable box's TV Output Jack (sometimes labeled CABLE OUT); and connect the other end to the RF ANTENNA/CABLE INPUT jack on the back of the DVD Recorder.

1d. Connect another RF Coaxial cable (not provided) to the other connector that's available on the 2 Way Splitter. Connect the other end of that cable to your TV's Antenna Input jack (sometimes labeled CABLE/ANTENNA).

For more information about the other Input jacks on the back of the DVD Recorder, go to page 5.

2. Connect the DVD Recorder to the TV

You need to connect cables to the DVD Recorder's OUTPUT jacks to the TV's INPUT jacks in order to see the content from the DVD Recorder (whether it's a TV program or a disc you're playing).

2a. Connect the audio cables.

A set of audio/video cables was packed with your DVD Recorder. Connect the audio cables to the OUTPUT AUDIO L (left – white) and R (right – red) jacks on the back of your DVD Recorder, and to the corresponding Audio Input jacks on your TV (sometimes labeled AUDIO IN L and R).

2b. Connect the video cable. The cables you use for the video determine the quality of the picture you'll see on your TV when you're playing DVDs. For more information about cables and signal quality, go to page 4.

Connect the video cable (yellow) to the OUTPUT VIDEO jack on the back of your DVD Recorder, and to the Video Input jack on your TV (sometimes labeled VIDEO IN)

2c. S-VIDEO If your TV has an S-VIDEO jack, connect one end of the S-Video cable (supplied) to the S-VIDEO jack on the back of the TV and the other end to the S-VIDEO OUT jack on the back of the DVD Recorder.

COMPONENT OUT Y, Pb, Pr (not shown) If your TV has Component Input Jacks (Y, Pb, Pr), you can achieve even greater picture quality by connecting the DVD Recorder to the TV using these jacks (COMPONENT VIDEO OUTPUT, Y, Pb, Pr on the DVD Recorder). For more explanation, go to page 4. Component Video cables not supplied with the DVD Recorder.

Note: If your TV is capable of progressive scan, connect the DVD Recorder to the TV using the COMPONENT VIDEO OUTPUT jacks, and slide the PROG SCAN switch to the ON position to see DVD titles (movies) in progressive scan format. If you need more explanation, go to page 5.

3. Attach the AC power cord to the unit.

4. Insert the other end of the AC power cord into an AC outlet (or power strip).

Go to page 13

Notes: This connection enables you to watch one channel while you record another channel by splitting the cable signal. If your cable box is necessary for premium channels, you won't be able to access them when watching TV directly (i.e., without going through the DVD Recorder by tuning the TV to its Video Input Channel).

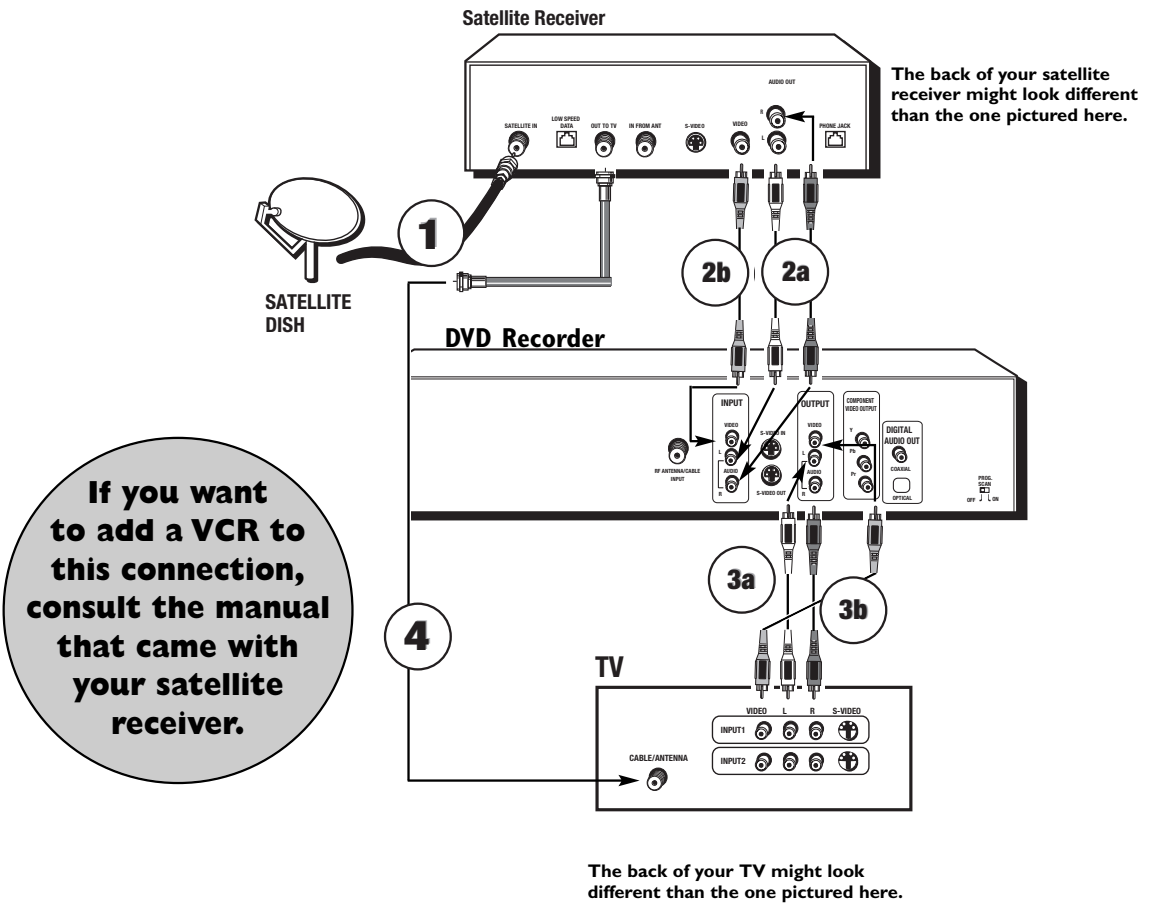

Details about the different kinds of cables used to connect your DVD Recorder are on page 4.

To watch TV (satellite programming) with the DVD Recorder turned on.

- Tune the TV to its Input I channel or Vid I channel
- Tune the DVD Recorder to the INPUT I channel (press the INPUT button on the remote).
- Tune the satellite receiver to the channel you want to watch.

To watch TV (satellite programming) with the DVD Recorder turned off.

- Tune the TV to its CABLE/ANTENNA INPUT channel (usually channel 2, 3, or 4).
- Tune the satellite receiver to the channel you want to watch.

To play a disc:

- Tune the TV to Input I channel or Vid I channel.

Connection: DVD Recorder + TV + Satellite Receiver



RF Coaxial cable

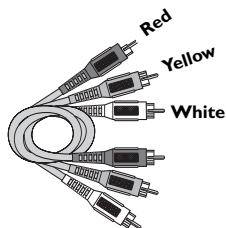

Audio video cables are usually color-coded red, white, and yellow. Red = right audio; White = left audio; Yellow = video.

The following instructions enable you to record the programs from your satellite receiver. Because the jack configuration and labels vary on different satellite receivers and televisions, the steps provided are general guidelines. Consult your Satellite Receiver and/or Television User's Guides for additional information. If you have cable TV service AND satellite TV, you can connect the cable signal to the DVD Recorder's RF ANTENNA/CABLE INPUT jack.

1. Satellite signal: Leave the cable in place that comes from the satellite dish and goes to the satellite receiver.

2. Connect the satellite receiver to the DVD Recorder

2a. Connect audio cables (red and white) to the satellite receiver's output jacks [sometimes labeled Audio Left (white) and Audio Right (red)]. Connect the other ends of these cables to the corresponding INPUT AUDIO L and AUDIO R jacks on the back of the DVD Recorder.

2b. Connect the video cable (yellow) to the Video Output jack on the satellite receiver (sometimes labeled VIDEO) to the INPUT VIDEO jack on the back of the DVD Recorder.

If your satellite receiver has an S-VIDEO jack, connect an S-Video cable to that jack and to the S-VIDEO IN jack on the DVD Recorder for increased picture quality (not shown in connection diagram).

Note: If your satellite receiver doesn't have a Video Output jack (yellow), connect an RF coaxial cable to the satellite receiver's OUT TO TV jack, and to the DVD Recorder's RF ANTENNA/CABLE INPUT jack.

3. Connect the DVD Recorder to the TV

You need to connect cables to the DVD Recorder's OUTPUT jacks to the TV's INPUT jacks in order to see the content from the DVD Recorder (whether it's a satellite program or a disc you're playing).

3a. Connect the audio cables.

A set of audio/video cables was packed with your DVD Recorder. Connect the audio cables to the OUTPUT AUDIO L (left – white) and R (right – red) jacks on the back of your DVD Recorder, and to the corresponding Audio Input jacks on your TV (sometimes labeled AUDIO IN L and R).

3b. Connect the video cable. The cables you use for the video determine the quality of the picture you'll see on your TV when you're playing DVDs. For more information about cables and signal quality, go to page 4.

Connect the video cable (yellow) to the OUTPUT VIDEO jack on the back of your DVD Recorder, and to the Video Input jack on your TV (sometimes labeled VIDEO IN)

S-VIDEO (not shown) If your TV has an S-VIDEO jack, connect one end of the S-Video cable (provided) to the S-VIDEO jack on the back of the TV and the other end to the S-VIDEO OUT jack on the back of the DVD Recorder.

COMPONENT OUT (Y, Pb, Pr) not shown If your TV has Component Input Jacks (Y, Pb, Pr), you can achieve even greater picture quality by connecting the DVD Recorder to the TV using these jacks (COMPONENT VIDEO OUTPUT, Y, Pb, Pr on the DVD Recorder). For more explanation, go to page 4.

Note: If your TV is capable of progressive scan, connect the DVD Recorder to the TV using the COMPONENT VIDEO OUTPUT jacks, and slide the PROG SCAN switch to the ON position to see DVD titles (movies) in progressive scan format. If you need more explanation, go to page 5.

4. Connect the satellite receiver to the TV

Connect an RF coaxial cable to the OUT TO TV jack on the satellite receiver, and to the Cable/Antenna input jack on the TV (sometimes labeled CABLE/ANTENNA)

5. Attach the AC power cord to the unit. Insert the other end AC power cord into an AC outlet (or power strip).

If you want to connect a VCR to the satellite receiver and the TV, connect the RF Coaxial cable in step 4 to the VCR's Cable/Antenna Input jack. Connect another RF Coaxial cable to the VCR's OUT TO TV jack, and to the TV's CABLE/ANTENNA INPUT jack. For more information, consult the manuals that came with these products.

Go to page 13

Important

You can't use the 2 Way Splitter that came with the DVD Recorder to split the satellite signal because it won't read digital signals properly. Therefore, you can't record one program and watch a different program at the same time. Additionally, this connection scenario illustrates a basic connection—you can achieve better video quality by connecting the components with S-Video or Component Video options, depending upon the cables you have and the jacks available on your components. See page 4 for more information about jacks and cables.

Consult the manual that came with your receiver to connect it properly.

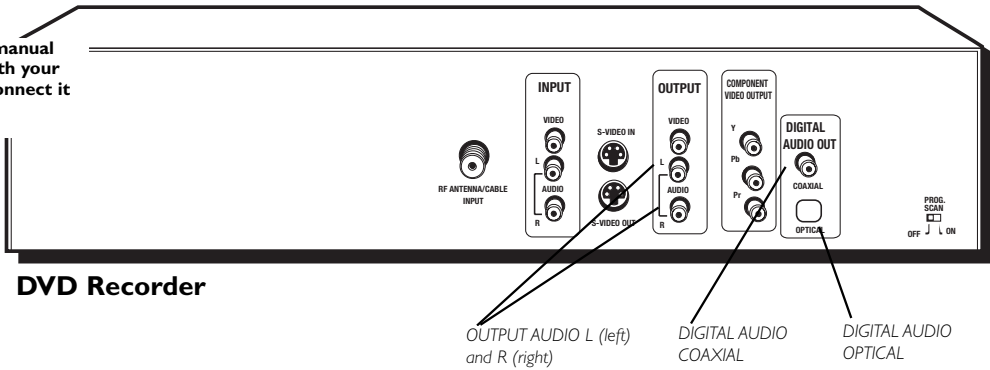

Advanced Audio Connection Information

Both Dolby Digital® and DTS® are audio formats used to record 5.1-channel audio signals onto the digital track of film (while the film is being made). Both of these formats provide up to six separate channels: left, right, center, left rear, right rear, and common subwoofer. The disc will play 5.1-channel sound only if you've connected a DTS or Dolby Digital receiver or decoder, and if the disc is encoded in the Dolby Digital or DTS format.

Please Read This Before Using the DIGITAL AUDIO Jacks!

This unit's digital output jacks are designed for a connection to a Dolby Digital or DTS receiver or decoder. Older digital equipment may not be compatible with the Dolby Digital bitstream. Such a connection can create a high level of noise that may be harmful to your ears, and could damage headphones or speakers. It is important to choose the correct Digital Output setting in the System Options menu, especially when you use either of the DIGITAL AUDIO OUT jacks. For more information, go to page 44.

Connecting your DVD Recorder to an audio/video receiver

You'll need to consult instructions that came with your audio video receiver in order to connect it properly. The information below provides general guidelines for the DVD Recorder's Audio Output Jacks.

For a basic audio connection, connect the left and right audio cables to your audio/video receiver and to the OUTPUT AUDIO L (left – white) and R (right – red) jacks on the back of your DVD Recorder.

If you have a Dolby Digital or DTS receiver, use one of the DIGITAL AUDIO OUT jacks to connect the receiver to the DVD Recorder (cables not supplied with DVD Recorder). You must also adjust the **Digital Output** setting (go to page 44 for information).

Notes:

The DIGITAL AUDIO OUTPUT jack has two options: OPTICAL and COAXIAL. Some Dolby Digital receivers have one type of Digital Audio Input jack, and some have both. Under most conditions, optical and coaxial connections work equally well — the only difference is the type of cable you connect to the jack.

If you want to use a less expensive cable, connect a digital coaxial cable (not supplied) to the COAXIAL jack. Rarely, but sometimes, coaxial cables — especially long ones, pick up radio frequency (RF) interference from household appliances, nearby power lines, and/or broadcast towers.

If you would rather use the OPTICAL jack, connect an optical digital cable (not supplied) to the DVD Recorder and to the corresponding digital optical input jack on the receiver.

Remove the protective cover that's in the DIGITAL AUDIO OPTICAL jack before connecting cables.

Install Batteries in the Remote

1. Remove the battery compartment cover on the back of the remote.
2. Insert new batteries. Match the polarities (+ and -) on the batteries with the diagram on the remote.
3. Put the battery compartment cover back on the remote.

Important Battery Information

- If you're not going to use the remote for a month or more, be sure to remove the batteries because they can leak and cause damage.
- Dispose of batteries in the proper manner, according to federal, state, and local regulations.
- Any battery may leak electrolyte if mixed with a different battery type, if inserted incorrectly, if all batteries are not replaced at the same time, if disposed of in fire, or if an attempt is made to charge a battery not intended to be recharged.
- Discard leaky batteries immediately. Leaking batteries can cause skin burns or other personal injury.

Point the Remote in the Right Direction and Put it in DVD Mode

When you want the remote to operate the DVD Recorder, point the remote at the DVD Recorder, not the TV. The remote has to be pointed in the correct direction and toward the correct component in order for the remote control's signal to communicate with the sensor on the component. Make sure there is a clear path between the remote control and the component you want to operate, so the signal isn't blocked.

Make sure the remote is in DVD mode — press the DVD button.

Turn on the TV and DVD Recorder

1. Turn on the DVD Recorder—press the DVD button on the remote.
2. Turn on the TV and tune it to the correct Video Input Channel—if you have an RCA, GE, or Proscan TV, press the TV button on the remote and then press the INPUT button on the remote (the TV turns on and tunes to the correct Video Input Channel).
If you have another brand of TV, turn on the TV and tune the TV to the correct Video Input Channel (if you don't know how to access the Video Input Channel on your TV, go to page 16 for help).

Note: You can program your remote to operate most brands of remote controllable TVs. Instructions are on page 19.

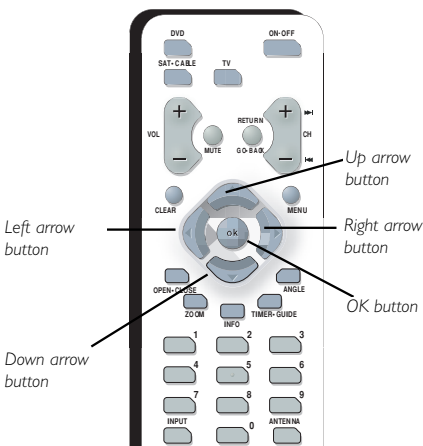

Use the arrow buttons on the remote to move through on-screen menus and highlight different options. Press the OK button to select a menu item that is highlighted.

Complete the Interactive Setup

The next few pages step you through the series of screens that will appear the first time you turn on your DVD Recorder.

Use the remote control to follow the on-screen instructions. The arrow buttons move the on-screen highlight in the corresponding directions on the screen (up, down, left, right).

Press the OK button to select a highlighted item.

Notes:

You can access the setup screens from the main menu. If you move, get a different program provider for TV shows, or change your connections, you'll need to complete the Interactive Setup again.

If you don't see the Language selection screen (below) the first time you turn on the DVD Recorder, make sure you've tuned your TV to the Video Input Channel that corresponds to the way you've connected the TV to the DVD Recorder. If you need help, go to page 16.

1) Select on-screen menu language

Make sure the remote is in DVD mode (press the DVD button). If you want the on-screen menus to appear in *English*, press the OK button on the remote control. If you prefer another language, press the arrow down button until that language is highlighted. Press OK to select the language. Next, the connection screen appears.

Note: If you don't see the Language selection screen the first time you turn on the DVD Recorder, make sure you've tuned your TV to the Video Input Channel that corresponds to the way you've connected the TV to the DVD Recorder. If you need help, go to page 16.

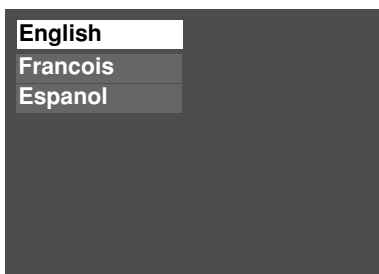

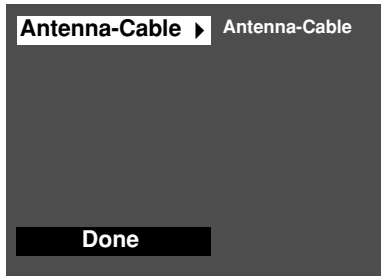

2) Select the Signal that's connected to the RF ANTENNA/CABLE INPUT jack

Completing this information lets the DVD Recorder know what program signals are being sent to it. Choose the type of signal that is connected to the RF ANTENNA/CABLE INPUT jack. Press the right arrow button to access the choices:

Antenna-Cable (cable without a cable box)

Antenna Only (no cable service, just off-air antenna)

Cable Receiver (cable service with a cable box)

Note: If the DVD Recorder doesn't start searching for channels after you've selected the type of signal connected to the RF ANTENNA/CABLE INPUT jack, press the down arrow button to highlight **Done** and press **OK**.

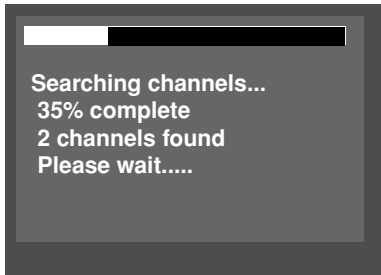

3) Channel Search

The DVD Recorder automatically scans the signal coming through the cable connected to the RF ANTENNA/CABLE INPUT jack and prepares the channel list. The channel list determines what channels appear when you press the channel up and down buttons.

A progress indicator appears on the TV screen. When the Channel Search reaches 100%, press **OK** (the Channel List appears). If the Channel List doesn't appear, check the RF ANTENNA/CABLE INPUT jack to make sure the cable is connected properly.

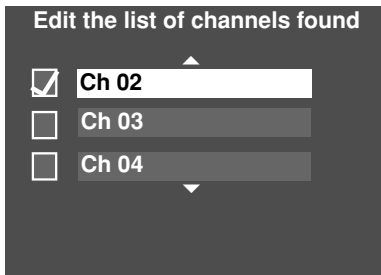

4) Channel List

The Channel List contains the channels you tune to when you press the **CH+** and **CH-** (channel up and channel down) buttons on the remote control. From the Channel List screen, you can delete channels you rarely watch. You'll still be able to tune to the "deleted" channels directly by using the number buttons on the remote control, but the DVD Recorder won't tune to a channel you delete when you press the **CH+/CH-** buttons on the remote control.

Press the down arrow button to scroll through the channels, or press the **CH-** button to scroll a screen at a time. A checkmark in the box next to the channel means it has been stored in the channel list. Follow the on-screen instructions to delete a channel in the list, or add one that isn't in the list. You can also label channels by pressing the **INFO** button.

To skip editing the channel list, press the right arrow button.

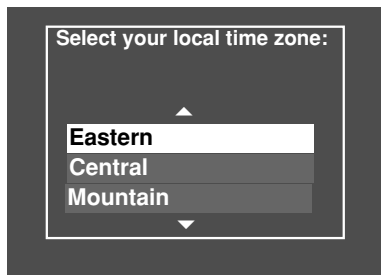

5) Time Zone

Use the down arrow button to highlight your time zone, and press **OK** (the Daylight Savings Time screen appears).

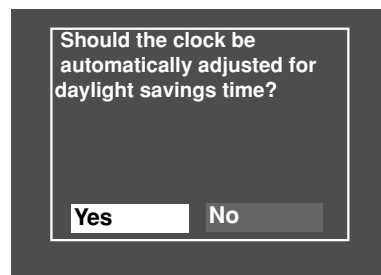

6) Daylight Savings Time

If you live in an area that recognizes Daylight Savings Time, press **OK** (the DVD Recorder's internal clock will automatically advance the time by 1 hour in the spring and set the clock back by 1 hour in the fall).

If you live in an area that doesn't use Daylight Savings Time, press the right arrow button to highlight **No**, and press **OK**.

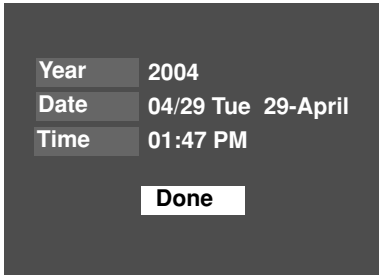

7) Time and Date

Your DVD Recorder has an automatic clock, but it may take awhile for the Recorder to find the correct channel for the clock. Therefore, you might want to set up the clock manually here.

Use the number buttons on the remote to enter *Year*, *Date*, and *Time*. To change the AM/PM setting when you're entering the *Time*, press the right arrow button.

Notes:

If this screen doesn't appear, you can set the time later from the main menu— with the remote in DVD mode, press MENU, select Setup, select Installation, select Clock Setup and follow the on-screen instructions.

The DVD Recorder is equipped with a clock that automatically keeps the time accurate. If you have any problem with the time being accurate, simply turn off the AutoClock option (page 44). Access the main menu, choose System Options, and then AutoClock. Follow the instructions to disable it, and set the time manually via the Clock Setup menu option that you access via the Setup/Installation menu.



Watch TV

When the set-up procedure is complete, the main menu appears with the *Watch TV* menu highlighted. To watch TV, just press the OK button on the remote.

What to Expect

Turn on the DVD Recorder to Watch TV

In order to use the features of the DVD Recorder (i.e., the channel banner that provides programming information), you'll have to get used to turning on your DVD Recorder to watch TV.

You also need to tune the TV to the Video Input Channel — instead of changing channels with the TV's channel up and channel down buttons, you change channels via the DVD Recorder's channel up and down buttons (or number buttons) and the TV stays on the Video Input Channel that corresponds to the Input Jacks on the TV you used to connect the TV to the DVD Recorder. If you need help finding the TV's Video Input Channel, go to page 16.

The Main Menu Appears

The main menu appears whenever you turn on the DVD Recorder. To watch TV, press the OK button when the *Watch TV* menu is highlighted. When you change channels, the channel banner appears to give you programming information that is available (for more information, go to page 24)

Changing Channels

You might notice a slight delay when you're changing channels because the signal goes to the DVD Recorder and is then sent out to the TV.

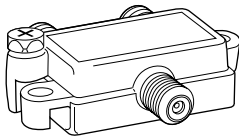

In order to watch one channel while you record another, you must connect the 2 Way Splitter correctly and change the TV to the channel you want to watch while the DVD Recorder stays on the channel you want to record. Operation with cable boxes varies. Not applicable with satellite receivers.

Recording one channel and watching another channel at the same time (not available with satellite connection and some cable boxes)

A 2 Way Splitter is packed with this product. Connected properly, this splitter enables you to watch one program while you record another. The connections provided show this 2 Way Splitter because you must use it if you want to record a program onto a DVD disc and watch a different program that is being broadcast on TV at the same time.

When you're recording one program and watching a different program, you can't change channels via the DVD Recorder. You must change the channel on the TV (using the TV's remote control; the channel buttons on the TV; or using the remote packed with the DVD Recorder* provided you program the remote to operate the TV and put the remote in TV mode by pressing the TV button).

Notes:

If you have a cable box, you might not be able to record premium program stations to the DVD Recorder when using the 2 way splitter. Consult your cable company and/or cable box manual for help.

*If you have a **digital cable box**, you must purchase a special digital splitter because the one provided is for regular, analog cable boxes only. Also, the 2-way splitter provided isn't compatible with digital satellite receivers.*

**The remote control packed with your DVD Recorder is capable of being programmed to operate many brands and models of TVs and VCRs. For instructions, go to page 19. If the remote operates your TV, press TV and INPUT to access the Video Input Channel.*

Chapter I: Connections and Setup

How to find your TV's Video Input Channel

In order to see what's playing on your DVD Recorder, you need to tune the TV to the Video Input Channel that corresponds to the Input Jacks on your TV that you used to connect the DVD Recorder to the TV. The Video Input Channel(s) varies for different brands and different models of TVs.

RCA, GE, and Proscan TVs

If your brand of TV is RCA, GE, or Proscan, the remote control packed with your DVD Recorder will most likely access the TV's Video Input Channel— with the DVD Recorder turned on, press the TV button, and then press INPUT until you see the DVD Recorder's menu on your TV screen.

Other Brands of TVs

Since access to a TV's Video Input Channel varies from one manufacturer to the next, it's difficult to provide specific instructions for your particular brand. However, a list of suggestions is provided below.

- Consult the Instruction Manual that came with your TV.
- If you can't find the information in the manual, or can't find the manual, review the following list.
 - There might be a button on the TV's remote control that accesses the Video Input Channel (see table below for examples).
 - You might select the Video Input Channel from the TV's menu system.
 - You might tune to it by pressing a specific channel number (see table below)
 - Press the Channel up and/or down buttons on the TV's remote control (sometimes the Video Input Channel is stored in your TV's channel list).

Video Input Channel Variations

Button/Switch on the TV	Button on the TV remote		Channel Number	
VIDEO	VID I	S-VID	00	93
SIGNAL	LINE	INPUT	90	VID 1
VID 1	VID	SOURCE	91	VID 2
VID 2	VIDEO	AUX	92	INPUT

Next Steps

This chapter is dedicated to connecting your DVD Recorder. Choose what you want to do next, and go to the appropriate chapter for instructions.

Chapter 2: The Remote Control (page 17)

A description of each button is in Chapter 2. Additionally, the universal remote control can be programmed to operate a TV and satellite receiver or cable box. Go to page 19 for instructions.

Chapter 3: Using the DVD Recorder's Features (page 23)

This chapter tells you how to record and playback programs and how to use the Disc Library.

Chapter 4: Playing Discs (page 29)

If you're ready to pop in a DVD (or a CD), this chapter explains how different discs function in the DVD Recorder and describes the features you can use with different types of discs.

Chapter 5: The DVD Recorder's Menu System (page 39)

Since this product is multi-functional, there are many on-screen menus to control settings and access features. Chapter 5 describes the menus and why you would want to use them.

Chapter 6: Additional Information (page 47)

If you're having trouble, go to Chapter 6. It includes troubleshooting information, the product's warranty, accessories you might want to purchase, and an explanation of the buttons and controls on the front of the DVD Recorder.

Chapter 2

The Remote Control

- **Explanation of the buttons**
- **Find out if the remote can operate your TV**
- **Programming the remote to operate your TV**
- **Programming the remote to operate other components**

Graphics contained within this User's Guide are for representation only. Some of the menu screens, buttons, and display messages might be different in your product than they appear in this book. The on-screen help text provides the most current operational information.

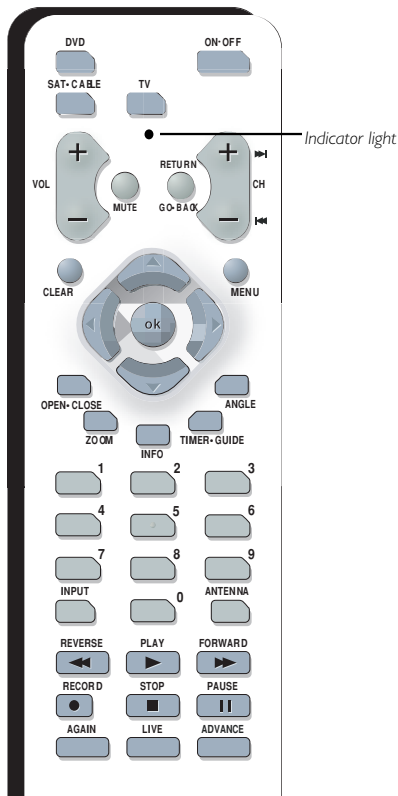

The Universal Remote Control that came with your DVD Recorder operates most RCA, GE, and Proscan branded components.

Additionally, the remote is capable of being programmed to operate many other brands and models of TVs, satellite receivers, or cable boxes.

Explanation of Buttons

You can use this remote to operate the DVD Recorder, and to access the features available. The remote is also designed to operate most RCA, GE, and Proscan components (TVs and satellite receivers). If you have another brand, you can program the remote control to operate those components (go to page 19 for instructions).

The descriptions that follow describe how each button works when operating the DVD Recorder. Many buttons will perform different functions depending upon the type of disc and menu functions of the disc.

Indicator light Used to indicate status of remote control when programming it to operate other components. Also, indicates when batteries are low by flickering when you press a button on the remote.

0-9 (Number buttons) Use the number buttons to input information such as chapter numbers, track numbers, to make selections on some menu screens, and/or to change channels.

Arrow buttons (up, down, left, right) Use the arrow buttons to highlight options that appear on the screen (the arrow buttons move the highlight in the corresponding directions — up arrow moves the highlight up; left arrow moves the highlight left, etc.).

ADVANCE When playing a disc, moves forward approximately 30 seconds. Not applicable for VCDs or mp3 files.

AGAIN Accesses the Scene Again™ feature—replays the last several seconds (approximately 10) of the DVD disc you're playing. Not applicable for VCDs or mp3 files.

ANGLE Accesses various camera angles that might have been added to a pre-recorded disc when it was created. Not available on all discs.

ANTENNA In SAT•CABLE mode, functions as a Satellite/Receiver button for RCA satellite receivers.

CH + Advances to the next chapter or track when you're playing discs. Goes to the next channel in the channel list when watching TV.

CH - When playing a disc, goes to the beginning of the current chapter or track, unless you're within the first minute of a chapter or the first 15 seconds of a track—then you'll skip to the beginning of the preceding chapter or track. When watching TV, goes to the previous channel in the channels list.

CLEAR Removes on-screen menus and displays.

DVD Turns on the DVD Recorder and puts the remote in DVD mode so it operates the DVD Recorder.

FORWARD Searches forward through the disc.

GO BACK Returns you to the previous menu. When watching TV, goes back to the previous channel.

INFO Displays the on-screen Info Display (for details about the Info Display, go to page 32.)

INPUT Accesses the Input Jacks on the Recorder (RF ANTENNA/CABLE INPUT, INPUT 1, and INPUT 2 on the front of the DVD Recorder).

LIVE When main menu is on the screen, provides quick access to watch TV.

MENU When you're not playing a disc, accesses the DVD Recorder's menu. When you're playing a disc, accesses the disc's menu, if one is available.

MUTE Lowers the volume to its minimum level. Press again to restore volume.

OPEN•CLOSE Opens and closes the disc tray.

OK When a menu is on the screen, selects the highlighted item.

ON•OFF Turns the DVD Recorder on and off.

PAUSE Pauses disc play or recording.

PLAY Begins disc play.

RECORD Records programming.

REVERSE Searches backward through the disc.

SAT•CABLE Puts the remote in Satellite or Cable mode in order for the remote to operate a satellite receiver or cable box. This remote is capable of being programmed to operate most brands of satellite receivers and cable boxes. This remote is already programmed to operate RCA, GE, and Proscan brand satellite receivers.

STOP Stops playback or recording.

TIMER/GUIDE Accesses the list of Timer Recordings (the Timer List screen).

TV Puts the remote in TV mode in order for it to operate your TV. This remote is already programmed to operate RCA, GE, and Proscan brand TVs. This remote is capable of being programmed to operate many brands of TVs.

VOL +/- If your remote is capable of operating your TV, increases and decreases the volume level.

ZOOM Enlarges the image on the screen so you can zoom in on details. To pan and scan after you've zoomed in on an image, use the arrow buttons. The Zoom feature isn't available on all discs. Typically, it works with DVD discs and CDs with JPEG files.

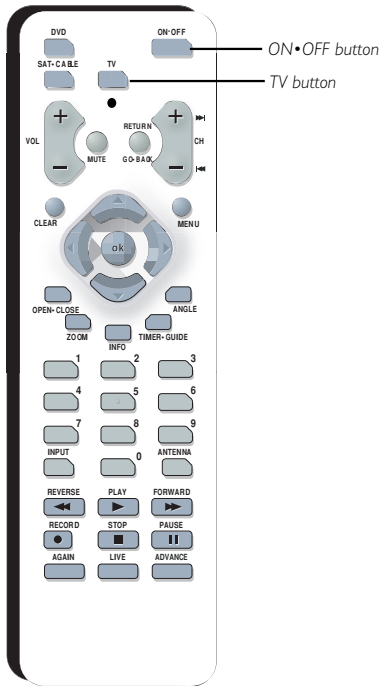

Find out if the remote can operate your TV

This remote control is designed to operate most RCA, GE, and Proscan TVs.

1. Press the TV button.
2. Press the ON•OFF button (if the TV turns on or off, this remote will operate the TV).
3. If that doesn't work, you can try programming the remote by following the instructions below.

Programming the remote to operate your TV

There are two ways to program this remote control to operate other brands of TVs: Direct Entry and Automatic Code Search (both methods are described below).

Direct Entry

1. Turn on the TV.
2. Look up the brand and code number(s) from the list on page 21.
3. Press and hold the TV button on the remote.
4. Keep holding down the TV button, and enter the first code from the code list for your brand (p. 21).
5. Release the TV button.
6. Point the remote toward the TV and press the ON•OFF button to see if the TV turns off. If it doesn't, press the TV button and then press ON•OFF. If you get no response, follow steps 1-5 again, but enter the next code from the code list for your brand of television.

Note: This remote may not be compatible with all brands and models of televisions.

Automatic Code Search

The Automatic Code Search method tests all of the codes for a specific component button. If you want to stop the automatic code search without programming any of your components, press CLEAR until the indicator on the remote turns off.

1. Turn on the TV.
2. Press and hold the TV button. While you continue pressing the TV button, press and hold the ON•OFF button until the indicator light on the remote turns on— then release both buttons.
3. Point the remote at the TV. Press and release PLAY, then wait 5 seconds or until the indicator on the remote stops flashing.

At this point the remote is searching for the correct code to program (you'll know it's found the correct code when the TV turns off, go to step 4). If, after 5 seconds, the TV doesn't turn off, press PLAY again to tell the remote to search the next set of codes.

Continue pressing PLAY until the TV turns off or you have searched through all of the codes. There are 20 total sets of codes. If the component does not turn off after pressing PLAY 20 times, then the remote can't be programmed to operate your brand of TV— you'll have to use the remote that came with your TV.

4. When the TV turns off, the remote has found the proper code. Press and release REVERSE, then wait 2 seconds. Repeat this step until the TV turns back ON.
5. To finish, press and hold STOP until the indicator on the remote turns off.

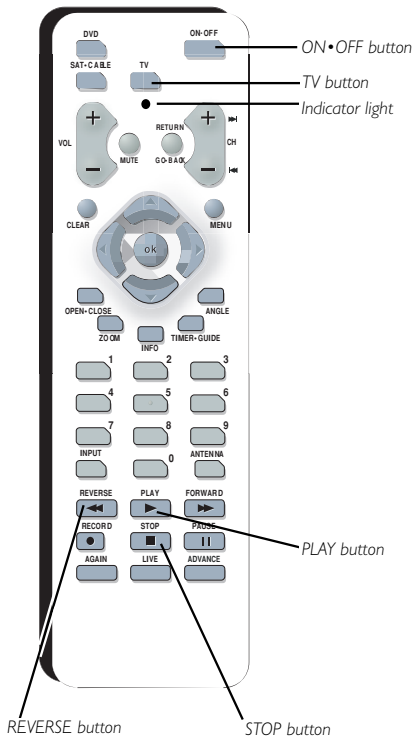

Programming the remote to operate a satellite receiver or cable box

This remote is already programmed to operate most RCA, GE, and Proscan satellite receivers — just press the SAT•CABLE button. If you have another brand or you need to program the SAT•CABLE button to operate a cable box, you need to program the remote.

There are two ways to program this remote control to operate other brands of satellite receivers or cable boxes: Direct Entry and Automatic Code Search (both methods are described below).

Direct Entry

1. Turn on the satellite receiver or cable box.
2. Look up the brand and code number(s) from the list on page 21.
3. Press and hold the SAT•CABLE button on the remote.
4. Keep holding down the SAT•CABLE button, and enter the first code from the code list for your brand.
5. Release the SAT•CABLE button.
6. Point the remote toward the satellite receiver or cable box and press the ON•OFF button to see if it turns off. If it doesn't, press the SAT•CABLE button and then press ON•OFF. If you get no response, follow steps 1-5 again, but enter the next code from the code list for your brand of satellite receiver or cable box.

Note: This remote may not be compatible with all brands and models of satellite receivers or cable boxes.

Automatic Code Search

The Automatic Code Search method searches all of the codes for a specific component button. If you want to stop the automatic code search without programming the remote, press CLEAR until the indicator on the remote turns off.

1. Turn on the satellite receiver or cable box.
2. Press and hold the SAT•CABLE button. While you continue pressing the SAT•CABLE button, press and hold the ON•OFF until the indicator light on the remote turns on— then release both buttons.
3. Point the remote at the satellite receiver or cable box. Press and release PLAY, then wait 5 seconds or until the indicator on the remote stops flashing.

At this point the remote is searching for the correct code (you'll know it's found the correct code when the satellite receiver or cable box turns off, go to step 4). If, after 5 seconds, the satellite receiver or cable box doesn't turn off, press PLAY again to tell the remote to search the next set of codes.

Continue pressing PLAY until the satellite receiver or cable box turns off or you have searched through all of the codes. When the indicator light turns off, and stays off, the remote has searched all of the codes— which means this remote can't be programmed to operate your satellite receiver or cable box. You'll have to use the remote that came with them.

4. When the satellite receiver or cable turns off, the remote has found the proper code. Press and release REVERSE, then wait 2 seconds. Repeat this step until the satellite receiver or cable box turns back ON.
5. To finish, press and hold STOP until the indicator on the remote turns off.

Using the remote to operate other components

Know the mode

Once you've programmed the remote to operate other components, you need a basic understanding of how the remote control works. The codes in the remote control that make a component act a specific way are mode dependent— if you want to change settings in your TV's menu, you must press the TV button before you press the MENU button so the remote control knows that you want to access the TV's menu system.

To summarize, to operate the DVD Recorder you must press the DVD button; to operate the TV, you must press the TV button; to operate a satellite receiver or cable box, you must press the SAT•CABLE button.

Understanding the INPUT button

Another important button is the INPUT button. The INPUT button access the programming from a specific component. We call these channels, Video Input Channels, because you are telling the component to send the video (and audio) that corresponds to the Video Input jack you used to connect the component to the DVD Recorder. For example, if you connected a satellite receiver to your DVD Recorder by using the S-VIDEO IN jack, you would need to press DVD (to put the remote in DVD mode) and then press INPUT until the S-Video Input Channel appears (if the satellite receiver is on, you'll see the program it is tuned to, and S-VID appears in the DVD Recorder's channel banner to let you know which "channel" the DVD Recorder has accessed.

Code List:TVs for TV button

Abex 1172	1177	1024	1151	1072	1072	1005	1008	Radio Shack	
Admiral 1001 1173 1211	Colortyme 1004 1006 1010	1025 1026 1027 1028 1029	Goldstar 1004 1005 1006 1012 1019 1056 1057 1058 1155 1156 1171 1172	1087 1105 1128 1171 1172 1181 1201	1073 1162 1181 1207	1006 1019 1022 1051 1079 1080 1081 1082 1125	1012 1019 1062 1068 1069 1075 1077 1183	Realistic 1000 1004 1006 1012 1038 1049 1095 1162 1171 1172	
Adventura 1174	Concerto 1004 1006	1030 1031 1032 1033		Janeil 1174	Magnavox 1004 1006 1008 1019 1062 1068 1069 1075 1076 1077 1088 1130 1131 1132 1133 1134 1183 1219 1235	Montgomery Ward 1083	Philips 1003 1004 1008 1012 1019 1062 1068 1069 1075 1076 1086 1087 1088 1089	RCA 1000 1003 1004 1004 1005 1006 1007 1019 1096 1098 1099 1100 1101 1102 1103 1129 1179 1181 1187 1188 1190 1202 1203 1215 1233	
Aiko 1016	Contec/Cony 1012 1013 1014 1038	1034 1035 1036 1037 1038 1039 1041 1042 1043 1044 1046 1047 1123 1124 1162 1171 1177 1179 1191 1208	Grundy 1038 1046 1171	JBL 1062	JCB 1002	Motorola 1003 1173	MTC 1004 1005 1006 1105	Multitech 1038	
Akai 1002	Craig 1038	1044 1046 1047 1123 1124 1162 1171 1177 1179 1191 1208	Hallmark 1004 1006	JCB 1002	Jensen 1004 1006	Motorola 1003 1173	MTC 1004 1005 1006 1105	Multitech 1038	
Alleron 1046	Crown 1038 1171	1044 1046 1047 1123 1124 1162 1171 1177 1179 1191 1208	Harvard 1038 Hitachi 1004 1006 1066 1067 1066 1067 1157 1158 1159 1182	JVC 1012 1013 1014 1054 1060 1065 1066 1067 1157 1158 1159 1182	JCB 1002	MTC 1004 1005 1006 1105	Multitech 1038	Multivision 1084	
Amtron 1038	Curtis Mathes 1000 1004 1006 1015 1105 1162 1171 1212	1044 1046 1047 1123 1124 1162 1171 1177 1179 1191 1208	Harvard 1038 Hitachi 1004 1006 1066 1067 1066 1067 1157 1158 1159 1182	Kawasho 1002 1004 1006	Majestic 1083	Multivision 1084	Multitech 1038	Multivision 1084	
Anam National 1003 1038 1192 1193 1194	Daewoo 1004 1005 1006 1016 1017 1018 1127 1171 1196	Envision 1004 1006	Hitachi 1004 1006 1066 1067 1066 1067 1157 1158 1159 1182	Kenwood 1004 1006 1019	Marants 1062	MARANTZ 1004 1006 1062 1078	NEC 1003 1004 1005 1006 1200	Pilot 1004 1171	
AOC 1004 1005 1006 1007 1175 1176 1195	Fisher 1048 1049 1051 1162 1180	1004 1006 1061 1135 1136 1137 1138 1139 1140 1141 1142 1143 1144 1145 1146 1148 1150 117 1198 1199	Hitachi 1004 1006 1066 1067 1066 1067 1157 1158 1159 1182	KENWOOD 1004 1006 1019	Marantz 1004 1006 1062 1078	MARANTZ 1004 1006 1062 1078	NEC 1003 1004 1005 1006 1200	Pioneer 1004 1006 1090 1091 1092 1179 1185	
Audiovox 1038	Fujitso 1046	1061 1135 1136 1137 1138 1139 1140 1141 1142 1143 1144 1145 1146 1148 1150 117 1198 1199	Hitachi 1004 1006 1066 1067 1066 1067 1157 1158 1159 1182	Kenwood 1004 1006 1019	Marantz 1004 1006 1062 1078	MARANTZ 1004 1006 1062 1078	NEC 1003 1004 1005 1006 1200	Pilot 1004 1171	
Belcor 1004	Funai 1038 1046	1061 1135 1136 1137 1138 1139 1140 1141 1142 1143 1144 1145 1146 1148 1150 117 1198 1199	Hitachi 1004 1006 1066 1067 1066 1067 1157 1158 1159 1182	Kenwood 1004 1006 1019	Marantz 1004 1006 1062 1078	MARANTZ 1004 1006 1062 1078	NEC 1003 1004 1005 1006 1200	Pioneer 1004 1006 1090 1091 1092 1179 1185	
Bell & Howell 1001 1083 1162	Daytron 1004 1006 1171	1061 1135 1136 1137 1138 1139 1140 1141 1142 1143 1144 1145 1146 1148 1150 117 1198 1199	Hitachi 1004 1006 1066 1067 1066 1067 1157 1158 1159 1182	Kenwood 1004 1006 1019	Memorex 1001 1006 1082 1083 1162	MARANTZ 1004 1006 1062 1078	NEC 1003 1004 1005 1006 1200	Pioneer 1004 1006 1090 1091 1092 1179 1185	
Bradford 1038	Dumont 1004 1151	1061 1135 1136 1137 1138 1139 1140 1141 1142 1143 1144 1145 1146 1148 1150 117 1198 1199	Hitachi 1004 1006 1066 1067 1066 1067 1157 1158 1159 1182	Kenwood 1004 1006 1019	Memorex 1001 1006 1082 1083 1162	MARANTZ 1004 1006 1062 1078	NEC 1003 1004 1005 1006 1200	Pioneer 1004 1006 1090 1091 1092 1179 1185	
Brokwood 1004	Electroband 1002	1061 1135 1136 1137 1138 1139 1140 1141 1142 1143 1144 1145 1146 1148 1150 117 1198 1199	Hitachi 1004 1006 1066 1067 1066 1067 1157 1158 1159 1182	Kenwood 1004 1006 1019	Memorex 1001 1006 1082 1083 1162	MARANTZ 1004 1006 1062 1078	NEC 1003 1004 1005 1006 1200	Pioneer 1004 1006 1090 1091 1092 1179 1185	
Candle 1004 1006 1008 1174	Electrohome 1003 1004 1006 1019 1020 1022	1061 1135 1136 1137 1138 1139 1140 1141 1142 1143 1144 1145 1146 1148 1150 117 1198 1199	Hitachi 1004 1006 1066 1067 1066 1067 1157 1158 1159 1182	Kenwood 1004 1006 1019	Memorex 1001 1006 1082 1083 1162	MARANTZ 1004 1006 1062 1078	NEC 1003 1004 1005 1006 1200	Pioneer 1004 1006 1090 1091 1092 1179 1185	
Celebrity 1002	Emerson 1004 1006 1012 1023	1061 1135 1136 1137 1138 1139 1140 1141 1142 1143 1144 1145 1146 1148 1150 117 1198 1199	Hitachi 1004 1006 1066 1067 1066 1067 1157 1158 1159 1182	Kenwood 1004 1006 1019	Memorex 1001 1006 1082 1083 1162	MARANTZ 1004 1006 1062 1078	NEC 1003 1004 1005 1006 1200	Pioneer 1004 1006 1090 1091 1092 1179 1185	
Centurion 1009		1061 1135 1136 1137 1138 1139 1140 1141 1142 1143 1144 1145 1146 1148 1150 117 1198 1199	Hitachi 1004 1006 1066 1067 1066 1067 1157 1158 1159 1182	Kenwood 1004 1006 1019	Memorex 1001 1006 1082 1083 1162	MARANTZ 1004 1006 1062 1078	NEC 1003 1004 1005 1006 1200	Pioneer 1004 1006 1090 1091 1092 1179 1185	
Citizen 1004 1006 1008 1016 1038 1105 1171 1174		1061 1135 1136 1137 1138 1139 1140 1141 1142 1143 1144 1145 1146 1148 1150 117 1198 1199	Hitachi 1004 1006 1066 1067 1066 1067 1157 1158 1159 1182	Kenwood 1004 1006 1019	Memorex 1001 1006 1082 1083 1162	MARANTZ 1004 1006 1062 1078	NEC 1003 1004 1005 1006 1200	Pioneer 1004 1006 1090 1091 1092 1179 1185	
		1061 1135 1136 1137 1138 1139 1140 1141 1142 1143 1144 1145 1146 1148 1150 117 1198 1199	Hitachi 1004 1006 1066 1067 1066 1067 1157 1158 1159 1182	Kenwood 1004 1006 1019	Memorex 1001 1006 1082 1083 1162	MARANTZ 1004 1006 1062 1078	NEC 1003 1004 1005 1006 1200	Pioneer 1004 1006 1090 1091 1092 1179 1185	

Chapter 2: The Remote Control

Code List

TV (cont.)

Sanyo	1205	1083	1151	5023	Signature	General
1004	1216	1105	1152	5024	5003	Instruments
1048	1218	1170	1153	5046	Sprucer	5060
1049	Soundesign	1171	1154	5053	5052	5061
1080	1004	Telecaption	1210	Magnavox	Standard	5062
1107	1006	1117	1217	5025	Components	Hitachi
1108	1008	TMK	Cable Box	Memorex	5039	5083
1162	1038	1004	SAT-CABLE	5026	5044	5084
1169	1046	1006	button	Movie Time	Starcom	Hughes Network
1180	Squareview	Toshiba	ABC	5027	5018	5077
Scotch	1189	1049	5002	NEC	5053	5090
1006	SSS	1071	5003	5005	Stargate	JVC
Scott	1004	1072	5004	NSC	5018	5082
1004	1038	1105	5006	5027	Starquest	Panasonic
1006	Starlite	1109	5053	Oak	5018	5075
1012	1038	1117	Antronix	5016	Tocom	Philips
1012	Supre-Macy	1118	5008	5029	5004	5085
1024	1174	1160	5009	Panasonic	5023	Primestar
1035	Supreme	1162	Archer	5048	Tusa	5076
1038	1002	Totevision	5008	5052	5018	Proscan
1046	Sylvania	1171	5009	Philips	TV86	5000 (SAT1), 5001 (SAT2)
Sears	1004	Universal	5010	5011	5027	RCA
1000	1006	1052	Cabletenna	5012	Unika	5000 (SAT1), 5001 (SAT2)
1004	1008	1087	5008	5013	5008	5071
1006	1019	Victor	Cableview	5015	5009	5080
1013	1062	1182	5008	5019	United Cable	5081
1014	1068	Vidtech	Colour Voice	5025	5053	Realistic
1019	1069	1004	5012	5030	Universal	5063
1046	1075	1005	5013	5031	5008	Sony
1048	1077	1006	Comtronic	5032	5009	5072
1049	1088	Viking	5014	Pioneer	5010	STS I
1051	1116	1174	Contec	5033	Viewstar	5064
1066	1161	Wards	5016	5034	5025	STS2
1071	1183	1000	Eastern	Proscan	5027	5065
1072	Symphonic	1001	5017	5000	Zenith	STS3
1109	1033	1004	GC Electronics	5001	5050	5066
1110	1038	1005	5009	RCA	5051	STS4
1162	1189	1006	GE	5007	Satellite	5067
1180	Tandy	1019	5000	5047	SAT-CABLE	Toshiba
1181	1173	1024	5001	5049	button	5068
1189	Tatung	1033	Gemini	5052	Alphastar	5073
Sharp	1003	1046	5018	Realistic	5079	Uniden
1004	Technics	1052	5019	5009	Chapparral	5069
1006	1054	1062	General	Regal	5056	5086
1012	Techwood	1068	Instrument	5022	Regency	
1012	1004	1069	5003	5035	5017	
1029	1006	1075	Hamlin	Rembrandt	Rembrandt	
1095	1054	1076	5020	5003	5003	
1111	Teknika	1083	5021	Samsung	Samsung	
1112	1004	1087	5022	5034	5034	
1113	1006	1088	5028	Scientific Atlanta	Scientific Atlanta	
1122	1054	1095	5035	5006	5006	
1171	Tokai	1119	5045	5036	5036	
1173	1004	1120	Hitachi	5037	5037	
Shogun	1005	Yamaha	5003	5038	Signal	
1004	1006	1004	Jerrold	5018	5018	
Signature	1008	1005	5003			
1001	1012	1006	5003			
1083	1013	1006	5003			
1115	1014	1019	5003			
Simpson	1016	Zenith	5003			
1008	1038	1004	5003			
Sony	1046	1004	5003			
1002	1076	1083	5003			

Chapter 3

Recording, Playback & Features

- **Watching TV**
- **Recording**
- **Playback**
- **Disc Library**

Graphics contained within this User's Guide are for representation only. Some of the menu screens, buttons, and display messages might be different in your product than they appear in this book. The on-screen help text provides the most current operational information.

Watching TV

Turn on the DVD Recorder to Watch TV

1. Turn on the TV, and tune the TV to the correct Video Input Channel (this channel corresponds to the input jacks on your TV that you used to connect the DVD Recorder to the TV).
2. Turn on the DVD Recorder (the DVD Recorder's main menu appears).
3. Since the *Watch TV* menu is already highlighted, just press the OK button on the remote (the DVD Recorder tunes to the last station you watched and a channel banner appears). To see the channel banner after it disappears from the screen, press INFO on the remote control.

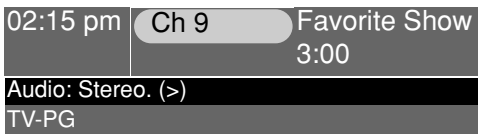

Channel Banner

The Channel Banner

While watching TV, press INFO on the remote control to see the channel banner. The information that appears in the channel banner depends upon the information sent from the broadcaster. For example, the rating and the time the program ends are not always sent by the broadcaster.



Recording Banner

Space available on disc

Recording

After you load a DVD+R or DVD+RW disc into the DVD Recorder's disc tray, there are several ways to record programming. The quickest way is to press the RECORD button while you're watching a show (the recording banner appears). You don't even need to remember to press the stop button when you're finished recording if you use the Express Recording feature in the recording banner.

Notes:

The DVD Recorder won't record copy-protected material.

Remember, if you're using a DVD+R disc you must finalize it (page 41).

Express Recording Feature

Each time you press the RECORD button on the remote the recording time increases by 30 minutes, up to the maximum limit (the status is listed on the far right side of the recording banner). The DVD Recorder will record for the amount of time you specified and then stop automatically. If you press INFO, the amount of recording time left appears. At anytime during the recording, you can extend the recording time by pressing the RECORD button.

Note: When you stop recording, the DVD Recorder takes several seconds to save information to the disc. A still frame of the recording may appear on the screen before you are returned to TV viewing.

Watching one channel while you record another channel

If you want to watch another channel while you're recording, you need to make sure you've connected the 2 Way Splitter (go to page 6 or 8 for details), and do the following:

1. Make sure the DVD Recorder and the TV are on. Tune the TV to the appropriate Video Input Channel (if you need help, go to page 16).
2. Using the DVD Recorder's channel buttons, tune to the program you want to record. Press the RECORD button.
3. If the remote that came with your DVD Recorder operates your TV, just press the TV button and use the channel up and down buttons to go to a different channel.
If the remote doesn't operate your TV, use the TV's remote control to change channels.
4. When you're finished recording, remember to turn the TV back to its Video Input Channel and watch TV through the DVD Recorder.

Notes:

This feature might work differently if you receive programming via a cable box. If you receive programming via satellite receiver, this feature isn't available—you can't record one satellite program and watch another satellite program.

The remote that came with your DVD Recorder is a programmable Universal remote that can be programmed to operate many brands and models of TVs. Go to page 19 if you want to program the remote.

When you stop recording, a delay may occur while the DVD Recorder generates information about the recording for the Disc Library.

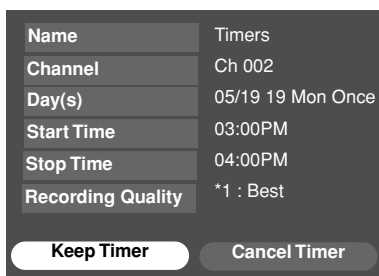
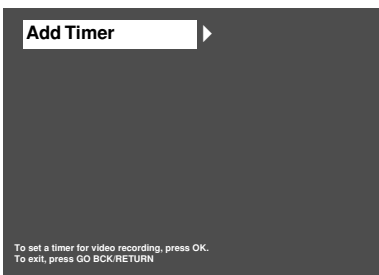
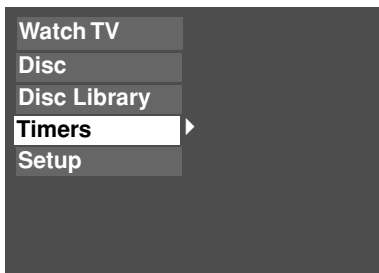

Timer Recordings

Setting up timer recordings to record programs automatically

- From the DVD Recorder's main menu, use the remote's arrow buttons to highlight *Timers*, and press the OK button.
- If necessary, highlight *Add Timer*, and press OK (the Timer Setup screen appears).
- If you want to give the Timer a name, highlight *Name* and press the INFO button (the on-screen keyboard appears — follow the on-screen instructions to name the timer). When finished entering the name, make sure you press the right arrow button to highlight *Done* and press OK (highlight moves to *Channel*).
- Highlight the *Channel* field and use the number buttons on the remote to enter the channel number, and press OK (highlight moves to *Day*).
To enter a Video Input Channel, press the right arrow button.
- Use the number buttons to enter month and day. To change the frequency (once, daily, weekly, etc.), press the right arrow button. When finished, press OK (highlight moves to *Start Time*).
- Use the number buttons to enter the time you want to start recording. Press the right arrow button to change the a.m./p.m. setting. When finished, press OK (the highlight moves to *Stop Time*).
- Use the number buttons to enter the time you want the DVD Recorder to stop recording. Press the right arrow button to change a.m./p.m. setting.
- You can change the quality of the recording by pressing the right arrow button. The better the quality, the more space the recording takes up on the disc — less recording time available (go to page 45 for more information). Press OK to confirm the quality recording setting.
- When you're finished, make sure *Keep Timer* is highlighted and press OK.

Notes: The DVD Recorder's clock must be set in order for Timer Recordings to work properly.

Using the different disc menus for recorded titles:

From the *Disc* menu, there are two separate menus to show you what has been recorded on the disc:

- Disc Title Menu*: lists the disc name and individual titles.
- Player Menu*: the disc menu (contents of recordings) as it will appear in ANOTHER DVD Player — instead of a title listing, a still picture (called a thumbnail) of each recording (title) appears on the screen with pertinent information. For multiple recordings, use the left and right arrow buttons to navigate. For more information, go to page 41.

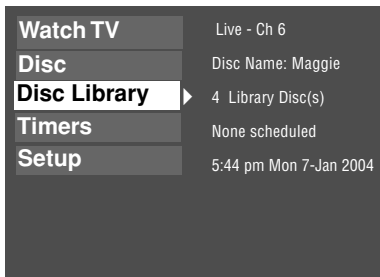

Shows you've recorded to a DVD+R or DVD+RW disc are called titles.

If you know which DVD+R or DVD+RW disc contains the program you recorded, insert the disc and select **Disc Library** to see all of the programs (titles) on the disc. If necessary, you can use the **Sort** feature to find a program.

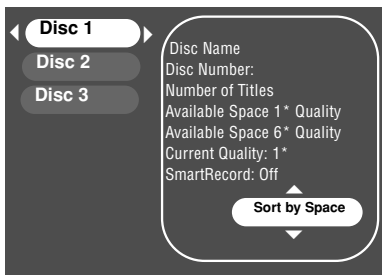

Disc Library

You can find a show you recorded to disc more quickly by using the DVD Recorder's Disc Library. Everytime you use your DVD Recorder to record a program, the DVD Recorder assigns the disc a number, and keeps track of what you've recorded and when you recorded it. The disc's library stores the following information about each disc:

- Disc Name and Number
- The number of titles (recordings) on a disc
- Available recording space available on a disc
- Name of the title (show, program, movie)
- Date the program was recorded
- Genre of the program (you may need to assign)

Editing the Disc Library's Contents

Most of the Disc Library's contents are automatically created if the information is available, but you can edit the information by using the on-screen keyboard.

1. Insert the DVD+R or DVD+RW disc into the DVD Recorder that has recorded program with the information you want to edit.
2. Highlight **Disc Library**, and press OK. If you want to edit information for one of the recorded programs, use up/down arrow buttons to highlight the program.
3. Press right arrow (the **Sort by Title** option is highlighted).
4. Press down arrow until **Assign Genre** is highlighted, and press OK (a list of genres appears).
5. Use the up/down arrow buttons to highlight a Genre and press OK. It will take about 15 seconds for the DVD Recorder to save the information to the Disc Library.

Since the Disc Library is saved in the DVD Recorder, you have a limited amount of space to keep disc contents. If the Disc Library becomes full, you'll have to delete some of the discs from the Disc Library to make room.

Finding a title (movie, program, etc) by using the Sort Feature

1. Press MENU (the main menu appears).
2. Press the down arrow button until **Disc Library** is highlighted, and press OK (a list of titles appears).
3. Press the right arrow button. Each time you press the down arrow button, the next option appears.

Sort by Title

When you press OK with **Sort by Title** highlighted, the on-screen keyboard appears. Enter the first character of the title and select **Done** (the titles starting with that letter appear, with the first in the list highlighted).

Sort by Genre

Lists contents of the disc by the Genre (you may need to assign a genre to recordings). Use the arrow buttons to highlight a Genre, and press OK (all titles that you've assigned to that Genre appear).

Sort by Date

Lists contents of the disc by the date recorded.

Other Sorting Options—Show All Discs

When you choose **Show All Discs**, additional sorting options appear:

Sort by Space: Lists the discs by the amount of recording space left.

Sort by Disc No.: Lists the discs numerically.

Sort by Disc Title: Lists discs alphabetically by title.

Show All Titles: Lists all the titles recorded.

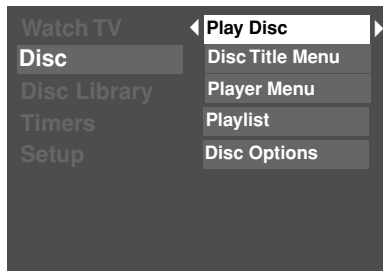
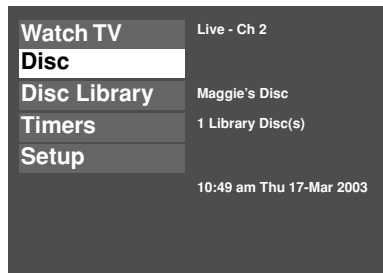

Once you've accessed the **Disc Title** menu and selected a title (recording), video of the program appears with recording details listed below it. Menu options appear on the left.



Info Display for recorded DVD Discs (DVD+RW and DVD+R)



The Edit icon



Playback

To play recordings, do the following:

1. Turn on the TV and the DVD Recorder.
2. Make sure the TV is tuned to the correct Video Input Channel (for help, go to p. 16).
3. Insert the DVD+R or DVD+RW disc you want to play.
4. Once the DVD Recorder reads the disc's contents, the main menu appears. If the main menu doesn't appear, press MENU (the main menu appears).

Notes:

If you selected *Autoplay On* in the *Disc Options* menu (page 42), the disc's contents appear automatically when you insert the disc.

If the screen is blank, you might not have your TV tuned to the correct Video Input Channel. For more information about Video Input Channels, go to page 16.

5. Use the up and down arrow buttons on the remote to highlight the *Disc* menu, and press OK (the options appear).

6. There are two ways to access your recordings within these menu options:

Play Disc: If you want to play all of the recordings on the disc (or there is only one recording), just press OK when this menu is highlighted (the first recording plays).

Disc Title Menu: Press OK when this menu option is highlighted (all of the recordings/titles on the disc appear). Use the arrow buttons to highlight the title you want to select:

- To watch the program that you've highlighted, press PLAY.
- If you want to name the program, delete it, or change the play mode, press OK (the options appear).

Rename Title: For DVD+RW discs only.

Play Title: Plays the movie, program or show.

Play Full Title: Only appears for DVD+RW discs that may have hidden chapters.

Delete Title: For DVD+RW discs only.

Clear Chapters: For DVD+RW discs only.

Note: The DVD Recorder automatically adds a chapter during recording about every 5 minutes. During playback, press INFO and use the Time Display or Chapter icon to advance through the recording.

Using the Info Display while playing DVD+R and DVD+RW discs

While playing the disc, press the INFO button on the remote (the Info Display appears). Details about the different icons appear in Chapter 4: Playing Discs. However, the edit feature includes special options for DVD+RW discs.

1. While playing a disc, press the INFO button.
2. Press the right arrow button to highlight the Edit icon , and press OK. The following choices appear (use the up/down arrow buttons to highlight a choice and press OK to select).
 - **Insert Chapter Marker** (DVD+RW discs only). When you're recording to a disc, the DVD Recorder adds a chapter marker automatically every 5 minutes. Additionally, you can insert chapter markers manually to segment different parts of the title. To insert a chapter marker, simply highlight Insert Chapter Marker during playback at the point where you want the chapter to start.
 - **Delete Chapter Marker** (DVD+RW discs only). Since the DVD Recorder automatically adds chapter markers every 5 minutes, you may want to make each chapter longer by deleting a chapter marker during playback.
 - **Hide Chapter** (DVD+RW discs only). During playback you can hide a specific chapter so it is automatically skipped. For more information, go to page 28.
 - **New Title Frame** You can change the thumbnail that appears in the *Player Menu* (described in the next section). When the video appears that you want to use to visually represent the title, press OK (the next time you access the *Player Menu*, a still image of this video will appear).
 - **Split Title** (DVD+RW discs only). You can divide one recording into smaller segments so that each title appears separately in the *Disc Title Menu*. This is a helpful feature when you record a block of programming that contains several shows and/or when you copy camcorder videocassette tapes to a disc. For examples, go to page 28.

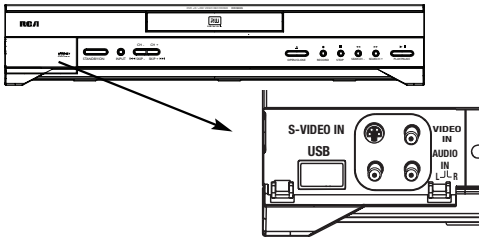

Front Input Jacks are under the door on the front of the DVD Recorder

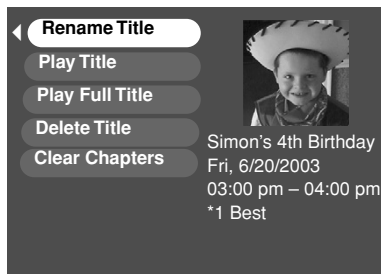

Using the Split Title Feature to Copy Camcorder Videocassette Tapes to Disc



The Split Title option lets you divide one recording into different titles. This is especially handy when you transfer videocassette tapes from camcorder recordings to disc—once you “Split the Title” you can jump from one special occasion to the next without the time consuming effort of fast forwarding through a tape.

1. Connect the VCR's Output Jacks to the DVD Recorder's Input jacks (for easy access, you can use the Front Input jacks that are underneath the door). For a connection picture using the Input jacks on the back of the DVD Recorder, go to page 56. Match the Video (yellow) and the Audio jacks (red and white) to the correct cables.
2. Turn on the VCR and the DVD Recorder
3. Insert the a DVD+RW disc into the DVD Recorder (you must use DVD+RW disc to use the Split Title feature, not a DVD+R disc).
4. Put the videocassette into the VCR (make sure it's cued to the beginning of the tape, or the place from which you want to start recording).
5. Press PLAY on the VCR and RECORD on the DVD Recorder (most videocassettes contain 2 hours of programming so you can automatically set the DVD Recorder to record for 2 hours by pressing RECORD 4 times). See Express Recording on page 24.
6. After you've finished recording, name the disc—go to the DVD Recorder main menu; highlight *Disc Title Menu* and press OK (the options appear).
7. Since *Rename Disc* is highlighted, just press OK (the keyboard appears). Use the arrow buttons and OK to rename the disc. Remember to highlight *Done* when you're finished, and press OK.
8. The disc contains one title—the entire contents of the videocassette tape. Play the disc from the beginning to determine what to name the first event you recorded (for example, Simon's 4th birthday). Name the first title by going to the *Disc Title Menu* and selecting *Rename Title*. Use the keyboard to rename the title.
9. When you get to the end of the first event on the disc—in the example above, Simon's 4th birthday—press the PAUSE button. Press INFO (the Info Display appears).
10. Press the right arrow button to highlight the Edit icon , and press OK.
11. Press the down arrow button to highlight *Split Title* or *Divide Title*—the Recorder cuts the recording at that point (you'll have to wait for a minute or so while the information is updated). Now you have two titles named Simon's 4th birthday. Start playing the second title, and rename it to fit the description of the event. Continue this sequence until you've divided the disc into as many separate titles as you want.
12. Additionally, you can easily remove any unused part of the disc. Typically, the end of videocassette tapes contain snowy, blank footage. If you copied the entire videocassette to disc, the end of the disc might have this unused content. To remove, just split this portion into a separate title, and then delete the title from the disc.

Editing Titles with the Hide Chapter Feature

As with most editing features on recorded discs, Hide Chapter is only available with DVD+RW discs. Some people use it to hide commercials or introductions to programs. You have to Insert a Chapter Marker at the beginning and the end of the part of the recording you want to “hide.”

Note: Since the DVD Recorder automatically adds a chapter marker every 5 minutes during recording, it might be a good idea to Clear All Chapter Markers before using the Hide Chapter feature. To find the Clear Chapters option, go to the Disc menu and select Disc Title Menu.

1. While playing the recording (called a title), press INFO (the Info Display appears).
2. Press right arrow until the Edit icon  is highlighted, and press OK.
3. When you're at the beginning of the place you want to hide, press PAUSE. Then, highlight *Insert Chapter Marker* (if the Info Display isn't on the screen, press INFO and select the Edit icon ).
4. Use FAST FORWARD or ADVANCE to go to the end of the segment, and select *Insert Chapter Marker* again.
5. To “hide the chapter” you must be playing it. Therefore, press REVERSE or AGAIN to go back a few seconds. If the Info Display isn't on the screen, press INFO, select the Edit icon, and select *Hide Chapter* (each time the title plays this chapter will be automatically skipped).
6. To “undo” the Hide Chapter feature for normal playback, go to the *Disc Title Menu* and select *Play Full Title*.

Chapter 4

Playing Discs

- **Regional Coding**
- **Types of Discs You Can Play**
- **How to Load and Play Discs**
- **Using the Different Menus**
- **Search Options**
- **Playback Options**
- **Using the On-Screen Info Display**

Graphics contained within this User's Guide are for representation only. Some of the menu screens, buttons, and display messages might be different in your product than they appear in this book. The on-screen help text provides the most current operational information.

Regional Coding

Both the DVD Recorder and the discs are coded by region. These regional codes must match in order for a pre-recorded DVD to play. This player's code is region 1. However, discs you use for recording (DVD+R and DVD+RW) aren't assigned region numbers.

Types of discs you can play



DIGITAL™
PHOTOVIEW™



Note: Some discs may not be compatible due to laser pickup and design.



This is an example of a one-sided disc.



This is an example of a two-sided disc — the title is usually in the center of the disc.

Tip

When you stop playing a disc, the player remembers where you stopped. When you start playing the disc again, the DVD Recorder picks up where you left off unless the disc is removed or the player is unplugged, or you press the STOP button twice.

- DVD+R and DVD+RW discs – used to record programming. Instructions about playing and recording these discs are in Chapter 3.
- DVD Video discs – contain picture and sound [DVD-R, DVD-RW (video mode only), DVD+R, DVD+RW, and DVD ROM are compatible with this player].
- CDs (CD-R, CD-RW) – Audio CDs contain musical or sound content only, mp3 discs are CDs that contain mp3 files. This player is also capable of playing CDs that contain JPEG files, and Multisession CDs.
- Video CD discs – Like DVD video discs, VCDs contain picture and sound content. The difference is the amount of information that can be stored on the disc. VCDs typically have lower picture and sound quality than DVD discs.
Super Video CDs (S-VCDs) can be used to record up to 70 minutes of digital sound and video, with MPEG-2 standard video and MPEG-1 standard audio (but you must use DVD+R or DVD+RW discs to record on your DVD Recorder NOT S-VCDs). Additionally, S-VCD disc compatibility is dependent on which MPEG coding software, disc design software, and/or disc writer software are used; and the discs themselves.

You can't play the following types of discs: Laserdiscs, CD-I, CD-ROM (computer-only discs), discs recorded using other broadcast standards (i.e. PAL or SECAM), or DVD-RAM discs.

Note: Some discs may not be compatible due to laser pickup and disc design.

To Load and Play Discs

Turn on the TV and your DVD Recorder (press ON•OFF on the remote or press the STANDBY/ON button on the DVD Recorder).

1. Make sure the TV is tuned to its Video Input channel (if you need more information, go to page 16).
2. Press the OPEN/CLOSE button (the disc tray opens).
3. Place a disc gently into the tray with the disc's label facing up (double-sided discs have content on both sides, so you can place either side up).
4. Press the OPEN/CLOSE or PLAY button. The disc tray closes. The DVD Recorder reads the disc's table of contents, and then one of three things happens depending on how the disc was programmed:
 - The disc starts playing.
 - The disc menu appears on the screen. One of the options will start disc play. Highlight that option and press OK.
 - The DVD Recorder's main menu appears on the screen. Highlight the Disc menu and press PLAY.

Note: If you don't see a picture, press STOP (the main menu appears), and check the position of the PROG SCAN switch on the back of the unit. Make sure the PROG SCAN switch is in the OFF position. Try playing the disc again.

The only time the PROG SCAN switch should be in the ON position is if you connected this unit to a progressive scan TV via Y, Pb, Pr COMPONENT jacks.

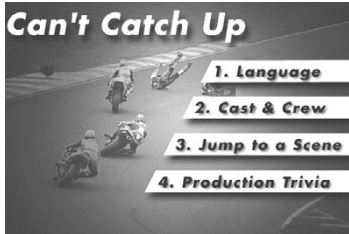

Using Different Menus

Each disc is programmed with different features. There are three separate types of menus that you can use to access features:

- **The Disc menu** – The Disc menu is part of each disc and is separate from the DVD Recorder's menu. The contents of each Disc menu vary according to how the disc was authored and what features are included.
 - To make the Disc menu appear, press the MENU button while the disc is playing.
- **The DVD Recorder's Info Display** – The Info Display appears as icons across the top of the screen when a disc is playing. It can only be accessed while you are playing a disc. It's turned on and off with the INFO button on the remote. The Info Display icons change based on the type of disc you're playing. Go to page 32 for more information.
- **The DVD Recorder menu** – If you're playing a disc, press STOP (the DVD Recorder's menu appears automatically).

Remember: A feature will only work if the disc was programmed with that feature. For example, if you choose subtitles on the Info Display, the subtitles will only appear if the disc was created with subtitles. If a menu or icon is "grayed out" it means that item (or feature) isn't available.

Search Options

Picture Scan

To search a disc during playback, use the FORWARD or REVERSE button. Each time you press FORWARD or REVERSE, your DVD Recorder scans the disc faster until you reach the fastest scan speed. To resume normal playback, press PLAY.

Note: Many DVD titles are programmed to prohibit skipping of warnings or credits so that you can't fast forward through them.

Freeze Frame and Frame Advance

While a disc is playing, press PAUSE to freeze the picture. To advance one frame at a time, press PAUSE again (the on-screen icon changes from PAUSE to FRAME). Each time you press the FORWARD or REVERSE button, the picture goes to the next (or previous) frame. To resume normal playback, press PLAY.

Slow Motion (in Freeze Frame Mode) – DVD discs only

While a disc is playing, press PAUSE. Press REVERSE or FORWARD (each time you press REVERSE or FORWARD the slow motion will get even slower until you reach slowest speed). To resume normal playback, press PLAY.

Time Search – DVD and VCD discs only

Make sure the Time Display (top left side of the Info Display) is highlighted, and then use the number buttons to enter a specific time on the disc that is playing. Go to page 33 for more information about the Time Display.

Quick Fast Forward and Quick Reverse – DVD and Audio CD only

While you're playing a disc, press the AGAIN button on the remote (the disc automatically repeats the last 10 seconds of the movie).

Similarly, press the ADVANCE button to go forward approximately 30 seconds.

Playback options

Many of your DVD Recorder's playback features are accessed through the Info Display (described on pages 32 through 36). Additionally, with some discs you can use the Zoom Feature to see details of an image.

Zoom

1. While you're playing a disc, press ZOOM (the player zooms in on the image). Each time you press ZOOM, the picture is magnified even more (until you get to the maximum zoom level).
2. To see other parts of the picture when you've zoomed in on the image, press the up, down, left, and/or right arrow buttons to go in corresponding directions.

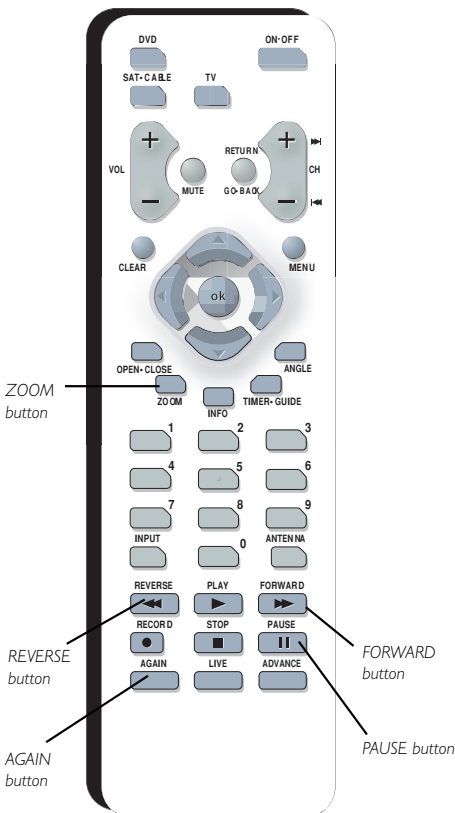

Using the On-Screen Info Display

The on-screen Info Display contains many playback features. To see the Info Display, press the INFO button on the remote while a disc is playing (the Info Display appears across the top of the screen). Each feature is illustrated with an icon. Use the left and right arrow buttons to move through the different icons in the Info Display. When an icon is highlighted, use the up and down arrow buttons on the remote to scroll through the choices.

Remember, you can only access the Info Display when you're playing a disc. Also, the Info Display features are only available if the disc was created with that particular feature (i.e., if you select the Angle icon, you won't be able to change the camera angle unless the disc was created with different camera angles). If one of the icons is "grayed out," the Info Display feature isn't available for the disc you're playing.



The invalid symbol appears on the screen when you press a button that doesn't have any function. To make the Info Display disappear from the screen, press INFO on the remote control.

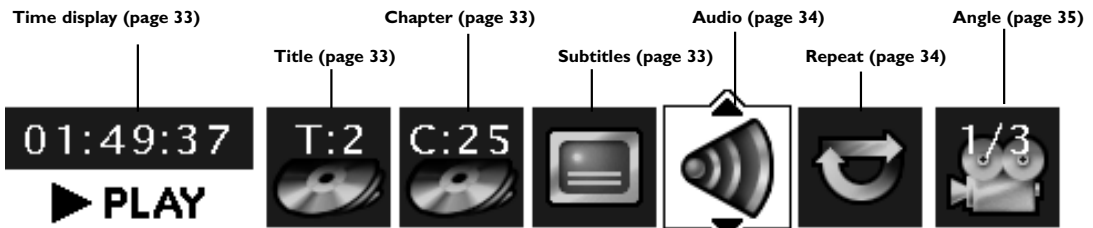

Text will appear here as you highlight different icons to help you use the Info Display.

This is the Info Display you'll see when you're playing a pre-recorded DVD disc. To make the Info Display appear, press the INFO button on the remote control. Use the left and right arrow buttons to highlight different icons. Use the up and down arrow buttons to scroll through the choices available.

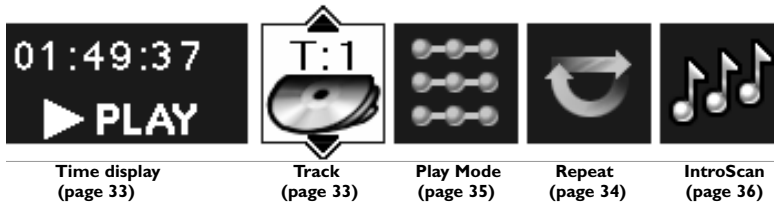

This is the Info Display you'll see when you're playing an audio CD.

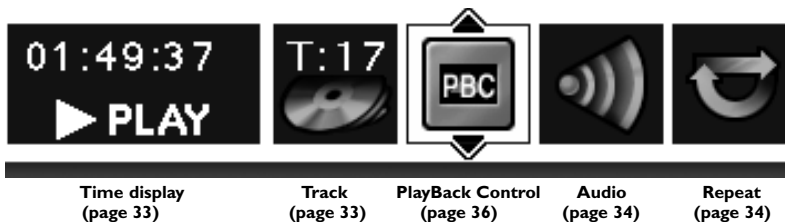

This is the Info Display you'll see when you're playing a Video CD, also called a VCD.



Time Display (DVD, Video CD, and Audio CD)

This feature displays the time that has elapsed during playback. For DVD discs, the time displayed refers to the current title and acts as a Time Search feature. For example, if you like a particular scene in a movie, you can enter the elapsed time the scene plays and skip right to it.

1. Highlight the Time Display and use the number buttons on the remote to enter the elapsed time you want to go to in that title. You must use two digits for each field. For example, if you enter 01:35:12, playback will start one hour, 35 minutes, and 12 seconds into the title.

Notes:

For Audio CDs, the time displayed refers to the track that's playing.

Some portions of a disc might prohibit searching or scanning, such as warnings or opening credits.



Selecting a Title on DVDs or a Track on Audio CDs or Video CDs

Some discs contain more than one title. For example, there might be four movies on one disc (each movie might be considered a title). Each title is divided into chapters.

To select a title via the Info Display, highlight the Title icon with the right arrow button on the remote control. Press the up or down arrow button to go to the next title: When you're playing a VCD or an Audio CD, use these instructions to go to a different Track.

Notes:

You can also use the number buttons on the remote to enter the title/track number.

Many discs only have one title.



Chapter Icon (DVD)

Because DVD discs use digital technology, a title can be divided into individual chapters (similar to tracks on a CD). You can skip to a specific chapter by using the Chapter feature in the Info Display.

1. While a disc is playing, press INFO on the remote (the Info Display appears).
2. Press the right arrow button until the chapter icon is highlighted.
3. Press the up and/or down arrow buttons to go to different chapters.

Notes:

You can also use the number button(s) on the remote to enter the chapter you want to play—enter 2 digits (for example, to go to chapter 4, press 0 and then press 4). The movie starts playing at the beginning of the chapter you entered.

The Chapter feature won't work if the disc isn't formatted with separate chapters.

When you're recording onto DVD+R and DVD+RW discs, a chapter mark is added automatically every 5 minutes of recording.

Shortcut

While you're playing a disc, you can use the CH +/ CH- buttons to go to the next chapter or previous chapter.



Subtitle Icon (DVD)

To change the subtitle language, highlight the subtitle icon and press the up or down arrow buttons to scroll through the choices (the subtitle language options appear in the box at the bottom of the Info Display).

Notes:

Changing the subtitle language with the Info Display will only affect the disc you are currently playing. When the disc is removed or the player is turned off, the subtitle language will revert to the language setting specified through the DVD Recorder's Language menu.

If the disc doesn't contain the language you want to use, the disc's default language is automatically selected.

Some discs are programmed to only allow you to access the subtitle feature through the disc's menu. If changing subtitle language via the Info Display doesn't work (as described above), press MENU and change the subtitle language via the disc's menu.



Repeat Icon (DVD, Video CD, and Audio CD)

By default, the Repeat feature is Off. There are three Repeat options:

- Title – repeats the title that is playing
- Disc – repeats the disc that is playing
- A-B – repeats a segment of the disc that you select.

Repeating Titles, Chapters, or Tracks

1. While a disc is playing, press INFO (the Info Display appears).
2. Press the right arrow button until the Repeat icon is highlighted.
3. Press the up or down arrow button to scroll through the different Repeat options — *Repeat title*, *Repeat disc*, *Repeat AB*, and *Repeat Standard* (the modes appear at the bottom of the Info Display).
4. To turn off the Repeat feature, press the up or down arrow button repeatedly until *Repeat Mode: Standard* appears.

AB Repeat

AB Repeat lets you define a specific segment on the disc that you want to repeat. For example, you might want to watch a specific scene from a movie repeatedly:

1. Follow steps 1 and 2 above.
2. Press the up (or down) arrow button until “*Repeat Mode: AB. Press OK to set A point*” appears at the bottom of the Info Display. Press OK when the disc gets to the beginning point of the segment (the A point) that you want to repeat.
3. Go to the end of the segment you want to repeat. Press OK to set the B point (the segment you marked will play repeatedly until you turn off the Repeat feature).
4. To turn off the Repeat feature, highlight the Repeat icon, and press the up arrow button on the remote until *Repeat Mode: Standard* appears at the bottom of the Info Display.

Note: Repeat is also cancelled when you eject the disc from the DVD Recorder.



Audio Icon (DVD and Video CD)

If the disc was created with different language tracks (recorded in different languages) or different audio formats (Dolby, DTS, stereo, etc.), you can change the audio option while you're playing the disc.

1. While a disc is playing, press INFO (the info display appears).
2. Press the right button until the Audio icon is highlighted.
3. Press the down arrow button on the remote to scroll through the available audio options.
4. When the option you want to use is highlighted, press the OK button.

Notes:

The language feature only works if the disc was created with multiple language tracks. If the disc doesn't contain the language you selected, the disc will play in the default language.

When you choose an audio language during disc playback, you only override the audio language setting in the DVD Recorder's Language menu temporarily.

Some discs are programmed to only allow the audio setting to be changed via the disc's menu. If changing audio option via the Info Display doesn't work (as described above), press MENU and change the audio setting via the disc's menu.



Camera Angle Icon (DVD)

Some discs contain multiple angles of a particular scene or sequence. If the disc only has one angle, this feature won't work. Currently, very few discs have this feature.

1. While a disc is playing, press ANGLE on the remote. If the disc wasn't created with multiple angles, the invalid symbol appears. If the disc contains multiple angles, the Angle icon appears with the current angle number and the number of angles available. For example, 1 of 4 indicates that Angle 1 is displayed and there are 4 different angles available.
2. Press the up arrow button to go to the second camera angle. Press the arrow button again to go to the third angle, etc.
3. To resume normal playback, scroll through the camera angles until you get to the original angle.

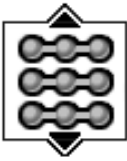

Play Mode Icon (Audio CD)

When you play audio CDs, the various Play Modes are available from the Info Display. The Play Mode feature lets you set up the order in which you want the tracks on the CD to play. There are three Play Modes:

Standard: the tracks play in the same order as listed on the CD (starting with track 1). This is the default play mode.

Random: the tracks on the CD play in a random order.

Program: the tracks play in the order you designate. To use the Program play mode, you must set up the order in which you want the tracks to play in the DVD Recorder's main menu system (go to page 45 for instructions).

Random

The Random option plays the tracks in a random order.

1. While you're playing a disc, press INFO (the Info Display appears).
2. Press the left or right arrow button to highlight the Play Mode icon.
3. Press the down arrow button until *Play Mode: Random* appears in the text at the bottom of the Info Display (the tracks start playing in random order).

To switch back to Standard Playback, follow steps 1 through 3 above until *Play Mode: Standard* appears underneath the Info Display icons.

Note: The player defaults to Standard Playback whenever you put a new CD into the DVD Recorder.

Program

The Program Play Mode is only available after you set up a playlist via the DVD Recorder's Disc menu (page 41).



IntroScan Icon (Audio CD)

Use the IntroScan feature to preview each track on the CD.

1. While the CD is playing, press INFO (the Info Display appears).
2. Use the arrow buttons to highlight the IntroScan icon.
3. Press OK (the first 20 seconds of each track starts playing).



Playback Control (PBC) Icon (Video CD)

Use the arrow buttons to highlight the Playback Control icon. Press the up or down arrow button to go back and forth between On and Off. How Playback Control (PBC) works varies for different Video CDs. With most Video CDs, turning on Playback Control enables you to access the Video CD's menu if it has one and requires that you navigate through the Video CD's contents by using the Video CD menu instead of the DVD Recorder's Info Display. When PBC is on, you won't be able to use any repeat modes or skip titles in the DVD Recorder's Info Display.

Playing Discs You Recorded (DVD+R and DVD+RW)

Playback of DVD+R and DVD+RW discs that you used to record programs is explained in Chapter 3 (go to page 26).

Playing mp3 or JPEG files

Your DVD Recorder can play mp3 files and JPEG files. You can also create a musical slide show by putting both mp3 (MPEG-1, layer 3) and JPEG files on the same disc.

mp3 is an audio file format which compresses recorded music. It was developed by Fraunhofer Gesellschaft in collaboration with Thomson Inc. The main advantage of the mp3 format is the ability to store CD-quality music tracks that are user-friendly and compressed on a personal computer. mp3 (MPEG-3, which stands for Motion Picture Experts Group-Layer 3, meaning the third layer of information) is a format used to compress digital audio. Since the audio is compressed, it takes up less space.

Note: You can only play true mp3 files in the DVD Recorder — some products use software to compress mp3 files and convert them to other formats such as MPX. Your DVD Recorder won't recognize or play MPX files or other types of converted mp3 files.

JPEG files are image files. Make sure that they have a resolution of less than 5 megapixels (approximately 2MB).

Note: The time taken for the contents of the disc to be displayed varies according to the size and number of JPEG files actually on the disc. If nothing is displayed after a few minutes, it is likely that certain files are too large. In this case, reduce the files' resolution to less than 5 megapixels (approximately 2MB) and write another disc.

Creating an mp3 Disc on Your Computer

Your DVD Recorder handles MPEG-1, layer 3 audio. If you encode your own mp3 files from an audio CD, avoid using the features of MPEG-2, such as the 22kHz sampling frequency.

Be sure to make a data CD rather than an audio CD. If you make an audio CD, you will lose the extra features and compression of the mp3 format.

Notes:

Some transport modes (reverse and fast forward) are not available for mp3 CDs.

When burning multisession CDs, make sure you close the last session.

For more help and recommendations about mp3 files, go to page 50.

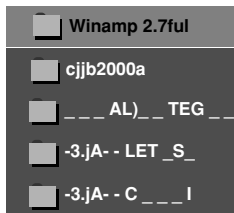

Example of folder list

1. Place the disc in the disc tray with the printed side facing up (a choice list appears). If you want to play mp3 files, highlight *Music*; if you want to view JPEG files, highlight *Pictures*; if you want to play both, highlight *Both*.
2. If the *AutoPlay* option in the *Play Mode* menu is enabled (see page 42), the disc's contents are displayed, otherwise press the **PLAY** button to display them.
3. Select a folder using the **▲** and **▼** buttons on the remote control, then press **OK** to display the list of files or press **PLAY** to start playing all the files contained in the folder.
4. Select a file using the **▲** and **▼** buttons, press **OK** (the playback options appear). Use the **▲** and **▼** buttons to scroll through the options and press **OK** when desired option appears.
 - mp3 file: if you press play when a file is highlighted, the player begins by playing the selected file, then all the files and subfolders contained in the same folder. The player then plays the contents of the folders at the same level as the folder containing the file selected at the start.

Notes:

While listening you can use the **◀** or **▶** button to go back to the previous track or go to the next one, and press the **MENU** button to display the disc's contents.

Some file names are too long to be completely displayed. Usually, the full name appears next to the play icon (the right side of the screen).

- JPEG file: the player starts the slide show with the JPEG file you have selected and proceeds to display all the JPEG files in the same folder, then all the JPEG files in the subfolders located in the same folder.

*Note: During the slide show you can use the **ANGLE** button to rotate the picture 90°, the **ZOOM** button to magnify the picture, the **◀** or **▶** buttons to go back to the previous picture or go on to the next one, the **FORWARD** and **REVERSE** buttons to change the speed of the slide show (the speed selection varies depending upon the size of the JPEG files, and the **MENU** button to interrupt the slide show and display the disc's contents.*

5. Press the **INFO** button to display the Info menu during playback.
 - mp3 file: press the **AUDIO** or **PLAY MODE** button several times to select a playback mode (standard, program, random, repeat).
 - JPEG file: press the **▼** button to select a projection speed.
6. When the player has played all the files, the disc's contents appear.
7. Press **STOP** to end playback.



Example of mp3 files.



Example of JPEG files.

This page intentionally left blank.

Chapter 5

Menu System

- **Overview of the DVD Recorder's Menu System**
- **Watch TV Menu**
- **Disc Menu**
- **Disc Library Menu**
- **Timer Menu**
- **Setup Menu**
- **Memory Card Menu**

Graphics contained within this User's Guide are for representation only. Some of the menu screens, buttons, and display messages might be different in your product than they appear in this book. The on-screen help text provides the most current operational information.

Chapter 5: The Menu System

Overview of the DVD Recorder's Menu System

Since this product has many features, it has a wealth of menus and options. To access the main menu during playback, press the STOP button on the remote. To access the main menu when you're not playing a disc, press the MENU button.

How to navigate through on-screen menus

Throughout the DVD Recorder's menu system, you'll see arrows on the on-screen menu bars. These arrows indicate you can use the correlating arrow buttons on the remote control to navigate to different menus and access choices. When a menu item is highlighted, press OK to select the menu.

If you see the left arrow button, you can press it to return to the previous menu. Throughout the menu system, the GO BACK button takes you to the previous menu.

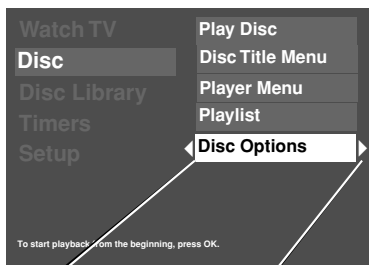

Press the left arrow button on the remote to go to the previous menu.

Press the right arrow button or the OK button on the remote to access the Disc Options.

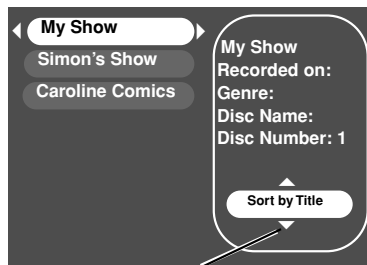

Press the up or down arrow button on the remote control to see more options.



The Main Menu

The main menu is divided into the following submenus:

Watch TV - shows current channel number or input.

Disc - plays a disc, enables you to create a customized playlist for audio CDs, selects the screen format for DVDs, and accesses title menus and disc menus for DVDs. Go to page 41 for details.

Disc Library - contains information about all programs you've recorded using this DVD Recorder. You can use the *Disc Library* as a search tool by sorting recorded programs. As much information as possible is stored automatically. The information is stored in the DVD Recorder's memory and has storage limits. You may need to delete some library contents in the future to make room for new recordings. For detailed information about the *Disc Library*, go to page 26.

Timers - set up timer recordings and view the list of existing timer recordings. Go to page 42 for information about this menu. For instructions to set up a timer, go to page 25.

Setup - accesses all of the menus from the Interactive Setup (the menu you went through the first time you turned on the product); parental controls (rating limits); language options for on-screen menus and discs; and advanced settings for audio and component video. Go to page 43 for more information.

Memory Card (only appears after connecting a compatible Mass Storage USB Device via the USB port on the front of the DVD Recorder) - lists options for playing and/or copying JPEG and mp3 files from a memory card (also called a flash card) via a compatible Mass Storage USB Device that you connect to the USB jack on the front of the DVD Recorder.

Notes:

You can only copy JPEG and mp3 files to a DVD+RW disc.

Not all Mass Storage USB Devices (commonly called memory card readers) will work with this DVD Recorder. For purchasing information, go to page 54.



Watch TV

Shows the current channel or input. To watch TV, press OK when the *Watch TV* menu is highlighted (the channel banner appears to show you available program information, such as channel, name, and time. For more information, go to page 24.

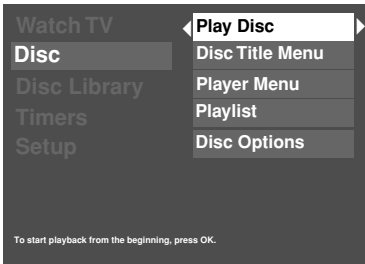

Disc

You can only access the disc menu when you've inserted a compatible disc into the DVD Recorder. The submenus follow:

Play Disc: starts playing the disc.

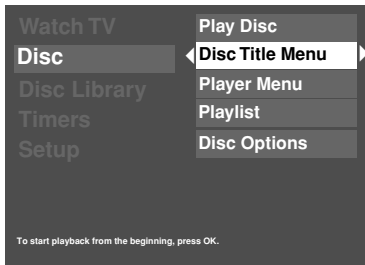

Disc Title Menu: available when you've inserted a DVD+R or DVD+RW disc that you've recorded in this DVD Recorder. With *Disc Title* highlighted, press OK to access the disc's title menu (the disc name appears on the top and each recording is listed below).

If you press OK when the disc name is highlighted, the following choices appear:

Rename Disc: Press OK when highlighted (the on-screen keyboard appears). Follow the on-screen instructions to give the disc a different name. Highlight Done when you're finished, and press OK.

Erase Disc: Erases a DVD+RW disc so you can record new programming onto it.

Lock Disc: Protects contents of the DVD so nobody can record new programming onto it.

Finalize Disc: Enables a DVD+R disc to be played in other DVD players.

If you press OK when one of the recordings (titles) is highlighted, the following choices appear: Rename title; Play title; Play full title; Delete title; and Clear chapters.

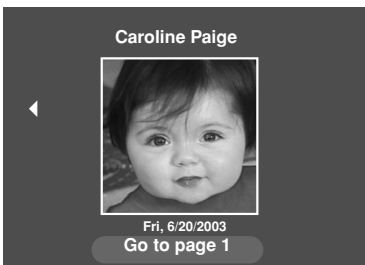

Player Menu: shows you how a DVD+R or DVD+RW disc's menu will appear in other DVD Players. A small still-frame from each title you record (program, show, movie) appears as a thumbnail. You'll use the DVD player's left and right arrow buttons to highlight a thumbnail so you can play the recording. If you have multiple recordings and want to get back to the beginning quickly, highlight *Go to page 1* (if available on the screen) and press OK.

Note: Not all DVD players are able to play DVD+R and DVD+RW discs. Check the DVD player's owner's manual.

The DVD Recorder's *Player Menu* shows how a DVD+R or DVD+RW disc menu will appear in another DVD player.

Note: not all DVD players support DVD+R and DVD+RW discs.

Playlist: (available for Audio CDs and DVDs): You can create a customized playlist just like you can with many CD players where you rearrange the order in which the songs play. The playlist is played via the Program Play option in the Info Display (page 35). To set up a playlist, follow the on-screen instructions.

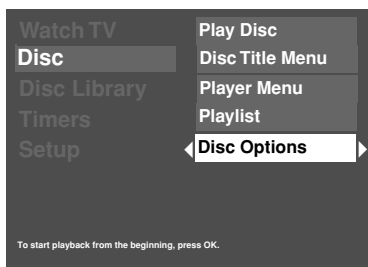

Disc Options

Autoplay: When you select *On*, a disc immediately starts playing after you insert it into the player (there's no need to press the PLAY button).

Note: For CDs with mp3, WMA, or JPEG files on them, instead of playing automatically, the CD's folders appear automatically.

Screen format: the setting you choose adjusts the way a movie appears on your TV (DVD discs only). Standard TVs are 4 x 3 format. Depending on the type of television you have, you may want to adjust the screen setting (also called the aspect ratio). The choices follow:

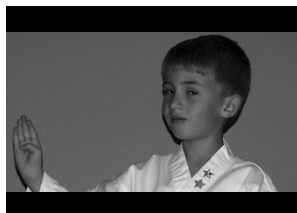

4 x 3 Letterbox

4 x 3 Letterbox – Choose this setting if you want to see movies in their original aspect ratio (height-to-width ratio). You'll see the entire frame of the movie, but it will take up a smaller portion of the screen vertically. The movie might appear with black bars at the top and bottom of the screen.



4 x 3 Standard

4 x 3 Standard – Choose this setting if you want the movie to fill the entire screen of your TV. This might mean that parts of the picture (the left and right edges) won't be seen. Most discs that are produced in a widescreen format only can't be cropped in this fashion.



16 x 9

16 x 9 – Choose this setting if your DVD Recorder is connected to a widescreen TV. If you choose this setting and you don't have a widescreen TV, the images on the screen might appear distorted due to vertical compression. If you play a disc recorded in 4 x 3 format on a widescreen TV, the left and right sides of the screen will appear black.

Angle Icon: Some DVDs are produced with multiple camera angles. However, it is difficult to know when the angle feature is available throughout a movie. If you turn on the Angle Display, an icon will appear on the screen whenever multiple angles are available for a particular scene in a movie.

Disc Library

The disc library accesses information about what you've recorded onto discs. Details of this feature and the submenus are described on page 26.

Timers

Timer: You can add timers and view or edit existing timers from this menu for automatic recording. Timer recordings are especially useful when you have a favorite program that you want to record every week and/or every day. If you use a cable box, the cable box must be *On* during the timer recording; if you're recording from satellite, the satellite set-top box, also called a receiver, must be *On*. For details about setting up a timer, go to page 25.

Note:

To go back to a previous menu, press GO BACK.

Setup

The Setup menu contains many submenus that are explained on the following pages. The following list is an overview. Follow the instructions at the bottom of the screen.

Note: To return to a previous menu, press the left arrow button or GO BACK.

Using Parental Controls

You can set up ratings limits and turn on the Parental Control feature in order to control the type of discs people can play in the DVD Recorder. The padlock icon on the Lock menu indicates whether the player is locked or unlocked.



Locked: You need to enter the password in order to play discs that have a higher rating than what you've allowed. When the player is locked, nobody can access the Lock menu without entering the password.



Unlocked: No password required to play discs. Even if you've set ratings limits, they won't be enforced when the player is unlocked.

Notes:

The player is shipped unlocked without any rating limits set. If you want to use the Parental Control feature, set Ratings Limits and then lock the player.

Don't confuse the DVD Recorder's Parental Control feature with a parental control feature that may be in your TV, often referred to as V-Chip. The ratings described here refer to discs that you play in the recorder, not TV programs.

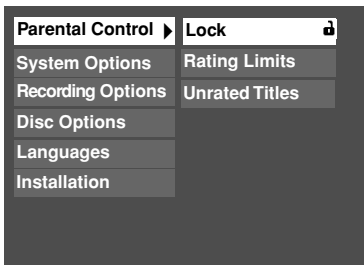

Lock (and Unlock)

1. From the DVD Recorder's main menu, select *Setup* and press OK (the *Setup* menu items appear).
2. Since *Parental Control* is highlighted, just press the OK button (the *Parental Control* menu items appear).
3. Since *Lock* is highlighted, just press the OK button on the remote.
4. If prompted to enter a password, use the number buttons on the remote control and press OK (*Confirm Password* appears). Enter the same numbers you entered before and press OK.
5. To return to the previous menu, press the left arrow button.

Once the player is locked, you'll need to enter the password everytime you access the *Parental Controls* menu.

Note: The player is shipped without any rating limits set. You need to set *Ratings Limits* (go to page 44 for instructions) in order for the player to prevent people from playing discs with certain ratings.

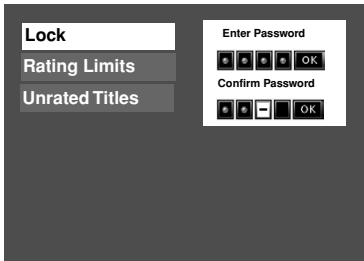

Rating Limits

The *Rating Limits* menu lets you determine what types of discs can be played in the player, and what types of discs will require a password to override the rating limit that you've set. In the U.S., the ratings feature is based on the ratings set up by the MPAA (Motion Pictures Association of America) such as R, PG, G, etc.

The system ranks the ratings from 1 to 8 in order to accommodate ratings systems used in other countries (1 is considered material that is least offensive and 8 is considered the most offensive).

Note: In order for the *Ratings* to be enforced, the DVD Recorder must be locked and the disc you're playing must contain a movie (or a title) that is rated.

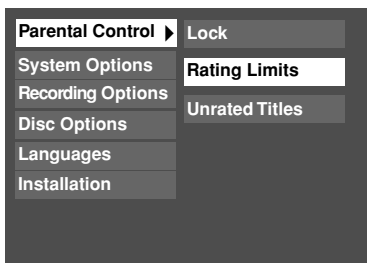

To set Ratings:

1. From the DVD Recorder's main menu, select *Setup* and press OK (the *Setup* menu items appear).
2. Since *Parental Control* is already highlighted, just press OK (the *Parental Control* menu items appear).
3. Highlight *Rating Limits* and press OK (the 8-level rating list appears).

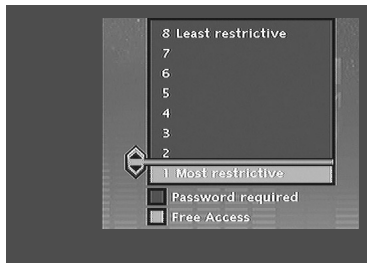

4. Use the up and down arrow buttons to move the bar to the rating level you find acceptable.

Ratings that don't require a password (free access) appear under the bar.

Ratings that require a password appear above the bar.

5. Press OK.

Note: You must lock the player (page 43) in order for the ratings to be enforced.

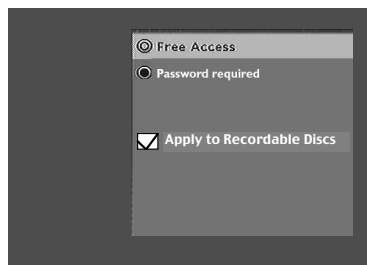

Unrated Titles

Some discs contain titles (or movies) that don't have a rating assigned to them. Sometimes, movies you might find the most explicit are unrated. However, much of the new programming on a discs, such as interviews with actors and directors, is also unrated. Additionally, the discs you use to record (DVD+R and DVD+RW) are considered unrated.

In order to prevent unrated titles from being played, you need to choose *Password Required* from the *Unrated Titles* menu, and lock the player.

If you want this setting to apply to disc you recorded (DVD+R and/or DVD+RW discs), simply highlight the check box next to *Apply to Recordable Discs* and press OK.

System Options:

Contains settings and menus for audio features, as well as black level settings and dimmer options for the front display of your DVD Recorder.

Digital Output: If you connected your DVD Recorder to a receiver via the DIGITAL AUDIO OUT jack (COAXIAL or OPTICAL) on the back of the player, choose the type of receiver (or decoder) you have: Dolby Digital and/or DTS.

Note: If you select DTS, and you don't have a DTS receiver connected to the DVD Recorder you won't hear any audio or the audio will be distorted.

SRS/TruSurround: The TruSurround® feature simulates a six-speaker listening experience through just two speakers. The default setting is *Off*. To turn on the Virtual Surround® feature highlight *SRS/TruSurround*, and press OK. Highlight *On* and press the OK button.

Black Level: Adjusts how bright the picture appears. Choose between *Dark* and *Light*. Use the arrow buttons to highlight a choice and the OK button to select the choice that's highlighted.

Dimmer: Adjusts the brightness of the display on the front of the DVD Recorder. Use the arrow buttons to highlight a setting, and the OK button to select the option that's highlighted. The choices follow: *Automatic* (the display automatically dims during playback); *Bright*; *Dim*.

AutoClock: Keeps the DVD Recorder's time current by downloading time from broadcast signal. If the DVD Recorder's clock is out of sync and AutoClock is on, try turning off AutoClock and set the time manually via the Clock Setup menu (page 50).

Audio Broadcast: Default setting for type of audio recorded and played. Choices are Stereo, Mono, SAP (Second Audio Program).

TruSurround  is a trademark of SRS Labs, Inc. TruSurround technology is incorporated under license agreement from SRS Labs, Inc.

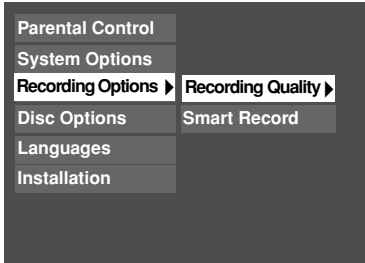

Recording Options:

Recording Quality: Similar to quality settings on a VCR, you tell the DVD Recorder what quality you want to use for the recording — the better the quality, the more memory (space) the recording will use on the DVD+R or DVD+RW disc. The choices are:

- | | | |
|---|---------------|--|
| 1 | Best | 1 hour recording time on an empty 4.7 GB disc |
| 2 | High | 2 hours recording time on an empty 4.7 GB disc |
| 3 | Good | 3 hours recording time on an empty 4.7 GB disc |
| 4 | Normal | 4 hours recording time on an empty 4.7 GB disc |
| 5 | Basic | 6 hours recording time on an empty 4.7 GB disc |
| 6 | Low | 8 hours recording time on an empty 4.7 GB disc |

SmartRecord: Used with Timer Recordings to ensure you have enough space on the disc to record the program. When SmartRecord is on, the DVD Recorder automatically detects how much recording time is left on the disc and adjusts the Recording Quality automatically if necessary.

Disc Options:

Takes you to Disc Menu options—Autoplay, Screen Format, and Angle Icon. Go to page 42 for more information.

Languages:

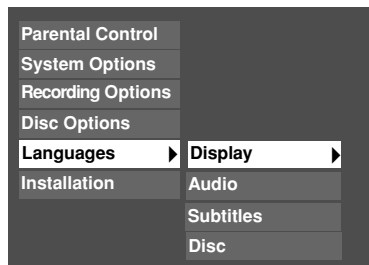

Display: the language that appears when you access this menu the first time reflects the option you chose during the interactive setup. To change the language of the on-screen displays (menus), use the arrow buttons to highlight a language and press OK to select it.

Audio: the language that appears when you access this menu the first time reflects the option you chose during the interactive setup. You can change the audio language by highlighting an option and pressing the OK button.

Subtitles: Some movies on DVD discs have subtitles. Set up your default settings in this menu. You can quickly override these settings while playing a disc by using the Info Display (go to page 33 for information).

Automatic: matches the language you selected during interactive setup.

Off: subtitles won't appear on the screen.

On: if the title (movie) has subtitles available, they will appear automatically.

Original: subtitle language will match the original audio (dialogue) language of the title (movie).

Disc: Many discs have their own menu that appears on the screen. You can select the language in which you want the disc menu displayed. In order for your setting to take effect, the disc's menu must have been created with the corresponding language option.

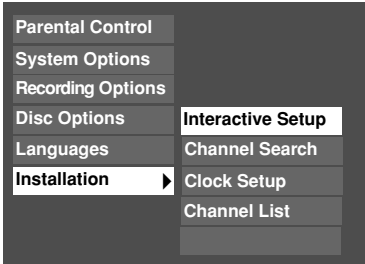

Installation:

The submenus contained in the *Installation* menu pertain to the way you've connected the DVD Recorder to other components such as your TV, satellite receiver, and or cable box. If you move, or change any of the information you gave the DVD Recorder when you set it up initially, you need to change the information in these menus.

Interactive Setup: The first time you turned on your DVD Recorder, you had to complete an interactive setup so your DVD Recorder could have the information it needs to function properly. For details about the Interactive Setup, go to page 13. To go through this procedure again to change settings, highlight *Interactive Setup* and press the OK button.

Channel Search: If you've changed program providers (cable and/or satellite), the Channel Search will automatically search the signal and put the latest channels in the DVD Recorder's channel list. Use the arrow buttons to highlight *Channel Search*, and press OK to begin (a progress indicator appears to let you know how quickly the search is being completed).

Clock Setup: If the clock is incorrectly set or you skipped this step during the interactive setup, you can set the DVD Recorder's clock using the number buttons on the remote and the arrow buttons to navigate. Follow the on-screen instructions.

Note: In order for Timer Recordings to work, you must set the clock to the correct time and date.

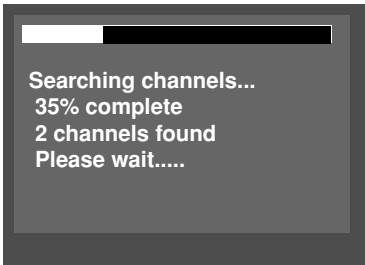

Channel List: Enables you to change what channels are accessed when you press the DVD Recorder's channel up and down buttons (if you delete a channel from the channel list, you can still access it by using the number buttons on the remote). For more explanation, go to page 15.

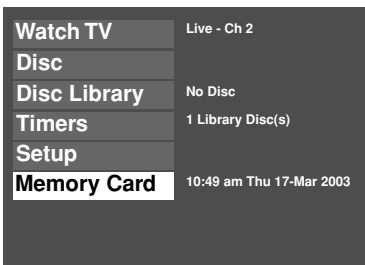
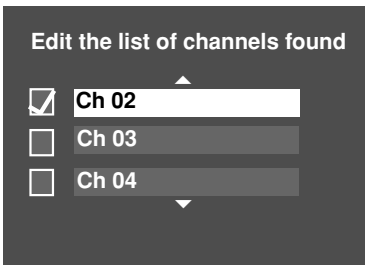

Memory Card Menu

This menu only appears when you've connected a Class Compatible USB Mass Storage Device (commonly referred to as a USB Card Reader) to the USB Port on the front of the DVD Recorder (it's underneath the door on the left side of the unit). Go to page 54 for card readers that are compatible with this DVD Recorder.

Once you've connected the card reader and inserted the memory card, you can play the music and/or images stored on the card. You can also copy them onto a DVD+RW disc.

Note: If there is a power failure or you unplug the DVD Recorder while content is being copied, the DVD+RW disc will become permanently inoperable.

IMPORTANT: You can only copy contents of a memory card to a DVD+RW disc, not a DVD +R disc.

Chapter 6

Additional Information

- **Troubleshooting**
- **Handling Cautions**
- **Maintenance of Cabinet**
- **Buttons and Controls on the front of the DVD Recorder**
- **Limited Warranty**
- **Accessory Information**
- **Copying content from DVD+R or DVD+RW disc to VCR videocassette**
- **Copying VCR videocassette to a DVD+R or DVD+RW disc**

Graphics contained within this User's Guide are for representation only. Some of the menu screens, buttons, and display messages might be different in your product than they appear in this book. The on-screen help text provides the most current operational information.

Troubleshooting

General Problems

Player won't work (locks up)

- Try unplugging the AC power cord and plugging it back in.
- Reset the DVD Recorder: on the front of the unit, press and hold the STANDBY/ON button while you press and hold the STOP button — wait at least 3 seconds before you release both of the buttons. You'll need to set up your menu preferences because this Reset Procedure returns the DVD Recorder's menus to the factory default settings and also erases the contents of the Disc Library.

No power

- Plug in the DVD Recorder. Make sure both ends of the AC power cord are securely plugged into the Recorder and into an AC outlet.
- Make sure you've plugged it into a working outlet and/or a power strip that is turned on.
- Don't plug the unit into an outlet that is operated by a wall switch.

Disc tray won't open

- Maybe the Tray Lock feature has been activated. To unlock the disc tray, press and hold the STOP button on the front of the unit and then press and hold the OPEN/CLOSE button on the front of the unit at the same time - wait 3 seconds before releasing both buttons.

No picture

- Turn on the TV.
- Tune your TV to the Video Input Channel that corresponds to the jacks you used to connect the TV to the DVD Recorder (go to page 16 for more help).
- If you're playing a DVD, press STOP (the main menu appears). Check the PROG SCAN switch on the back of the unit to make sure it is in the OFF position. Try playing the disc again.
- Make sure your DVD Recorder is connected properly.
- If you connected a satellite receiver or a cable box, make sure it is turned on.

Light is blinking

- There is a problem with a Timer Recording — you've either set up two programs to record at the same time; two programs that overlap; there's not enough room on the disc to record; or the disc is locked. Turn on the TV and DVD Recorder, and go to the *Timers* menu to find out what's wrong.

A screen saver appears on the TV

- Your player is equipped with a screen saver that appears on the TV after your player has been idle for several minutes. To make it disappear, press STOP or CLEAR on the remote.

The menu is displayed in a foreign language

- The *Language* menu (*Display* menu) is set to that language. Go to the *Setup* menu and choose *Languages* (in Spanish, shown as *Idiomas*; in French, as *Langues*), choose the *Display* option. Highlight the language you prefer, and press OK.

Disc won't eject

- When you put a disc into the player, the player may take up to 15 seconds to read the disc. You won't be able to eject the disc during this time. Wait 15 seconds and try again.
- Maybe the Tray Lock feature has been activated. To unlock the disc tray, press and hold the STOP button on the front of the unit and then press and hold the OPEN/CLOSE button on the front of the unit at the same time - wait 3 seconds before releasing both buttons.

I forgot my password

- Press the STOP button on the front of the unit while you press the STOP button on the remote control — keep pressing both buttons for approximately 3 seconds (until the  icon disappears from the front panel display). Release both buttons (the player should be unlocked). If that doesn't work, try resetting the DVD Recorder (instructions are listed below).
- Reset the DVD Recorder: on the front of the unit, press and hold the STANDBY/ON button while you press and hold the STOP button — wait at least 3 seconds before you release both of the buttons. You'll need to set up your menu preferences because this Reset Procedure returns the DVD Recorder's menus to the factory default settings.

The time (clock) is wrong

Go to the *System Options* menu and select *AutoClock*. Set it to off and then set the time manually via the *Clock Setup* menu, which is found in the *Installation* menu.

Playback Problems

Disc won't play

- Insert a disc with the label side facing up.
- Check the type of disc you put into the player. This player only plays DVD video discs, Video CDs, audio CDs, and CDs with true mp3 files and/or JPEG files. mp3 files that have been converted to MPX files (or similar types of files) won't be recognized by your DVD Recorder.
- Both the DVD Recorder and the disc are coded by region. If the regional codes don't match, the disc cannot be played. This player is Region No. 1. Region coding isn't applicable to discs you use to record (DVD+R and DVD+RW).
- Press STOP (the main menu appears). Check the PROG SCAN switch on the back of the unit to make sure it is in the OFF position. Try playing the disc again.
- If you're playing a Multisession CD, you might not have closed the session before ejecting it from your computer. Close the session and try the disc again.
- If you're trying to play a DVD+R or DVD+RW disc you recorded in this DVD Recorder in another DVD player, the DVD player may not support DVD+R or DVD+RW discs. Also, if it is a DVD+R disc make sure you finalize it (p. 41).
- If it's a DVD+R or DVD+RW disc, check the setting in the *Parental Controls* menu. Go to *Unrated Titles*, and see if the box is checked next to *Apply to Recordable Discs*. If there is a check in the box and you set *Unrated Titles* to *Password Required*, simply highlight the checkbox and press OK. Try to play the disc again.

Play starts, but then stops immediately

- The disc is dirty. Clean it.
- Condensation has formed in the DVD Recorder. Allow it to dry out.

The picture is distorted and/or fuzzy; or "jumps" during disc playback

- The disc might be damaged. Try another disc.
- It is normal for some distortion to appear during forward or reverse scan.
- The disc might be dirty. Clean it (go to page 51 for instructions)
- Some discs have defects that cause them to jump from one scene to the next.
- Turn the PROG SCAN switch on the back of the DVD Recorder to the "off" position. This switch should only be turned on if you've connected the DVD Recorder to a television that uses progressive scanning to display the image. Some, but not all High Definition Televisions (HDTVs) and multimedia monitors use progressive scan.
- If you have a progressive scan TV connected, a slight jumping of the signal is normal when you first play a DVD disc. A more detailed explanation follows:
If you have a progressive scan TV connected to the DVD Recorder via the COMPONENT jacks (Y, Pb, Pr) and turned on the PROG SCAN switch, the DVD Recorder automatically switches between progressive scan and regular interlace because progressive scan is only available when you play DVD discs. As the signal is converted from interlace to progressive (and vice versa), the Recorder resynchronizes the signal. Depending upon your TV, this resynchronization process might cause a slight "jump" in the picture when you start playing a DVD disc and again when you return to watching TV.

No sound or distorted sound

- Make sure your player is connected properly. Make sure all cables are securely inserted into the appropriate jacks.
- You may need to readjust the Digital Output setting (from the *System Options* menu). Go to page 44. If you select DTS, and your DVD Recorder isn't connected to a DTS-capable receiver, you won't hear any sound, or the sound will be distorted.
- Turn your TV to its Video Input Channel (go to page 16).
- Sound is muted when you're using search features (fast forward, reverse, frame advance, etc.).
- If you connected an audio receiver to your DVD Recorder, make sure you chose the correct input setting on the receiver.

Can't advance through a movie

- You can't advance through the opening credits and warning information that appear at the beginning of movies because the disc is programmed to prohibit that action.

Subtitle and/or audio language is not the one selected from the initial setting

- If the subtitle and/or audio language does not exist on the disc, the disc's priority language will be selected instead. Set the subtitle and/or audio language manually through the Info Display or the DVD Recorder's menu system.

Play doesn't begin

- The rating of the title on the disc exceeds the rating limit set in the Ratings Limits menu. Unlock the player and/or change the rating limit in those menus. Go to page 43 for more information.

No forward or reverse scan

- Some discs have sections that prohibit rapid scanning, or title and chapter skip.
- If you're trying to skip through the warning information and credits at the beginning of a movie, you won't be able to. This part of the movie is often programmed to prohibit skipping through it.

Desired angle cannot be changed

- Most discs don't have the multi-camera angle system, and some discs only have multiple angles during certain parts of the movie.

Picture is too tall and thin

- Change the *Screen Format* in the menu system. Go to page 42 for more information.

Picture is too short and wide

- Change the *Screen Format* in the menu system. Go to page 42 for more information.

Disc I recorded won't play in another DVD player

- If it's a DVD+R disc, make sure you finalize the disc (p. 41).
- Some DVD players won't play DVD+R and/or DVD+RW discs. Check the DVD player's manual.

Recording/Copying Problems

Not enough space on the DVD+R or DVD+RW disc

- To get more recording time, you can change the Recording Quality setting (page 45).

Won't record

- You can't record content that is copy-protected. If a message appears notifying you that you can't record the material, press CLEAR on the remote to remove the message from the screen.
- Make sure you've inserted a DVD+R or DVD+RW disc.
- Make sure the disc isn't locked, which protects contents of disc but prevents recording.

Not enough space on the DVD+R or DVD+RW disc

- To get more recording time, you can change the Recording Quality setting (page 45)

REMOTE CONTROL

Remote won't work

- You might be in the wrong mode. To operate your DVD Recorder, press the DVD button on the remote before you press any other buttons. If you're operating the TV, press the TV button first, etc. (this remote operates most RCA, GE, and Proscan TVs and satellite receivers, and you can program it to operate other brands of televisions).
- Insert new batteries in the remote.
- Operate the remote control at a distance of no more than 20 feet.
- Remove any obstacles between the remote and the DVD Recorder or other component. If your DVD Recorder is in an entertainment cabinet, the glass doors might obstruct the remote control from operating the DVD Recorder. Open the doors.

Can't program the remote

- The universal remote control that came with your DVD Recorder is already programmed to operate most RCA, GE, and Proscan TVs and satellite receivers. You can program it to operate many other brands and models of TVs, cable boxes, and digital satellite receivers. However, the remote doesn't support all brands and all models of TVs, satellite receivers, and cable boxes so there is a possibility the remote can't be programmed to operate your component. Instructions for programming the remote control are on page 52.

Lost the remote control

- To order a new remote control, go to page 54. The buttons on the front of the DVD Recorder operate the DVD Recorder's basic functions, but you won't be able to use the menu system without the remote control. The buttons on the front of the unit are described on page 17. Also, if you have another RCA, GE, or Proscan brand product with a remote control that has a DVD button, some of the buttons will probably operate this product if you press the DVD button first.

MP3 FILES

The following recommendations can't be taken as a guarantee that the DVD Recorder will play mp3 recordings, or as an assurance of sound quality. Certain technologies and methods for mp3 file recording on CD-R discs prevent optimal playback of these files on your product.

- Make sure the file is a true mp3 file. You can only play true MP3 files in the DVD Recorder — some products use software to compress mp3 files and convert them to other formats such as MPX. Your DVD Recorder won't recognize or play MPX files or other types of converted mp3 files.
- When naming mp3 files, don't exceed 12 characters, and enter .mp3 as the file extension. When using a general name format of: Title.mp3, make sure the title is 8 characters or less, don't use spaces, and don't use special characters (such as =, +, /, %, &, etc.).
- Whatever the real recording capacity of the CD-R, don't use more than 630MB of recording space on the disc.
- Use a decompression transfer rate of at least 128 kb/sec (kilobits/second) when recording mp3 files. Sound quality with mp3 files basically depends on the rate of compression you choose. Getting audio CD quality sound requires an analog/digital sampling rate, that is conversion to mp3 format, of at least 128 kb/sec and up to 160 kb/sec. However, choosing higher rates like 192 kb/sec or more, only rarely give even better sound quality. Conversely, files with sampling rates below 128 kb/sec won't be played.

Can't get to DVD Recorder's main menu

- Press the STOP button until the main menu appears or press the left arrow button to return to the previous menu. If that doesn't work, remove the mp3 disc from the disc tray.

Can't make the Info Display appear

- The Info Display is only available when playing DVD discs, Audio CDs, Video CDs, and watching TV. The Info Display disappears automatically (times out)

Handling Cautions

- Before connecting other components to this DVD Recorder, be sure to turn all components off.
- Don't move the player while a disc is being played. The disc may get scratched or broken, and the player's internal parts may be damaged.
- Don't put any container filled with liquid or any small metal objects on the DVD Recorder.
- Don't put your hand into the disc tray.
- Don't place anything other than the disc in the disc tray.
- Exterior influences such as lightning and static electricity can affect normal operation. If this occurs, turn the unit off and on again with the STANDBY•ON button, or disconnect and then reconnect the AC power cord to the AC power outlet. The unit should operate normally.
- Be sure to remove the disc and turn off the player after use.

Maintenance of Cabinet

For safety reasons, when cleaning the cabinet be sure to disconnect the AC power cord from the AC outlet.

- Do not use benzene, thinner, or other solvents for cleaning.
- Wipe the cabinet with a soft cloth.

Formation of Condensation

- Due to sharp changes in temperature and humidity, condensation may form if warm air comes in contact with any cold parts inside the player.
- When condensation forms inside the player, the player may not operate correctly. If this occurs, leave the player at room temperature until the inside of the player becomes dry and operational.
- If condensation forms on a disc, wipe the disc with a soft, dry cloth by moving the cloth from the center hole toward the outer edge.

Handling Discs

- Don't touch the disc's signal surfaces. Hold by the edges or by one edge and the hole in the center.
- Don't affix labels or adhesive tape to label surfaces. Don't scratch or damage the label.
- Do not use damaged (cracked or warped) discs.

Cleaning Discs

- Dirty discs can cause reduced video and audio performance. Always keep discs clean by wiping them gently with a soft cloth from the inner edge toward the outer perimeter.
- If a disc becomes very dirty, wet a soft cloth in water, wring it out well. Wipe the dirt away gently, and remove any water drops with a dry cloth.
- Do not use record-cleaning sprays or anti-static agents on discs. Also, never clean the discs with benzene, thinner, or other volatile solvents which may cause damage to the disc surface.

Open the door to access the front audio video input jacks (INPUT 2) and the USB port.

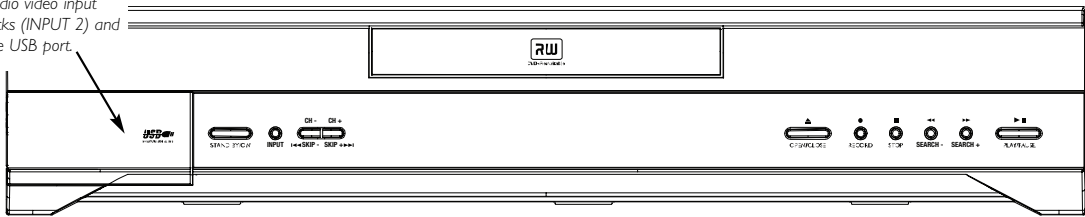

Front of the DVD Recorder

Underneath the door:

INPUT 2: Audio/Video jacks – These Input Jacks are provided for convenience when you are connecting a temporary component, such as a camcorder.

S-VIDEO– If a component you're connecting, such as a camcorder, has an S-Video Output jack connect it to this jack for picture quality that is better than regular video (yellow). Remember, you still have to connect audio cables to hear sound.

USB Input– Connect a compatible Memory Card Reader so you can view and/or copy music or pictures. Go to page 54 to find out which Memory Card Readers are compatible with this product.

STANDBY/ON – Turns the DVD Recorder on and off.

INPUT – Accesses different Video Input Channels (this is the “channel” to which you tune the DVD Recorder so you can see the signal coming from a component that is connected to the different Input Jacks on the DVD Recorder). For example, if your camcorder is connected to the Audio and Video Input jacks on the front of the DVD Recorder (behind the door), you would press the INPUT button until *INPUT 2-Front* appears.

OPEN/CLOSE – Opens and closes the disc tray.

PLAY/PAUSE – Press to begin playback. Pauses playback or recording.

STOP – Stops playback and/or recording.

RECORD – Records content to a DVD disc (DVD+R or DVD+RW discs only).

CH- (channel down) – Goes to the previous channel in the channel list when you're watching TV.

⏮ SKIP – When playing a disc, goes to the beginning of the current chapter or track, unless you're within the first minute of a chapter or the first 15 seconds of a track—then, you'll skip to the beginning of the preceding chapter or track.

CH+ (channel up) – Goes to the next channel in the channel list when you're watching TV.

SKIP ▶▶ – When playing a disc, goes to the beginning of the next title, chapter, or track on a disc (in effect, “skipping” the title, chapter, or track).

⏪ SEARCH ▶▶ – Reverse and fast forward buttons (search backwards or search forwards).

Limited Warranty

What your warranty covers:

- Defects in materials or workmanship.

For how long after your purchase:

- One year from date of purchase for parts and labor.

The warranty period for rental units begins with the first rental or 45 days from date of shipment to the rental firm, whichever comes first.

What we will do:

- Pay any Authorized RCA Service Center the labor charges to repair your DVD Recorder.
- Pay any Authorized RCA Service Center for the new or, at our option, refurbished replacement parts required to repair your DVD Recorder.

How you get service:

- Take your DVD Recorder to any Authorized RCA Service Center. To identify your nearest Authorized RCA Service Center, ask your dealer, look in the Yellow Pages, or call 1-800-336-1900.
- Proof of purchase in the form of a bill of sale or receipted invoice which is evidence that the product is within the warranty period must be presented to obtain warranty service. For rental firms, proof of first rental is also required.
- Pick up your DVD Recorder when repairs are completed.

What your warranty does not cover:

- Acts of nature, such as but not limited to lightning damage.
- Adjustment of customer controls.
- Damage from misuse or neglect.
- A unit that has been modified or incorporated into other products or is used for institutional or other commercial purposes.
- Batteries.
- Units purchased or serviced outside the U.S.A.

Product Registration:

- Please complete the online Product Registration on RCA.com or complete and mail the Product Registration Card packed with your unit. It will make it easier to contact you should it ever be necessary. The return of the card is not required for warranty coverage.

Limitation of Warranty:

- THE WARRANTY STATED ABOVE IS THE ONLY WARRANTY APPLICABLE TO THIS PRODUCT. ALL OTHER WARRANTIES, EXPRESS OR IMPLIED (INCLUDING ALL IMPLIED WARRANTIES OF MERCHANTABILITY OR FITNESS FOR A PARTICULAR PURPOSE) ARE HEREBY DISCLAIMED. NO VERBAL OR WRITTEN INFORMATION GIVEN BY THOMSON INC., ITS AGENTS OR EMPLOYEES SHALL CREATE A WARRANTY OR IN ANY WAY INCREASE THE SCOPE OF THIS WARRANTY.
- REPAIR OR REPLACEMENT AS PROVIDED UNDER THIS WARRANTY IS THE EXCLUSIVE REMEDY OF THE CONSUMER. THOMSON INC. SHALL NOT BE LIABLE FOR INCIDENTAL OR CONSEQUENTIAL DAMAGES RESULTING FROM THE USE OF THIS PRODUCT OR ARISING OUT OF ANY BREACH OF ANY EXPRESS OR IMPLIED WARRANTY ON THIS PRODUCT. THIS DISCLAIMER OF WARRANTIES AND LIMITED WARRANTY ARE GOVERNED BY THE LAWS OF THE STATE OF INDIANA. EXCEPT TO THE EXTENT PROHIBITED BY APPLICABLE LAW, ANY IMPLIED WARRANTY OF MERCHANTABILITY OR FITNESS FOR A PARTICULAR PURPOSE ON THIS PRODUCT IS LIMITED TO THE APPLICABLE WARRANTY PERIOD SET FORTH ABOVE.

How state law relates to warranty:

- Some states do not allow the exclusion nor limitation of incidental or consequential damages, or limitations on how long an implied warranty lasts, so the above limitations or exclusions may not apply to you.
- This warranty gives you specific legal rights, and you also may have other rights that vary from state to state.

If you purchased your product outside the United States:

- This warranty does not apply. See your dealer for warranty information.

Accessory Information

There are various accessories available to complement your DVD Recorder. **Prices are subject to change without notice. All accessories are subject to availability.**

A shipping and handling fee will be charged upon ordering, and we are required by law to collect the appropriate sales tax for each individual state, country, and locality to which the merchandise is being sent.

For more information about accessories, go on-line to www.rca.com



Optical Plug to Optical Plug for Optical Audio connection to a compatible receiver.
3 feet (part number DV3); price \$15.95
6 feet (part number DV6); price \$19.95

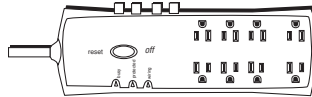

Surge Protector (part number SCTV4000C), price \$49.95



Optical Plug to Mini Plug
3 feet (part number DV3M); price \$15.95
6 feet (part number DV6M); price \$19.95

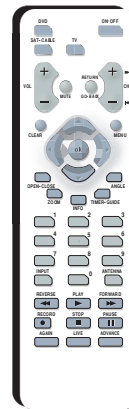

Remote Control (RCR31 IDBM1) part number 261387

TMC100 Reader (not shown), \$34.95

Basic reader for SD/MMC memory cards. Enables you to connect to the DVD Recorder's USB port to play JPEG files or mp3 files on the DVD Recorder, or copy them to a DVD+RW disc.

TMC150 Reader (not shown), call for price

Enables you to connect to the DVD Recorder's USB port to play JPEG files or mp3 files on the DVD Recorder, or copy them to a DVD+RW disc.

Other compatible card readers are available at retailers. Your DVD Recorder is compatible with current Class Compatible USB Mass Storage Devices that are USB 1.1

How to Order

To place an order by phone, have your Visa, MasterCard, or Discover Card ready and call the toll-free number listed below.

Use this number only to place an order for accessory items.

1-800-338-0376

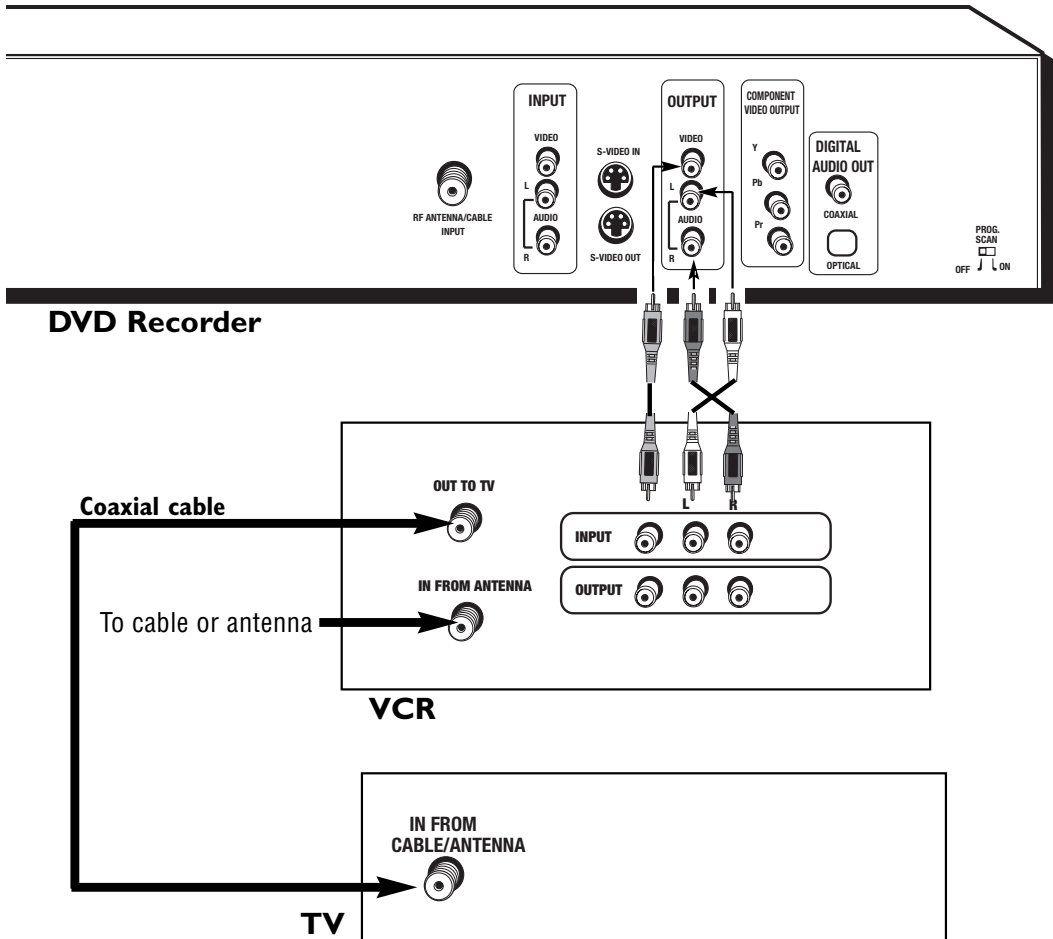

DVD Recorder

Coaxial cable

To cable or antenna

VCR

TV

Copying content from a DVD+R or DVD+RW disc to a VCR videocassette

The following instructions are provided for a general connection in case you might want to copy content from a disc you recorded to a VCR videocassette. The back of your TV and VCR probably don't exactly match the ones shown here. In general, you just need to connect the DVD Recorder's Output jacks to the VCR's Input Jacks. Also, you need to be able to see what your copying, so the TV needs to be connected.

1. Connect the DVD Recorder to the VCR. Connect a set of audio/video cables to the DVD Recorder's OUTPUT VIDEO (yellow), AUDIO L (white), and AUDIO R (red) jacks, to the VCR's Input Jacks (sometimes labeled VIDEO and AUDIO L and R).
2. Connect the VCR to the TV. Connect an RF coaxial cable to the OUT TO TV jack on the VCR and to the IN FROM CABLE/ANTENNA jack on the TV.
3. Make sure all of the components (TV, VCR, and DVD Recorder) are plugged into working power outlets.
4. Turn on all of the components.
5. Tune the TV to channel 3 or 4 (depending on whether the VCR's 3/4 switch is set to 3 or 4) because the VCR is connected to the TV with an RF Coaxial Cable.
6. Change the channel on the VCR to its Video Input Channel (sometimes called LINE or LINE INPUT) because the DVD Recorder is connected to the VCR's INPUT jacks.
7. Insert the DVD+R or DVD+RW disc you want to copy to a videocassette into the DVD Recorder.
8. Insert a working videocassette tape into the VCR.
9. Press the RECORD button on the VCR.
10. Start playback on DVD Recorder.

NOTE: Copy-protected content, such as pre-recorded DVD titles, cannot be recorded, copied, or duplicated.

Chapter 6: Additional Information

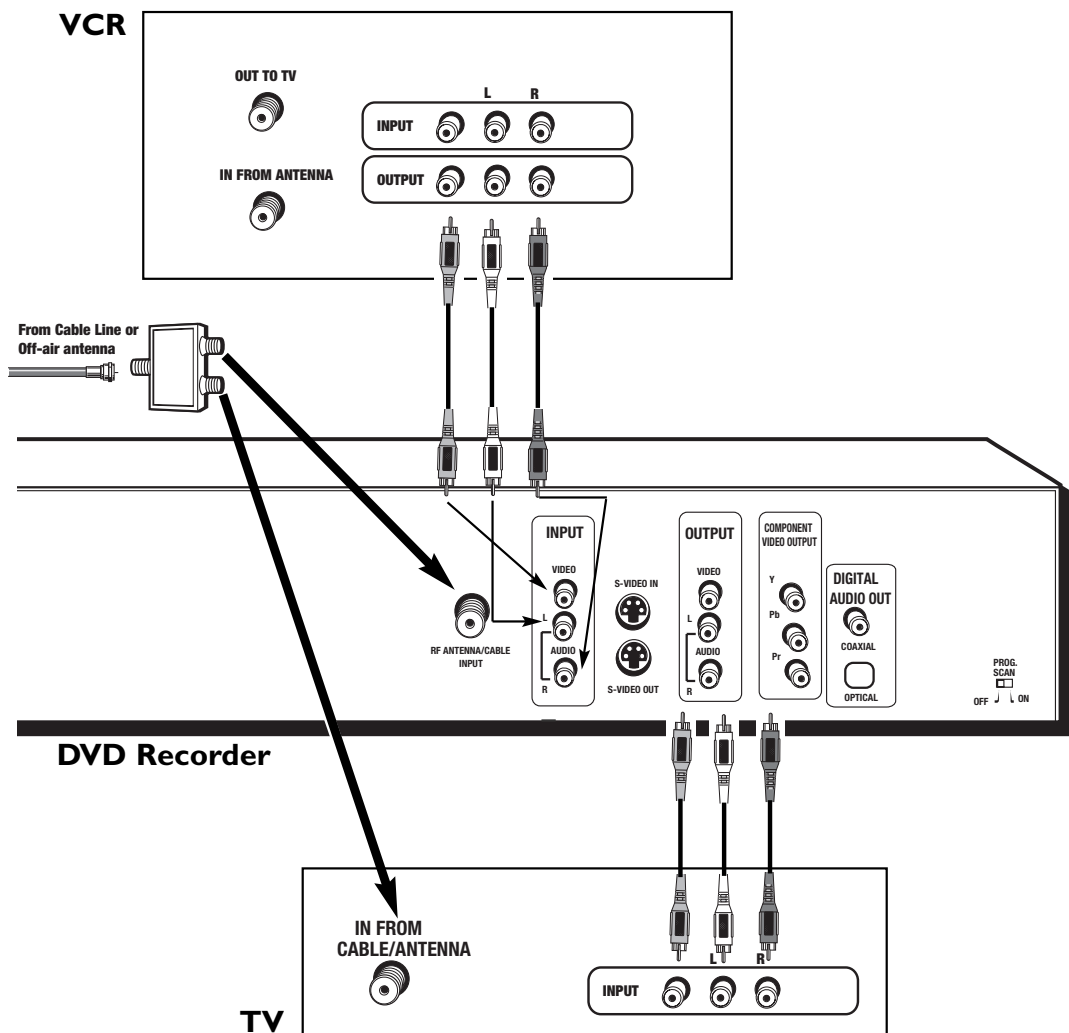

Copying content from a VCR videocassette to a DVD+R or DVD+RW disc

The following instructions are provided for a general connection in case you want to copy your VCR videocassettes to disc. The back of your TV and VCR probably don't exactly match the ones shown here. In general, you just need to connect the VCR's Output Jacks to the DVD Recorder's Input Jacks. Also, you need to be able to see what your copying, so the TV needs to be connected.

1. Connect the DVD Recorder to the VCR. Connect a set of audio/video cables to the DVD Recorder's INPUT VIDEO (yellow), AUDIO L (white), and AUDIO R (red) jacks, to the VCR's OUTPUT Jacks (sometimes labeled OUTPUT VIDEO and AUDIO L and R).
2. Connect the DVD Recorder to the TV. Connect a set of audio/video cables to the DVD Recorder's OUTPUT VIDEO (yellow), AUDIO L (white), and AUDIO R (red) jacks, to the TV's INPUT Jacks (sometimes labeled INPUT VIDEO, L and R).
3. Connect the signal from your cable or off-air antenna to the 2 Way Splitter (provided)— the end with one connector.
4. Use the RF Coaxial Cable (provided) to connect the 2 Way Splitter to the DVD Recorder's RF ANTENNA/CABLE INPUT jack.
5. Connect another RF Coaxial Cable (not provided) to the other connector on the 2 Way Splitter. Connect the other end of this cable to the TV's RF Input jack (sometimes labeled IN FROM CABLE/ANTENNA).
6. Turn on all of the components.
7. Tune the TV to the Video Input Channel that corresponds with the Audio/Video Input jacks you used to connect it to the DVD Recorder.
8. Insert the videocassette you want to record onto disc into the VCR, and cue it up.
9. Tune the DVD Recorder to its Video Input Channel (press the DVD button and then the INPUT button on the DVD Recorder's remote control).
10. Put a DVD+R or DVD+RW disc into the DVD Recorder, and press RECORD.
11. Press PLAY on the VCR.
12. When you're finished recording, press STOP on the DVD Recorder and tune the TV to its Video Input Channel so it displays content playing in the DVD Recorder.
13. Make sure the content copied by playing the disc.

Visit our website at www.rca.com

Please do not send any products to the Indianapolis address listed in this manual or on the carton. This will only add delays in service for your product.

Thomson Inc.
10330 North Meridian Street
Indianapolis, IN 46290

©2004 Thomson Inc.
Trademark(s) ® Registered
Marca(s) Registrada(s)
Printed in Thailand
TOCOM 16357160

THOMSON

THOMSON 

Free Manuals Download Website

<http://myh66.com>

<http://usermanuals.us>

<http://www.somanuals.com>

<http://www.4manuals.cc>

<http://www.manual-lib.com>

<http://www.404manual.com>

<http://www.luxmanual.com>

<http://aubethermostatmanual.com>

Golf course search by state

<http://golfingnear.com>

Email search by domain

<http://emailbydomain.com>

Auto manuals search

<http://auto.somanuals.com>

TV manuals search

<http://tv.somanuals.com>