

# **RCA**

## **DVD Player User's Guide**

Changing Entertainment. Again.



### **RC5920P**

# Important Information

## WARNING

RISK OF ELECTRIC SHOCK  
DO NOT OPEN

To reduce the risk of electric shock, do not remove cover (or back). No user serviceable parts inside. Refer servicing to qualified service personnel.



This symbol indicates "dangerous voltage" inside the product that presents a risk of electric shock or personal injury.



This symbol indicates important instructions accompanying the product.

## FCC NOTE:

This equipment has been tested and found to comply with the limits for a Class B digital device, pursuant to Part 15 of the FCC rules. These limits are designed to provide reasonable protection against harmful interference in a residential installation. This equipment generates, uses and can radiate radio frequency energy and, if not installed and used in accordance with the instructions, may cause harmful interference to radio communications. However, there is no guarantee that interference will not occur in a particular installation. If this equipment does cause harmful interference to radio or television reception, which can be determined by turning the equipment off and on, the user is encouraged to try to correct the interference by one or more of the following measures.

- Reorient or relocate the receiving antenna.
- Increase the separation between the equipment and receiver.
- Connect this equipment into an outlet on a circuit different from that to which the receiver is connected.
- Consult the dealer or an experienced radio/TV technician for help.

This class B digital apparatus meets all requirements of the Canadian Interference--Causing Equipment Regulations.

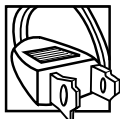

**Caution:** To prevent electric shock, match wide blade of plug to wide slot, fully insert.

**Attention:** Pour éviter les chocs électriques, introduire la lame la plus large de la fiche dans la borne correspondante de la prise et pousser jusqu'au fond.

Refer to the identification/rating label located on the back panel of your product for its proper operating voltage.

## WARNING

To reduce the risk of fire or electric shock, do not expose this DVD player to rain or moisture. No objects filled with liquids, such as vases, shall be placed on the apparatus.

## CAUTION

THIS PRODUCT UTILIZES A LASER. USE OF CONTROLS OR ADJUSTMENTS OR PERFORMANCE OF PROCEDURES OTHER THAN THOSE SPECIFIED HEREIN MAY RESULT IN HAZARDOUS RADIATION EXPOSURE. DO NOT OPEN COVERS AND DO NOT REPAIR YOURSELF. REFER SERVICING TO QUALIFIED PERSONNEL.

## CAUTION

FCC Regulations state that unauthorized changes or modifications to this equipment may void the user's authority to operate it.

### Note:

This DVD player is designed and manufactured to respond to the Region Management Information. If the Region number of a DVD disc does not correspond to the Region number of this DVD player, this DVD player cannot play the disc. The Region number for this DVD player is Region No 1.

### Note:

This device is protected by U.S. patent numbers 4,631,603 and 4,577,216 and 4,819,098 and other intellectual property rights. The use of Macrovision's copy protection technology in the device must be authorized by Macrovision and is intended for home and other limited pay-per-view uses only, unless otherwise authorized in writing by Macrovision. Reverse engineering or disassembly is prohibited.

**CLASS 1  
LASER  
PRODUCT**

## Product Registration Information

Keep your sales receipt to obtain warranty parts and service and for proof of purchase. Attach it here and record the serial number in case you need it. The number is located on the player.

Model No. **RC5920P** \_\_\_\_\_

Serial No. \_\_\_\_\_

Purchase Date: \_\_\_\_\_

Dealer/Address/Phone: \_\_\_\_\_

## Chapter 1: Connections & Setup

Things to Consider Before You Connect .....	6
Choose Your Connection .....	7
Cables Needed to Connect Components to Your TV .....	7
Explanation of Input Jacks and Cables .....	8
DVD Player + TV with Audio/Video Input Jacks .....	9
DVD Player + TV + VCR .....	11
DVD Player + TV + Dolby Digital or DTS Receiver .....	13
DVD Player + TV + Dolby Pro Logic or Stereo Receiver .....	15
DVD Player + TV + VCR + Satellite Receiver .....	17
The Jacks on the Back of the DVD Player .....	18
Front Panel Controls .....	19
Installing Batteries in the Remote .....	20
Important Battery Information .....	20
Turn on the TV and DVD Player .....	20
How to Find Your TV's Video Input Channel .....	21
How to Move Around the DVD Player's Menu System .....	22
A Quick Tour of The Remote .....	23
Component Buttons .....	23
DVD Buttons .....	23
Programming the Remote to Operate Your TV .....	25
Testing the remote .....	25
Entering Codes .....	25
Code List .....	26

## Chapter 2: Playing DVDs

Regional Coding .....	28
Using Different Menus .....	28
Types of Discs Your Player will Play .....	28
Loading and Playing Discs .....	29
Selecting Discs from the Disc Tray .....	29
Using a Disc Menu .....	30
Using the On-Screen Info Display .....	31
Selecting a Title .....	31
Selecting a Chapter .....	32
Using Subtitles .....	32
Selecting the Subtitle Language .....	32
Changing the Audio Language .....	33
Changing the Camera Angle .....	33
Using Bookmarks .....	34

Manufactured under license from Dolby Laboratories. "Dolby" and the double-D symbol are trademarks of Dolby Laboratories. Confidential unpublished works. ©1992-1997 Dolby Laboratories, Inc. All rights reserved.

DTS is a registered trademark of Digital Home Theater Systems, Inc.

## Chapter 2: Playing DVDs *(continued)*

<b>Time indicator</b> .....	<b>34</b>
<b>The Repeat Feature</b> .....	<b>34</b>
To Use Disc or Track Repeat: .....	34
A•B Repeat .....	35
How to Cancel Repeat .....	35
<b>Selecting a Play Mode</b> .....	<b>36</b>
Random Play .....	36
Programmed Play .....	36
Editing a Program .....	36
<b>Disc Playback Features Using the Remote</b> .....	<b>37</b>
<b>What is a Video CD?</b> .....	<b>38</b>

## Chapter 3: Playing Audio CDs and MP3 Discs

<b>Using the Info Display</b> .....	<b>40</b>
Selecting a Specific Track .....	40
<b>Using IntroScan™</b> .....	<b>41</b>
<b>Using Bookmarks</b> .....	<b>41</b>
Storing a Bookmark .....	41
Using a Bookmark .....	41
<b>The Time Display</b> .....	<b>42</b>
<b>Selecting a Play Mode</b> .....	<b>42</b>
Random Play .....	42
Programmed Play .....	43
Editing a Program .....	43
<b>The Repeat Feature</b> .....	<b>44</b>
To Use Disc or Track Repeat: .....	44
A•B Repeat .....	44
How to Cancel Repeat .....	44
<b>Playing MP3 Discs</b> .....	<b>45</b>
What is MP3? .....	45
Obtaining MP3 files .....	45
Creating an MP3 Disc on Your Computer .....	45
<b>The MP3 Display</b> .....	<b>46</b>
Selecting Folders and Songs .....	46
Skipping Songs .....	46
Creating a Play List .....	47

## Chapter 4: Using the DVD Player's Menu System

<b>The DVD Player Menu System</b> .....	<b>50</b>
Two Types of Menu Items: Path and Action .....	50
<b>The Audio Language Preference</b> .....	<b>51</b>
<b>Changing the Subtitle Language Preference</b> .....	<b>52</b>
<b>Changing the Player Menus Language Preferences</b> .....	<b>52</b>

# Table of Contents

---

## Chapter 4: Using the DVD Player's Menu System *(continued)*

<b>Creating a Password and Setting Ratings</b> .....	<b>53</b>
Creating a Password .....	53
Changing your Password .....	53
Clearing Your Password .....	53
Setting the Rating .....	54
<b>TV Aspect</b> .....	<b>55</b>
<b>Dynamic Range</b> .....	<b>56</b>
<b>Digital Audio Out</b> .....	<b>56</b>
<b>Linear PCM</b> .....	<b>56</b>
<b>Language Code List</b> .....	<b>57</b>

## Chapter 5: Other Information

<b>Troubleshooting</b> .....	<b>60</b>
<b>Handling Cautions</b> .....	<b>63</b>
Maintenance of Cabinet .....	63
Formation of Condensation .....	63
Handling Discs .....	63
Cleaning Discs .....	63
<b>Limited Warranty</b> .....	<b>64</b>
<b>Accessories and Order Form</b> .....	<b>67</b>
<b>Index</b> .....	<b>69</b>

**This page intentionally left blank.**

# Connections & Setup

## Chapter Overview:

- Things to Consider Before You Connect
- Choose Your Connection
- Explanation of Cables and Jacks
- The Jacks on the Back of the DVD Player
- The Front Panel Controls
- Installing Batteries in the Remote
- How to Find Your TV's Video Input Channel
- How to Move Around the DVD Player's Menu System
- The Remote Control

Changing Entertainment. Again.



## Things to Consider Before You Connect

### Protect Against Power Surges

- Connect all components before you plug any of their power cords into the wall outlet.
- Turn off the TV and/or components before you connect or disconnect any cables.
- Make sure all antennas and cables are properly grounded. Refer to the Important Safeguards sheet packed with your DVD player.

### Protect Components from Overheating

- Don't block ventilation holes on any of the components. Arrange the components so that air can circulate freely.
- Don't stack components.
- When you place components in a stand, make sure you allow adequate ventilation.
- If you connect an audio receiver or amplifier, place it on the top shelf so the heated air from it won't flow around other components.

### Position Cables Properly to Avoid Audio Interference

- Insert each cable firmly into the designated jack.
- If you place components above the TV, route all cables down the side of the back of the TV instead of straight down the middle of the back of the TV.
- If your antenna uses 300-ohm twin lead cables, do not coil the cables. Also, keep the twin lead cables away from audio/video cables.

### Connection Pictures

Audio/video cables are usually bundled together. For better visibility, the connection pictures in this book show each cable separately (audio left, audio right, and video).

### Types of Discs Your DVD Player will Play



- DVD video discs – DVD video discs contain high quality picture and sound content.
- Audio discs – Audio CDs contain musical or sound content only.
- Video CD discs – Like DVD video discs, Video CDs contain picture and sound content. The difference is the amount of information that can be stored on the disc.
- CD-R discs, DVD+RW, DVD-RW, DVD-R, DVD-ROM (with movie information)



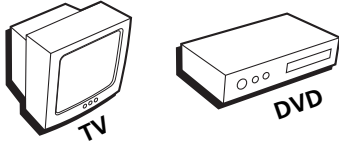

## Choose Your Connection

There are several ways to connect your DVD player. Please use the following chart to determine which connection is best for you. Turn to the appropriate page and connect your DVD player.

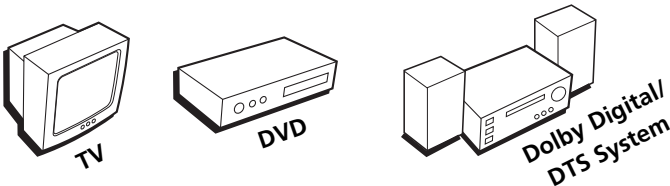
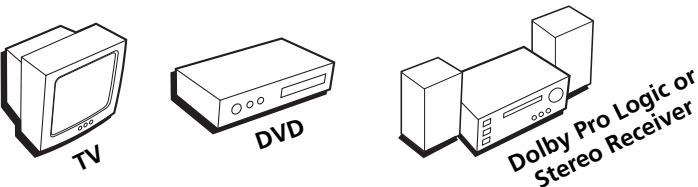
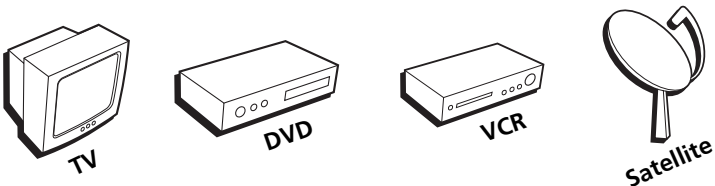
Components	Cables Needed	Connection	Go to...
	<ul style="list-style-type: none"> <li>• Coaxial</li> <li>• Audio/video</li> <li>• S-Video</li> <li>• Component video (optional)</li> </ul>	TV + DVD	page 9
	<ul style="list-style-type: none"> <li>• Coaxial</li> <li>• Audio/video</li> <li>• S-Video</li> <li>• Component video (optional)</li> </ul>	TV + DVD + VCR	page 11
	<ul style="list-style-type: none"> <li>• Coaxial</li> <li>• Audio/video</li> <li>• S-Video</li> <li>• Optical Digital</li> <li>• Component video (optional)</li> </ul>	TV + DVD + Dolby Digital	page 13
	<ul style="list-style-type: none"> <li>• Coaxial</li> <li>• Audio/video</li> <li>• S-Video</li> <li>• Component video (optional)</li> </ul>	TV + DVD + Dolby Pro Logic or Stereo Receiver	page 15
	<ul style="list-style-type: none"> <li>• Coaxial</li> <li>• Audio/video</li> <li>• S-Video</li> <li>• Component video (optional)</li> </ul>	TV + DVD + VCR + Satellite	page 17

## Cables Needed to Connect Components to Your TV

The pictures below show the cables needed for the connections represented in this book.

**Note:** Audio/Video cables (A/V cables for short) are usually sold as a bundled set, but the connection pictures in this book show each cable separately for better visibility.

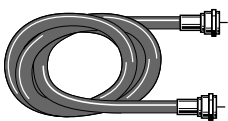

RF coaxial cable

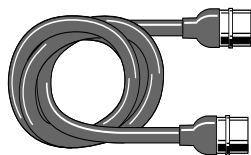

S-Video cable

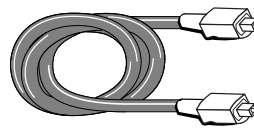

Optical digital audio cable

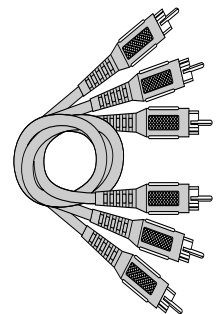

Audio/Video cables

## Explanation of Input Jacks and Cables

This section describes the jacks and cables you can use to make connections (some of the cables may not be provided with your DVD player). There are several ways to connect components to your DVD player.

Different jacks and cables provide a different level of performance (this book categorizes these levels as Excellent, Very Good, and Good). It's important to remember, we're talking about degrees of picture improvement for comparison. If your component has component video, S-VIDEO, composite video (VIDEO, AUDIO Left and Right); component video would be considered excellent, S-Video would be very good, and composite video would be good.

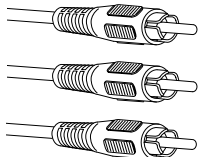

**Component Video Cables and Jacks**

### Component Video (Y P<sub>B</sub> P<sub>R</sub>) Jacks and Cables— Excellent Video Quality

The Y P<sub>B</sub> P<sub>R</sub> jacks allow you to connect to a TV that has Component or progressive scan video jacks. This connection provides optimum picture quality because the video is separated into three signals. To ensure maximum picture quality, use three video-grade cables for the connection.

**Note:** Also, remember to connect the left and right audio cables because the Y P<sub>B</sub> P<sub>R</sub> jacks and cables carry only the picture signal, not the sound.

### S-Video Jack and Cable — Very Good Video Quality

The S-Video (separate video) jack provides better picture quality than the regular video jacks (labeled INPUT1 VIDEO; INPUT2 VIDEO; INPUT3 VIDEO) because the color (chrominance, also called chroma) part of the signal is separated from the black and white (luminance) part of the picture.

If your TV has an S-VIDEO jack, connect the player to the TV with an S-Video cable for a better quality picture.

**Note:** Remember to connect the left and right audio cables because the S-Video cable carries only the picture signal, not the sound.

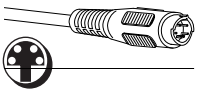

**S-Video Cable and Jack**

### Digital Audio Out Jack and Optical Cable — Excellent Audio Quality

The optical cable is used to connect a Dolby Digital receiver. If you own a Dolby Digital receiver that uses an optical cable-type input, you can use an optical cable for the best sound quality.

**Note:** This DVD player's optical digital output jack fully complies with the international standard governing this type of jack (IEC958), and is designed for connection to a Dolby Digital (AC-3<sup>®</sup> or PCM) receiver or Dolby Digital (AC-3 or PCM) decoder. Older equipment, some of which is not fully compliant with IEC958, may not be compatible with the Dolby Digital bitstream. Such a connection using anything other than Dolby Digital AC-3 or PCM receiver or decoder could create a high noise level, causing damage to headphones or speakers.

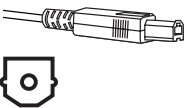

**Digital Audio Out Cable and Jack**

### Audio/Video Jacks and Cables (RCA-type) — Very Good Video and Audio

These jacks are used for most audio/video connections between components. The audio/video jacks are often color coded (yellow for video, red for right audio, and white for left audio). This is also called composite video.

**Note:** If components you are connecting to have only one input for audio (mono), connect it to the left (white L/Mono) audio jack and don't connect the right audio part of the cable.

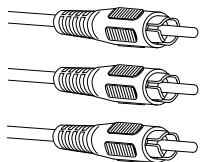

**Audio/Video Cables and Jacks**

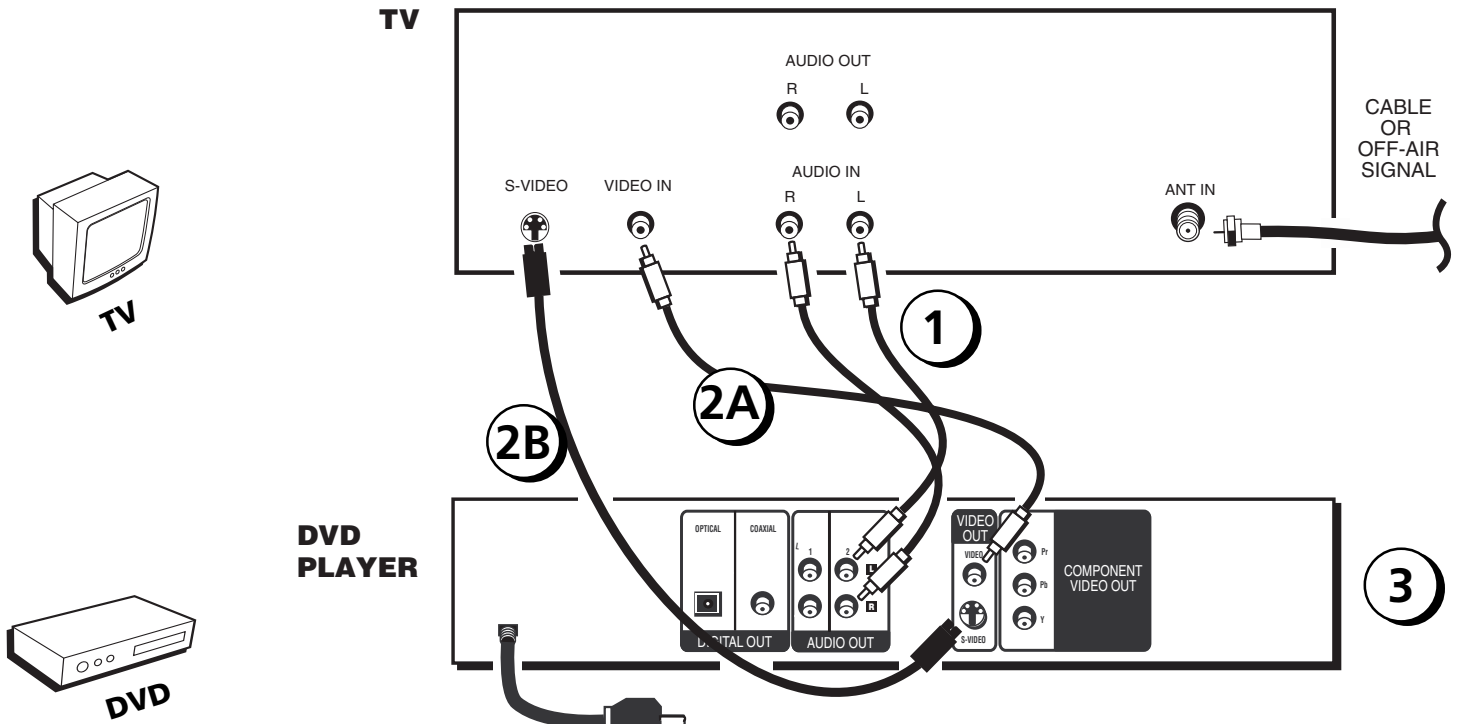

## DVD Player + TV with Audio/Video Input Jacks

1. Connect the audio cables to the AUDIO OUT L (left – white) and R (right – red) jacks on the back of your DVD Player, and to the corresponding Audio Input jacks on your TV.
2. Connect the video cable.
  - A. **Basic video connection** – Connect the video cable (yellow) to the VIDEO OUT jack on the back of your DVD Player, and to the Video Input jack on your TV.
  - OR**
  - B. **S-Video** – (optional) If your TV has an S-Video Input jack, connect the S-Video cable to the S-VIDEO OUT jack on the back of your DVD Player and to the S-Video jack on your TV. If your TV doesn't have S-Video, use the basic video connection listed above.
  - OR**
  - C. **Component video** (optional, not shown in illustration) – If your TV has component video (Y, P<sub>B</sub>, and P<sub>R</sub> jacks) use video-grade cables for the Y, P<sub>B</sub>, and P<sub>R</sub> connections. Note that it is essential to match the color-coded connectors with a compatible TV. If your TV doesn't have component video, use the basic video connection or the S-Video connection listed above.
3. Plug in the AC power cord into an AC outlet.

**Note:** Your cable or off-air connection to the television should not be affected by this connection. Connect your cable or off-air antenna to your television as you normally would. You may need to consult your television manual for details.

**Go to page 20**

# Connections & Setup

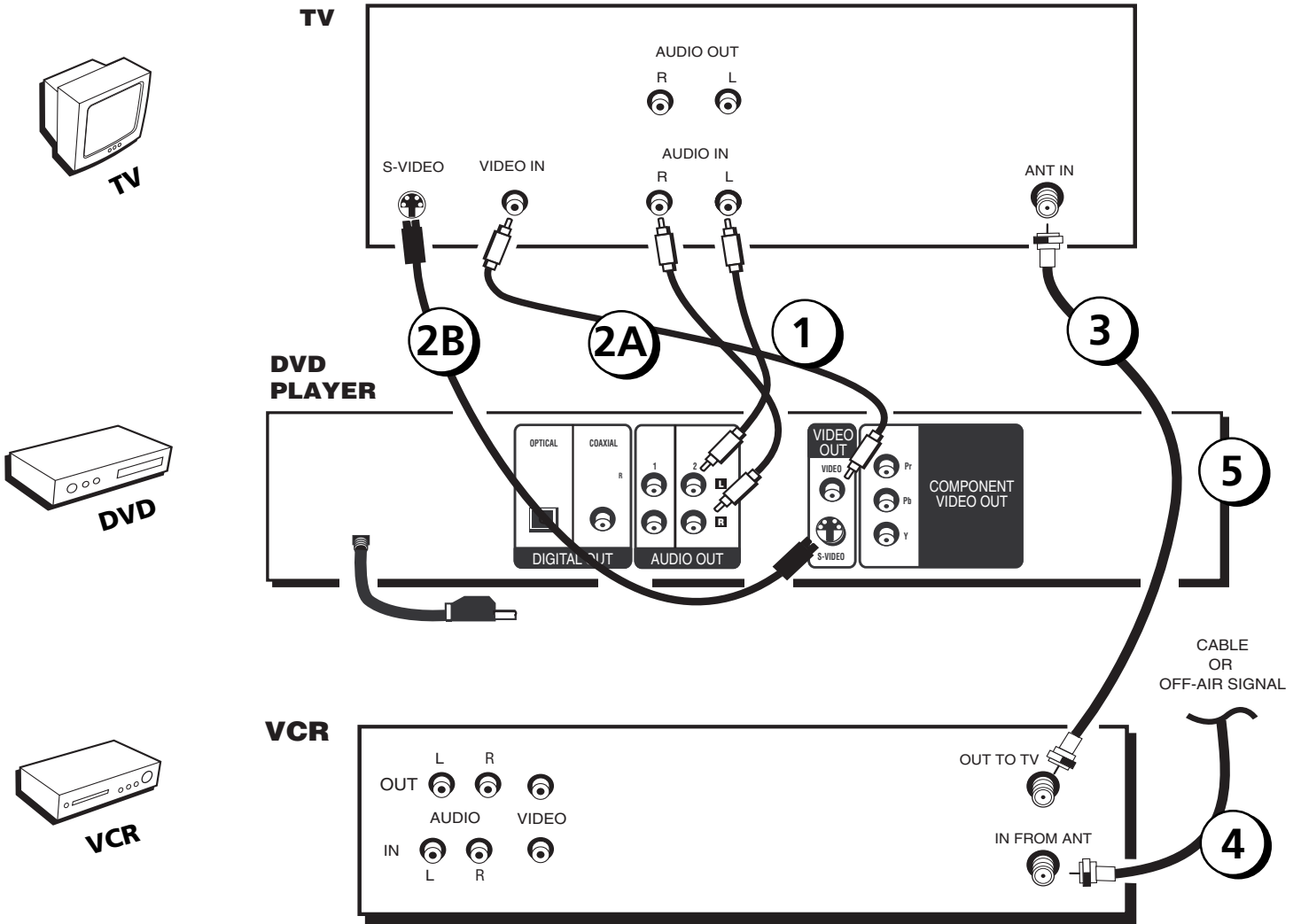

## DVD Player + TV + VCR

1. Connect the audio cables to the AUDIO OUT L (left – white) and R (right – red) jacks on the back of your DVD Player, and to the corresponding Audio Input jacks on your TV.

2. Connect the video cable.

A. **Basic video connection** – Connect the video cable (yellow) to the VIDEO OUT jack on the back of your DVD Player, and to the Video Input jack on your TV.

**OR**

B. **S-Video** – (optional) If your TV has an S-Video Input jack, connect the S-Video cable to the S-VIDEO OUT jack on the back of your DVD Player and to the S-Video jack on your TV. If your TV doesn't have S-Video, use the basic video connection listed above.

**OR**

C. **Component video** (optional, not shown in illustration) – If your TV has component video (Y, P<sub>B</sub>, and P<sub>R</sub> jacks) use video-grade cables for the Y, P<sub>B</sub>, and P<sub>R</sub> connections. Note that it is essential to match the color coded connectors with a compatible TV. If your TV doesn't have component video, use the basic video connection or the S-Video connection listed above.

3. Connect a coaxial cable to the antenna output jack on the VCR and to the antenna input jack on the television.

4. Connect the antenna or cable to the Antenna Input jack on the VCR.

5. Plug in the AC power cord into an AC outlet.

**Go to page 20**

# Connections & Setup

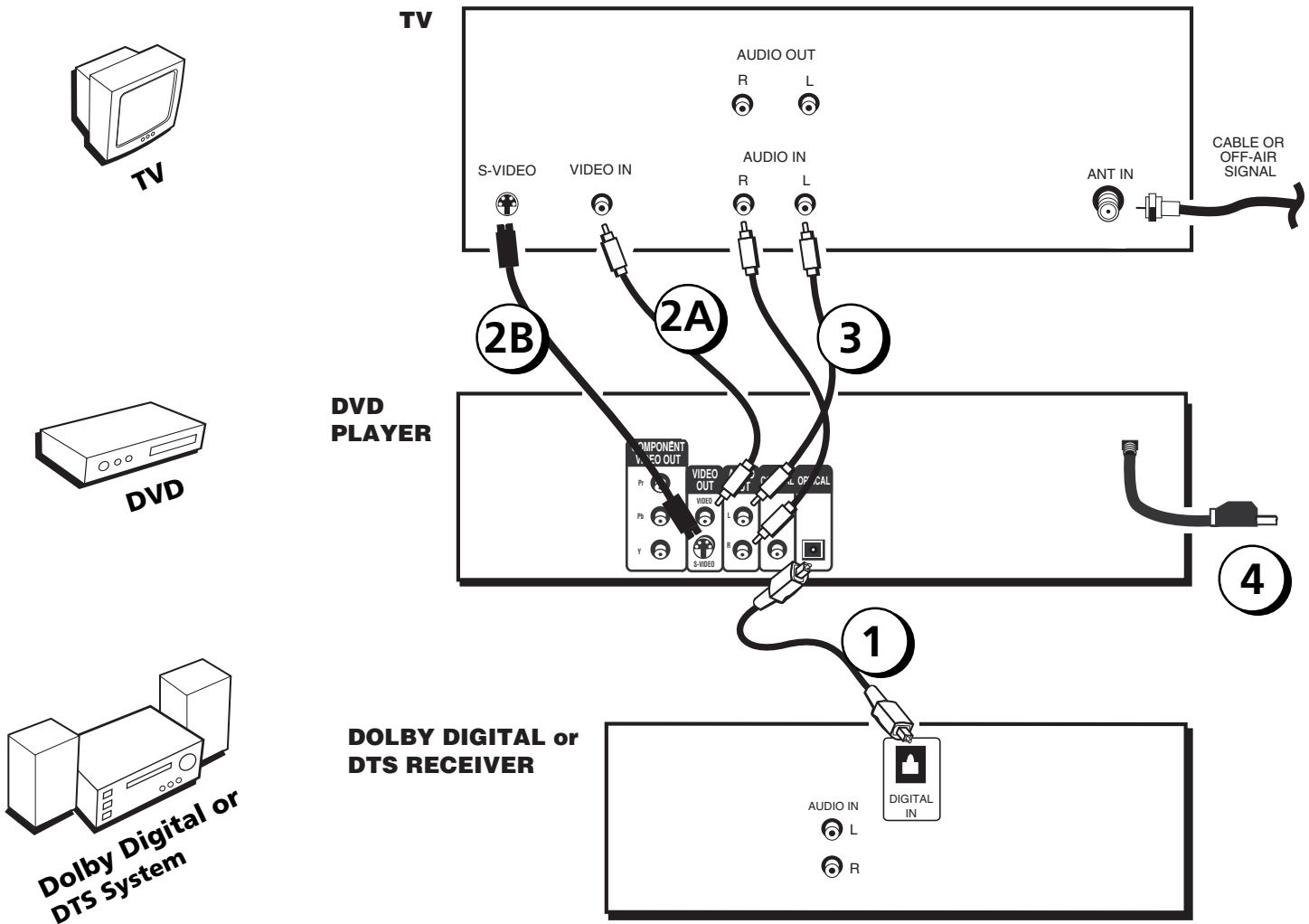

## Dolby Digital® and DTS®

Both Dolby Digital and DTS are audio formats used to record 5.1-channel audio signals onto the digital track of film (while the film is being made). Both of these formats provide up to six separate channels: left, right, center, left rear, right rear, and common subwoofer.

The disc will play 5.1-channel sound only if you've connected a DTS or Dolby Digital receiver or decoder and if the original movie the disc was recorded from was encoded in the Dolby Digital or DTS format.

### Please Read This Before Using the OPTICAL or COAXIAL Jacks!

This player's digital output jack is designed for a connection to a Dolby Digital or DTS receiver or decoder. This player has two types of digital audio out jacks: OPTICAL and COAXIAL. Use the jack (and the corresponding cable) that matches the type of OPTICAL IN or COAXIAL IN jack your receiver or decoder has.

Older digital equipment may not be compatible with the Dolby Digital bitstream. Such a connection can create a high level of noise that may be harmful to your ears, and could damage headphones or speakers.

It is important to choose the correct Digital Output setting in the DVD Player's Digital Audio Out menu, especially when you use the OPTICAL OR COAXIAL jack. For more information, see chapter 4.

## DVD Player + TV + Dolby Digital or DTS Receiver

### To Connect the DVD Player

1. If you have a Dolby Digital or DTS receiver, insert an optical digital cable (not provided) to the OPTICAL or COAXIAL jack on the DVD player to the Digital Input jack on the back of the receiver. You must also set the Digital Output setting in the Digital Audio Out menu (see chapter 4).

**Note:** The connection illustration on the left shows a digital optical cable. If your receiver has a coaxial AUDIO IN jack, use a shielded (coaxial) video or audio cable with RCA plugs at both ends to connect the coaxial digital audio jacks on the DVD player and the A/V receiver.

2. Connect the video cable.

A. **Basic video connection** – Connect the video cable (yellow) to the VIDEO OUT jack on the back of your DVD Player, and to the Video Input jack on your TV.

**OR**

B. **S-Video** – (optional) If your TV has an S-Video Input jack, connect the S-Video cable to the S-VIDEO OUT jack on the back of your DVD Player and to the S-Video jack on your TV. If your TV doesn't have S-Video, use the basic video connection listed above.

**OR**

C. **Component video** (optional, not shown in illustration) – If your TV has component video (Y, P<sub>B</sub>, and P<sub>R</sub> jacks) use video-grade cables for the Y, P<sub>B</sub>, and P<sub>R</sub> connections. Note that it is essential to match the color coded connectors with a compatible TV. If your TV doesn't have component video, use the basic video connection or the S-Video connection listed above.

3. **Down Mix Audio** (optional) – Connect the second set of AUDIO OUT jacks on the back of the DVD player to the AUDIO IN jacks on the back of the TV. This allows you to listen to discs without going through the receiver. For example, if it's late at night and you want to listen to a disc without 5.1-channel sound on, you can turn off the receiver and listen to the disc through the TV speakers.
4. Plug in the AC power cord into an AC outlet.

**Go to page 20**

Manufactured under license from Dolby Laboratories. "Dolby" and the double-D symbol are trademarks of Dolby Laboratories. Confidential unpublished works. ©1992-1997 Dolby Laboratories, Inc. All rights reserved.

DTS is a registered trademark of Digital Home Theater Systems, Inc.

# Connections & Setup

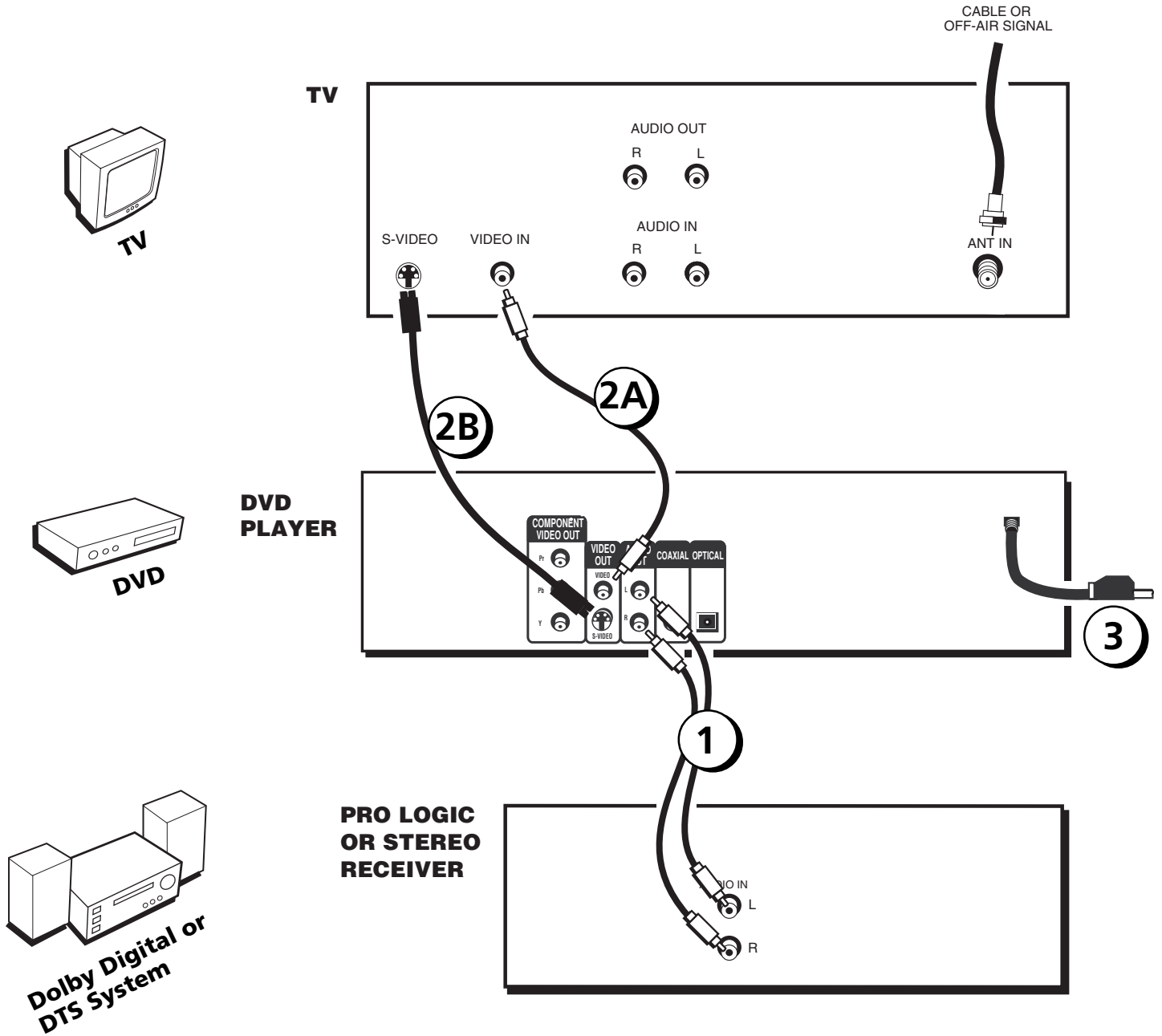



## DVD Player + TV + Dolby Pro Logic or Stereo Receiver

### To Connect the DVD Player

1. Connect the left and right audio cables to your audio/video receiver and to the AUDIO OUT FRONT L (left – white) and R (right – red) jacks on the back of your DVD Player.
2. Connect the video cable.
  - A. **Basic video connection** – Connect the video cable (yellow) to the VIDEO OUT jack on the back of your DVD Player, and to the Video Input jack on your TV.

**OR**
  - B. **S-Video** – (optional) If your TV has an S-Video Input jack, connect the S-Video cable to the S-VIDEO OUT jack on the back of your DVD Player and to the S-Video jack on your TV. If your TV doesn't have S-Video, use the basic video connection listed above.

**OR**
  - C. **Component video** (optional) – If your TV has component video (Y, P<sub>B</sub>, and P<sub>R</sub> jacks) use video-grade cables for the Y, P<sub>B</sub>, and P<sub>R</sub> connections. Note that it is essential to match the color coded connectors with a compatible TV. If your TV doesn't have component video, use the basic video connection or the S-Video connection listed above.
3. Plug in the AC power cord into an AC outlet.

**Go to page 20**

# Connections & Setup

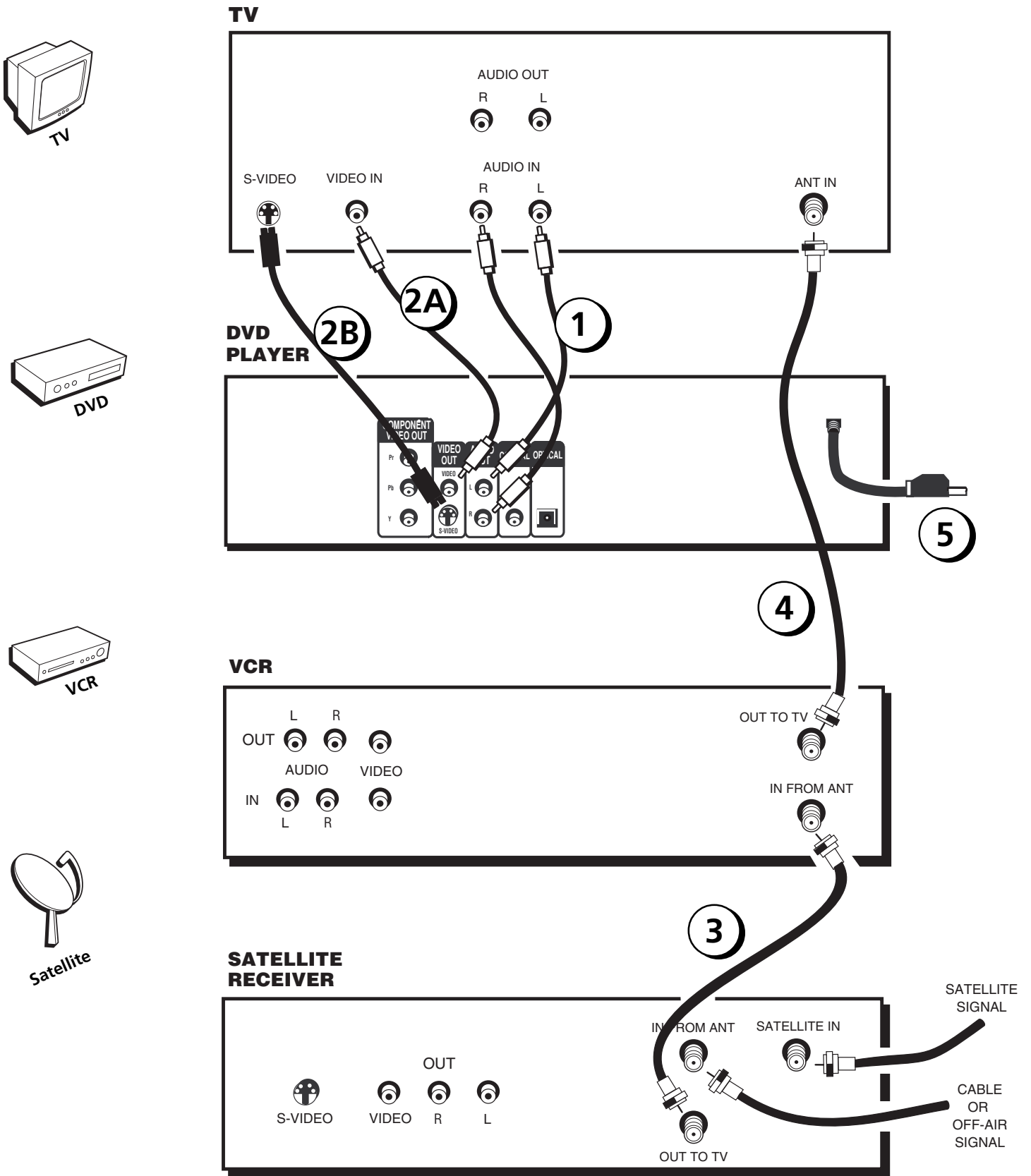

## DVD Player + TV + VCR + Satellite Receiver

1. Connect the audio cables to the AUDIO OUT L (left – white) and R (right – red) jacks on the back of your DVD Player, and to the corresponding Audio Input jacks on your TV.
2. Connect the video cable.
  - A. **Basic video connection** – Connect the video cable (yellow) to the VIDEO OUT jack on the back of your DVD Player, and to the Video Input jack on your TV.

**OR**
  - B. **S-Video** – (optional) If your TV has an S-Video Input jack, connect the S-Video cable to the S-VIDEO OUT jack on the back of your DVD Player and to the S-Video jack on your TV. If your TV doesn't have S-Video, use the basic video connection listed above.

**OR**
  - C. **Component video** (optional, not shown in illustration) – If your TV has component video (Y, P<sub>B</sub>, and P<sub>R</sub> jacks) use video-grade cables for the Y, P<sub>B</sub>, and P<sub>R</sub> connections. Note that it is essential to match the color coded connectors with a compatible TV. If your TV doesn't have component video, use the basic video connection or the S-Video connection listed above.
3. Use a coaxial cable to connect the antenna output on the satellite receiver to the antenna input on the VCR.
4. Use a coaxial cable to connect the antenna output on the VCR to the antenna input on the TV.
5. Plug in the AC power cord into an AC outlet.

**Go to page 20**

# Connections & Setup

## The Jacks on the Back of the DVD Player

When connecting, make sure you connect Output jacks to Input jacks, Video to Video, Right Audio to Right Audio, etc.

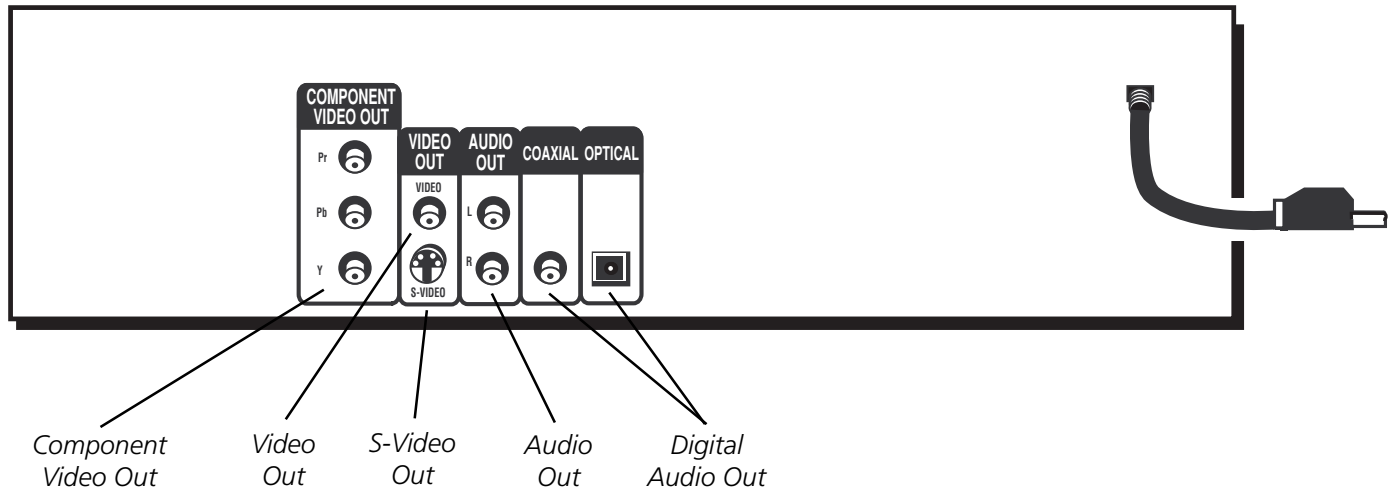

### Description of Jacks (from left to right)

#### COMPONENT (Y, P<sub>B</sub>, P<sub>R</sub>) VIDEO OUT

Use these jacks to connect to a TV with component video input jacks. Unlike a single video input, component video maintains the video signal as three separate signals through these three jacks. This connection provides optimum quality. To ensure maximum picture quality, use three video-grade cables for the Y, P<sub>B</sub>, and P<sub>R</sub> connections. Note that it is essential to match the color-coded connectors with a compatible TV.

#### VIDEO OUT

If you are using color-coded red, yellow and white RCA cables, connect the yellow video cable to this jack and to the Video Input jack on your TV.

#### S-VIDEO OUT

If your TV has an S-Video jack, you can connect an S-Video cable for increased video quality. The S-Video cable only carries the picture signal; remember to connect the left and right audio cables.

#### AUDIO OUT

Insert audio cables (left and right) from the FRONT R (right) and L (left) jacks on your DVD player to the corresponding Audio Input jacks (left and right) on your TV or receiver.

#### DIGITAL AUDIO OUT

Use a digital optical or coaxial cable (not provided) to connect your DVD player to a compatible Dolby Digital or DTS receiver or decoder.

## Front Panel Controls

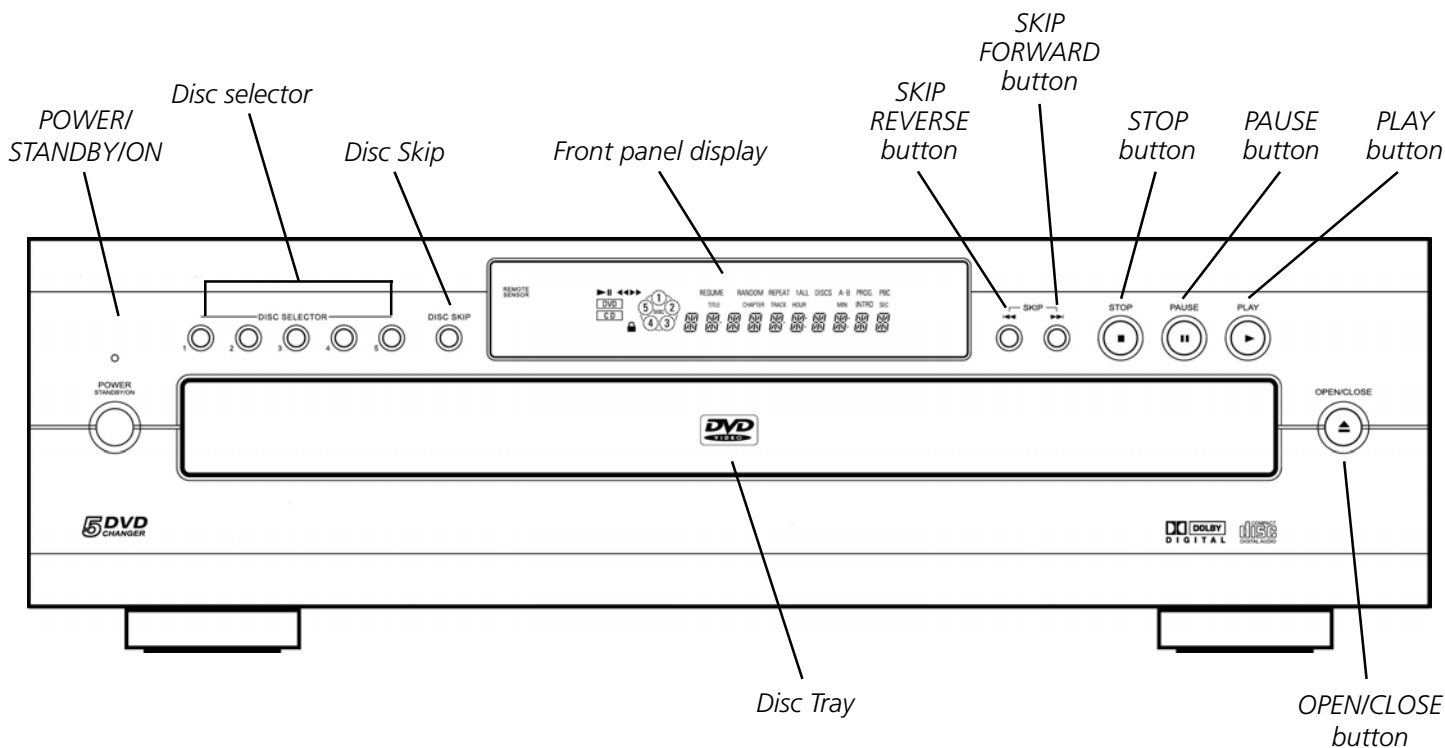

(listed alphabetically)

**DISC SKIP** Press this button to skip the current disc and go to the next disc in the tray.

**Disc Selector** Press the button number of the disc you want to play.

**Disc tray** Press OPEN•CLOSE to open and close the disc tray.

**Front panel display** (See following page for details.)

**POWER ON/OFF button** Turns the player on and off. The ON•OFF indicator lights when the player is on.

**OPEN/CLOSE** Press to open and close the disc tray.

**PAUSE** Pauses disc play. Advances playback one frame at a time during pause mode.

**PLAY** Begins disc play (and closes disc tray if it's open).

**SKIP REV** Allows you to move to the beginning of the preceding title, chapter, track or MP3 title on a disc (in effect, "skipping" the title, chapter, track or MP3 title).

**SKIP FWD** Allows you to move to the beginning of the next title, chapter, track or MP3 title on a disc (in effect, "skipping" the title, chapter, track or MP3 title).

**STOP** Stops disc play.

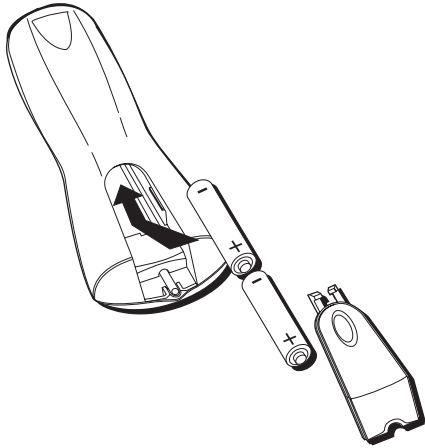

## Installing Batteries in the Remote

1. Remove the battery compartment cover on the back of the remote.
2. Insert new batteries. Match the polarities (+ and -) on the batteries with the diagram on the remote.
3. Put the battery compartment cover back on the remote.

## Important Battery Information

- If you're not going to use the remote for a month or more, be sure to remove the batteries because they can leak and cause damage.
- Dispose of batteries in the proper manner, according to federal, state, and local regulations.
- Any battery may leak electrolyte if mixed with a different battery type, if inserted incorrectly, if all batteries are not replaced at the same time, if disposed of in fire, or if an attempt is made to charge a battery not intended to be recharged.
- Discard leaky batteries immediately. Leaking batteries can cause skin burns or other personal injury.

## Point the Remote in the Right Direction

When you want the remote to operate the DVD Player, point the remote at the DVD Player, *not* the TV. The remote has to be pointed in the correct direction and toward the correct component in order for the remote's signal to communicate with the sensor on the component. Make sure there is a clear path between the remote and the component you want to operate so the signal isn't blocked.

## Turn on the TV and DVD Player

1. Turn on your TV and tune to the correct video input channel (see following page).
2. Press the DVD button on the DVD remote or the POWER button on the DVD player.

## How to Find Your TV's Video Input Channel

You need to tune your TV to the Video Input Channel (or S-Video Channel if you connected the S-Video cable to your TV and to your DVD Player) to see the DVD Player's menu and to see the content that's on a disc. The video channel on TVs varies for different brands and different models. In order for your DVD remote to work, your TV must be set on the correct video input channel. Below are some things to try.

- If your TV brand is RCA, GE, or PROSCAN, press the TV button on the remote that came with your TV (not the DVD remote). Then press the INPUT button on the remote.
- If you have another brand, consult your TV's Owner's Manual.

If those options don't work, try one of the following options.

- Press a button on the TV remote (see table below).
- Select it from the TV's menu system.
- Tune directly to the DVD input channel by pressing a specific number (see table below).
- Go through all the channels in the channel list by pressing the channel up/down buttons on the TV.

Some common scenarios are listed in the following table:

### Video Input Channel Variations

Button/Switch on the TV	Button on the TV Remote	Channel #
VIDEO	VID 1	00
SIGNAL	LINE	90
VID 1	VID	91
VID 2	VIDEO	92
S-VID	S-VID	93
S-VIDEO	INPUT	VID 1
	S-VIDEO	VID 2
	SOURCE	
	AUX	

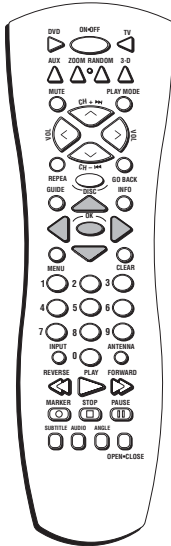

The buttons used for navigation are shown in gray. Use these arrow buttons to highlight an item on the screen. Press the OK button to select a highlighted item.

## How to Move Around the DVD Player's Menu System

The technical term for how you move through the DVD Player's menu system is "Navigation."

This book tells you how to select different menu items, but you can explore the menu system on your own by following a few "navigational rules."

Press the DVD button to put the remote into DVD mode. Then use the arrow buttons on the remote (highlighted in gray on the picture on the left) to highlight different menu items on the screen. (In your DVD Player's menu, a highlighted item appears brighter than the other items on the screen.) To select a menu item, press OK on the remote when the menu item is highlighted.

The invalid symbol  appears on the screen when you press a button that doesn't have any function for that disc.



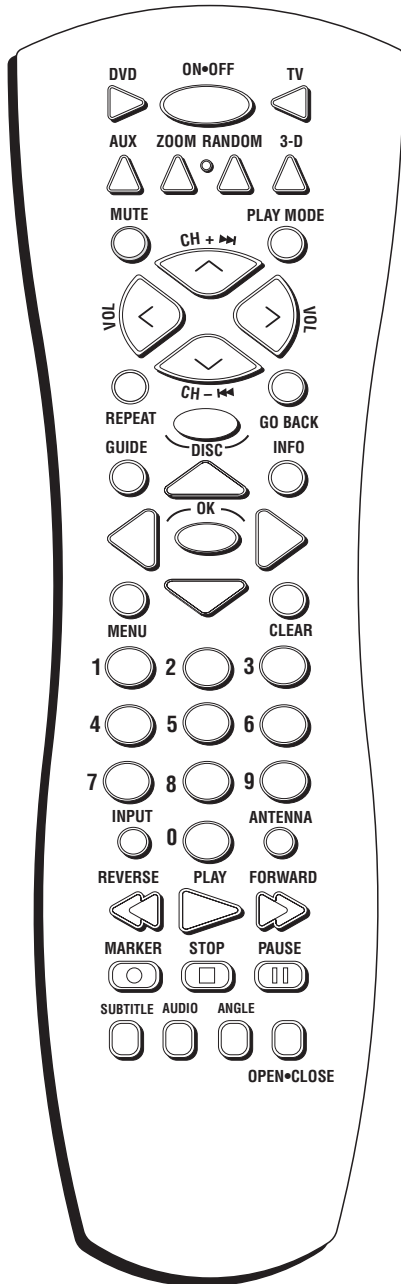

## A Quick Tour of The Remote

You can use this remote to control compatible components. The component buttons are programmed to operate some PROSCAN, RCA and GE components. The buttons must be programmed to operate other brands of components. (See page 25 for instructions.)

### Component Buttons

(Buttons listed in alphabetical order)

Use these buttons to turn on the component and set the remote to control the selected component.

**AUX** Use this button to turn on a compatible TV, VCR, satellite receiver, or cable box after it has been programmed. Used with the ON•OFF button to turn on some brands of components.

**DVD** Use this button to turn on the DVD player and set the remote to control the DVD player.

**TV** Use this button to turn on a compatible TV and set the remote to control the TV. Used with the ON•OFF button to turn on some brands of TVs.

### DVD Buttons

(Buttons Listed in Alphabetical Order)

**3-D** Press this button to simulate a 3-D surround effect from 2 stereo speakers if the disc was recorded using Dolby Surround or Dolby Digital.

**ANGLE** Use this button to access various camera angles on a DVD disc (if the DVD disc contains multiple camera angles).

**ANTENNA** Switches modes.

**Arrow buttons** Use the arrow buttons (left, right, up, and down) to move through on-screen menus. You highlight a menu item by pressing the arrow buttons. You select a highlighted item by pressing the OK button.

**AUDIO** Use this button to access various audio features while playing a disc.

**CH + ►►** advances to the next chapter, track, index or MP3 title.

**CH - ◄◄** reverses to the preceding chapter, track, index or MP3 title.

**CLEAR** Allows you to clear information, such as remove the Info display from the screen.

**DISC** Displays the disc menu (provided the disc has a menu) when playing a pre-recorded disc or the Index Picture screen when playing a DVD+RW disc.

**FORWARD** Allows you to search forward through a disc while it is in play mode (or slow speed search in pause mode). Press repeatedly to increase speed.

# Connections & Setup

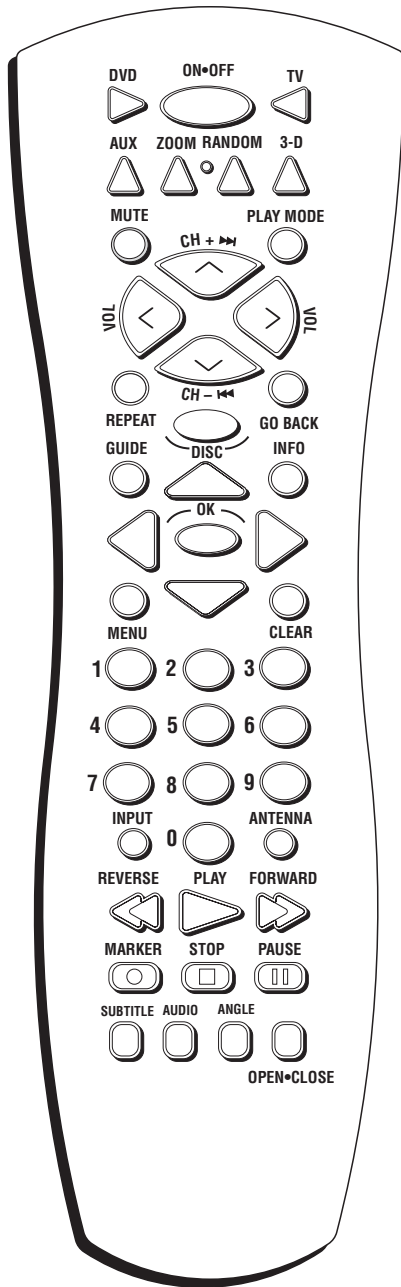

**GO BACK** When you're using the DVD Player's menu system, press this button to return to the preceding menu screen.

**GUIDE** Allows you to see the titles that are available on the current disc (if the disc contains a guide menu).

**INFO** Press this button while you're playing a disc to see the on-screen Info Display. The Info Display contains various playback features and gives you information about the disc you're playing.

**INPUT** Use with the TV button to tune to the Video Input Channel. This may not work with all TVs. In DVD mode, when using Subtitle feature, use to scroll through available languages.

**MARKER** Press this button to access the Marker display. The Marker display allows you to set markers at points on the disc that you'd like to return to. remove the Info Display from the screen).

**MENU** Press this button to see the disc's menu when you're playing a disc (press it again to resume playback). When there is no disc playing, press to see the player menu.

**Number buttons (0-9)** Use the number buttons to input information such as chapter numbers, track numbers, or to make selections on some menu screens.

**MUTE** Turns sound down to an inaudible level.

**OK** Press this button to select a highlighted menu item.

**ON•OFF** Turns on the player when it is in standby mode or puts the player in standby mode when power is on.

**OPEN•CLOSE** When the STOP button is held down, opens and closes the disc tray.

**PAUSE** Pauses disc play. When disc play is paused, press PAUSE again to advance one frame.

**PLAY** Begins disc play (and closes disc tray if it is open).

**PLAY MODE** Press this button to access the Play Mode info display to set random and program playback.

**RANDOM** Press to play chapters, tracks, titles or discs randomly.

**REPEAT** – Accesses the repeat feature, allowing you to repeat portions of a disc.

**REVERSE** Allows you to search backward through a disc while it is in play mode (or slow speed search in pause mode).

**STOP** Stops disc play. You can also press STOP to remove the screen saver from the screen to see the DVD Player's main menu. When you hold the STOP button down, it acts as the OPEN•CLOSE button to open and close disc tray.

**SUBTITLE** Use this feature to turn the subtitles off and on. While the subtitle info area is displayed press the arrow up and down buttons on the remote to change subtitle languages (if available).

**VOL</>** – Increases/decreases volume level.

**ZOOM** Use this button to zoom in on certain areas of the screen.

## Programming the Remote to Operate Your TV

The remote can be programmed to control most brands of remote controllable TVs. The remote is already programmed to control most RCA, Proscan, and GE TVs.

### Testing the remote

To determine whether the remote needs to be programmed, turn the TV ON, point the remote at the TV, and press the TV button. Then press ON•OFF or CH+ (channel up) or CH- (channel down) to see if the TV responds to the remote commands. If not, the remote needs to be programmed.

### Entering Codes

To control a TV that is not from RCA, Proscan or GE, you'll need to enter the specific codes for the brand of TV you have.

1. Turn on the TV to be programmed.
2. Look up the brand and code number(s) for the TV on the code list that's on the next page.
3. Point the DVD Player's remote at the TV.
4. Press and hold the TV button on the remote.
5. Enter the code from the code list that's on the next page.
6. Release the TV button, and then press ON•OFF to see if the TV responds to the command. If it doesn't, try pressing the TV button and then ON•OFF again.
7. If you get no response, repeat these steps using the next code listed for your brand, until the TV responds to the remote commands.

**Note:** This remote may not be compatible with all brands and models of televisions.

### Important!

You must *continue pressing* the TV button *while* you enter the code.

For example, let's say you have a Zenith TV. To program the remote to operate the TV you would:

Press and hold the TV button while you enter the first code listed for Zenith in the TV Codes column.

Release the TV button. Press ON•OFF to see if the TV responds. If it doesn't, follow the same steps, but enter the second code instead of the first.



# Playing DVDs

## Chapter Overview:

- Regional Coding
- Using Different Menus
- Loading and Playing Discs
- Using a Disc Menu
- Using the On-Screen Info Display
- Using the Repeat Feature
- Selecting a Play Mode
- Disc Playback Features Using the Remote
- What is a Video CD?



Changing Entertainment. Again.



## Regional Coding

Both the DVD player and the discs are coded by region. These regional codes must match in order for the disc to play. If the codes don't match, the disc won't play. This player's code is region 1.

## Using Different Menus

Each disc is programmed with different features. There are three separate menu paths that you can use to access features:

- **The Disc menu** – The Disc menu is part of each disc and is separate from the DVD player's menu. The contents of each Disc menu varies according to how the disc was authored and what features are included. The Disc menu is turned on and off (while the disc is playing) with the MENU button on the remote or the front of the player.
- **The DVD player's Info Display** – The Info Display appears as icons across the top of the screen when a disc is playing. It can only be accessed while you are playing a disc. It's turned on and off with the INFO button on the remote or the front of the player.
- **The DVD player menu** – The DVD player's menu system is accessed only when a disc isn't playing. It appears automatically when the STOP button is pressed.

Remember that a feature will only work if the disc was programmed with that feature. For example, if you choose subtitles on the Info Display, the subtitles will only appear if the disc was created with subtitles. If a menu item is "grayed out" it means that item isn't available.

## Types of Discs Your Player will Play

Your DVD player plays the following types of discs:

DVD discs

Video CD discs

Audio CD discs

CD-R discs, CD-RW discs

DVD+RW, DVD-RW, DVD-R, DVD-ROM (with movie information)

MP3 discs

Before you load a disc, make sure that it is compatible with the player. The following discs CANNOT be used with this player:

- Laserdiscs
- CD-I, CD-ROM (computer-only discs), DVD-ROM (without movie information)
- Discs recorded using other broadcast standards (i.e. PAL or SECAM)
- DVD RAM

## Loading and Playing Discs

Turn on the TV and your DVD Player (press ON•OFF on the player or press the DVD button on the remote control).



**This is an example of a one-sided disc.**

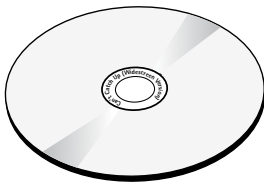

**This is an example of a 2-sided disc. The title is in the center.**

1. Press the OPEN•CLOSE button on the front of the DVD Player or on the remote. The disc tray opens.
2. Place a disc gently into the first slot in the tray with the disc's label facing up (double-sided discs have content on both sides, so you can place either side up).
3. Press the DISC SKIP button on the front of the player to rotate the disc tray. Continue placing discs into the tray as described above. There are 5 discs in the disc tray.
3. Press the OPEN/CLOSE or PLAY button. The disc tray closes.

The DVD Player reads the first disc's table of contents, and then one of two things happens depending on how the disc was programmed:

- The disc starts playing.
- The disc menu appears on the screen. One of the options will start disc play. Highlight that option and press OK on the DVD remote.

When you stop playing a disc, the DVD player remembers where you stopped. When you start playing the disc again, the player picks up where you left off unless the disc is removed, the player is unplugged, or you pressed the STOP button twice.

## Selecting Discs from the Disc Tray

The tray holds 5 discs. To move to the next disc in the tray, press the disc skip button on the front of the player.

You can also select a different disc by pressing one of the numbered DISC SELECT buttons on the front of the player.

# Playing DVDs

## Using a Disc Menu

A disc is capable of having an on-screen menu that is separate from the DVD player's menu system and on-screen Info Display. The disc menu might only contain a list of the titles and chapters, or it may allow you to change features such as language and playback settings.

Although the content and operation of disc menus vary from disc to disc, the following example will give you an idea of what to expect.

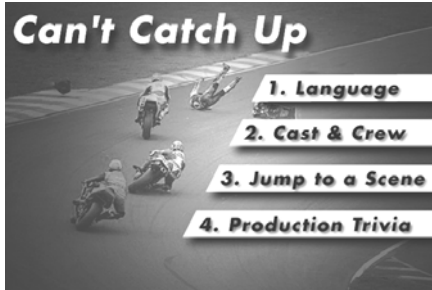

An example of a disc menu. The menus on discs vary because the disc menu is created by the disc's author.

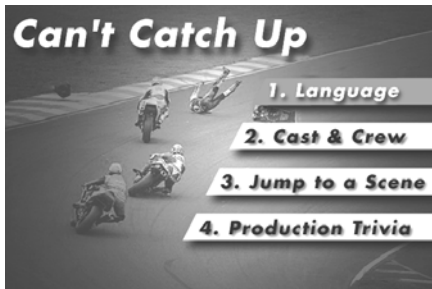

In this example, The *Language* setting is highlighted. To select this option, press OK on the remote.



In the example above, English is highlighted. Press OK on the remote to play the disc with English dialog.

1. While the disc is playing, press the MENU button on the remote or the front of the player. The disc menu appears.

2. Press the up/down arrow buttons to highlight the section of the disc menu you want to choose, and press OK on the remote. In the example on the left, *Language* has been selected.

3. Press the up/down arrows to select a language, and press OK on the remote.
4. Press MENU on the remote or the front of the player to resume playback.

**Note:** Any settings you change on the disc menu only override the default settings in the DVD Player's menu temporarily. Default settings are the settings that you set up in the DVD Player's menu system. To change the default settings, see Chapter 4.



## Using the On-Screen Info Display

The on-screen Info Display contains many playback features. To see the Info Display, press the INFO button on the remote or the front of the player while a disc is playing. The Info Display appears across the top of the screen. Each feature is represented by an icon. Use the left/right arrow buttons on the remote or the front of the player to move through the different icons in the Info Display.

When an icon is highlighted, press OK to select it.

Remember, you can only access the Info Display when you're playing a disc. Also, the Info Display features are only available if the disc was created with that particular feature (i.e., if you select the Subtitle icon, you won't be able to change the subtitle language unless the author of the disc created the disc with subtitles).

The invalid symbol  appears on the screen when you press a button that doesn't have any function. If one of the icons is "grayed out," that Info Display feature isn't available for the disc you're playing. To make the Info Display disappear from the screen, press INFO on the remote or the front of the player.

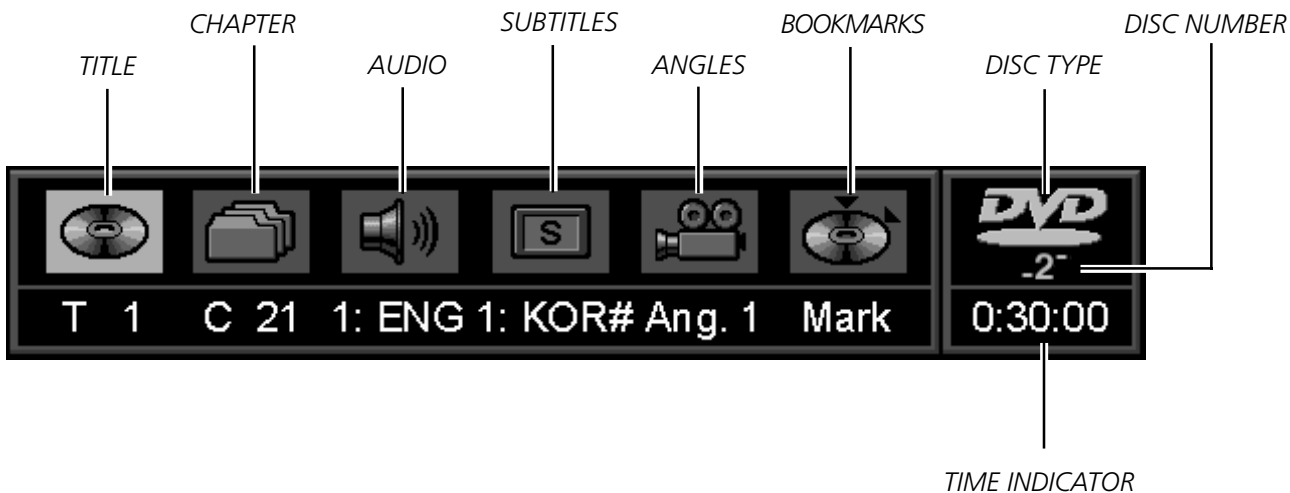

### Selecting a Title

Some discs contain more than one title. For example, there might be four movies on one disc (each movie might be considered a title). Each title is divided into chapters. To select a title:

1. While the disc is playing, press INFO on the remote or the front of the player to bring up the Info Display.
2. If the *Title* icon on the Info Display isn't highlighted, use the left/right arrow buttons to highlight it. Press OK.
3. Use the number button(s) on the remote to enter the title number you want to play (the title begins playing).

**Note:** Some discs only have one title.



## Selecting a Chapter

Because DVD discs use digital technology, a title can be divided into individual chapters (similar to tracks on a CD). You can skip to a specific chapter by using the Chapter feature in the Info Display.

1. While a disc is playing, press INFO on the remote or the front of the player to bring up the Info Display.
2. Press the arrow buttons to highlight the *Chapter* icon. Press OK.
3. Use the number buttons on the remote to enter the number of the chapter you want to play (the chapter begins playing).

### Notes:

*The Chapter feature won't work if the disc isn't formatted with separate chapters.*

*You can also advance to the next chapter by pressing CH + on the remote (SKIP >> on the front of the player) and go to the preceding chapter by pressing CH - on the remote (SKIP << on the front of the player).*



## Using Subtitles

By default, subtitles are off. To turn subtitles on:

While the disc is playing, press the SUBTITLE button on the remote.

## Selecting the Subtitle Language

You can change the subtitle language while you're watching a DVD disc, but only if the disc was created with subtitles.



1. Press the INFO button on the remote.
2. Highlight the *Subtitles* icon and press OK (the subtitle display appears).
3. Press the INPUT button to scroll through the available subtitle languages. Subtitles will be displayed in whatever language is shown in the subtitle display, so once the language you want is shown, subtitles will automatically be displayed in that language.
4. Press CLEAR to remove the info display from the screen.

### Notes:

*Changing the subtitle language with the Info Display will only affect the disc currently being played. When the disc is removed or the player is turned off, the subtitle language will revert to the language setting specified through the DVD player main menu.*

*The subtitle language can also be changed through the DVD player menu.*



## Changing the Audio Language

If the disc was created with different language tracks (recorded in different languages), you can use the Info Display to temporarily change the DVD Player's Audio Language setting.



1. While a disc is playing, press AUDIO on the remote (the audio display appears).  
*Note: You can also bring up the Audio display by pressing the INFO button on the remote and selecting the Audio icon from the info display.*
2. Press the OK button to scroll through the available audio languages. Audio will be played in whatever language is shown in the audio display, so once the language you want is shown, audio will automatically be played in that language.
3. Press CLEAR to remove the Info Display from the screen.

### Notes:

*The language feature only works if the disc was created with multiple audio tracks.*

*When you choose an audio language from the audio display, you only override the audio language setting in the DVD Player's main menu temporarily.*

*The audio language can also be changed through the DVD player menu.*



## Changing the Camera Angle

Some discs contain multiple angles of a particular scene or sequence. If the disc only has one angle, this feature won't work. When multiple angles are available, the *Angle* icon appears in the upper right corner of the screen. To change the camera angle:



1. While a disc is playing, press ANGLE on the remote (the angle display appears).  
*Note: You can also bring up the Angle display by pressing the INFO button on the remote and selecting the Angle icon from the info display.*
2. The angle display will show which angle number is currently playing. Press OK to change the camera angle. With each press of the OK button, the angle will change.
4. To make the Info Display disappear, press the CLEAR button on the remote.

# Playing DVDs

---



## Using Bookmarks

The bookmark feature lets you mark a point on the disc that you can go to quickly. You can store up to nine bookmarks per disc. When you turn the player off or remove the disc, bookmarks are cleared.



## Storing a Bookmark

1. While a disc is playing, press MARKER on the remote (the bookmark display appears).

*Note: You can also bring up the Marker display by pressing the INFO button on the remote and selecting the Bookmark icon from the info display.*

2. An available unmarked icon will be highlighted (in the *Mark* row).
3. When you reach the scene you want to mark, press OK. The highlighted *Mark* box and the *Go To* box above it will be checked and the point is marked.
4. To mark more points, use the arrow buttons to highlight an empty *Mark* box and repeat step 3 above.
5. Press CLEAR to remove the display from the screen.

## Using a Bookmark

1. While you're playing a disc, press MARKER on the remote (the bookmark display appears).
3. Use the arrow buttons to highlight the bookmark you want to activate (in the *Go To* row).
4. Press OK to activate the bookmark and go to that point on the disc.
5. Press CLEAR to remove the display from the screen.

## Time indicator

This feature displays the audio/video time. For DVD discs, the time displayed refers to the current title time. For Audio CDs and MP3 discs, it refers to the current track time.

## The Repeat Feature

The default mode for the Repeat feature is Off. There are five Repeat options:

- All Discs – Repeats all discs in the player
- One Disc – repeats the disc that is playing
- Title – repeats the title that is playing
- Chapter – repeats the chapter that is playing
- A•B – Set the beginning (point A) and the end (point B) of a segment to make this part of the movie or CD play repeatedly.

## To Use Disc, Title or Chapter Repeat:

1. While a disc is playing, press REPEAT on the remote to bring up the repeat display.
2. Press OK to scroll through the *Repeat* options until the option you want is displayed in the text box.
3. Press OK. The selected repeat option will loop continually until you turn Repeat off. Repeat is turned off by completing steps 1 through 2 above and selecting the *Off* option.

## A•B Repeat

A•B Repeat lets you define a specific segment on the disc that you want to repeat. For example, you might like to watch the dogfight in the movie *Top Gun*. To watch this scene over and over:



1. Find the spot on the disc that is a few seconds **before** the beginning of the scene you want to repeat (this gives you time to access the Info Display and the Repeat feature).
2. While a disc is playing, press REPEAT on the remote to bring up the repeat display.
3. Press OK to scroll through the *Repeat* options until the A-B Repeat option is displayed. Press OK.
4. At the beginning of the scene you want to repeat, press OK to set the A point.
5. When you get to the part of the disc that you want to be the end of the repeated segment (the B point), press OK. The segment will repeat until you turn Repeat off.
6. Press CLEAR to remove the display from the screen.

## How to Cancel Repeat

There are three ways to cancel Repeat:

- Press STOP twice.
- Go to the *Repeat* icon in the Info Display and select *Off*.
- Open the disc tray.

## Selecting a Play Mode

You can choose what order the titles or tracks will play on a disc. The standard play mode is the default. To select another play mode, a disc must be in the DVD player.

There are three play mode options:

**Standard Play:** plays the disc's titles, chapters, or tracks (depending on the type of disc in the player) in their default order (i.e., chapter 1 of Title 1 plays first, then chapter 2 of Title 1, etc.)

**Random Play:** plays the chapters of each title (or tracks on an audio CD) in random order.

**Program Play:** Plays the chapters or tracks on the disc in the order you have programmed (you must create a play list which lists the order in which you want the tracks on the disc to play).



### Random Play

To play chapters or tracks in random order:

1. Press the RANDOM button on the remote. The random display will appear to confirm your selection.
2. Press CLEAR to remove the display from the screen.

To return to standard play, press the RANDOM button again. The standard play display will appear to confirm your selection. Press CLEAR to remove the display from the screen.

## Programmed Play

To use the programmed play option, you must create a play list to set the order you want the chapters (or tracks on a CD) on the disc to play in. The Program Edit screen varies depending on the type of disc (DVD or CD) you are playing.

### Creating a Program List for a DVD Video Disc

1. If a disc is playing, press STOP once to put the player in stop mode.
2. Press PLAY MODE on the remote (the Program Edit screen is displayed).
3. The *Disc* box is highlighted. Use the up/down arrow buttons (or the number buttons) to highlight the disc you want to play first.
4. Use the arrow buttons to highlight the *Title* box. Use the up/down arrow buttons to highlight the title you want to play.
5. Use the arrow buttons to highlight the *Chapter* box. Use the up/down arrow buttons to highlight the chapter you want to play.
6. Use the arrow buttons to highlight *Add* and press OK. Your selection will be added to the playlist.
7. Continue adding discs/titles/chapters as explained in steps 2-5 until your program is complete. You can play your program by highlighting *Play* and pressing OK.

## Editing a Program

### Deleting Items from the Play List

To delete items from the play list:

1. If a disc is playing, press STOP once to put the player in stop mode.
2. Press PLAY MODE on the remote (the Program Edit screen is displayed).
3. Highlight the row in the play list you want to delete. Use the arrow buttons to highlight *Delete* and press OK or CLEAR. The item is deleted.

### Inserting Items in the Play List

To insert items into the play list:

1. If a disc is playing, press STOP once to put the player in stop mode.
2. Press PLAY MODE on the remote (the Program Edit screen is displayed).
3. Use the arrow buttons to select the disc/title/chapter you want to insert.
4. Use the arrow buttons to highlight the row where you want to insert your selection (your selection will be inserted above that row).
5. Use the arrow buttons to highlight the *Insert* option and press OK.

## Disc Playback Features Using the Remote

You can use the remote control to activate disc playback features.

Playback features aren't usually available during the opening credits of a movie. If a playback feature isn't available, the invalid symbol  appears on the screen when you press that button.

### Fast Motion Playback (Picture Scan)

To scan quickly through the disc when you're playing it, use the Picture Scan feature.

1. Press the REVERSE or FORWARD button on the remote when you're playing a disc.
2. Press the button again to scan at a faster speed. Each time you press the button, the scanning speed increases.
3. Press the PLAY button at any time to resume normal playback.

**Note:** You won't hear the sound (audio) on DVD discs when you're using the picture scan feature.

# Playing DVDs

---

## Freeze Frame and Frame Advance

1. Press PAUSE when a disc is playing to freeze the picture.
2. Each time you press the PAUSE button, the picture advances one frame.
3. Press PLAY to resume normal playback.

## Slow Motion Playback (in Freeze Frame Mode)

While the disc is in freeze frame mode, you can use slow motion playback.

1. While the disc is playing, press PAUSE on the remote.
2. Press the REVERSE or the FORWARD button.
3. Press the button again to decrease the slow motion playback speed.
4. Press PLAY to resume normal playback.

## Chapter Advance

While a disc is playing, you can go forward or backward a chapter or track at a time by pressing CH + or CH – on the remote.

## Zoom

When playing DVD discs and Video CDs, you can magnify the screen during normal playback. For DVD discs, Zoom has 3 levels (1.5x, 2x, 4x). For video CDs, Zoom has 2 levels (1x, 2x). Zoom magnifies from the center of the screen. Once in Zoom mode, you can pan right, left, up or down by using the arrow buttons.

1. Press ZOOM on the remote control to magnify. (The zoom level will be displayed in the corner of the screen. Press CLEAR to clear the zoom Info Display from the screen.)
2. Press the ZOOM button again to go to the next level of magnification.
3. To turn Zoom off, press the ZOOM button until you cycle through all the levels and return to normal playback.

**Note:** You can use the 1.5x zoom mode to alter a 16x9 letterbox movie (black bars top and bottom) to a 4x3 format. This will eliminate the black bars at the top and bottom and allow you to use left/right arrow keys to pan and scan.

## What is a Video CD?

Like DVD video discs, Video CDs contain picture and sound content. Video CDs (VCDs) are encoded in a different format. VCDs don't hold as much information as DVD discs and the picture quality is not as high.

Because a VCD contains less information than a DVD disc, some of the features provided by the player may not work with some VCDs.



# Playing Audio CDs and MP3 Discs

## Chapter Overview:

- Using the Info Display
- Using IntroScan™
- Using Bookmarks
- Using the Time Display
- Selecting a Play Mode
- The Repeat Feature
- Playing MP3 Discs



Changing Entertainment. Again.



# Playing Audio CDs and MP3 Discs

## Using the Info Display

Your DVD player has many of the same features as an audio CD player. The player's on-screen Info Display lets you choose various playback features. This section explains how to play audio CDs in your DVD player and how to use the player's features. For instructions on loading and playing your CDs, see Chapter 2.

To access the Info Display while the CD is playing, press INFO on the remote or the front of the player. The Info Display appears across the top of the screen. Each of the playback features is represented by an icon. To access a feature, use the arrow buttons on the remote to highlight the icon. Each feature that can be accessed from the on-screen Info Display is described on the following pages. To clear the Info Display from the screen, press INFO on the remote control or the front of the player.

### Notes

To see the Info Display while playing audio CDs, you must turn on your TV and tune it to its Video Input Channel. For more information about the TV's Video Input Channel, see Chapter 1.

Some transport modes (reverse and fast forward) are not available for audio CDs.

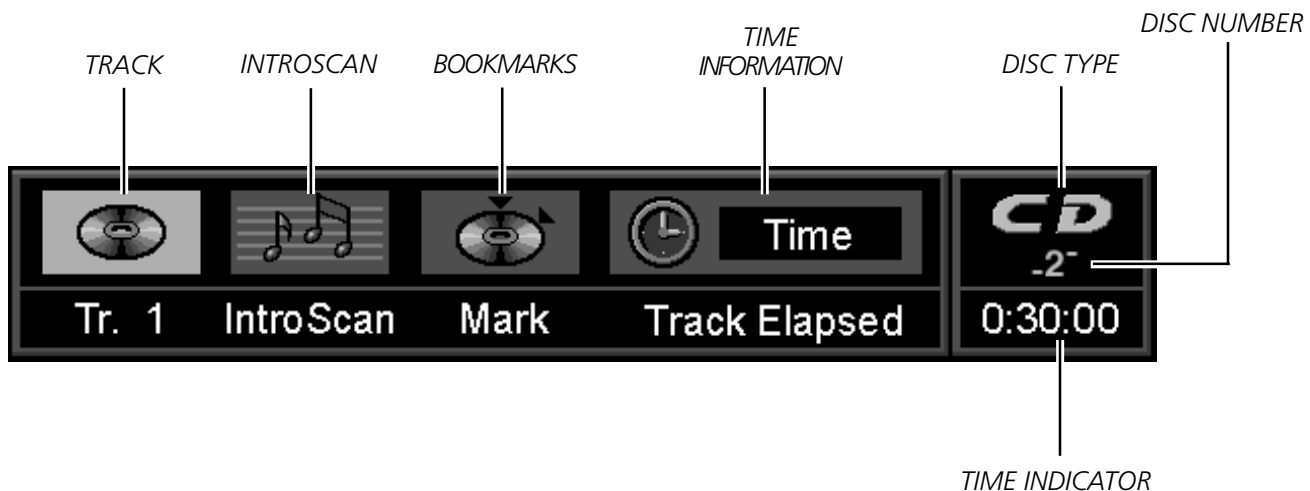

## Selecting a Specific Track

1. Press INFO on the remote or the front of the player (the Info Display appears).
2. Highlight the *Track* icon.
3. Use the number buttons on the remote to enter the track number you want to play. You may need to press the OK button on the remote after you enter a single digit track number.

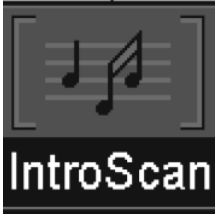

## Using IntroScan™

The IntroScan system plays the first ten seconds of each track on the CD (similar to the scan feature that's on many car radios). To use the IntroScan system:

1. Press INFO on the remote or the front of the player (the Info Display appears).
2. Highlight the *IntroScan* icon. Press OK. The first ten seconds of each track will play.
  - After the IntroScan system goes through all of the tracks, it stops.
  - If you want to stop the IntroScan system while it's in progress, press PLAY on the remote. The current track starts playing in its entirety.



## Using Bookmarks

The bookmark feature lets you mark a place on the disc that you can go to quickly. You can store up to nine bookmarks per disc. When you turn the player off or remove the disc, bookmarks are cleared.



## Storing a Bookmark

1. While a disc is playing, press MARKER on the remote (the bookmark display appears).

*Note: You can also bring up the Marker display by pressing the INFO button on the remote and selecting the Bookmark icon from the info display.*
2. An available unmarked icon will be highlighted (in the *Mark* row).
3. When you reach the place you want to mark, press OK. The highlighted *Mark* box and the *Go To* box above it will be checked and the place is marked.
4. To mark more places, use the arrow buttons to highlight an empty *Mark* box and repeat step 4 above.
5. Press CLEAR to remove the display from the screen.

## Using a Bookmark

1. While you're playing a disc, press MARKER on the remote (the bookmark display appears).
3. Use the arrow buttons to highlight the bookmark you want to activate (in the *Go To* row).
4. Press OK to activate the bookmark and go to that point on the disc.
5. Press CLEAR to remove the display from the screen.

# Playing Audio CDs and MP3 Discs

---

## The Time Display

The Time Display has four options:

- Track elapsed – show the elapsed play time of the current track.
- Track remain – shows the remaining play time for the current track.
- Disc elapsed – shows the total time the current disc has played.
- Disc remain – shows the remaining play time of the current disc.

To change the time display:



1. Press INFO on the remote to bring up the Info Display.
2. Use the arrow buttons to highlight the *Time* icon.
3. Press the OK button to scroll through the time display choices. The time display will change with each press of the button.

## Selecting a Play Mode

You can choose what order the tracks will play on a disc. The standard play mode is the default. To select another play mode, a disc must be in the DVD player.

There are three play mode options:

**Standard Play:** plays the disc's tracks in their default order.

**Random Play:** plays the tracks in random order.

**Program Play:** Plays the tracks on the disc in the order you have programmed (you must create a play list to set the order you want the tracks on the disc to play in).



### Random Play

To play chapters or tracks in random order:

1. Press the RANDOM button on the remote. The random display will appear to confirm your selection.
2. Press CLEAR to remove the display from the screen.



To return to standard play, press the RANDOM button again. The standard play display will appear to confirm your selection. Press CLEAR to remove the display from the screen.

## Programmed Play

To use the programmed play option, you must create a play list to set the order you want the tracks on the disc(s) to play in.

### Creating a Program List for an Audio Disc

1. If a disc is playing, press STOP once to put the player in stop mode.
2. Press PLAY MODE on the remote (the Program Edit screen is displayed).
3. The *Disc* box is highlighted. Use the up/down arrow buttons (or the number buttons) to highlight the disc you want to play first.
4. Use the arrow buttons to highlight the *Track* box. Use the up/down arrow buttons to highlight the track you want to play.
5. Use the arrow buttons to highlight *Add* and press OK. Your selection will be added to the playlist.
6. Continue adding discs/tracks as explained in steps 2-4 until your program is complete. You can play your program by highlighting *Play* and pressing OK.

## Editing a Program

### Deleting Items from the Play List

To delete items from the play list:

1. If a disc is playing, press STOP once to put the player in stop mode.
2. Press PLAY MODE on the remote (the Program Edit screen is displayed).
3. Highlight the row in the play list you want to delete. Use the arrow buttons to highlight *Delete* and press OK or CLEAR. The item is deleted.

### Inserting Items in the Play List

To insert items into the play list:

1. If a disc is playing, press STOP once to put the player in stop mode.
2. Press PLAY MODE on the remote (the Program Edit screen is displayed).
3. Use the arrow buttons to select the disc/track you want to insert.
4. Use the arrow buttons to highlight the row where you want to insert your selection (your selection will be inserted above that row).
5. Use the arrow buttons to highlight the *Insert* option and press OK.

# Playing Audio CDs and MP3 Discs

---

## The Repeat Feature

The default mode for the Repeat feature is Off. There are four Repeat options for Audio CDs:

- All Discs – Repeats all discs in tray
- One Disc – repeats the disc that is playing
- Track – repeats the track that is playing
- A•B – Set the beginning (point A) and the end (point B) to make this segment of the CD play repeatedly.

### To Use Disc or Track Repeat:

1. While a disc is playing, press the REPEAT button on the remote or the front of the player (the Repeat info display will appear).
2. Press the up/down arrow buttons to scroll through the *Repeat* options until the *Disc* or *Track Repeat* option is displayed in the text box.
3. Press OK. The selected repeat option will loop continually until you turn Repeat off. Repeat is turned off by completing steps 1 through 3 above, and selecting the *Off* option.



### A•B Repeat

A•B Repeat lets you define a specific segment on the disc that you want to repeat:

1. Find the spot on the disc that is a few seconds **before** the beginning of the part you want to repeat (this gives you time to access the Info Display and the Repeat feature).
2. Press REPEAT on the remote or the front of the player to bring up the Repeat info display.
3. Press the REPEAT button until the A•B Repeat option is shown. Press OK.
4. At the beginning of the part you want to repeat, press OK to set the A point.
5. When you get to the part of the disc that you want to be the end of the repeated segment (the B point), press OK. The segment will repeat until you turn Repeat off.
6. Press the CLEAR button to remove the info display from the screen.

### How to Cancel Repeat

There are three ways to cancel Repeat:

- Press STOP twice.
- Press REPEAT button and select *Off*.
- Eject the disc.

## Playing MP3 Discs

### What is MP3?

MP3 is a format for storing digital audio. An audio CD-quality song can be compressed into MP3 format with very little loss of quality, while taking up much less space.

CD-R or a CD-RW discs that have been encoded in MP3 format can be played on your DVD player. In this manual, CD-R and CD-RW discs will be referred to as MP3 discs. MP3 files, or songs, are referred to as *titles*.

### Obtaining MP3 files

There are two ways to obtain MP3 files:

- By using computer software to encode MP3 files from an audio CD – You can download the software necessary to encode MP3 files from the internet.

When encoding MP3 files, you can include information such as title, artist, genre, and comments that will be displayed by your DVD player at the time the title is played. This information must be included at the time the file is encoded in order for it to be displayed at the time you play it on the player.

- Downloading MP3 files from the internet – There are many internet sites that allow you to download MP3 files for free, and many sites that require a fee.

### Creating an MP3 Disc on Your Computer

For information regarding MP3 encoding software and MP3 sites, visit <http://www.lyrazone.com>.

# Playing Audio CDs and MP3 Discs



## The MP3 Display

MP3 discs contain individual songs that can be organized into folders. When you play an MP3 disc, the MP3 screen appears. Folders and songs are displayed on the left side of the screen. The right side of the screen is the program window.

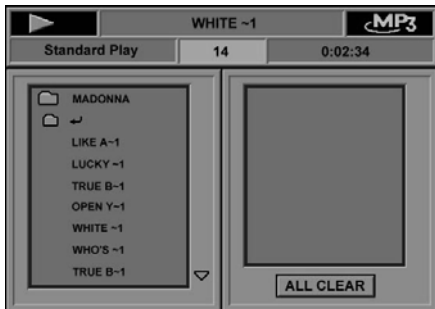

## Selecting Folders and Songs

Playback begins automatically when you insert an MP3 disc into the player. The player will begin playing the songs in the order they were burned on the disc.

1. To open a folder, use the arrow buttons on the remote to highlight the folder you want. Press OK (the songs in the folder will be displayed).
2. Use the up/down arrow buttons to highlight the song you want from the song list. Press OK to begin playback of the highlighted song.

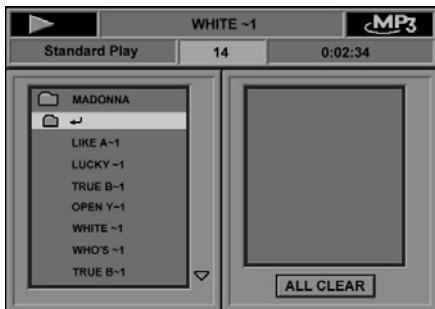

## Closing Folders

Use the arrow buttons to highlight the open folder icon. Press OK to close the folder.

## Skipping Songs

Use the CH+ button to move to the next song. Use the CH- button to move to the beginning of the currently playing song. Press CH- again to move to the previous song.





## Creating a Play List

You can play the songs in a folder in any order you want by creating a play list.

1. If a disc is playing, press STOP to put the player in stop mode.
2. Press PLAY MODE on the remote (the Program Edit screen will appear).
2. Use the up/down arrow buttons to select a song and press the OK button (the song will appear in the program window on the right side of the screen).
3. Press PLAY to begin playback of the playlist (make sure the screen displays Program Play above the window on the left).

## Deleting Songs from the Playlist

To delete a song from the playlist:

1. Press STOP to put the player in stop mode.
2. Use the arrow buttons to highlight the song you want to delete.
3. Press CLEAR (the song is deleted from the playlist).

## Deleting the Playlist

To delete the entire playlist:

1. Press STOP to put the player in stop mode.
2. Use the arrow buttons to highlight the ALL CLEAR option on the screen and press OK.

**This page intentionally left blank.**

# Using the DVD Player's Menu System

### Chapter Overview:

- The DVD Player Menu System
- Locking Your DVD Player
- The Display Menu
- The Sound Menu
- The Languages Menu

Changing Entertainment. Again.



# Using the DVD Player's Menu System

---

## The DVD Player Menu System

The DVD player menu system is not the same as the disc menu or the Info Display. If you are playing a disc, press STOP on the remote control to stop playback and press the MENU button on the remote bring up the DVD player menu.

### Path Items

A path menu item has an arrow on the right side to let you know this item is a path to MORE options. To see the path menu options, highlight the path menu item and press OK. The next set of menu choices appears to the right of the menu item.

## The Audio Language Preference

The Audio Language menu enables you to choose which language you want to listen to a movie in.

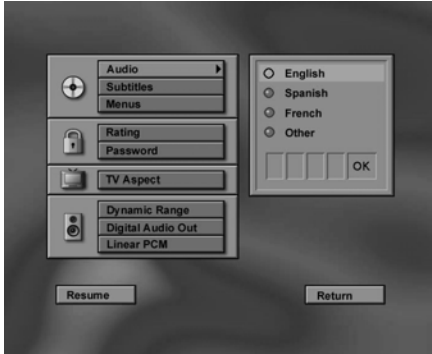

1. If a disc is playing, press STOP and MENU (the menu appears).
2. Highlight *Audio* and press OK (the audio language options are displayed).
3. Highlight the language you want to use for the audio portion of the discs and press OK.
4. Press the MENU button to remove the menu from the screen.

### How to Set *Other* as an Audio Language Option

If the language you want to use isn't listed, you can use the *Other* option to select the language of your choice.

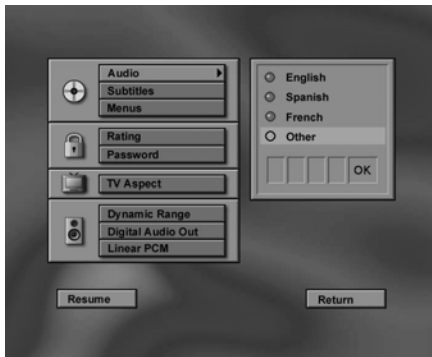

1. If a disc is playing, press STOP and MENU (the menu appears).
2. From the *Audio* menu, highlight *Other* and press OK.
3. Enter the code from the Language Codes list at the end of this chapter and press OK.
4. Press the MENU button to remove the menu from the screen.

**NOTE:** Remember, your player can't play the disc in the language you have chosen if the disc wasn't created with that language option.

# Using the DVD Player's Menu System

---

## Changing the Subtitle Language Preference

The *Subtitles* menu lets you choose a preferred language for the subtitles. The default is *Auto*. To change the subtitle language preference:

1. If a disc is playing, press STOP and MENU (the menu appears).
2. Highlight *Subtitles* and press OK (the *Subtitle* menu is displayed).
3. Highlight the language you want to use for subtitles and press OK.
4. Press the MENU button to remove the menu from the screen.

**Note:** Remember, your player can't play the disc in the language you have chosen if the disc wasn't created with that language option.

## How to Set *Other* as the Subtitle Language Preference

If the language you want to use isn't listed, you can use the *Other* option to select the language of your choice.

1. Highlight and select the *Subtitles* option (the Subtitles menu is displayed).
2. From the *Subtitles* menu, highlight *Other* and press OK.
3. Enter the code from the Language Codes list at the end of the chapter and press OK (the previous menu appears with your selection shown next to the *Audio* path menu).
4. Press the MENU button to remove the menu from the screen.

**NOTE:** Remember, your player can't play the disc in the language you have chosen if the disc wasn't created with that language option.

## Changing the Player Menu Language Preferences

You can choose one of three languages for the text that appears within the on-screen menu system. The default is English. If you change the Player Menu language, the entire player menu system will be displayed in the selected language.

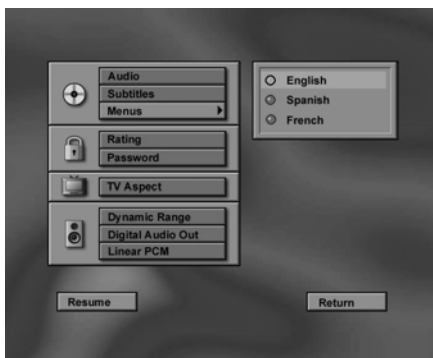

1. If a disc is playing, press STOP and MENU (the menu appears).
2. Highlight *Menus* and press OK (the language choices for the DVD Player's menu are displayed).
3. Highlight the language you want to use for the menu items and press OK. The menu appears with your selection shown next to *Player Menus*.
4. Press the CLEAR button to remove the info display from the screen.

## Creating a Password and Setting Ratings

The Rating feature is a system sort of like movie ratings. It works with DVD discs that have been assigned a rating. This helps you control the types of DVDs that your family watches. Once you have set the ratings limit, you can lock the player so that a password is required to play discs with a rating over the limit you've set.

**Note:** The player alerts you when you try to play a movie with a rating that exceeds the limit you've set. Some discs include a rating override feature. When you play a disc with this feature, the message **Override Limit or Cancel Selection** appears on the screen. If you choose to override the rating limit, you will need to enter your password to begin playback.

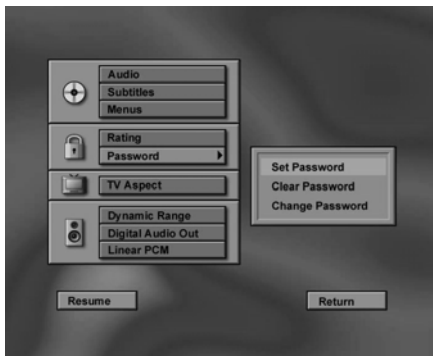

### Creating a Password

1. If a disc is playing, press STOP and MENU (the menu appears).
2. Use the arrow buttons to highlight the *Password* option. Press OK. The password choices appear on the right.
3. Highlight the *Set Password* option and press OK (the Enter Password box appears).
4. Enter a four-digit number that you want to use as your password. Press OK.
5. You will be prompted to enter your password again to confirm. Enter your password again and press OK. Your password is now set.

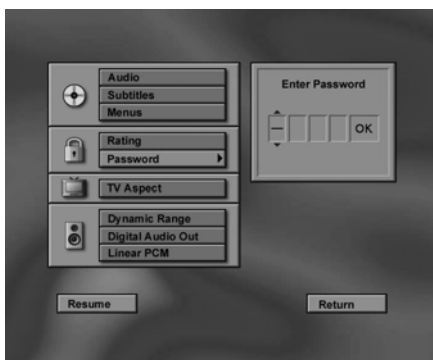

### Changing your Password

To change your password:

1. If a disc is playing, press STOP and MENU (the menu appears).
2. Use the arrow buttons to highlight the *Password* option. Press OK. The password choices appear on the right.
3. Highlight the *Change Password* option and press OK (the Enter Password box appears).
4. Enter your current password and press OK (the *Enter Password* box appears).
5. Enter a new four-digit number that you want to use as your password. Press OK.
6. You will be prompted to enter your password again to confirm. Enter your password again and press OK. Your password is now set.

### Clearing Your Password

If you want to turn the password off so any disc can be viewed:

1. If a disc is playing, press STOP and MENU (the menu appears).
2. Use the arrow buttons to highlight the *Password* option. Press OK. The password options appear on the right.
3. Highlight the *Clear Password* option and press OK (the *Enter Password* box appears).
4. Enter your password and press OK. The password feature is now turned off.

# Using the DVD Player's Menu System

---

## Setting the Rating

### Rated Titles

The Rating option lets you determine how your player will react to discs that contain movies that are rated (in the U.S.A., the Motion Pictures Association of America (MPAA) rates movies as G, PG, PG-13, etc.).

You decide which ratings require a password and which ones don't. This system ranks the ratings 1 through 8 in order to accommodate different countries' ratings systems (1 is considered a movie title with the least offensive material).

In order for the Rating Level feature to work, the disc must be encoded with rating information. If the author of the disc did not encode rating information, then this feature will not work for that disc.

The DVD Player must be locked (password protected) in order for it to enforce the settings in the Rating menu.

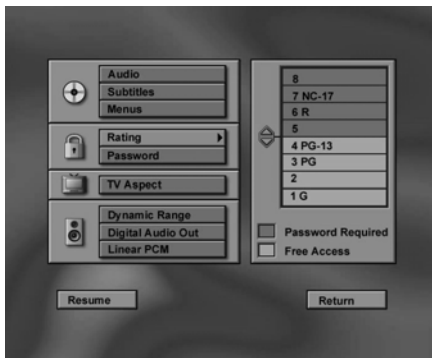

1. If a disc is playing, press STOP and MENU (the menu appears).
2. Use the arrow buttons to highlight the *Rating* option. Press OK (the 8-level rating limits list appears).
3. To change the rating limit, press the up or down arrow button.
4. When you have highlighted the desired settings, press OK. You are returned to the menu and the setting appears to the right of the *Rating* option. This means when the player is locked, it will require you to enter the password to play any discs that are rated higher than the limit you've set.

*Note: Some titles (movies) aren't rated, but may contain material that is unsuitable for children.*



# Using the DVD Player's Menu System

## TV Aspect

The TV Aspect adjusts the way a movie appears on your TV. Standard TVs are 4 x 3 format. Depending on the type of television you have, you may want to adjust the screen setting (also called the aspect ratio).

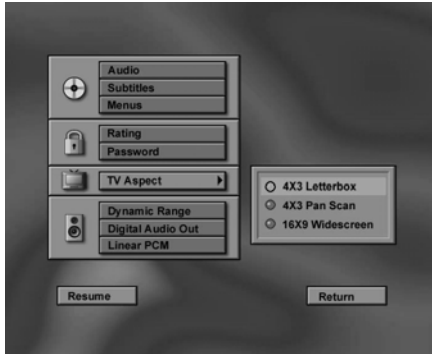

1. If a disc is playing, press STOP and MENU (the menu appears).
2. Highlight *TV Aspect*. Press OK. The TV Aspect options appear.
3. Highlight the option you want (as described below) and press OK.



4x3 Letterbox

**4 x 3 Letterbox** – Choose this setting if you want to see movies in their original aspect ratio (height-to-width ratio). You'll see the entire frame of the movie, but it will take up a smaller portion of the screen vertically. The movie might appear with black bars at the top and bottom of the screen.



4x3 Standard

**4 x 3 Standard** – Choose this setting if you want the movie to fill the entire screen of your TV. This might mean that parts of the picture (the left and right edges) won't be seen.

Most discs produced in a widescreen format can't be cropped in this fashion. This means the black bars will appear at the top and the bottom of the screen.



16x9 Widescreen

**16 x 9 Widescreen** – Choose this setting if your DVD Player is connected to a widescreen TV. If you choose this setting and you don't have a widescreen TV, the images on the screen may appear distorted due to vertical compression.

If you play a disc recorded in 4 x 3 format on a widescreen TV, the left and right side of the screen will appear black.

Some movies are actually slightly wider than 16 x 9. In this case, black bars will appear at the top and bottom of the screen even in Widescreen mode.

*Note: Some discs are already formatted with black bars so the entire image can be seen on a standard TV screen. If you have a widescreen TV and you are playing this type of disc, you will need to set your TV to expand the image. See your TV User's Manual.*

# Using the DVD Player's Menu System

## Dynamic Range

This feature compresses the dynamic range (quietest sound to loudest sound) of a disc's soundtrack. For example, action scenes might be very loud, while whispered dialog is quiet. The Dynamic Range feature evens out the range of the volume by making loud sounds quieter and soft sounds louder.

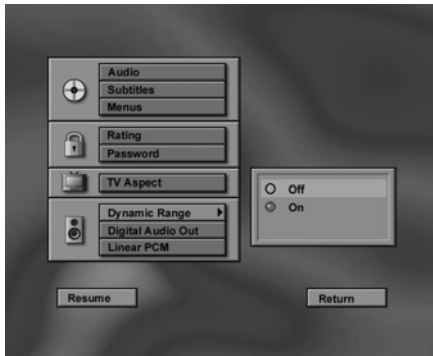

1. If a disc is playing, press STOP and MENU (the menu appears).
2. Highlight and select the *Dynamic Range* option and press the right arrow button.
3. Highlight On or Off and press OK.
4. Press the MENU button to remove the menu from the screen.

## Digital Audio Out

Digital output lets you choose which type of digital audio is output from your DVD player. If you've used an optical cable to connect a Dolby Pro Logic, Dolby Digital, or DTS receiver, you must select a digital output with this setting. There are three options:

- PCM: Choose this setting if you are using the left/right analog outputs or if the digital audio outputs are connected to a processor that is capable of playing conventional PCM audio for CDs.
- Dolby Digital: Choose this setting if you connected a Dolby Digital receiver.
- DTS: Choose this setting if you connected a DTS receiver or decoder to your DVD Player.

You can check both options if your receiver is capable of decompressing both types of audio. The default is DTS. To change the digital output:

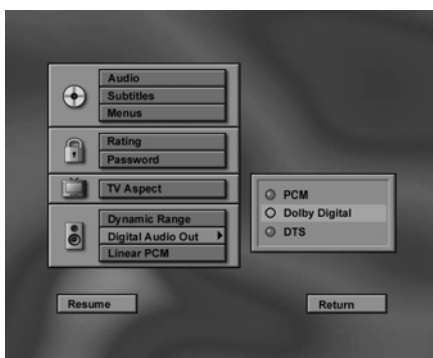

1. If a disc is playing, press STOP and MENU (the menu appears).
2. Highlight the *Digital Audio Out* option and press OK.
4. Highlight the desired output and press OK.
5. Press the MENU button to remove the menu from the screen.

*Note: If you set Digital Output to DTS, you must have your DVD Player connected to a receiver or decoder with the DTS feature and the disc you play must support the DTS audio format. If you choose DTS and your receiver or decoder doesn't support DTS, you won't hear any audio.*

## Linear PCM

If you have an Audio receiver hooked up, you can use the Linear PCM feature to change the bitrate if necessary.

# Language Code List

Don't forget to press the OK button after you enter the code.

Language	Code	Language	Code	Language	Code
Abkhazian	6566	Hungarian	7285	Russian	8285
Afar	6565	Icelandic	7383	Samoaan	8377
Afrikaans	6570	Indonesian	7378	Sangho	8371
Albanian	8381	Interlingua	7365	Sanskrit	8365
Ameharic	6577	Interlingue	7369	Scots Gaelic	7168
Arabic	6582	Inupiak	7375	Serbian	8382
Armenian	7289	Irish	7165	Servo-Croatian	8372
Assamese	6583	Italian	7384	Sesotho	8384
Aymara	6588	Japanese	7465	Setswana	8478
Azerbaijani	6590	Javanese	7487	Shona	8378
Bashkir	6665	Kannada	7578	Sindhi	8368
Basque	6985	Kashmiri	7583	Singhalese	8373
Bengali; Bangla	6678	Kazakh	7575	Siswati	8383
Bhutani	6890	Kinyarwanda	8287	Slovak	8375
Bihari	6672	Kirghiz	7589	Slovenian	8376
Bislama	6673	Kirundi	8278	Somali	8379
Breton	6682	Korean	7579	Spanish	6983
Bulgarian	6671	Kurdish	7585	Sundanese	8385
Burmese	7789	Laothian	7679	Swahili	8387
Byelorussian	6669	Latin	7665	Swedish	8386
Cambodian	7577	Latvian, Lettish	7686	Tagalog	8476
Catalan	6765	Lingala	7678	Tajik	8471
Chinese	9072	Lithuanian	7684	Tamil	8465
Corsican	6779	Macedonian	7775	Tatar	8484
Croatian	7282	Malagsy	7771	Telugu	8469
Czech	6783	Malay	7783	Thai	8472
Danish	6865	Malayalam	7776	Tibetan	6679
Dutch	7876	Maltese	7784	Tigrinya	8473
English	6978	Maori	7773	Tonga	8479
Esperanto	6979	Marathi	7782	Tsonga	8483
Estonian	6984	Moldavian	7779	Turkish	8482
Faroese	7079	Mongolian	7778	Turkmen	8475
Fiji	7074	Naru	7865	Twi	8487
Finnish	7073	Nepali	7869	Ukrainian	8575
French	7082	Norwegian	7879	Urdu	8582
Frisian	7089	Occitan	7967	Uzbek	8590
Galician	7176	Oriya	7982	Vietnamese	8673
Georgian	7565	Oromo (Afan)	7977	Volapük	8679
German	6869	Panjabi	8065	Welsh	6789
Greek	6976	Pashto, Pushto	8083	Wolof	8779
Greenlandic	7576	Persian	7065	Xhosa	8872
Guarani	7178	Polish	8076	Yiddish	7473
Gujarati	7185	Portuguese	8084	Yoruba	8979
Hausa	7265	Quechua	8185	Zulu	9085
Hebrew	7387	Rhaero-Romance	8277		
Hindi	7273	Romanian	8279		

**This page intentionally left blank.**

# Other Information

### Chapter Overview:

- Troubleshooting
- Care and Maintenance
- Limited Warranty
- Accessory Ordering Information

Changing Entertainment. Again.



## Troubleshooting

*If you are experiencing product operation problems, please review the troubleshooting section before you call for service. Refer to the Limited Warranty for information on how to obtain repair service.*

### Player won't work

- Reset the DVD Player by unplugging the AC power cord and plugging it back in.

### No Power

- Plug in the DVD Player. Make sure both ends of the AC power cord are securely plugged into the player and into an AC outlet.

### Disc won't play

- Insert a disc with the label side facing up.
- Check the type of disc you put into the player. This player only plays DVD video discs, Video CDs, audio CDs, CD-R discs and CD-RW discs.
- If the disc is a DTS music CD, it requires a DTS decoder.
- Both the player and the disc are coded by region. If the regional codes don't match, the disc can't be played. This player is Region No. 1.

### Play starts, but then stops immediately

- The disc is dirty. Clean it.
- Condensation has formed. Allow player to dry out. For more information, go to page 63.

### No picture

- Turn your TV to its Video Input Channel. For more information, go to page 21.
- Turn on the TV.
- Make sure your player is connected properly. Make sure all cables are securely inserted into the appropriate jacks.

### No sound or distorted sound

- Make sure your player is connected properly. Make sure all cables are securely inserted into the appropriate jacks.
- You may need to readjust the *Digital Audio Out* setting (see chapter 4).
- Turn your TV to its Video Input Channel. For more information, go to page 21.
- Sound is muted during still, frame advance, or slow-motion play.
- If you connected an audio or audio/video receiver to your DVD Player, make sure you chose the correct setting in the Digital Audio Out menu. For more information, go to page 56.
- Make sure you have checked the Dolby Digital and DTS boxes in the Digital Audio Out menu.

### Player skips over songs on my MP3 disc

- Be sure that you have encoded the file as MPEG-1 layer III.
- Increase the bit rate (quality) the next time you create a CD.

### The ID3 information is not displayed for some files

- When creating a disc, use ID3 version 1 tags.

## Troubleshooting

### Remote control won't work

- If you are using a universal remote, you might be in the wrong mode. To operate your DVD Player, press DVD on the remote before you press any other buttons. If you're operating the TV, press the TV button first, etc.
- Insert new batteries in the remote.
- Operate the remote control at a distance of no more than 20 feet.
- Remove any obstacles between the remote and the DVD Player or other component. If your DVD Player is in an entertainment cabinet, the glass doors may be obstructing the remote control from operating the unit. Open the doors.
- Reset the remote. Remove batteries and hold down one or more buttons for about one minute to drain the microprocessor inside the remote to reset it. Reinstall batteries and try the remote again.

### Can't advance through a movie

- You can't advance through the opening credits and warning information that appear at the beginning of movies because the disc is programmed to prohibit that action.

### The icon appears on screen

- The feature or action cannot be completed at this time because:
  - The disc's software restricts it.
  - The disc's software doesn't support that feature (e.g., angles).
  - The feature is not available at the moment.
  - You've requested a title or chapter number that doesn't exist.

### The picture is distorted

- Did you connect your VCR to the DVD Player? Disconnect it. See chapter 1 for the correct setup and connection.
- The disc might be damaged. Try another disc.

### Picture is distorted during forward and reverse scan

- It is normal for some distortion to appear while scanning.

### A screen saver appears on the TV

- Your player is equipped with a screen saver that appears on the TV after your player has been idle for several minutes. Press STOP or GO BACK on the remote to make the screen saver disappear from the screen and return to the player's main menu.

### Subtitle and/or audio language is not the one selected from the initial setting

- If the subtitle and/or audio language you've chosen as the default does not exist on the disc, the initial settings will not be seen/heard. The disc's priority language is selected instead. Set the subtitle and/or audio language manually through the Info Display or the player menu.

### The menu is displayed in a foreign language

- The Menu Language preference is set to that language. From the DVD player's main menu, select the *Player Menu* option. Highlight the language you prefer and press OK.

### Play doesn't begin

- The rating of the title on the disc exceeds the rating limit set in the *Rating List* when you press PLAY. Unlock the player or change the rating limit in those menus (see chapter 4).

# Other Information

---

## Troubleshooting

### No forward or reverse scan

- Some discs have sections that prohibit rapid scanning, or title and chapter skip.
- If you're trying to skip through the warning information and credits at the beginning of a movie, you won't be able to. This part of the movie is often programmed to prohibit skipping through it.

### Camera angle cannot be changed

- Some discs don't have the multi-camera angles, and some discs only have it in certain parts of the movie.

### Picture is too tall and thin

- Change the aspect ratio using the *TV Aspect* setting in the main menu (see chapter 4).

### Picture is too short and wide

- Change the aspect ratio using the *TV Aspect* setting in the main menu (see chapter 4).

### Cannot copy discs to video tape

- You can't record DVD discs onto videocassettes because the discs are encoded with anti-copy protection.

### Disc won't eject

- When you put a disc into the player, the player may take up to 15 seconds to read the disc. You won't be able to eject the disc during this time. Wait 15 seconds and try again.

### Forgot password

- Point the remote at the DVD player. Press and hold the STOP button on the front of the DVD Player and the STOP button on the remote control at the same time (hold both buttons down at the same time for at least 3 seconds). The player will unlock. Follow the instructions for locking your player and changing the password in Chapter 4.



## Handling Cautions

- Before connecting other components to this player, be sure to turn all components off.
- Don't move the player while a disc is being played. The disc may get scratched or broken, and the player's internal parts may be damaged.
- Don't put any container filled with liquid or any small metal objects on the player.
- Be careful not to put your hand into the disc tray.
- Don't place anything other than the disc in the disc tray.
- Exterior influences such as lightning and static electricity can affect normal operation of this player. If this occurs, turn the player off and on again with the ON•OFF button, or disconnect and then reconnect the AC power cord to the AC power outlet. The player will operate normally.
- Be sure to remove the disc and turn off the player after use.

## Maintenance of Cabinet

For safety reasons, when cleaning the cabinet be sure to disconnect the AC power cord from the AC outlet.

- Do not use benzene, thinner, or other solvents for cleaning.
- Wipe the cabinet with a soft cloth.

## Formation of Condensation

- Due to sharp changes in temperature and humidity, condensation may form if warm air comes in contact with any cold parts inside the player.
- When condensation forms inside the player, the player may not operate correctly. If this occurs, leave the player at room temperature until the inside of the player becomes dry and operational.
- If condensation forms on a disc, wipe the disc with a soft, dry cloth by moving the cloth from the center hole toward the outer edge.

## Handling Discs

- Don't touch the disc's signal surfaces. Hold by the edges or by one edge and the hole in the center.
- Don't affix labels or adhesive tape to label surfaces. Don't scratch or damage the label.
- Do not use damaged (cracked or warped) discs.

## Cleaning Discs

- Dirty discs can cause reduced video and audio performance. Always keep discs clean by wiping them gently with a soft cloth from the inner edge toward the outer perimeter.
- If a disc becomes very dirty, wet a soft cloth in water, wring it out well. Wipe the dirt away gently, and remove any water drops with a dry cloth.
- Do not use record-cleaning sprays or anti-static agents on discs. Also, never clean the discs with benzene, thinner, or other volatile solvents which may cause damage to the disc surface.

# Other Information

---

## Limited Warranty

### What your warranty covers:

- Defect in materials or workmanship.

### For how long after your purchase:

- 90 days from date of purchase - Unit exchange, which includes parts and labor.
- 91 days to 1 year from date of purchase - Unit exchange, which includes parts only; you pay the labor.
- The warranty for rental units begins with the first rental or 45 days from date of shipment to the rental firm, whichever comes first.

### What we will do:

#### During the initial 90 days:

Exchange the DVD unit with a new or, at our option, refurbished unit.

#### After the 90 days and within one year:

Exchange the DVD unit with a new or, at our option, refurbished unit. We will bill you a flat exchange charge to replace a defective unit. This charge covers the labor cost for its repair.

#### How you get service:

- Call 1-800-311-9263 and have your unit's date of purchase and model/serial number ready. The model/serial number information is on the back of your unit.
- A representative will troubleshoot your problem over the phone.
- If the representative determines that you should receive a replacement unit you will be provided with a Service Request (SR) number and the location of a nearby exchange point if one exists. No returns will be accepted without the SR number.
- Proof of purchase in the form of a bill of sale or receipted invoice which is evidence that the product is within the warranty period must be presented to obtain warranty service. For rental firms, proof of first rental is also required.

### To receive a replacement unit before you return yours:

#### Option I:

1. Provide your Discover, MasterCard or Visa account number and expiration date to your phone representative. This is for security purposes only and your account will not be charged at this time.
2. We will send you a replacement unit.
3. If you return the unit to us within 14 days from the date you were provided a SR number, only items not covered by warranty will be charged to your account. If your unit is not received within 14 days, the suggested retail value of the unit will be charged to your credit card. This amount will be credited, less a \$10 handling fee, if the unit is subsequently received.
4. Ship your defective unit back to us using the replacement unit's carton. Shipping instructions will be included on the carton along with your SR number which will allow you to easily ship the unit back to us. Make sure you insure your shipment in case of damage or loss. Include with the shipment:
  - Evidence of purchase date such as a bill of sale.
  - A brief note describing your unit's problem.
  - Your name, address and phone number.

#### Option II:

1. For a fee of \$10.00, we will send a replacement unit to our exchange point.
2. The exchange location will notify you of its arrival.
3. Take your unit and evidence of purchase date, such as a bill of sale, to the exchange location and you will be provided the new or refurbished unit. Please retain all accessories such as the remote control hand unit.
4. If the repairs are covered by your warranty, you will not be billed.

Thomson assumes no responsibility for warranty shipments from the customer to the factory if not shipped in the manner prescribed by Thomson. Return transportation, storage, handling and insurance costs are your responsibility. We accept no responsibility in case of damage or loss. To receive a replacement unit after we have received your unit:

- Write the SR number on the outside of the carton used to return the unit. Make sure you insure your shipment in case of damage or loss.
- Carefully pack the unit using the original box and packing material if possible. Please retain all accessories that were included with your unit such as the remote control hand unit.
- Include with the shipment:
  1. Evidence of purchase date, such as a bill of sale, to verify your unit's warranty eligibility.
  2. A brief note describing your unit's problem.
  3. Your name, address and phone number.
- The representative will advise the address to mail a cashier's check or money order for payment if there are any out of warranty labor or parts charges, and you elect not to use your credit card.
- After we receive your product, a new or refurbished unit will be shipped to you.

## What your warranty *does not* cover:

- Acts of nature, such as but not limited to lightning damage.
- Adjustment of customer controls.
- Damage from misuse or neglect.
- A unit that has been modified or incorporated into other products or is used for institutional or other commercial purposes.
- Batteries.
- Units purchased or serviced outside the U.S.A.
- Shipping damage if the unit was not packed and shipped in the manner prescribed by Thomson.
- Storage fees may be charged by the exchange point if you fail to pickup the replacement unit in a timely manner.

## Product Registration:

- Please complete and mail the Product Registration Card packed with your DVD product. It will make it easier to contact you should it ever be necessary. The return of the card is not required for warranty coverage.

## Limitation of Warranty:

- THE WARRANTY STATED ABOVE IS THE ONLY WARRANTY APPLICABLE TO THIS PRODUCT. ALL OTHER WARRANTIES, EXPRESS OR IMPLIED (INCLUDING ALL IMPLIED WARRANTIES OF MERCHANTABILITY OR FITNESS FOR A PARTICULAR PURPOSE) ARE HEREBY DISCLAIMED. NO VERBAL OR WRITTEN INFORMATION GIVEN BY THOMSON MULTIMEDIA INC., ITS AGENTS OR EMPLOYEES SHALL CREATE A WARRANTY OR IN ANY WAY INCREASE THE SCOPE OF THIS WARRANTY.
- REPAIR OR REPLACEMENT AS PROVIDED UNDER THIS WARRANTY IS THE EXCLUSIVE REMEDY OF THE CONSUMER. THOMSON MULTIMEDIA INC. SHALL NOT BE LIABLE FOR INCIDENTAL OR CONSEQUENTIAL DAMAGES RESULTING FROM THE USE OF THIS PRODUCT OR ARISING OUT OF ANY BREACH OF ANY EXPRESS OR IMPLIED WARRANTY ON THIS PRODUCT. THIS DISCLAIMER OF WARRANTIES AND LIMITED WARRANTY ARE GOVERNED BY THE LAWS OF THE STATE OF INDIANA. EXCEPT TO THE EXTENT PROHIBITED BY APPLICABLE LAW, ANY IMPLIED WARRANTY OF MERCHANTABILITY OR FITNESS FOR A PARTICULAR PURPOSE ON THIS PRODUCT IS LIMITED TO THE APPLICABLE WARRANTY PERIOD SET FORTH ABOVE.

## How state law relates to warranty:

- Some states do not allow the exclusion nor limitation of incidental or consequential damages, or limitations on how long an implied warranty lasts, so the above limitations or exclusions may not apply to you.
- This warranty gives you specific legal rights, and you also may have other rights that vary from state to state.

## If you purchased your product outside the United States:

- This warranty does not apply. See your dealer for warranty information.

**This page intentionally left blank.**

## Accessories and Order Form



Optical Plug to Optical Plug DV3 (3 ft.) DV6 (6 ft.)



Optical Plug to Mini Plug DV3M (3 ft.) DV6M (6 ft.)

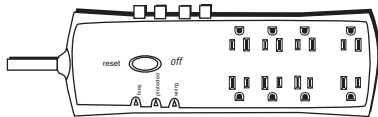

Surge Protector (SCTV160)

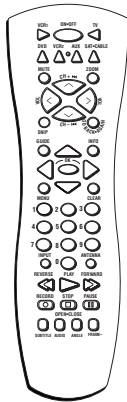

Remote Control (CRK76DG1)

### Accessory Order Form for Your DVD Player

Description	Part No.	Price	Qty
Optical Plug to Optical Plug (3 ft.)	DV3	\$15.95	
Optical Plug to Optical Plug (6 ft.)	DV6	\$19.95	
Optical Plug to Mini Plug (3 ft.)	DV3M	\$15.95	
Optical Plug to Mini Plug (6 ft.)	DV6M	\$19.95	
Remote Control (CRK76DG1)	246773	\$19.95	
Surge Protector	SCTV160	\$49.95	

Total Merchandise .....	\$
Sales Tax .....	\$
We are required by law to collect the appropriate sales tax for each individual state, country, and locality to which the merchandise is being sent.	
Shipping and Handling .....	\$ 5.00
Total Amount Enclosed .....	\$
Use VISA or MasterCard preferably. Money order or check must be in U.S. currency only. No COD or CASH.	

Prices are subject to change without notice.

All accessories are subject to availability.

**Please complete other side also.**



Detach Here

# Other Information

Charge your order on your VISA, MasterCard, or Discover Card by filling in below

## USE YOUR CREDIT CARD

**IMPORTANT:** Copy complete account number from your VISA card



My card expires:

**IMPORTANT:** Copy complete account number from your MasterCard



Copy Number above your name on MasterCard

My card expires:

**IMPORTANT:** Copy complete account number from your Discover Card



My card expires:

AUTHORIZED SIGNATURE

(Credit card order will not be processed without signature)

Print or type your name and address clearly.



A complete and correct order will save you days of waiting.

Name: \_\_\_\_\_  
Street: \_\_\_\_\_  
Apt. \_\_\_\_\_  
City: \_\_\_\_\_  
State: \_\_\_\_\_ Zip: \_\_\_\_\_  
Daytime Telephone No.: \_\_\_\_\_

Please make sure that both sides of this form have been filled out completely.

- Allow 4-6 weeks for delivery.
- All accessories are subject to availability.
- Prices are subject to change.

## To Place an Order

To place your order by phone, have your Visa, MasterCard or Discover Card ready and call the toll-free number listed below.

Use this number only to place an order for accessory items listed on this order form.

1-800-338-0376

To place your order by mail, detach and mail the completed order form with credit card information, money order or check in US currency (made payable to Thomson multimedia Inc.) to the following address:

Video Accessories  
PO Box 8419  
Ronks, PA 17573

## Symbols

- 3-D Surround button 23
- 4 x 3 Letterbox 55
- 4 x 3 Standard 55

## A

- A•B Repeat 34, 44
- Accessories 67
- Angle, camera 33
- Arrow buttons 23
- Aspect ratio 55
- Audio
  - Dolby Digital 12
- AUDIO button 23
- Audio CD
  - Playing 40
- Audio equipment
  - Dolby Digital 12
  - DTS 12
- Audio language 33

## B

- Batteries, remote 20
- Bookmarks
  - recalling 34, 41
  - storing 34, 41
  - using 34, 41
- Buttons
  - ANGLE 23
  - arrow buttons 23
  - AUDIO 23
  - CH + and CH - 23
  - CLEAR 23
  - component 23
  - DVD 20
  - FORWARD 23
  - FRAME - 23
  - GO BACK•AGAIN 24
  - GUIDE 24
  - INFO 24
  - MENU 24
  - Numbers (0-9) 24
  - OK 24
  - ON•OFF 20
  - OPEN•CLOSE 24
  - PAUSE 19, 24
  - PLAY 19, 24
  - REVERSE 24
  - SKIP FWD 19
  - SKIP REV 19
  - SNIP 24
  - STOP 24
  - SUBTITLE 24
  - ZOOM 24, 38

## C

- Cables 8
  - audio/video 8
  - coaxial 8
  - COMPONENT VIDEO 8
  - for RF jacks 8
  - for Y, Pb, Pr jacks 8
  - optical 8
  - S-Video 8
- Camera angle 33
- Cancelling repeat feature 35, 44
- CH + and CH - 23
- Changing the Menu Language 52
- Chapter advance 38
- Chapter, selecting 32
- Cleaning discs 63
- CLEAR button 23
- Codes for remote
  - cable box 26
  - satellite receiver 26
  - VCR 26
- Component Video 8
- Connections
  - 5.1 channel digital audio 13
  - Dolby Digital 13
  - DTS receiver 13
  - DVD Player + TV 9
  - DVD Player + TV + VCR 11
  - DVD player + TV + VCR + Satellite Receiver 17
- Connections, types of 7
- Controls
  - front panel 19
  - remote 23

## D

- DIGITAL AUDIO OUT jack 8, 12
- Digital Output
  - Dolby Digital 56
  - DTS 56
- Discs
  - cleaning 63
  - handling 63
  - menu 30
- Dolby Digital receiver 8
- Dolby Pro Logic 13, 15
- DTS 12
- DTS Receiver 13
- DVD disc
  - programming 36, 43
- DVD Limits menu
  - rated Titles 54

## F

- Fast motion playback 37
- FORWARD button 23
- Frame advance 38
- Freeze frame (pause) 38
- Front panel controls 19

## G

- GO BACK•AGAIN button 24
- Grayed out 31
- GUIDE button 24

## H

- Handling
  - cautions 63
  - discs 63
  - DVD Player 63
- How to find your TV's video input channel 22

## I

- Icons 31
- INFO button 24
- Info Display
  - Audio CD 40
  - picture of 31
  - using 31
- Installing batteries 20
- Invalid icon 22, 31, 37

## J

- Jacks 8
  - ANTENNA A IN 8
  - ANTENNA B IN 8
  - audio/video 8
  - COMPONENT VIDEO 8
  - DIGITAL AUDIO OUT 8
  - SATELLITE IN 8

## L

- Language
  - changing the menu 52
  - subtitles 51, 52
- Linear PCM 56

## M

- Maintenance 63
- MARKER button 24
- MENU button 24
- Menu system 22
- Menus
  - action 50
  - path 50
  - types 50

Motion Pictures Association of America 54

## N

Navigation 22

Number buttons 24

## O

OK button 24

ON•OFF button 23

On-screen info display 31, 40

OPEN•CLOSE button 24

Optical cable 8

Order form, accessories 67

## P

Path menu item 50

PAUSE button 19, 24

Picture scan 37

PLAY button 19, 24

Play Menu

    program play 36, 42

    random play 36, 42

PLAY MODE button 24

Playback features

    audio language 33

    bookmarks 34, 41

    camera angle 33

    chapter advance 38

    fast motion 37

    repeat 34, 44

    selecting a chapter 32

    slow motion 38

    using remote 37

Playing

    audio CD 40

    digital video discs 29

Program

    DVD disc 36, 43

    editing 36, 43

## R

RANDOM button 24

Rated Titles 54

Rating Limits 54

RCA-type cables 8

Recalling bookmarks 34, 41

Remote 23

    component buttons 23

    DVD buttons 23

    installing batteries 20

    pointing 20

    tour 23

Repeat 34, 44

    cancelling 35, 44

REVERSE button 24

## S

SATELLITE IN jack 8

Selecting a chapter 32

Shuttle control 37

SKIP FWD button 19

SKIP REV button 19

Slow motion playback 38

SNIP button 24

STOP button 19, 24

Storing bookmarks 34, 41

SUBTITLE button 24

Subtitle language 51, 52

## T

Title 31

Troubleshooting 60, 61, 62

TV buttons 23

TV's Video Input Channel 21

Types of Discs the Player Can Play 20

## U

Using bookmarks 34, 41

## V

Video CD

    description 38

    Disc Menu 38

Video Input Channel 21

## W

Warranty 64

## Y

Y Pb Pr jacks 8

## Z

ZOOM button 24, 38

Zoom feature 38





Please do not send any products to the Indianapolis address listed in this manual or on the carton. This will only add delays in service for your product.

**Thomson multimedia Inc.**

**10330 North Meridian Street  
Indianapolis, IN 46290**

©2001 Thomson Consumer Electronics, Inc.  
Trademark(s)® Registered  
Marca(s) Registrada(s)  
Printed in P.R.C.  
TOCOM 15794100



## Free Manuals Download Website

<http://myh66.com>

<http://usermanuals.us>

<http://www.somanuals.com>

<http://www.4manuals.cc>

<http://www.manual-lib.com>

<http://www.404manual.com>

<http://www.luxmanual.com>

<http://aubethermostatmanual.com>

Golf course search by state

<http://golfingnear.com>

Email search by domain

<http://emailbydomain.com>

Auto manuals search

<http://auto.somanuals.com>

TV manuals search

<http://tv.somanuals.com>