

RTD615i

FCC Information

This device complies with part 15 of the FCC Rules. Operation is subject to the following two conditions: (1) This device may not cause harmful interference, and (2) this device must accept any interference received, including interference that may cause undesired operation.

This equipment has been tested and found to comply with the limits for a Class B digital device, pursuant to part 15 of the FCC Rules. These limits are designed to provide reasonable protection against harmful interference in a residential installation. This equipment generates, uses and can radiate radio frequency energy and, if not installed and used in accordance with the instructions, may cause harmful interference to radio communications.

However, there is no guarantee that interference will not occur in a particular installation. If this equipment does cause harmful interference to radio or television reception, which can be determined by turning the equipment off and on, the user is encouraged to try to correct the interference by one or more of the following measures:
• Reorient or relocate the receiving antenna.
• Increase the separation between the equipment and receiver.
• Connect the equipment into an outlet on a circuit different from that to which the receiver is connected.
• Consult the dealer or an experienced radio / TV technician for help.

WARNING: Changes or modifications to this unit not expressly approved by the party responsible for compliance could void the user's authority to operate the equipment.



This Home Theater has earned the ENERGY STAR.

Ventilation

You must adequately ventilate the product. Make sure there is adequate space around the unit to provide proper air flow for ventilation. See diagram.

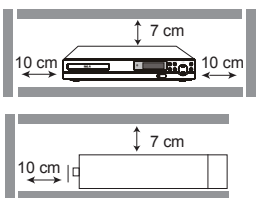

This product complies with DHHS Rules 21 CFR Subchapter J. Applicable at the date of manufacture.

For your safety

The AC power plug is polarized (one blade is wider than the other) and only fits into AC power outlets one way. If the plug won't go into the outlet completely, turn the plug over and try to insert it the other way.

If it still won't fit, contact a qualified electrician to change the outlet, or use a different one. Do not attempt to bypass this safety feature.

Removing the power plug is the only way to completely remove power from your product. Make sure the power plug remains easily accessible.

Note: This DVD player is designed and manufactured to respond to the Region Management Information. If the Region number of a DVD disc does not correspond to the Region number of this DVD player, this player cannot play the disc. The Region number for this DVD player is Region 1.

FCC Information



THE LIGHTNING FLASH AND ARROWHEAD WITHIN THE TRIANGLE IS A WARNING SIGN ALERTING YOU OF "DANGEROUS VOLTAGE" INSIDE THE PRODUCT.

THE EXCLAMATION POINT WITHIN THE TRIANGLE IS A WARNING SIGN ALERTING YOU OF IMPORTANT INSTRUCTIONS ACCOMPANYING THE PRODUCT.

CAUTION: TO REDUCE THE RISK OF ELECTRIC SHOCK, DO NOT REMOVE COVER (OR BACK). NO USER SERVICEABLE PARTS INSIDE. REFER SERVICING TO QUALIFIED SERVICE PERSONNEL.

WARNING: TO PREVENT FIRE OR ELECTRICAL SHOCK HAZARD, DO NOT EXPOSE THIS PRODUCT TO RAIN OR MOISTURE.

CAUTION: USE OF CONTROLS OR ADJUSTMENTS OR PERFORMANCE OF PROCEDURES OTHER THAN THOSE SPECIFIED MAY RESULT IN HAZARDOUS RADIATION EXPOSURE.

CAUTION: DANGER OF EXPLOSION IF BATTERY IS INCORRECTLY REPLACED. REPLACE ONLY WITH THE SAME OR EQUIVALENT TYPE.

WARNING: TO BE COMPLETELY DISCONNECT THE POWER INPUT, THE MAINS PLUG OF APPARATUS SHALL BE DISCONNECTED FROM THE MAINS. THE MAINS PLUG OF APPARATUS SHOULD NOT BE OBTSTRUCTED OR SHOULD BE EASILY ACCESSED DURING INTENDED USE.

Service information

This product should be serviced only by those specially trained in appropriate servicing techniques.

Main plug is used as the disconnect device, it shall remain operable and should not be obstructed during intended use. To be completely disconnected the apparatus from supply mains, the main plug of the apparatus shall be disconnected from the mains socket outlet completely.

Caution Invisible laser radiation when open and interlocks defeated. Avoid exposure to beam. Class 1 laser product. This system must be opened only by qualified technicians to prevent accidents caused by the laser beam.

DVD copy protection

In accordance with the DVD standard, your DVD player is equipped with a Copy Protection system, which can be switched on and off by the DVD disc itself, in order to make any recording of the relevant DVD disc onto a videotape of very poor picture quality, or even impossible. This product incorporates copyright protection technology that is protected by method claims of certain U.S. patents and other intellectual property rights owned by Macrovision Corporation and other rights owners. Use of this copyright protection technology must be authorized by Macrovision Corporation, and is intended for home use only unless otherwise authorized by Macrovision Corporation Reverse engineering or disassembly is prohibited.

Important Information

Important battery information

- Do not mix different types of batteries or new and old batteries. Do not use rechargeable batteries.
• In order to avoid any risk of explosion, observe the polarities indicated inside the battery compartment. Replace only with the type of batteries specified. Do not dispose of them in a fire or recharge them.
• If you are not using the remote control for a long period of time, remove the batteries.

Please respect the environment and prevailing regulations. Before you dispose of batteries or accumulators, ask your dealer whether they are subject to special recycling and if they will accept them for disposal.



Illustrations contained in this document are for representation only.



CAUTION:

This product utilizes a laser. Use of controls or adjustments or performance of procedures other than those specified may result in hazardous radiation exposure. Do not open covers and do not repair yourself. Refer servicing to qualified personnel.

This class B digital apparatus complies with Canadian ICES-003. Cet appareil numérique de la classe B est conforme à la norme NMB-003 du Canada.

WARNING To reduce the risk of fire or electric shock, do not expose this product to rain or moisture. No objects filled with liquids, such as vases, should be placed on the apparatus.

Important Safety Instructions

Please read and save for future reference.

Some of the following information may not apply to your particular product; however, as with any electronic product, precautions should be observed during handling and use.
• Read these instructions.
• Keep these instructions.
• Heed all warnings.
• Follow all instructions.
• Do not use this apparatus near water.
• Clean only with a dry cloth.
• Do not block any ventilation openings. Install in accordance with the manufacturer's instructions.
• Do not install directly near any heat sources such as radiators, heat registers, stoves, or other apparatus (including amplifiers) that produce heat.
• Only use attachments / accessories specified by the manufacturer.

- Do not defeat the safety purpose of the polarized or grounding-type plug. A polarized plug has two blades with one wider than the other. A grounding type plug has two blades and a third grounding prong. The wide blade or the third prong is provided for your safety. If the provided plug does not fit into your wall outlet, consult an electrician for replacement of the obsolete outlet.
• Protect the power cord from being walked on or pinched particularly at plugs, convenience receptacles, and the point where they exit from the apparatus.
• Unplug this apparatus during lightning storms or when unused for long periods of time.
• Refer all servicing to qualified service personnel. Servicing is required when the apparatus has been damaged in any way, such as the power cord or plug is damaged, liquid has been spilled or objects have fallen into the apparatus, the apparatus has been exposed to rain or moisture, does not operate normally, or has been dropped.

Additional safety information

The apparatus shall not be exposed to dripping or splashing and that no objects filled with liquids, such as vases, shall be placed on the apparatus.
• Always leave sufficient space around the product for ventilation. Do not place product in or on bed, rug in a bookcase or cabinet that may prevent air flow through vent openings.
• Do not place lighted candles, cigarettes, cigars, etc., on the product.
• Connect power cord only to AC power source as marked on the product.
• Care should be taken so that objects do not fall into the product.
• Do not attempt to disassemble the cabinet. This product does not contain customer serviceable components.

If your product operates on batteries, adhere to the following precautions:

- A. Any battery may leak electrolyte if mixed with a different battery type, if inserted incorrectly, or if all batteries are not replaced at the same time.
B. Any battery may leak electrolyte or explode if disposed in fire or an attempt is made to charge a battery not intended to be recharged.
C. Discard leaky batteries immediately. Leaking batteries can cause skin burns or other personal injury. When discarding batteries, be sure to dispose of them in the proper manner, according to your state/provincial and local regulations.
D. Battery shall not be exposed to excessive heat such as sunshine, fire or the like.

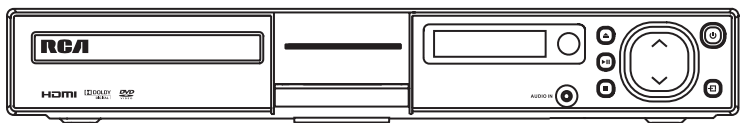

It's important to read this instruction prior to using your new product for the first time.

Connections and Setup

Accessories provided

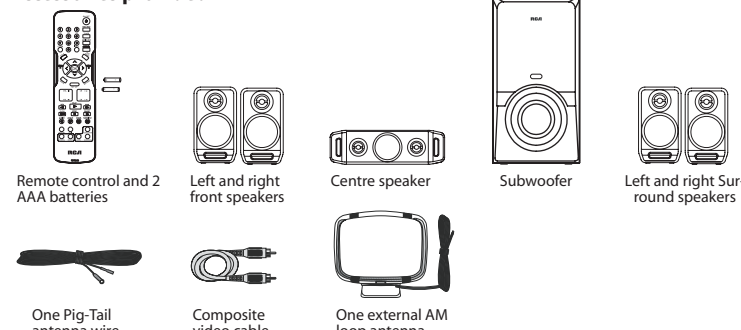

Things to consider before you connect

- Ensure that the mains supply in your house complies with that indicated on the identification sticker located on the back of your unit.
• Install your unit horizontally, away from any source of heat (fireplace) or appliances creating strong magnetic or electric fields.
• The components of this unit are sensitive to heat. The maximum ambient temperature should not exceed 35°C / 95°F.
• Leave enough space around the unit to allow adequate ventilation: 10 cm/4 inches on either side and above the top, and 5 cm/2 inches at the rear.
• The humidity of the room should not exceed 75%. If you have to use the unit outdoors, do not expose to rain or splashing water. The apparatus should not be exposed to dripping or splashing and no objects filled with liquids, such as vases, should be placed on the apparatus.
• Moving the unit from a cold place to a warm one can cause condensation on some components inside the unit. Let the condensation disappear on its own before turning the unit on again.
• Before moving the unit, make sure the disc tray is empty.
• Where the mains plug or an appliance coupler is used as a disconnect device, the disconnect device shall remain readily operable.
• Other important use and cleaning information at the end of the booklet.

Connecting the antennas

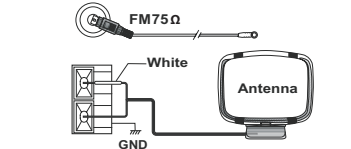

The AM and FM antennas connect to the AM and FM terminals on the systems back panel. They must be hooked up in order to receive clear reception.

AM Loop Antenna

- 1. Uncoil the AM antenna wire.
2. Press down on the antennas tab to open the terminal.
3. Make sure the white wire on the AM loop antenna is inserted into the AM loop terminal and the other wire is inserted into the ground loop terminal.

Connections and Setup

Connecting to your TV (VIDEO)

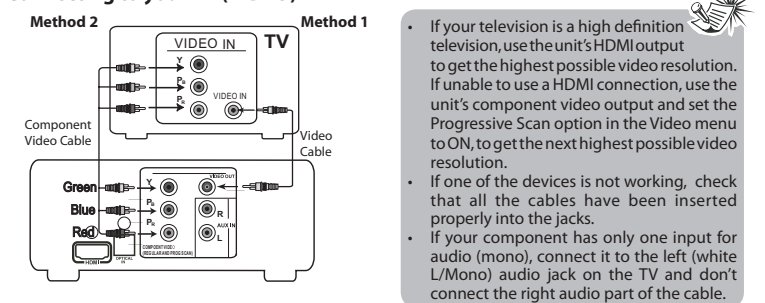

- Method 1: If your television is a high definition television, use the unit's HDMI output to get the highest possible video resolution. If unable to use a HDMI connection, use the unit's component video output and set the Progressive Scan option in the Video menu to ON to get the next highest possible video resolution.
• If one of the devices is not working, check that all the cables have been inserted properly into the jacks.
• If your component has only one input for audio (mono), connect it to the left (white L/Mono) audio jack on the TV and don't connect the right audio part of the cable.

- Method 2: Composite video jacks (Pr, Pb, Y)
• The component video jacks are color-coded green, blue and red.
• Additional component video cables (not supplied) are required to provide best picture quality. They are usually color-coded green, blue and red.
• Connect the component video OUT jacks on the receiver to the component video IN jacks on your TV so the video content goes from the receiver to the screen.

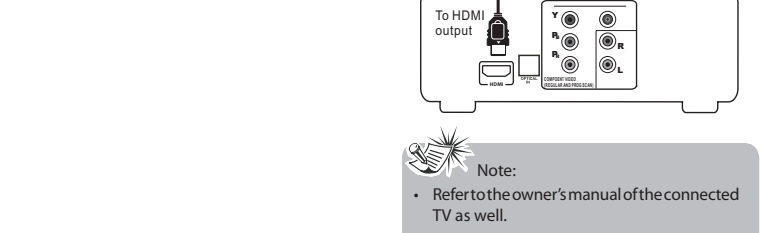

Overview of Controls

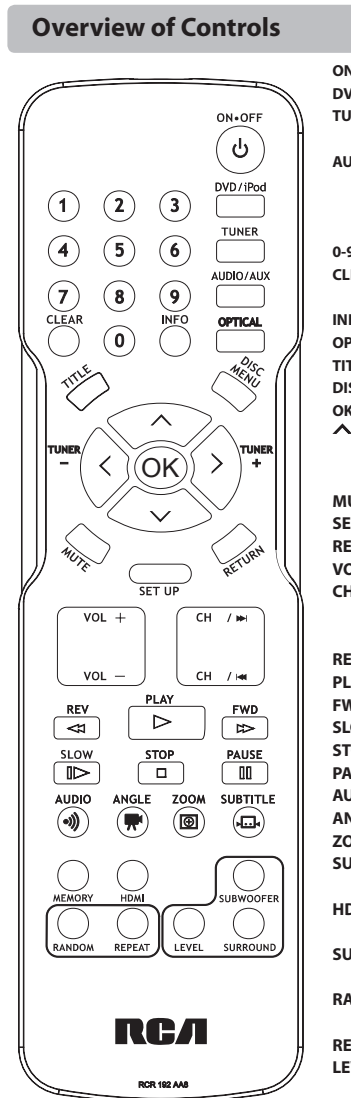

- ON-OFF: Turn on/off the unit.
DVD/iPod: Switch between DVD and iPod mode.
TUNER: Select the TUNER and selects between FM/AM.
AUDIO/AUX: Select and toggle between the Front AUDIO IN mode and the Rear Auxiliary input (for listening to audio input from connected TV, VCR or SAT/Cable Box).
0-9: Number entry.
CLEAR: Clear the current setting manually from the TV screen without saving change.
INFO: Access the Info menu.
OPTICAL: Select digital audio input.
TITLE: Access the title menu of DVD discs.
DISC MENU: Access the disc menu during playback.
OK: Confirm your selection.
NAVIGATION: Navigate through the menus.
MUTE: Mute and restore the sound.
ENTER: Enter Setup menu.
RETURN: In DVD mode, return to the previous menu.
VOL +/-: Adjust the sound volume.
CH +/-: Directly access the next or previous chapter (DVD) or track (CD).
REV: Start reverse accelerated play.
PLAY: Start playing a disc.
FWD: Start forward accelerated play.
SLOW: Start SLOW motion function.
STOP: Stop playback.
PAUSE: Freeze frame, access frame advance.
AUDIO: Access the audio function.
ANGLE: Access the camera angle function for DVD disc.
ZOOM: Access the Zoom function.
SUBTITLE: Select the subtitle languages or turns subtitle off (if available).
HDMI: Change video output signals (480p, 720p, 1080i or 1080p).
SUBWOOFER: Select among subwoofer output levels (soft/balance/strong/powerful).
RANDOM: Turn on/off random playback on CDDA/iJPEG discs.
REPEAT: Access the repeat function.
LEVEL: Toggle channels for different level settings. Adjust the value using VOL +/-.

Overview of Controls

- SURROUND: Changes the Surround sound setting. In DVD mode, press the button to select between S:1 ch and STEREO modes. In the AUDIO/AUX mode (analog input), press the button to select between S:1 CHANNEL and STEREO modes.
Remote control functions in tuner mode:
TUNER: Select the TUNER and switch between FM/AM.
VOL +/-: Adjust the sound volume.
MUTE: Mute and restore the sound.
TUNER +/-: Tune down and up the radio frequencies.
MEMORY: CH+/CH-: Select programmed stations.
AUDIO: Select between Stereo and Mono mode for (FM).
Using remote control to navigate through the on-screen menus:
Use left, right, up, down buttons and OK on the remote control to navigate through the on-screen displays (the DVD player's menu, the Info Display that appears during playback, or a disc's menu).
Use left, right, up, down buttons on the remote control to move through on-screen menus in the direction of the button (e.g., to move right, press right). The buttons are used to highlight an option. Once highlighted, press OK to select the option that is highlighted.
Note: Insert 2 "AAA" batteries into the remote control prior to use.

Playing Discs - Basic Functions

- Compatible discs: DVD, CD, CD-R, CD-RW.
Compatible formats: DVD, JPEG, CD.
Regional coding: Your unit has been designed to process regional management information stored on DVD discs.
Operating the DVD receiver: Turn on your television set, press ON-OFF on the remote control or ON/STANDBY located on the unit's front panel, press DVD on the remote control.
Loading disc: Press the disc button on the front panel to open the disc tray. Place a disc onto the disc tray with the label side up. Press the disc button to close the disc tray.
Playback: Switch the unit and the TV set on. After loading a disc, playback starts automatically, or the disc menu appears.
Accelerated play: While the disc is playing, press REV or FWD one or more times to vary the speed and direction of the accelerated play.
Pause: While the disc is playing, press PAUSE once for freeze frame. Press PLAY to resume normal playback.
Frame advance: Press PAUSE twice, "Step" is displayed. Press PLAY to resume normal playback.

Connections and Setup

- Better surround placement: Location: If possible, place surround speakers to either side of the listening area, not behind it. Height: If space permits, install surround speakers 2-3 feet above viewers.
Alternative Surround Placement: Rear wall: If rear wall mounting is the only choice, aim the speakers at each other (A), towards the front (B) or towards the sidewalls (C, D).
Test tone/Channel balance: Channel balance: Your receiver is equipped with a test signal generator to help balance the audio level for each channel.
Level adjustment and surround channel level expectation: Even though you adjust the surround channel to be as loud as the others on the test signal, you may find that surround channels seems quieter for actual TV and Movie content.

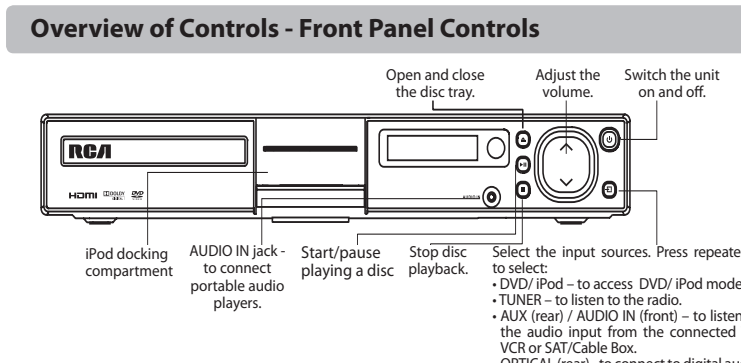

The Info Menu

This option is only available if the disc offers dialog languages or audio formats. When you change the dialog language using the Info menu, it only changes the dialog language of the disc being played. When you eject the disc or switch off the unit, the language will revert to the one you selected in the language Setup menu.

Subtitles (DVD)

Subtitles are turned off by default. Turn on subtitles as follows:

- While the disc is playing, press INFO twice, then select the Subtitles icon using the left/right buttons.
- Select a language using the up/down buttons.
- To turn subtitles off, select the off option or press SUBTITLE on the remote control.

When you change the language of the subtitles using the Info menu, it only applies to the disc currently being played. When you eject the disc and switch off the unit, the subtitles will default to the subtitle language you selected in the Languages menu.

This function may not be available on all discs.

Camera angle (DVD)

Some discs offer different camera angles for specific scenes.

- To change the camera angle, press the ANGLE button on the remote control or press the INFO button twice and select the Camera angle icon with the left/right buttons.
- Choose the angle with the up/down buttons.

If the disc was recorded using a single camera angle, this function is not available.

The Info Menu

Play mode (all discs except jpeg)

- While the disc is playing, press the INFO button twice for CD and three times for DVD.
- Select the Play Mode icon using the left/right buttons.
- Use the up/down buttons to select an option.
 - DVD play modes: standard, program, A-B repeat, title repeat, chapter repeat. Program play mode is only available if a program list has been created (see below). Repeat mode is only available with discs that display elapsed time and remaining time. To repeat a sequence between points A and B, choose the A-B repeat option, and then follow the instructions for entering the two points.
 - Audio CD play modes: standard, introscan, random, program, repeat A-B, repeat disc, repeat track.
- To stop repeat playback, select the Play Mode icon and use the up/down buttons to choose the Standard option.

Creating a Program List for Program Play Mode (Audio CDs and DVD discs)

- To use program play mode, you must first create a program list.
- To create a program list, press the INFO button twice for CD and three times for DVD. Highlight the Play Mode option and press the up arrow to select the Program option.
 - Press OK. The program screen is displayed.
 - The first spot in the list is highlighted. Use the number buttons on the remote control to enter a track number.
 - Use the buttons to move to the next spot in the list. Enter the next track number.
 - Continue entering tracks until you have completed your list.
 - Highlight the Play option at the bottom of the screen and press OK or press PLAY to start playback. The program list will play in the order you programmed it.

The Info Menu

Sleep

- Press INFO button twice for CD and thrice for DVD. Select Sleep icon with the left/right buttons.
- Select one of the available options using the OK button: Off, 30,60,90 or 120 minutes.



Note: This function is only available with discs whose elapsed time or remaining time appears in the Info menu.

Introscon (CD)

- This option plays the first ten seconds of each track on a CD.
- Press the INFO button twice, then select the Play mode icon with the left/right buttons.
 - Press the up/down buttons to select the INTRO option and press OK to start IntroScan.
 - Press STOP to stop Introscon, and press PLAY to resume normal playback.

Bookmark (DVD and audio CD)

- Press INFO twice for CD and three times for DVD. Select the Bookmark icon with the left/right buttons, and press OK. A menu is displayed with five bookmarks.
- The first bookmark space is highlighted. Press OK to set the bookmark. The bookmark is saved and is indicated by the number 1. You can set up to five bookmarks on a disc.
- To start playback from a bookmark, press the PLAY button on the remote control.
- To delete a bookmark, highlight it and press CLEAR.



Note: This function is only available with discs whose elapsed time or remaining time appears in the Info menu.

Radio

The unit has a built-in tuner that allows for FM radio function. The AM loop antenna allows for AM radio function.

Manual tuning

- Connect the FM antenna and the AM loop antenna at the back of the unit.
- Press TUNER.
- Tune a station by pressing TUNER+/repeatedly until the desired station is found. Alternatively, you can press and hold the same buttons down for about one second to activate the automatic search function. In this mode the unit will automatically tune frequencies until it finds a station.
- Repeat step 3 to tune to another radio station.
- Press TUNER to toggle between FM and AM.

Storing radio stations

The unit can store up to 60 radio stations (AM/FM each 30 radio stations) in its memory. You can enter every single radio station yourself or the unit can store all available radio stations automatically in ascending order.

Automatic preset programming

- Press TUNER to enter the Tuner mode.
- Press and hold TUNER for two seconds to start automatic preset programming.
- Radio frequencies will be browsed and radio stations stored automatically. When all the available radio stations are stored or all 30 memory locations are full, the auto preset programming function will stop.

Manual preset

- Tune to a radio station (see "Manual tuning" for details).
- Press MEMORY. While the Program Preset number is still flashing, input your desired preset number using the numeric buttons, then press MEMORY to store it.

Retrieving preset stations

- Press TUNER to enter the Tuner mode.
- Press CH+/-, CH-/+ to search up or down for the preset stations or directly press the numeric buttons.

Radio



- Tips:
- When a strong FM stereo broadcast is tuned, ST is displayed.
 - When you manually tune into a weak FM station, press AUDIO into a remote control to switch from Stereo to Mono mode. This will reduce the background noise.
 - If there is any interference, change the antenna's position until ideal sound reception is obtained. TV and other electronic devices could be the cause of interference, so try to position the antenna away from them.
 - A weak signal can affect the "Automatic preset programming" function's efficiency. Adjust the antenna for better reception and a more efficient search.

iPod

iPod is a trademark of Apple Computer, Inc., registered in the U.S. and other countries.

Compatible iPod Types:

- iPod nano (1st generation) 1GB, 2GB, 4GB
- iPod nano (2nd generation) 2GB, 4GB, 8GB
- iPod nano 3rd generation (video) 4GB, 8GB
- iPod nano 4rd generation (video) 8GB, 16GB
- iPod 5th generation (video) 30GB, 60GB, 80GB
- iPod classic 80GB, 120GB, 160GB
- iPod touch 8GB, 16GB, 32GB

Using an Adaptor to Connecting Your iPod

- Open the iPod docking compartment.

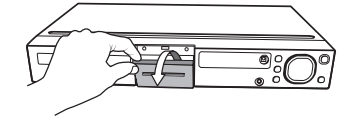

- Choose the iPod Dock Adaptor that fits your iPod (Dock adapters are not included with this product, please use the one that was included with your iPod).

iPod Dock Adaptor (not included)

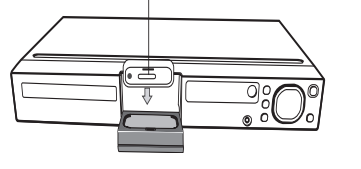

- Insert your iPod Dock Adaptor into the dock until it sits firmly in place.

iPod

- Turn on the unit, press the DVD/iPod button to select IPOD mode. Your iPod will be connected automatically, following screen appears.

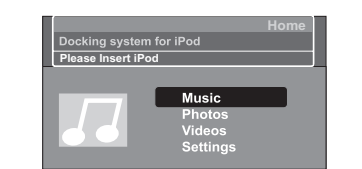

Warning: To prevent damage to the unit and/or your iPod, connect or remove your iPod when the unit is powered off or the unit is not in iPod mode.

Caution: Due to the iPod limitation, not all functions of some iPod models can be controlled via the remote control of this unit. If necessary, operate on your iPod directly.

Removing the iPod Dock Adaptor

- Remove the iPod Dock Adaptor as shown in the figure to the right.
- Replace it with another one you need.

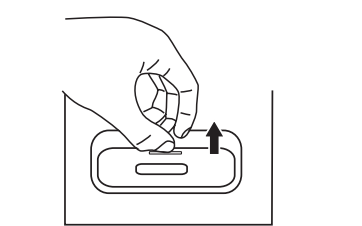

Note: Make sure "TV Out" in the setting of your iPod is set to "On".

AUDIO IN / AUX IN

TV, VCR or SAT/Cable Box can be connected to AUX input jacks at the back of the unit or AUDIO IN at the rear panel so that sound from the auxiliary component comes into the unit and out through the speakers.

Connecting auxiliary components

Refer to "Connecting AUDIO from external sources such as TV" for details on connecting the auxiliary components to the unit.

Selecting AUDIO IN / AUX IN mode

Press either SOURCE on the main unit or AUDIO / AUX on the remote control to select AUX IN or AUDIO IN mode.

Sound output in Aux-In mode

- You may change the surround setting by pressing SURROUND to select between Dolby Prologic and stereo modes.
- If the auxiliary audio signal is mono, there is no output from speakers in either Dolby Prologic or Stereo mode.

Jpeg Files

Displaying jpeg files

Jpeg files are image files. Make sure that they have a resolution of less than 2 megapixels.

- Open the disc tray.
- Place the disc with the printed side facing up and close the disc tray. The folders on the disc will be listed in numerical order on the left side of the screen. When you highlight a folder, then press OK button. The list of pictures in the folder are listed in numerical order on the right side of the screen.

- Select a folder using the up/down buttons on the remote control, then press the left button to move to the picture icons at the bottom of the screen. Use the left/right buttons to select picture mode.
- Press the up button to move to the file list on the right side of the screen. Use the up/down buttons to select a file. Press OK or PLAY to start playback.

- jpeg file: the unit starts the slide show with the jpeg file you have selected, then displays all the jpeg files in the same folder, then all the jpeg files in the subfolders located in the same folder. You can set the amount of time a picture remains on the screen in the Video Setup menu.

During the slide show you can use the left/right buttons to rotate the picture, the up button to rotate the image vertically, the down button to rotate the image horizontally. Use the ZOOM button to magnify the picture. Use the CH-/+ button to go back to the previous picture or the CH+/+ button to go to the next one, and the STOP button to interrupt the slide show and display the disc's contents.

Jpeg Files

Displaying jpeg files

- Press INFO to display the Info menu during play back. Press the up/down button to select a play mode, and press OK.
- When the unit has played all the files, the slide show stops and the disc's contents are displayed again.
- Press STOP to end playback.



Note:

- The time taken for the contents of the disc to be displayed varies according to the size and number of jpeg files on the disc. If nothing is displayed after a few minutes, the file sizes may be too large. Reduce the files' resolution and write another disc.
- Before inserting a disc, make sure it is compatible with the unit.

The Setup Menu

There are four options in the main setup menu: General Setup, Language Setup, Audio Setup and Video Setup.

Press SETUP to bring up the main menu. Select one of the menu icons across the top of the screen using the left/right buttons. The menu's options are displayed on the left side of the screen. Press the right button to move to the option's choices on the right. Press SETUP if you want to exit setup.

General Setup

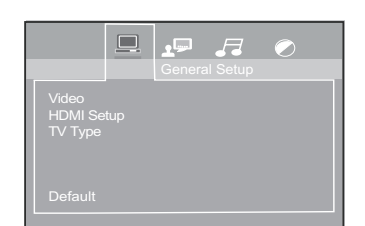

Video

Progressive Scan Output provides higher quality video. Turn on Progressive Scan if you're using the Component Video jacks of the unit to connect a TV or monitor compatible with a progressive scan signal. Select P-Scan YPBPr and press OK to activate Progressive Scan.

HDMI Setup

This lets you select the resolution of the player's output according to the connected TV.

- Supported HD mode: 480p, 720p, 1080i and 1080p.

The Setup Menu

TV Type

Depending on the format of the DVD disc, you can choose the picture format (aspect ratio) best suited to the format of your TV screen:

- 4:3 PS: reproduces a 4:3 picture without distortion.
- 4:3 LB: gives best reproduction of pictures recorded in this format (i.e. with horizontal bands at the top and bottom of the screen) or in 16:9.
- 16:9 (windscreen): reproduces 16:9 format films in full on a 16:9 screen.

Default

This option allows you to return the unit's settings to the original factory settings. Any changes you have made to the unit's settings will be reverted back to the original settings.



IMPORTANT! Once Progressive Scan has been activated, an image will only be visible on a progressive scan TV or monitor. If you choose this option and you don't have a progressive scan TV or monitor, you may get a picture with incorrect color or no color.

The Setup Menu

Language Setup

With this menu, you can set the language for unit menus, dialog, subtitles and the disc menus. If you chose "English" during initial set-up, any menus generated by the disc are in English, and so is the language of the dialogs (if this language is available on the disc).

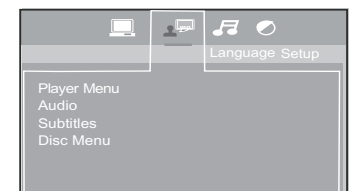

- Select the Language Setup icon in the main menu using the left/right buttons.
- Select one of the options using the up/down buttons.
- Press the right button to move to the language choices.
- Use the up/down buttons to highlight the language of your choice and press OK.

Player Menu

Select the language of player menus and press OK.

Audio

Select the dialog language using up/down buttons and press OK.

To change the Audio language during playback, press INFO twice for DVD and use the left/right buttons to highlight the Audio icon. Press the up/down buttons or AUDIO on the remote control to select audio language.

The Setup Menu

Subtitles

Select the subtitle language using up/down buttons and press OK. To change the language of the subtitles during playback, press INFO twice for DVD and use the left/right buttons to highlight the Subtitle icon. Press the up/down buttons or the SUBTITLE button on the remote control to select a subtitle language.

Disc Menu

To change the language of the disc menus, select the language using the up/down buttons and press OK. The language you select will only be displayed if the disc is programmed with that language.



Notes:

- If the selected language is not available on a disc, the disc's language will be used instead.
- If the language chosen is available, it is automatically selected when you display the subtitles or press SUBTITLE on the remote control. Otherwise, the subtitle language indicated on the disc is selected.

Limited Warranty

AVC MULTIMEDIA ("AVC") makes the following limited warranty. This limited warranty extend to the original consumer purchaser and is limited to non-commercial use of the product.

One Year Parts & Labor Warranty

AVC products purchased in the United States or Canada are warranted to be free from defects in materials or workmanship for a period of one year from the date of their original retail purchase. If the unit fails to conform to this warranty, we will service the product using new or refurbished parts and products, at AVC's sole discretion.

During a period of one year from the effective warranty date, AVC will provide, when needed, service labor to repair a manufacturing defect at its designated Service Center. To obtain warranty service in the United States or Canada, you must first call our Customer Support Center at 1-800-506-5746 or 1-877-252-6873, during the hours listed in the box below. The determination of service will be made by AVC Customer Support. **PLEASE DO NOT RETURN YOUR UNIT TO AVC WITHOUT PRIOR AUTHORIZATION.** New or remanufactured replacements for defective parts or products will be used for repairs by AVC at its designated Service Center for one year from the effective warranty date. Such replacement parts or products are warranted for an additional one year from the date of repair or replacement. The Customer will be required to ship the unit to the Service Center indicated at the time Customer Support is contacted to make the necessary repairs. The customer is responsible for all transportation charges to the service facility.

Packaging and Shipping Instruction

When you send the product to the AVC service facility you must use the original carton box and packing material or an equivalent as designated by AVC.

Your Responsibility

- You must retain the original sale receipt to provide proof of purchase.
- Warranties are effective only if the product is purchased and operated in the United States or Canada.
- Warranties extend only to defects in material or workmanship, and do not extend to any product or parts which have been lost or discarded, or damage to product or parts caused by misuse, accident, improper operation or maintenance, or use in violation of instructions provided with the product, or to product which has been altered or modified without authorization of AVC, or to products or parts thereof which have had the serial number removed or changed.

Technical Specifications:

Amplifier Section:
RMS Output Power: Dolby Digital Mode with 10% Total Harmonic Distortion
Rear Channels: 90 Watts per channel (1KHz, 80) Front Channels: 90 Watts per channel (1KHz, 80) Signal to Noise: 38dB Subwoofer Channel: 120 Watts (100Hz, 60) Total RMS Output Power, Dolby Digital mode: 600 Watts

Muting Attenuation: 70 dB
Frequency Response: 200Hz ~ 20KHz/3dB, 1KHz ref.
Subwoofer Frequency Response: 20Hz ~ 200Hz/3dB, 100Hz ref.
Signal to Noise Ratio: 70 dB (Dolby Digital)

AM Tuner Section:
Frequency Response: 2kHz +/- 3dB, 400Hz ref.
Usable Sensitivity: 3000uV/m @ 5/N 20dB
Signal to Noise: 38dB
IF Rejection: 35dB

FM Tuner Section:
Frequency Response: 15kHz +/- 3dB, 1KHz ref.
Quieting: 24dB
Signal to Noise: 62dB(stereo) / 65dB(mono)
IF Rejection: 70dB

Dimensions (H x W x D mm):
Unit: 66.6 x 430 x 232.4
Front Speakers: 143 x 80.5 x 93
Centre Speaker: 80.5 x 27.2 x 73
Rear Speakers: 143 x 80.5 x 93
Subwoofer: 355 x 195 x 340

iPod

Playing Photos

- In iPod Home menu, use the ^, v button to select Photos and press the OK button.
- Use the ^, v and OK buttons to navigate the iPod menu lists and select a photo, press the OK button to begin playback. (If necessary, operate on your iPod directly.)
- For iPod Touch, touch the iPod screen to begin playback.)
- Press the PAUSE button to pause playback, press the PLAY button again to resume playback.
- Press the CH+/+/- / CH-/ button to skip to the previous / next photo.
- Press the RETURN button to go back to the previous menu.

Using an iPod Touch to view photos

- In iPod Home menu, use the ^, v button to select Photos and press the OK button. Touch the "Photos" selection on iPod panel, then select the photo you prefer.
- Touch the > to confirm the photo.



The Setup Menu

Test Tone

This function is used to test and adjust the volume level (gain) for each individual speaker channel. Use CH+/+/-, CH-/ button to select the speaker channel you wish to test and adjust. You'll hear a test tone coming from the speaker you select. Use the VOL+/ buttons to adjust the level to your desired setting. Press OK button to exit this function.

Video Setup

- Select the Video icon in the main menu using the left/right buttons.
- Select a menu option using the up/down buttons and press OK.

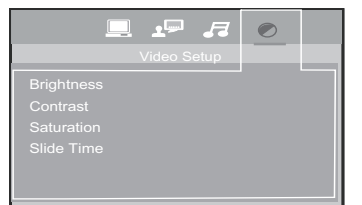

Slide Time

The Slide Time option lets you select the amount of time a picture is displayed in a slide show. The choices are 5 seconds, 10 seconds or 15 seconds.

Troubleshooting

The unit does not switch on.

- Make sure it is plugged in.
- Press the ON-OFF button on the remote control or the ON/STANDBY button on the front of the unit.

The device switches off spontaneously.

- The devices switches off automatically when it is in STOP mode for more than 30 minutes without any user intervention. Switch it on again.
- It might be impossible to read the disc.
- Insert the disc with the printed side facing up.
- Check that the disc can actually be played by this device.
- Check that the disc's regional code matches the unit's regional code. This unit's regional code is 1.
- Clean the disc.

There is no picture.

- Check you have switched on the TV set.
- Check the connections.
- Select the AV input assigned to the unit on the TV.
- Replace the HDMI cable with a better one. A bad HDMI cable can cause loss of video.
- Press HDMI key on remote handset several times to toggle among different HD OUTPUT.

The picture is of poor quality (with snow or lines).

- Check the connections.
- Make sure the speakers are connected.
- Make sure the MUTE function is not on.

No surround sound.

- Check the speaker configuration in the Setup menu (See Positioning speakers or Audio Setup).

Limited Warranty

Out of Warranty

In the event your product requires repair after the limited warranty period has expired, please contact our Customer Support Center at 1-800-506-5746, 1-877-252-6873 or

www.RCAav.com

Hours: Monday-Thursday: 9am-7pm, Friday: 9am-5pm, Saturday: 9am-NOON Eastern time.

Important: You are responsible for any transportation, shipping or insurance relative to the return of product to our Product Returns Center.

All warranties implied by state law, including the implied warranties of merchantability and fitness for a particular purpose, are expressly limited to the duration of the limited warranties set forth above. With the exception of any warranties implied by state law as hereby limited, the foregoing warranty is exclusive and in lieu of all other warranties, guarantees, agreements and similar obligations of manufacturer or seller with respect to the repair or replacement of any parts. In no event shall AVC be liable for consequential or incidental damages.

No person, agent, distributor, dealer or company is authorized to change, modify or extend the terms of these warranties in any manner whatsoever. The time within action must be commenced to enforce any obligation of AVC arising under the warranty or under any statute, or law of the United States or Canada or any state thereof, is hereby limited to one year from the date of purchase. This limitation does not apply to implied warranties arising under state law.

This warranty gives you specific legal rights and you may also have other rights, which may vary, from state to state. Some states do not allow limitation on how long an implied warranty lasts, when an action may be brought, or to the exclusion or limitation of incidental or consequential damages, so the above provisions may not apply to you.

For more information on other products and services, please visit our web site at

www.RCAav.com

Important: Also keep your "Bill of Sale" as proof of purchase.

Model no. _____ Product name _____
Type of set _____
Serial no. _____ Invoice no. _____
Date purchased _____ Dealer name _____

FOR SERVICE AND REPAIR, PLEASE VISIT **www.RCAav.com**
Specifications and external appearance are subject to change without notice.

Troubleshooting

Free Manuals Download Website

<http://myh66.com>

<http://usermanuals.us>

<http://www.somanuals.com>

<http://www.4manuals.cc>

<http://www.manual-lib.com>

<http://www.404manual.com>

<http://www.luxmanual.com>

<http://aubethermostatmanual.com>

Golf course search by state

<http://golfingnear.com>

Email search by domain

<http://emailbydomain.com>

Auto manuals search

<http://auto.somanuals.com>

TV manuals search

<http://tv.somanuals.com>