

RCA

DVD Recorder/VCR Combo User's Guide DRC8300N

Changing Entertainment. Again.



A  **THOMSON BRAND**

Important Information

CAUTION

RISK OF ELECTRIC SHOCK DO NOT OPEN



This symbol indicates that this product incorporates double insulation between hazardous mains voltage and user accessible parts.



This symbol indicates "dangerous voltage" inside the product that presents a risk of electric shock or personal injury.



This symbol indicates important instructions accompanying the product.

WARNING

To reduce the risk of fire or shock hazard, do not expose this DVD Recorder to rain or moisture.

CAUTION

THIS PRODUCT UTILIZES A LASER. USE OF CONTROLS OR ADJUSTMENTS OR PERFORMANCE OF PROCEDURES OTHER THAN THOSE SPECIFIED HEREIN MAY RESULT IN HAZARDOUS RADIATION EXPOSURE. DO NOT OPEN COVERS AND DO NOT REPAIR YOURSELF. REFER SERVICING TO QUALIFIED PERSONNEL.

CAUTION

FCC Regulations state that unauthorized changes or modifications to this equipment may void the user's authority to operate it.

Note:

This DVD Recorder is designed and manufactured to respond to the Region Management Information. If the Region number of a DVD disc does not correspond to the Region number of this DVD Recorder this DVD Recorder cannot play the disc. The Region number for this DVD Recorder is Region No 1.

Note:

This device is protected by U.S. patent numbers 4,631,603 and 4,577,216 and 4,819,098 and other intellectual property rights. The use of Macrovision's copy protection technology in the device must be authorized by Macrovision and is intended for home and other limited pay-per-view uses only, unless otherwise authorized in writing by Macrovision. Reverse engineering or disassembly is prohibited.

The apparatus shall not be exposed to dripping or splashing and that no objects filled with liquids, such as vases, shall be placed on the apparatus.

FCC INFORMATION

This equipment has been tested and found to comply with the limits for a Class B digital device, pursuant to Part 15 of the FCC rules. These limits are designed to provide reasonable protection against harmful interference in a residential installation. This equipment generates, uses and can radiate radio frequency energy and, if not installed and used in accordance with the instructions, may cause harmful interference to radio communications. However, there is no guarantee that interference will not occur in a particular installation. If this equipment does cause harmful interference to radio or television reception, which can be determined by turning the equipment off and on, the user is encouraged to try to correct the interference by one or more of the following measures.

- Reorient or relocate the receiving antenna.
- Increase the separation between the equipment and receiver.
- Connect this equipment into an outlet on a circuit different from that to which the receiver is connected.
- Consult the dealer or an experienced radio/TV technician for help.

This class B digital apparatus meets all requirements of the Canadian Interference – Causing Equipment Regulations. This class B digital apparatus complies with Canadian CES-003.

Cet appareil numérique de la class B est conforme à la norme du NMB-003 du Canada.

Refer to the identification/rating label located on the back panel of your product for its proper operating voltage.

Product Registration

Please fill out the product registration card and return it immediately. Returning the product registration card allows us to contact you if needed.

Keep your sales receipt to obtain warranty parts and service and for proof of purchase. Attach it here and record the serial and model numbers in case you need them. The numbers are located on the back of the DVD Recorder.

Model No. **DRC8300N** Serial No. _____
Purchase Date: _____
Dealer/Address/Phone: _____

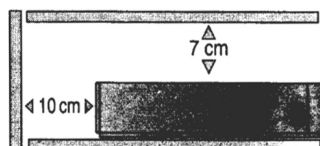
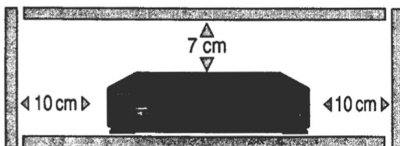

Ventilation:

You must adequately ventilate the product. Make sure there is adequate space around the DVD Recorder/VCR to provide proper air flow for ventilation. See diagram.

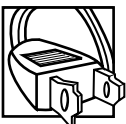

The AC power cord is polarized (one blade is wider than the other) and only fits into AC outlets one way. If the plug won't go into the outlet completely, turn the plug over and try to insert it the other way. If it still won't fit, contact a qualified electrician to change the outlet or use a different one. Do not attempt to bypass this safety feature.

CLASS 1
LASER
PRODUCT

Table of Contents

Chapter 1: Connections and Setup

Types of Discs	2
Things to consider before you connect	2
Unpack the Box	2
Choose your connection	3
Explanation of Jacks and Cables	4
Back of the DVD/VCR	5
Front of the DVD/VCR	7
Connection: DVD/VCR + TV	8
Connection: DVD/VCR + TV + Cable Box	10
Connection: DVD/VCR + TV + Satellite Receiver	12
Advanced Audio Connection Information	14
Install batteries in the remote control	15
Turn on the TV and the DVD/VCR	15
Complete Interactive Setup	15
What to Expect	17
How to find your TV's Video Input Channel	18
Next Steps	18

Chapter 2: The Remote Control

Explanation of buttons	20
Find out if the remote can be programmed to operate your TV	21
Programming the remote to operate your TV	21
Programming the remote to operate other components	22
Using the remote to operate other components	20
Code list for programming the remote control	23

Chapter 3: Using the Recorder's Features

Watching TV	28
The Channel Banner	28
DVD Recording	28
Express recording	28
Watching one channel while you record another channel	28
Watching a videocassette tape while you record to disc	29
Copying a DVD disc (DVD+R or DVD+RW) to tape	29
Timer Recordings	30
Disc Library	31
Editing the Genre of a Title	31
Finding a title (movie, program, etc.) by using the Sort Feature	31
DVD Playback	32
Editing DVD+R and DVD+RW discs	33
Editing titles using the Hide Chapter Feature	34
VCR Basics	34
Basic Playback	34
Basic Recording	34
Advanced VCR Features	35
Advanced Playback	35
VCR Info Display	35
VCR Recording	36
Express Recording	36
Watching one channel while you record another channel	36
Watching a DVD disc while you record to tape	36
Copying a videocassette tape to a DVD disc (DVD+R or DVD+RW)	36

Chapter 4: Playing Discs

Regional Coding	38
Types of discs you can play	38
How to Load and Play Discs	38
Using Different Menus	39
Search Options	39
Playback Options	39
Using the On-Screen Info Display	39
Time Display	41
Selecting a Title on DVDs or a Track on Audio CDs or VCDs	41
Chapter Icon	41
Subtitle Icon	41
Repeat Icon	42
Audio Icon	42
Camera Angle Icon	43

Play Mode Icon	44
IntroScan (Audio CD only)	44
PlayBack Control (PBC), Video CD only	44
Playing mp3 and/or JPEG files	44
Viewing JPEG files	45

Chapter 5: The Menu System

Overview of the Menu System	47
The Main Menu	47
Watch TV	48
Disc	48
Play Disc	48
Disc Title Menu	48
Player Menu	48
Playlist	48
Copy Disc	48
Disc Options	49
Autoplay	49
Screen Format	49
Angle Icon	49
Tape	49
Play Tape	49
Play from Start	49
Copy Tape	49
Review A-B Edits	49
Delete A-B Edits	49
Tape Options	49
Tape AutoPlay	49
Playback Mode (Digital or Analog)	49
AutoRewind	49
Disc Library	50
Timers	50
Setup	50
Parental Controls	50
Lock/Unlock	50
Rating Limits	50
Unrated Titles	51
System Options	51
Digital Output	51
SRS/TruSurround	51
Black Level	51
Display Dimmer	51
Audio Broadcast	51
Recording Options	52
Record Destination	52
Recording Quality	52
Tape Speed	52
Smart Record	52
Disc Options	note to see page 42
Tape Options	note to see page 42
Languages	52
Display	52
Audio	52
Subtitles	52
Disc	52
Installation Menu	53
Interactive Setup	53
Channel Search	53
Clock Setup	53
Channel List	53

Chapter 6: Additional Information

Troubleshooting	55
Handling Cautions	58
Maintenance of Cabinet	58
Limited Warranty	59
Accessories	60



Some discs may not be compatible due to laser pickup and disc design.

Types of Discs

RECORDING: TYPES OF DISCS YOU CAN USE FOR RECORDING

DVD+R 2.4x, 4x, or 8x ONLY; DVD+RW 2.4x and 4x ONLY.

NOTES:

It is NOT possible to record on CD-R or CD-RW discs.

IMPORTANT: It is NOT possible to record content that is copy-protected. This is usually true for most pre-recorded DVD discs and most pre-recorded VHS tapes.

PLAYBACK: TYPES OF DISCS YOU CAN PLAY

- **DVD discs** – DVD movie discs (DVD-ROM); DVD+R; DVD+RW; DVD-RW (must be recorded using video mode or VM); DVD-R (must be recorded using video mode or VM and must be finalized).
- **CDs (Audio CDs, CD-R, CD-RW)** – Audio CDs contain musical or sound content only. mp3 discs are CDs (CD-R or CD-RW) that contain mp3 files. This product also plays CDs that contain JPEG files and Multisession CDs.
- **Video CD (VCD) and Super Video CD (S-VCD) discs** – Like DVD video discs, VCDs contain picture and sound content. The difference is the amount of information that can be stored on the disc. VCDs typically have lower picture and sound quality than DVD discs. Super Video CDs (S-VCDs) can be used to record up to 70 minutes of digital sound and video, with MPEG-2 standard video and MPEG-1 standard audio—but you must use DVD+R or DVD+RW discs to record on your DVD/VCR not S-VCDs. Additionally, S-VCD disc compatibility is dependent on which MPEG coding software, disc design software, and disc writer software are used; and the discs themselves.

Things to consider before you connect

Protect components from overheating

- Don't block ventilation holes on any of the components. Arrange the components so that air can circulate freely.
- Don't stack components.
- When you place components in a stand, make sure you allow adequate ventilation.
- If you connect an audio receiver or amplifier, place it on the top shelf.

Position cables properly to avoid audio interference

- Insert each cable firmly into the designated jack.
- If you place components above the TV, route all cables down the side of the back of the TV instead of straight down the middle of the back of the TV.
- If your TV has an antenna that uses 300-ohm twin lead cables, do not coil the cables. Also, keep the twin lead cables away from audio/video cables.

Connection Pictures

Audio/video cables are usually bundled together. For better visibility, the connection pictures in this book show each cable separately (audio left, audio right, and video). Graphics contained within this publication are for representation only.

Unpack the Box

Your DVD/VCR came with the following items:

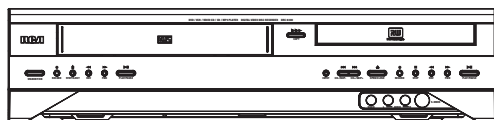

DVD/VCR

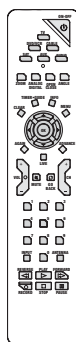

Remote control and batteries (part number 261387)

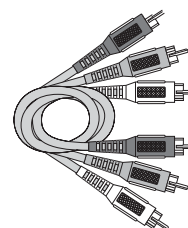

1 set of audio video cables (part number 233086)

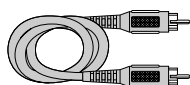

S-Video cable (part number 257982)







RF Coaxial cable (part number 221396)

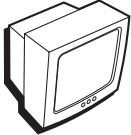
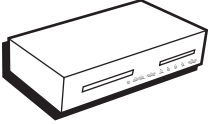
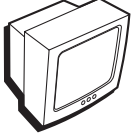

Power cord (part number 218104)

Choose Your Connection

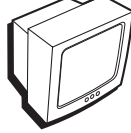
There are several ways to connect your DVD/VCR. Please use the following chart to determine which connection is best for you. Turn to the appropriate page for specific instructions.

Components			Cables Needed	Connection	Go to
 DVD/VCR	 TV		<ul style="list-style-type: none"> • Coaxial • Audio/video • S-Video 	TV	p. 8
 DVD/VCR	 TV	 Cable Box	<ul style="list-style-type: none"> • Coaxial • Audio/video • S-Video 	TV + cable box	p. 10
 DVD/VCR	 TV	 Satellite Receiver	<ul style="list-style-type: none"> • Coaxial • Audio/video • S-Video 	TV + satellite receiver	p. 12

To achieve enhanced picture quality, use the S-Video Cable (supplied) to connect your DVD/VCR to your TV if your TV has an S-Video jack available.

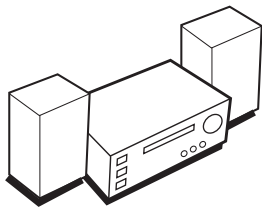

Connecting an optional audio receiver:

After you connect the DVD/VCR to your TV (choose an option above), go to page 14 for general information about connecting an audio/video receiver.

Explanation of Input Jacks and Cables

This section describes the jacks and cables you can use to make connections (only an S-Video and a set of audio/video cables are packed with your DVD/VCR—you can purchase other cables by calling 1-800-338-0376, order online at www.rca.com, or go to your local electronics store). There are several ways to connect your DVD/VCR to your TV depending upon the cables you have and the jacks that are on the back of your TV.

Different jacks and cables provide a different level of performance. It's important to remember, we're talking about degrees of picture improvement for comparison. If your TV has Component jacks (Y, Pb, Pr), S-VIDEO, and composite video (often color-coded yellow and grouped with Audio Left and Right jacks that are white and red); Component (Y, Pb, Pr), would be considered excellent, S-Video would be very good, and the composite video jack (yellow) would be considered good.

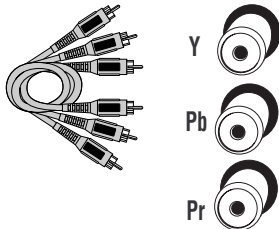

Component Video (Y, Pb, Pr) Jacks and Cables

The Y, Pb, Pr jacks provide optimum picture quality because the video is separated into three signals (two signals are dedicated to the color portion of the image, and the other signal is dedicated to the black and white part of the image).

To ensure maximum picture quality, use three video-grade cables (not supplied) for the connection. You can purchase bundled component video cables (not supplied) that are color-coded to match the Y, Pb, Pr jacks (red, green, and blue). Component Video Input jacks are usually found on high-end TVs, such as HDTVs; multimedia monitors; and some of the "flat" LCD and Plasma TVs or monitors.

Notes:

Also, remember to connect the left and right audio cables because the Y, Pb, Pr jacks and cables carry only the picture signal, not the sound.

Use the Component Video connection (Y, Pb, Pr) for DVD playback and watching TV. You must also connect yellow video cable or S-Video for VCR playback in analog mode.

S-Video Jacks and Cables

The S-Video (separate video) jack provides better picture quality than a composite video jack (sometimes labeled VIDEO and color-coded yellow on TVs) because S-Video keeps the color part of the picture separate from the black and white part of the picture. If your TV has an S-VIDEO jack, connect the DVD/VCR to the TV with an S-Video cable for a better quality picture. One S-Video cable is supplied with your DVD/VCR.

Note: Remember to connect the left and right audio cables because the S-Video cable carries only the picture signal, not the sound.

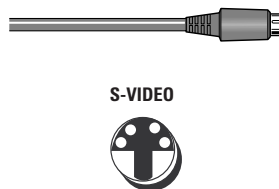

Audio/Video Jacks and Cables (RCA-type)

Video

The basic Video jack (usually color-coded yellow) is also referred to as composite video. Composite video doesn't keep color information separated (like S-Video), but it's better than the video quality you get from an RF coaxial cable (the type used to connect a cable signal or off-air antenna).

Audio

These jacks are used to send the audio from the disc or tape you're playing in the DVD/VCR to the TV. The audio jacks and cables (supplied) are often color-coded (red for right audio, and white for left audio). You must connect audio cables to the AUDIO L and R jacks on the DVD/VCR and the corresponding Audio Input Jacks on the TV no matter which Video jack you connect (VIDEO; S-VIDEO; Y, Pb, Pr).

Note: If your TV has only one input for audio (mono), connect it to the left (white L/Mono) audio jack on the DVD/VCR and don't connect the right audio part of the cable.

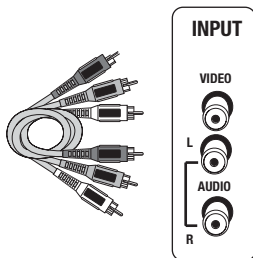

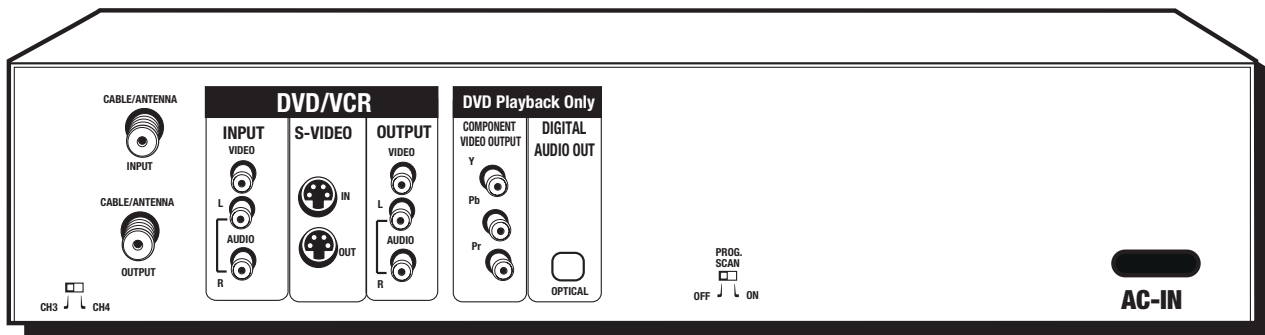

Back of the DVD/VCR

The back of your recorder might look a little overwhelming at first. This section explains what goes where and why. There are two sets of jacks on the back of your DVD/VCR—INPUT jacks and OUTPUT jacks.

Each jack is explained individually below, but the basic idea is about sending and receiving information to be played on or through your DVD/VCR and displaying that information on your TV screen.

INPUT The cables connected to INPUT jacks bring the signal that carries the content INTO the DVD/VCR, such as the cable signal (programming) from the cable company or satellite programming from a satellite receiver.

OUTPUT The cables connected to the OUTPUT jacks are sending the signal from the DVD/VCR OUT TO your TV so you can see it on the screen. The correct cables must be connected to the DVD/VCR's Output jacks and the corresponding Input Jacks on the TV so you can see the program on the TV. You must also tune the TV to the correct channel, called a Video Input Channel (for details, go to page 18).

Explanation of Jacks (from left to right)

CH3/Ch4 Switch This switch is also found on VCRs—it corresponds to the TV channel you would use to watch a tape if you only have your TV connected to the DVD/VCR with an RF Coaxial Cable via the CABLE/ANTENNA OUTPUT jack (if the switch is set to CH3, you would tune the TV to channel 3). However, the connections illustrated in the User's Guide show a preferred connection using audio/video cables or an S-Video cable.

CABLE/ANTENNA INPUT: Connect an RF Coaxial cable from an off-air antenna, cable box, or cable outlet to this jack. The cable is sending the programming from the source to the DVD/VCR.

CABLE/ANTENNA OUTPUT: Connect an RF Coaxial cable (provided) to this jack and to the Cable/Antenna Input jack on your TV.

INPUT: These jacks receive audio and video from a compatible component, such as a satellite receiver. Another set of Input Jacks (INPUT 2) are on the front of the DVD/VCR for temporarily connecting components such as a camcorder or a video game unit.

VIDEO: Color coded yellow, the video cable you use with this jack provides better quality than an RF Coaxial cable but isn't as good as S-Video. Connect corresponding video cable to a compatible component such as a satellite receiver or cable box.

AUDIO L (left): Color coded white, connect corresponding audio cable to a compatible component such as a satellite receiver or cable box.

AUDIO R (right): Color coded red, connect corresponding audio cable to a compatible component such as a satellite receiver or cable box.

S-VIDEO

IN: If your satellite receiver or cable box has an S-VIDEO output jack, connect the S-Video cable to this jack because it provides better picture quality than standard video (the yellow jack).

OUT: If your TV has an S-Video jack, connect an S-Video cable to the TV's S-VIDEO jack and to this S-VIDEO OUT jack on the DVD/VCR to achieve better picture quality than standard video (the yellow jack).

continues on next page...

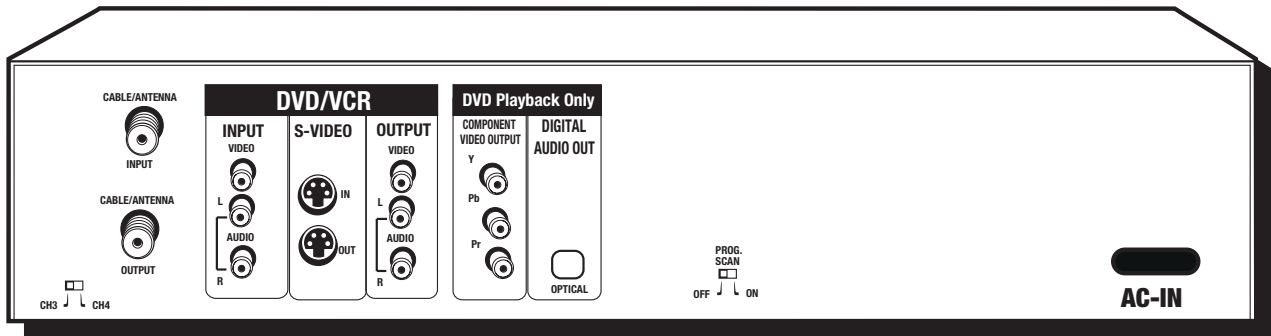

OUTPUT: These jacks send the content (audio and video) from your DVD/VCR OUT to the TV so you can see it on the TV screen and hear it through the TV's speakers.

VIDEO: Color coded yellow, the video cable you use with this jack provides better quality than an RF Coaxial cable but isn't as good as S-Video.

AUDIO L (left): Color coded white, connect corresponding audio cable to TV's Audio Left Input Jack.

AUDIO R (right): Color coded red, connect corresponding audio cable to TV's Audio Right Input Jack.

COMPONENT VIDEO OUTPUT (Y, Pb, Pr) - DVD PLAYBACK ONLY: Some high-end TVs and monitors have Component Video Input jacks. The cables that send the video signal through these Output Jacks provide the highest resolution because the video signal is divided into 3 separate parts (cables not supplied with DVD/VCR). As with VIDEO and S-VIDEO, COMPONENT VIDEO (Y, Pb, Pr) only carries the picture signal so you need to connect the audio cables so you'll hear the sound. If your TV has COMPONENT INPUT jacks, use three video grade cables to connect the DVD/VCR to these jacks on the TV to get the best picture quality. However, make sure you also connect another video cable (either a RF coaxial cable to the CABLE/ANTENNA OUTPUT jack; the yellow cable to the VIDEO Output jack; or an S-Video cable to the S-VIDEO OUT jack) because you can only use Component Video for DVD Playback. You'll need to have another Video Output connected for playback of VCR tapes.



DIGITAL AUDIO OPTICAL OUT - DVD PLAYBACK ONLY: If you have a Dolby Digital or DTS receiver or decoder with a Digital Audio Optical Input jack, you can achieve enhanced sound quality during DVD PLAYBACK by connecting a digital optical cable (not supplied).

Note: Make sure you connect regular audio cables in addition to connecting a Digital Audio cable because you can only use the DIGITAL AUDIO connection for DVD Playback. If you're playing a VCR tape in analog mode (necessary for recording to DVD disc and playing a tape at the same time) you'll need the other audio cables connected because the sound from the DIGITAL AUDIO won't match up with the video in analog mode causing a "a lip sync" problem.

PROG. SCAN switch – If you've connected your DVD/VCR to a TV that uses progressive scanning to display the image via the Y, Pb, Pr jacks, turn the switch to the "on" position for progressive scan playback of DVD discs. Typically, only some High Definition Televisions and high-end multimedia monitors use progressive scanning. Leave the switch in the OFF position for S-VIDEO or regular VIDEO (yellow) connections.

Note: If you turn the PROG SCAN switch on, and your TV isn't capable of progressive scanning you won't see a clear picture on the TV screen. Additionally, when playing DVDs you won't see any picture—press STOP (the main menu appears) and turn the PROG SCAN switch to the OFF position. Try playing the disc again.

AC-IN – This is where you attach the power cord.

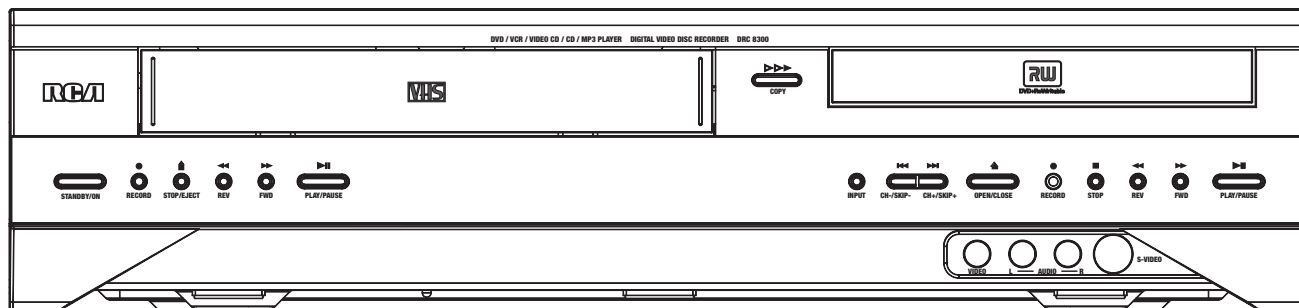

Front of the DVD/VCR

COPY – Shortcut to transfer tapes (VCR) to disc (DVD), which is great for converting your camcorder recordings that are on videocassette tape to a DVD disc. When you have a recordable DVD+R or DVD+RW disc in the DVD disc tray and a videocassette tape in the VCR, press COPY (the VCR starts playing and the DVD/VCR starts recording automatically).

STANDBY/ON – Turns the DVD/VCR on and off.

VCR Buttons

RECORD – Records to a videocassette tape.

STOP/EJECT – When playing a tape, stops playback. When tape isn't playing, ejects the tape.

REV – Rewinds the tape

FWD – Fast forwards the tape

PLAY/PAUSE – Starts playback. During playback, pauses playback.

INPUT – Just like a TV has Video Input Channels (page 16), the DVD/VCR has one Video Input Channel for each set of INPUT jacks. The Video Input Channel is the "channel" to which you tune the DVD/VCR so you can see the picture and hear the sound that's coming from the component that is connected to the DVD/VCR's INPUT jacks. For example, if you connected your camcorder to the Audio and Video Input jacks on the front of the DVD/VCR, you would press the INPUT button until *INPUT 2-Front* appears.

DVD Buttons

CH-/SKIP- (channel down/skip reverse) – Goes to the previous channel in the channel list when you're watching TV. When playing a disc, goes to the beginning of the current chapter or track unless you're within the first minute of a chapter or the first 15 seconds of a track—then, you'll skip to the beginning of the preceding chapter or track.

CH+/SKIP+ (channel up/skip forward) – Goes to the next channel in the channel list when you're watching TV. When playing a disc, goes to the beginning of the next title, chapter, or track on a disc (in effect, "skipping" the title, chapter, or track).

OPEN/CLOSE – Opens and closes the disc tray.

RECORD – Records content to a DVD disc (DVD+R or DVD+RW discs only).

STOP – Stops playback and/or recording.

REV (reverse) – Searches backwards through the disc.

FWD (forward) – Searches forwards through a disc.

PLAY/PAUSE – Starts playback of a disc. Pauses recording or playback.

Front Input Jacks:

INPUT 2: Audio/Video jacks – These Input Jacks are provided for convenience when you are connecting a temporary component, such as a camcorder.

S-VIDEO – If a component you're connecting, such as a camcorder, has an S-Video Output jack connect it to this jack for picture quality that is better than regular video (yellow). Remember, you still have to connect audio cables to hear sound.

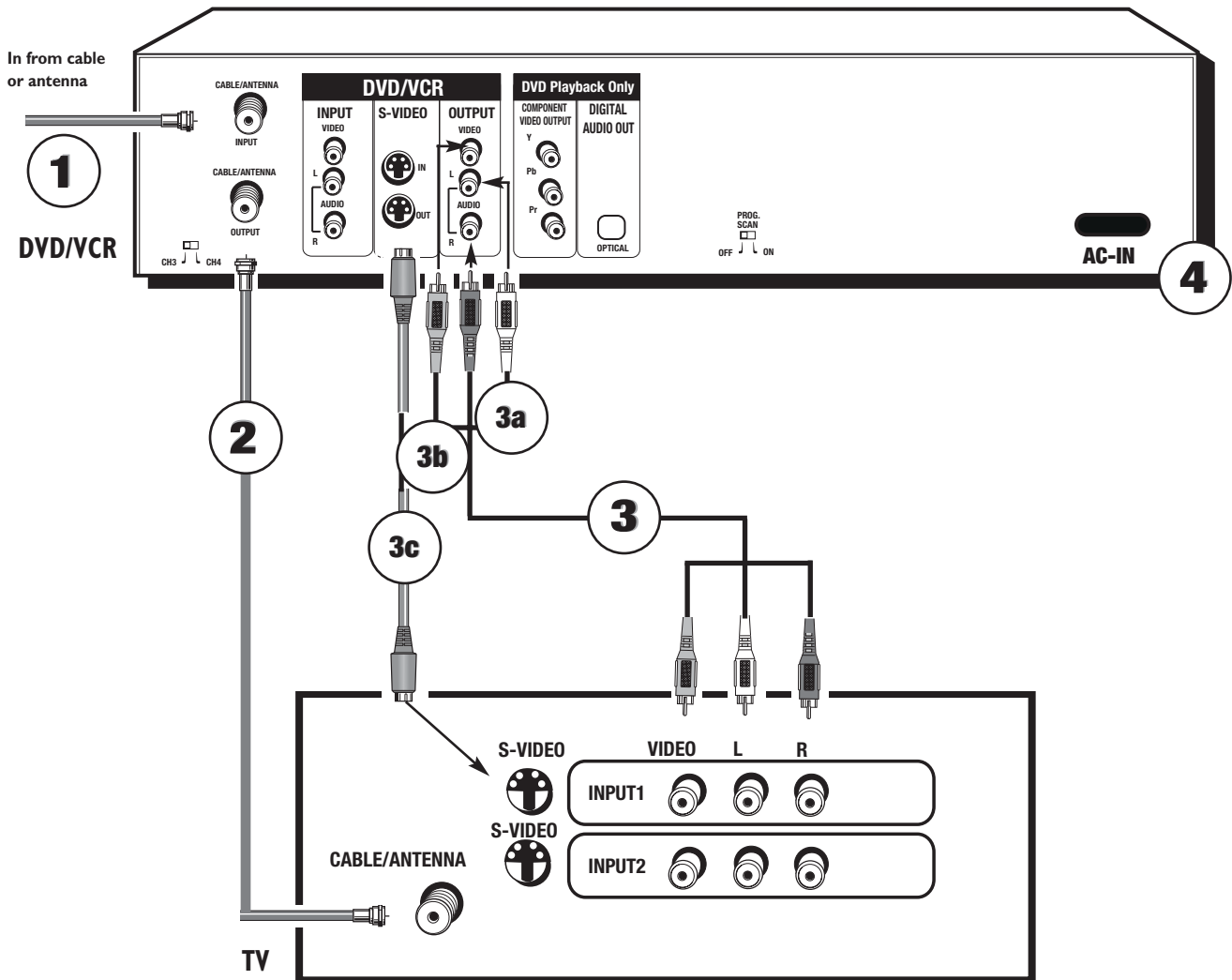

The back of your TV might look different than the one pictured here.

Details about the different kinds of cables used to connect your DVD/VCR are on page 4.

To watch one program while you record another:

Tune the TV to its Input 1 channel or Vid 1 channel
 Tune the DVD/VCR to the channel you want to record, and press RECORD.
 Use the buttons on the TV (or the TV's remote control*) to tune the TV to the channel you want to watch.

To play a disc or tape:

Tune the TV to its Input 1 channel or Vid 1 channel.

If you need help finding your TV's various Video Input Channels, go to page 18.

* The remote control packed with your DVD/VCR is capable of being programmed to operate many brands and models of TVs and VCRs. For instructions, go to page 21. If the remote operates your TV, press TV and INPUT to access the Video Input Channel.



RF Coaxial cable

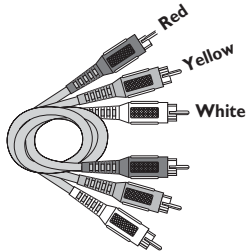

Audio video cables are usually color-coded red, white, and yellow.



If your TV has an S-Video jack, connect the S-Video cable (supplied). S-Video provides better video quality than composite video (the yellow jack).

Connection: DVD/VCR + TV

1. Connect the signal (cable or antenna):

Note: Depending upon how you currently have your TV connected, you'll have to disconnect the cable from your TV's Antenna Input jack (sometimes labeled CABLE/ANTENNA) or your VCR's Input jack before you connect the cable as explained below.

Cable service: If you have cable service via a cable that comes out of the wall, connect the end of that cable to the CABLE/ANTENNA INPUT jack on the DVD/VCR.

Note: If you have a cable box, go to page 10 for connection instructions.

Off-air antenna: If you use an off-air antenna to get TV programming, connect the antenna's RF coaxial cable to the CABLE/ANTENNA INPUT jack on the DVD/VCR.

2. Connect the DVD/VCR to the TV

You need to connect cables from the DVD/VCR's OUTPUT jacks to the TV's INPUT jacks in order to see the content from the DVD/VCR.

Use the RF Coaxial cable that was packed with your DVD/VCR, and connect one end to the CABLE/ANTENNA OUTPUT jack on the DVD/VCR. Connect the other end to the Cable/Antenna Input jack on the back of your TV (sometimes labeled CABLE/ANTENNA).

3. If you want to be able to record one TV program while you watch a different program, you need to connect the audio/video cables in addition to connecting the RF Coaxial cable described in Step 2.

- 3a. Connect the audio cables.

A set of audio/video cables was packed with your DVD/VCR. Connect the audio cables to the OUTPUT AUDIO L (left – white) and R (right – red) jacks on the back of your DVD/VCR, and to the corresponding Audio Input jacks on your TV (sometimes labeled AUDIO IN L and R).

- 3b. Connect the video cable. The cables you use for the video determine the quality of the picture you'll see on your TV when you're playing DVDs. For more information about cables and signal quality, go to page 4. Connect the video cable (yellow) to the OUTPUT VIDEO jack on the back of your DVD/VCR, and to the Video Input jack on your TV (sometimes labeled VIDEO IN).

- 3c. If your TV has an S-Video jack, use the S-Video cable (supplied). Connect one end of the S-Video cable (supplied) to the S-VIDEO IN jack on the back of the TV and the other end to the S-VIDEO OUT jack on the back of the DVD/VCR.

COMPONENT OUT Y, Pb, Pr (not shown) If your TV has Component Input Jacks (Y, Pb, Pr), you can achieve even greater picture quality (DVD playback only) by connecting the DVD/VCR to the TV using these jacks (COMPONENT VIDEO OUTPUT, Y, Pb, Pr on the DVD/VCR). For more explanation, go to page 4. Component Video cables not supplied with the DVD/VCR.

Notes:

If your TV is capable of progressive scan, connect the DVD/VCR to the TV using the COMPONENT VIDEO OUTPUT jacks, and slide the PROG SCAN switch to the ON position to see DVD titles (movies) in progressive scan format. If you need more explanation, go to page 6.

If you use the COMPONENT VIDEO connection (Y, Pb, Pr), you must connect another video cable (yellow or S-Video) for VCR playback. The Component Out jacks are only for DVD playback.

4. Attach the AC power cord to the unit.
5. Insert the other end of the AC power cord into an AC outlet (or power strip).

Go to page 15

The back of your TV and/or Cable Box might look different than the ones pictured here.

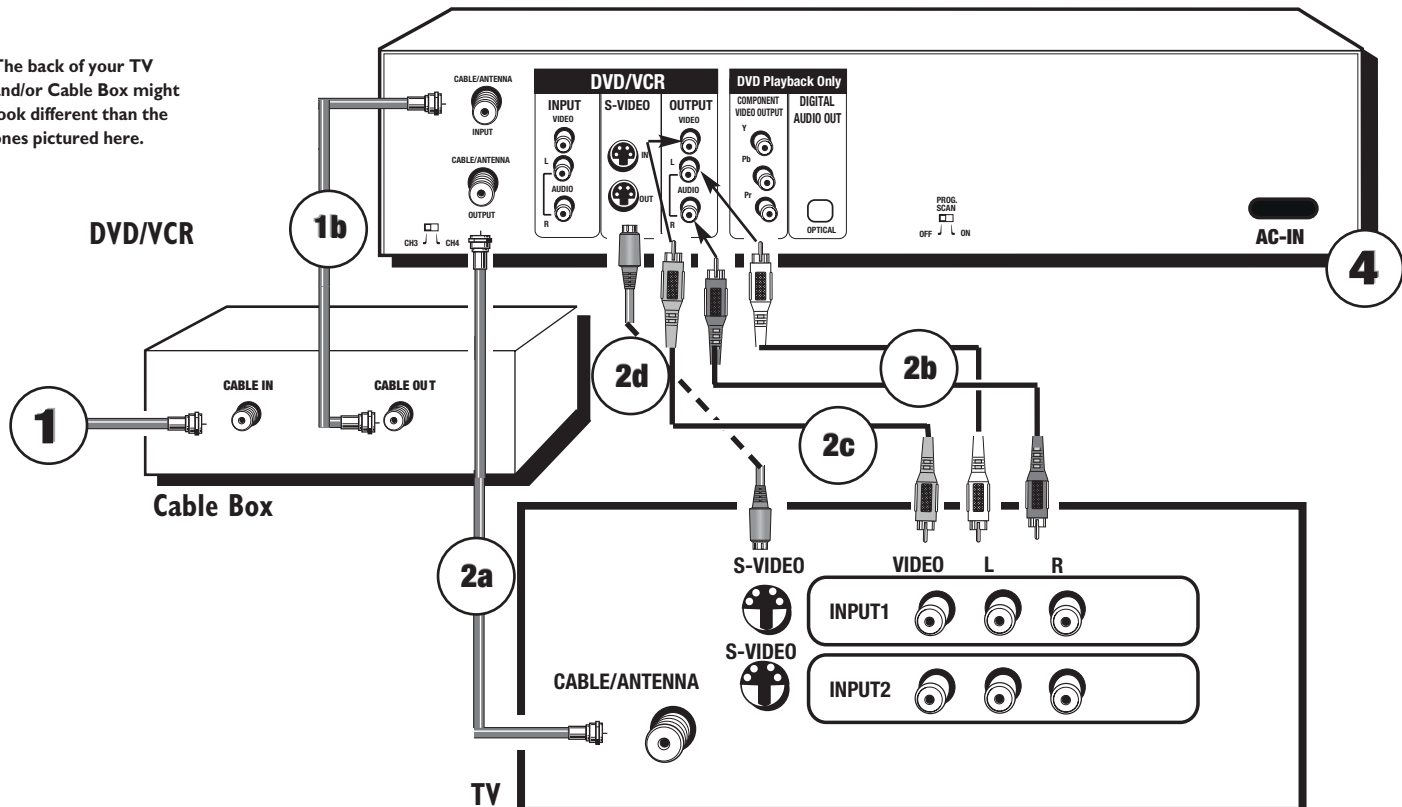

Notes about cable boxes:

If you have questions about using a cable box with the DVD/VCR, consult your cable company. RCA can only provide general instructions because cable services and cable boxes differ in various areas. This connection only shows a basic RF Coaxial Cable connection, your cable box may have Audio Video or S-Video jacks.

If you connect your components as described, you must access different Video Input Channels on your TV to see programming. If you don't know how to access Video Input Channels on your TV, go to page 18 for help. A general explanation, based on the connection shown above, follows:

To watch one program while you record another:

Tune the TV to its Input 1 channel or Vid 1 channel.

Tune the DVD/VCR to the cable box channel (usually channel 2, 3, or 4).

Use the channel buttons on the cable box to tune to the channel you want to record. Press the RECORD button on the DVD/VCR.

Use the buttons on the TV (or the TV's remote control*) to tune the TV to the channel you want to watch.

To play a disc or tape:

Tune the TV to its Input 1 channel or Vid 1 channel.

If you need help finding your TV's various Video Input Channels, go to page 18.

* The remote control packed with your DVD/VCR is capable of being programmed to operate many brands and models of TVs. For instructions, go to page 21. If the remote operates your TV, press TV and INPUT to access the Video Input Channel.

Connection: DVD/VCR + TV + Basic Cable Box



RF Coaxial cable

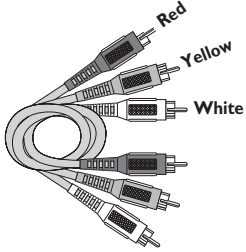

Audio video cables are usually color-coded red, white, and yellow. Red= right audio; White = left audio; Yellow = video.

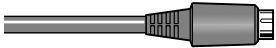

If your TV has an S-Video jack, connect the S-Video cable (supplied). S-Video provides better video quality than composite video (the yellow jack).

1. Connect the cable box signal.

Note: Before you connect the DVD/VCR, you'll need to disconnect some of the cables first in order to reconnect them.

- 1b. Connect the RF Coaxial cable that is connected to the cable box's Output jack (sometimes labeled CABLE OUT) to the CABLE/ANTENNA INPUT jack on the back of the DVD/VCR.

2. Connect the DVD/VCR to the TV

You need to connect cables from the DVD/VCR's OUTPUT jacks to the TV's INPUT jacks in order to see the content from the DVD/VCR (whether it's a TV program or a disc you're playing).

- 2a. Use the RF Coaxial cable that was packed with your DVD/VCR, and connect one end to the CABLE/ANTENNA OUTPUT jack on the DVD/VCR. Connect the other end to the Cable/Antenna Input jack on the back of your TV (sometimes labeled CABLE/ANTENNA).

If you want to be able to record one TV program while you watch a different program, you need to connect the audio/video cables (provided) in addition to connecting the RF Coaxial cable described in Step 2a.

- 2b. Connect the audio cables.

A set of audio/video cables was packed with your DVD/VCR. Connect the audio cables to the OUTPUT AUDIO L (left – white) and R (right – red) jacks on the back of your DVD/VCR, and to the corresponding Audio Input jacks on your TV (sometimes labeled AUDIO IN L and R).

- 2c. Connect the video cable. The cables you use for the video determine the quality of the picture you'll see on your TV when you're playing DVDs. For more information about cables and signal quality, go to page 4.

Connect the video cable (yellow) to the OUTPUT VIDEO jack on the back of your DVD/VCR, and to the Video Input jack on your TV (sometimes labeled VIDEO IN).

- 2d. **S-VIDEO** If your TV has an S-VIDEO jack, connect one end of the S-Video cable (supplied) to the S-VIDEO IN jack on the back of the TV and the other end to the S-VIDEO OUT jack on the back of the DVD/VCR.

COMPONENT OUT Y, Pb, Pr (not shown) If your TV has Component Input Jacks (Y, Pb, Pr), you can achieve even greater picture quality (DVD playback only) by connecting the DVD/VCR to the TV using these jacks (COMPONENT VIDEO OUTPUT, Y, Pb, Pr on the DVD/VCR). For more explanation, go to page 4. Component Video cables not supplied with the DVD/VCR.

Notes:

If your TV is capable of progressive scan, connect the DVD/VCR to the TV using the COMPONENT VIDEO OUTPUT jacks, and slide the PROG SCAN switch to the ON position to see DVD titles (movies) in progressive scan format. If you need more explanation, go to page 6.

If you use the COMPONENT VIDEO connection (Y, Pb, Pr), you must connect another video cable (yellow or S-Video) for VCR playback. The Component Out jacks are only for DVD playback.

3. Attach the AC power cord to the unit.
4. Insert the other end of the AC power cord into an AC outlet (or power strip).

Go to page 15

The back of your satellite receiver might look different than the one pictured here.

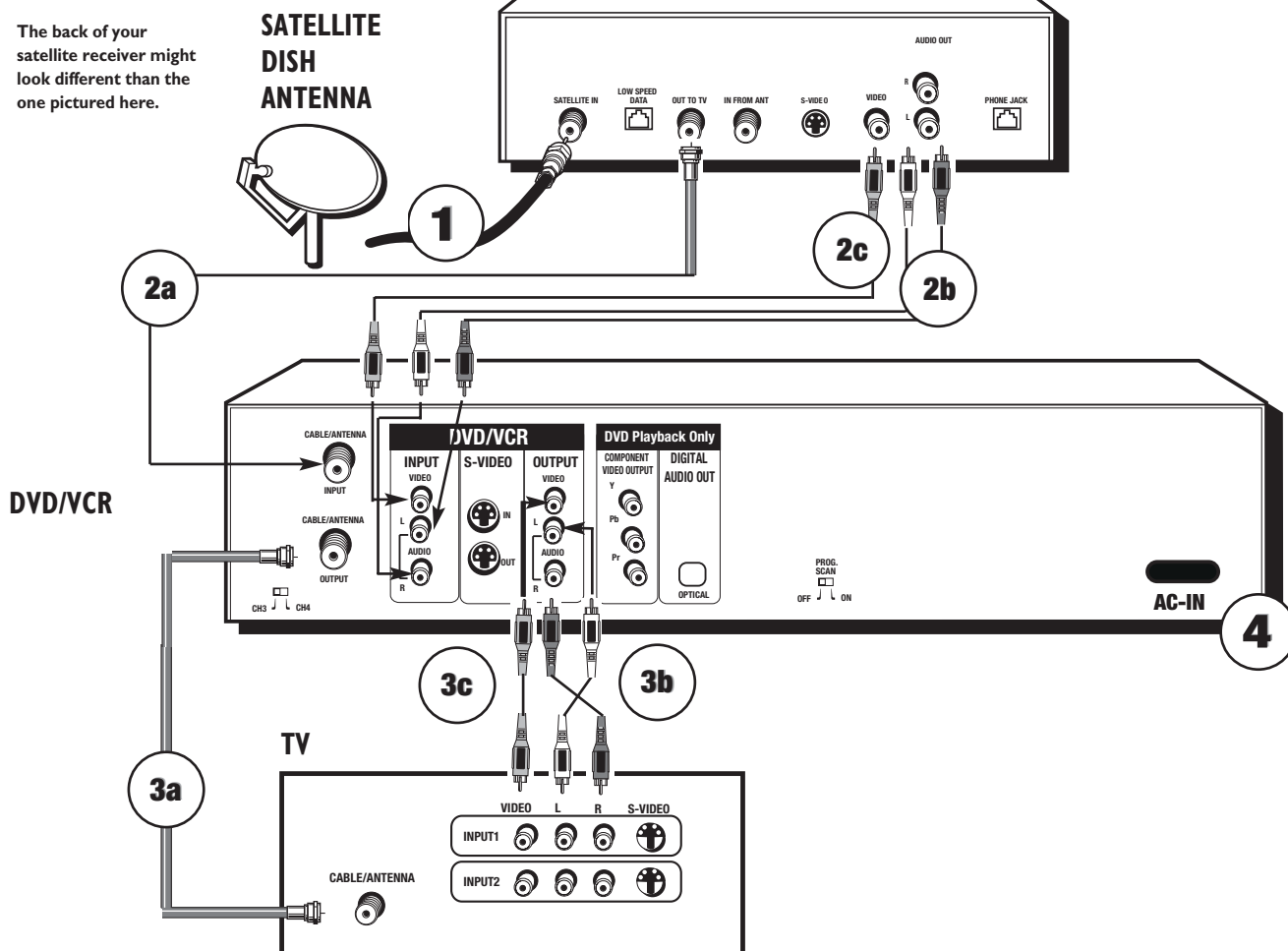

The back of your TV might look different than the one pictured here.

Details about the different kinds of cables used to connect your DVD/VCR are on page 4.

To watch TV (satellite programming) with the DVD Recorder turned on:

Tune the TV to its Input 1 channel or Vid 1 channel
Tune the DVD/VCR to the INPUT 1 channel (press the INPUT button on the remote).
Tune the satellite receiver to the channel you want to watch.

To watch TV (satellite programming) with the DVD/VCR turned off:

Tune the TV to its CABLE/ANTENNA INPUT channel (usually channel 2, 3, or 4).
Tune the satellite receiver to the channel you want to watch.

To play a disc or tape:

Tune the TV to Input 1 channel or Vid 1 channel.

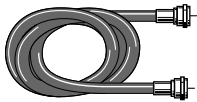

RF Coaxial cable

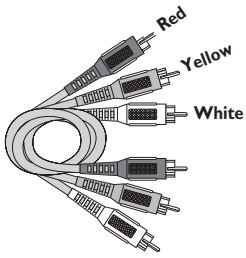

Audio video cables are usually color-coded red, white, and yellow. Red= right audio; White = left audio; Yellow = video.

Connection: DVD/VCR + TV + Satellite Receiver

The following instructions enable you to record the programs from your satellite receiver. Because the jack configuration and labels vary on different satellite receivers and televisions, the steps provided are general guidelines. Consult your Satellite Receiver and/or Television User's Guides for additional information. If you have cable TV service AND satellite TV, you can connect the cable signal to the DVD/VCR's CABLE/ANTENNA INPUT jack.

1. **Satellite signal:** Leave the cable in place that comes from the satellite dish and goes to the satellite receiver.
2. **Connect the satellite receiver to the DVD/VCR**
 - 2a. Connect a coaxial cable to the satellite receiver's OUT TO TV jack, and to the CABLE/ANTENNA INPUT jack on the DVD/VCR.
 - 2b. Connect audio cables (red and white) to the satellite receiver's output jacks [sometimes labeled Audio Left (white) and Audio Right (red)]. Connect the other ends of these cables to the corresponding INPUT AUDIO L and AUDIO R jacks on the back of the DVD/VCR.
 - 2c. Connect the video cable (yellow) to the Video Output jack on the satellite receiver (sometimes labeled VIDEO) to the INPUT VIDEO jack on the back of the DVD/VCR.
If your satellite receiver, has an S-VIDEO OUT jack, connect an S-Video cable to that jack and to the S-VIDEO IN jack on the DVD/VCR for increased picture quality (not shown in connection diagram).

3. Connect the DVD/VCR to the TV

You need to connect cables from the DVD/VCR's OUTPUT jacks to the TV's INPUT jacks in order to see the content from the DVD/VCR (whether it's a satellite program or a disc you're playing).

- 3a. Connect an RF coaxial cable to the DVD/VCR's CABLE/ANTENNA OUTPUT jack and to the TV's Antenna Input jack (sometimes labeled CABLE/ANTENNA).
- 3b. Connect the audio cables.
A set of audio/video cables was packed with your DVD/VCR. Connect the audio cables to the OUTPUT AUDIO L (left – white) and R (right – red) jacks on the back of your DVD/VCR, and to the corresponding Audio Input jacks on your TV (sometimes labeled AUDIO IN L and R).
- 3c. Connect the video cable. The cables you use for the video determine the quality of the picture you'll see on your TV when you're playing DVDs. For more information about cables and signal quality, go to page 4.

Connect the video cable (yellow) to the OUTPUT VIDEO jack on the back of your DVD/VCR, and to the Video Input jack on your TV (sometimes labeled VIDEO IN).

S-VIDEO (not shown) If your TV has an S-VIDEO input jack, connect one end of the S-Video cable (provided) to the S-VIDEO input jack on the back of the TV and the other end to the S-VIDEO OUT jack on the back of the DVD/VCR.

COMPONENT OUT Y, Pb, Pr (not shown) If your TV has Component Input Jacks (Y, Pb, Pr), you can achieve even greater picture quality (DVD playback only) by connecting the DVD/VCR to the TV using these jacks (COMPONENT VIDEO OUTPUT, Y, Pb, Pr on the DVD/VCR). For more explanation, go to page 4. Component Video cables not supplied with the DVD/VCR.

Notes:

If your TV is capable of progressive scan, connect the DVD/VCR to the TV using the COMPONENT VIDEO OUTPUT jacks, and slide the PROG SCAN switch to the ON position to see DVD titles (movies) in progressive scan format. If you need more explanation, go to page 6.

If you use the COMPONENT VIDEO connection (Y, Pb, Pr), you must connect another video cable (yellow or S-Video) for VCR playback. The Component Out jacks are only for DVD playback.

4. Attach the AC power cord to the unit. Insert the other end of the AC power cord into an AC outlet (or power strip).

Go to page 15

Important

You can't watch one satellite program and record another satellite program at the same time.

This connection scenario illustrates a basic connection—you can achieve better video quality by connecting the components with S-Video or Component Video options, depending upon the cables you have and the jacks available on your components. See page 4 for more information about jacks and cables.

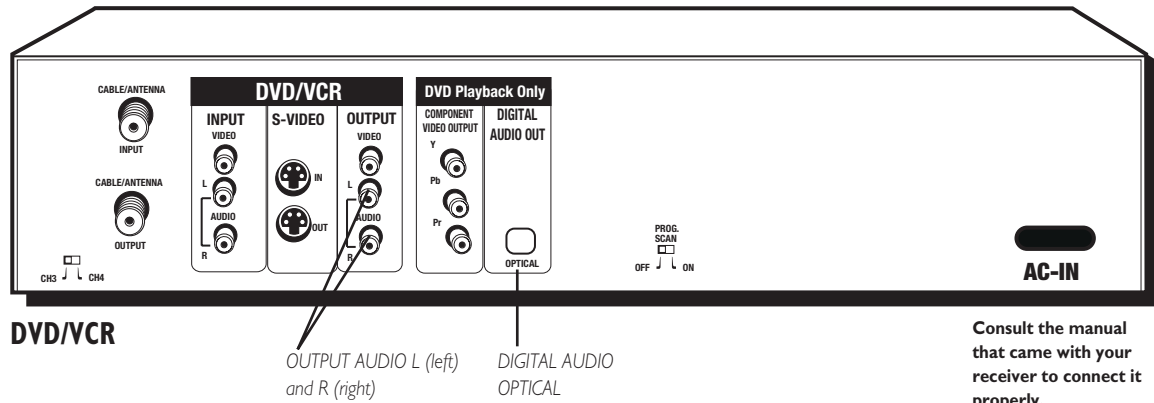

Advanced Audio Connection Information

Both Dolby Digital® and DTS® are audio formats used to record 5.1-channel audio signals onto the digital track of film (while the film is being made). Both of these formats provide up to six separate channels: left, right, center, left rear, right rear, and common subwoofer. The disc will play 5.1-channel sound only if you've connected a DTS or Dolby Digital receiver or decoder, and if the disc is encoded in the Dolby Digital or DTS format.

Please Read This Before Using the DIGITAL AUDIO Jack!

This unit's digital audio output jack is designed for a connection to a Dolby Digital or DTS receiver or decoder. Older digital equipment may not be compatible with the Dolby Digital bitstream. Such a connection can create a high level of noise that may be harmful to your ears, and could damage headphones or speakers. It is important to choose the correct Digital Output setting in the System Options menu. For more information, go to page 51.

Additionally, the DIGITAL AUDIO OUT connection is for DVD playback only. Make sure you connect audio cables (white and red) for VCR playback.

Connecting your DVD/VCR to an audio/video receiver

You'll need to consult instructions that came with your audio video receiver in order to connect it properly. The information below provides general guidelines for the DVD/VCR's Audio Output Jacks.

For a basic connection, connect the left and right audio cables to your audio/video receiver and to the OUTPUT AUDIO L (left – white) and R (right – red) jacks on the back of your DVD/VCR.

If you have a Dolby Digital or DTS receiver, connect an optical cable (SPDIF) to the DIGITAL AUDIO OUT jack on the DVD/VCR and the Digital Audio Input jack on the receiver (cables not supplied with DVD/VCR). You must also adjust the **Digital Output** setting (go to page 51 for information).

Note: Remove the protective cover that's in the DIGITAL AUDIO OUT OPTICAL jack before connecting the cable.

Install Batteries in the Remote

1. Remove the battery compartment cover on the back of the remote.
2. Insert new batteries. Match the polarities (+ and -) on the batteries with the diagram on the remote.
3. Put the battery compartment cover back on the remote.

Important Battery Information

- If you're not going to use the remote for a month or more, be sure to remove the batteries because they can leak and cause damage.
- Dispose of batteries in the proper manner, according to federal, state, and local regulations.
- Any battery may leak electrolyte if mixed with a different battery type, if inserted incorrectly, if all batteries are not replaced at the same time, if disposed of in fire, or if an attempt is made to charge a battery not intended to be recharged.
- Discard leaky batteries immediately. Leaking batteries can cause skin burns or other personal injury.

Point the Remote in the Right Direction and Put it in DVD/VCR Mode

When you want the remote to operate the DVD/VCR, point the remote at the DVD/VCR, not the TV. The remote has to be pointed in the correct direction and toward the correct component in order for the remote control's signal to communicate with the sensor on the component. Make sure there is a clear path between the remote control and the component you want to operate, so the signal isn't blocked.

Make sure the remote is in DVD/VCR mode—press the DVD/VCR button.

Turn on the TV and DVD/VCR

1. Turn on the DVD/VCR—press the DVD/VCR button on the remote.
2. Turn on the TV and tune it to the correct Video Input Channel—if you have an RCA, GE, or Proscan TV, press the TV button on the remote (if the TV doesn't turn on, press the ON•OFF button) and then press the INPUT button on the remote until you get to the Video Input Channel that matches how the DVD/VCR is connected to the TV.

If you have another brand of TV, turn on the TV and tune the TV to the correct Video Input Channel (if you don't know how to access the Video Input Channel on your TV, go to page 18 for help).

Note: You can program your remote to operate most brands of remote controllable TVs. Instructions are on page 21.

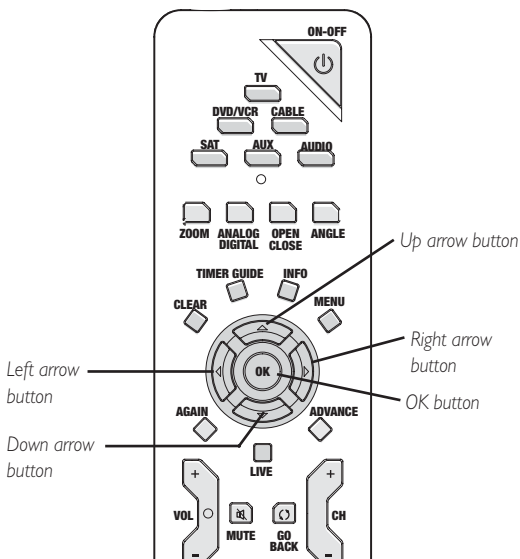

Use the arrow buttons on the remote to move through on-screen menus and highlight different options. Press the OK button to select a menu item that is highlighted.

Complete the Interactive Setup

The next few pages step you through the series of screens that will appear the first time you turn on your DVD/VCR.

Use the remote control to follow the on-screen instructions. The arrow buttons move the on-screen highlight in the corresponding directions on the screen (up, down, left, right).

Press the OK button to select a highlighted item.

Notes:

You can access the setup screens from the main menu. If you move, get a different program provider for TV shows, or change your connections, you'll need to complete the Interactive Setup again.

If you don't see the Language selection screen (below) the first time you turn on the DVD/VCR, make sure you've tuned your TV to the Video Input Channel that corresponds to the way you've connected the TV to the DVD/VCR. If you need help, go to page 18.

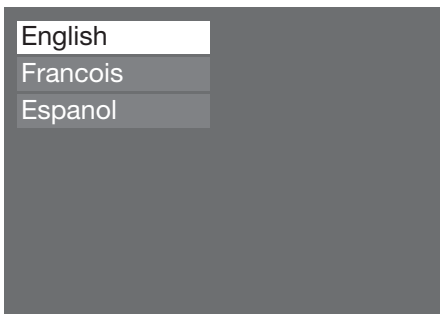

1) Select on-screen menu language

Make sure the remote is in DVD/VCR mode (press the DVD/VCR button). If you want the on-screen menus to appear in *English*, press the OK button on the remote control. If you prefer another language, press the arrow down button until that language is highlighted. Press OK to select the language. Next, the connection screen appears.

Note: If you don't see the Language selection screen the first time you turn on the DVD/VCR, make sure you've tuned your TV to the Video Input Channel that corresponds to the way you've connected the TV to the DVD/VCR. If you need help, go to page 18.

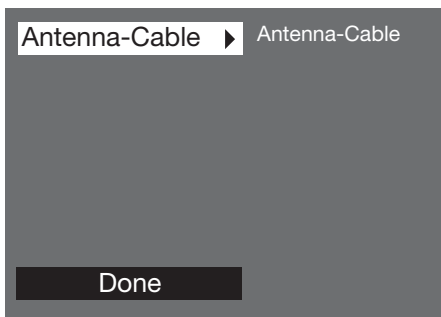

2) Select the Signal that's connected to the CABLE/ANTENNA INPUT jack

Completing this information lets the DVD/VCR know what program signals are being sent to it. Choose the type of signal that is connected to the CABLE/ANTENNA INPUT jack. Press the right arrow button to access the choices:

Note: If you've connected a cable box or satellite receiver to the CABLE/ANTENNA INPUT jack, turn on the cable box or satellite receiver before completing this step.

Cable-Antenna (cable service)

Antenna Only (no cable service, just off-air antenna)

Note: If the DVD/VCR doesn't start searching for channels after you've selected the type of signal connected to the CABLE/ANTENNA INPUT jack, press the down arrow button to highlight Done and press OK.

3) Channel Search

The DVD/VCR automatically scans the signal coming through the cable connected to the CABLE/ANTENNA INPUT jack and prepares the channel list. The channel list determines what channels appear when you press the CH+ and CH- buttons.

A progress indicator appears on the TV screen. When the Channel Search reaches 100%, press OK (the Channel List appears). If the Channel List doesn't appear, check the CABLE/ANTENNA INPUT jack to make sure the cable is connected properly.

Note: If you are using only a cable box or satellite receiver, there will be few, if any, channels in the channel list.

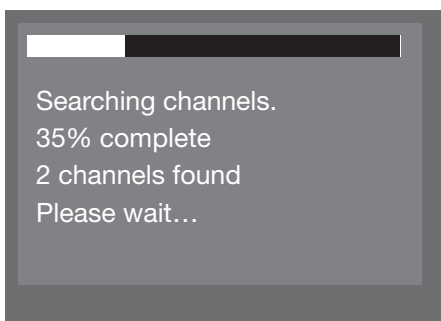

4) Channel List

The Channel List contains the channels you tune to when you press the CH+ and CH- (channel up and channel down) buttons on the remote control. From the Channel List screen, you can delete channels you rarely watch. You'll still be able to tune to the "deleted" channels directly by using the number buttons on the remote control, but the DVD/VCR won't tune to a channel you delete when you press the CH+/CH- buttons on the remote control.

Press the down arrow button to scroll through the channels. A checkmark in the box next to the channel means it has been stored in the channel list. Highlight the channel and press OK to check or uncheck the box. You can also label channels by pressing the INFO button.

To skip editing the channel list, press the right arrow button.

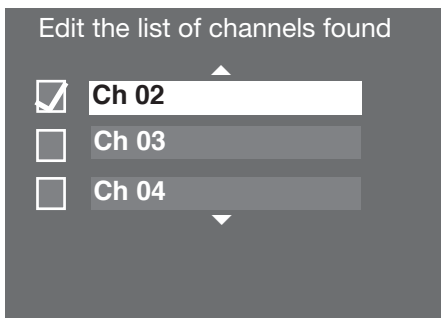

5) Time Zone

Use the down arrow button to highlight your time zone, and press OK (the Daylight Savings Time screen appears).

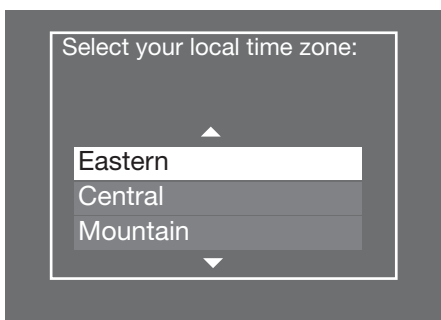

6) Daylight Savings Time

If you live in an area that recognizes Daylight Savings Time, press OK (the DVD/VCR's internal clock will automatically advance the time by 1 hour in the spring and set the clock back by 1 hour in the fall).

If you live in an area that doesn't use Daylight Savings Time, press the right arrow button to highlight No, and press OK.

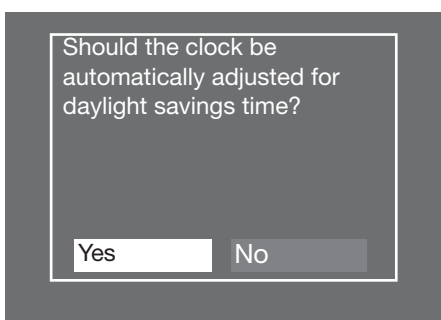

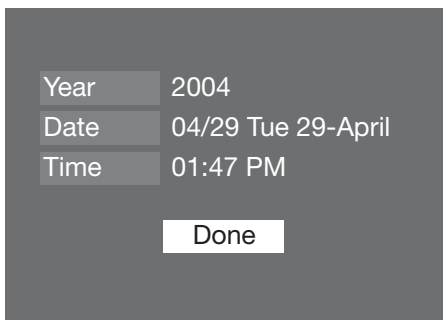

7) Time and Date

Your DVD/VCR has an automatic clock, but it may take awhile for the DVD/VCR to find the correct channel for the clock. Therefore, you might want to set up the clock manually here.

Use the number buttons on the remote to enter *Year*, *Date*, and *Time*. To change the AM/PM setting when you're entering the *Time*, press the right arrow button.

Notes:

If this screen doesn't appear, you can set the time later from the main menu—with the remote in DVD/VCR mode, press MENU, select Setup, select Installation, select Clock Setup and follow the on-screen instructions.

The DVD/VCR is equipped with a clock that automatically keeps the time accurate. If you have any problem with the time being accurate, simply turn off the AutoClock option (page 53). Access the main menu, choose System Options, and then AutoClock. Follow the instructions to disable it, and set the time manually using the Clock Setup menu option that you access via the Setup/Installation menu.

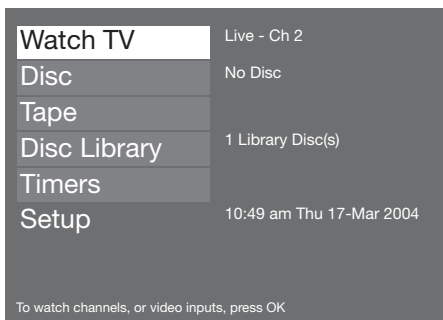

Watch TV

When the set-up procedure is complete, the main menu appears with the *Watch TV* menu highlighted. To watch TV, just press the OK button on the remote.

What to Expect

Turn on the DVD/VCR to Watch TV

In order to use the features of the DVD/VCR, you'll have to get used to turning on your DVD/VCR to watch TV.

You also need to tune the TV to the Video Input Channel—instead of changing channels with the TV's channel up and channel down buttons, you change channels via the DVD/VCR's channel up and down buttons (or number buttons). The TV stays on the Video Input Channel that corresponds to the Input Jacks on the TV you used to connect the TV to the DVD/VCR. If you need help finding the TV's Video Input Channel, go to page 18.

The Main Menu Appears

The main menu appears whenever you turn on the DVD/VCR. To watch TV, press the OK button when the *Watch TV* menu is highlighted. When you change channels, the channel banner appears to give you programming information that is available (for more information, go to page 28).

Changing Channels

You might notice a slight delay when you're changing channels because the signal goes to the DVD/VCR and is then sent out to the TV.

Discs for Recording

Recording to DVD discs is new to many people. There are several different formats of DVD discs. For your DVD/VCR, only DVD+R 2.4x, 4x, or 8x and DVD+RW 2.4x and 4x type discs can be used for recording. A DVD+RW disc is "rewritable" which means you can use the disc over and over again (similar to how you use VCR tapes to record). Additionally, DVD+RW discs have many "digital features" for editing the disc's content. DVD+R discs can only be used one time—you can't record over existing programs and you must get used to "finalizing the disc" in order for other DVD players to be able to play DVD+R discs. Throughout this User's Guide, you'll notice that some features and menu options are only available for a specific type of disc.

Make sure you use discs from a reputable manufacturer. Many problems encountered when recording (or playing) discs are related to the wide variation in disc quality due to the large number of brands and manufacturers. If you encounter problems with one brand of disc, please try another brand.

VCR (Digital vs. Analog)

Your VCR is equipped with two modes: digital and analog. The digital mode (or path) enables you to use an on-screen InfoDisplay during playback. This DVD/VCR is also designed with an analog mode (or path) so you are able to record to a DVD disc while watching a VCR tape; or record to a VCR tape while watching a DVD disc. The DVD functions always go through the digital path. There is only one digital path. Therefore, if you are using any VCR functions at the same time you're using DVD functions, the DVD/VCR switches to the analog path. If you are playing a VCR tape and the DVD functions aren't in use, you can switch the VCR playback between the analog path and the digital path by pressing the ANALOG•DIGITAL button on the remote.

Note: The DVD/VCR will change to the analog VCR path automatically when needed. When the VCR is in analog mode, the on-screen InfoDisplay isn't available and the VCR menu system will look different than the menus represented in this User's Guide.

Smart Play

Your DVD/VCR is an integrated product. The DVD/VCR intuitively knows whether a VCR tape or a DVD disc has been loaded, and acts accordingly when you press the PLAY button on the remote. If you have both a VCR tape and a DVD disc in the DVD/VCR, the main menu appears and you must select the appropriate media (tape or disc) by highlighting the appropriate menu (*Tape* or *Disc*) so the DVD/VCR knows what to do.

Chapter 1: Connections and Setup

How to find your TV's Video Input Channel

In order to see what's playing on your DVD/VCR, you need to tune the TV to the Video Input Channel that corresponds to the Input Jacks on your TV that you used to connect the DVD/VCR to the TV. The Video Input Channel(s) varies for different brands and different models of TVs.

RCA, GE, and Proscan TVs

If your brand of TV is RCA, GE, or Proscan, the remote control packed with your DVD/VCR will most likely access the TV's Video Input Channel—with the DVD/VCR turned on, press the TV button, and then press INPUT until you see the DVD/VCR's menu on your TV screen.

Other Brands of TVs

Since access to a TV's Video Input Channel varies from one manufacturer to the next, it's difficult to provide specific instructions for your particular brand. However, a list of suggestions is provided below.

- Consult the Instruction Manual that came with your TV.
- If you can't find the information in the manual, or can't find the manual, review the following list.
 - There might be a button on the TV's remote control that accesses the Video Input Channel (see table below for examples).
 - You might select the Video Input Channel from the TV's menu system.
 - You might tune to it by pressing a specific channel number (see table below).
 - Press the Channel up and/or down buttons on the TV's remote control (sometimes the Video Input Channel is stored in your TV's channel list).

Video Input Channel Variations

Button/Switch on the TV	Button on the TV remote	Channel Number
VIDEO	VID I S-VID	00 93
SIGNAL	LINE INPUT	90 VID 1
VID 1	VID SOURCE	91 VID 2
VID 2	VIDEO AUX	92 INPUT

Next Steps

This chapter is dedicated to connecting your DVD/VCR. Choose what you want to do next, and go to the appropriate chapter for instructions.

Chapter 2: The Remote Control (page 19)

A description of each button is in Chapter 2. Additionally, the universal remote control can be programmed to operate many brands and types of components. Go to page 19 for instructions.

Chapter 3: Recording, Playback & Features (page 27)

This chapter tells you how to record and playback programs, how to use the Disc Library and special editing features. Instructions for copying a VHS tape to a DVD disc are in this chapter.

Chapter 4: Playing Discs (page 37)

If you're ready to pop in a DVD (or a CD), this chapter explains how different discs function in the DVD/VCR and describes the features you can use with different types of discs.

Chapter 5: The DVD/VCR's Menu System (page 46)

Since this product is multi-functional, there are many on-screen menus to control settings and access features. Chapter 5 describes the menus and why you would want to use them.

Chapter 6: Additional Information (page 54)

If you're having trouble, go to Chapter 6. It includes troubleshooting information, the product's warranty, and accessories you might want to purchase.

Chapter 2

The Remote Control

- **Explanation of the buttons**
- **Find out if the remote can operate your TV**
- **Programming the remote to operate your TV**
- **Programming the remote to operate other components**

Graphics contained within this User's Guide are for representation only. Some of the menu screens, buttons, and display messages might be different in your product than they appear in this book. The on-screen help text provides the most current operational information.

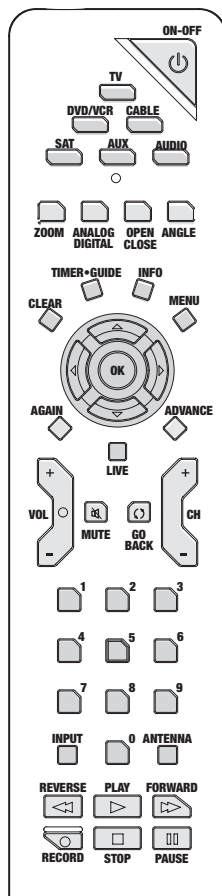

The Universal Remote Control that came with your DVD/VCR operates most RCA, GE, and Proscan branded components.

Additionally, the remote is capable of being programmed to operate many other brands and models of components.

Explanation of Buttons

You can use this remote to operate the DVD/VCR, and to access the features available. The remote is also designed to operate most RCA, GE, and Proscan components (TVs, VCRs, DVD players, audio components and satellite receivers). If you have another brand, you can program the remote control to operate those components (go to page 19 for instructions).

The descriptions that follow describe how each button works when operating the DVD/VCR. Many buttons will perform different functions depending upon the type of disc and menu functions of the disc.

0-9 (Number buttons) Use the number buttons to input information such as chapter numbers, track numbers, to make selections on some menu screens, and/or to change channels.

Arrow buttons (up, down, left, right) Use the arrow buttons to highlight options that appear on the screen (the arrow buttons move the highlight in the corresponding directions—up arrow moves the highlight up; left arrow moves the highlight left, etc.).

ADVANCE When playing a disc or tape, moves forward approximately 30 seconds. Not applicable for VCDs or mp3 files.

AGAIN Accesses the Scene Again™ feature—replays the last several seconds (approximately 10) of the DVD disc or tape you're playing. Not applicable for VCDs or mp3 files.

ANALOG•DIGITAL Switches the VCR from the digital path (InfoDisplay available) to the analog path (no InfoDisplay and different menu system).

ANGLE Accesses various camera angles that might have been added to a pre-recorded disc when it was created. Not available on all discs.

ANTENNA Acts like a TV/VCR button that is on most VCRs—on your DVD/VCR switches the RF Output between the TV/cable signal and the DVD/VCR output.

AUDIO Puts the remote in audio mode to operate a component, such as an audio receiver or amplifier, that you've programmed to work with this button.

AUX Puts the remote in auxiliary mode to operate a component (such as a cable box, VCR, DVD player, satellite receiver, or audio receiver) that you've programmed to work with this button.

CABLE Puts the remote in cable box mode so the remote operates a cable box that you've programmed to work with this button.

CH+ Advances to the next chapter or track when you're playing discs. Goes to the next channel in the channel list when watching TV.

CH- When playing a disc, goes to the beginning of the current chapter or track, unless you're within the first minute of a chapter or the first 15 seconds of a track—then you'll skip to the beginning of the preceding chapter or track. When watching TV, goes to the previous channel in the channels list.

CLEAR During playback, removes on-screen menus and displays.

DVD/VCR Turns on the DVD/VCR and puts the remote in DVD mode so it operates the DVD/VCR.

FORWARD Searches forward through the disc or tape.

GO BACK Returns you to the previous menu. When watching TV, goes back to the previous channel.

INFO Displays the on-screen Info Display (for details about the Info Display, go to page 32.)

INPUT Accesses the Input Jacks on the Recorder (CABLE/ANTENNA INPUT, INPUT 1, and INPUT 2 on the front of the DVD/VCR).

LIVE When the Main menu is on the screen, provides quick access to watch TV.

MENU When you're not playing a disc, accesses the DVD/VCR's menu. When you're playing a disc, accesses the disc's menu, if one is available.

MUTE Lowers the volume to its minimum level. Press again to restore volume.

OPEN•CLOSE Opens and closes the disc tray.

OK When a menu is on the screen, selects the highlighted item.

ON•OFF Turns the DVD/VCR on and off.

PAUSE Pauses disc or tape play or recording.

PLAY Begins disc or tape play.

RECORD Records programming.

REVERSE Searches backward through a disc or tape.

SAT Puts the remote in Satellite mode in order for the remote to operate a satellite receiver. This remote is capable of being programmed to operate most brands of satellite receivers. This remote is already programmed to operate most RCA, GE, and Proscan brand satellite receivers.

STOP Stops playback or recording.

TIMER•GUIDE Accesses the list of Timer Recordings (the Timer List screen).

TV Puts the remote in TV mode in order for it to operate your TV. This remote is already programmed to operate RCA, GE, and Proscan brand TVs. This remote is capable of being programmed to operate many brands of TVs.

VOL +/- Increases and decreases the volume level. Is capable of operating your TV or audio receiver.

ZOOM Enlarges the image on the screen so you can zoom in on details. To pan and scan after you've zoomed in on an image, use the arrow buttons. The Zoom feature isn't available on all discs. Typically, it works with DVD discs and CD-Rs with JPEG files.

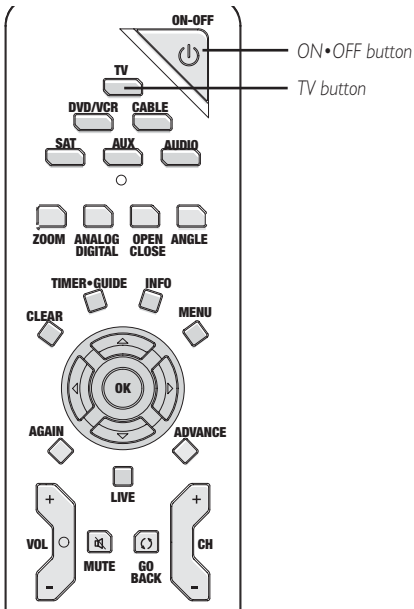

Find out if the remote can operate your TV

This remote control is designed to operate most RCA, GE, and Proscan TVs.

1. Press the TV button (if the TV turns on, this remote will operate your TV; if it doesn't turn on, go to step 2 below).
2. Press the ON•OFF button (if the TV turns on or off, this remote will operate the TV).
3. If that doesn't work, you can try programming the remote by following the instructions below.

Programming the remote to operate your TV

There are two ways to program this remote control to operate other brands of TVs: Direct Entry and Automatic Code Search (both methods are described below).

Direct Entry

1. Turn on the TV.
2. Look up the brand and code number(s) from the list that starts on page 23.
3. Press and hold the TV button on the remote.
4. Keep holding down the TV button, and enter the first code from the code list for your brand (p. 21).
5. Release the TV button.
6. Point the remote toward the TV and press the ON•OFF button to see if the TV turns off. If it doesn't, press the TV button and then press ON•OFF. If you get no response, follow steps 1-5 again, but enter the next code from the code list for your brand of television.
7. If you have tried all of the codes listed for your brand and this remote still doesn't operate the TV, try the Automatic Code Search method (next section). If Automatic Code Search method doesn't find the correct code, this remote won't work with your TV and you'll have to use the remote that came with your TV.

Note: This remote may not be compatible with all brands and models of televisions.

Automatic Code Search

The Automatic Code Search method for the TV button tests all of the TV codes. If you want to stop the automatic code search without programming the TV button to operate your TV, press CLEAR until the indicator on the remote turns off.

1. Turn on the TV.
2. Press and hold the TV button. While you continue pressing the TV button, press and hold the ON•OFF button until the indicator light on the remote turns on—then release both buttons.
3. Point the remote at the TV. Press and release PLAY, then wait 5 seconds or until the indicator on the remote stops flashing.

At this point the remote is searching for the correct code to program (you'll know it's found the correct code when the TV turns off, go to step 4). If, after 5 seconds, the TV doesn't turn off, press PLAY again to tell the remote to search the next set of codes.

Continue pressing and releasing the PLAY button (at 5 second intervals) or each time the indicator light stops blinking. When the indicator light turns off, and stays off, the remote has searched all of the codes—which means this remote can't be programmed to operate your TV. You'll have to use the remote that came with the TV.

4. When the TV turns off, the remote has found the proper code. Press and release REVERSE, then wait 2 seconds. Repeat this step until the TV turns back ON.
5. To finish, press and hold STOP until the indicator on the remote turns off.

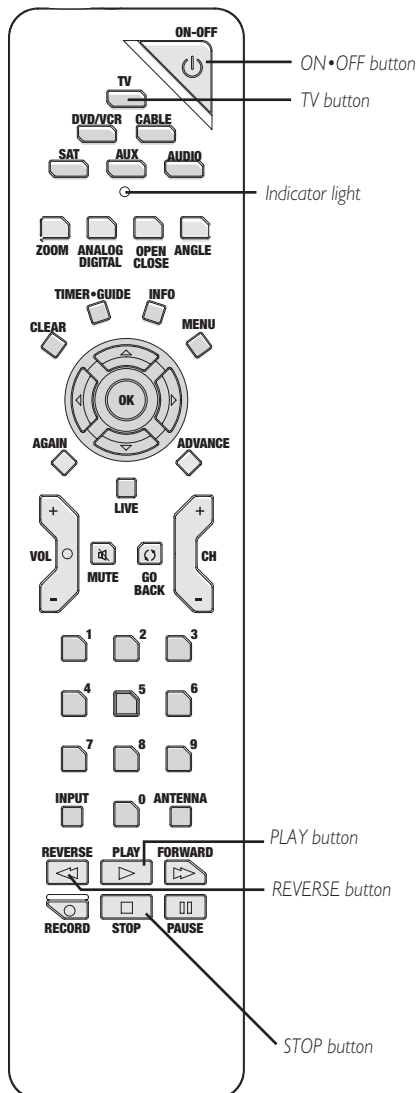

Chapter 2: The Remote Control

Programming the remote to operate other components

This remote is already programmed to operate most RCA, GE, and Proscan components—just press the applicable component button to operate the component (for a satellite receiver, press the SAT button; for an audio component, press AUDIO, etc.).

There are two ways to program this remote control to operate other brands of satellite receivers, cable boxes, and/or other compatible components: Direct Entry and Automatic Code Search (both methods are described below).

Direct Entry

1. Turn on the component you want to program the DVD/VCR remote to operate (satellite receiver, VCR, etc.).
2. Look up the component, brand, and code number(s) from the list (pages 23-26).
3. Press and hold the appropriate component button on the remote (i.e., SAT for satellite receiver; CABLE for cable box; or AUDIO for an audio component). The AUX button can control many different types of components including VCRs, TVs, audio components, satellite boxes, cable boxes, or DVD players. You must use the Direct Entry method to program the AUX button unless you want to program it to operate a VCR (Automatic Code Search for the AUX button only accesses the VCR codes).
4. Keep holding down the component button, and enter the first code from the code list for your brand. If the indicator light flashes, you've entered an invalid code or the button isn't programmable.
5. Release the component button.
6. Point the remote toward the component and press the ON•OFF button to see if it turns off. If it doesn't, press the component button and then press ON•OFF. If you get no response, follow steps 1-5 again, but enter the next code from the code list.

Note: This remote may not be compatible with all brands and models of components.

Automatic Code Search

The Automatic Code Search method searches all of the codes for the default component of a specific component button. If you want to stop the automatic code search without programming the remote, press CLEAR until the indicator on the remote turns off.

Note: You can only use Automatic Code Search to program the AUX button if you want the button to operate a VCR—you must use Direct Entry (above) if you want to program the AUX button to operate other components.

1. Turn on the component.
2. Press and hold the component button (TV, SAT, CABLE, or AUDIO). While you continue pressing the component button, press and hold the ON•OFF until the indicator light on the remote turns on—then release both buttons.
3. Point the remote at the specific component you're programming the remote to operate (TV, satellite receiver, cable box, audio component, etc.). Press and release PLAY, then wait 5 seconds or until the indicator on the remote stops flashing.

At this point the remote is searching for the correct code (you'll know it's found the correct code when the component turns off, go to step 4). If, after 5 seconds, the component doesn't turn off, press PLAY again to tell the remote to search the next set of codes.

Continue pressing and releasing the PLAY button (at 5 second intervals) or each time the indicator light stops blinking. When the indicator light turns off, and stays off, the remote has searched all of the codes—which means this remote can't be programmed to operate the particular brand/model of component. You'll have to use the remote that came with the component.

4. When the component turns off, the remote has found the proper code. Press and release REVERSE, then wait 2 seconds. Repeat this step until the component turns back ON.
5. To finish, press and hold STOP until the indicator on the remote turns off.

Using the remote's features

Know the mode

Once you've programmed the remote to operate other components, you need a basic understanding of how the remote control works. The codes in the remote control that make a component act a specific way are mode dependent—if you want to change settings in your TV's menu, you must press the TV button before you press the MENU button so the remote control knows that you want to access the TV's menu system.

To summarize, to operate the DVD/VCR you must press the DVD/VCR button; to operate the TV, you must press the TV button; to operate a satellite receiver, you must press the SAT button; to operate the cable box, you must press the CABLE button; etc.

To let you know which mode you're in, the component button that is active lights when you press a button.

Understanding the INPUT button

Another important button is the INPUT button. The INPUT button accesses the programming from a specific component. We call these channels, Video Input Channels, because you are telling the component to send the video (and audio) that corresponds to the Video Input jack you used to connect the component to the DVD/VCR. For example, if you connected a satellite receiver to your DVD/VCR by using the S-VIDEO IN jack, you would need to press DVD/VCR (to tell the remote you want to operate the DVD/VCR) and then press INPUT until the S-Video Input Channel appears (if the satellite receiver is on, you'll see the program it is tuned to, and S-VID appears in the DVD/VCR's channel banner to let you know which "channel" the DVD/VCR has accessed.

Low Battery Indicator

When the batteries are low, the indicator light and the component button light flickers.

Code List for TV button

Admiral	Crown	1131	Infinity	LG	1050	Philco	1060	Sansui
1002	1026	1138	1038	1006	1051	1004	1121	1109
1097	1038	Envision	Janeil	Loewe	Mitsubishi	1005	Radio Shack	1149
1118	Curtis Mathes	1005	1098	1038	1005	1006	1029	Sanyo
Aiko	1001	1007	JBL	Logik	1006	1007	1045	1005
1015	1005	Fisher	1038	1002	1007	1008	1130	1028
Akai	1007	1028	JC Penney	Luxman	1018	1011	1157	1029
1003	1014	1029	1001	1005	1020	1018	Radio	1045
Amtron	1029	1030	1005	1007	1030	1038	Shack/Realistic	1051
1026	1045	1045	1006	LXI	1050	1040	1001	1065
Anam	1063	1103	1007	1001	1051	1041	1005	1066
National	1095	Fujitsu	1008	1007	1052	1046	1007	1093
1004	1119	1027	1012	1029	1079	1048	1011	1103
1026	1130	Funai	1020	1038	Montgomery	Philips	1026	Scott
1110	1157	1026	1031	1043	Ward	1004	1029	1005
1111	Daewoo	1027	1032	1044	1002	1005	1045	1007
1112	1005	GE	1034	1045	Motorola	1008	1061	1011
AOC	1006	1000	1035	1045	1004	1011	1095	1021
1005	1007	1001	1044	1104	1097	1018	1096	1025
1006	1015	1004	1054	1116	MTC	1038	RCA	1026
1007	1016	1005	1062	1130	1005	1040	1000	1027
1099	1017	1007	1063	1132	1006	1041	1001	Sears
1100	1080	1020	1081	1147	1007	1046	1004	1001
1113	1095	1031	1095	1157	1063	1053	1005	1005
Apex	1108	1032	1096	Magnavox	Multitech	1054	1006	1007
1140	Daytron	1054	1104	1005	1026	1055	1007	1012
1148	1005	1104	1130	1007	NAD	1056	1018	1013
1150	1007	1120	1132	1008	1007	Pioneer	1102	1018
Audiovox	1095	1130	1147	1018	1043	1005	1104	1027
1026	Dimensia	1132	1157	1038	1044	1007	1108	1028
Bell & Howell	1001	1157	Jensen	1040	1106	1057	1130	1029
1002	1130	1158	1005	1041	1126	1058	1132	1030
1029	1157	Goldstar	1007	1046	1147	1059	1138	1039
1045	Dumont	1005	JVC	1047	NEC	1102	1144	1043
Broksonic	1005	1006	1011	1048	1004	1106	1155	1044
1143	1084	1007	1012	1055	1005	1126	1157	1045
1151	Electroband	1011	1013	1082	1006	1138	1158	1067
Celebrity	1003	1018	1032	1083	1007	Portland	Realistic	1068
1003	Electrohome	1033	1037	1124	1010	1005	1029	1103
Centurion	1003	1034	1039	1125	Nikko	1006	1045	1104
1009	1004	1035	1089	1129	1007	1007	1130	1107
Citizen	1005	1087	1090	1139	1015	1015	1157	1130
1005	1018	1088	1105	Majestic	1015	1095	Runco	1132
1007	1019	1095	1127	1002	Onwa	Price Club	1084	1147
1008	1020	1096	1146	Marantz	1026	1063	Sampo	1157
1015	Emerson	Hallmark	Kawasho	1005	Optimus	Prima	1005	Sharp
1026	1005	1005	1003	1007	1106	1142	1007	1005
1045	1007	Hisense	1005	1036	1126	Prism	1095	1007
1063	1011	1141	1007	1038	Optonica	1032	1096	1011
1095	1021	Hitachi	Kenwood	1049	1061	Proscan	1156	1022
1119	1022	1005	1005	Megatron	1097	1000	Samsung	1023
Colortyme	1023	1007	1018	1036	Orion	1001	1005	1061
1005	1024	1011	Kloss	Memorex	1025	1104	1006	1069
1007	1025	1012	Novabeam	1002	1109	1130	1007	1070
1010	1026	1013	1026	1006	Panasonic	1132	1011	1071
Contec/Cony	1027	1036	1040	1007	1004	1157	1014	1077
1011	1029	1037	1041	1029	1032	1158	1018	1095
1012	1045	1102	1098	1045	1038	Proton	1062	1097
1013	1078	1126	KTV	MGA	1094	1005	1063	Signature
1026	1095	1134	1026	1005	1121	1007	1064	1002
Craig	1101	1135	1042	1006	1128	1011	1095	1072
1026	1102	1136	1095	1007	1152	Quasar	1096	Sony
	1109	1137	1101	1018	1153	1004	1114	1003
	1127	1138		1020		1032	1133	1115
				1030		1042		1122
								1123

Chapter 2: The Remote Control

Code List for TV button

TV (continued)

Soundesign	Toshiba	VCR	2006	2001	Kenwood	2041	Philips	2061
1005	1029		2010	2002	2006	2042	2018	2064
1007	1043	AUX button	2013	2010	2007	2060	2038	2067
1008	1044	Admiral	2015	2018	2008	2065	2048	2071
1026	1045	2069	2018	2019	2013	Montgomery	2066	2074
1027	1063	Aiko	2019	2061	2015	Ward	Pioneer	2075
Starlite	1067	2024	2021	2064	2058	2069	2007	2078
1026	1074	Aiwa	2061	2074	2065	Motorola	2034	2087
Supre-Macy	1075	2023	2074	2087	KLH	2018	2043	2088
1098	1091	Akai	Daewoo	2088	2037	2069	2065	Realistic
Sylvania	1092	2003	2012	Go Video	Kodak	MTC	Portland	2008
1005	1145	2004	2014	2073	2011	2010	2013	2010
1007	1147	2005	2016	2076	2018	Multitech	2014	2011
1008	Totevision	2058	2022	Goldstar	LG	2010	2016	2012
1018	2059	2059	2023	2006	2011	2013	2057	2018
1038	Universal	2060	2024	2011	Logik	2023	Proscan	2019
1040	1031	Audiovox	2057	2015	2037	2032	2000	2020
1041	1054	2011	Daytron	2033	LXI	2037	2001	2023
1046	Wards	Bell & Howell	2057	2036	2011	NEC	2002	2025
1047	1001	2008	Dimensia	Gradiente	Magnavox	2006	2074	2030
1048	1002	Broksonic	2002	2023	2018	2007	2087	2048
1055	1005	2009	2074	Harman	2019	2008	2088	2069
1073	1006	2022	Electrohome	Kardon	2038	2013	Quasar	Ricoh
1092	1007	2083	2011	2006	2039	2015	2018	2072
1154	1018	Calix	2025	Harwood	2053	2058	2019	Runco
Symphonic	1021	2011	Emerson	2037	2055	2065	2067	2053
1024	1024	Canon	2003	Hitachi	2066	Nikko	Radio Shack	Samsung
1026	1027	2018	2009	2034	Marantz	2011	2011	2005
1107	1031	2019	2011	2035	2006	Noblex	2048	2010
Tandy	1038	Capehart	2012	2036	2007	2010	2069	2012
1097	1040	2018	2054	2054	2008	Olympus	Radio	2028
Tatung	1041	2021	2058	2064	2013	2018	Shack/Realistic	2032
1004	1046	2022	2064	JC Penney	2015	Optimus	2008	2059
Technics	1047	2023	Emerson	2006	2018	2011	2010	2079
1032	1054	2025	2007	2007	2038	2069	2011	2085
Techwood	1055	2026	2008	2009	Matsushita	Optonica	2018	Sansui
1005	1061	2027	2009	2010	2018	2048	2019	2007
1007	1076	2028	2010	2011	Memorex	Panasonic	2020	2047
1032	1130	2029	2011	2018	2008	2018	2023	2058
Teknika	1157	2040	2018	2019	2010	2019	2025	2065
1002	Yamaha	2060	2018	2020	2011	2056	2030	Sanyo
1005	1005	2062	2019	2031	2018	2067	2048	2008
1006	1006	2068	2031	2034	2020	Pentax	Radix	2010
1007	1007	2070	2034	2035	2023	2013	2011	2020
1007	1018	2084	2035	2037	2053	2034	RCA	2080
1008	Zenith	Fisher	2037	2038	2069	2035	2000	Scott
1011	1002	2020	2054	2054	MGA	2054	2001	2009
1012	1005	2030	Jensen	2064	2025	2064	2002	2012
1013	1084	2031	2034	Pentex	2040	Research	2003	2022
1015	1085	2035	2035	2060	2060	2015	2010	2027
1026	1086	2058	2058	Minolta	2034	Philco	2018	2029
1027	1117	2063	2063	2034	2035	2018	2034	2040
1047	Curtis Mathes	2007	Funai	2006	2054	2019	2035	2062
1063	2002	2008	2023	2007	Mitsubishi	2038	2044	2011
1094	Garrard	2015	2058	2015	2025	2039	2045	2018
1095	GE	2065	2077	2058	2034		2046	2023
1121		2000		2040	2035		2054	2052
1128					2040			
Telecaption								
1074								

Code List

VCR (continued) AUX button

Sears	2018	PVR	5088	DVD	Panasonic	DVD/VCR	Cable Box	Philips
2008	2023	AUX button	5090	DVD button	3006	DVD	CABLE button	5012
2011	2052	Tivo	5091	Aiwa	3021	button	ABC	5013
2018	Toshiba	2082	5092	3004	3056	& AUX	5003	5014
2020	2012	Satellite	5093	Apex	3057	button	5004	5015
2030	2030	SAT button	5094	3007	Philips	button	5005	5019
2031	2031	Alphastar	RCA	3008	3002	Broksonic	5007	5025
2034	2034	5068	5000	3048	3044	DVD 3050	5046	5029
2035	2040	Chaparral	5001	3049	3046	VCR 2083	Archer	5030
2054	2060	5050	5086	Broksonic	Pioneer	Emerson	5010	5031
Sharp	Totevision	5051	5087	3022	3022	DVD 3052	5011	Pioneer
2014	2010	Dishnet	5088	3023	3023	VCR 2084	Cableview	5032
2025	2011	5067	5090	Proscan	Pioneer	Go Video	5008	5033
2048	Unitech	Drake	5091	3001	Pioneer	DVD 3040	Contec	Proscan
2049	2010	5052	5092	3062	Qwestar	VCR 2077	5016	5002
2069	Vector	5053	5093	Emerson	3024	JVC	Eastern	5004
Shintom	Research	Echostar	5094	3011	RCA	DVD 3041	5017	RCA
2004	2006	5074	Realistic	3012	3001	VCR 2077	GE	5002
2035	2007	Express Vu	5057	3052	3001	RCA	5002	5008
2037	2012	5084	Sony	Funai	3026	DVD 3042	5003	5041
2050	2013	Star Choice	5062	3012	3041	VCR 2078	5004	5043
Signature	Video	5085	Star Choice	GE	3060	Sanyo	Gemini	5045
2069	Concepts	STS1	5085	3001	3061	DVD 3043	5018	Realistic
Singer	2006	5058	STS1	3013	3062	VCR 2078	5019	5010
2018	2007	STS3	5059	Go Video	Samsung	Sony	General	Samsung
2037	2012	5060	STS4	3040	3027	DVD 3058	Instruments	5033
2072	2013	5091	5060	Hitachi	3039	VCR 2086	5004	Scientific
Sony	2060	5092	Toshiba	3014	Sansui	Zenith	Hamlin	Atlanta
2004	Wards	5093	5061	JVC	3032	DVD 3045	5020	5007
2050	2010	5094	5063	3041	Sanyo	VCR 2081	5021	5035
2051	2011	General	5076	Kenwood	3043	Sony	5022	5036
2063	2012	Instruments	5077	3015	Sharp	DVD 3058	5027	5037
2086	2018	5054	5078	Konka	3028	VCR 2086	5034	Signature
STS	2020	5055	5079	Koss	3047	Sony	Hitachi	5004
2018	2023	5056	5080	3051	Sony	5004	5004	Sprucer
2054	2025	Hitachi	5081	Lasonic	3029	Jerrold	5018	5045
Sylvania	2034	5070	5082	3038	3030	5004	5023	Standard
2018	2035	5071	5083	Magnavox	3031	5018	5024	Component
2019	2037	Hughes	Uniden	3002	3058	5023	5024	5039
2023	2048	Network	5073	Sylvania	Sylvania	5024	5040	Starcom
2038	2054	Systems	HDTV Tuner	3012	3012	5046	5046	5018
2039	2062	5066	RCA	3059	3059	Magnavox	5025	5046
2040	2069	5075	3000	Memorex	Toshiba	5025	Motorola	Stargate
2066	2071	JVC	RCA	3017	3033	5018	5047	5018
Symphonic	XR-1000	5069	3000	Mintek	3034	5023	5048	Tocom
2023	2018	Panasonic	HDTV Tuner	3018	3035	5038	5049	5005
Tandy	2023	5064	RCA	Mitsubishi	3036	5039	Movie Time	5023
2008	2037	Philips	3000	3003	Zenith	5049	5026	United Cable
Tashiko	Yamaha	5072	RCA	NAD	3037	NEC	NEC	5046
2011	2006	5077	3000	3011	3045	5006	5006	Universal
Tatung	2007	Primestar	HDTV Tuner	Norcent	Norcent	5026	5026	5009
2058	2008	5065	RCA	3019	3019	NSC	NSC	5010
Teac	2015	Proscan	3000	Onkyo	Onkyo	5026	5026	5011
2058	2058	5001	RCA	3020	3020	Oak	Oak	View Star
2023	Zenith	Philips	3000	Oritron	Oritron	5016	5016	5016
2058	2004	5072	Philips	3024	3024	5028	5028	5025
Technics	2050	5077	5072	Panasonic	Panasonic	Panasonic	Panasonic	5026
2018	2053	5077	5077	5042	5042	5045	5045	Zenith
2056	2063	5077	5077	5045	5045			5044
Teknika	2072	5077	5077					
2011	2081	5077	5077					

CD Player

AUDIO button

ADC

4066
4067
4077

Aiwa

4051
4068

Akai

4069

Denon

4071

Emerson

4052

Fisher

4053
4074
4075

GE

4076

Hitachi

4054

JVC

4055

Kenwood

4056
4078
4079

Luxman

4080

Marantz

4058

MCS

4081

Mitsubishi

4082
4083

Nakamichi

4085
4086

NEC

4057

Onkyo

4059

4087

4088

Optimus

4089
4090
4091

Panasonic

4060

Pioneer

4061
4092

Proscan

4007

RCA

4073
4100

Sanyo

4099

Sears

4070

Sherwood

4093

Sony

4062
4072
4094

Teac

4095
4096
4097

Technics

4063

Toshiba

4084

Yamaha

4064
4065
4098

Audio Receiver Tuner AUDIO button

Aiwa

4008
4009
4010
4019

Denon

4023

Harman Kardon

4018

JBL

4018

JVC

011

Kenwood

012

Onkyo

4020

Optimus

4024

Panasonic

4021

RCA

4013
4027
4028
4031

4034

4044

Sherwood

4022

Sony

4014
4015

Technics

4021

Yamaha

4016
4017

Home Theatre In A Box AUDIO button & DVD button

JBL

Audio 4037
DVD 3053

JVC

Audio 4038
DVD 3054

Koss

Audio 4035
4036
DVD 3055

Audio AUDIO button

GE

4050
4004
4006
4047
4048
4049
4043
4003

Proscan

4050
4004
4006
4047
4048
4049
4043
4003

RCA

4050
4025
4006
4047
4048
4049
4043
4003
4004

Phono AUDIO button

GE

4005

RCA

4005

Chapter 3

Recording, Playback & Features

- Watching TV
- DVD Recording (DVD+R and DVD + RW)
- Disc Library
- DVD Playback
- VCR Recording
- VCR Playback

Graphics contained within this User's Guide are for representation only. Some of the menu screens, buttons, and display messages might be different in your product than they appear in this book. The on-screen help text provides the most current operational information.

Watching TV

Turn on the DVD/VCR to Watch TV

1. Turn on the TV, and tune the TV to the correct Video Input Channel (this channel corresponds to the input jacks on your TV that you used to connect the DVD/VCR to the TV).
2. Turn on the DVD/VCR (the DVD/VCR's main menu appears).
3. Since the *Watch TV* menu is already highlighted, just press the OK button on the remote (the DVD/VCR tunes to the last station you watched and a channel banner appears). To see the channel banner after it disappears from the screen, press INFO on the remote control.

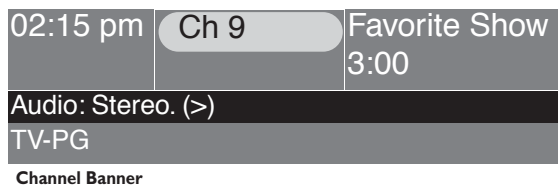

The Channel Banner

While watching TV, press INFO on the remote control to see the channel banner. The information that appears in the channel banner depends upon the information sent from the broadcaster. For example, the rating, the program name, and the time the program ends are not always sent by the broadcaster.

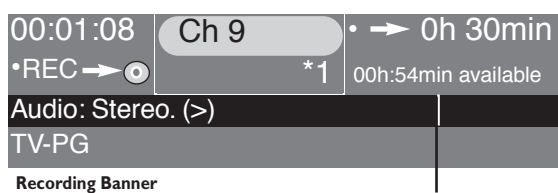

DVD Recording

After you load a DVD+R or DVD+RW disc into the DVD/VCR's disc tray, there are several ways to record programming. When you insert a blank DVD+R or DVD+RW disc, the DVD/VCR will need to format the disc so you may need to wait several seconds. The quickest way to start recording is to press the RECORD button while you're watching a show (the recording banner appears). You don't even need to remember to press the stop button if you use the Express Recording feature in the recording banner (see next section).

Note: When you stop recording, the DVD/VCR takes several seconds to save information to the disc. A still frame of the recording may appear on the screen before you are returned to TV viewing.

Notes:

The DVD/VCR won't record copy-protected material.

The first time you load a DVD+R or DVD+RW disc, the DVD/VCR will format it.

Remember, if you're using a DVD+R disc you must finalize it if you want to play the disc in another DVD player (page 33).

Express Recording Feature

Each time you press the RECORD button on the remote the recording time increases by 30 minutes, up to the maximum limit (the status is listed on the far right side of the recording banner). The DVD/VCR will record for the amount of time you specified and then stop automatically. If you press INFO, the amount of recording time left appears. At anytime during the recording, you can extend the recording time by pressing the RECORD button. If you only press RECORD once, the recording will not stop automatically—you will need to press the STOP button to stop recording.

IMPORTANT:

When you record to a DVD+R disc, you must finalize it before you can play it in another DVD player.

To finalize the disc (select the Disc menu from main menu, then select the *Disc Title Menu*. With the disc name highlighted, press OK. Select *Finalize Disc* and press OK. Once the disc is finalized you won't be able to change the name of the disc or the name of the titles on the disc.

Watching one channel while you record another channel

If you want to watch another channel while you're recording, you need to make sure you've connected an RF coaxial cable to the CABLE/ANTENNA OUTPUT jack on DVD/VCR and TV's corresponding Cable/Antenna Input jack.

1. Make sure the DVD/VCR and the TV are on. Tune the TV to the appropriate Video Input Channel (if you need help, go to page 18).
2. Using the DVD/VCR's channel buttons, tune to the program you want to record. Press the RECORD button.
3. If the remote that came with your DVD/VCR operates your TV, just press the TV button and use the channel up and down buttons to change the channel on the TV. If the remote doesn't operate your TV, use the TV's remote control to change channels.
4. When you're finished recording, remember to turn the TV back to its Video Input Channel and watch TV through the DVD/VCR.

Notes:

This feature might work differently if you receive programming via a cable box. If you receive programming via a satellite receiver, this feature isn't available—you can't record one satellite program and watch another satellite program.

The remote that came with your DVD/VCR is a programmable Universal remote that can be programmed to operate many brands and models of TVs. Go to page 21 if you want to program the remote.

When you stop recording, a delay may occur while the DVD/VCR generates information about the recording for the Disc Library.

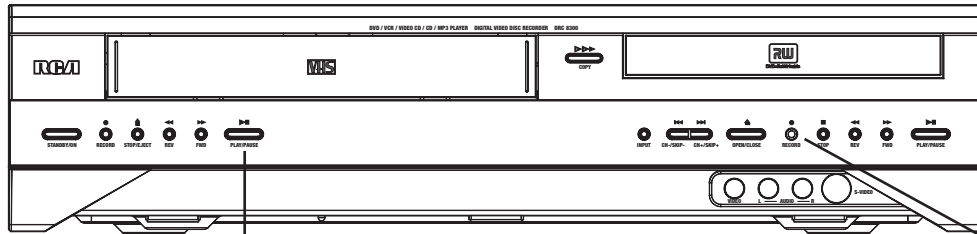

VCR PLAY/PAUSE button

DVD RECORD button

Watching a videocassette tape while you record to disc

1. Start recording on the disc (tune the DVD/VCR to the channel you want to record) and press RECORD).
2. Insert the videocassette tape you want to play after you've started recording on your DVD disc.
3. Make sure the TV is tuned to the channel that matches the jacks you used to connect the DVD/VCR to the TV (the TV's video input channel).
4. Press the VCR's PLAY button.

Note: The VCR will use the analog path because the DVD Recording is using the digital path. Therefore, the Info Display won't be available and the VCR menus will be different. More information is available in the VCR section of this chapter.

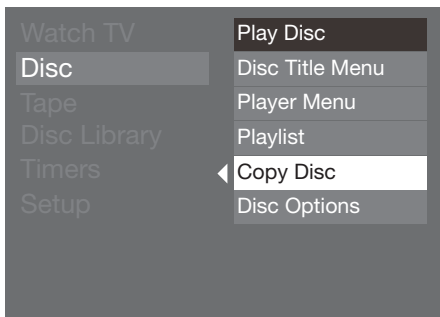
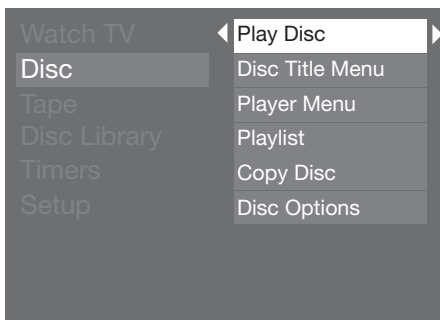

Copying a DVD disc (DVD+R or DVD+RW) to a Videocassette Tape

To copy a disc to tape, use the copy feature to save some steps.

1. Put a DVD+R or DVD+RW disc into the disc tray.
2. Put a blank videocassette tape into the VCR deck.
3. If the main menu isn't on the screen, press MENU.
4. Press the down arrow button until the *Disc* menu is highlighted, and press OK.
5. Press the down arrow button until *Copy Disc* is highlighted, and press OK.
6. Since *Copy Disc* is highlighted, just press OK (the DVD/VCR starts playing the disc and recording the disc to the videotape automatically). All the titles on the disc will be copied.
If you don't want to record the disc onto the videocassette tape, press the down arrow button to highlight *Cancel* and press OK.
7. If you only want to copy a specific title or a specific chapter, you can create a playlist (go to page 48 for instructions).

Notes:

You can't copy pre-recorded DVDs that are copy-protected. Most movies on DVD discs are copy-protected.

If you set up a playlist on the DVD disc, only the content of the playlist will be copied. To copy the entire disc, you'll need to delete the playlist first.

You can also copy a disc to tape via the Timers menu by setting up a Transfer Timer (for more information, go to page 30).

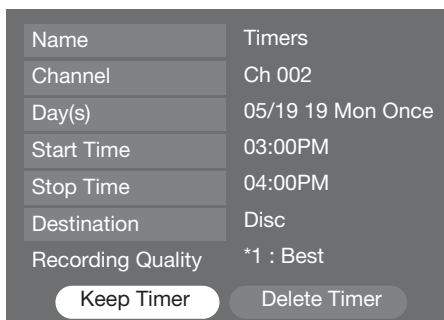
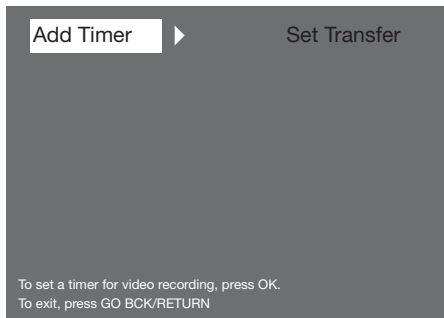

Timer Setup Screen

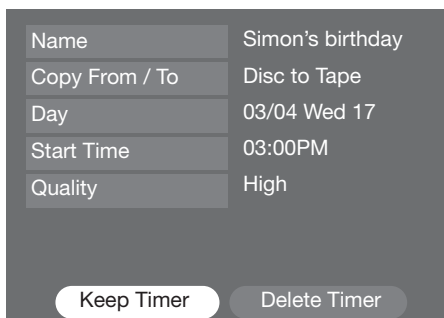

Transfer Setup Screen

Timer Recordings

Setting up timer recordings to record programs automatically

1. From the DVD/VCR's main menu, use the remote's arrow buttons to highlight *Timers*, and press the OK button.
- Tip: You can also access the Timers menu by pressing the **TIMER•GUIDE** button on the remote control.**
2. Since *Add Timer* is highlighted, just press OK (the Timer Setup screen appears).
3. If you want to give the Timer a name, highlight *Name* and press the INFO button (the on-screen keyboard appears—follow the on-screen instructions to name the timer). When finished entering the name, make sure you press the right arrow button to highlight *Done* and press OK.
4. Press the down arrow button to highlight the *Channel* field and use the number buttons on the remote to enter the channel number, and press OK (highlight moves to *Day*).
To enter a Video Input Channel, press the right arrow button.
5. Use the number buttons to enter month and day. To change the frequency (once, daily, weekly, etc.), press the right arrow button. When finished, press OK (highlight moves to *Start Time*).
6. Use the number buttons to enter the time you want to start recording. Press the right arrow button to change the a.m./p.m. setting. When finished, press OK (the highlight moves to *Stop Time*).
7. Use the number buttons to enter the time you want the DVD/VCR to stop recording. Press the right arrow button to change a.m./p.m. setting. When finished, press OK (the highlight moves to *Destination*).
8. With *Destination* highlighted—press the right arrow button to switch between *Tape* (to record to the VCR) and *Disc* (to record to a DVD+R or DVD+RW disc). When finished, press OK (the highlight moves to *Recording Quality*).
9. You can change the quality of the recording by pressing the right arrow button. The better the quality, the more space the recording takes up on the disc or tape—(go to page 52 for more information). Press OK to confirm the quality recording setting.
10. When you're finished, make sure *Keep Timer* is highlighted and press OK.

Notes: The DVD/VCR's clock must be set in order for Timer Recordings to work properly.

Setting up timer recordings to transfer a disc to tape or tape to disc

1. From the DVD/VCR's main menu, use the remote's arrow buttons to highlight *Timers*, and press the OK button.
2. Press the right arrow button to highlight *Set Transfer* and press OK (the Transfer Setup screen appears).
3. If you want to give the Timer a name, press the INFO button when *Name* is highlighted (the on-screen keyboard appears—follow the on-screen instructions to name the timer). When finished entering the name, make sure you press the right arrow button to highlight *Done* and press OK (the on-screen keyboard disappears). Press OK again (highlight moves to *Copy From / To*).
4. Press the right arrow button to choose whether you want to copy *Disc to Tape* or a *Tape to Disc*. Press OK, the highlight moves to *Day*.
5. Use the number buttons to enter month and day. When finished, press OK (highlight moves to *Start Time*).
6. Use the number buttons to enter the time you want to start recording. Press the right arrow button to change the a.m./p.m. setting. When finished, press OK (the highlight moves to *Quality*).
7. To change the quality, press the right arrow button.
8. When you're satisfied with the settings, press the arrow down button to highlight *Keep Timer*, and press OK. Make sure the disc is in the disc tray and the tape is in the VCR deck before the Timer Recording is ready to start.

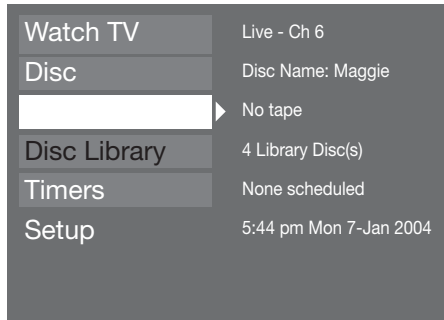

Shows you've recorded to a DVD+R or DVD+RW disc are called titles.

Disc Library

You can find a show you recorded to disc more quickly by using the DVD/VCR's Disc Library. Everytime you use your DVD/VCR to record a program, the DVD/VCR assigns the disc a number, and keeps track of what you've recorded and when you recorded it. The disc's library stores the following information about each disc:

- Disc Name and Number
- The number of titles (recordings) on a disc
- Recording space available on a disc
- Name of the title (show, program, movie)
- Date the program was recorded
- Genre of the program (you may need to assign)
- Which disc is loaded (indicated by a round disc symbol next to the title or disc name)

Editing the Genre of a Title

Most of the Disc Library's contents are automatically created if the information is available, but you can add or change the genre when the disc is loaded in the DVD/VCR.

1. Insert the DVD+R or DVD+RW disc into the DVD/VCR that has the recorded program with the genre information you want to edit.
2. Highlight *Disc Library*, and press OK. If you want to edit the genre information for one of the recorded programs, use up/down arrow buttons to highlight the program. The round disc should be next to the title, indicating that the disc is loaded in the DVD/VCR.
3. Press right arrow (the *Sort by Title* option is highlighted).
4. Press down arrow until *Assign Genre* is highlighted, and press OK (a list of genres appears).
5. Use the up/down arrow buttons to highlight a Genre and press OK. It will take about 15 seconds for the DVD/VCR to save the information.

Since the Disc Library is saved in the DVD/VCR, you have a limited amount of space to keep disc contents. If the Disc Library becomes full, you'll have to delete some of the discs from the Disc Library to make room.

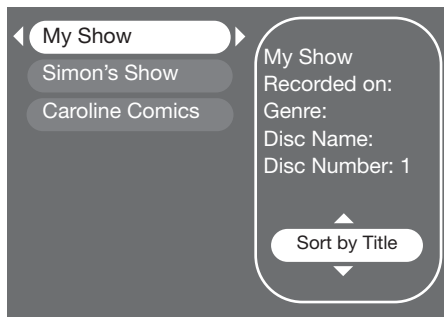

Finding a title (movie, program, etc) by using the Sort Feature

1. Press MENU (the main menu appears).
2. Press the down arrow button until *Disc Library* is highlighted, and press OK (a list of titles appears).
3. Press the right arrow button. Each time you press the down arrow button, the next option appears.

Sort by Title

When you press OK with *Sort by Title* highlighted, the on-screen keyboard appears. Enter the first character of the title you're trying to find and select *Done* (the titles starting with that letter appear, with the first in the list highlighted).

Sort by Genre

Lists contents of the disc by the Genre (you may need to assign a genre to recordings). Use the arrow buttons to highlight a Genre, and press OK (all titles that you've assigned to that Genre appear).

Sort by Date

Lists contents of the disc by the date recorded.

Other Sorting Options—Show All Discs

When you choose *Show All Discs*, additional sorting options appear:

Sort by Space: Lists the discs by the amount of recording space left.

Sort by Disc No.: Lists the discs numerically.

Sort by Disc Title: Lists discs alphabetically by disc title.

Show All Titles: Lists all the titles recorded.

Delete Discs: Deletes the disc that is highlighted and the its contents from the Disc Library, but doesn't delete the contents from the disc—the titles are still on the disc.

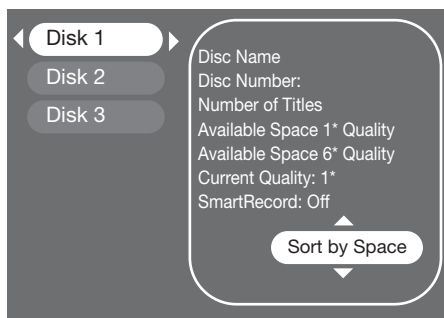

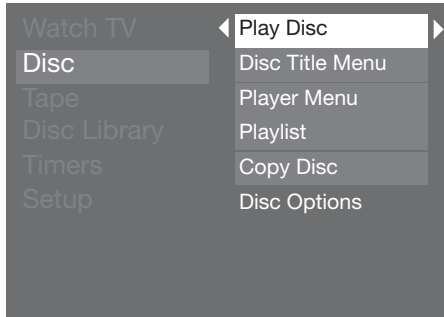
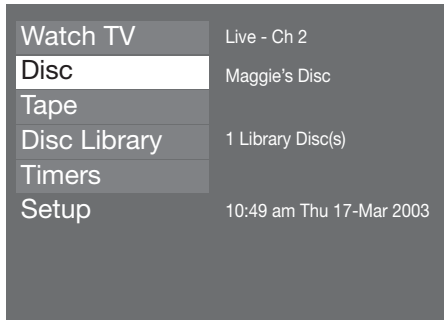

DVD Playback

To play recordings, do the following:

1. Turn on the TV and the DVD/VCR.
2. Make sure the TV is tuned to the correct Video Input Channel (for help, go to p. 18).
3. Insert the DVD+R or DVD+RW disc you want to play.
4. Once the DVD/VCR reads the disc's contents, the main menu appears. If the main menu doesn't appear, press MENU (the main menu appears).

Notes:

If you selected **Autoplay On** in the **Disc Options** menu (page 49), the disc's title menu appears automatically when you insert the disc.

If the screen is blank, you might not have your TV tuned to the correct Video Input Channel. For more information about Video Input Channels, go to page 18.

5. Use the up and down arrow buttons on the remote to highlight the *Disc* menu, and press OK (the options appear).
6. There are two ways to access your recordings within these menu options:

Play Disc: If you want to play all of the recordings on the disc (or there is only one recording), just press OK when this menu is highlighted (the first recording plays).

Disc Title Menu: Press OK when this menu option is highlighted (all of the recordings/titles on the disc appear). Use the arrow buttons to highlight the title you want to select:

- To watch the program that you've highlighted, press PLAY.
- If you want to name the program, delete it, or change the play mode, press OK (the options appear).

Rename Title: For DVD+RW discs or DVD+R discs which have not been finalized.

Play Title: Plays the movie, program or show.

Play Full Title: Can only be selected for DVD+RW discs that may have hidden chapters.

Delete Title: For DVD+RW discs only.

Note: You can delete a title from a DVD+R disc that hasn't been finalized but the program will still be on the disc. You will not be able to access the program once the title has been deleted.

Clear Chapters: For DVD+RW discs only.

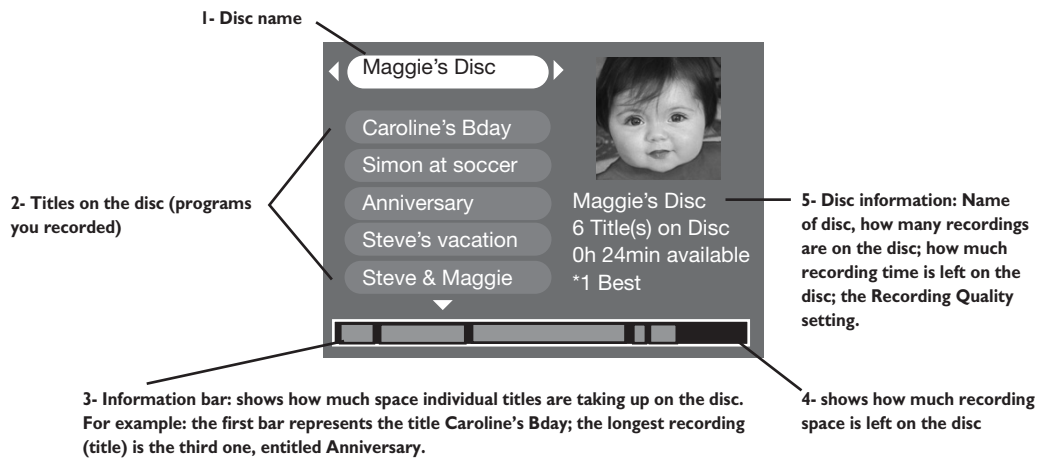

Disc Information

In addition to providing information about individual titles on the disc, the *Disc Title Menu* gives you helpful information about the disc itself. After you've inserted the DVD+RW disc or DVD+R disc, select *Disc* from main menu, highlight *Disc Title Menu* and press OK.

The picture above is an example of what you'll see (details are on the next page).

I- Disc name

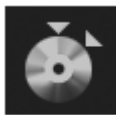
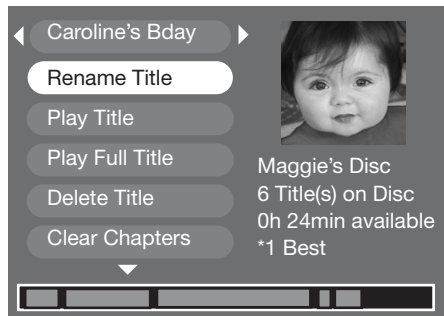
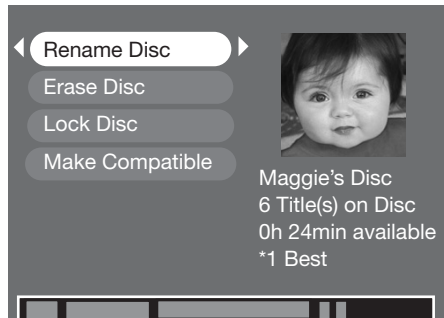
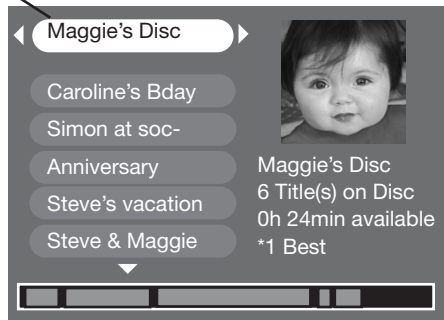

The Edit icon

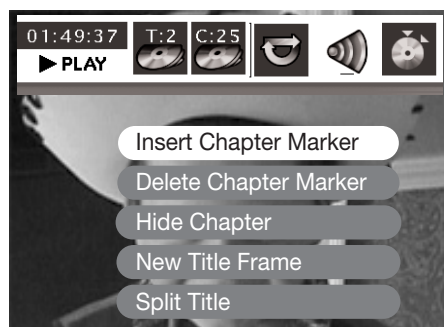

The top menu bar is the name of the disc. With the disc name highlighted, press OK and the options described below appear:

Note: You cannot select the disc name for a finalized DVD+R disc.

Rename Disc: press OK, on-screen keyboard appears so you can change the name of the disc (I on illustration above left).

Erase Disc: DVD+RW discs only. Erases a DVD+RW disc so you can record new programming onto it (not available for DVD+R disc).

Lock Disc: DVD+RW discs only. Protects contents of the DVD so nobody can record new programming onto it. If the disc has been locked, the menu option changes to *Unlock Disc* (not available for DVD+R discs).

Finalize Disc: DVD+R only. Enables a DVD+R disc to be played in other DVD players. Not available if the disc has already been finalized. After a disc is finalized, you can't record more programs to the disc.

Make Compatible: DVD+RW discs only. If you have made edits to the disc (described in the next section), such as adding or deleting chapter markers or hiding chapters, this option enables the edited version of the disc to be compatible with other DVD players.

If you press OK when a title is highlighted, the following options appear:

Rename Title: Press OK when highlighted, and the on-screen keyboard appears. Follow the on-screen instructions to give the disc a different name. Highlight *Done* when you're finished, and press OK.

Play Title: Press OK when highlighted to play the title.

Play Full Title: Press OK when highlighted to play a title which has been edited by hiding chapters if you want to play the title in its entirety (even the hidden chapters). Not available for DVD+R discs.

Delete Title: Press OK when highlighted to delete the title. Follow the on-screen instructions on the confirmation screen to delete the title. (Not available for finalized DVD+R discs.) If you delete a title from a non-finalized DVD+R disc, the information will still be on the disc but the title will be erased so there won't be any way to access the title.

Clear Chapters: The DVD/VCR adds a chapter marker every 5 minutes of recording. You can also add chapters manually. When you highlight this option and press OK, all chapter markers are erased. (Not available for DVD+R discs).

Editing DVD+R and DVD+RW discs

While playing the disc, press the INFO button on the remote (the Info Display appears). Details about the different icons appear in Chapter 4: Playing Discs. However, the edit feature includes special options for DVD+RW discs.

- While playing a disc, press the INFO button.
- Press the right arrow button to highlight the Edit icon , and press OK. The following choices appear (use the up/down arrow buttons to highlight a choice and press OK to select).
 - Insert Chapter Marker** (DVD+RW discs only). When you're recording to a disc, the DVD Recorder adds a chapter marker automatically every 5 minutes. Additionally, you can insert chapter markers manually to segment different parts of the title. To insert a chapter marker, simply highlight *Insert Chapter Marker* during playback at the point where you want the chapter to start.
 - Delete Chapter Marker** (DVD+RW discs only). Since the DVD/VCR automatically adds chapter markers every 5 minutes, you may want to make each chapter longer by deleting a chapter marker during playback.
 - Hide Chapter** (DVD+RW discs only). During playback you can hide a specific chapter so it is automatically skipped. For more information, go to page 34.
 - New Title Frame** You can change the thumbnail image that appears in the *Player Menu* (described in the next section). When the video appears that you want to use to visually represent the title, press OK (the next time you access the *Player Menu* a still image of this video will appear).
 - Split Title** (DVD+RW discs only). You can divide one recording into smaller segments so that each title appears separately in the *Disc Title Menu*. This is a helpful feature when you record a block of programming that contains several shows and/or when you copy camcorder videocassette tapes to a disc.

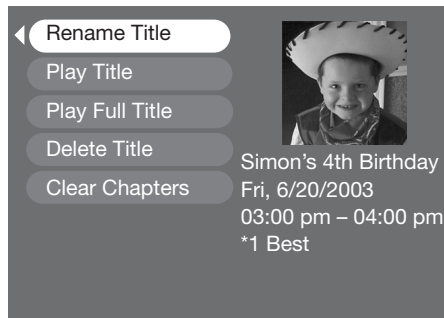

Editing Titles with the Hide Chapter Feature

As with most editing features on recorded discs, Hide Chapter is only available with DVD+RW discs. Some people use it to hide commercials or introductions to programs. You have to Insert a Chapter Marker at the beginning and the end of the part of the recording you want to “hide.”

Note: Since the DVD/VCR automatically adds a chapter marker every 5 minutes during recording, it might be a good idea to **Clear All Chapter Markers before using the Hide Chapter feature.** To find the Clear Chapters option, go to the Disc menu and select Disc Title Menu. Highlight the title you want to clear chapters from, and press OK. Highlight Clear Chapters, and press OK.

1. While playing the recording (called a title), press INFO (the Info Display appears).
2. Press right arrow until the Edit icon is highlighted, and press OK.
3. When you're at the beginning of the place you want to hide, press PAUSE. Then, highlight *Insert Chapter Marker* (if the Info Display isn't on the screen, press INFO and select the Edit icon).
4. Use FAST FORWARD or ADVANCE to go to the end of the segment that you want to hide, and select *Insert Chapter Marker* again.
5. To “hide the chapter” you must be playing it. Therefore, press REVERSE or AGAIN until playback is between the two chapter markers you just inserted. If the Info Display isn't on the screen, press INFO, select the Edit icon, and select *Hide Chapter* (each time the title plays this chapter will be automatically skipped).
6. To “undo” the Hide Chapter feature for normal playback, go to the *Disc Title Menu* and select *Play Full Title*.

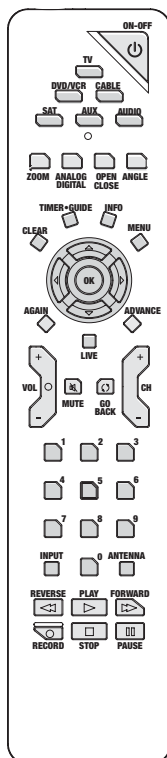

VCR Basics

The VCR part of your DVD/VCR has all the basic functions of other VCRs. The basic concepts are explained below and the advanced VCR features are explained on page 32.

Basic Playback

1. Tune the TV to your DVD/VCR viewing channel (03, 04, or the Video Input Channel).
2. Insert a tape in the DVD/VCR.
3. Press PLAY to play the tape.
 - Press FORWARD or REVERSE to cue the tape to the desired position during Play mode.
 - To advance the tape approximately 30 seconds at a time during Play mode, press the ADVANCE button on the remote control.
 - To go back approximately 10 seconds during play mode, press the AGAIN button.
 - Press PAUSE to stop action. For slow-motion playback, press FORWARD (while picture is paused). To move one frame at a time, press PAUSE on the remote (while paused)—each time you press PAUSE, the video moves forward one frame.
 - Press the CH +/CH- buttons to remove any streaks from the picture, if necessary.
 - Press STOP to stop playback.

Note: If both a DVD disc and VCR tape are in the DVD/VCR, go to the main menu (press MENU), select *Tape*, and press PLAY to start playing the tape.

Tape Eject

Press the STOP/EJECT button on the DVD/VCR when stopped to eject the tape. You can also press the OPEN•CLOSE button on the remote control to eject the tape.

Basic Recording

1. If necessary, change the tape speed (SP or SLP) in *Recording Options* menu (page 52).
2. If you're watching TV, press the RECORD button on the front of the DVD/VCR (the VCR's RECORD button that is next to the STANDBY/ON button turns on) to begin recording.
3. Press the STOP button to halt recording.

If you just want to pause the recording for a short time (like during a commercial), press PAUSE instead of STOP. To resume recording, press the RECORD button on the remote control.

Check the Safety Tab

Make sure there is a tape in the DVD/VCR with its safety tab in place. You cannot record on a tape if the safety tab has been removed. If the safety tab is removed and you want to record, simply cover the hole with adhesive tape.



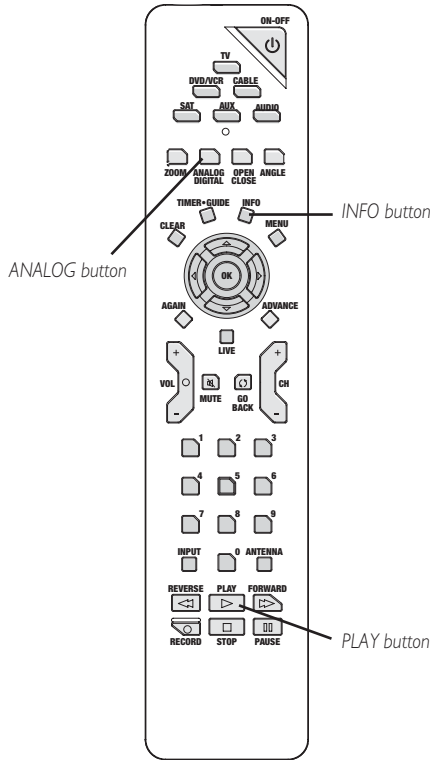

Advanced VCR Features

The VCR portion of your DVD/VCR combo works like most VCRs, but has some additional features for playback and copying tapes to disc. Most importantly, you need to understand the difference between digital and analog as it applies to the VCR portion of your DVD/VCR combo.

The analog setting provides standard playback that the majority of VCRs provide—play, stop, pause, record. In addition to standard VCR playback functions, the digital path provides you with all kinds of neat features that mimic a DVD. You can only use one path at a time: digital or analog.

All DVD functions must use the digital path—there is only one digital path. Therefore, there are times when the tape will play through the analog path (for example, when you record to a DVD disc and play a VCR tape at the same time).

The easiest way to see if you are using the Digital VCR path, is to press INFO during playback. If you're in the digital mode, an Info Display appears.

Advanced Playback

1. Insert a tape.
2. Press PLAY.
3. Press INFO (if the Info Display doesn't appear, press ANALOG DIGITAL on the remote control).
4. With the Info Display on the screen, use the left/right arrow buttons on the remote to highlight different icons to access the VCR playback features.

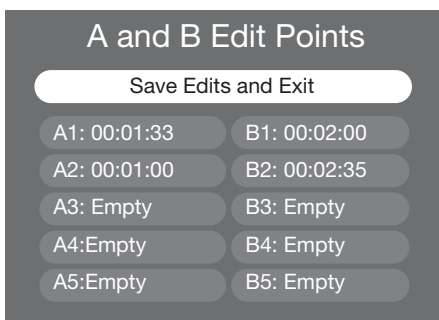
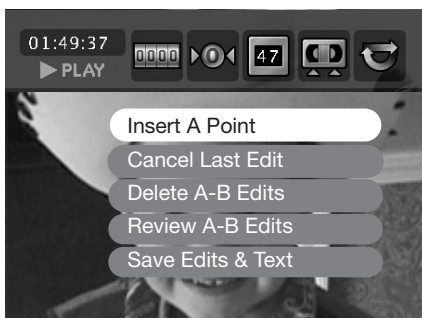
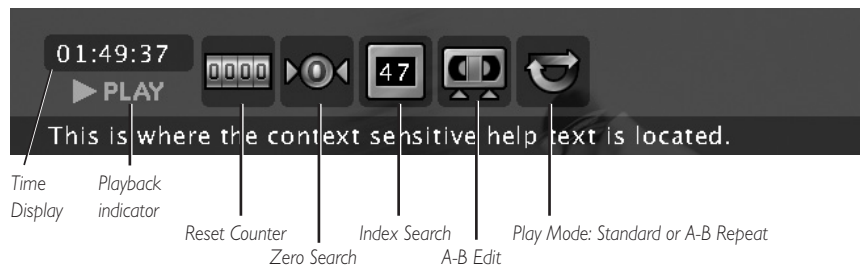
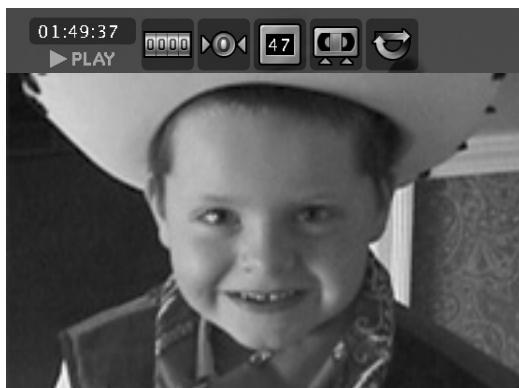

VCR Info Display

Above, the time display shows the amount of time that has elapsed on the tape. Below the time display is the play indicator that tells you the state of playback (play, pause, stop, etc.).

Note: These items are for display only—you cannot adjust or change them.

Reset Counter: Sets the 0 point, which means the elapsed time in the Timer Display starts from the point when you press OK with the Reset Counter icon highlighted.

Zero Search: Fast forwards or rewinds the tape to the point that you selected as the 0 point (above).

Index Search: Each time you press RECORD on the VCR, the tape records an index mark. Use Index Search to quickly find the beginning of a program. With the Index Search icon highlighted, you can quickly go back or go forward to the next index point. Press FORWARD to go to the next Index Mark, press REVERSE to go to the previous Index mark. The Tape menu will be displayed while the DVD/VCR searches for the next Index Mark.

A-B Edit: This feature was designed so that you can copy your videotape collection of home movies to DVD discs in separate segments so the events appear as separate titles on the DVD disc. For example, you might have your wedding; a birthday party; and your family reunion on a tape from your camcorder recordings. If you set up A-B Edits, these events will appear as separate titles on the DVD disc. With the AB Edit icon highlighted, press OK (the options appear on the screen).

Insert A point/Insert B point: press OK to mark the beginning or the end of an A-B segment of the tape.

Cancel Last Edit: cancels the last action.

Delete A-B Edits: clears all A-B segments.

Review/Play A-B Edits: displays A-B edits, and allows you to start playing A-B Edits.

Save Edits & Exit: saves the A-B segments.

VCR Recording

After you put a videocassette tape in the VCR deck, there are several ways to record programming. The quickest way to start recording is to press the RECORD button (on the front of the DVD/VCR next to the STANDBY/ON button) while you're watching a show. You don't even need to remember to press the stop button if you use the Express Recording feature in the recording banner.

Note: The DVD/VCR supports Macrovision and won't record copy-protected material.

Express Recording Feature

Each time you press the RECORD button on the remote the recording time increases by 30 minutes, up to the maximum limit (the status is listed on the far right side of the recording banner). The DVD/VCR will record for the amount of time you specified and then stop automatically. At anytime during the recording, you can extend the recording time by pressing the RECORD button.

Watching one channel while you record another channel

If you want to watch another channel while you're recording, you need to make sure you've connected the DVD/VCR to the TV properly (both audio/video cables and an RF coaxial cable need to be connected):

1. Make sure the DVD/VCR and the TV are on. Tune the TV to the appropriate Video Input Channel (if you need help, go to page 18).
2. Put a tape with its safety tab intact into the VCR deck.
3. Using the DVD/VCR's channel buttons, tune to the program you want to record. Press the RECORD button.
4. If the remote that came with your DVD/VCR operates your TV, just press the TV button and use the channel up and down buttons to go to a different channel.

If the remote doesn't operate your TV, use the TV's remote control to change channels.

If you don't see a picture on the TV or the picture looks fuzzy ("noisy"), press the ANTENNA button on the remote control.

5. When you're finished recording, remember to turn the TV back to its Video Input Channel and watch TV through the DVD/VCR.

Notes:

This feature might work differently if you receive programming via a cable box. If you receive programming via satellite receiver, this feature isn't available—you can't record one satellite program and watch another satellite program.

The remote that came with your DVD/VCR is a programmable Universal remote that can be programmed to operate many brands and models of TVs. Go to page 21 if you want to program the remote.

Recording to tape while you watch a DVD disc

1. Make sure the DVD/VCR and the TV are on. Tune the TV to the appropriate Video Input Channel (if you need help, go to page 18).
2. Put a tape with its safety tab intact into the VCR deck.
3. Using the DVD/VCR's channel buttons, tune to the program you want to record. Press the RECORD button.
4. Put the DVD disc into the disc tray, and close it.
5. Press PLAY to start playing the DVD disc.

Notes: Since you're using the digital path to play the DVD disc, the VCR will be recording in true analog mode. Therefore, the advanced VCR features in the InfoDisplay won't be available when you play the tape.

Timer Recordings

Go to page 30 for instructions to set up Timer Recordings (both Add Timer and Set Transfer).

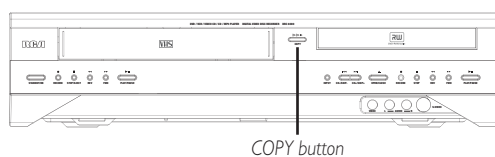

If you set up A-B Edits (page 35), only the A-B Edits will be recorded to disc when you use the COPY button on the front of the DVD/VCR.

Copying a Videocassette Tape to a DVD disc (DVD+R or DVD+RW)

To copy a disc to tape, use the COPY button on the front of the DVD/VCR to save steps.

1. Put a DVD+R or DVD+RW disc into the disc tray (if it's a blank disc, you'll need to wait for the DVD/VCR to initialize the disc).
2. Put the videocassette tape you want to transfer to a disc, into the VCR deck and make sure it's cued up or rewound to the beginning.
3. Press the COPY button on the front of the DVD/VCR.

The current record quality setting is displayed along with the Copy Mode. Press OK to confirm and begin the copy (the DVD/VCR starts playing the tape and recording onto the disc automatically). If you want to change the record quality setting, press the down arrow button to highlight *Cancel* and press OK. The record quality can be changed in the *Setup* menu (select *Recording Options*).

4. To watch TV while the tape is copying to disc, you'll need to change channels on the TV because the DVD/VCR is conducting two functions—playback of the tape and recording onto a DVD.

Note: You can't copy pre-recorded videocassette tapes that are encrypted with Macrovision software.

Chapter 4

Playing Discs

- **Regional Coding**
- **Types of Discs You Can Play**
- **How to Load and Play Discs**
- **Using the Different Menus**
- **Search Options**
- **Playback Options**
- **Using the On-Screen Info Display**

Graphics contained within this User's Guide are for representation only. Some of the menu screens, buttons, and display messages might be different in your product than they appear in this book. The on-screen help text provides the most current operational information.

Regional Coding

Both the DVD/VCR and the discs are coded by region. These regional codes must match in order for a pre-recorded DVD to play. This player's code is region 1. However, discs you use for recording (DVD+R and DVD+RW) aren't assigned region numbers.



Note: Some discs may not be compatible due to laser pickup and design.



This is an example of a one-sided disc.



This is an example of a two-sided disc—the title is usually in the center of the disc.

Tip

When you stop playing a disc, the player remembers where you stopped. When you start playing the disc again, the DVD/VCR picks up where you left off unless the disc is removed or the player is unplugged, or you press the STOP button twice.

Types of discs you can play

- DVD+R and DVD+RW discs – used to record programming. Instructions about playing and recording these discs are in Chapter 3.
- DVD Video discs – contain picture and sound [DVD-R, DVD-RW (video mode only), DVD+R, DVD+RW, and DVD ROM are compatible with this player]. DVD-R discs must be finalized.
- CDs (CD-R, CD-RW) – Audio CDs contain musical or sound content only. mp3 discs are CDs that contain mp3 files. This player is also capable of playing CDs that contain JPEG files, and Multisession CDs.
- Video CD discs – Like DVD video discs, VCDs contain picture and sound content. The difference is the amount of information that can be stored on the disc. VCDs typically have lower picture and sound quality than DVD discs.

Super Video CDs (S-VCDs) hold up to 70 minutes of digital sound and video, with MPEG-2 standard video and MPEG-1 standard audio (but you must use DVD+R or DVD+RW discs to record on your DVD/VCR, NOT S-VCDs). Additionally, S-VCD disc compatibility is dependent on which MPEG coding software, disc design software, and/or disc writer software are used; and the discs themselves.

You can't play the following types of discs: Laserdiscs, CD-I, CD-ROM (computer only discs), discs recorded using other broadcast standards (i.e. PAL or SECAM), or DVD-RAM discs.

Note: Some discs may not be compatible due to laser pickup and disc design.

To Load and Play Discs

Turn on the TV and your DVD/VCR (press ON•OFF on the remote or press the STANDBY/ON button on the DVD/VCR).

1. Make sure the TV is tuned to its Video Input channel (if you need more information, go to page 18).
2. Press the OPEN/CLOSE button (the disc tray opens).
3. Place a disc gently into the tray with the disc's label facing up (double-sided discs have content on both sides, so you can place either side up).
4. Press the OPEN/CLOSE or PLAY button. The disc tray closes. The DVD/VCR reads the disc's table of contents, and then one of three things happens depending on how the disc was programmed:
 - The disc starts playing.
 - The disc menu appears on the screen. One of the options will start disc play. Highlight that option and press OK.
 - The DVD/VCR's main menu appears on the screen. Highlight the Disc menu and press PLAY.

Note: If you don't see a picture, press STOP (the main menu appears), and check the position of the PROG SCAN switch on the back of the unit. Make sure the PROG SCAN switch is in the OFF position. Try playing the disc again.

The only time the PROG SCAN switch should be in the ON position is if you connected this unit to a progressive scan TV via Y, Pb, Pr COMPONENT jacks.

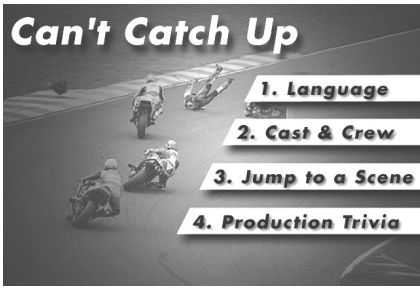

Using Different Menus

Each disc is programmed with different features. There are three separate types of menus that you can use to access features:

- **The Disc menu** – The Disc menu is part of each disc and is separate from the DVD/VCR's menu. The contents of each Disc menu vary according to how the disc was authored and what features are included.
To make the Disc menu appear, press the MENU button while the disc is playing.
- **The DVD/VCR's Info Display** – The Info Display appears as icons across the top of the screen when a disc is playing. It can only be accessed while you are playing a disc. It's turned on and off with the INFO button on the remote. The Info Display icons change based on the type of disc you're playing. Go to page 40 for more information.
- **The DVD/VCR menu** – If you're playing a disc, press STOP (the DVD/VCR's menu appears automatically).

Remember: A feature will only work if the disc was programmed with that feature. For example, if you choose subtitles on the Info Display, the subtitles will only appear if the disc was created with subtitles. If a menu or icon is "grayed out" it means that item (or feature) isn't available.

Search Options

Picture Scan

To search a disc during playback, use the FORWARD or REVERSE button. Each time you press FORWARD or REVERSE, your DVD/VCR scans the disc faster until you reach the fastest scan speed. To resume normal playback, press PLAY.

Note: Many DVD titles are programmed to prohibit skipping of warnings or credits so that you can't fast forward through them.

Freeze Frame and Frame Advance

While a disc is playing, press PAUSE to freeze the picture. To advance one frame at a time, press PAUSE again (the on-screen icon changes from PAUSE to FRAME). Each time you press the FORWARD or REVERSE button, the picture goes to the next (or previous) frame. To resume normal playback, press PLAY.

Slow Motion (in Freeze Frame Mode) – DVD discs only

While a disc is playing, press PAUSE. Press REVERSE or FORWARD (each time you press REVERSE or FORWARD the slow motion will get a little faster until you reach the fastest slow motion speed). To resume normal playback, press PLAY.

Time Search – DVD and VCD discs only

Make sure the Time Display (top left side of the Info Display) is highlighted, and then use the number buttons to enter a specific time on the disc that is playing. Go to page 41 for more information about the Time Display.

Quick Fast Forward and Quick Reverse – DVD and Audio CD only

While you're playing a disc, press the AGAIN button on the remote (the disc automatically repeats the last 10 seconds of the movie).

Similarly, press the ADVANCE button to go forward approximately 30 seconds.

Playback options

Many of your DVD/VCR's playback features are accessed through the Info Display (described on pages 40 through 44). Additionally, with some discs you can use the Zoom Feature to see details of an image.

Zoom

1. While you're playing a disc, press ZOOM (the player zooms in on the image). Each time you press ZOOM, the picture is magnified even more (until you get to the maximum zoom level).
2. To see other parts of the picture when you've zoomed in on the image, press the up, down, left, and/or right arrow buttons to go in corresponding directions.

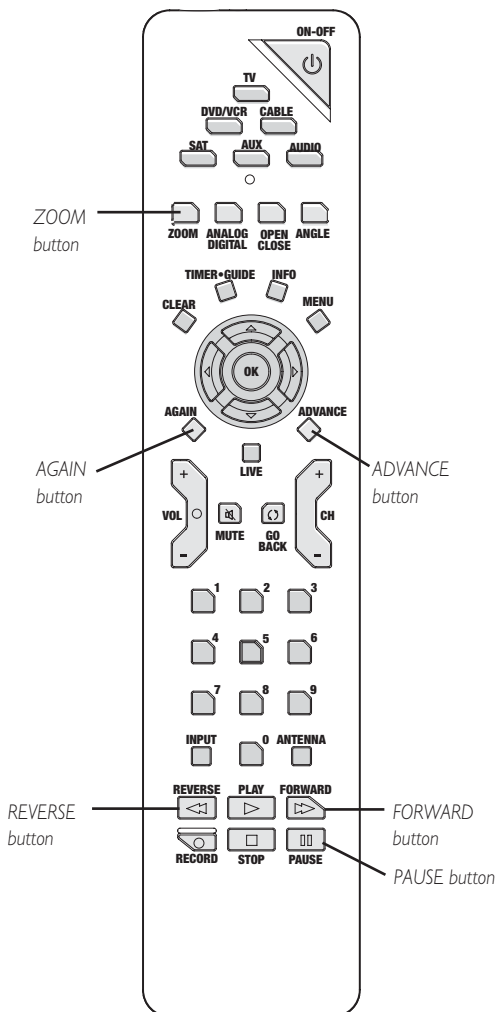

Using the On-Screen Info Display

The on-screen Info Display contains many playback features. To see the Info Display, press the INFO button on the remote while a disc is playing (the Info Display appears across the top of the screen). Each feature is illustrated with an icon. Use the left and right arrow buttons to move through the different icons in the Info Display. When an icon is highlighted, use the up and down arrow buttons on the remote to scroll through the choices.

Remember, you can only access the Info Display when you're playing a disc (or when playing a videotape via the digital path). Also, the Info Display features are only available if the disc was created with that particular feature (i.e., if you select the Angle icon, you won't be able to change the camera angle unless the disc was created with different camera angles). If one of the icons is "grayed out," the Info Display feature isn't available for the disc you're playing.

 The invalid symbol appears on the screen when you press a button that doesn't have any function. To make the Info Display disappear from the screen, press INFO on the remote control.

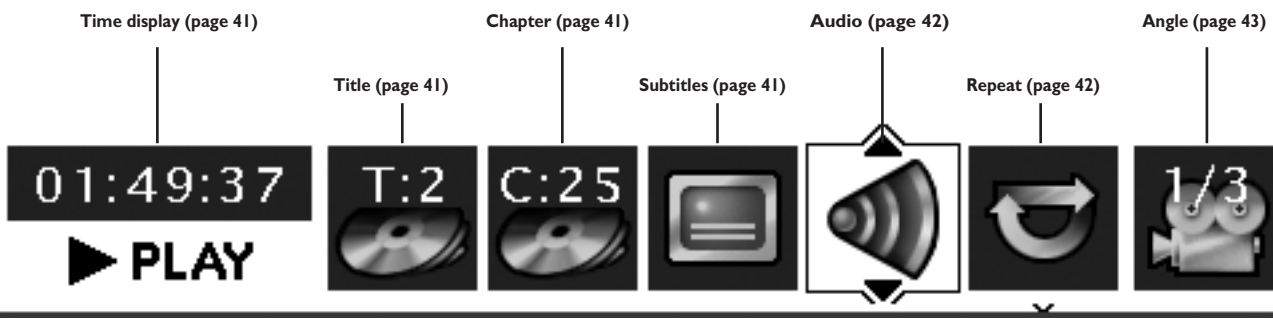

Text will appear here as you highlight different icons to help you use the Info Display.

This is the Info Display you'll see when you're playing a pre-recorded DVD disc. To make the Info Display appear, press the INFO button on the remote control. Use the left and right arrow buttons to highlight different icons. Use the up and down arrow buttons to scroll through the choices available.

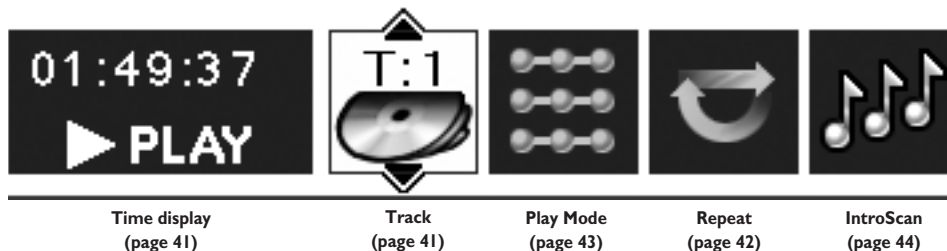

This is the Info Display you'll see when you're playing an audio CD.

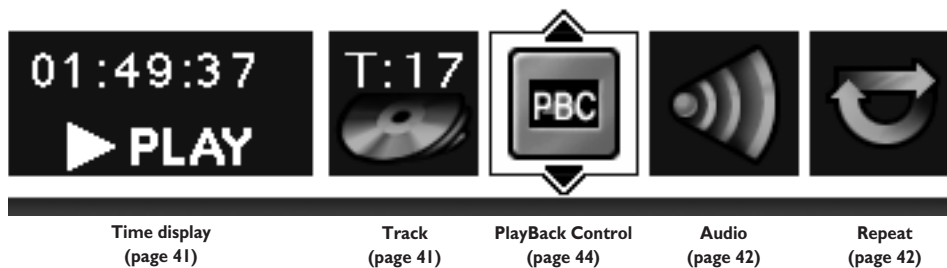

This is the Info Display you'll see when you're playing a Video CD, also called a VCD.



DVD+R and DVD+RW Info Display... go to page 32.

VCR Info Display... go to page 35.

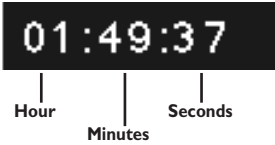

Time Display (DVD, Video CD, and Audio CD)

This feature displays the time that has elapsed during playback. For DVD discs, the time displayed refers to the current title and acts as a Time Search feature. For example, if you like a particular scene in a movie, you can enter the elapsed time the scene plays and skip right to it.

1. Highlight the Time Display and use the number buttons on the remote to enter the elapsed time you want to go to in that title. You must use two digits for each field. For example, if you enter 01:35:12, playback will start one hour, 35 minutes, and 12 seconds into the title.

Notes:

For Audio CDs, the time displayed refers to the track that's playing.

Some portions of a disc might prohibit searching or scanning, such as warnings or opening credits.



Selecting a Title on DVDs or a Track on Audio CDs or Video CDs

Some discs contain more than one title. For example, there might be four movies on one disc (each movie might be considered a title). Each title is divided into chapters.

To select a title via the Info Display, highlight the Title icon with the right arrow button on the remote control. Press the up or down arrow button to go to the next title: When you're playing a VCD or an Audio CD, use these instructions to go to a different Track.

Notes:

You can also use the number buttons on the remote to enter the title/track number.

Many disks only have one title.



Chapter Icon (DVD)

Because DVD discs use digital technology, a title can be divided into individual chapters (similar to tracks on a CD). You can skip to a specific chapter by using the Chapter feature in the Info Display.

1. While a disc is playing, press INFO on the remote (the Info Display appears).
2. Press the right arrow button until the chapter icon is highlighted.
3. Press the up and/or down arrow buttons to go to different chapters.

Notes:

You can also use the number button(s) on the remote to enter the chapter you want to play—you may need to enter 2 digits, depending on the number of chapter there are on the disc (for example, if there are 14 chapters, to go to chapter 4, press 0 and then press 4). The movie starts playing at the beginning of the chapter you entered.

The Chapter feature won't work if the disc isn't formatted with separate chapters.

When you're recording onto DVD+R and DVD+RW discs, a chapter mark is added automatically every 5 minutes of recording.

Shortcut

While you're playing a disc, you can use the CH +/ CH- buttons to go to the next chapter or previous chapter.



Subtitle Icon (DVD)

To change the subtitle language, highlight the subtitle icon and press the up or down arrow buttons to scroll through the choices (the subtitle language options appear in the box at the bottom of the Info Display).

Notes:

Changing the subtitle language with the Info Display will only affect the disc you are currently playing. When the disc is removed or the player is turned off, the subtitle language will revert to the language setting specified through the DVD/VCR's Language menu.

If the disc doesn't contain the language you want to use, the disc's default language is automatically selected.

Some discs are programmed to only allow you to access the subtitle feature through the disc's menu. If changing subtitle language via the Info Display doesn't work (as described above), press MENU and change the subtitle language via the disc's menu.



Repeat Icon (DVD, Video CD, and Audio CD)

By default, the Repeat feature is Off. There are three Repeat options:

- Title – repeats the title that is playing
- Disc – repeats the disc that is playing
- A-B – repeats a segment of the disc that you select.

For DVD discs and VCDs, play modes are also available from the Repeat Icon:

DVD and VCDs: Play mode standard plays the discs chapters in the order they were placed on the disc.

DVD: Play mode playlist plays a playlist you create in the menu system (page 48).

Repeating Titles, Chapters, or Tracks

1. While a disc is playing, press INFO (the Info Display appears).
2. Press the right arrow button until the Repeat icon is highlighted.
3. Press the up or down arrow button to scroll through the different Repeat options—*Repeat title*, *Repeat disc*, *Repeat AB*, and *Repeat Standard* (the modes appear at the bottom of the Info Display).
4. To turn off the Repeat feature, press the up or down arrow button repeatedly until *Play Mode: Standard* appears.

AB Repeat

AB Repeat lets you define a specific segment on the disc that you want to repeat. For example, you might want to watch a specific scene from a movie repeatedly:

1. Follow steps 1 and 2 above.
2. Press the up (or down) arrow button until “*Repeat Mode: AB. Press OK to set A point*” appears at the bottom of the Info Display. Press OK when the disc gets to the beginning point of the segment (the A point) that you want to repeat.
3. Go to the end of the segment you want to repeat. Press OK to set the B point (the segment you marked will play repeatedly until you turn off the Repeat feature).
4. To turn off the Repeat feature, highlight the Repeat icon, and press the up arrow button on the remote until *Play Mode: Standard* appears at the bottom of the Info Display.



Audio Icon (DVD and Video CD)

If the disc was created with different language tracks (recorded in different languages) or different audio formats (Dolby, DTS, stereo, etc.), you can change the audio option while you're playing the disc.

1. While a disc is playing, press INFO (the info display appears).
2. Press the right arrow button until the Audio icon is highlighted.
3. Press the down arrow button on the remote to scroll through the available audio options.
4. When the option you want to use is highlighted, press the OK button.

Notes:

The language feature only works if the disc was created with multiple language tracks. If the disc doesn't contain the language you selected, the disc will play in the default language.

When you choose an audio language during disc playback, you only override the audio language setting in the DVD/VCR's Language menu temporarily.

Some discs are programmed to only allow the audio setting to be changed via the disc's menu. If changing audio option via the Info Display doesn't work (as described above), press MENU and change the audio setting via the disc's menu.



Camera Angle Icon (DVD)

Some discs contain multiple angles of a particular scene or sequence. If the disc only has one angle, this feature won't work. Currently, very few discs have this feature.

1. While a disc is playing, press ANGLE on the remote. If the disc wasn't created with multiple angles, the invalid symbol appears. If the disc contains multiple angles, the Angle icon appears with the current angle number and the number of angles available. For example, 1 of 4 indicates that Angle 1 is displayed and there are 4 different angles available.
2. Press the up arrow button to go to the second camera angle. Press the arrow button again to go to the third angle, etc.
3. To resume normal playback, scroll through the camera angles until you get to the original angle.

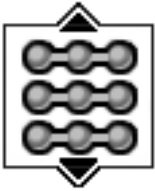

Play Mode Icon (Audio CD)

When you play audio CDs, the various Play Modes are available from the Info Display. The Play Mode feature lets you set up the order in which you want the tracks on the CD to play. There are three Play Modes:

Standard: the tracks play in the same order as listed on the CD (starting with track 1). This is the default play mode.

Random: the tracks on the CD play in a random order.

Program: the tracks play in the order you designate. To use the Program play mode, you must set up the order in which you want the tracks to play in the DVD/VCR's main menu system (go to page 48 for instructions).

Random

The Random option plays the tracks in a random order.

1. While you're playing a disc, press INFO (the Info Display appears).
2. Press the left or right arrow button to highlight the Play Mode icon.
3. Press the down arrow button until *Play Mode: Random* appears in the text at the bottom of the Info Display (the tracks start playing in random order).

To switch back to Standard Playback, follow steps 1 through 3 above until *Play Mode: Standard* appears underneath the Info Display icons.

Note: The player defaults to Standard Playback whenever you put a new CD into the DVD/VCR.

Program

The Program Play Mode is only available after you set up a playlist via the DVD/VCR's Disc menu (page 48).



IntroScan Icon (Audio CD)

Use the IntroScan feature to preview each track on the CD.

1. While the CD is playing, press INFO (the Info Display appears).
2. Use the arrow buttons to highlight the IntroScan icon.
3. Press OK (the first 20 seconds of each track starts playing).



Playback Control (PBC) Icon (Video CD)

Use the arrow buttons to highlight the Playback Control icon. Press the up or down arrow button to go back and forth between On and Off. How Playback Control (PBC) works varies for different Video CDs. With most Video CDs, turning on Playback Control enables you to access the Video CD's menu if it has one and requires that you navigate through the Video CD's contents by using the Video CD menu instead of the DVD/VCR's Info Display. When PBC is on, you won't be able to use any repeat modes or skip titles in the DVD/VCR's Info Display.

Playing Discs You Recorded (DVD+R and DVD+RW)

Playback of DVD+R and DVD+RW discs that you used to record programs is explained in Chapter 3 (go to page 32).

Playing mp3 or JPEG files

Your DVD/VCR can play mp3 files and JPEG files. You can also create a musical slide show by putting both mp3 (MPEG-1, layer 3) and JPEG files on the same disc.

mp3 is an audio file format which compresses recorded music. It was developed by Fraunhofer Gesellschaft in collaboration with Thomson Inc. The main advantage of the mp3 format is the ability to store CD-quality music tracks that are user-friendly and compressed on a personal computer. mp3 (MPEG-3, which stands for Motion Picture Experts Group-Layer 3, meaning the third layer of information) is a format used to compress digital audio. Since the audio is compressed, it takes up less space.

Note: You can only play true mp3 files in the DVD/VCR—some products use software to compress mp3 files and convert them to other formats such as MPX. Your DVD/VCR won't recognize or play MPX files or other types of converted mp3 files.

JPEG files are image files. Make sure that they have a resolution of less than 5 megapixels (approximately 2MB).

Note: The time taken for the contents of the disc to be displayed varies according to the size and number of JPEG files actually on the disc. If nothing is displayed after a few minutes, it is likely that certain files are too large. In this case, reduce the files' resolution to less than 5 megapixels (approximately 2MB) and write another disc.

Creating an mp3 Disc on Your Computer

Your DVD/VCR handles MPEG-1, layer 3 audio. If you encode your own mp3 files from an audio CD, avoid using the features of MPEG-2, such as the 22kHz sampling frequency.

Be sure to make a data CD rather than an audio CD. If you make an audio CD, you will lose the extra features and compression of the mp3 format.

Notes:

Some transport modes (reverse and fast forward) are not available for mp3 CDs.

When burning multisession CDs, make sure you close the last session.

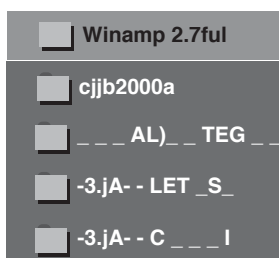

Example of folder list.

1. Place the disc in the disc tray with the printed side facing up.
2. If the *AutoPlay* option in the *Play Mode* menu is enabled (see page 49), the disc's contents are displayed, otherwise press the PLAY button to display them.
3. Select a folder using the ▲ and ▼ buttons on the remote control, then press OK to display the list of files or press PLAY to start playing all the files contained in the folder.



Example of mp3 files.



Example of JPEG files.

- Select a file using the ▲ and ▼ buttons, press OK (the playback options appear). Use the ▲ and ▼ buttons to scroll through the options and press OK when desired option appears.
 - mp3 file: if you press play when a file is highlighted (and you selected *Play All*), the player begins by playing the selected file, then all the files and subfolders contained in the same folder. The player then plays the contents of the folders at the same level as the folder containing the file selected at the start. If you chose *Standard Play*, playback will stop after all of the files in the current folder (and its subfolders) have played.

Notes:

While listening you can use the ◀ or ▶ button to go back to the previous track or go to the next one, and press the MENU button to display the disc's contents.

Some file names are too long to be completely displayed.

- JPEG file: the player starts the slide show with the JPEG file you have selected and proceeds to display all the JPEG files in the same folder, then all the JPEG files in the subfolders located in the same folder.

Note: During the slide show you can use the ANGLE button to rotate the picture 90°, the ZOOM button to magnify the picture, the ◀ or ▶ buttons to go back to the previous picture or go on to the next one, the FORWARD and REVERSE buttons to change the speed of the slide show (the speed selection varies depending upon the size of the JPEG files), and the MENU button to interrupt the slide show and display the disc's contents.

- When the player has played all the files, the disc's contents appear.
- Press STOP to end playback.

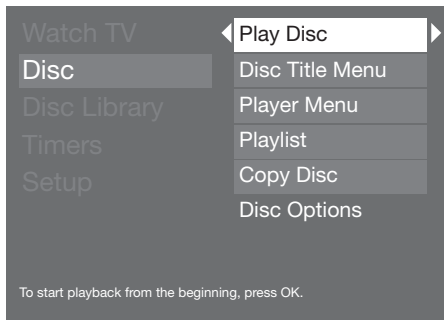

Musical Slide Show: Playing JPEG and mp3 files at the same time

The way the JPEG files and mp3 files are displayed when you put the CD-R disc in the DVD/VCR, varies depending upon how you set up the files and folders when you created the CD. The musical slide show enables you to display JPEG files while listening to mp3 music files that are on the same disc.

If you want to control the order in which the mp3 music files play, you need to set up a playlist by going to the *Disc* menu and choosing *Playlist* and enter the individual mp3 files in the order you want to play them. Then, you choose *Play Disc* and choose *Both* from the submenu. When the JPEG list appears, select the picture you want to use as the first slideshow picture. When playback starts, the mp3 playlist will start playing automatically in the order you designated as the JPEG files are displayed.

The order the mp3 files and JPEG files play in the Musical Slide Show as described in the instructions that follow are designated by the order the files were placed on the disc.

- Insert the disc that has the mp3 and jpeg files on it into the DVD/VCR disc tray.
- Close the disc tray (press OPEN/CLOSE).
- After the DVD/VCR reads the disc, highlight the *Disc* menu and press OK.
- Since *Play Disc* is highlighted, just press OK.
- Press the arrow down button on the remote to highlight *Both*, and press OK.
- Select the mp3 folder and the JPEG folder.
- To try different options, press the right arrow button to highlight *Standard Play*. Use the up/down arrow buttons to scroll through the choices available.

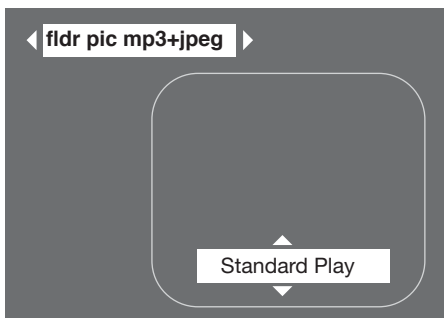
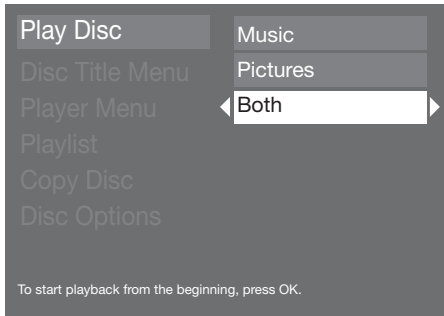

Chapter 5

Menu System

- Overview of the DVD/VCR's Menu System
- Watch TV Menu
- Disc Menu
- Tape Menu
- Disc Library Menu
- Timer Menu
- Setup Menu

Graphics contained within this User's Guide are for representation only. Some of the menu screens, buttons, and display messages might be different in your product than they appear in this book. The on-screen help text provides the most current operational information.

Overview of the DVD/VCR's Menu System

Since this product has many features, it has a wealth of menus and options. To access the main menu during playback, press the STOP button on the remote. To access the main menu when you're not playing a disc or tape, press the MENU button.

How to navigate through on-screen menus

Throughout the DVD/VCR's menu system, you'll see arrows on the on-screen menu bars. These arrows indicate you can use the correlating arrow buttons on the remote control to navigate to different menus and access choices. When a menu item is highlighted, press OK to select the menu.

If you see the left arrow button, you can press the left arrow button on the remote control to return to the previous menu. Throughout the menu system, the GO BACK button takes you to the previous menu.

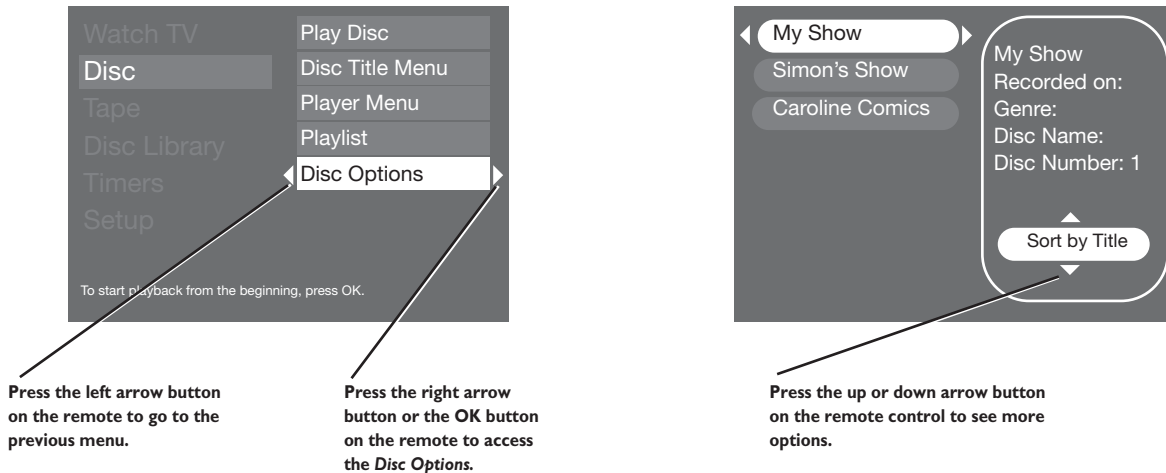

The Main Menu

The main menu is divided into the following submenus:

Watch TV – shows current channel number or input.

Disc – plays a disc, accesses the disc title menu, enables you to copy a disc to tape, enables you to create a customized playlist (audio CDs and DVDs), selects the screen format for DVDs, and accesses title menus and disc menus for DVDs. Go to page 48 for details.

Tape – provides options for VCR playback, such as AutoPlay; allows you to copy a tape to disc; allows you to select segments of the tape for editing. Go to page 49.

Disc Library – contains information about all programs you've recorded using this DVD/VCR. You can use the *Disc Library* as a search tool by sorting recorded programs. As much information as possible is stored automatically. The information is stored in the DVD/VCR's memory and has storage limits. You may need to delete some library contents in the future to make room for new recordings. For detailed information about the *Disc Library*, go to page 31.

Timers – set up timer recordings and view the list of existing timer recordings. Go to page 50 for general information about this menu. For instructions to set up a timer, go to Chapter 3 (page 30).

Setup – accesses all of the menus from the Interactive Setup (the menu you went through the first time you turned on the product); parental controls (rating limits); record quality settings; language options for on-screen menus and discs; and advanced settings for audio and component video. Go to page 50 for more information.



Watch TV

The *Watch TV* menu shows the current channel or input. To watch TV, press OK when the *Watch TV* menu is highlighted (the channel banner appears to show you available program information, such as channel, name, and time). For more information, go to page 28.

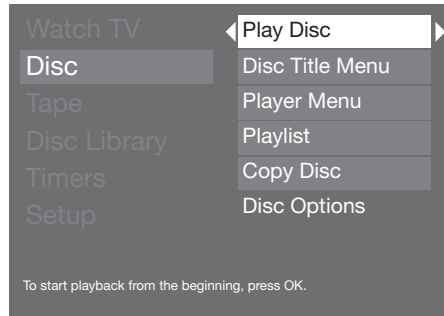

Disc

You can only access the disc menu when you've inserted a compatible disc into the DVD/VCR. The submenus follow:

Play Disc: starts playing the disc.

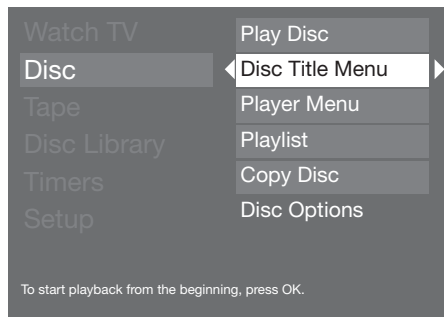

Disc Title Menu: available only when you've inserted a DVD+R or DVD+RW disc that you've recorded in this DVD/VCR. With *Disc Title* highlighted, press OK to access the disc's title menu (the disc name appears on the top and each recording is listed below the disc name). **For details about the Disc Title Menu, go to Chapter 3 (page 32).**

If you press OK when the disc name is highlighted, the following choices appear:

Rename Disc: Press OK when highlighted (the on-screen keyboard appears). Follow the on-screen instructions to give the disc a different name. Highlight *Done* when you're finished, and press OK. You cannot select the disc name for a finalized DVD+R disc.

Erase Disc: Erases a DVD+RW disc so you can record new programming onto it. Not available for DVD+R disc.

Lock Disc: Protects contents of the DVD so nobody can record new programming onto it. If the disc is locked, this option changes to unlock. This option isn't available for DVD+R discs.

Finalize Disc: Only appears if you have a DVD+R disc in the DVD/VCR. In order for a DVD+R disc to be played in other DVD player, you must finalize it.

Make Compatible: DVD+RW discs only. If you have made edits to the disc, such as adding or deleting chapter markers or hiding chapters, this option enables the edited version of the disc to be compatible with other DVD players.

If you press OK when one of the recordings (titles) is highlighted, the following choices appear: Rename title; Play title; Play full title; Delete title; and Clear chapters.

Player Menu: shows you how a DVD+R or DVD+RW disc's menu will appear in other DVD Players. A small still-frame from each title you record (program, show, movie) appears as a thumbnail image. Use the DVD player's left and right arrow buttons to highlight a thumbnail so you can play the recording. If you have multiple recordings and want to get back to the beginning quickly, highlight *Go to page 1* (if available on the screen) and press OK.

Note: Not all DVD players are able to play DVD+R and DVD+RW discs. Check the DVD player's owner's manual.

Playlist: (available for Audio CDs and DVDs): You can create a customized playlist just like you can with many CD players where you rearrange the order in which the songs play. The playlist is played via the Program Play option in the Info Display (page 43). When you want to copy a single title from a DVD+R or DVD+RW disc to a tape, you can set up a playlist for the disc with only the title you want to copy. To set up a playlist, follow the onscreen instructions.

Copy Disc: Simultaneously starts playing disc and recording the disc to tape in the VCR. Note: If you've created a playlist on the disc, only the playlist will be recorded. To copy the entire disc, you would have to delete the playlist from the disc before you choose *Copy Disc*.

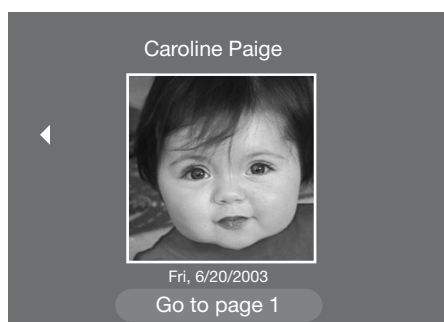

The DVD/VCR's *Player Menu* shows how a DVD+R or DVD+RW disc menu will appear in another DVD player.

Note: not all DVD players support DVD+R and DVD+RW discs.

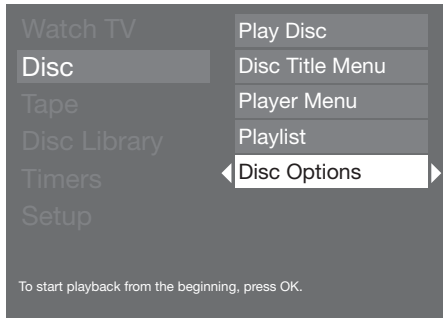

Disc Options

AutoPlay: When you select *On*, a pre-recorded DVD disc immediately starts playing after you insert it into the player (there's no need to press the PLAY button). With AutoPlay *On*, recordable discs (DVD+R or DVD+RW) with content recorded on them will automatically display contents.

Note: For CDs with mp3 or JPEG files on them, instead of playing automatically, the contents of the CD (the files and/or folders) appear automatically.

Screen format: the setting you choose adjusts the way a movie appears on your TV (DVD discs only). Standard TVs are 4 x 3 format. Depending on the type of television you have, you may want to adjust the screen setting (also called the aspect ratio). The choices follow:



4 x 3 Letterbox



4 x 3 Standard



16 x 9

4 x 3 Letterbox – Choose this setting if you want to see movies in their original aspect ratio (height-to-width ratio). You'll see the entire frame of the movie, but it will take up a smaller portion of the screen vertically. The movie might appear with black bars at the top and bottom of the screen.

4 x 3 Standard – Choose this setting if you want the movie to fill the entire screen of your TV. This might mean that parts of the picture (the left and right edges) won't be seen. Most discs that are produced in a widescreenonly format can't be cropped in this fashion.

16 x 9 – Choose this setting if your DVD/VCR is connected to a widescreen TV. If you choose this setting and you don't have a widescreen TV, the images on the screen might appear distorted due to vertical compression. If you play a disc recorded in 4 x 3 format on a widescreen TV, the left and right sides of the screen will appear black.

Angle Icon: Some DVDs are produced with multiple camera angles. However, it is difficult to know when the angle feature is available throughout a movie. If you turn on the Angle Display, an icon will appear on the screen whenever multiple angles are available for a particular scene in a movie.

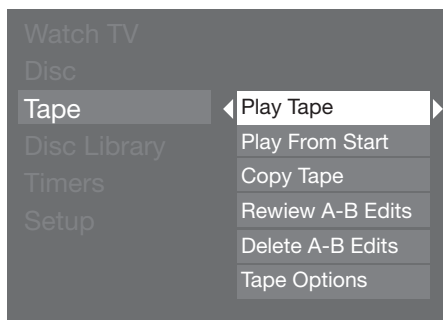

Tape

Play Tape: starts playing the tape.

Play from Start: Rewinds the tape to the beginning and starts playback.

Copy Tape: Allows you to copy the contents of a tape to a DVD+R or DVD+RW disc. The copy will begin from the current position on the tape to the end of the tape.

Note: Tapes (movies) that have been encoded with copy-protection cannot be copied to disc.

Review A-B Edits: Allows you to review A-B Edit segments you created using the VCR Info Display (see page 35 for more information). Also allows you to play A-B Edit segments.

Delete A-B Edits: Allows you to delete A-B Edit segments.

Tape Options:

Tape AutoPlay: When you select *On*, the tape starts playing automatically after you insert it into VCR (there's no need to press the PLAY button).

Playback Mode: Gives you two options for VCR playback:

Digital – Sends the VCR content through the digital part of the DVD/VCR, which enables you to use the VCR InfoDisplay during playback (for more information, go to page 35).

Analog – Choose *Analog* if you want to play a tape and view the picture in true analog format without going through the digital encode and decode process, which is applied through the digital path. In the Analog mode, you will not be able to see the on-screen Info Display described on page 35.

AutoRewind: When you select *On*, the tape automatically starts rewinding as soon as you reach the end of the tape.

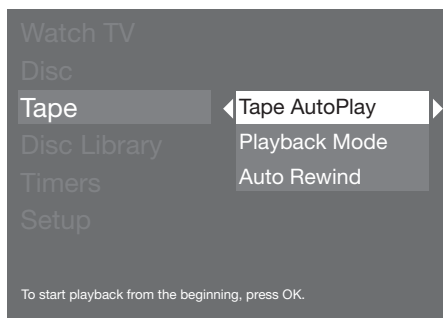

Disc Library

The disc library accesses information about what you've recorded onto discs. Details of this feature and the submenus are described on page 31.

Timers

Timer: You can add timers and view or edit existing timers from this menu for automatic recording. Timer recordings are especially useful when you have a favorite program that you want to record every week and/or every day. If you use a cable box, the cable box must be On and tuned to the channel you want to record, during the timer recording; if you're recording from satellite, the satellite set-top box, also called a receiver, must be On and tuned to the channel you want to record. For details about setting up a timer, go to page 30.

Setup

The Setup menu contains many submenus that are explained on the following pages. Follow the instructions at the bottom of the screen.

Note: To return to a previous menu, press the left arrow button or GO BACK.

Parental Controls

You can set up ratings limits and turn on the Parental Control feature in order to control the type of discs people can play in the DVD/VCR. The padlock icon on the Lock menu indicates whether the player is locked or unlocked.

 **Locked:** You need to enter the password in order to play discs that have a higher rating than what you've allowed. When the player is locked, nobody can access the Lock menu without entering the password.

 **Unlocked:** No password required to play discs. Even if you've set ratings limits, they won't be enforced when the player is unlocked.

Notes:

The player is shipped unlocked without any rating limits set. If you want to use the Parental Control feature, set Ratings Limits and then lock the player.

Don't confuse the DVD/VCR's Parental Control feature with a parental control feature that may be in your TV, often referred to as V-Chip. The ratings described here refer to discs that you play in the recorder, not TV programs.

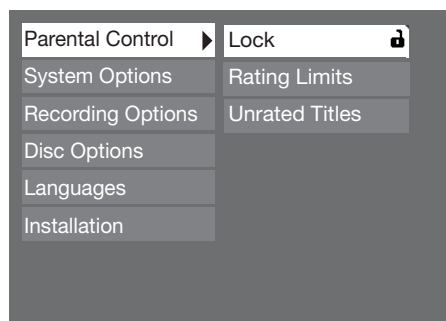

Lock (and Unlock)

1. From the DVD/VCR's main menu, select *Setup* and press OK (the *Setup* menu items appear).
2. Since *Parental Control* is highlighted, just press the OK button (the *Parental Control* menu items appear).
3. Since *Lock* is highlighted, just press the OK button on the remote.
4. If prompted to enter a password, use the number buttons on the remote control and press OK (*Confirm Password* appears). Enter the same numbers you entered before and press OK.
5. To return to the previous menu, press the left arrow button.

Once the player is locked, you'll need to enter the password everytime you access the *Parental Controls* menu.

Note: The player is shipped without any rating limits set. You need to set Ratings Limits (go to page 50 for instructions) in order for the player to prevent people from playing discs with certain ratings.

Rating Limits

The *Rating Limits* menu lets you determine what types of discs can be played in the player, and what types of discs will require a password to override the rating limit that you've set. In the U.S., the ratings feature is based on the ratings set up by the MPAA (Motion Pictures Association of America) such as R, PG, G, etc.

The system ranks the ratings from 1 to 8 in order to accommodate ratings systems used in other countries (1 is considered material that is least offensive and 8 is considered the most offensive).

Note: In order for the Ratings to be enforced, the DVD/VCR must be locked and the disc you're playing must contain a movie (or a title) that is rated.

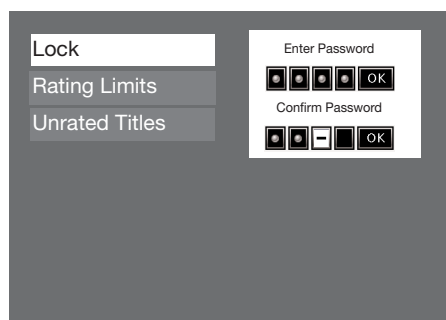

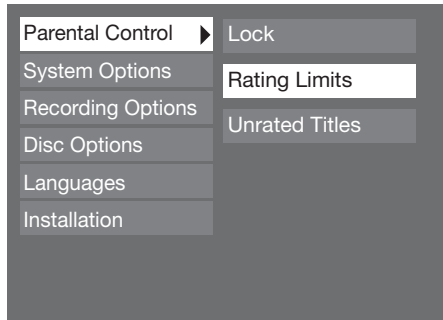

To set Ratings:

1. From the DVD/VCR's main menu, select *Setup* and press OK (the *Setup* menu items appear).
2. Since *Parental Control* is already highlighted, just press OK (the *Parental Control* menu items appear).
3. Highlight *Rating Limits* and press OK (the 8-level rating list appears).

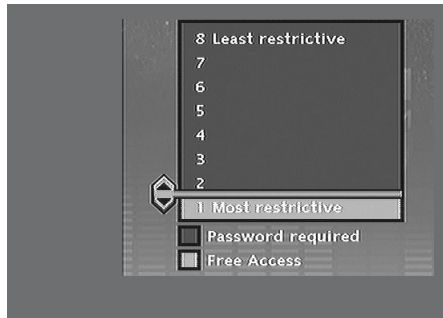

4. Use the up and down arrow buttons to move the bar to the rating level you find acceptable.
Ratings that don't require a password (free access) appear under the bar.
Ratings that require a password appear above the bar.
5. Press OK.

Note: You must lock the player (page 50) in order for the ratings to be enforced.

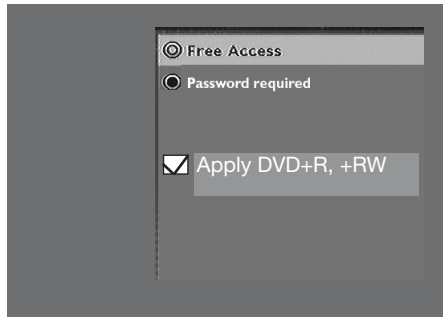

Unrated Titles

Some discs contain titles (or movies) that don't have a rating assigned to them. Sometimes, movies you might find the most explicit are unrated. However, much of the new programming on discs, such as interviews with actors and directors, is also unrated. Additionally, the discs you use to record (DVD+R and DVD+RW) are considered unrated.

In order to prevent unrated titles from being played, you need to choose *Password Required* from the *Unrated Titles* menu, and lock the player.

If you want this setting to apply to discs you recorded (DVD+R and DVD+RW discs), simply highlight the check box next to *Apply DVD+R, +RW* and press OK.

System Options:

Contains settings and menus for audio features, as well as black level settings and dimmer options for the front display of your DVD/VCR.

Digital Output: If you connected your DVD/VCR to a receiver via the DIGITAL AUDIO OUT jack on the back of the player, choose the type of receiver (or decoder) you have: Dolby Digital or DTS.

Note: If you select **DTS**, and you don't have a **DTS** receiver connected to the DVD/VCR you won't hear any audio or the audio will be distorted.

SRS/TruSurround: The TruSurround® feature simulates a six-speaker listening experience through just two speakers. The default setting is *Off*. To turn on the Virtual Surround® feature highlight *SRS/TruSurround*, and press OK. Highlight *On* and press the OK button.

Black Level: Adjusts how bright the picture appears. Choose between *Dark* and *Light*. Use the arrow buttons to highlight a choice and press the OK button to select the choice that's highlighted.

Dimmer: Adjusts the brightness of the display on the front of the DVD/VCR. Use the arrow buttons to highlight a setting, and the OK button to select the option that's highlighted. The choices follow: *Automatic* (the display automatically dims during playback); *Bright*; *Dim*.

Audio Broadcast: Default setting for type of audio recorded and played. Choices are Stereo, Mono, SAP (Second Audio Program).

AutoClock: Keeps the DVD/VCR's time current by downloading time from broadcast signal. If the DVD/VCR's clock is out of sync and AutoClock is on, try turning off AutoClock and set the time manually via the Clock Setup menu (page 53).

TruSurround  is a trademark of SRS Labs, Inc. TruSurround technology is incorporated under license agreement from SRS Labs, Inc.

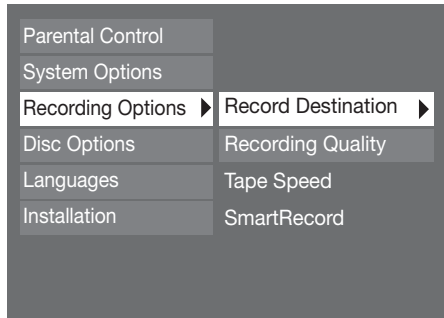

Recording Options:

Record Destination: Choose whether you want to record to a disc (DVD) or a tape (VCR).

Recording Quality: The better the quality, the more memory (space) the recording will use on the DVD+R or DVD+RW disc or tape. The choices for a disc are:

1	Best	1 hour recording time on an empty 4.7 GB disc
2	High	2 hours recording time on an empty 4.7 GB disc
3	Good	3 hours recording time on an empty 4.7 GB disc
4	Normal	4 hours recording time on an empty 4.7 GB disc
5	Basic	6 hours recording time on an empty 4.7 GB disc
6	Low	8 hours recording time on an empty 4.7 GB disc

Tape Speed: Choose between SP (Standard Play) or SLP (Super Long Play) setting for recording on tape.

SmartRecord: Used with Timer Recordings to ensure you have enough space on a DVD+R or DVD+RW disc to record the program. When SmartRecord is on, the DVD/VCR automatically detects how much recording time is left on the disc and adjusts the Recording Quality automatically if necessary. Does not apply for VCR recordings to tape.

Disc Options:

Takes you to Disc Menu options—Autoplay, Screen Format, and Angle Icon. Go to page 49 for more information.

Tape Options:

Takes you to Tape Menu options—Autoplay, Playback Mode, and AutoRewind. Go to page 49 for more information.

Languages:

Display: the language that appears when you access this menu the first time reflects the option you chose during the interactive setup. To change the language of the onscreen displays (menus), use the arrow buttons to highlight a language and press OK to select it.

Audio: the language that appears when you access this menu the first time reflects the option you chose during the interactive setup. You can change the audio language by highlighting an option and pressing the OK button. The language selected will only apply when it is available on the disc.

Subtitles: Some movies on DVD discs have subtitles. Set up your default settings in this menu. You can quickly override these settings while playing a disc by using the Info Display (go to page 41 for information).

Automatic: If the language you selected in the interactive setup isn't available for the title you're playing, but subtitles are available in that language—the subtitles for that language will appear automatically during playback.

Off: subtitles won't appear on the screen.

On: if the title (movie) has subtitles available, they will appear automatically.

Original: subtitle language will match the original audio (dialogue) language of the title (movie).

Disc Menu: Many discs have their own menu that appears on the screen. You can select the language in which you want the disc menu displayed. In order for your setting to take effect, the disc's menu must have been created with the corresponding language option.

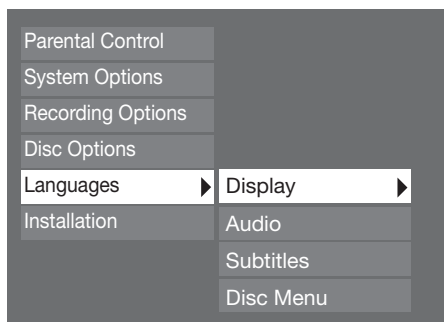

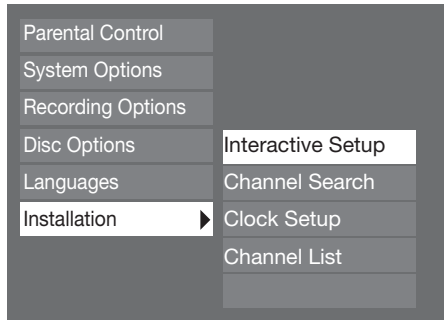

Installation:

The submenus contained in the Installation menu pertain to the type of signal that is connected to your DVD/VCR (cable or off-air antenna). If you move, or change any of the information you entered when you first set up your DVD/VCR, you need to change the information in the following menus.

Interactive Setup: The first time you turned on your DVD/VCR, you had to complete an interactive setup so your DVD/VCR could have the information it needs to function properly. For details about the Interactive Setup, go to page 13. To go through this procedure again to change settings, highlight *Interactive Setup* and press the OK button.

Channel Search: If you've changed program providers (cable and/or satellite), the Channel Search will automatically search the signal and put the latest channels in the DVD/VCR's channel list. Use the arrow buttons to highlight *Channel Search*, and press OK to begin (a progress indicator appears to let you know how quickly the search is being completed).

Clock Setup: If the clock is incorrectly set or you skipped this step during the interactive setup, you can set the DVD/VCR's clock using the number buttons on the remote and the arrow buttons to navigate. Follow the on-screen instructions.

Note: In order for Timer Recordings to work, you must set the clock to the correct time and date.

Channel List: Enables you to change what channels are accessed when you press the DVD Recorder's channel up and down buttons (if you delete a channel from the channel list, you can still access it by using the number buttons on the remote). For more explanation, go to page 16.

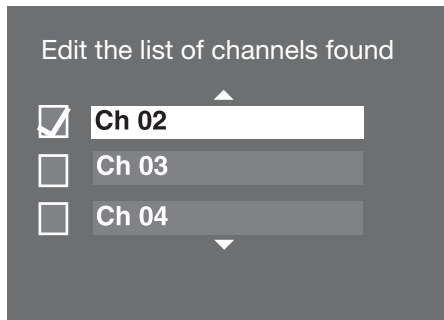
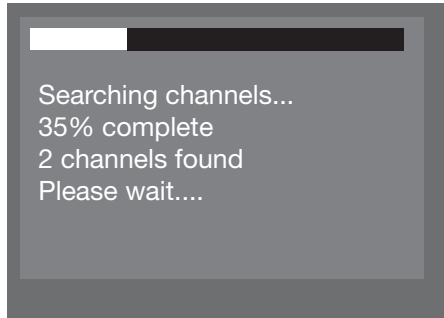

Chapter 6

Additional Information

- **Troubleshooting**
- **Handling Cautions**
- **Maintenance of Cabinet**
- **Limited Warranty**
- **Accessory Information**

Graphics contained within this User's Guide are for representation only. Some of the menu screens, buttons, and display messages might be different in your product than they appear in this book. The on-screen help text provides the most current operational information.

Troubleshooting

General Problems

Player won't work (locks up)

- Try unplugging the AC power cord and plugging it back in.
- Reset the DVD/VCR: on the front of the unit, press and hold the STANDBY/ON button while you press and hold the STOP button—wait at least 3 seconds before you release both of the buttons. You'll need to set up your menu preferences because this Reset Procedure returns the DVD/VCR's menus to the factory default settings and also erases the contents of the Disc Library.

No power

- Plug in the DVD/VCR. Make sure both ends of the AC power cord are securely plugged into the Recorder and into an AC outlet.
- Make sure you've plugged it into a working outlet and/or a power strip that is turned on.
- Don't plug the unit into an outlet that is operated by a wall switch.

No picture

- Turn on the TV.
- Tune your TV to the Video Input Channel that corresponds to the jacks you used to connect the TV to the DVD/VCR (go to page 18 for more help).
- Check the PROG SCAN switch on the back of the unit to make sure it is in the OFF position. Try playing the disc again.
- Make sure your DVD/VCR is connected properly.
- If you connected a satellite receiver or a cable box, make sure it is turned on.
- Press the ANTENNA button.

A screen saver appears on the TV

- Your player is equipped with a screen saver that appears on the TV after your player has been idle for several minutes. To make it disappear, press STOP or CLEAR on the remote.

The menu is displayed in a foreign language

- The *Language* menu (*Display* menu) is set to that language. Go to the *Setup* menu and choose *Languages* (in Spanish, shown as *Idiomas*; in French, as *Langues*), choose the *Display* option. Highlight the language you prefer, and press OK.

I forgot my password

- Press the STOP button on the front of the unit while you press the STOP button on the remote control—keep pressing both buttons for approximately 3 seconds (until the  icon disappears from the front panel display). Release both buttons (the player should be unlocked). If that doesn't work, try resetting the DVD/VCR (instructions are listed below).
- Reset the DVD/VCR: on the front of the unit, press and hold the STANDBY/ON button while you press and hold the STOP button—wait at least 3 seconds before you release both of the buttons. You'll need to set up your menu preferences because this Reset Procedure returns the DVD/VCR's menus to the factory default settings and also erases the disc library.

The time (clock) is wrong

Go to the *System Options* menu and select *AutoClock*. Set it to off and then set the time manually via the *Clock Setup* menu, which is found in the *Installation* menu.

DVD Problems

Disc won't eject

- When you put a disc into the player, the player may take up to 15 seconds to read the disc. You won't be able to eject the disc during this time. Wait 15 seconds and try again.
- Maybe the Tray Lock feature has been activated. To unlock the disc tray, press and hold the STOP button on the front of the unit and then press and hold the OPEN/CLOSE button on the front of the unit at the same time—wait 3 seconds before releasing both buttons.

Disc tray won't open

- Maybe the Tray Lock feature has been activated. To unlock the disc tray, press and hold the STOP button on the front of the unit and then press and hold the OPEN/CLOSE button on the front of the unit at the same time—wait 3 seconds before releasing both buttons.

Disc won't play

- Many problems encountered when playing (or recording) a disc are related to the wide variation in disc quality due to the large number of brands and manufacturers. We highly recommend using discs from a reputable manufacturer. If you encounter problems with one brand, please try another brand.
- Insert a disc with the label side facing up.
- Check the type of disc you put into the player. This player only plays DVD video discs, Video CDs, audio CDs, and CDs with true mp3 files and/or JPEG files. mp3 files that have been converted to MPX files (or similar types of files) won't be recognized by your DVD/VCR.
- Both the DVD/VCR and the disc are coded by region. If the regional codes don't match, the disc cannot be played. This player is Region No. 1. Region coding isn't applicable to discs you use to record (DVD+R and DVD+RW).
- Press STOP (the main menu appears). Check the PROG SCAN switch on the back of the unit to make sure it is in the OFF position. Try playing the disc again.
- If you've put both a DVD in the disc tray and a videotape in the VCR deck, select the Disc menu from the main menu and choose *Play Disc* (or press the PLAY button when the menu is highlighted).
- If you're playing a Multisession CD, you might not have closed the session before ejecting it from your computer. Close the session and try the disc again.
- If you're trying to play a DVD+R or DVD+RW disc you recorded in this DVD/VCR in another DVD player, the DVD player may not support DVD+R or DVD+RW discs. Also, if it is a DVD+R disc make sure you finalize it (p. 41).
- If you're trying to play a DVD-RW disc, it must have been recorded using the video mode (VM) and it must have been finalized.
- If it's a DVD+R or DVD+RW disc, check the setting in the *Parental Controls* menu. Go to *Unrated Titles*, and see if the box is checked next to *Apply to DVD+R and DVD+RW discs*. If there is a check in the box and you set *Unrated Titles* to *Password Required*, simply highlight the checkbox and press OK. Try to play the disc again.

Play starts, but then stops immediately

- The disc is dirty. Clean it.
- Condensation has formed in the DVD/VCR. Allow it to dry out.

The picture is distorted and/or fuzzy; or “jumps” during disc playback

- The disc might be damaged. Try another disc.
- It is normal for some distortion to appear during forward or reverse scan.
- The disc might be dirty. Clean it (go to page 58 for instructions).
- Some discs have defects that cause them to jump from one scene to the next.
- Turn the PROG SCAN switch on the back of the DVD/VCR to the “off” position. This switch should only be turned on if you’ve connected the DVD/VCR to a television that uses progressive scanning to display the image. Some, but not all High Definition Televisions (HDTVs) and multimedia monitors use progressive scan.
- If you have a progressive scan TV connected, a slight jumping of the signal is normal when you first play a DVD disc. A more detailed explanation follows:
If you have a progressive scan TV connected to the DVD/VCR via the COMPONENT jacks (Y, Pb, Pr) and turned on the PROG SCAN switch, the DVD/VCR automatically switches between progressive scan and regular interlace because progressive scan is only available when you play DVD discs. As the signal is converted from interlace to progressive (and vice versa), the Recorder resynchronizes the signal. Depending upon your TV, this resynchronization process might cause a slight “jump” in the picture when you start playing a DVD disc and again when you return to watching TV.

No sound or distorted sound

- Make sure your player is connected properly. Make sure all cables are securely inserted into the appropriate jacks.
- You may need to readjust the Digital Output setting (from the *System Options* menu). Go to page 51. If you select DTS, and your DVD/VCR isn’t connected to a DTS-capable receiver, you won’t hear any sound, or the sound will be distorted.
- Turn your TV to its Video Input Channel (go to page 18).
- Sound is muted when you’re using search features (fast forward, reverse, frame advance, etc.).
- If you connected an audio receiver to your DVD/VCR, make sure you chose the correct input setting on the receiver.

Can’t advance through a movie

- You can’t advance through the opening credits and warning information that appear at the beginning of movies because the disc is programmed to prohibit that action.

Subtitle and/or audio language is not the one selected from the initial setting

- If the subtitle and/or audio language does not exist on the disc, the disc’s priority language will be selected instead. Set the subtitle and/or audio language manually through the Info Display or the DVD/VCR’s menu system.

Play doesn’t begin

- The rating of the title on the disc exceeds the rating limit set in the Ratings Limits menu. Unlock the player and/or change the rating limit in those menus. Go to page 50 for more information.

No forward or reverse scan

- Some discs have sections that prohibit rapid scanning, or title and chapter skip.
- If you’re trying to skip through the warning information and credits at the beginning of a movie, you won’t be able to. This part of the movie is often programmed to prohibit skipping through it.

Desired angle cannot be changed

- Most discs don’t have the multi-camera angle system, and some discs only have multiple angles during certain parts of the movie.

Picture is too tall and thin

- Change the *Screen Format* in the menu system. Go to page 49 for more information.

Picture is too short and wide

- Change the *Screen Format* in the menu system. Go to page 49 for more information.

Disc I recorded won’t play in another DVD player

- If it’s a DVD+R disc, make sure you finalize the disc (p. 33).
- Some DVD players won’t play DVD+R and/or DVD+RW discs. Check the DVD player’s manual.

Recording/Copying Problems

Not enough space on the DVD+R or DVD+RW disc

- To get more recording time, you can change the Recording Quality setting (page 52). If it is a DVD+RW disc, you can delete some titles to create more space.

Won’t record

- You can’t record content that is copy-protected. If a message appears notifying you that you can’t record the material, press CLEAR on the remote to remove the message from the screen.
- Make sure you’ve inserted a DVD+R or DVD+RW disc.
- Make sure the disc isn’t locked, which protects contents of disc but prevents recording. Go to page 48 for more information.
- Many problems encountered when recording (or playing) disc are related to the wide variation in disc quality due to the large number of brands and manufacturers. We highly recommend using discs from a reputable manufacturer. If you encounter problems with one brand of disc, please try another brand.
- Press the DVD’s RECORD button on the front of the DVD/VCR. The remote control’s RECORD button activates recording on the part of the DVD/VCR selected in the Recording Options menu (Tape or Disc). You can change the selection (page 52).

mp3 files

The following recommendations can't be taken as a guarantee that the DVD/VCR will play mp3 recordings, or as an assurance of sound quality. Certain technologies and methods for mp3 file recording on CD-R discs prevent optimal playback of these files on your product.

- Make sure the file is a true mp3 file. You can only play true MP3 files in the DVD/VCR—some products use software to compress mp3 files and convert them to other formats such as MPX. Your DVD/VCR won't recognize or play MPX files or other types of converted mp3 files.
- When naming mp3 files, don't exceed 12 characters, and enter .mp3 as the file extension. When using a general name format of: Title.mp3, make sure the title is 8 characters or less, don't use spaces, and don't use special characters (such as =, +, /, %, &, etc.).
- Whatever the real recording capacity of the CD-R, don't use more than 630MB of recording space on the disc.
- Use a decompression transfer rate of at least 128 kb/sec (kilobits/second) when recording mp3 files. Sound quality with mp3 files basically depends on the rate of compression you choose. Getting audio CD quality sound requires an analog/digital sampling rate, that is conversion to mp3 format, of at least 128 kb/sec and up to 160 kb/sec. However, choosing higher rates like 192 kb/sec or more, only rarely give even better sound quality. Conversely, files with sampling rates below 128 kb/sec won't be played.

Can't get to DVD/VCR's main menu

- Press the STOP button until the main menu appears or press the left arrow button to return to the previous menu. If that doesn't work, remove the mp3 disc from the disc tray.

Can't make the Info Display appear

- The Info Display is only available when playing DVD discs, VCR tapes using the digital path, Audio CDs, Video CDs, and watching TV.

VCR Problems

No picture or snowy picture

- Turn on the TV.
- Check the PROG SCAN switch on the back of the unit to make sure it is in the OFF position.
- Make sure your DVD/VCR is connected properly.
- If you connected a satellite receiver or a cable box, make sure it is turned on.
- Some snow or streaks are normal during search, stop action, frame advance, and slow-motion playback.
- Adjust the tracking by pressing the CH+ and/or CH- buttons during playback.
- The tape may be worn out or poor quality.
- Press the ANTENNA button.

Tape won't play

- Make sure you turn on the TV, and tune it to the correct Video Input Channel.
- Try ejecting the tape and reinserting it.
- Make sure the tape is not broken.
- If the main menu appears when you press PLAY, you probably have both a DVD disc loaded in the disc tray and a tape in the VCR deck. You need to select *Tape* from the main menu to play it.
- Make sure the DVD/VCR is not in pause mode. Press PAUSE or PLAY to return to normal playback.

Time counter disappears during searching

- This is normal.
- Try ejecting the tape and reinserting it.

Tape won't record

- Make sure there is a recordable tape in the DVD/VCR.
- Make sure the tape's safety tab is intact.
- Press the VCR's RECORD button on the front of the DVD/VCR. The remote control's RECORD button activates recording on the part of the DVD/VCR selected in the Recording Options menu (Tape or Disc). You can change the selection (page 52).

Timer Recordings

- Make sure the time is correct. Your DVD/VCR is equipped with an automatic clock, but the feature might not work properly in some areas. If the time is inaccurate, set it manually by selecting the Setup menu; then Installation; and then Clock Setup.
- Make sure you set up the timer recording correctly—specifically, check the Destination field (you might have chosen Disc when you meant to choose Tape, or vice versa); check the AM/PM setting.
- If you're recording from a satellite receiver or cable box, make sure they are turned on when it is time for the recording to start. Also, if you used audio/video or S-Video cables to connect your satellite receiver or cable box to the DVD/VCR, tune the DVD/VCR to the corresponding Video Input Channel by pressing the INPUT button on the remote control. If you used a coaxial cable to connect your satellite receiver or cable box to the DVD/VCR, tune the DVD/VCR to the corresponding satellite / cable box channel (usually channel 2, 3, or 4). Remember, the DVD/VCR must be tuned to the appropriate input that matches how the satellite receiver or cable box is connected before you turn off the DVD/VCR.

Remote Control

Remote won't work

- You might be in the wrong mode. To operate your DVD/VCR, press the DVD/VCR button on the remote before you press any other buttons. If you're operating the TV, press the TV button first, etc. (this remote operates most RCA, GE, and Proscan TVs and satellite receivers, and you can program it to operate other brands of televisions).
- Insert new batteries in the remote.
- Operate the remote control at a distance of no more than 20 feet.
- Remove any obstacles between the remote and the DVD/VCR or other component. If your DVD/VCR is in an entertainment cabinet, the glass doors might obstruct the remote control from operating the DVD/VCR. Open the doors.

Can't program the remote

- The universal remote control that came with your DVD/VCR is already programmed to operate most RCA, GE, and Proscan components. You can program it to operate many other brands and models of TVs, cable boxes, digital satellite receivers, audio components, etc. However, the remote doesn't support all brands and all models so there is a possibility the remote can't be programmed to operate your component. Instructions for programming the remote control are on page 21.
- If you're trying to program the AUX button, you must use the Direct Entry method, NOT the Automatic Code Search method.

Lost the remote control

- To order a new remote control, go to page 60. The buttons on the front of the DVD/VCR operate the DVD/VCR's basic functions, but you won't be able to use the menu system without the remote control. The buttons on the front of the unit are described on page 7. Also, if you have another RCA, GE, or Proscan brand product with a remote control that has a DVD button, some of the buttons will probably operate this product if you press the DVD button first.

Handling Cautions

- Before connecting other components to this DVD/VCR, be sure to turn all components off.
- Don't move the player while a disc is being played. The disc may get scratched or broken, and the player's internal parts may be damaged.
- Don't put any container filled with liquid or any small metal objects on the DVD/VCR.
- Don't put your hand into the disc tray.
- Don't place anything other than the disc in the disc tray.
- Exterior influences such as lightning and static electricity can affect normal operation. If this occurs, turn the unit off and on again with the STANDBY•ON button, or disconnect and then reconnect the AC power cord to the AC power outlet. The unit should operate normally.
- Be sure to remove the disc and turn off the player after use.

Maintenance of Cabinet

For safety reasons, when cleaning the cabinet be sure to disconnect the AC power cord from the AC outlet.

- Do not use benzene, thinner, or other solvents for cleaning.
- Wipe the cabinet with a soft cloth.

Formation of Condensation

- Due to sharp changes in temperature and humidity, condensation may form if warm air comes in contact with any cold parts inside the player.
- When condensation forms inside the player, the player may not operate correctly. If this occurs, leave the player at room temperature until the inside of the player becomes dry and operational.
- If condensation forms on a disc, wipe the disc with a soft, dry cloth by moving the cloth from the center hole toward the outer edge.

Handling Discs

- Don't touch the disc's signal surfaces. Hold by the edges or by one edge and the hole in the center.
- Don't affix labels or adhesive tape to label surfaces. Don't scratch or damage the label.
- Do not use damaged (cracked or warped) discs.

Limited Warranty

What your warranty covers:

- Defects in materials or workmanship.

For how long after your purchase:

- One year from date of purchase for parts and labor.

The warranty period for rental units begins with the first rental or 45 days from date of shipment to the rental firm, whichever comes first.

What we will do:

- Pay any Authorized RCA Service Center the labor charges to repair your DVD/VCR.
- Pay any Authorized RCA Service Center for the new or, at our option, refurbished replacement parts required to repair your DVD/VCR.

How you get service:

- Take your DVD/VCR to any Authorized RCA Service Center. To identify your nearest Authorized RCA Service Center, ask your dealer, look in the Yellow Pages, or call 1-800-336-1900.
- Proof of purchase in the form of a bill of sale or receipted invoice which is evidence that the product is within the warranty period must be presented to obtain warranty service. For rental firms, proof of first rental is also required.
- Pick up your DVD/VCR when repairs are completed.

What your warranty does not cover:

- Acts of nature, such as but not limited to lightning damage.
- Adjustment of customer controls.
- Damage from misuse or neglect.
- A unit that has been modified or incorporated into other products or is used for institutional or other commercial purposes.
- Batteries.
- Units purchased or serviced outside the U.S. A.

Product Registration:

- Please complete the online Product Registration on RCA.com or complete and mail the Product Registration Card packed with your unit. It will make it easier to contact you should it ever be necessary. The return of the card is not required for warranty coverage.

Limitation of Warranty:

- THE WARRANTY STATED ABOVE IS THE ONLY WARRANTY APPLICABLE TO THIS PRODUCT. ALL OTHER WARRANTIES, EXPRESS OR IMPLIED (INCLUDING ALL IMPLIED WARRANTIES OF MERCHANTABILITY OR FITNESS FOR A PARTICULAR PURPOSE) ARE HEREBY DISCLAIMED. NO VERBAL OR WRITTEN INFORMATION GIVEN BY THOMSON INC., ITS AGENTS OR EMPLOYEES SHALL CREATE A WARRANTY OR IN ANY WAY INCREASE THE SCOPE OF THIS WARRANTY.
- REPAIR OR REPLACEMENT AS PROVIDED UNDER THIS WARRANTY IS THE EXCLUSIVE REMEDY OF THE CONSUMER. THOMSON INC. SHALL NOT BE LIABLE FOR INCIDENTAL OR CONSEQUENTIAL DAMAGES RESULTING FROM THE USE OF THIS PRODUCT OR ARISING OUT OF ANY BREACH OF ANY EXPRESS OR IMPLIED WARRANTY ON THIS PRODUCT. THIS DISCLAIMER OF WARRANTIES AND LIMITED WARRANTY ARE GOVERNED BY THE LAWS OF THE STATE OF INDIANA. EXCEPT TO THE EXTENT PROHIBITED BY APPLICABLE LAW, ANY IMPLIED WARRANTY OF MERCHANTABILITY OR FITNESS FOR A PARTICULAR PURPOSE ON THIS PRODUCT IS LIMITED TO THE APPLICABLE WARRANTY PERIOD SET FORTH ABOVE.

How state law relates to warranty:

- Some states do not allow the exclusion nor limitation of incidental or consequential damages, or limitations on how long an implied warranty lasts, so the above limitations or exclusions may not apply to you.
- This warranty gives you specific legal rights, and you also may have other rights that vary from state to state.

If you purchased your product outside the United States:

- This warranty does not apply. See your dealer for warranty information.

Accessory Information

There are various accessories available to complement your DVD/VCR. **Prices are subject to change without notice. All accessories are subject to availability.**

A shipping and handling fee will be charged upon ordering, and we are required by law to collect the appropriate sales tax for each individual state, country, and locality to which the merchandise is being sent.

For more information about accessories, go on-line to www.rca.com

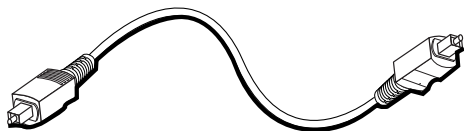

Optical Plug to Optical Plug for Optical Audio connection to a compatible receiver.
3 feet (part number DV3); price \$15.95
6 feet (part number DV6); price \$19.95

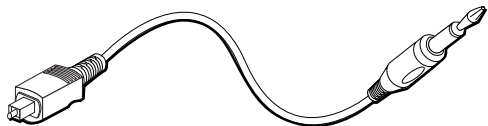

Optical Plug to Mini Plug
3 feet (part number DV3M); price \$15.95
6 feet (part number DV6M); price \$19.95

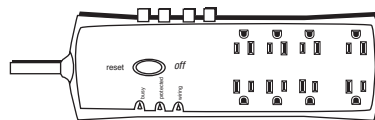

Surge Protector (part number SCTV4000C); price \$49.95

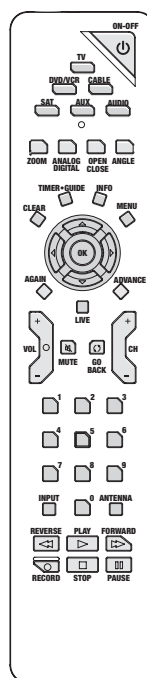

Remote Control (RCR311DBM1)
part number 261387; \$23.10

How to Order

To place an order by phone, have your Visa, MasterCard, or Discover Card ready and call the toll-free number listed below.

Use this number only to place an order for accessory items.

1-800-338-0376

Visit our website at www.rca.com

Please do not send any products to the Indianapolis address listed in this manual or on the carton. This will only add delays in service for your product.

Thomson Inc.
10330 North Meridian Street
Indianapolis, IN 46290

©2004 Thomson Inc.
Trademark(s) ® Registered
Marca(s) Registrada(s)
Printed in Thailand
TOCOM I635718A

THOMSON

THOMSON 

Free Manuals Download Website

<http://myh66.com>

<http://usermanuals.us>

<http://www.somanuals.com>

<http://www.4manuals.cc>

<http://www.manual-lib.com>

<http://www.404manual.com>

<http://www.luxmanual.com>

<http://aubethermostatmanual.com>

Golf course search by state

<http://golfingnear.com>

Email search by domain

<http://emailbydomain.com>

Auto manuals search

<http://auto.somanuals.com>

TV manuals search

<http://tv.somanuals.com>