

RCA

HDTV Monitor User's Guide

Changing Entertainment. Again.



Important Information

WARNING

To reduce the risk of fire or electric shock, do not expose this product to rain or moisture.

CAUTION

RISK OF ELECTRIC SHOCK
DO NOT OPEN



This symbol indicates that this product incorporates double insulation between hazardous mains voltage and user accessible parts. When servicing use only identical replacement parts.

Caution: To reduce the risk of electric shock, do not remove cover (or back). No user serviceable parts inside. Refer servicing to qualified service personnel.



This symbol indicates "dangerous voltage" inside the product that presents a risk of electric shock or personal injury.



This symbol indicates important instructions accompanying the product.

The apparatus shall not be exposed to dripping or splashing and that no objects filled with liquids, such as vases, shall be placed on the apparatus.

Refer to the identification/rating label located on the back panel of your product for its proper operating voltage.

FCC Regulations state that unauthorized changes or modifications to this equipment may void the user's authority to operate it.

Caution: Using video games or any external accessory with fixed images for extended periods of time can cause them to be permanently imprinted on the picture tube (or projection TV picture tubes). ALSO, some network/program logos, phone numbers, black borders (sides, top and bottom), etc. may cause similar damage. This damage is not covered by your warranty.

Cable TV Installer: This reminder is provided to call your attention to Article 820-40 of the National Electrical Code (Section 54 of the Canadian Electrical Code, Part 1) which provides guidelines for proper grounding and, in particular, specifies that the cable ground shall be connected to the grounding system of the building as close to the point of cable entry as practical.

Warning: Do not use the Freeze feature for an extended period of time. This can cause the image to be permanently imprinted on the picture tube. Such damage is not covered by your warranty. Press any button to unfreeze the picture at any time.

Product Registration

Please fill out the product registration card (packed separately) and return it immediately. For US customers: Your RCA Consumer Electronics product may also be registered at www.rca.com/productregistration. Registering this product allows us to contact you if needed.

Product Information

Keep your sales receipt to obtain warranty parts and service and for proof of purchase. Attach it here and record the serial and model numbers in case you need them. These numbers are located on the product.

Model No. _____

Serial No. _____

Purchase Date: _____

Dealer/Address/Phone: _____

IMPORTANT SAFETY INSTRUCTIONS

1. Read these instructions.
2. Keep these instructions.
3. Heed all warnings.
4. Follow all instructions.
5. Do not use this apparatus near water.
6. Clean only with dry cloth.
7. Do not block any ventilation openings. Install in accordance with the manufacturer's instructions.
8. Do not install near any heat sources such as radiators, heat registers, stoves, or other apparatus (including amplifiers) that produce heat.
9. Do not defeat the safety purpose of the polarized or grounding-type plug. A polarized plug has two blades with one wider than the other. A grounding type plug has two blades and a third grounding prong. The wide blade or the third prong is provided for your safety. If the provided plug does not fit into your outlet, consult an electrician for replacement of the obsolete outlet.
10. Protect the power cord from being walked on or pinched particularly at plugs, convenience receptacles, and the point where they exit from the apparatus.
11. Only use attachments/accessories specified by the manufacturer.
12. Use only with the cart, stand, tripod, bracket, or table specified by the manufacturer, or sold with the apparatus. When a cart is used, use caution when moving the cart/apparatus combination to avoid injury from tip-over.
13. Unplug this apparatus during lightning storms or when unused for long periods of time.
14. Refer all servicing to qualified service personnel. Servicing is required when the apparatus has been damaged in any way, such as power-supply cord or plug is damaged, liquid has been spilled or objects have fallen into the apparatus, the apparatus has been exposed to rain or moisture, does not operate normally, or has been dropped.



If an outside antenna is connected to the TV receiver, be sure the antenna system is grounded so as to provide some protection against voltage surges and built up static charges. In the U.S. Section 810-21 of the National Electrical Code and in Canada, Part 1 of the Canadian Electrical Code provides information with respect to proper grounding of the antenna system. See the figure on the right for details.

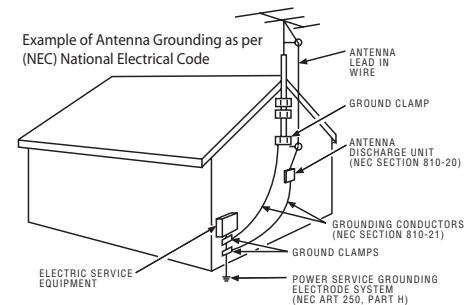

To assure adequate ventilation for this product, maintain a spacing of 4 inches from the top and sides of the TV receiver and 2 inches from the rear of the TV receiver and other surfaces.

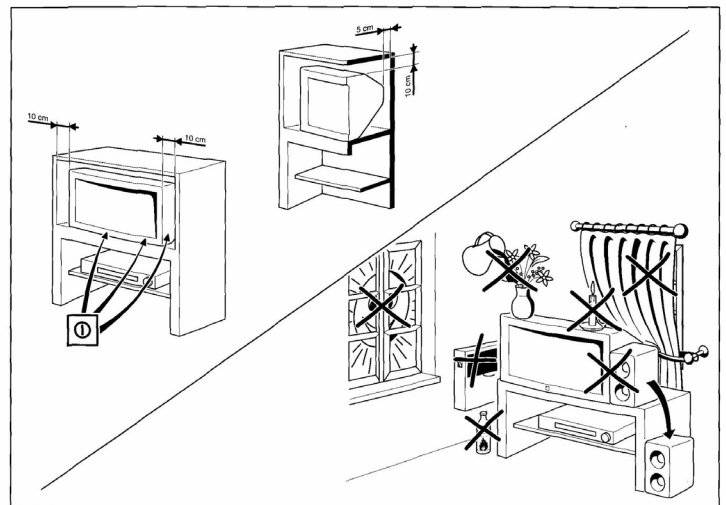

Introduction

Key Features Overview

Your TV is equipped with features that will add to your TV viewing experience. The following information summarizes a few of these features. Chapter 3 provides more information about the rest of the TV's features and how to use them.

Hi-Pix Picture Enhancement System

The Hi-Pix Picture Enhancement System incorporates two of RCA's most advanced technologies: TruScan Digital Reality and the AVR Picture Projection System. The result is the ultimate in true-to-life picture performance that provides the optimum picture resolution from each digital source connected to your TV (terrestrial, DVD, satellite, and/or cable).

TruScan Digital Reality

Picture performance starts with signal processing. TruScan Digital Reality intelligent signal processing recognizes incoming video signals and progressively converts them to achieve optimum digital picture performance. It enhances the picture quality and makes you feel as if you're close to the real thing. It also recognizes when original film sources have been modified and automatically converts the analog frame rate back to its original format to bring out the detail – a process commonly referred to as reverse 3:2 pulldown.

AVR Picture Projection System

The Accurate Visual Reality high definition picture projection system offers a brighter picture than conventional CRTs (cathode ray tubes). These tubes create brilliant, lifelike fidelity. The AVR 4 lens system is designed to complement the CRTs providing accurate colors and razor sharp focus everywhere on the screen.

DVI-HDTV Input

Lets you connect a component with a DVI (Digital Visual Interface) output. DVI provides an uncompressed, digital video interface developed for high-bandwidth digital connection. It supports the overlay of high-resolution graphics needed by some electronic program guide navigation and other interactive services. DVI, when combined with HDCP (High bandwidth Digital Content Protection) technology, creates a protected digital connection. The DVI-HDTV connection is designed to display either progressive scan (480p) or HDTV (1080i) signals at a bandwidth of up to 1.78 Gigabits per second.

PIP (Picture-In-Picture) and POP (Picture-Outside-Picture)

Description: PIP lets you watch two channels at one time – one channel on the main screen and the other in a smaller window. POP also lets you watch two channels at one time – one channel on the left side of the screen (the main picture) and the other on the right.

Requirements: Press the PIP button to bring up the PIP window. Press again to bring up POP. Chapter 3 has detailed instructions on how to use the PIP and POP features.

Note: PIP and POP are not available for DVI or component video sources (CMP1 or CMP2).

V-Chip: Parental Controls (for the U.S. and Canada)

Description: You can block programs and movies by content, age-based ratings, and/or movie ratings.

Requirements:

- Set up the *Parental Control* menu in the TV's main menu (Chapter 3 has details).
- The broadcasters must use the rating system when they send the program to your TV in order for your TV to block the program.
- Parental controls must be locked for these settings to take affect.

Table of Contents

Important Safety Instructions	1	Channel 3: Special Features	
Introduction		Channel Banner	24
Key Features Overview	2	Autotuning	24
Chapter 1: Setup & Connections		Why You Should Use the Autotuning Feature	24
Things to Consider Before You Connect	4	How to Set Up the Autotuning Feature.....	25
Choose Your Connection	5	Parental Controls and V-Chip	26
Cables Needed to Connect Components		How V-Chip Works for USA and Canada.....	26
to Your TV.....	5	Canada V-Chip Ratings	29
TV + HDTV Tuner + VCR + DVD Player	7	Blocking Canadian V-Chip Ratings	30
TV + Satellite Receiver + VCR	9	Lock/Unlock Parental Controls	31
TV + DVD + VCR	11	V-Chip Movie Rating Limit	31
TV+ A/V Receiver or Speakers	12	Blocking Unrated/Exempt Programs	31
Explanation of Jacks	13	PIP (Picture-in-Picture) and	
The Front of Your TV	14	POP (Picture-outside-Picture) Operation	32
Front Input Jacks.....	14	PIP and POP Buttons.....	32
Front Panel Buttons.....	15	Chapter 4: Using the Menu System	
Plug in the TV	15	Sound Menu	33
Put batteries in the remote	15	Picture Menu	34
How to Use the Remote Control to Complete		Channel Guide Menu	36
the Initial Setup	15	Time Menu	36
Complete Auto Channel Search.....	16	Parental Control Menu	36
Turn on the TV	16	PIP Menu	37
Complete the Initial Setup	16	Setup Menu	37
Set the Menu Language	16	Chapter 5: Additional Information	
Changing Lists and Labels	17	Troubleshooting	39
Auto Convergence.....	17	FCC Information	41
Chapter 2: Using the Remote Control		Care and Cleaning	41
The Buttons on the Remote Control	18	RCA HDTV Monitor Limited Warranty	42
Programming the Remote	20	Accessory Information	44
Find Out If You Need to Program the Remote	20		
How to Use the Remote After You've			
Programmed It	21		
Using the INPUT Button	22		
Remote Control Codes	22		

Things to Consider Before You Connect

Protect Against Power Surges

- Connect all components before you plug any of their power cords into the wall outlet.
- Turn off the TV and/or component before you connect or disconnect any cables.
- Make sure all antennas and cables are properly grounded. Refer to the Important Safety Instructions on page 1.

Protect Components from Overheating

- Don't block ventilation holes on any of the components. Arrange the components so that air can circulate freely.
- Don't stack components.
- If you place components in a stand, make sure you allow adequate ventilation.
- If you connect an audio receiver or amplifier, place it on the top shelf so the heated air from it won't flow around other components.

Position Cables Properly to Avoid Audio Interference

- Insert each cable firmly into the designated jack.
- If you place components above the TV, route all cables down the side of the back of the TV instead of straight down the middle of the TV.
- If your antenna uses 300-ohm twin lead cables, do not coil the cables. Also, keep the twin lead cables away from audio/video cables.

Important Stand and Base Safety Information

Choose the location for your TV carefully. Place the TV on a stand or base that is of adequate size and strength to prevent the TV from being accidentally tipped over, pushed off, or pulled off. This could cause personal injury and/or damage the TV. Refer to the Important Safety Instructions on page 1.

Use Indirect Light



Don't place the TV where sunlight or room lighting will be directed toward the screen. Use soft or indirect lighting.

Choose Your Connection

There are several ways to connect your TV. Please use the following chart to determine which connection is best for you. Proceed to the appropriate page and connect your TV.

Note for US customers: If you prefer, we can provide you with the name of an Authorized Service Representative who will visit your home for a fee to install your electronic entertainment system and to instruct you in its operation. For details about this service, call 1-888-206-3359.

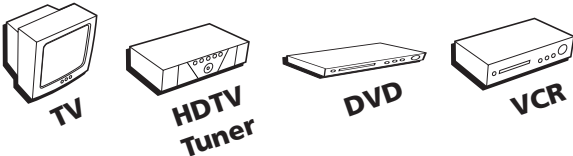
For additional assistance while using your RCA product, please visit www.rca.com/customersupport.

Components	Cables Needed	Connection Title	Go to...
 <p>TV HDTV Tuner DVD VCR</p>	<p>Coaxial Audio/video Component video DVI-HDTV</p>	<p>TV + HDTV Tuner + DVD + VCR</p>	<p>pages 6-7</p>
 <p>TV Satellite VCR</p>	<p>Coaxial Audio/video S-Video</p>	<p>TV + Satellite Receiver + VCR</p>	<p>pages 8-9</p>
 <p>TV DVD VCR</p>	<p>Coaxial Audio/video Component video</p>	<p>TV + DVD + VCR</p>	<p>pages 10-11</p>

For general information on connecting an A/V receiver or speakers to your TV, go to page 12.

Cables Needed to Connect Components to Your TV

The pictures below show the cables needed for the connections represented in this book.

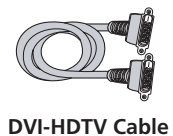
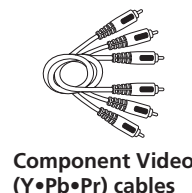
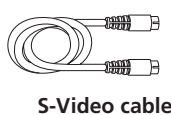
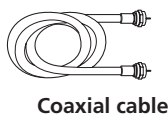

Connections & Setup

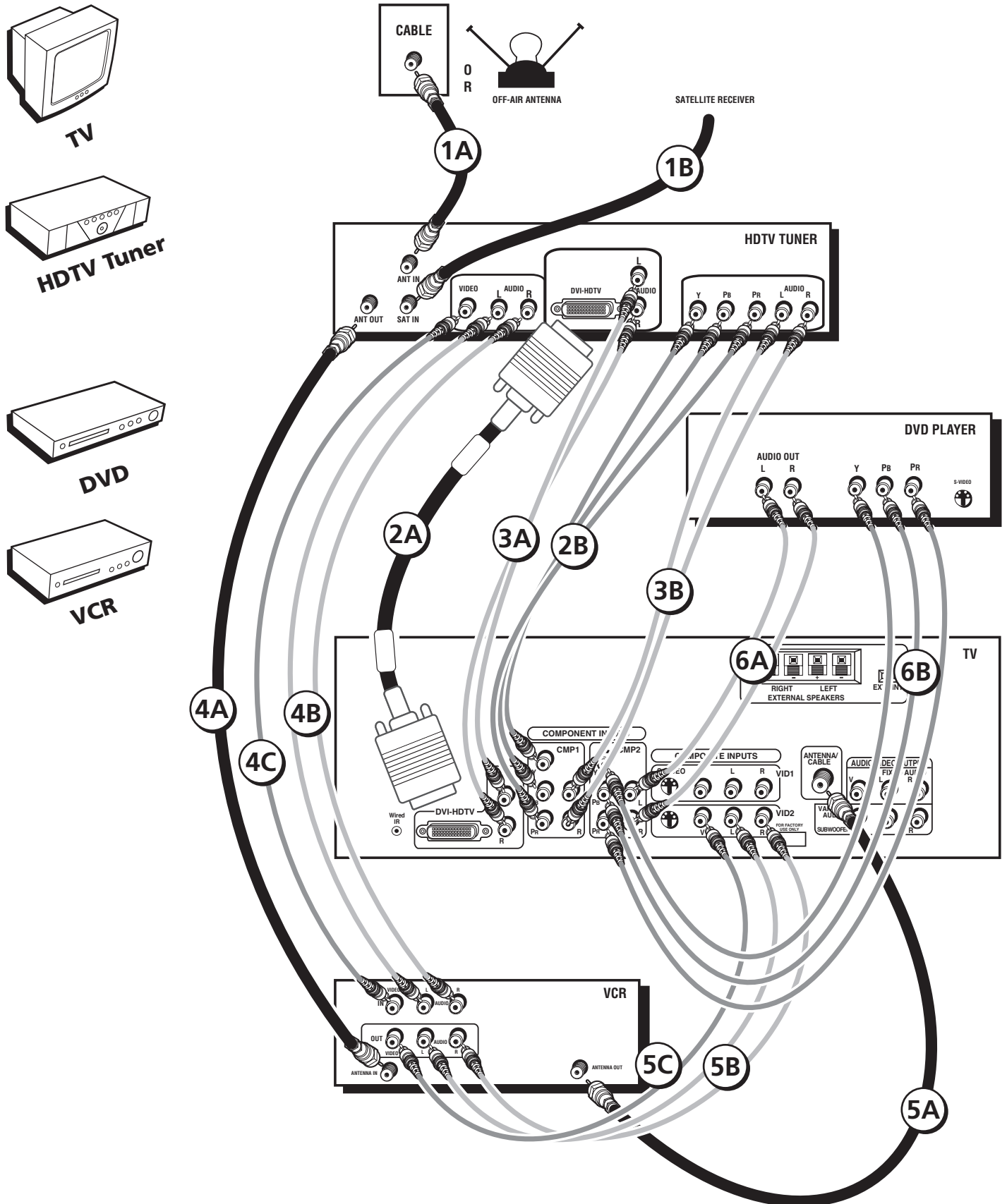

TV + HDTV Tuner + VCR + DVD Player

1. Make sure cable or antenna and/or satellite is connected to your VCR.

- A. Connect the coaxial cable from your cable outlet or antenna to the antenna input on the HDTV Tuner.
- B. Connect the satellite dish antenna to the satellite input on the HDTV Tuner.

2. Make the video connection between your HDTV Tuner and the TV.

A. Best Connection: DVI-HDTV

Connect a DVI-HDTV cable to the DVI-HDTV jack on the back of your HDTV Tuner. Connect the other end of the cable to the DVI-HDTV input on the back of TV.

– OR –

- #### B. Very Good Connection: Connect three video grade cables to the CMP1 Y PB PR jacks on the back of the TV and to the Y PB PR jacks on the HDTV Tuner.

Notes: The DVI-HDTV and Y PB PR jacks send the digital cable signal to the TV in digital and analog formats, respectively.

3. Make the audio connection between your HDTV Tuner and the TV (to match your video connection).

A. If you used the DVI-HDTV jack:

Connect the audio (white and red) cables to the DVI-HDTV L and R audio jacks on the back of the TV and to the Audio Output jacks on the HDTV Tuner.

– OR –

B. If you used the Component Video jacks:

Connect the audio (white and red) cables to the CMP1 L and R audio jacks on the back of the TV and to the Audio Output jacks on the HDTV Tuner.

4. Connect your HDTV Tuner to your VCR.

- A. Connect a coaxial cable to the HDTV Tuner's antenna output and to VCR's antenna input.
- B. Connect the audio (white and red) cables to the Audio Output jacks on the HDTV Tuner and to the Audio Input jacks on the VCR.
- C. Connect the video cable to the Video Output jack on the HDTV Tuner and to the Video Input jack on the VCR.

5. Connect your VCR to your TV.

- A. Connect a coaxial cable to the VCR's antenna output and to the ANTENNA/CABLE Input jack on the TV.
- B. Connect the audio (white and red) cables to the VID2 L/MONO and R audio jacks on the back of the TV and to the Audio Output jacks on the VCR.
- C. Connect the video cable to the VID2 V (video) jack on the back of the TV and to the Video Output jack on the VCR.

6. Connect your DVD player to your TV.

- A. Connect the audio (white and red) cables to the CMP2 L and R audio jacks on the back of the TV and to the Audio Output jacks on the DVD player.
- B. Connect three video grade cables to the CMP2 Y PB PR jacks on the back of the TV and to the Y PB PR jacks on the DVD player.

Notes: If your DVD player doesn't have Y PB PR jacks, but does have an S-Video jack, connect the player to the TV's VID1 S-VIDEO jack using an S-Video cable.

If your DVD player doesn't have an S-Video jack, connect the player to the TV's VID1 V (video) jack using a video cable.

Important: If you use the TV's VID1 S-VIDEO or V (video) jack to connect the DVD player, you must connect the audio cables to the TV's VID1 L/MONO and R jacks.

Go to page 15

Connections & Setup

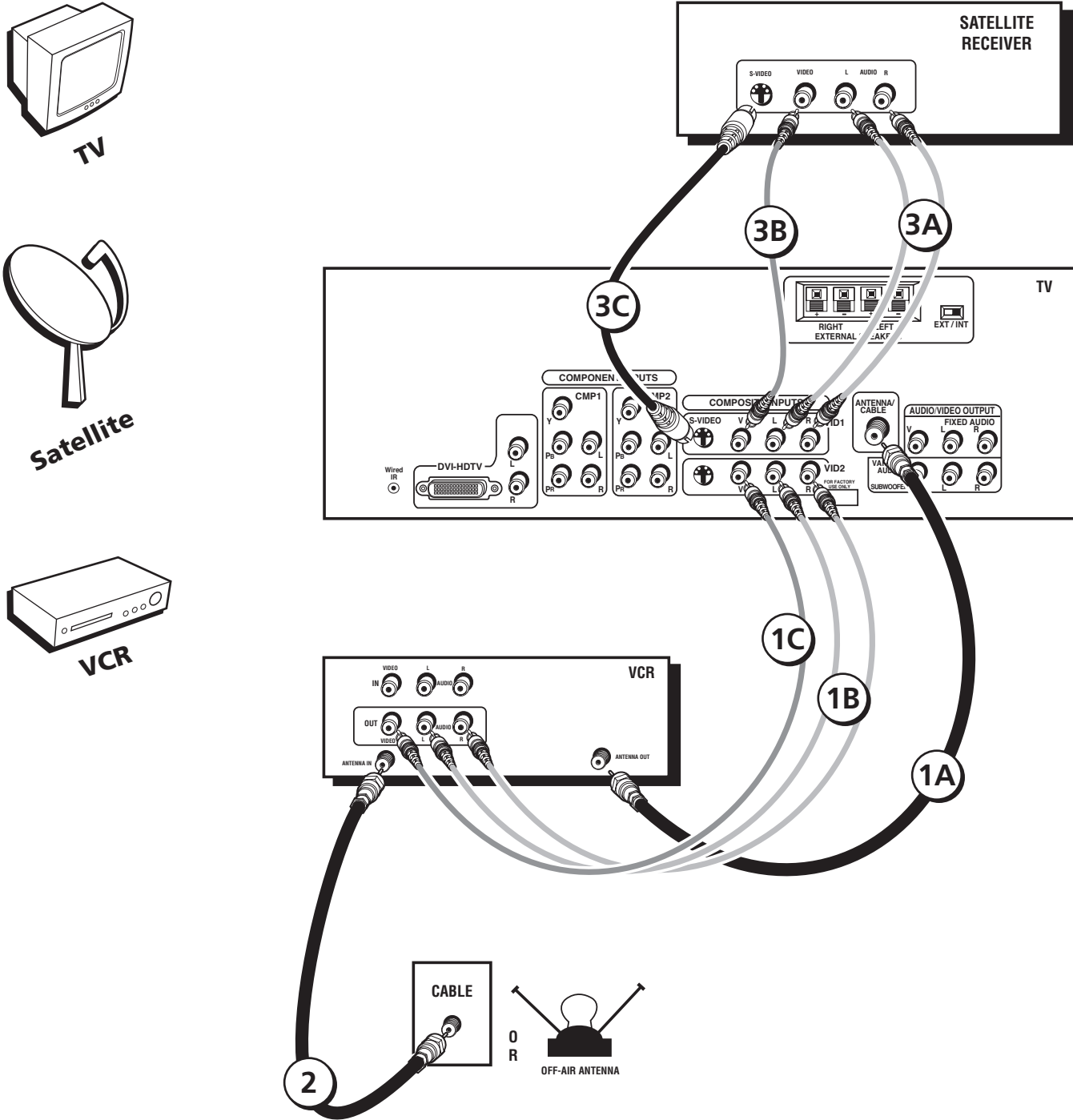

TV + Satellite Receiver + VCR

1. Connect your VCR to your TV.

- A. Connect a coaxial cable to the VCR's antenna output and to the ANTENNA/CABLE Input jack on the TV.
- B. Connect the audio (white and red) cables to the VID2 L/MONO and R Audio jacks on the back of the TV and to the Audio Output jacks on the VCR.
- C. Connect the video cable to the VID2 V (Video) jack on the back of the TV and to the Video Output jack on the VCR.

2. Make sure cable or antenna is connected to your VCR.

Connect the coaxial cable from your cable outlet or antenna to the antenna input on the VCR.

3. Connect your Satellite Receiver to your TV.

- A. Connect the audio (white and red) cables to the VID1 L/MONO and R Audio jacks on the back of the TV and to the Audio Output jacks on the Satellite Receiver.
- B. Connect the video cable to the VID1 V (Video) jack on the back of the TV and to the Video Output jack on the Satellite Receiver.
- C. If your Satellite Receiver has an S-Video jack, connect an S-Video cable (instead of the video cable in step B) to the S-VIDEO jack on the TV and to the S-VIDEO jack on the satellite receiver.

Go to page 15

Connections & Setup

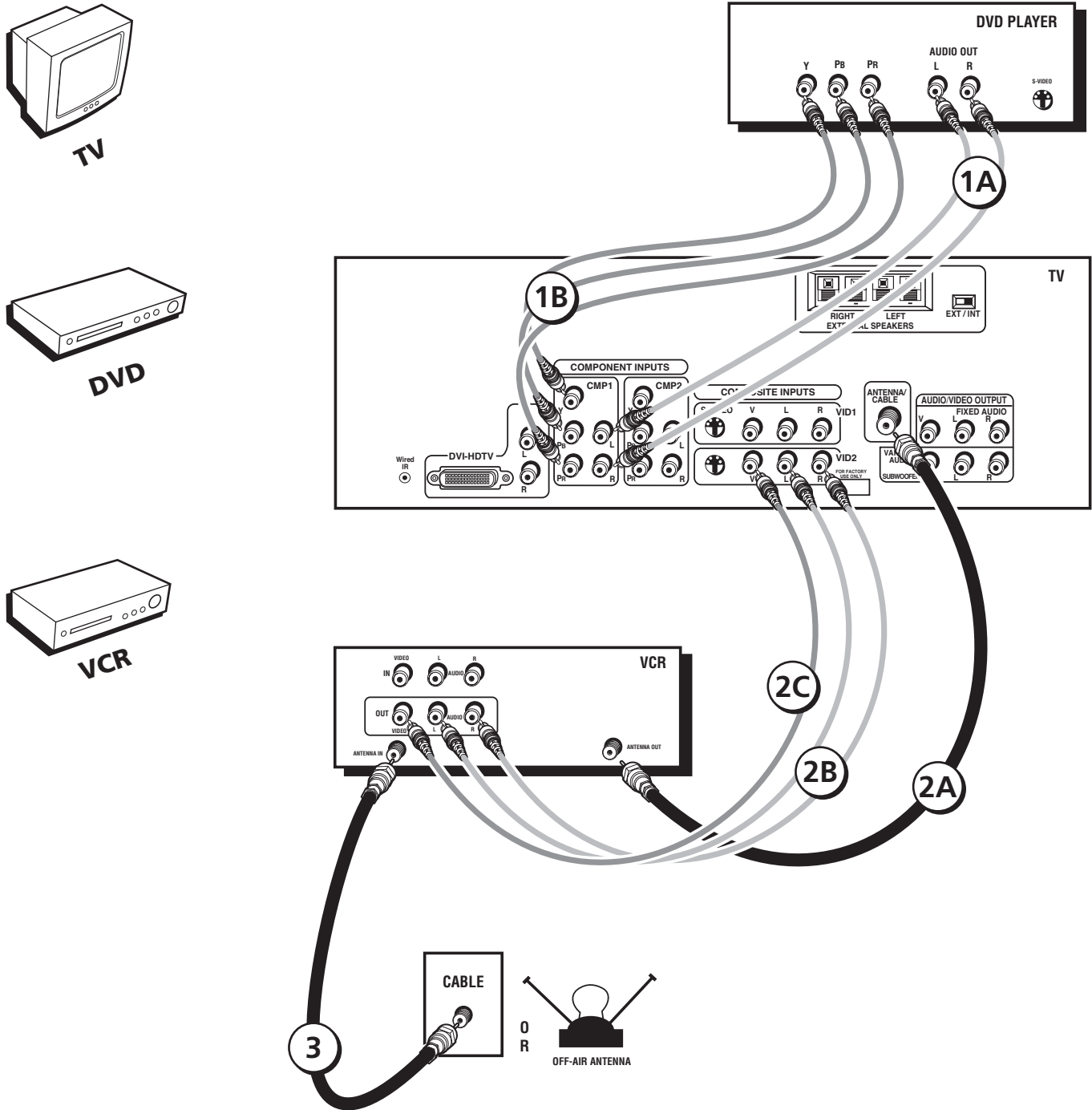

TV + DVD + VCR

1. Connect your DVD Player to your TV.

- A. Connect the audio (white and red) cables to the CMP1 L and R Audio jacks on the back of the TV and to the Audio Output jacks on the DVD player.
- B. Connect three video grade cables to the CMP1 Y PB PR jacks on the back of the TV and to the Y PB PR jacks on the DVD player.

Notes:

If your DVD player does not have Y PB PR jacks, but does have an S-Video jack, connect the player to the VID1 S-VIDEO jack on the TV using an S-Video cable.

If your DVD player does not have an S-Video jack, connect the player to the VID1 V (Video) jack on the back of the TV using a video cable.

Important: If you use the VID1 S-VIDEO or V (Video) jack to connect your TV to the DVD player, you must connect the audio cables to the VID1 L/MONO and R jacks on the TV.

2. Connect your VCR to your TV.

- A. Connect a coaxial cable to the VCR's antenna output and to the ANTENNA/CABLE Input jack on the TV.
- B. Connect the audio (white and red) cables to the VID2 L/MONO and R Audio jacks on the back of the TV and to the Audio Output jacks on the VCR.
- C. Connect the video cable to the VID2 V (Video) jack on the back of the TV and to the Video Output jack on the VCR.

3. Make sure cable or antenna is connected to your VCR.

Connect the coaxial cable from your cable outlet or antenna to the antenna input on the VCR.

Go to page 15

TV+ A/V Receiver or Speakers

These are two different ways your TV uses a component to hear audio.

1. Connect audio cables to either the FIXED or VARIABLE AUDIO L and R OUTPUT jacks and to the Audio Inputs on the A/V receiver.
 - FIXED provides fixed-level audio output from the TV. This audio output is ideal for connecting to an A/V receiver that has its own volume control.
 - VARIABLE provides variable-level audio output. Volume levels can be controlled by the volume controls on the TV and TV remote control.

-OR-

2. Use speaker wire to connect the TV to external speakers.
 - The EXT/INT switch beside the jacks let you turn the TV's internal speakers on or off. If you connect external speakers, slide the switch to EXT so the audio is sent to the external speakers only. Choosing INT sends the audio to the TV's speakers only. Choosing INT sends the audio to the TV's speakers only.

Note: The external speaker rating is 8 ohms with 15 watts power handling capabilities.

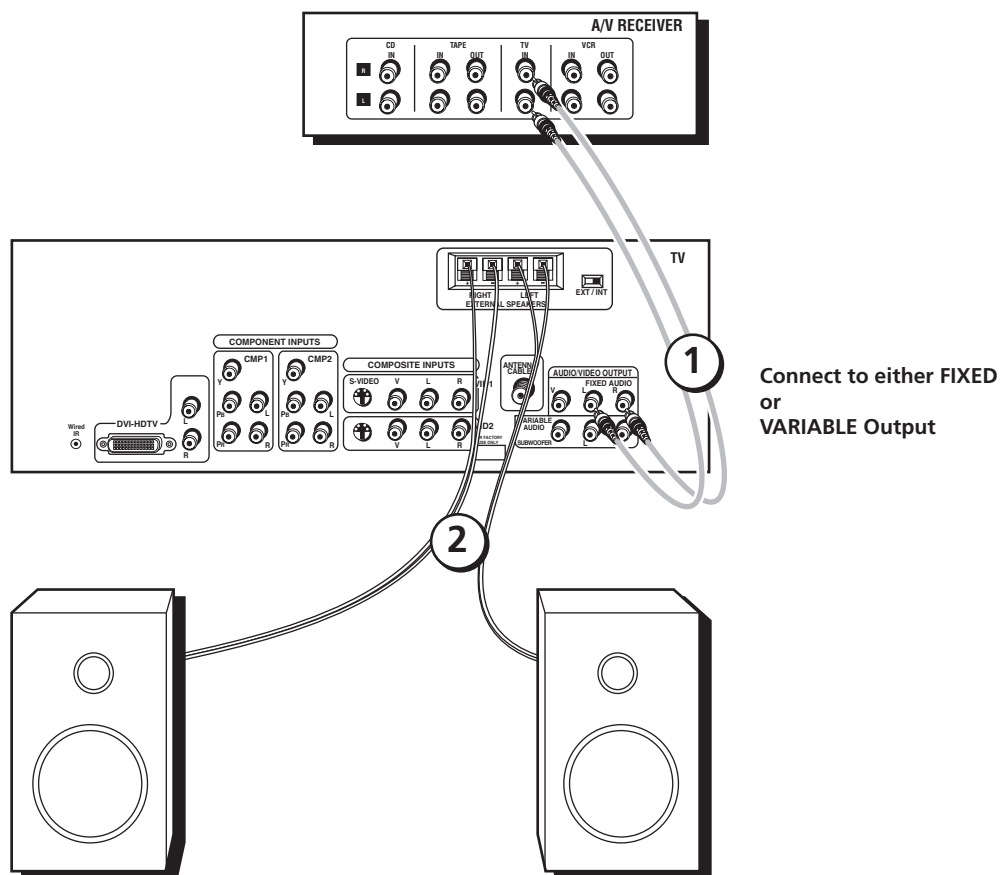

Explanation of Jacks (in alphabetical order)

This section describes the jacks you can use to make connections. There are several ways to connect components to your TV.



ANTENNA/CABLE Lets you connect a coaxial cable to receive the signal from the antenna, cable, cable box, or if using the examples on pages 6-11, a VCR.

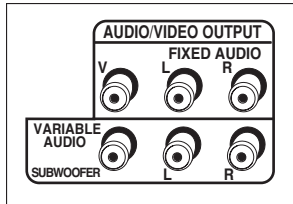

AUDIO/VIDEO OUTPUT Lets you connect an amplifier or audio receiver for improved sound quality or an external video monitor.

- **FIXED AUDIO L/R** Provides fixed-level audio output from the TV. This audio output is ideal for connecting an A/V receiver when you want to control the volume through the A/V receiver.
- **VARIABLE AUDIO** Provides variable-level audio output. Volume levels are controlled by the volume controls on the TV and remote control.
- **SUBWOOFER** Provides lower bass audio frequencies from the TV to a subwoofer.

Note: If you've connected a subwoofer, make sure you set the External Subwoofer option in the Sound menu. Go to page 33 for instructions.

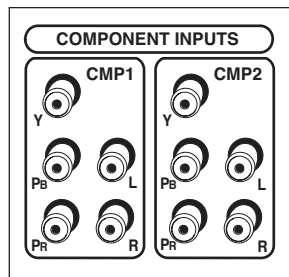

COMPONENT INPUTS Lets you connect a component video source, such as a DVD player.

- **CMP1 Y PB PR (Component Video)** Provides optimum picture quality because the video is separated into three signals. Use three video-grade cables for the connection. When using CMP1 Y PB PR, make sure to connect left and right audio cables to the CMP1 L and R Audio Input jacks.
- **CMP1 L (Audio)** Provides left audio connection. The left audio connector is usually white.
- **CMP1 R (Audio)** Provides right audio connection. The right audio connector is usually red.
- **CMP2 Y PB PR, and L and R Audio** Allows you to connect a second component video source. Their description is the same as CMP1 above. When using CMP2 Y PB PR, make sure you connect the left and right audio cables to the CMP2 Audio jacks.

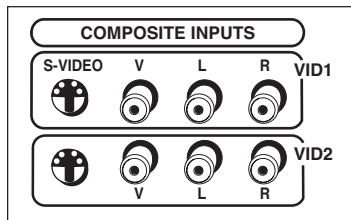

COMPOSITE INPUTS Lets you connect another component such as a VCR, DVD player, or laserdisc player. Its AUDIO jacks are the same as described for CMP1 above.

- **VID1 S-VIDEO** Provides better picture quality than the video jacks (VID1 and 2 Video) because the color part of the picture is separated from the black and white part of the picture. When using VID1 S-VIDEO, make sure to connect left and right audio cables to the VID1 L/MONO and R Audio Input jacks.
- **VID1 V (Video)** Provides composite video connection. The video connector is usually yellow.
- **VID2 S-VIDEO, V and L/MONO and R Audio** Allows you to connect a component such as a VCR, DVD player, or laserdisc player. Their description is the same as VID1 above.

Note: For each VID jack group (VID1 and VID2), you may connect either an S-Video or Video cable. Do not connect both at the same time in either of the VID jack groups.

Continues on next page...

Connections & Setup

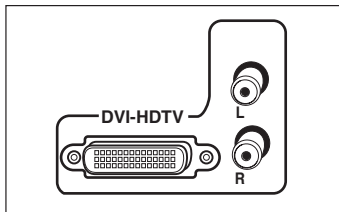

DVI-HDTV Input Lets you connect an HDTV Tuner with a DVI output.

- **DVI (Digital Visual Interface)** Provides an uncompressed, digital video interface developed for high-bandwidth digital connection. It supports the overlay of high-resolution graphics needed by some electronic program guide navigation and other interactive services. DVI, when combined with HDCP (High bandwidth Digital Content Protection) technology, creates a protected digital connection. The DVI-HDTV connection is designed to display either progressive scan (480p) or HDTV (1080i) signals at a bandwidth of up to 1.78 Gigabits per second.
- **L (Audio)** Provides left audio connection when using the DVI jack. The left audio connector is usually white.
- **R (Audio)** Provides right audio connection when using the DVI jack. The right audio connector is usually red.

Note: Remember to connect the left and right audio cables because the DVI cable carries only the picture signal, not the sound.

EXTERNAL SPEAKERS

- **Right and Left Speaker Terminals** Let you connect external left and right speakers to the TV to receive left and right sound.
- **EXT/INT (switch)** Lets you turn the TV's internal speakers on or off. EXT sends audio to external speakers only. INT sends audio to the TV's internal speakers only.

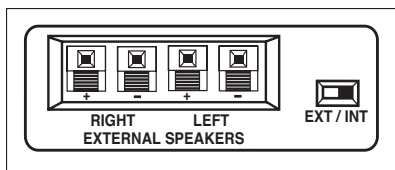

Wired IR This jack is for connecting a wired remote control system, which is primarily for professional installers. If you're using the remote that was included with your TV, don't plug anything into this jack.

The Front of Your TV

Front Input Jacks

The TV has front inputs for convenience: one set of audio/video input jacks, an S-Video jack and a headphones jack. The jacks are ideal for using a video game console or a camcorder. Locate the jacks either on the front of the TV or on one of the sides. To access the component you connected to the front of the TV, press the INPUT button on your remote until *FRNT* appears on the screen.

Note: When connecting a component that uses a monaural cable, such as some camcorders, use the Left (mono) input jack to get sound from both speakers.

PHONES Allows you to connect headphones to listen to the sound coming from the TV. To adjust volume control of the headphones, press the VOL > or VOL < button (the volume display appears). Press the arrow up or down button (the headphone volume display appears), then press the right or left arrow button to adjust the headphone volume.

VIDEO (in) Receives video from another component such as a camcorder, video game console or VCR.

L/MONO and R AUDIO Receives audio from another component such as a camcorder, video game console or VCR.

S-VIDEO (in) Allows you to connect an S-Video cable from another component. Make sure you also connect audio cables from the component to the TV.

Note: Do not connect an S-Video and a regular video cable to the FRNT jacks at the same time.

Front Panel Buttons

If you cannot locate your remote, you can use the front panel buttons of your TV to operate many of the TV's features.

MENU/OK Brings up the Main menu. In the menu system, it selects highlighted items.

CH ∇ Scans down through the current channel list. In the menu system, acts like down arrow button on the remote control and adjusts menu controls.

CH \wedge Scans up through the channel list. In the menu system, acts like up arrow button on the remote control and adjusts menu controls.

VOL $<$ Decreases the volume. In the menu system, acts like left arrow button on the remote control and adjusts menu controls.

VOL $>$ Increases the volume. In the menu system, acts like right arrow button on the remote control and adjusts menu controls.

POWER Turns the TV on and off.

Plug in the TV

Plug the end of the power cord into a grounded wall outlet. Insert the plug completely into the outlet.

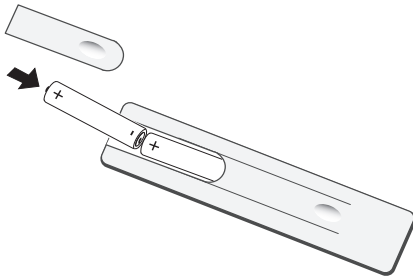

Put batteries in the remote

- Remove the battery compartment cover from the back of the remote by pushing the tab and lifting off the cover.
- Insert 2 "AA" fresh batteries. Make sure the polarities (+ and -) are aligned correctly.
- Replace the cover.

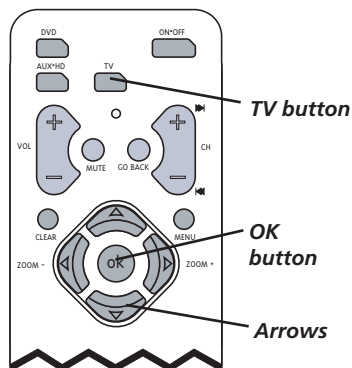

How to Use the Remote Control to Complete the Initial Setup

The technical term is "Navigation" – how you move through the on-screen menus. The theory is the same throughout the menu screens: highlight your choice and select it.

To highlight a menu item, press the arrow buttons on the remote to highlight one of the items listed on the screen. Use the up or down arrow button to move up or down. Use the right or left arrow button to move right or left.

To select the item that you've highlighted, press OK.

Note: Highlighted means that the menu item stands out from other menu items on the list (appears darker, brighter, or a different color).

Turn on the TV

Press TV on the remote, or press POWER on the TV's front panel.

Note: Pressing the TV button not only turns on the TV, but puts the remote into TV mode. "TV mode" means that the buttons on the remote control operate the TV's functions.

Tip

To access the setup menus manually, press MENU and choose SETUP.

Complete the Initial Setup

The menu system in your TV allows the TV's features to work properly. The first time you turn on your TV, the setup screens appear.

Set the Menu Language

The first part of the setup allows you to select your preferred language for the menu system.

If English is your preferred language, press OK. If you want to choose another language, press the down arrow button until that language is highlighted, and press OK.

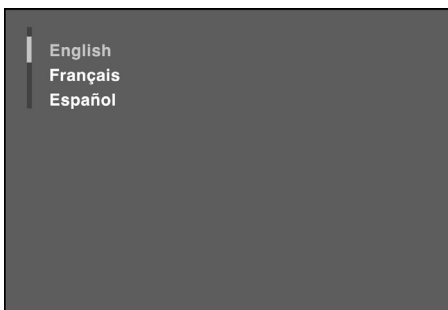

Complete Auto Channel Search

The next screen asks you to make sure you've connected the TV to a cable, satellite, or off-air signal. When you're sure that a signal is connected to your TV, press OK on your remote to go to the Channel setup screen.

In the Channel setup screen, you can launch the Auto channel search by pressing OK. The Auto channel search allows the TV to search for all channels viewable through your antenna or cable TV system. This is sometimes called *auto programming*. When the channel search is complete, press OK to access the *List & Labels* screen.

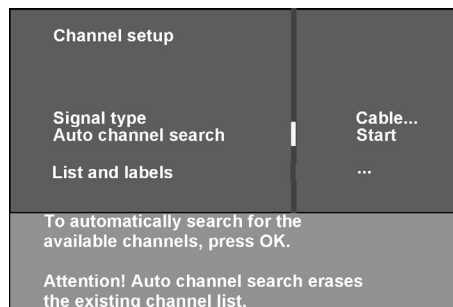



Changing Lists and Labels

The List & Labels part of the setup lets you edit your channel list and choose or create a personal six-character label for each channel.

Note: *Changing List and Labels can be time consuming. You can change these at a later time by accessing the Setup menu.*

1. Press the left or right arrow to scroll through the channels and choose the one you want to edit.
2. Press the down arrow to highlight the *In channel list* option. Press the left or right arrow button to add (the box is checked) or remove (the box is unchecked) the channel from the list.
3. Press the down arrow to highlight the *Channel label* option. Press the left or right arrow button to scroll through the available list of 25 most common labels. The last option in the list allows you to create your own six-character label for the channel (the first letter of the label is highlighted).
4. Press the 1 or 2 number button to change the first letter of the label.
5. Press the right arrow to highlight the second letter, then press the 1 or 2 number button to change the second letter, etc...
6. When you are finished creating your label, press OK. Select *Go back* to go to the *Auto Convergence* menu.

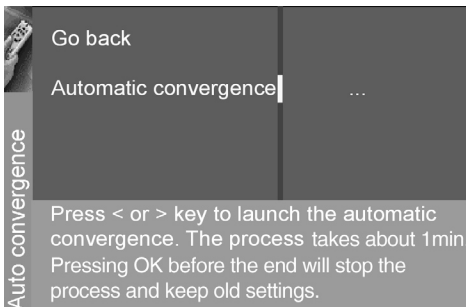

Auto Convergence

Your TV's picture tubes might have been disturbed during delivery or after you moved the TV, causing the color in your TV to be out of alignment. The colors adjust by starting auto convergence.

IMPORTANT: *Auto convergence works best once the TV has warmed up for at least an hour. If you've just unpacked your TV, it's a good idea to repeat the Auto convergence function when the TV's been running for at least an hour. See page 38 for more information about Auto convergence.*

1. Press OK to begin auto convergence.
2. When the auto convergence is complete, the *Red center convergence* menu appears. The cross in the middle of the screen should be yellow. If it is not, use the arrow buttons to move the red cross to overlap the green cross. Press OK when adjustments are complete.
3. The *Blue center convergence* menu appears with a cyan cross in the middle of the screen. If it is not, use the arrow buttons to move the blue cross to overlap the green cross. Press OK (the TV tunes to the last selected/available channel in the channel list).

Note:

If you're using an HD source (such as an HDTV tuner or HDTV satellite receiver) on the CMPNT or DVI input, you should run Auto convergence separately for that input as well. Tune to the input you're using for the HD source, then go to page 38 for information on Auto convergence.

The Buttons on the Remote Control

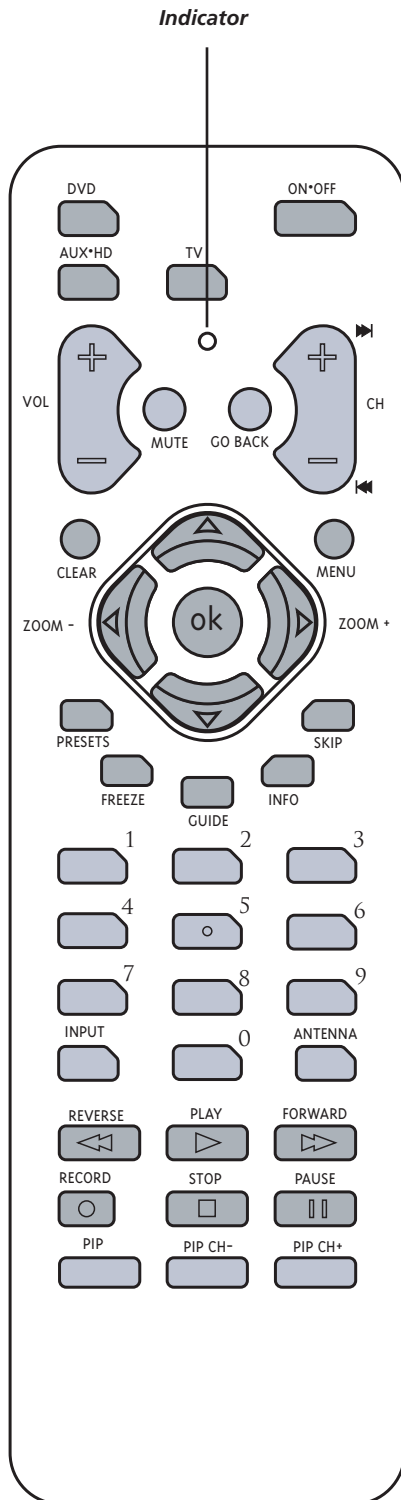

(0-9) Number Buttons Enter channel numbers and time settings directly through the remote control.

To enter a one-digit channel, enter a zero first. To enter a two-digit channel, press the two digits. To enter a three-digit channel, press and hold the 1 button until 1 and two dashes (--) appear, then add the second two digits. Example: to tune to channel 123, press and hold 1 until 1-- appears, release the 1 button and then press 2 and 3.

ANTENNA In VCR mode (if programmed), this button works as a TV/VCR button for some VCRs. In SAT mode (if programmed), this button works as a TV/SAT button for some satellite receivers.

Arrows Used to highlight different items in the TV menu and to adjust the menu controls. The up and down arrows move the PIP window when no menus are on the screen. When watching TV without the PIP window or menu system in use, the left and right arrows (**ZOOM-** and **ZOOM+**) change the current format of the screen (4:3, Zoom 14:9, Zoom 16:9, Zoom 16:9 \wedge/v , Cinerama, regular mode 16:9).

AUX•HD Puts the remote in AUX/HD mode. As a default, this button controls some models of RCA HDTV Tuners. It can also be programmed to operate some brands of an additional remote-controllable components. The Autotuning feature for this button works *only* with HDTV tuners (see page 24 for more information on Autotuning).

CH + or CH - Scans up or down through the current channel list. Press once to change the channel up or down; press and hold to continue changing channels. In DVD mode (if programmed), these buttons work as chapter advance or chapter reverse buttons with some DVD players.

CLEAR Removes any menu or display from the screen and returns you to normal viewing. Also exits PIP or POP if no menu is displayed.

DVD Puts the remote in DVD mode and, if Autotuning is enabled, will turn on the TV and tune to the correct input channel.

FREEZE When watching TV, freezes the picture until you press any button on the remote to resume normal TV viewing. The FREEZE feature automatically times out after a short time. Please note that when you "unfreeze" you go back to live programming (skipping any programming that occurred during the freeze).

Note: The FREEZE feature does not work on signals from the DVI-HDTV, CMP1 or CMP2 inputs in progressive scan (480p) or HDTV (1080i) modes.

Do not use the Freeze feature for an extended period of time. This can cause the image to be permanently imprinted on the picture tube. Such damage is not covered by your warranty. Press any button to unfreeze the picture at any time.

GO BACK Returns you to the previous channel.

GUIDE Brings up the *Channel Guide* menu.

Indicator Indicates the programming mode when programming the remote to control components. The indicator lights up when you press a valid button on the remote. It flickers when the remote batteries are low and you press a button.

Using the Remote Control

Tip

The indicator flashes when the remote batteries are low and you press a button on the remote.

A warning banner may also appear on the screen when you press a remote button and your batteries are low.

Tip

To turn off all the RCA, GE, and Proscan components that are connected to the TV, press ON•OFF twice within two seconds.

This feature only works with most RCA, GE, and Proscan products.

Note:

The DVD and AUX•HD buttons also turn on most RCA, GE, and Proscan products.

INFO Brings up channel banner; press again to clear the screen.

INPUT Press to toggle through the available input sources (VID1, VID2, FRNT, CMP1, CMP2 and DVI. Press the CH+ or CH- button to resume TV viewing).

MENU Brings up the Main menu.

MUTE Reduces the TV's volume to its minimum level. Press again to restore the volume.

OK When in the menu system, selects highlighted items. When watching TV, freezes the picture until you press any button on the remote to resume normal TV viewing. Please note that when you "unfreeze" you go back to live programming (skipping any programming that occurred during the freeze).

ON•OFF When in TV mode, turns the TV on and off. If in another component mode (DVD or AUX•HD) and programmed, will turn the component on and off. When pressed twice within two seconds, the ON•OFF button turns off most RCA, GE and Proscan components.

PIP Press once to bring up the small picture-in-picture window. Press again to bring up the picture-outside-picture (POP) windows. Press to remove POP. (See Chapter 3 for more information about using PIP.)

PIP + or PIP – When using PIP or POP, changes the channel in the picture window.

PRESETS Displays the Picture and Sound preset settings. Use the up and down arrow buttons to highlight either Picture or Sound settings. Use the left and right arrow buttons to change to a different Picture or Sound preset.

REVERSE, PLAY, FORWARD, RECORD, STOP, PAUSE If programmed, provides transport control for some remote-controllable VCRs and DVD players.

SKIP Press once before changing channels and the TV will wait 30 seconds before returning you to the original channel. Press repeatedly to add more time.

TV Turns on the TV and puts the remote in TV mode. Also displays current status.

VOL – or VOL + Decreases or increases the TV's volume.

Using the Remote Control

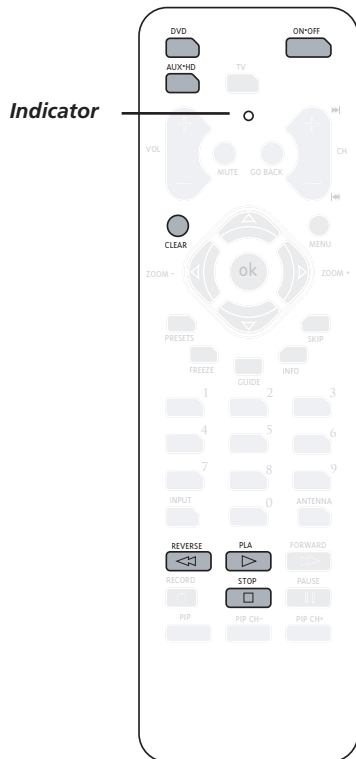

Programming the Remote to Operate Other Components

The universal remote can be programmed to operate most brands of remote controllable components. The remote is already programmed to operate most RCA, GE, and Proscan components.

Also, the AUX•HD button can be programmed to operate most brands of an additional remote-controllable component (such as a VCR, DVD player, satellite receiver or cable box).

Note: The TV button can't be programmed on this remote.

Find Out If You Need to Program the Remote

To determine whether the universal remote needs to be programmed to operate one of the components connected to your TV, such as a DVD player, do the following:

1. Turn on the component (in this example, a DVD player).
2. Point the remote at the component.
3. Press the corresponding component button (in this example, the DVD button).
4. Press ON•OFF to see if the DVD player responds. If the DVD player doesn't respond, you need to program the remote to operate it.

You'll use these buttons when you program the remote.

Important: The remote may not be compatible with all models of all brands of components. It also may not operate all functions of the remote that came with your component.

Programming the Remote

There are two ways to program the remote control:

- automatic code search
- direct entry

Using Automatic Code Search

The following instructions can be used to program the remote to operate each of your components. If you want to stop the automatic code search without programming any of your components, press CLEAR until the indicator on the remote turns off.

Note: The AUX•HD button on this remote is set by default to search for codes for DVD players only. If you want to program it for use with a different component, use the direct entry method.

1. Turn on the component you want to operate (VCR, DVD player, etc.)
2. Press and hold the component button you want to program (DVD or AUX•HD). While holding the component button, press and hold ON•OFF until the indicator on the remote turns on, then release both buttons.
3. Point the remote at the component. Press and release PLAY, then wait 5 seconds or until the indicator on the remote stops flashing.

At this point the remote is searching for the correct code to program. If, after 5 seconds, the component you want to operate does not turn off, press PLAY again to tell the remote to search the next set of codes.

Tip

To stop the automatic code search without programming any components, press and hold CLEAR until the indicator on the remote turns off.

Using the Remote Control

Continue pressing PLAY until the component turns off or the indicator light on the remote turns off. If the indicator light turns off, then all codes for that particular component have been tested once. If the component does not turn off, then the remote can't be programmed to operate that component.

If the component you want to control *does* turn off:

1. Press and release REVERSE, then wait 2 seconds. Repeat this step until the device turns back ON.
2. To finish, press and hold STOP until the indicator on the remote turns off. A code that controls your component has been saved to that remote button.

Important

You must continue pressing the component button while you enter the code.

Let's say you have a Zenith DVD player. To program the universal remote to operate the DVD player, you would:

Press and hold the DVD button while you enter the first code listed for Zenith in the DVD Codes column.

Release the DVD button. Press ON•OFF to see if the DVD player responds. If it doesn't, follow the same steps, but enter the second code for Zenith DVD players instead of the first.

Using Direct Entry

1. Turn on the component to be programmed.
 2. Look up the brand and code number(s) for the component on the code list in this section.
 3. Press and hold the component button you want to program on the remote.
 4. Enter the code from the remote control code list on the following pages. If the indicator flashes, you have either entered an invalid code or the button isn't programmable.
 5. Release the component button, point the remote at the component and then press ON•OFF to see if the component responds to the command. If it doesn't, try pressing the component button and then ON•OFF again.
- If you get no response, repeat these steps using the next code listed for your brand, until the component responds to the remote commands.
 - If you try all the codes for your component brand and none work, try the automatic code search method. If automatic code search doesn't find the code, the remote is not compatible with your component.

Using the Remote Control

Component buttons

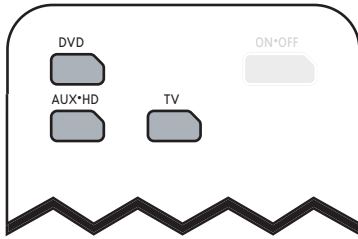

How to Use the Remote After You've Programmed It

Because this universal remote can control several different components (TV, DVD, VCR, satellite receiver, etc.) it uses operational modes triggered by the component buttons. For example, if you want the remote to control the TV, you would press the TV button to put the remote into TV mode before you could control the TV.

1. Press the appropriate component button (DVD or AUX•HD) to set the remote to control the component.
2. Press ON•OFF to turn the component ON or OFF.
3. Use the remote buttons that apply to that component.

Notes:

- *The remote may not be compatible with all brands and models of components. It also may not operate all functions of the remote that came with your component.*
- *If you keep pressing buttons and nothing happens, the remote is probably in the wrong mode. You must press the component button that matches the component you want to operate (i.e., if you want to operate the DVD player, press DVD on the remote control to put the remote in DVD mode.)*

Using the INPUT Button

Use the INPUT button to scroll through the available input channels and view components you have connected to the TV.

1. Press TV to place the remote in TV mode. Make sure the component you want to view is turned ON.
2. Press INPUT to tune to an available input channel.
3. To return to the channel you were previously watching on TV, press CH+ or CH- button.

Remote Control Codes

VCR Codes

Programmable for the AUX•HD button.

Admiral.....	2132
Adventura.....	2026
Aiko.....	2027
Aiwa.....	2026
Akai.....	2003, 2004, 2005, 2007, 2008, 2111, 2112, 2113
American High.....	2021
Asha.....	2013
Audio Dynamics.....	2009, 2010
Audiovox.....	2014
Bell & Howell.....	2011
Beaumarck.....	2013
Broksonic.....	2012, 2025
Calix.....	2014
Candle.....	2013, 2014, 2015, 2016, 2017, 2018, 2019
Canon.....	2021, 2022, 2114
Capehart.....	2020, 2110
Carver.....	2062
CCE.....	2027, 2061
Citizen.....	2013, 2014, 2015, 2016, 2017, 2018, 2019, 2027
Colortyme.....	2009
Colt.....	2061
Craig.....	2013, 2014, 2023, 2061
Curtis-Mathes.....	2000, 2009, 2013, 2016, 2018, 2021, 2022, 2024, 2115, 2131
Cybernex.....	2013
Daewoo.....	2015, 2017, 2019, 2025, 2026, 2027, 2028, 2110
Daytron.....	2110
DBX.....	2009, 2010
Dimensia.....	2000, 2131
Dynatech.....	2026
Electrohome.....	2014, 2029
Electroponic.....	2014
Emerson.....	2012, 2014, 2015, 2021, 2024, 2025, 2026, 2029, 2030, 2031, 2032, 2033, 2034, 2035, 2036, 2037, 2038, 2039, 2040, 2041, 2042, 2044, 2045, 2046, 2047, 2065, 2113, 2116, 2117, 2130
Fisher.....	2011, 2023, 2048, 2049, 2050, 2051, 2052, 2118
Fuji.....	2021, 2119
Funai.....	2026
Garrard.....	2026
GE.....	2000, 2001, 2013, 2021, 2022, 2053, 2115, 2120, 2131
Goldstar.....	2009, 2014, 2018, 2054
Gradiente.....	2026
Harley Davidson.....	2026
Harman Kardon.....	2009
Harwood.....	2061
Headquarter.....	2011
Hitachi.....	2055, 2056, 2057, 2107, 2111, 2120, 2122
Hi-Q.....	2023
Instant Replay.....	2021
JCL.....	2021
JC Penney.....	2009, 2010, 2011, 2013, 2014, 2021, 2022, 2055, 2056, 2058, 2059, 2060, 2107, 2118
Jensen.....	2055, 2056, 2111
JVC.....	2009, 2010, 2011, 2018, 2111, 2123
Kenwood.....	2009, 2010, 2011, 2016, 2018, 2111, 2123
KLH.....	2061
Kodak.....	2014, 2021
Lloyd.....	2026
Logik.....	2061
LXI.....	2014
Magnavox.....	2021, 2022, 2062, 2063, 2104, 2105, 2108, 2124
Magnin.....	2013
Marantz.....	2009, 2010, 2011, 2016, 2018, 2021, 2062, 2064
Marta.....	2014
Masushita.....	2021
Mei.....	2021
Memorex.....	2011, 2013, 2014, 2021, 2023, 2026, 2104, 2132
MGA.....	2029, 2065, 2113
MGN Technology.....	2013
Midland.....	2053
Minolta.....	2055, 2056, 2107
Mitsubishi.....	2029, 2055, 2056, 2065, 2066, 2067, 2068, 2069, 2070, 2071, 2072, 2073, 2074, 2106, 2113, 2123
Montgomery Ward.....	2075, 2132
Motorola.....	2021, 2132
MTC.....	2013, 2126
Multitech.....	2013, 2016, 2026, 2053, 2061
NEC.....	2009, 2010, 2011, 2016, 2018, 2064, 2076, 2078, 2079, 2111, 2123
Nikko.....	2014
Noblex.....	2013

Olympus.....	2021
Optimus.....	2014, 2132
Optonica.....	2096
Panasonic.....	2021, 2022, 2109, 2125, 2126, 2127
Pentax.....	2016, 2055, 2056, 2107, 2120
Pentax Research.....	2018
Philco.....	2021, 2022, 2062, 2063
Philips.....	2021, 2062, 2096, 2124
Pilot.....	2014
Pioneer.....	2010, 2055, 2080, 2081, 2123
Portland.....	2016, 2017, 2019, 2110
Proscan.....	2000, 2001, 2131
Protec.....	2061
Pulsar.....	2104
Quarter.....	2011
Quartz.....	2011
Quasar.....	2021, 2022, 2125
RCA.....	2000, 2001, 2003, 2013, 2021, 2055, 2056, 2082, 2083, 2084, 2085, 2086, 2087, 2088, 2089, 2090, 2091, 2107, 2115, 2120, 2125, 2131, 2133
Radioshack/Realistic.....	2011, 2013, 2014, 2021, 2022, 2023, 2026, 2029, 2049, 2050, 2096, 2132
Radix.....	2014
Randex.....	2014
Ricoh.....	2128
Runco.....	2104
Samsung.....	2005, 2013, 2015, 2033, 2053, 2112
Sanky.....	2104, 2132
Sansui.....	2010, 2092, 2111, 2123
Sanyo.....	2011, 2013, 2023
Scott.....	2012, 2015, 2025, 2032, 2038, 2065, 2093, 2116
Sears.....	2011, 2014, 2021, 2023, 2048, 2049, 2050, 2051, 2055, 2056, 2107, 2118
Sharp.....	2017, 2029, 2094, 2095, 2096, 2097, 2132
Shintom.....	2004, 2056, 2061, 2098
Shogun.....	2013
Signature.....	2132
Singer.....	2021, 2061, 2128
Sony.....	2004, 2098, 2099, 2119
STS.....	2021, 2107
Sylvania.....	2021, 2022, 2026, 2062, 2063, 2065, 2124
Symphonic.....	2026
Tandy.....	2011
Tashiko.....	2014
Tatung.....	2111
TEAC.....	2026, 2085, 2111
Technics.....	2021, 2109
Teknika.....	2014, 2021, 2026, 2100, 2129
TMK.....	2013, 2024, 2047
Toshiba.....	2015, 2049, 2051, 2055, 2065, 2093, 2116
Totevision.....	2013, 2014
Unitech.....	2013
Vector Research.....	2009, 2010, 2015, 2016
Victor.....	2010
Video Concepts.....	2009, 2010, 2015, 2016, 2113
Videosonic.....	2013
Wards.....	2013, 2014, 2015, 2021, 2023, 2026, 2029, 2055, 2056, 2061, 2096, 2101, 2102, 2103, 2107, 2116, 2132
XR-1000.....	2021, 2026, 2061
Yamaha.....	2009, 2010, 2011, 2018, 2111
Zenith.....	2004, 2098, 2104, 2119, 2128

DVD codes

Programmable for the DVD and AUX•HD buttons.

Aiwa.....	3009
Apex.....	3023, 3024
GE.....	3000
Hitachi.....	3008
JVC.....	3002, 3010
Konka.....	3011, 3012
Magnavox.....	3003
Mitsubishi.....	3004
Panasonic.....	3013
Philips.....	3003, 3019, 3021, 3022
Pioneer.....	3005
Proscan.....	3000
RCA.....	3000, 3001
Samsung.....	3025
Sanyo.....	3014
Sony.....	3006, 3015, 3016
Toshiba.....	3007, 3017, 3020
Zenith.....	3018

Cable Box Codes

Programmable for the AUX•HD button.

ABC.....	5002, 5003, 5004, 5006, 5053
Antronix.....	5008, 5009
Archer.....	5008, 5009, 5010
Cabletenna.....	5008
Cableview.....	5008
Colour Voice.....	5012, 5013
Comtronic.....	5014
Contec.....	5016
Eastern.....	5017
GC Electronics.....	5009
GE.....	5000, 5001
Gemini.....	5018, 5019
General Instrument.....	5003
Hamlin.....	5020, 5021, 5022, 5028, 5035, 5045
Hitachi.....	5003
Jerrold.....	5003, 5018, 5023, 5024, 5046, 5053
Magnavox.....	5025
Memorex.....	5026
Movie Time.....	5027
NEC.....	5005
NSC.....	5027
Oak.....	5016, 5029
Panasonic.....	5048, 5052
Philips.....	5011, 5012, 5013, 5015, 5019, 5025, 5030, 5031, 5032
Pioneer.....	5033, 5034
Proscan.....	5000, 5001
RCA.....	5007, 5047, 5049, 5052
Realistic.....	5009
Regal.....	5022, 5035
Regency.....	5017
Rembrandt.....	5003
Samsung.....	5034
Scientific Atlanta.....	5006, 5036, 5037, 5038
Signal.....	5018
Signature.....	5003
Sprucer.....	5052
Standard Components.....	5039, 5044
Starcom.....	5018, 5053
Stargate.....	5018
Starquest.....	5018
Tocom.....	5004, 5023
Tusa.....	5018
TV86.....	5027
Unika.....	5008, 5009
United Cable.....	5053
Universal.....	5008, 5009, 5010
Viewstar.....	5025, 5027
Zenith.....	5050, 5051

Satellite Receiver Codes

Programmable for the AUX•HD button.

Alphastar.....	5079
Chapparral.....	5056, 5057
Dishnet.....	5078
Drake.....	5058, 5059
Echostar.....	5089
GE.....	5000 (SAT1), 5001 (SAT2)
General Instruments.....	5060, 5061, 5062
Hitachi.....	5083, 5084
Hughes Network.....	5077, 5090
JVC.....	5082
Panasonic.....	5075
Philips.....	5085
Primestar.....	5076
Proscan.....	5000 (SAT1), 5001 (SAT2)
RCA.....	5000 (SAT1), 5001 (SAT2), 5071, 5080, 5081
Realistic.....	5063
Sony.....	5072
STS1.....	5064
STS2.....	5065
STS3.....	5066
STS4.....	5067
Toshiba.....	5068, 5073
Uniden.....	5069, 5086

HDTV Tuner Codes

Programmable for the AUX•HD button.

RCA.....	7000
----------	------



Using the TV's Features

Channel Banner

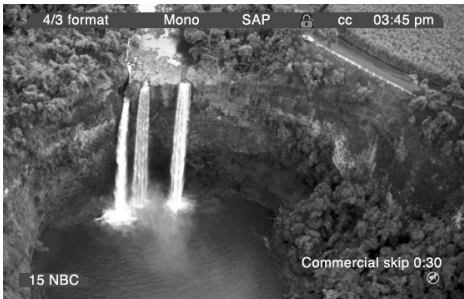
There are several indicators that might appear when you press the TV or INFO button on the remote. This display is called the Channel Banner. The following list describes the items on the Channel Banner screen (left to right and top to bottom).



Sample displays on a Channel Banner.

4/3 format	Current screen format.
Mono (or Stereo)	<i>Mono</i> appears when the current channel is broadcasting in mono. <i>Stereo</i> appears when the current channel is broadcasting in stereo.
SAP	The current channel is broadcasting SAP (Second Audio Program) information.
	Parental Controls are locked.
CC	Closed Captioning is available on the current channel.
03:45 pm	Current time.
15 NBC	Current channel and label assigned to the channel.
Commercial skip 0:30	Shows the time remaining on the commercial skip (SKIP) timer.
	Sound is muted.

Autotuning

The autotuning feature automatically tunes the TV to the correct channel/input for different components you have connected to your TV (like a VCR, DVD Player, etc.) When you set up autotuning in the menu system you don't have to remember to change your TV to the VID1 input, for example, when you want to watch a DVD on your DVD player.

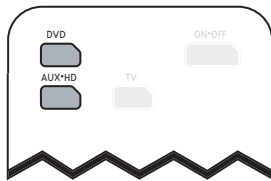

Your remote's component buttons

Why You Should Use the Autotuning Feature

With the autotuning feature, you can set up the TV to tune to the channel/input you need to watch by pressing that component's button.

How to Set Up the Autotuning Feature

The way you set up the autotuning feature in the TV's menu corresponds to the component buttons on the remote and the way you have each component connected to your TV. When you set up autotuning, you're telling the TV what channel/input to tune to when you press the DVD or AUX•HD button on the remote control.

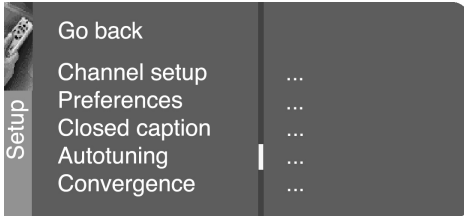

1. Press MENU (the MAIN MENU appears).
2. Highlight *Setup* and press OK on your remote control.
3. Highlight *Autotuning* and press OK.
4. Choose which component button you would like to set:

Set DVD Channel Lets you set up the channel the TV tunes to when you press the VCR button.

Set AUX/HD Channel Lets you set up the channel the TV tunes to when you press the AUX/HD button.

5. Press the right arrow button to select the choice that matches the way you have the component connected to this TV, and press OK.

You can select from the following inputs or channels:

N/A Choose this if you don't have this particular component connected to the TV, or if you don't want the TV to automatically tune to the correct channel/input when you're using this component.

Channel 3 or 4 Component is connected to the CABLE/ANTENNA jack on the back of the TV, and you want the TV to tune to channel 3 when you press the corresponding button on the remote. Reminder: make sure the component's Channel 3/4 switch is set to channel 3.

VID1 or VID2 (Video Input) Component is connected to a VIDEO or S-Video jack on the back of the TV and you want the TV to tune to a VID input channel when you press the corresponding component button.

FRNT (Front Video Input) Component is connected to the VIDEO jack on the front of the TV and you want the TV to tune to the front VID input channel (FRNT) when you press the corresponding component button.

CMP1 or CMP2 (Component Video Input) Compatible component video source, such as a DVD player or digital TV converter box, is connected to the three COMPONENT VIDEO INPUT jacks (Y,PB,PR) on the back of the TV and you want the TV to tune to the component video input channel (CMP) when you press the corresponding component button.

DVI Component is connected to the DVI-HDCP jack on the back of the TV and you want the TV to tune to the DVI input channel when you press the corresponding component button.

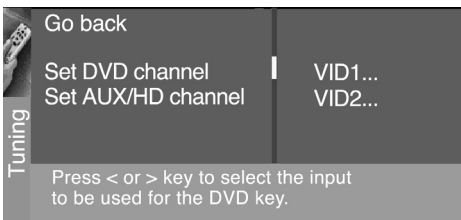

Using the TV's Features

Parental Controls and V-Chip

The choices in the *US V-CHIP* and *Canada V-CHIP* menus involve software inside your TV (referred to as V-Chip) which allows you to block TV programs and movies based on violence, sex, or other content you may believe children should not view.

Once you block programs, you can unblock programs by entering a password.

By default, the software inside your TV is turned “off.” For instructions to turn on V-Chip, go to page 31.

Note: Parental Control settings are not available for DVI, CMP1, or CMP2 inputs.

How V-Chip Works for USA and Canada

V-Chip reads the program's age-based rating (TV-MA, TV-14, etc.) and content themes [(Violence (V), Adult Language (L), etc.)]. If you have blocked the rating and/or content themes that the program contains, you will receive the message *This channel has not been approved for viewing. Change channel or press OK to enter password and temporarily deactivate the Parental Control.*

Broadcasters are not required to provide content themes, so programs received with no content themes will only be blocked if you block their age-based rating. You can also block out programs that have been given an Exempt rating, and programs that are considered unrated. The next several pages have tables showing the TV age-based ratings and content themes for the US and Canada.



US V-Chip TV Rating Limit

The V-Chip TV Rating Limit lets you decide which TV programs can and cannot be viewed.

To set TV programming limits:

1. Choose *Parental Control* from the MAIN MENU. If Parental Controls have previously been locked, you must enter your password.
2. Highlight and select *US V-Chip*. Then select *V-Chip TV Rating*.
3. Once you get to the *V-Chip TV rating limit* screen, use the arrow buttons and OK on your remote to change the status of a TV program rating or content theme from *View* to *Block*.
4. For TV rating limits to take effect, lock Parental Controls by accessing the *Lock parental controls* menu.

The following sections give you more details about how to change the status of TV program limits.

Note: If you forget your password, follow step one above to get to the password entry screen. Then press the VOL+ and CH+ buttons on the TV's front panel at the same time for at least 8 seconds. You will receive an on-screen message that Parental Controls have been unlocked once you've successfully reset the password.

The V-Chip Rating Screen

The following is an example of where items are located within the Rating Limit screen.

Rating Status Field
Lets you select whether the status of the age-based rating limit to the left is View or Block.

Rating Field
Lets you select from a list of age-based ratings you can block or view.

Content Themes
Lists the content themes you can block or view.

Content Status Fields
Lets you select which content themes to view for the selected rating, and whether the status of the content theme is currently unlocked (🔓) or locked (🔒).

Rating Settings Area
Lets you see the current block/view state of age-based ratings and associated content. The View (🔓) settings are coded in green, and the Block (🔒) settings are coded in red.

Age-Based Rating	USA Description and Content Themes for Age-Based Ratings
TV-MA	Mature Audience Only. Specifically designed to be viewed by adults and may be unsuitable for children under 17. It contains one or more of the following content themes: crude indecent language (L), explicit sexual activity (S), or graphic violence (V).
TV-14	Parents Strongly Cautioned. Contains some material that many parents would find unsuitable for children under 14. Parents are strongly urged to exercise greater care in monitoring this program and are cautioned against letting children under the age of 14 watch unattended. This program contains one or more of the following content themes: intensely suggestive dialogue (D), strong coarse language (L), intense sexual situations (S), or intense violence (V).
TV-PG	Parental Guidance Suggested. Contains material that parents may find unsuitable for younger children. Many parents may want to watch it with their younger children. The program contains one or more of the following content themes: some suggestive dialogue (D), infrequent coarse language (L), some sexual situations (S), or moderate violence (V).
TV-G	General Audience. Most parents would find this program suitable for all ages. It contains little or no sexual dialogue (D) or situations (S), no strong language (L), and little or no violence (V).
TV-Y7	Directed to Children 7 years and older. Designed for children ages 7 and above. It may be more appropriate for children who have acquired the developmental skills needed to distinguish between make-believe and reality. Themes and elements in this program may include mild fantasy violence (FV) or comedic violence, or may frighten children under the age of 7.
TV-Y	All Children. Themes and elements in this program are designed for a young audience, including children from ages 2-6. It is not expected to frighten younger children.

Using the TV's Features

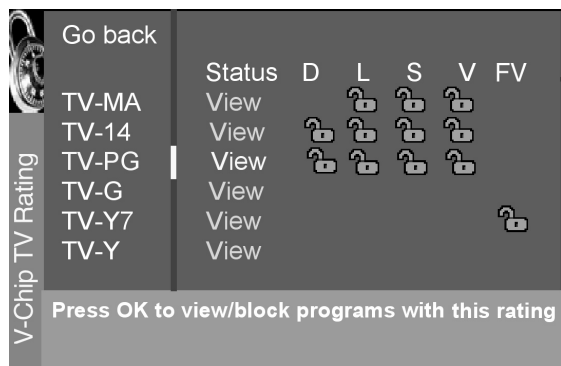

Blocking Age-Based Ratings

You can automatically block all program ratings above a specified age-based rating level. To block programs with higher ratings:

1. Press the up or down arrow button to scroll to the rating corresponding with the lowest rating you do not want the child to watch.
2. Press the OK button to toggle between *View* and *Block*. The status for the rating listed to the left and all higher ratings automatically changes to *Block* (and).
3. Use the up/down arrow buttons to highlight *Go back* and press OK.
4. Select *Lock Parental Controls* from the *Parental Control* menu for rating limits to take effect.

Hierarchy of Age-Based Ratings	
TV-MA	<i>Mature Audience Only</i>
TV-14	<i>Parents Strongly Cautioned</i>
TV-PG	<i>Parental Guidance Suggested</i>
TV-G	<i>General Audience</i>
TV-Y7	<i>Directed to Children 7 years and older</i>
TV-Y	<i>All Children</i>

Viewing Age-Based Ratings

After you block age-based ratings, you can change some of the ratings back to *View*.

1. Use the up/down arrows to select the rating with a status of *Block*.
2. Press OK to select *View*.

Content Themes	
D	<i>Sexually explicit dialogue</i>
L	<i>Adult language</i>
S	<i>Sexual situations</i>
V	<i>Violence</i>
FV	<i>Fantasy Violence</i>

Blocking Specific Content Themes

You can block programs based on their content. (Content is represented by the D, L, S, V and FV on your screen.) When you block a content theme for a particular rating, you automatically block that content theme for higher rated programs as well.

To block program content:

1. Determine the content themes you want to block.
2. Press the down arrow button to scroll to the rating whose content theme you want to change.
3. Press the right arrow button to move the yellow highlight to a particular content theme status.
4. Press the OK button to change its status to . (In the example to the left, you block the language (L) corresponding with TV-14. The language for TV-MA is blocked as well.)

Notes: *Broadcasters are not required to provide content themes or age-based ratings.*

You must remember to lock Parental Controls for rating limits to take effect.

Tip

To change all V-Chip movie or TV ratings to *View*, press the 0 number button.

Viewing Specific Content Themes

If you block specific content themes, you have the option of going back and changing some of the them back to (🔒) View:

1. Determine the content themes you want to change to (🔒) View.
2. Press the down arrow button to scroll to the rating whose content theme you want to change, such as 🔒 under language (L) corresponding with TV-14.
3. Press the right arrow button to move the yellow highlight to a particular content theme status.
4. Press the OK button to change the status back to 🔒. Your child would then be able to watch programs with the TV-14 adult language content, but not programs with TV-MA language content.

Note: Only the content theme status corresponding to TV-14 (L) language changes to (V) View. Higher rated content themes, such as that for TV-MA language, do not change.

Canada V-Chip Ratings

Canadian TV V-Chip supports two different Canadian rating systems: English and French.

Rating	Canadian English V-Chip Rating System
18+	Adults. Programming intended for adults 18 and older. It may contain elements of violence, language, and sexual content which could make it unsuitable for viewers under 18. Violence Guidelines: May contain violence integral to the development of the plot, character or theme, intended for adult audiences. Other Content Guidelines: May contain graphic language and explicit portrayals of nudity and/or sex.
14+	Viewers 14 and over. Programming contains themes or content which may not be suitable for viewers under the age of 14. Parents are strongly cautioned to exercise discretion in permitting viewing by pre-teens and early teens. Violence Guidelines: May contain intense scenes of violence. Could deal with mature themes and societal issues in a realistic fashion. Other Content Guidelines: May contain scenes of nudity and/or sexual activity. There could be frequent use of profanity.
PG	Parental Guidance. Programming intended for a general audience but which may not be suitable for younger children (under the age of 8). Parents may consider some content inappropriate for unsupervised viewing by children aged 8-13. Violence Guidelines: Depictions of conflict and/or aggression will be limited and moderate; may include physical, fantasy, or supernatural violence. Other Content Guidelines: May contain infrequent mild profanity, or mildly suggestive language. Could also contain brief scenes of nudity.
G	General Audience. Programming considered acceptable for all ages groups. While not designed specifically for children, it is understood younger viewers may be part of the audience. Violence Guidelines: Will contain very little violence, either physical or verbal or emotional. Will be sensitive to themes which could frighten a younger child, will not depict realistic scenes of violence which minimize or gloss over the effects of violent acts. Other Content Guidelines: There may be some inoffensive slang, no profanity and no nudity.
C8+	Children 8 and older. Programming generally considered acceptable for children 8 years and over to watch on their own. Violence Guidelines: Violence will not be portrayed as the preferred, acceptable, or only way to resolve conflict or encourage children to imitate dangerous acts which they may see on television. Any realistic depictions of violence will be infrequent, discreet, of low intensity and will show the consequences of the acts. Other Content Guidelines: There will be no profanity, nudity or sexual content.
C	Children. Programming intended for children under age 8. Violence Guidelines: Careful attention is paid to themes which could threaten children's sense of security and well being. There will be no realistic scenes of violence. Depictions of aggressive behavior will be infrequent and limited to portrayals that are clearly imaginary, comedic or unrealistic in nature. Other Content Guidelines: There will be no offensive language, nudity or sexual content.

Using the TV's Features

Rating	Canadian French V-Chip Rating System
18 ans +	Adults. Programming is for adults only. This program contains sustained violence or extremely violent scenes.
16 ans +	Viewers 16 and over. Programming is not suitable for those under age 16. This program contains frequent scenes of violence or intensely violent scenes.
13 ans +	Viewers 13 and over. Programming may not be suitable for children under the age of 13. This program either contains several violent scenes or one or more scenes that are violent enough to affect them. Viewing in the company of an adult is therefore strongly recommended for children under the age of 13.
8 ans +	Viewers 8 and over. Not recommended for young children. This program is suitable for most audiences, but it contains mild or occasional violence that could upset young children. Viewing in the company of an adult is therefore recommended for young children (under the age of 8) who do not distinguish between reality and imagination. Programming generally considered acceptable for children 8 years and over to watch on their own. Violence Guidelines: Violence will not be portrayed as the preferred, acceptable, or only way to resolve conflict or encourage children to imitate dangerous acts which they may see on television. Any realistic depictions of violence will be infrequent, discreet, of low intensity and will show the consequences of the acts. Other Content Guidelines: There will be no profanity, nudity or sexual content.
G	General Audience. This program is suitable for audiences of all ages. It contains no violence, or any violence that it does contain is either minimal or is presented in a humorous manner, as a caricature, or in an unrealistic way.

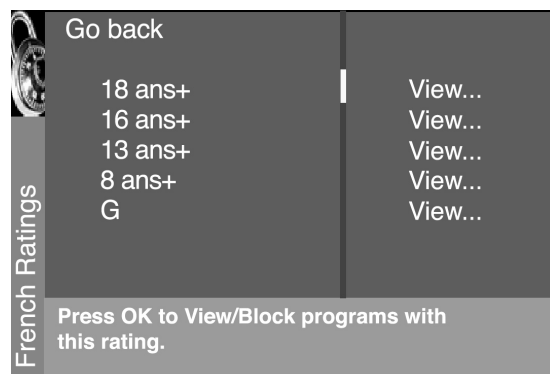
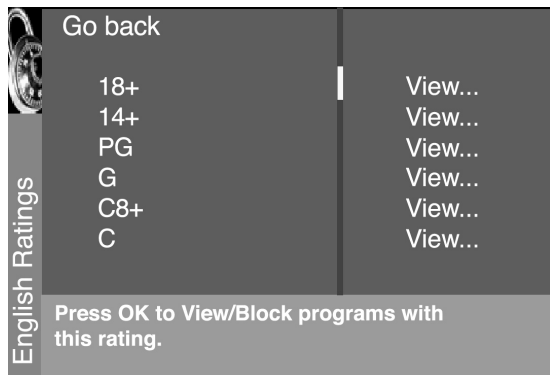

Blocking Canadian V-Chip Ratings

If you receive Canadian programs you can block Canadian English and French V-Chip by ratings only. When you block a particular rating, you automatically block the higher rated programs as well.

To block Canadian English and French program ratings:

1. Select *Canada V-Chip* from the *Parental Control* menu.
2. Highlight *English ratings* or *French ratings* and press OK.
3. Determine the rating you want to block.
4. Press the down arrow button to scroll to the rating you want to change.
5. Press the OK button to change its status to block (the lock icon appears and all ratings above the one you selected change to lock).

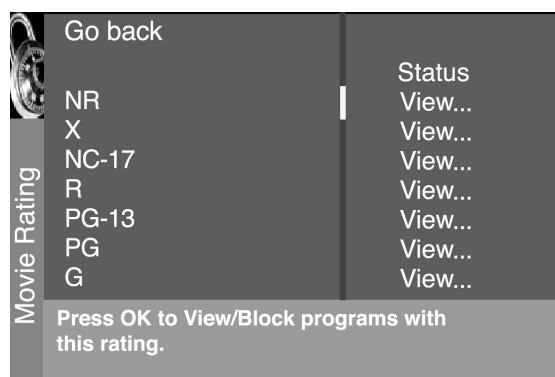

V-Chip Movie Rating Limit

Set movie rating limits by blocking movies rated above a specified level.

To access the Movie Rating Limit menu:

1. Press **MENU** on the remote control (the TV's *MAIN MENU* appears).
2. Select *Parental Control*.
3. Select *US V-Chip*.
4. Select *V-Chip movie rating*.

Blocking Movie Ratings

Once you are in the Movie Ratings menu, follow the same steps described for blocking TV ratings.



Blocking Unrated/Exempt Programs

The *Unrated/Exempt Prog.* option lets you decide if programs that the V-Chip recognizes as unrated can be viewed. Unrated TV programs may include news, sports, political, religious, local and weather programs, emergency bulletins, public announcements, and programs without ratings. The Exempt option applies to both USA and Canadian unrated programs and Canadian programs rated *E*.

View All unrated programs are available.

Block All unrated programs are not available.

Note: You must remember to activate V-Chip for rating limits to take effect.

Press the down arrow to highlight *Unrated/Exempt Prog.* Then press the right arrow to toggle between *View* and *Block*.

Lock/Unlock Parental Controls

Selecting this option lets you lock and unlock parental controls settings using a password.

If you do not lock parental controls, none of the settings for V-Chip, Channel Block, or Front Panel Block will take effect.

If you forget your password, press the **MENU** button, then select *Parental Control* (the password entry screen appears). Simultaneously press and hold **CH+** and **VOL+** on the front panel for 8 seconds. Parental Controls unlock and the *Parental Control* menu appears. You can enter a new password by locking the Parental Controls again.

Front Panel Block

Selecting this option lets you block (disable) or unblock (enable) the TV's front panel. The remote still tunes to any channel. When using this as a Parental Control method, remove access to any remote that is capable of operating the television while you have the front panel blocked.

Don't forget to lock parental controls after you change the status. If you don't, the front panel block will not take effect.

Using the TV's Features



PIP example



POP example

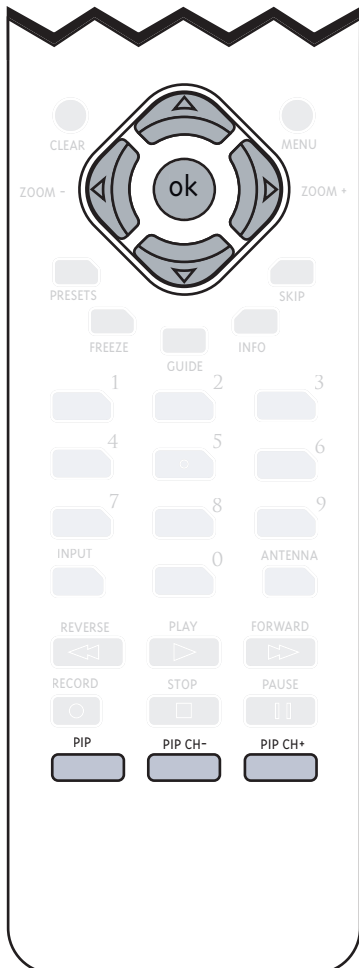

PIP (Picture-in-Picture) and POP (Picture-outside-Picture) Operation

The PIP (picture-in-picture) feature lets you display a second, smaller picture on top of the main picture. POP (picture-outside-picture) lets you display two windows side by side.

Note: PIP and POP are not available for DVI or component video sources (CMP1 or CMP2).

PIP and POP Buttons

There are several remote buttons that control the way the PIP window works:

PIP Brings up the PIP window. Press again to bring up POP. Press again to remove the window.

Up and down arrow buttons Let you move the PIP window to different corners of the screen. Up arrow moves PIP counterclockwise; down arrow moves PIP clockwise.

Left and right arrow buttons Switches the main POP window, where the sound is coming from, with the other window.

PIP + and PIP - Lets you change channels in the PIP and right POP window.

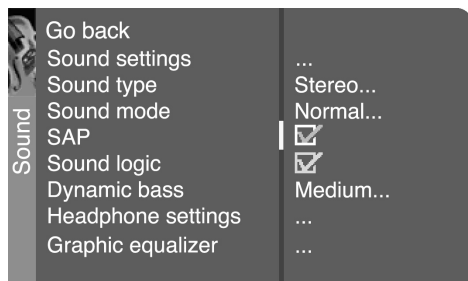

Sound Menu

The Sound menu lets you adjust audio output. To access the Sound menu, press MENU on the remote, and then select *Sound* from the main menu. The following audio items can be adjusted: *Sound settings*, *Sound type*, *Sound mode*, *SAP*, *Sound Logic*, *Dynamic bass*, *Headphone settings*, and *Graphic equalizer*.

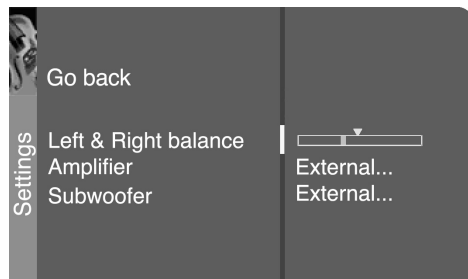

Sound settings The *Sound settings* submenu contains the following items:

Left & Right balance Use the left or right arrow to center the bar under the arrow to balance the left and right speakers.

Amplifier Use the left or right arrow button to select *External* (if your TV is using external amplifier only) or *Internal* (if your TV is using the speakers in the TV).

Subwoofer Select *External* if the TV is using an external subwoofer, or *None* if the TV is not using a subwoofer.

Sound type Press the right arrow button to scroll through the available audio types, which control the way the sound comes through your speakers. The options available vary according to the input selected.

Mono (available for regular TV viewing only) Plays the sound in mono only. Use this setting when receiving broadcasts with weak stereo signals.

Stereo Splits the incoming stereo audio signal into left and right channels. Most TV programs and recorded materials have stereo audio. The word *Stereo* appears in the channel banner when you tune to a program that is broadcast in stereo.

Automatic (available for regular TV viewing only) Chooses the sound type according to the current signal.

Left and Right (available for audio/video inputs only) Isolates either the left or right channel of the incoming audio.

Sound Mode Press the right arrow button to scroll through the available audio modes, which provides special processing through your speakers (depending on the setting you chose as your *Sound type*).

Normal Does not give any special processing, simply provides the mono or stereo sound provided by the signal you're watching.

Wide Available only for mono signals. "Widens" sound from mono broadcasts and mono components connected to your TV for a fuller, more spacious sound.

Magic Available only for stereo signals. Gives a surround effect with more bass.

Second Audio Program (SAP) Plays the program's audio in a second language, if one is available. The letters "SAP" appear in the channel banner when you tune to a program that is broadcast with SAP information. SAP audio is broadcast in mono. SAP is also used to broadcast a program's audio with descriptions of the video for the visually impaired.

Continues on next page...

Using the TV's Menu System

Sound logic Reduces the annoying blasts in volume during commercial breaks, and also amplifies softer sounds in program material. Eliminates the need to constantly adjust the volume.

Dynamic bass Enhances your TV's low-frequency response. The options are *Off*, *Medium* and *High*.

Headphone settings Displays a choice list of available settings you can adjust: *Volume*, *Bass* and *Treble*. The *Headphone sound* option allows you to choose stereo, mono or automatic. These descriptions are same as for *Sound Type* (see the previous page).

Graphic equalizer Allows you to choose a specific preset through the Sound Preset option. Press the right arrow to cycle through the options: *Standard*, *Movie*, *Voice*, *Music*, *Flat*, *Videogame*, *Video camera* and *Personal*.

The Frequency range displays the different treble and bass bands set for each Sound Preset option. You can choose a band and make adjustments. When you make adjustments, the Sound Preset option automatically changes to *Personal*. Press the left or right arrow button to select the frequency (Bass 100Hz, Mid Bass 500Hz, Medium 1.5kHz, Mid Treble 5kHz, Treble 10kHz) you want to adjust. Then use the up or down arrow button to adjust the level.

To view the frequency range of another *Sound Preset* option, press the right or left arrow until no band is selected and *Frequency range* is highlighted. Then press the up arrow to highlight *Sound Preset*.

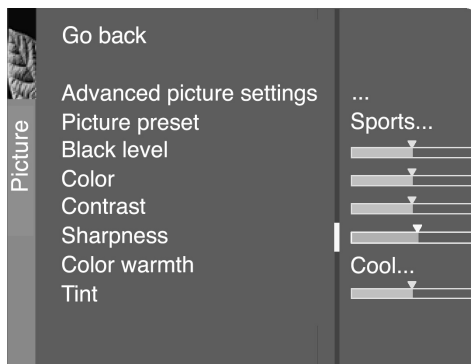
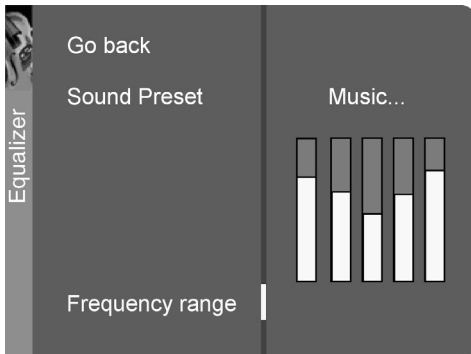

Picture Menu

The *Picture* menu contains menus and controls to configure the following video settings: *Advanced picture settings*, *Picture presets*, *Black level*, *Color*, *Contrast*, *Sharpness*, *Color Warmth*, and *Tint*. The *Picture* menu options apply to the video for the main TV and video input selections.

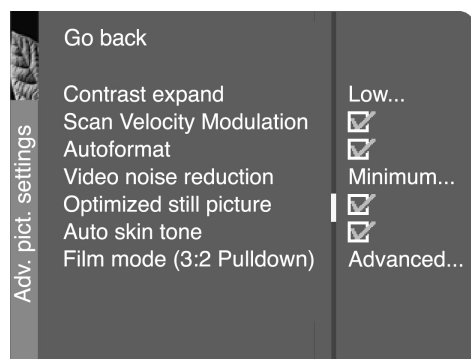

Advanced picture settings

Contrast expand You can adjust the contrast of the picture to suit the light of the room. Press the right arrow to choose which of the following best describes the lighting in the room: *Low*, *Medium* or *High*.

Scan Velocity Modulation Improves the sharpness of the picture by changing the speed of the cathode-ray tube's electron beam when it transitions between dark and light areas of the screen. Choose to have it on (box checked) or off (box unchecked), depending on your preference.

Autoformat When enabled (box checked) the TV automatically detects the screen format the signal is sending for each channel, as well as input channels.

Tip:

If the picture is switching screen formats abruptly during normal TV viewing, switch the *Autoformat* feature off.

Using the TV's Menu System

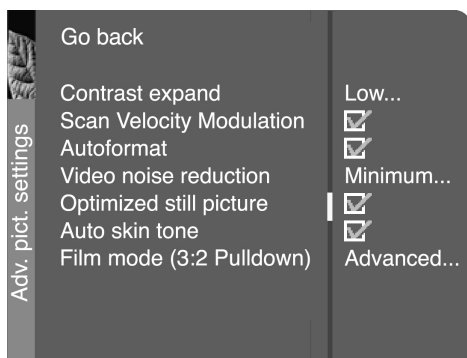

Video noise reduction Reduce picture “static” or any type of interference. This feature is especially useful for providing a clearer picture in weak analog signal conditions. Press the right arrow to choose between: *Off* for no noise reduction; *Minimum* for a softer, smoother picture that retains picture sharpness and detail; *Medium* for a slightly softer picture than the *Minimum* setting; *Maximum* for an even softer, smoother picture than the other settings (the picture detail is somewhat decreased).

Optimized still picture When enabled (box checked), enhances the picture specifically for still frames (for example, if you're watching a slideshow on your HDTV monitor, or if you've paused a frame of a DVD).

Auto Skin Tone When enabled (box checked), minimizes the flesh tone variations of the TV picture.

Film mode (3:2 Pulldown) Automatically detects video sources that were originally recorded on film (like most movies) and subsequently converted to a different format (for TV broadcast, for example). Film mode processes the converted signal so that it looks as close as possible to the original. Another name for this process is reverse 3:2 pulldown.

Advanced (recommended) enables the feature only when the TV detects that movie playback quality could be improved. *Advanced* is the default setting.

The *On* setting should only be used in rare circumstances when the TV is used solely with film-based sources (like DVDs on a non-progressive-scan player).

The *Off* setting turns off film mode upconversion. Try using this setting if you think the reverse 3:2 pulldown is causing distortions in your picture.

Note: *Autoformat* and *Video noise reduction* are available for *CMP1* and *CMP2* inputs only if the signal is 480i.

Picture Presets Displays a choice list that lets you select one of the preset picture settings: *Vibrant*, *Cinematic*, *Natural*, *Sports*, *Videogame*, *Video Camera* or *Personal*. Choose the setting that is best for your viewing environment. You can set a different picture preset for each input (including one for your regular TV channels).

Black Level Adjusts the brightness of the picture.

Color Adjusts the richness of the color.

Contrast Adjusts the difference between the light and dark areas of the picture.

Sharpness Adjusts the crispness of the edges in the picture.

Note: You can adjust sharpness for each channel and input. This is useful if the signal appears fuzzy.

Color Warmth Displays a choice list that lets you set one of three automatic color adjustments: *Cool* for a more blue palette of picture colors; *Normal*; or *Warm* for a more red palette of picture colors. The warm setting corresponds to the NTSC standard of 6500 K.

Tint Adjusts the balance between the red and green levels.

When you change any of these picture settings, the *Picture Preset* changes to *Personal*. Use the left or right arrow button to make adjustments. To return to the *Picture* menu, press the up or down arrow button.

Tip:

You can select a different picture preset (or set up a different personal preset) for each input. The ANTENNA/CABLE jack counts as a single input.

Using the TV's Menu System

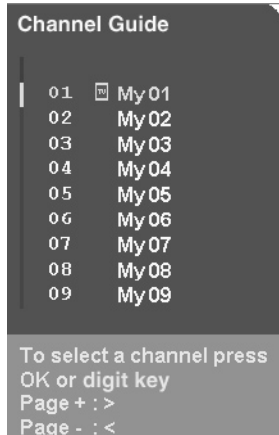

Channel Guide Menu

Allows you to view and select from the entire channel list and their labels. Press the GUIDE button to bring up the Channel Guide menu. Use the up or down arrow to scroll through the list. Press OK to select and tune to the highlighted channel. Press the last digit of one of the channels in the guide to tune to that channel and leave the Channel Guide on the screen.

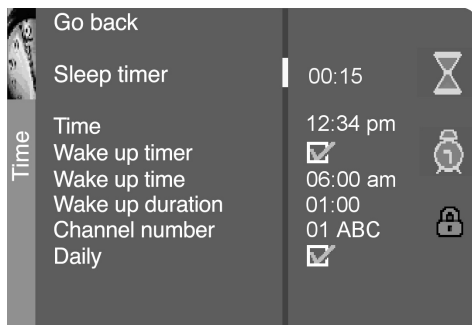

Time Menu

Sleep Timer Lets you set the TV to turn off after a given amount of time.

Time Lets you enter the current time. If it is eight o'clock, for example, you must first enter the number zero, then number eight. Use the OK button to choose between AM and PM.

Wake up timer Lets you set the TV to turn itself on. When you turn on Wake up timer, the following options appear:

Wake up time Lets you set the time you want the TV to turn itself on.

Wake up duration Lets you set how long you want the TV to stay on when it turns on.

Channel number Lets you select a specific channel the TV tunes to when the wake up timer is set.

Daily Lets you choose if you want the wake up timer to turn on daily.

Note: The Wake up timer is available only when the time has been set.

Parental Control Menu

The Parental Control Menu was explained in Chapter 3. Go to page 26 for more information.

Using the TV's Menu System

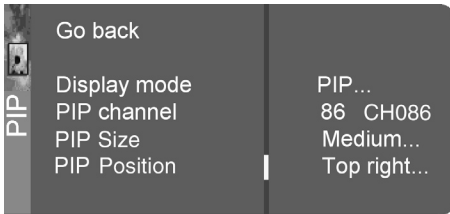

PIP Menu

Display Mode

Off No window is displayed.

PIP PIP window is displayed.

POP POP window is displayed.

PIP channel Allows you to choose the channel displayed in the PIP or main POP window. Scroll through channel list as well as the VID1, VID2 and FRNT input channels.

PIP size Allows you to choose the size of the PIP window: *Small*, *Medium* or *Large*.

PIP position Allows you to choose where the PIP window appears on the screen: *Top right*, *Top left*, *Bottom right* or *Bottom left*.

Note: Pip size and position are not available for POP.

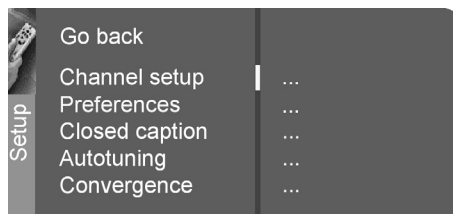

Setup Menu

The Setup menu lets you configure the TV to fit its surroundings and your preferences. To access the *Setup* menu, press MENU on the remote, and then select *Setup* from the main menu.

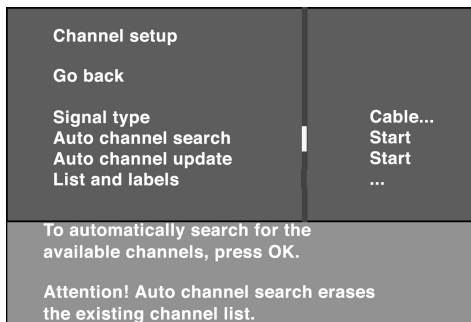

Channel setup

Signal Type The TV chooses the signal type during the initial setup. If you change how you receive broadcasts through the antenna input, you must change the *Signal type* setting. Choose *Cable* if you are using cable or a cable box for TV signals. Choose *UHF/VHF Antenna* if you are using an off-air antenna for TV signals.

Auto channel search Searches for channels the signal is receiving. Go to page 16 for more information.

Auto channel update Searches for any new channels that are not in your channel list and adds them to the list.

List and labels Edit the channels in the list or choose labels for each channel. Go to page 17 for more information.

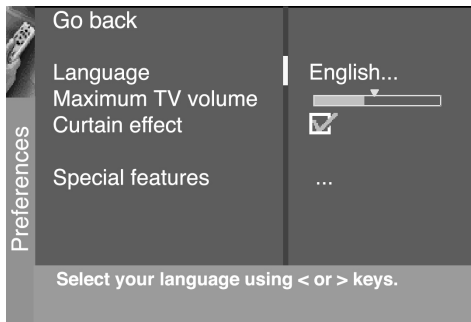

Preferences

Language Displays a choice list that lets you select your preferred language for the menus: *English*, *Español* or *Français*.

Maximum TV volume Allows you to set how high volume turns up when you press the VOL+ button. Highlight *Maximum volume*, then press and hold OK to hear the maximum volume. Make sure the volume has not been muted or turned down all the way.

Continues on next page...

Using the TV's Menu System

Short-term vs. Long-term Power Outages

The *Auto channel* and *Auto volume* settings don't take effect after short-term power outages (usually less than two to three minutes). The TV will turn back on at the same volume and channel as before the power outage.

The *Auto channel* and *Auto volume* settings take effect after power outages of several minutes or more.

Curtain effect Reveals the picture by "opening" it from the middle of the screen when the TV is switched on. Hides the picture by "closing" it from the sides when the TV is switched off.

Special features The *Auto on* setting switches your TV on after a power outage; *Auto channel* tunes the TV to the channel you specify as the *Initial channel* when *Auto on* is enabled; *Auto volume* tunes the TV to the volume you set in *Initial volume* when *Auto on* is enabled.

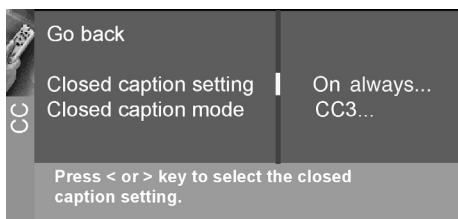

Closed Caption Many programs are encoded with closed-captioning information, which lets you display the audio portion of a program as text on the TV screen.

Closed captioning is not available on all channels at all times. Only specific programs encoded with closed-captioning information. When a program is closed captioned, *CC* is displayed in the channel banner. See Chapter 3 for more information about the channel banner. The closed caption options are:

Closed caption setting Lets you choose the way closed captioning information appears on the screen. The *Closed caption setting* does not effect the DVI-HDTV input.

Off No captioning information displayed.

On always Captioning information shown always, when available.

On when mute Displays captioning information, when available, whenever the TV's sound is muted by pressing the MUTE button. The captioning information is not displayed when the sound is not muted.

Closed-Caption Mode Displays a choice list that lets you choose which captioning mode is used for displaying captioning information. If you are unsure of the differences among the modes, you may prefer to leave the closed captioned mode set to CC1, which displays complete text of the program in the primary language in your area.

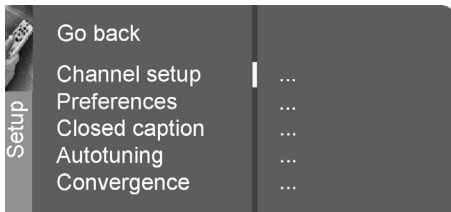

Autotuning Displays a choice list that lets you set up the TV to automatically tune to the correct input channel when you press a component button (DVD or AUX/HD) on the remote. Go to Chapter 3 for details about the Autotuning feature.

Convergence The *Auto convergence* feature automatically adjusts the TV's tubes (this may take several minutes, after which you can make fine adjustments to the convergence settings); *Red convergence* displays the Red convergence screen, allowing you to use the arrow buttons to align the red and green images; *Blue convergence* displays the Blue convergence screen, allowing you to use the arrow buttons to align the blue and green images.

Troubleshooting

Most problems you encounter with your TV can be corrected by consulting the following troubleshooting list.

Note for US customers: If you prefer, we can provide you with the name of an Authorized Service Representative who will visit your home for a fee to install your electronic entertainment system and to instruct you in its operation. For details about this service, call 1-888-206-3359.

For additional assistance while using your RCA product, please visit www.rca.com/customersupport.

TV Problems

TV won't turn on

- Press the TV button.
- Make sure the TV is plugged in.
- Check the wall receptacle (or extension cord) to make sure it is "live" by plugging in something else.
- Something might be wrong with your remote control. Press the POWER button on the front of the TV. If the TV turns on, check the remote control solutions on the next page.
- The front panel controls may be locked (disabled). Use the remote control to unlock the front panel controls by selecting the *Front Panel Block* in the *Parental Control* menu and press OK to uncheck the box.
- The TV might be performing a periodic diagnostic check. Wait for a few minutes for the TV to turn on.

Buttons don't work

- If you're using the remote control, press the TV button first to make sure the remote is in TV mode.
- The front panel controls may be locked (disabled). Use the remote control to unlock the front panel controls by selecting the *Front Panel Block* in the *Parental Control* menu and press OK to uncheck the box.
- Unplug the TV for ten minutes and then plug it back in. Turn the TV on and try again.

TV turns off unexpectedly

- Sleep timer may have been activated. Go to page 36 for instructions.
- Electronic protection circuit may have been activated because of a power surge. Wait 30 seconds and then turn on again. If this happens frequently, the voltage in your house may be abnormally high or low.
- Unplug. Wait ten minutes. Plug in again.

TV turns on unexpectedly

- Wake up timer might have been activated. Go to page 36 for instructions.
- Auto on might have been activated. Go to page 38 for instructions.
- You might have pressed CH+, CH- or INPUT on the remote accidentally.

Blank screen

- Make sure the component connected to the TV is turned on.
- Try another channel.
- If you're trying to watch something that's playing on a component connected to the TV (like a DVD or a VCR tape), press the TV button on the remote, then press INPUT until you get to the correct video input channel.

No sound, picture okay

- Maybe the sound is muted. Try pressing the volume up button to restore sound.
- If using S-Video or Y, PB, PR, remember to also connect the component's left and right audio output jacks to the TV's L and R Audio Input jacks.
- If you're using the TV's internal speakers, make sure the INT/EXT switch on the back of the TV is put on "INT".
- The sound settings may not be set correctly. Go to page 33 for more information.

Can't select certain channel

- Make sure the remote control is in TV mode. Press the TV button and enter the channel number using the number buttons.
- Channel may be blocked or not approved in the *Parental Controls* menu.
- If using a VCR, check to make sure the TV/VCR button on the VCR is in the correct mode (press the TV/VCR button on your VCR).

Continues on next page...

Other Information

Noisy stereo reception

- May be a weak station. Use *Sound* menu to choose mono sound.

No picture, no sound but TV is on

- Maybe the cable/air function is set to the wrong position. Go to page 37 for detailed instructions.
- The channel might be blank — change channels.
- If you're watching your VCR and it's connected with coaxial cable to the CABLE/ANTENNA jack, tune the TV to channel 3 or 4 (whichever channel is selected on the 3/4 switch on the back of your VCR). Also check to make sure the TV/VCR button on the VCR is in the correct mode (press the TV/VCR button on your VCR).

Sound okay, picture poor

- Check antenna connections. Make sure all of the cables are firmly connected to the jacks.
- Try adjusting sharpness function to improve weak signals. Go to page 35 for more instructions.

Volume buttons not adjusting volume louder

- Check to make sure volume isn't limited by the maximum volume feature. Go to page 37 for more instructions.

Picture not moving

- You have activated the Freeze feature by pressing FREEZE or OK on the remote. Press any button to “unfreeze” the picture.

Black box appears on the screen

- Closed-captioning might be on. Check *Closed Caption* in the *Setup* menu. Go to page 38 for more instructions.

Freeze not working

- The freeze feature is not available for Component video (CMP1 or CMP2) or DVI inputs.

Low battery warning appears on screen

- Place new batteries in remote.

TV picture keeps switching between screen formats abruptly

- Switch the *Auto format* feature to *Off*. See page 34 for more information.

The Remote Control Doesn't Work

- Something might be between the remote and the remote sensor on the component. Make sure there is a clear path.
- Maybe the remote isn't aimed directly at the component (TV, VCR, DVD player, etc.) that you're trying to operate.
- Maybe remote is not in TV Mode. Press the TV button so remote will control TV.
- Maybe batteries in remote are weak, dead, or installed incorrectly. Put new batteries in the remote. (Note, if you remove the batteries, you may have to reprogram the remote to operate other components.)
- You might need to drain the remote's microprocessor: remove batteries and press the number 1 button for at least 60 seconds. Release the 1 button, replace the batteries, and (if necessary) program the remote again.
- Make sure there's nothing plugged into the WIRED IR jack on the TV's back panel. The remote that came with your TV won't work if anything is plugged into this jack.

Problems with V-Chip/Parental Controls

The rating limits don't work

- You must lock the settings. Go to the *MAIN MENU* (press MENU on your remote), select *Parental Control*, select *Lock Parental Controls*.

I don't remember my password and I want to unlock the TV

- If you forget your password, press MENU, then select *Parental Control* (the password entry screen appears). Simultaneously press and hold CH+ and VOL+ on the TV's front panel for 8 seconds. The Parental control menu appears on the screen, and you can re-enter a password via *Lock Parental Controls*.

The V-Chip won't let me watch a program even though it's not rated as violent.

- Maybe the movie was given an NR (Not Rated) status. After you block movie ratings, you must set *NR* to *View* separately in order to view movies with an NR rating.

FCC Information

This equipment has been tested and found to comply with the limits for a Class B digital device, pursuant to Part 15 of the FCC Rules. These limits are designed to provide reasonable protection against harmful interference in a residential installation. This equipment generates, uses, and can radiate radio frequency energy and, if not installed and used in accordance with the instructions, may cause harmful interference to radio communications. However, there is no guarantee that interference will not occur in a particular installation. If this equipment does cause harmful interference to radio or television reception, which can be determined by turning the equipment off and on, the user is encouraged to try to correct the interference by one or more of the following measures:

- Reorient or relocate the receiving antenna.
- Increase the separation between the equipment and receiver.
- Connect the equipment into an outlet on a circuit different from that to which the receiver is connected.
- Consult the dealer or an experienced radio/TV technician for help.

This Class B digital apparatus complies with Canadian ICES-003.

Care and Cleaning

CAUTION: Turn OFF your TV before cleaning.

You can clean the TV as required, using a soft lint-free cloth. Be sure to occasionally dust the ventilation slots in the cabinet to help assure adequate ventilation.

The TV's screen may be cleaned with a soft, lint-free cloth as well. Take care not to scratch or mar the screen. If necessary, you may use a cloth dampened with warm water. Never use strong cleaning agents, such as ammonia-based cleaners, or abrasive powder. These types of cleaners will damage the TV.

While cleaning do not spray liquid directly on the screen, or allow liquid to run down the screen and inside the TV. Also, never place drinks or vases with water on top of the TV. This could increase the risk of fire or shock hazard or damage to the TV.

Caution: Using video games or any external accessory with fixed images for extended periods of time can cause them to be permanently imprinted on the picture tube (or projection TV picture tubes). ALSO, some network/program logos, phone numbers, etc. may cause similar damage. This damage is not covered by your warranty.

RCA HDTV Monitor Limited Warranty

What your warranty covers:

- Defects in materials or workmanship.

For how long after your purchase:

- One year from date of purchase for labor.
- One year from date of purchase for parts.
- Two years from date of purchase for the picture tube.

The warranty period for rental units begins with the first rental or 45 days from date of shipment to the rental firm, whichever comes first.

What we will do:

- Pay an Authorized Service Center the labor charges to repair your unit.
- Pay an Authorized Service Center for the new, or at our option, refurbished replacement parts and picture tube required to repair your unit.

How you get service:

- Call 1-877-RCA-HDTV and have your unit's date of purchase and model number ready.
- A representative will troubleshoot your problem over the phone.
- If the representative determines that you should receive service, they will provide you with the name(s) of the Authorized Service Center in your area.
- Contact the Service Center and arrange for home or pick up, repair, and return service, provided that your unit is located within the geographic territory covered by an Authorized Service Center. If not, you must take your unit to the Service Center location at your own expense, or pay for the cost the Service Center may charge to transport your unit to and from your home.
- Proof of purchase in the form of a bill of sale or receipted invoice which is evidence that the product is within the warranty period must be presented to obtain warranty service. For rental firms, proof of first rental is also required.

What your warranty does not cover:

- Customer instruction. (Your Owner's Manual describes how to install, adjust, and operate your unit. Any additional information should be obtained from your dealer.)
- Installation and related adjustments.
- Signal reception problems not caused by your unit.
- Damage from misuse or neglect.
- Batteries.
- Images burnt onto the screen.
- A unit that has been modified or incorporated into other products.
- A unit purchased or serviced outside the U.S.A.
- Acts of nature, such as but not limited to lightning damage.

Product Registration:

- Please complete the online Product Registration on RCA.com or complete and mail the Product Registration Card packed with your unit. It will make it easier to contact you should it ever be necessary. The return of the card is not required for warranty coverage.

Limitation of Warranty:

- **THE WARRANTY STATED ABOVE IS THE ONLY WARRANTY APPLICABLE TO THIS PRODUCT. ALL OTHER WARRANTIES, EXPRESS OR IMPLIED (INCLUDING ALL IMPLIED WARRANTIES OF MERCHANTABILITY OR FITNESS FOR A PARTICULAR PURPOSE) ARE HEREBY DISCLAIMED. NO VERBAL OR WRITTEN INFORMATION GIVEN BY THOMSON INC., ITS AGENTS OR EMPLOYEES SHALL CREATE A WARRANTY OR IN ANY WAY INCREASE THE SCOPE OF THIS WARRANTY.**
- **REPAIR OR REPLACEMENT AS PROVIDED UNDER THIS WARRANTY IS THE EXCLUSIVE REMEDY OF THE CONSUMER. THOMSON INC. SHALL NOT BE LIABLE FOR INCIDENTAL OR CONSEQUENTIAL DAMAGES RESULTING FROM THE USE OF THIS PRODUCT OR ARISING OUT OF ANY BREACH OF ANY EXPRESS OR IMPLIED WARRANTY ON THIS PRODUCT. THIS DISCLAIMER OF WARRANTIES AND LIMITED WARRANTY ARE GOVERNED BY THE LAWS OF THE STATE OF INDIANA. EXCEPT TO THE EXTENT PROHIBITED BY APPLICABLE LAW, ANY IMPLIED WARRANTY OF MERCHANTABILITY OR FITNESS FOR A PARTICULAR PURPOSE ON THIS PRODUCT IS LIMITED TO THE APPLICABLE WARRANTY PERIOD SET FORTH ABOVE.**

How State Law relates to warranty:

- Some states do not allow the exclusion nor limitation of incidental or consequential damages, or limitations on how long an implied warranty lasts, so the above limitations or exclusions may not apply to you.
- This warranty gives you specific legal rights, and you also may have other rights that vary from state to state.

If you purchased your unit outside the United States:

- This warranty does not apply. Contact your dealer for warranty information.

Service calls which do not involve defective materials or workmanship are not covered by this warranty. Costs of such service calls are the sole responsibility of the purchaser.

Other Information

Accessory Information

There are various accessories available to complement your HDTV Monitor. Prices are subject to change without notice. All accessories are subject to availability.

A shipping and handling fee will be charged upon ordering, and we are required by law to collect the appropriate sales tax for each individual state, county and locality to which the merchandise is being sent.

HOW TO ORDER

To place an order by phone, have your Visa, MasterCard or Discover Card ready and call the toll-free number listed below. Use this number only to place an order for accessory items.

1-800-338-0376

You can buy some accessories on-line at:

www.rca.com.

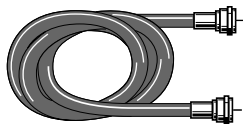

VH81 (3-ft.), price: \$3.95
VH82 (6-ft.), price: \$4.95

Screw-on Cable attaches to the round antenna connectors (called 75-ohm F-type) on the back of your VCR or TV. The ends screw onto the connectors for a secure connection.



VH976 (6-ft.), price: \$7.95
VH913 (12-ft.), price: \$14.95

S-Video Cable has multi-pin connectors on each end for connecting S-Video components to your TV.

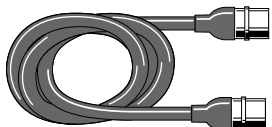

VH89 (6-ft.), price: \$5.95

Push-on antenna cable attaches to the round antenna connectors (called 75-ohm F-type). The ends push on for a quick connection

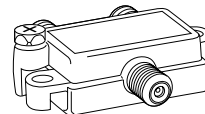

VH47, price: \$3.95

2-way Signal Splitter helps you connect to a second TV or VCR.

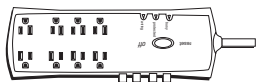

SCTV4000C,
price: \$49.95

Surge Protector provides eight outlets, coaxial and telephone line protection. Audible alarm for surge failure. \$100,000 Surge Equipment Guarantee.

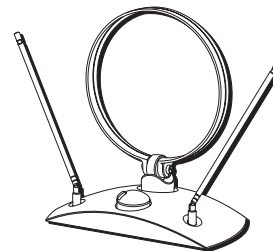

Amplified VHF/UHF/FM Antenna allows you to easily switch from the antenna signal to cable or satellite easily without disconnecting antenna.

ANT200, price: \$49.95

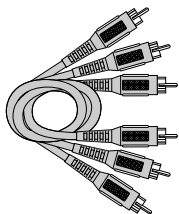

Gold-Tipped cable
DT6DC (6-ft), price: \$24.95
DT12DC (12-ft), price: \$34.95

Component Video Cables Triple cable used to connect a video source with Y, PR, PB jacks to the TV.

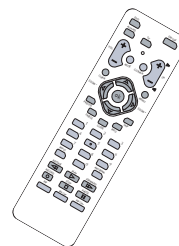

Remote Control This is the remote control that came packed with your TV. Replacements or spares can be ordered as needed.

261669, price: \$28.25



VH83 (6-ft., mono), price: \$5.95
VH84 (6-ft., stereo), price: \$9.95

Standard Audio/Video cable with RCA-type phono plugs.

- A**
- A/V receiver 12
 - Accessories 44
 - Age-based ratings 28
 - Amplifier 33
 - ANTENNA/CABLE 14, 35
 - Arrow buttons 18, 32
 - Audio/Video cables 44
 - Audio jacks
 - Front 14
 - Outputs (fixed/variable) 14
 - Autoformat 34, 40
 - Automatic code search 20
 - Autotuning 24, 25, 38
 - Auto channel search 16, 37
 - Auto channel update 37
 - Auto convergence 17, 38
 - Auto on 38
 - Auto skin tone 35
 - AUX/HD button 18, 25
- B**
- Balance 33
 - Black level 35
- C**
- Cables
 - Audio/Video 5, 44
 - Coaxial 5, 44
 - Component video 5, 44
 - DVI 5
 - S-Video 5, 44
 - Canadian V-Chip ratings 26, 30
 - English system 29
 - French system 30
 - Care and cleaning 41
 - Channel banner 24
 - Channel Guide menu 36
 - Channel number 24
 - Channel setup 37
 - CLEAR button 18
 - Closed captions 24, 38
 - CMP1/CMP2 inputs 13, 25
 - Coaxial cable 5, 44
 - Codes for the remote 23
 - Color 35
 - Color warmth 35
 - Commercial skip 19, 24
 - Component buttons 19, 21, 24, 38
 - Connections 5
 - DVD 6, 7, 10, 11
 - HDTV Tuner 6, 7
 - Satellite receiver 8, 9
 - Things to consider before 4
 - VCR 6, 7, 8, 9, 10, 11
 - Content themes 28, 29
 - Contrast 35
 - Contrast expand 34
 - Convergence 38
 - Curtain effect 38
- D**
- Direct entry 20, 21
 - DVD
 - Button 18, 25
 - Connection 6, 7, 10, 11
 - DVI input 13, 25
 - Dynamic bass 34
- E**
- Exempt programs 31
 - External speakers 12, 14
- F**
- FCC information 41
 - Film mode 35
 - Freeze 18, 40
 - FRNT input 25
 - Front panel
 - Block 31
 - Buttons 15
 - Jacks 14
- G**
- Graphic equalizer 34
 - GUIDE button 18, 36
- H**
- HDTV Tuner 6, 7
 - Headphones
 - Jack 14
 - Settings 34
 - Hi-Pix Picture Enhancement System 2
- I**
- Initial setup 15, 16
 - Inputs
 - ANTENNA/CABLE 14, 35
 - Button 19, 22
 - CMP1 and CMP2 13, 25
 - DVI 13, 25
 - FRNT 14, 25
 - VID1 and VID2 13, 25
- J**
- Jacks 13, 14
 - ANTENNA/CABLE 14, 25, 35
 - Audio 13, 14
 - Component video 13, 25
 - DVI 2, 13, 25
 - Front 14, 25
 - S-Video 13, 14, 25
 - Video 13, 14, 25
- L**
- Language 16, 37
 - Lists and labels 17, 37
- M**
- Maximum TV volume 37
 - Menu
 - Button 16, 19
 - Channel guide 36
 - Language 16, 37
 - Parental control 36
 - Picture 34, 35
 - PIP 37
 - Setup 16, 37, 38
 - Sound 33, 34
 - Time 36
 - Mute 19, 24
- O**
- ON•OFF button 19
 - Optimized still picture 35
- P**
- Parental control
 - Menu 36
 - Problems 40
 - Parental controls 2, 24, 26
 - Lock/unlock 31
 - Password 40
 - Picture menu 34
 - Picture presets 19, 35
 - PIP (Picture-in-picture) 2, 32
 - Button 19, 32
 - Channel 37
 - Menu 37
 - POP (Picture-outside-picture) 2, 19, 32, 37
 - Preferences 37, 38
- R**
- Rating limits
 - Problems 40
 - Remote control
 - Backlight 19
 - Batteries 15, 40
 - Buttons 18, 19
 - Codes 23
 - Problems 40
 - Programming 20
 - Replacement 44
 - Use 15, 21
 - Reverse 3:2 pulldown 2, 35
- S**
- S-Video
 - Back input jacks 13, 25
 - Cable 44
 - Front input jack 14
 - Safety information 4
 - SAT/CAB button 19, 25
 - Satellite receiver 8, 9
 - Scan velocity modulation 34
 - Screen format 24, 34, 40
- Second audio program (SAP)** 24, 33
- Setup menu** 16, 37, 38
- Sharpness** 35
- Signal type** 37
- SKIP button** 19, 24
- Sleep timer** 19, 36
- Sound**
- Menu 33, 34
 - Mode 33
 - Settings 19, 33
 - Type 33
- Sound logic** 34
- Stereo** 24, 33, 40
- Subwoofer** 14, 33
- SWAP button** 19, 32
- T**
- Time 24, 36
 - Tint 35
 - Transport buttons 19
 - Troubleshooting 39, 40
 - TV button 16, 19
 - TV problems 39
- U**
- Unrated programs 31
 - US V-Chip ratings 26, 27, 31
- V**
- V-Chip 2, 26, 27
 - Canadian ratings 30
 - Movie rating limit 31
 - Problems 40
 - US ratings 31
 - VCR
 - Button 19, 25
 - Connection 6, 7, 8, 9, 10, 11
 - Video input jacks
 - Front 14
 - VID1/VID2 13, 25
 - Video noise reduction 35
 - Volume punchthrough 22
- W**
- Wake up timer 36
 - Warranty 42
- Z**
- ZOOM button 19, 32

Visit the RCA website at www.rca.com

Please do not send any products to the Indianapolis address listed in this manual or on the carton. This will only add delays in service for your product.

Thomson Inc.
10330 North Meridian Street
Indianapolis, IN 46290

©2003 Thomson Inc.
Trademark(s)® Registered
Marca(s) Registrada(s)
Printed in USA
TOCOM 16206110



Free Manuals Download Website

<http://myh66.com>

<http://usermanuals.us>

<http://www.somanuals.com>

<http://www.4manuals.cc>

<http://www.manual-lib.com>

<http://www.404manual.com>

<http://www.luxmanual.com>

<http://aubethermostatmanual.com>

Golf course search by state

<http://golfingnear.com>

Email search by domain

<http://emailbydomain.com>

Auto manuals search

<http://auto.somanuals.com>

TV manuals search

<http://tv.somanuals.com>