



Cat. No. 20-421 **A**

## OWNER'S MANUAL

Please read before using this equipment.

# PRO-2015

## 200-Channel Programmable Home Scanner

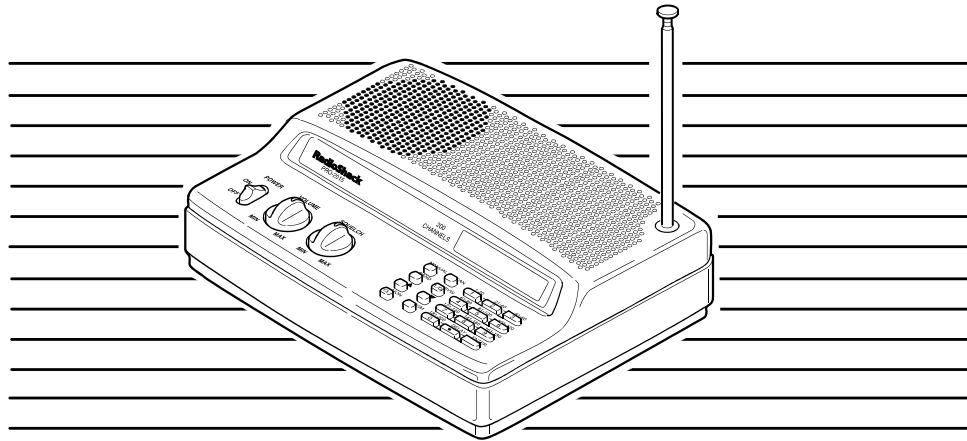

**RadioShack®**

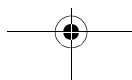



## FEATURES

---

Your RadioShack PRO-2015 200-Channel Programmable Home Scanner lets you in on all the action! This scanner gives you direct access to over 25,000 frequencies, including those used by police and fire departments, ambulance services, government agencies, air, and amateur radio services.

Your scanner includes these special features:

**Five Service Banks** — let you search preset frequencies in separate fire/police, air, ham radio, marine, and weather banks, to make it easy to locate specific types of calls.

**200 Channels** — let you store up to 200 of your favorite frequencies for easy scanning and recall.

**Two-Second Delay** — lets you set the scanner so it delays scanning or searching for two seconds before moving to another channel or frequency so you can hear more replies.

**Ten Channel-Storage Banks** — you can store up to 20 channels in each of 10 different banks to group channels so you can more easily identify calls.

**20 Monitor Memories** — let you temporarily save up to 20 frequencies you locate during a search, so you can

move selected frequencies to channel storage later.

**Memory Backup** — keeps the channel frequencies stored in memory for about 1 hour during a power loss.

**HyperSearch™ and HyperScan™** — enable the scanner to search at up to 50 steps per second and scan at up to 25 channels per second, to help you quickly find interesting broadcasts.

**Duplicate Frequency Check** — automatically notifies you if you are about to store a frequency you have already stored, to help avoid wasting storage space.

**Squelch Control** — lets you adjust the scanner's sensitivity low enough to receive weak signals or high enough to eliminate receiver noise when not receiving a signal.

**Direct Search** — lets you search for new and unlisted frequencies starting from a specified frequency.

**Lock-Out Function** — lets you set your scanner to lock out up to 200 channels when scanning or skip up to 50 specified frequencies when searching.

**Liquid Crystal Display** — makes it easy to view and change programming information at any time.

© 1999 Tandy Corporation.  
All Rights Reserved.

RadioShack is a registered trademark used by Tandy Corporation.  
Hyperscan and Hypersearch are trademarks used by Tandy Corporation.

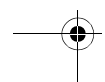
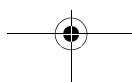



---

**Display Backlight** — makes the scanner easy to read in low light situations.

**Supplied Telescoping Antenna** — lets you receive strong local signals.

**External Antenna Terminal** — lets you connect an external antenna (not supplied) to the scanner.

**Dual Conversion** — helps prevent interference from image frequencies.

We recommend you record your scanner's serial number here. The number is on the scanner's back panel.

Serial Number: \_\_\_\_\_

**WARNING:** To reduce the risk of fire or shock hazard, do not expose this product to rain or moisture.

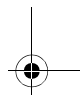
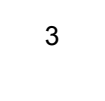
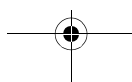
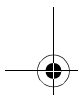
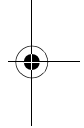
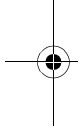

Your PRO-2015 scanner can receive all of these bands:

29–30 MHz	10 m Amateur Radio
30–50 MHz	VHF Lo
50–54 MHz	6 m Amateur Radio
108–136.9875 MHz	Air
137–144 MHz	Government
144–148 MHz	2 m Amateur Radio
148–174 MHz	VHF Hi
380–420 MHz	Government
420–450 MHz	70 cm Amateur Radio
450–470 MHz	UHF Lo
470–512 MHz	UHF "T" Band

## FCC NOTICE

Your scanner might cause TV or radio interference even when it is operating properly. To determine if your scanner is causing the interference, turn off your scanner. If the interference goes away, your scanner is causing it. Try the following methods to eliminate the interference.

- Move your scanner away from the TV or radio.
- Connect your scanner to an outlet that is on a different electrical circuit from the TV or radio.

- Contact your local RadioShack store for help.

If you cannot eliminate the interference, the FCC requires that you stop using your scanner.

This device complies with Part 15 of *FCC Rules*. Operation is subject to the following conditions: (1) This device must not cause harmful interference, and (2) this device must accept any interference received, including interference that may cause undesired operation.

## SCANNING LEGALLY

Your scanner covers frequencies used by many different groups including police and fire departments, ambulance services, government agencies, private companies, amateur radio services, military operations, pager services, and wireline (telephone and telegraph) service providers. It is legal to listen to almost every transmission your scanner can receive. However, there are some transmissions you should never intentionally listen to. These include:

- telephone conversations (cellular, cordless, or other private means of telephone signal transmission)
- pager transmissions
- any scrambled or encrypted transmissions



---

According to the *Electronic Communications Privacy Act (ECPA)*, you are subject to fines and possible imprisonment for intentionally listening to, using, or divulging the contents of such a transmission unless you have the consent of a party to the communication (unless such activity is otherwise illegal).

This scanner has been designed to prevent reception of illegal transmissions. This is done to comply with the legal requirement that scanners be manufactured so as to not be easily modifiable to pick up those transmissions. Do not open your scanner's case to make any modifications that could allow it to pick up transmissions that it is not legal to listen to. Doing so could subject you to legal penalties.

We encourage responsible, legal scanner use.

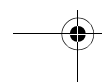
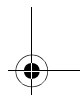
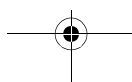
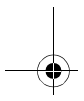
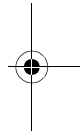
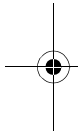

# CONTENTS

<b>Preparation .....</b>	<b>8</b>
Power Sources .....	8
Using AC Power .....	8
Using DC Power .....	8
Connecting an Antenna .....	9
Connecting the Supplied Antenna .....	9
Connecting an Outdoor Antenna .....	10
<b>Understanding Your Scanner .....</b>	<b>11</b>
A Look at the Controls .....	11
A Look at the Display .....	12
Understanding Banks .....	14
Channel Storage Banks .....	14
Service Banks .....	14
<b>Operation .....</b>	<b>16</b>
Turning on the Scanner/Setting Volume and Squelch .....	16
Storing Known Frequencies into Channels .....	16
Finding and Storing Active Frequencies .....	17
Searching the Service Banks .....	17
Using Direct Search .....	19
Using the Monitor Memory .....	20
Listening to a Monitor Memory Frequency .....	20
Moving a Frequency from a Monitor Memory to a Channel .....	20
Scanning the Stored Channels .....	21
Turning Channel-Storage Banks Off and On .....	22
Monitoring a Stored Channel .....	22
Clearing a Stored Channel .....	22
<b>Special Features .....</b>	<b>24</b>
Locking Out Channels and Frequencies .....	24
Locking Out Channels .....	24
Locking Out Frequencies .....	24
Reviewing Locked-Out Frequencies .....	25
Removing All Lockout Tags From Frequencies .....	25
Removing Lockout Tags from Frequencies in All Service Banks .....	25
Using the Delay Function .....	25
Listening to the Weather Bank .....	26
Turning the Key Tone On and Off .....	26



---

<b>A General Guide to Scanning .....</b>	<b>27</b>
Ham Radio Frequencies .....	27
National Weather Frequencies .....	27
Birdie Frequencies .....	28
United States Broadcast Band .....	28
Guide to the Action Bands .....	29
Typical Band Usage .....	29
Primary Usage .....	29
Band Allocation .....	30
Avoiding Image Frequencies .....	34
Frequency Conversion .....	34
<b>Troubleshooting .....</b>	<b>35</b>
Resetting/Initializing the Scanner .....	36
Resetting the Scanner .....	36
Initializing the Scanner .....	36
<b>Care and Maintenance .....</b>	<b>37</b>
<b>Specifications .....</b>	<b>38</b>

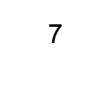
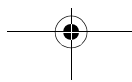
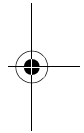
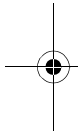

## PREPARATION

### POWER SOURCES

#### Using AC Power

The scanner's supplied AC adapter lets you power the scanner from a standard AC outlet. To connect power to the scanner, insert the AC adapter's barrel plug into the **DC 12V** jack on the back of the scanner, then plug the AC adapter into a standard AC outlet.

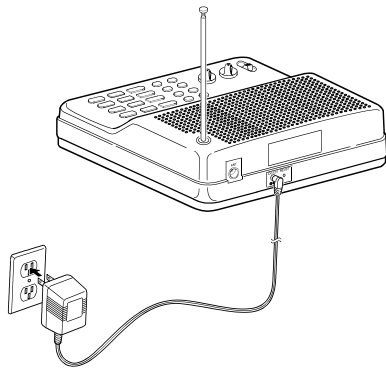

**Warning:** Do not use the AC adapter's polarized plug with an extension cord receptacle unless the blades can be fully inserted to prevent blade exposure.

#### Cautions:



You must use a Class 2 power source that supplies 12 volts DC and delivers at least 300 mA. Its center tip must be set to positive and its plug must fit the PRO-2015's **DC 12V** jack. The supplied adapter meets these specifications. Using

an adapter that does not meet these specifications could damage the PRO-2015 or the adapter.

- Be sure to connect the AC adapter to the scanner before you connect it to an AC outlet, and disconnect the AC adapter from the AC outlet before you disconnect it from the scanner.

#### Using DC Power

You can power your scanner from your vehicle's cigarette-lighter socket with an optional DC adapter, such as RadioShack Cat. No. 270-1533.

#### Cautions:



You must use a power source that supplies 12 volts DC and delivers at least 300 mA. Its center tip must be set to positive and its plug must fit the PRO-2015's **DC 12V** jack. The recommended adapter meets these specifications. Using an adapter that does not meet these specifications could damage the PRO-2015 or the adapter.

- Be sure to connect the DC adapter to the scanner before you connect it to the cigarette-lighter socket, and disconnect the DC adapter from the cigarette-lighter socket before you disconnect it from the scanner.



To connect a DC adapter, insert its 5.5 mm outer diameter/2.1 mm inner diameter barrel plug into the **DC 12V** jack on the back of the scanner, then plug the adapter into your vehicle's cigarette-lighter socket.

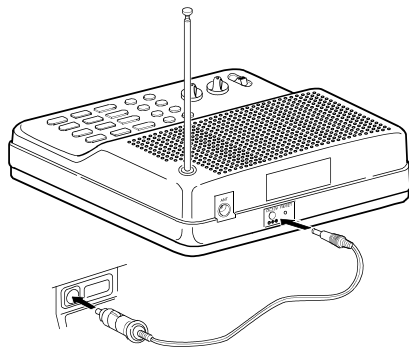

**Notes:**

- If you use a DC adapter and your vehicle's engine is running, you might hear electrical noise on the scanner caused by the engine. This is normal.
- Mobile use of this scanner is unlawful or requires a permit in some areas. Check the laws in your area.

## CONNECTING AN ANTENNA

### Connecting the Supplied Antenna

You must install an antenna before you can operate the scanner.

The supplied telescoping antenna helps your scanner receive strong local signals. To install the antenna, thread it clockwise into the hole on top of the scanner.

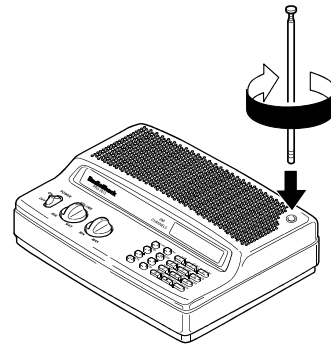

The scanner's sensitivity depends on its location and the antenna's length. For the best reception of the transmissions you want to hear, adjust the antenna's length according to the chart below.

Frequency	Antenna Length
29–174 MHz	Extend fully
380–512 MHz	Extend 2 segments

## Connecting an Outdoor Antenna

Instead of the supplied antenna, you can connect an outdoor base-station or mobile antenna (not supplied) to your scanner. Your local RadioShack store sells a variety of antennas.

Choose the one that best meets your needs.

When deciding on an outdoor antenna and its location, consider these points:

- The antenna should be located as high as possible.
- The antenna and antenna cable should be as far as possible from sources of electrical noise (appliances, other radios, and so on).
- The antenna should be vertical for the best performance.

To connect an optional base-station or mobile antenna, first remove the supplied antenna from the scanner. Always use 50-ohm coaxial cable, such as RG-58 or RG-8, to connect the base-station or mobile antenna. For lengths over 50 feet, use RG-8 low-loss dielectric coaxial cable. If the antenna cable's connector does not fit in the **ANT** jack on the back of the scanner, you might also need a PL-259-to-Motorola antenna plug adapter, such as Cat. No. 278-208. Your local RadioShack store carries a wide variety of coaxial antenna cable and connectors.

Once you choose an antenna, follow the mounting instructions supplied with the antenna. Then route the antenna's cable to the scanner and connect the cable to the **ANT** jack.

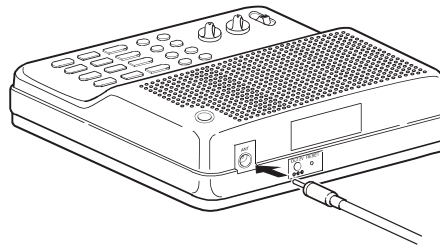

**Warning:** Use extreme caution when you install or remove an outdoor antenna. If the antenna starts to fall, let it go! It could contact overhead power lines. If the antenna touches a power line, contact with the antenna, mast, cable, or guy wires can cause electrocution and death. Call the power company to remove the antenna. Do not attempt to do so yourself.

**Caution:** Do not run the cable over sharp edges or moving parts that might damage it.

## UNDERSTANDING YOUR SCANNER

Once you understand a few simple terms used in this manual and familiarize yourself with your scanner's features, you can put the scanner to work for you. You simply determine the type of communications you want to receive, then set the scanner to scan them.

A **frequency** is the tuning location of a station (expressed in kHz or MHz). To find active frequencies, you can use the **search** function.

You can also search the **service-search banks**, which are preset groups of frequencies categorized by type of service.

When you find a frequency, you can store it into a programmable memory location called a **channel**, which is grouped with your other channels in a **channel-storage bank**. You can then **scan** the channel-storage banks to see if there is activity on the frequencies stored there. Each time the scanner finds an active frequency, it stays on that channel until the transmission ends.

### A LOOK AT THE CONTROLS

**Note:** Some of the scanner's keys perform more than one function (such as **MON/CL**) and are marked with more than one label. The steps in this Owner's Manual show only the label on the

key appropriate to the action being performed.

A quick look at this section should help you understand each control's function.



**POWER** — turns the scanner on and off.

**VOLUME** — adjusts the volume.

**SQUELCH** — adjusts the scanner's squelch.

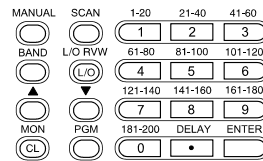

**MANUAL** — stops scanning to let you directly enter a channel number.

**SCAN** — scans through the programmed channels.

**BAND** — lets you search service banks.

**L/O RVW/L/O** (Lock Out Review/ Lock Out) — lets you review locked-out channels or frequencies, and lets you lock out selected channels or skips specified frequencies during a search.

**▲/▼** — enters the direction the scanner will search or scan.

**MON/CL** (Monitor/Clear) — accesses the 20 monitor memories or clears an incorrect entry.

**PGM** (Program) — programs frequencies into channels.

**Number Keys** — each key has a single-digit label and a range of numbers. Use the digits on the keys to enter the numbers for a channel or a frequency. Use the range of numbers above the key (**21–40**, for example) to select the channel in a channel-storage bank. See “Understanding Banks” on Page 14.

**DELAY/.** — enters a decimal point, or programs a two-second delay for the selected channel.

**ENTER** — enters a frequency into a channel.

## A LOOK AT THE DISPLAY

The display shows the scanner’s current operating mode. A look at the display will help you understand how your scanner operates.



**FIRE/POLICE** — appears when you search in the fire/police service bank.

**AIRCRAFT** — appears when you search in the air service bank.

**MARINE** — appears when you search in the marine service bank.

**HAM** — appears when you search in the ham radio service bank.

**BANK** — appears with numbers (1–10) when you search through the channels. Bank numbers with a bar under them show which ones are turned on for scanning. See “Understanding Banks” on Page 14.

**WX** — appears when you scan or manually select a channel in the weather band.

**▲/▼** — indicate the scan or search direction.

**M** — appears when you listen to the monitor memory.

**CH** — appears with a number (1–200) to the left to show which of the scanner’s 200 channels it is tuned to.

**MHz** — these digits show which frequency your scanner is currently tuned to.

**SRCH** — appears during service band and direct frequency searches.



**SCAN** — appears when you scan channels.

**MAN** — appears when you manually select a channel.

**PGM** — appears while you program the scanner.

**DLY** — appears when you program a two-second delay.

**L/O** — appears when you manually select a channel you locked-out while scanning or when you review the locked-out frequency.

**Error** — appears when you make an entry error.

**-dUPL-** (duplicate) — appears when you try to store a frequency that is already stored in another channel.

**-d-** — appears during a direct frequency search.

**-b-** — appears during a service bank frequency search.

**Ch-FULL** — appears when you try to enter a frequency during a search when all channels are full.

**F L-out** — appears when you start direct search from a locked-out frequency.

**FLo -FULL** — appears when you try to lockout a frequency during a search when 50 frequencies are already locked-out.

**L-r** — appears while you review the locked-out frequencies.

**dEFAULT** — appears when you remove all the lockout from the service bank frequencies.

**FLo ALL-CL** — appears when you remove all the locked-out frequencies during a service bank/direct search.

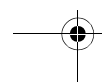
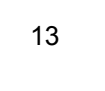
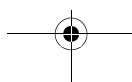
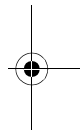
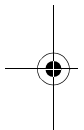

## UNDERSTANDING BANKS

### Channel Storage Banks

To make it easier to identify and select the channels you want to listen to, channels are divided into 10 banks of 20 channels each. Use each channel-storage bank to group frequencies, such as those used by the police department, fire department, ambulance services, or aircraft (see "Guide to the Action Bands" on Page 29). For example, the police department might use four frequencies, one for each side of town. You could program the police frequencies starting with Channel 1 (the first channel in bank 1) and program the fire department frequencies starting with Channel 21 (the first channel in bank 2).

### Service Banks

The scanner is preprogrammed with the frequencies allocated by fire/police, aircraft, ham radio, marine, and weather services. In these service banks, you can search through the frequencies and store them in channels for fire/police, aircraft, ham radio, and marine banks. (In the weather bank, you can only scan channels.) This is handy for quickly finding active frequencies instead of searching through an entire band.

**Note:** The frequencies in the scanner's service bank are preset. You cannot change them.

14

### Air

Group	Frequency range (MHz)	Step (kHz)
—	108.000–136.9875	12.5

### Amateur Radio

Group	Frequency range (MHz)	Step (kHz)
1	29.000–29.700	5
2	50.000–54.000	5
3	144.000–148.000	5
4	420.000–450.000	12.5

### Weather

Weather Channel	Frequency Range (MHz)
1	162.400
2	162.425
3	162.450
4	162.475
5	162.500
6	162.525
7	162.550

**Marine**

Group	Frequency range (MHz)	Step (kHz)
—	156.025–156.750	25
	156.800	—
	156.850	—
	156.875–156.975	25
	157.025	—
	157.050	—
	157.100	—
	157.150	—
	157.175	—
	157.425	—
	160.625	—
	160.650–160.875	25
	161.600	—
	161.800	—
	161.825–162.000	25

**Fire/Police**

Group	Frequency range (MHz)	Step (kHz)
1	33.420–33.980	20
	37.020–37.420	20
	39.020–39.980	20
	42.020–42.940	20
	44.620–45.860	40
	45.880	—
	45.900	—
	45.940–46.060	40
	46.080–46.500	20
2	153.770–154.130	60
	154.145–154.445	15
	154.650–154.950	15
	155.010–155.370	60
	155.415–155.700	15
	155.730–156.210	60
	158.730–159.210	60
	166.250	—
170.150	—	
3	453.0375–453.9625	12.5
	458.0375–458.9625	12.5
	460.0125–460.6375	12.5
	465.0125–465.6375	12.5

## OPERATION

### TURNING ON THE SCANNER/SETTING VOLUME AND SQUELCH

1. Turn **VOLUME** and **SQUELCH** fully counterclockwise.

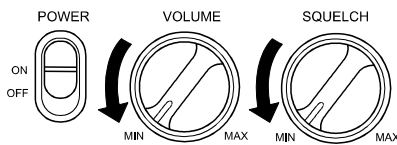

2. To turn on the scanner, slide **POWER** to **ON**.

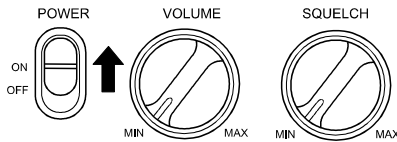

3. Turn **VOLUME** clockwise until you hear a hissing sound.
4. Turn **SQUELCH** clockwise, then leave it set to a point just after the hissing sound stops.

#### Notes:

- If the scanner picks up unwanted, partial, or very weak transmissions, turn **SQUELCH** clockwise to decrease the scanner's sensitivity to these signals.
- If you want to listen to a weak or distant station, turn **SQUELCH** counterclockwise.

- If the scanner will not scan, turn **SQUELCH** further clockwise.

5. To turn off the scanner when you finish, slide **POWER** to **OFF**.

### STORING KNOWN FREQUENCIES INTO CHANNELS

Good references for active frequencies are the RadioShack *Police Call*, *Aeronautical Frequency Directory*, and *Maritime Frequency Directory*. We update these directories every year, so be sure to get a current copy.

Follow these steps to store frequencies into channels.

1. Press **PGM**, enter the channel number (1–200) where you want to store a frequency, then press **PGM** again. The channel number appears.
2. Use the number keys and **•** to enter the frequency (including the decimal point) you want to store.

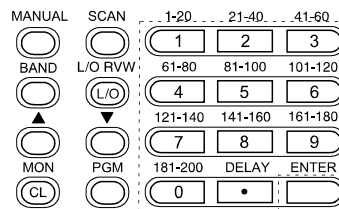



3. Press **ENTER** to store the frequency into the channel.

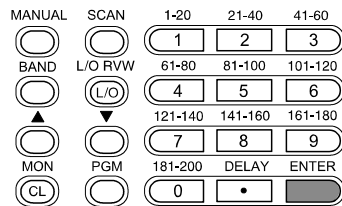

#### Notes:

- If you made a mistake in Step 2, **Error** appears and the scanner beeps when you press **ENTER**. Simply start again from Step 2.
- Your scanner automatically rounds the entered frequency to the nearest valid frequency. For example, if you enter a frequency of 151.473, your scanner accepts it as 151.470.
- If you entered a frequency that is already stored in another channel, the scanner beeps three times and displays the lowest channel number where the frequency is already stored, and **-dUPL-** then the frequency flashes. If you want to store the frequency anyway, press **ENTER** again. Or, press **MON/CL** to clear the frequency.
- Press **DELAY** if you want the scanner to pause two seconds on this channel after a transmission ends before it proceeds

to the next channel (see “Using the Delay Function” on Page 25). The scanner stores the **DELAY** setting in the channel.

4. To program the next channel in sequence, press **PGM** and repeat Steps 2 and 3.

## FINDING AND STORING ACTIVE FREQUENCIES

### Searching the Service Banks

Your scanner contains groups of pre-set frequencies called service banks. Each service bank is associated with a specific activity (see “Understanding Banks” on Page 14). You can search for fire/police, air, ham, and marine transmissions even if you do not know the specific frequencies that are used in your area. Then you can store the frequencies you found into the scanner’s channels or monitor memories.

**Note:** You can use the scanner’s delay feature while using band search. See “Using the Delay Function” on Page 25.

1. Press **BAND**. The last selected band name (such as **HAM**), **SRCH**, and other information appear.

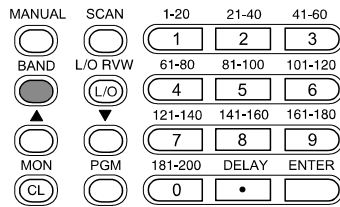

2. To select a different band, repeatedly press **BAND** until the desired band name appears. After about two seconds, the scanner begins searching rapidly up or down in that band for an active frequency.

**Notes:**

- To search through the frequencies, hold down ▲ or ▼ for a few seconds. The scanner tunes through the frequencies until an active frequency is found.
- To reverse the search direction at any time, hold down ▲ or ▼ for a few seconds.
- To search the band up or down in small increments (see “Service Banks” on Page 14 for increments), repeatedly press and release ▲ or ▼.
- To pause the search while receiving a signal, press and release ▲ or ▼. To continue the search, hold down ▲ or ▼ for about two seconds.

3. When the scanner finds an active frequency, it stops searching and

displays the frequency's number. To store the displayed frequency in the lowest available channel, press **ENTER**. The channel and frequency flash twice, and the scanner stores the displayed frequency. The scanner then continues to search for frequencies.

**Notes:**

- If there is no empty channel, **Ch-FULL** appears. To store more frequencies, you must clear some channels. See “Clearing a Stored Channel” on Page 22. To continue searching after **Ch-FULL** appears, press **MON/CL**.
  - If you entered a frequency that is already stored in another channel, **-DUPL-** (duplicate) and the lowest-numbered channel containing the duplicate frequency flash on the display for about three seconds. If you want to store the frequency anyway, press **ENTER** again. Or, enter a different frequency number or press **MON/CL** if you made a mistake.
4. To store the displayed frequency in the monitor memory, press **MON/CL**. **M**, the monitor memory number, and the frequency flash twice.

5. To search for another active frequency in the selected band, hold down ▲ or ▼ for about two seconds.
6. To select a different band and search for another active frequency, begin again from Step 2.

### Using Direct Search

During a direct search, the scanner searches up or down, starting from a frequency you specify. Follow these steps to use direct search.

**Note:** You can use the scanner's delay feature while using direct search.

1. Press **MANUAL** or **PGM**, then enter the frequency you want to use as a starting point for the search, including the decimal point.

**Note:** To start from a frequency already stored in one of your scanner's channels, press **MANUAL** or **PGM**, enter the desired channel number, then press **MANUAL** or **PGM** again.

2. Press ▲ or ▼ for a few seconds to search up or down. **SRCH**, **-d-**, and ▲ or ▼ appear.



▲ -d- CH 149.0000 MHz  
SRCH

### Notes:

- To reverse the search direction at any time, hold down ▲ or ▼ for a few seconds.
  - To search up or down in small increments (in steps of 5 or 12.5 kHz), press and release ▲ or ▼.
  - To pause the search while still receiving a signal, press and release ▲ or ▼. To begin searching again, hold down ▲ or ▼ for a few seconds.
3. When the scanner finds an active frequency, it stops searching and displays the frequency's number. To store the displayed frequency in the lowest available channel, press **ENTER**. The channel and frequency flash twice, and the scanner stores the displayed frequency. The scanner continues to search for frequencies.

### Notes:

- If there is no empty channel, **Ch-FULL** appears. To store more frequencies, you must clear some channels. See "Clearing a Stored Channel" on Page 22. To continue searching after **Ch-FULL** appears, press **MON/CL**.

- If you entered a frequency that is already stored in another channel, **-dUPL-** (duplicate) and the lowest-numbered channel containing the duplicate frequency flash on the display for about three seconds. If you want to store the frequency anyway, press **ENTER** again.
- To store the displayed frequency in a monitor memory, press **MON/CL. M**, the monitor memory number, and the frequency flash twice. To search for another active frequency, hold down **▲** or **▼**. See "Using the Monitor Memory."

## USING THE MONITOR MEMORY

The scanner has 20 monitor memories that you can use to temporarily store frequencies while you decide whether you want to save them into channels. This is handy for quickly storing an active frequency when you are searching through an entire band.

You can store a frequency into a monitor memory during a bank or direct search. See "Finding and Storing Active Frequencies" on Page 17.

You can select monitor memories manually, but you cannot scan them. See "Listening to a Monitor Memory Frequency."

After you store a frequency in the scanner's monitor memory during a search, you can recall it and move it to one of your scanner's channel memories. See "Moving a Frequency from a Monitor Memory to a Channel."

## Listening to a Monitor Memory Frequency

To recall a frequency stored in a monitor memory, simply press **MANUAL** then **MON/CL. M**, the monitor memory number, and **CH** flash and the current monitor memory frequency appears. To select a different monitor memory, enter the desired monitor memory's number (1–20), then press **MON/CL** again.



## Moving a Frequency from a Monitor Memory to a Channel

1. Press **PGM**, enter the channel number where you want to store the frequency, then press **PGM** again. **PGM** and the selected channel number appear.
2. Press **MON/CL. M**, the last selected monitor memory number, and **CH** flash, and the monitor memory frequency appear.

3. Enter the desired monitor memory's number (1–20), then press **MON/CL** again. The selected monitor memory's frequency appears.
4. Press **ENTER**. The scanner stores the frequency in the selected channel.
5. To move another monitor memory frequency to the next channel, press **PGM** and begin again from Step 2.

## SCANNING THE STORED CHANNELS

To set the scanner to continuously scan through all channels with stored frequencies, simply press **SCAN**. **SCAN** and **▲** appear, and the scanner begins to rapidly scan until it finds an active frequency.

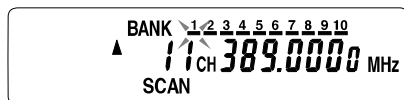

If the scanner finds an active frequency, it stops and displays that channel and frequency number, then it automatically begins scanning again when the transmission ends on that frequency.

### Notes:

- To set the scanner to remain on the current channel for two seconds after the transmission ends, press **DELAY**. See “Using the Delay Function” on Page 25.
- To set the scanner to remain on the current channel, even after the transmission stops, press **MANUAL** at any time during the transmission so **MAN** appears and **SCAN** disappears from the display (see “Monitoring a Stored Channel” on Page 22).
- To lock out channels so the scanner does not stop for a transmission on those channels, see “Locking Out Channels and Frequencies” on Page 24.
- To reverse the scanning direction, press **▲** or **▼**.

## TURNING CHANNEL-STORAGE BANKS OFF AND ON

To turn off banks while scanning, press the bank's number key until the bar under the bank's number disappears. The scanner does not scan any of the channels within the banks you have turned off.

To turn on banks while scanning, press the bank's number key until a bar appears under the bank's number.

### Notes:

- You cannot turn off all banks. There must be at least one active bank.
- You can manually select any channel in a bank, even if the bank is turned off.
- When you turn on a bank while scanning, the scanner moves to the selected bank's first channel and continues scanning.

## MONITORING A STORED CHANNEL

You can continuously monitor a specific channel without scanning. This is useful if you hear an emergency broadcast on a channel and do not want to miss any details — even though there might be periods of si-

lence — or if you simply want to monitor that channel.

Follow these steps to manually select a channel.

1. Press **MANUAL**.

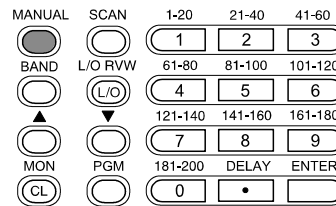

2. Enter the channel number.
3. Press **MANUAL** again.

## CLEARING A STORED CHANNEL

If you no longer want a frequency stored in a channel (and you do not want to replace that frequency with a different one), follow these steps to clear the stored frequency.

1. Select the channel that you want to clear.
2. Press **PGM**. **PGM** appears.
3. Press **0**, then press **ENTER**. The frequency number changes to **000.0000** on the display to indicate the channel is cleared.





- 
4. To clear another channel, use the number keys to enter that channel number (1–200), then press **PGM** again. Or, repeatedly press **PGM** until the desired channel number appears. Then repeat Step 3.

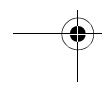
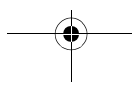
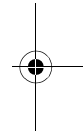
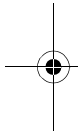

## SPECIAL FEATURES

### LOCKING OUT CHANNELS AND FREQUENCIES

You can increase the scanning or search speed by locking out individual channels or frequencies that have a continuous transmission, such as a weather channel (see “National Weather Frequencies” on Page 27) or a birdie frequency (see “Birdie Frequencies” on Page 28).

#### Notes:

- You can manually select locked-out channels.
- Your scanner automatically locks out empty channels.

#### Locking Out Channels

To lock out a channel while scanning, press and release **L/O/L/O RVW** when the scanner stops on the channel. The scanner then continues to scan.

To manually lock out a channel, follow these steps.

1. Press either **MANUAL** or **PGM**.
2. Enter the frequency's channel number where the frequency you want to lock out is stored, press **MANUAL** or **PGM** again, then press **L/O/L/O RVW**. **L/O** (the lock-out tag) appears.

To remove the lock-out tag from a channel, select that channel again,

then press **L/O/L/O RVW** so **L/O** disappears from the display.

#### Locking Out Frequencies

#### Notes:

- You can lock out as many as 50 frequencies during a search. If you try to lock out more, the scanner beeps three times and **FLo FULL** appears.
- If you enter a duplicate frequency to lockout, **F L-out** appears.
- To lock out a frequency during a bank or direct search, press **L/O/L/O RVW** when the scanner stops on the frequency. The scanner locks out the frequency then continues searching.

To manually lock out a frequency, follow these steps.

1. Press either **MANUAL** or **PGM**.
2. Enter the frequency (including the decimal point) you want to lock out.
3. Press either **▲** or **▼** once.
4. Press **L/O/L/O RVW**. The scanner beeps once when you release **L/O/L/O RVW**. Then **-d-** and the frequency the next step up or down (according to which arrow key you pressed in Step 3) appears.



## Reviewing Locked-Out Frequencies

To review the frequencies you locked out, hold down **L/O/L/O RVW** for about three seconds during a search. **L-r** appears. As you press **▲** or **▼**, the scanner displays all locked-out frequencies. When you reach the highest frequency, the scanner beeps twice and returns to the lowest locked-out frequency.

## Removing All Lockout Tags From Frequencies

1. Start a band or direct search.
2. To review the frequencies you locked out, hold down **L/O/L/O RVW** for about two seconds during the search. **L-r** appears.
3. Hold down **MON/CL** then **L/O/L/O RVW**. **FLo ALL-CL** appears.
4. Press **ENTER** to clear all lockout tags. To exit without clearing all locked out frequencies, press **MON/CL**.

## Removing Lockout Tags from Frequencies in All Service Banks

1. Start a band or direct search.
2. To review the frequencies you locked out, hold down **L/O/L/O RVW** for about two seconds during the search. **L-r** appears.

3. Hold down **MON/CL** then press **BAND**. **dEFAULT** appears.
4. Press **ENTER** to clear all locked out frequencies in all the service banks (except the weather bank).

## USING THE DELAY FUNCTION

Many agencies use a two-way radio system that has a period of several seconds between a query and a reply. To avoid missing a reply, you can program a two-second delay into any channel or frequency.

You can program a two-second delay in any of these ways:

- If the scanner is scanning and stops on an active channel, quickly press **DELAY** before it continues scanning.
- If the scanner is searching, press **DELAY**. **DLY** appears and the scanner automatically adds a two-second delay to every transmission it stops on in that band.
- Manually select the desired channel, then press **DELAY**.

When your scanner stops on a channel or frequency with a programmed delay, **DLY** appears and the scanner continues to monitor that frequency for two seconds after the transmission stops before resuming scanning or searching.



To turn off the two-second delay, press **DELAY** while the scanner is monitoring the channel or frequency. **DLY** disappears from the display.

## LISTENING TO THE WEATHER BANK

The FCC (Federal Communications Commission) has allocated 11 channels for use by the National Oceanic and Atmospheric Administration (NOAA). NOAA broadcasts your local forecast and regional weather information on one or more of these channels. We have programmed your scanner with seven of the U.S. frequencies most commonly used by NOAA.

To hear your local forecast and regional weather information, press **BAND** until **WX** appears. Your scanner begins to scan through the weather band. To reverse the scanning direction, press **▲** or **▼**.

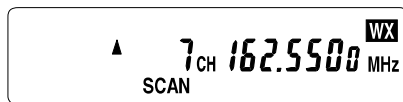

Your scanner should stop within a few seconds on your local weather broadcast. If the broadcast is weak, you can press **▲** or **▼** again to resume scanning.

**Note:** To manually select a preprogrammed weather channel, you can:

- hold down **▲** or **▼** until **MAN** appears, then repeatedly press **▲** or **▼** to move forward or backward through the channels.
- press the number (1-7) of the channel you want to listen to.

To resume scanning, hold down **▲** or **▼** until **SCAN** appears.

## TURNING THE KEY TONE ON AND OFF

The scanner is preset to sound a tone each time you press one of its keys. You can turn this feature on or off.

1. If the scanner is on, slide **POWER** to **OFF** to turn it off.
2. While you hold down **2** and **ENTER**, turn on the scanner.
3. Release **2** and **ENTER**.



## **A GENERAL GUIDE TO SCANNING**

Reception of the frequencies covered by your scanner is mainly "line-of-sight." That means you usually cannot hear stations that are beyond the horizon.

### **HAM RADIO FREQUENCIES**

Ham radio operators often broadcast emergency information when other means of communication break down.

The following chart shows the voice frequencies that you can monitor:

<b>Wavelength (Meters)</b>	<b>Voice (MHz)</b>
10 m	29.000–29.700
6 m	50.000–54.000
2 m	144.000–148.000
70 cm	420.000–450.000

### **NATIONAL WEATHER FREQUENCIES**

161.650*	161.775*	162.400	162.425
162.440*	162.450	162.475	162.500
162.525	162.550	163.275*	

\*Not preprogrammed in this scanner.



## BIRDIE FREQUENCIES

Every scanner has birdie frequencies. Birdies are signals created inside the scanner's receiver. These operating frequencies might interfere with broadcasts on the same frequencies. If you program one of these frequencies, you hear only noise on that frequency. If the interference is not severe, you might be able to turn **SQUELCH** clockwise to cut out the birdie.

The birdie frequencies on this scanner to watch for are:

29.800	51.200	128.000	149.400	166.400
30.735	51.225	128.6250	153.600	388.3875
32.200	112.150	133.1875	162.200	388.4125
38.400	112.6875	140.800	163.920	426.7875
40.000	115.200	143.430	164.830	482.2625
40.980	122.9375			

To find the birdies in your individual scanner, begin by disconnecting the antenna and moving it away from the scanner. Make sure that no other nearby radio or TV sets are turned on. Use the direct search function to search every frequency band from its lowest frequency to the highest. Occasionally, the searching will stop as if it had found a signal, often without any sound. This is a birdie. Make a list of all the birdies in your scanner for future reference.

## UNITED STATES BROADCAST BAND

In the United States, there are several broadcast bands. The standard AM and FM bands are probably the most well known. There are also four television audio broadcast bands—the lower three transmit on the VHF band and the fourth transmits on the UHF band. You can use your scanner to monitor the 470–512 MHz portion of the UHF band.

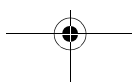



## GUIDE TO THE ACTION BANDS

### Typical Band Usage

#### HF Band (3.00–30.00 MHz)

10 m Amateur	29.00–29.70 MHz
High Range	29.70–29.90 MHz

#### VHF Band (30.00–300.0 MHz)

Low Range	30.00–50.00 MHz
6 m Amateur	50.00–54.00 MHz
U.S. Government	137.00–144.00 MHz
2 m Amateur	144.00–148.00 MHz
High Range	148.00–174.00 MHz

#### UHF Band (300.00 MHz–3.0 GHz)

U.S. Government	380.00–420.00 MHz
70 cm Amateur	420.00–450.00 MHz
Low Range	450.00–470.00 MHz
FM-TV Audio Broadcast, Wide Band	470.00–512.00 MHz

### Primary Usage

As a general rule, most of the radio activity is concentrated on the following frequencies:

#### VHF Band

Government, Police, and Fire	153.785–155.980 MHz
Emergency Services	158.730–159.460 MHz
Railroad	160.000–161.900 MHz

#### UHF Band

Land-Mobile Paired Frequencies	450.000–470.000 MHz
Base Stations	451.025–454.950 MHz
Mobile Units	456.025–459.950 MHz
Repeater Units	460.025–464.975 MHz
Control Stations	465.025–469.975 MHz

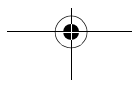

**Note:** Remote control stations and mobile units operate at 5 MHz higher than their associated base stations and relay repeater units.

## BAND ALLOCATION

To help decide which frequency ranges to scan, use the following listing of the typical services that use the frequencies your scanner receives. These frequencies are subject to change, and might vary from area to area. For a more complete listing, refer to the *Beyond Police Call*, available at your local RadioShack store.

### Abbreviations

### Services

AIR .....	Aircraft
BIFC .....	Boise (ID) Interagency Fire Cache
BUS .....	Business
CAP .....	Civil Air Patrol
CB .....	Citizens Band
CCA .....	Common Carrier
CSB .....	Conventional Systems
CTSB .....	Conventional/Trunked Systems
FIRE .....	Fire Department
HAM .....	Amateur (Ham) Radio
GOVT .....	Federal Government
GMR .....	General Mobile Radio
GTR .....	General Trunked
IND .....	Industrial Services
	(Manufacturing, Construction, Farming, Forest Products)
MAR .....	Military Amateur Radio
MARI .....	Maritime Limited Coast
	(Coast Guard, Marine Telephone, Shipboard Radio, Private Stations)
MARS .....	Military Affiliate Radio System
MED .....	Emergency/Medical Services
MIL .....	U.S. Military
MOV .....	Motion Picture/Video Industry
NEW .....	New Mobile Narrow
NEWS .....	Relay Press (Newspaper Reporters)
OIL .....	Oil/Petroleum Industry
POL .....	Police Department
PUB .....	Public Services
	(Public Safety, Local Government, Forestry Conservation)
PSB .....	Public Safety
PTR .....	Private Trunked
ROAD .....	Road & Highway Maintenance
RTV .....	Radio/TV Remote Broadcast Pickup
TAXI .....	Taxi Services
TELB .....	Mobile Telephone
	(Aircraft, Radio Common Carrier, Landline Companies)
TELC .....	Cordless Phones

TELM .....	Telephone Maintenance
TOW .....	Tow Trucks
TRAN .....	Transportation Services (Trucks, Tow Trucks, Buses, Railroad, Other)
TSB .....	Trunked Systems
TVn .....	FM-TV Audio Broadcast
USXX .....	Government Classified
UTIL .....	Power & Water Utilities
WTHR .....	Weather

**HIGH FREQUENCY (HF)—(3 MHz–30 MHz)**

**10 m Amateur Band (28.0–29.7 MHz)**

29.000–29.700 .....	HAM
---------------------	-----

**VERY HIGH FREQUENCY (VHF)—(30 MHz–300 MHz)**

**VHF Low Band (29.7–50 MHz—in 5 kHz steps)**

29.700–29.790 .....	IND
29.900–30.550 .....	GOVT, MIL
30.580–31.980 .....	IND, PUB
32.000–32.990 .....	GOVT, MIL
33.020–33.980 .....	BUS, IND, PUB
34.010–34.990 .....	GOVT, MIL
35.020–35.980 .....	BUS, PUB, IND, TELM
36.000–36.230 .....	GOVT, MIL
36.230–36.990 .....	Oil Spill Cleanup, GOVT, MIL
37.020–37.980 .....	PUB, IND
38.000–39.000 .....	GOVT, MIL
39.020–39.980 .....	PUB
40.000–42.000 .....	GOVT, MIL, MARI
42.020–42.940 .....	POL
42.960–43.180 .....	IND
43.220–43.680 .....	TELM, IND, PUB
43.700–44.600 .....	TRAN
44.620–46.580 .....	POL, PUB
46.600–46.990 .....	GOVT, TELC
47.020–47.400 .....	PUB
47.420 .....	American Red Cross
47.440–49.580 .....	IND, PUB
49.610–49.990 .....	MIL, TELC

**6 m Amateur Band (50–54 MHz)**

50.00–54.00 .....	HAM
-------------------	-----

**U.S. Government Band (138–144 MHz)**

137.000–144.000 .....	GOVT, MIL
-----------------------	-----------

**2 m Amateur Band (144–148 MHz)**

144.000–148.000 .....	HAM
-----------------------	-----

**VHF High Band (148–174 MHz)**

148.050–150.345	CAP, MAR, MIL
150.775–150.790	MED
150.815–150.980	TOW, Oil Spill Cleanup
150.995–151.475	ROAD, POL
151.490–151.955	IND, BUS
151.985	TELM
152.0075	MED
152.030–152.240	TELB
152.270–152.480	IND, TAXI, BUS
152.510–152.840	TELB
152.870–153.020	IND, MOV
153.035–153.725	IND, OIL, UTIL
153.740–154.445	PUB, FIRE
154.490–154.570	IND, BUS
154.585	Oil Spill Cleanup
154.600–154.625	BUS
154.655–156.240	MED, ROAD, POL, PUB
156.255–157.425	OIL, MARI
157.450	MED
157.470–157.515	TOW
157.530–157.725	IND, TAXI
157.740	BUS
157.770–158.100	TELB
158.130–158.460	BUS, IND, OIL, TELM, UTIL
158.490–158.700	TELB
158.730–159.465	POL, PUB, ROAD
159.480	OIL
159.495–161.565	TRAN
161.580–162.000	OIL, MARI, RTV
162.0125–162.35	GOVT, MIL, USXX
162.400–162.550	WTHR
162.5625–162.6375	GOVT, MIL, USXX
162.6625	MED
162.6875–163.225	GOVT, MIL, USXX
163.250	MED
163.275–166.225	GOVT, MIL, USXX
166.250	GOVT, RTV, FIRE
166.275–169.400	GOVT, BIFC
169.445–169.505	Wireless Mikes, GOVT
169.55–169.9875	GOVT, MIL, USXX
170.000–170.150	BIFC, GOVT, RTV, FIRE
170.175–170.225	GOVT
170.245–170.305	Wireless Mikes
170.350–170.400	GOVT, MIL
170.425–170.450	BIFC
170.475	PUB
170.4875–173.175	GOVT, PUB, Wireless Mikes
173.225–173.5375	MOV, NEWS, UTIL, MIL
173.5625–173.5875	MIL Medical/Crash Crews
173.60–173.9875	GOVT



---

---

**ULTRA HIGH FREQUENCY (UHF)—(300 MHz–3 GHz)**

381.800–383.900 ..... GOVT

**U. S. Government Band (406–450 MHz)**

406.125–419.975 ..... GOVT, USXX

**70 cm Amateur Band (420–450 MHz)**

420.000–450.000 ..... HAM

**Low Band (450–470 MHz)**

450.050–450.925 ..... RTV

451.025–452.025 ..... IND, OIL, TELM, UTIL

452.0375–453.00 ..... IND, TAXI, TRAN TOW, NEWS

453.0125–454.000 ..... PUB, OIL

454.025–454.975 ..... TELB

455.050–455.925 ..... RTV

457.525–457.600 ..... BUS

458.025–458.175 ..... MED

460.0125–460.6375 ..... FIRE, POL, PUB

460.650–462.175 ..... BUS

462.1875–462.450 ..... BUS, IND

462.4625–462.525 ..... IND, OIL, TELM, UTIL

462.550–462.925 ..... GMR, BUS

462.9375–463.1875 ..... MED

463.200–467.925 ..... BUS

**FM-TV Audio Broadcast, UHF Wide Band (470–512 MHz)  
(Channels 14 through 20 in 6 MHz steps)**

475.750 ..... Channel 14

481.750 ..... Channel 15

487.750 ..... Channel 16

511.750 ..... Channel 20

**Note:** Some cities use the 470–512 MHz band for land/mobile service.



## AVOIDING IMAGE FREQUENCIES

You might discover one of your regular stations on another frequency that is not listed. It might be what is known as an image frequency. For example, you might find a service that regularly uses a frequency of 453.275 also on 474.675.

To see if it is an image, do a little math.

Note the new frequency.	474.675
Double the intermediate frequency of 10.7 MHz (21.400) and subtract it from the new frequency.	<u>-21.400</u>
If the answer is the regular frequency, then you have tuned to an image.	453.275

Occasionally, you might get interference on a weak or distant channel from a strong broadcast 21.4 MHz below the tuned frequency. This is rare, and the image signal is usually cleared whenever there is a broadcast on the actual frequency.

## FREQUENCY CONVERSION

The tuning location of a station can be expressed in frequency (kHz or MHz) or in wavelength (meters). The following information can help you make the necessary conversions.

$$1 \text{ MHz (million)} = 1,000 \text{ kHz (thousand)}$$

To convert MHz to kHz, multiply the number of megahertz by 1,000:

$$30.62 \text{ (MHz)} \times 1000 = 30620 \text{ kHz}$$

To convert from kHz to MHz, divide the number of kilohertz by 1,000:

$$141500 \text{ (kHz)} \div 1000 = 141.5 \text{ MHz}$$

To convert MHz to meters, divide 300 by the number of megahertz:

$$300 \div 171 \text{ MHz} = 1.75 \text{ meters}$$

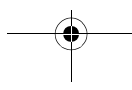

## TROUBLESHOOTING

If your scanner stops operating properly, these suggestions might help you eliminate the problem. If the scanner still does not operate properly, take it to your local RadioShack store for assistance.

PROBLEM	SUGGESTION
Scanner is on, but will not scan.	Be sure <b>SQUELCH</b> is adjusted properly. See "Turning on the Scanner/Setting Volume and Squelch" on Page 16.
	Be sure <b>MAN</b> is not displayed. If it is, press <b>SCAN</b> .
Scanner receives stations poorly or not at all.	Check the antenna (indoor or outdoor).
	Signals may be blocked from being received by the scanner due to metal frames or material in the building. Change the scanner's location and try again.
The scanner's keys do not work, or the display shows random segments.	The scanner might be locked. Reset the scanner. If that does not work, reinitialize the scanner. See "Resetting/Initializing the Scanner" on Page 36.
Scanner does not work at all.	Check that the power supply (AC adapter/AC outlet) is working.
	The scanner might be locked. Reset the scanner. If that does not work, reinitialize the scanner. See "Resetting/Initializing the Scanner" on Page 36.
Scanner locks on frequencies that have an unclear transmission.	Be sure <b>SQUELCH</b> is adjusted properly.
	Be sure birdie frequencies are not programmed, or listen to birdie frequencies manually. See "Birdie Frequencies" on Page 28.

## RESETTING/ INITIALIZING THE SCANNER

If the scanner's display locks up or does not work properly after you connect a power source, you might need to reset or initialize the scanner.

**Important:** If you have problems, first try to reset the scanner. If that does not work, you can initialize the scanner; however, this clears all information stored in your scanner's memory.

### Resetting the Scanner

1. Turn off the scanner, then turn it on again.
2. Insert a pointed object, such as a straightened paper clip, into the **RESET** opening on the back of the scanner (as shown) and gently press then release the reset button inside the opening.

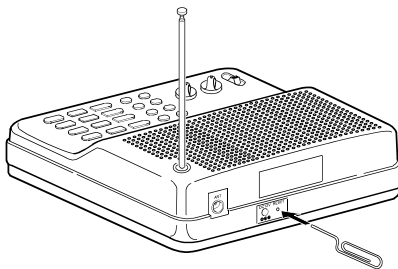

**Note:** If the scanner still does not work properly, you might need to initialize it.

### Initializing the Scanner

**Important:** This procedure clears all information you stored in the scanner's memory. Initialize the scanner only when you are sure the scanner is not working properly.

1. Turn off the scanner, then turn it on again.
2. Hold down **MON/CL**.
3. While holding down **MON/CL**, insert a pointed object, such as a straightened paper clip, into the **RESET** opening on the back of the scanner and gently press then release the reset button inside the opening. The display briefly turns off.
4. When the display turns on again, release **MON/CL**.

**Note:** You must release the reset button before releasing **MON/CL**, otherwise the memory might not clear.



## CARE AND MAINTENANCE

---

Your RadioShack PRO-2015 200-Channel Programmable Home Scanner is an example of superior design and craftsmanship. The following suggestions will help you care for your PRO-2015 so you can enjoy it for years.



Keep the PRO-2015 dry. If it gets wet, wipe it dry immediately. Liquids might contain minerals that can corrode the electronic circuits.



Use and store the PRO-2015 only in normal temperature environments. Temperature extremes can shorten the life of electronic devices, and distort or melt plastic parts.



Keep the PRO-2015 away from dust and dirt, which can cause premature wear of parts.



Handle the PRO-2015 gently and carefully. Dropping it can damage circuit boards and cases and can cause the PRO-2015 to work improperly.



Wipe the PRO-2015 with a damp cloth occasionally to keep it looking new. Do not use harsh chemicals, cleaning solvents, or strong detergents to clean the PRO-2015.

Modifying or tampering with the scanner's internal components can cause a malfunction and might invalidate its warranty and void your FCC authorization to operate it. If your scanner is not performing as it should, take it to your local RadioShack store for assistance.

# SPECIFICATIONS

## Frequency Coverage:

VHF Lo .....	30–50 MHz (in 5 kHz steps)
Amateur Radio .....	29–30 MHz (in 5 kHz steps)
	50–54 MHz (in 5 kHz steps)
	144–148 MHz (in 5 kHz steps)
Air .....	108–136.9875 (in 12.5 kHz steps)
Government .....	137–144 MHz (in 5 kHz steps)
Amateur Radio/Government .....	380–450 MHz (in 12.5 kHz steps)
VHF Hi .....	148–174 MHz (in 5 kHz steps)
UHF Lo .....	450–470 MHz (in 12.5 kHz steps)
UHF “T” .....	470–512 MHz (in 12.5 kHz steps)

Channels of Operation ..... 200 channels and 20 monitor memories

## Sensitivity (20 dB S/N):

29–54 MHz .....	0.5 $\mu$ V
108–136.9875 MHz .....	1.0 $\mu$ V
137–174 MHz .....	0.5 $\mu$ V
380–512 MHz .....	0.7 $\mu$ V

## Selectivity:

$\pm 10$ kHz .....	–6 dB
$\pm 18$ kHz .....	–50 dB

Spurious Rejection ..... 50 dB at 154MHz

Search Speed ..... 50 Steps/Sec.

Scan Speed ..... 25 Channels/Sec.

Delay Time ..... 2 Seconds

IF Frequencies ..... 10.7 MHz and 455 kHz

IF Rejection (10.7 MHz) ..... 70 dB at 154 MHz

## Squelch Sensitivity:

Threshold .....	Less than 1.0 $\mu$ V
Tight, FM ((S + N)/N) .....	25 dB
Tight, AM ((S + N)/N) .....	20 dB

Antenna Impedance ..... 50 ohms

Audio Output Power (10% THD) ..... 800 mW

Memory Backup ..... 1 Hour



---

Built-in Speaker .....	3 inch (77 mm) 8 ohm, Dynamic Type
Power Requirements .....	120 VAC, 60 Hz, 8 W
Operating Temperature .....	+32° to 110°F (0° to 43°C)
Dimensions (HWD) .....	2 <sup>1</sup> / <sub>16</sub> × 8 <sup>1</sup> / <sub>4</sub> × 6 <sup>7</sup> / <sub>8</sub> inches (52 × 210 × 175 mm)
Weight .....	24 oz. (680 g)
Supplied Accessories .....	Telescoping Antenna, AC Adapter

Specifications are typical; individual units might vary. Specifications are subject to change and improvement without notice.

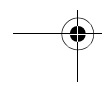
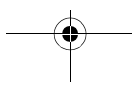
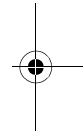
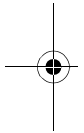

### Limited Ninety-Day Warranty

This product is warranted by RadioShack against manufacturing defects in material and workmanship under normal use for ninety (90) days from the date of purchase from RadioShack company-owned stores and authorized RadioShack franchisees and dealers. EXCEPT AS PROVIDED HEREIN, RadioShack MAKES NO EXPRESS WARRANTIES AND ANY IMPLIED WARRANTIES, INCLUDING THOSE OF MERCHANTABILITY AND FITNESS FOR A PARTICULAR PURPOSE, ARE LIMITED IN DURATION TO THE DURATION OF THE WRITTEN LIMITED WARRANTIES CONTAINED HEREIN. EXCEPT AS PROVIDED HEREIN, RadioShack SHALL HAVE NO LIABILITY OR RESPONSIBILITY TO CUSTOMER OR ANY OTHER PERSON OR ENTITY WITH RESPECT TO ANY LIABILITY, LOSS OR DAMAGE CAUSED DIRECTLY OR INDIRECTLY BY USE OR PERFORMANCE OF THE PRODUCT OR ARISING OUT OF ANY BREACH OF THIS WARRANTY, INCLUDING, BUT NOT LIMITED TO, ANY DAMAGES RESULTING FROM INCONVENIENCE, LOSS OF TIME, DATA, PROPERTY, REVENUE, OR PROFIT OR ANY INDIRECT, SPECIAL, INCIDENTAL, OR CONSEQUENTIAL DAMAGES, EVEN IF RadioShack HAS BEEN ADVISED OF THE POSSIBILITY OF SUCH DAMAGES.

Some states do not allow the limitations on how long an implied warranty lasts or the exclusion of incidental or consequential damages, so the above limitations or exclusions may not apply to you.

In the event of a product defect during the warranty period, take the product and the RadioShack sales receipt as proof of purchase date to any RadioShack store. RadioShack will, at its option, unless otherwise provided by law: (a) correct the defect by product repair without charge for parts and labor; (b) replace the product with one of the same or similar design; or (c) refund the purchase price. All replaced parts and products, and products on which a refund is made, become the property of RadioShack. New or reconditioned parts and products may be used in the performance of warranty service. Repaired or replaced parts and products are warranted for the remainder of the original warranty period. You will be charged for repair or replacement of the product made after the expiration of the warranty period.

This warranty does not cover: (a) damage or failure caused by or attributable to acts of God, abuse, accident, misuse, improper or abnormal usage, failure to follow instructions, improper installation or maintenance, alteration, lightning or other incidence of excess voltage or current; (b) any repairs other than those provided by a RadioShack Authorized Service Facility; (c) consumables such as fuses or batteries; (d) cosmetic damage; (e) transportation, shipping or insurance costs; or (f) costs of product removal, installation, set-up service adjustment or reinstallation.

This warranty gives you specific legal rights, and you may also have other rights which vary from state to state.

RadioShack Customer Relations, 200 Taylor Street, 6th Floor, Fort Worth, TX 76102

*We Service What We Sell*

04/99

**RadioShack**  
**A Division of Tandy Corporation**  
**Fort Worth, Texas 76102**

04A99

GH-9901-1D  
Printed in Hong Kong



## Free Manuals Download Website

<http://myh66.com>

<http://usermanuals.us>

<http://www.somanuals.com>

<http://www.4manuals.cc>

<http://www.manual-lib.com>

<http://www.404manual.com>

<http://www.luxmanual.com>

<http://aubethermostatmanual.com>

Golf course search by state

<http://golfingnear.com>

Email search by domain

<http://emailbydomain.com>

Auto manuals search

<http://auto.somanuals.com>

TV manuals search

<http://tv.somanuals.com>