



rainbowsystem.com

REXAIR LLC | TROY, MICHIGAN

© 2011 REXAIR LLC | R13999A-1 | PRINTED IN U.S.A.

Download from [Www.Somanuals.com](http://Www.Somanuals.com). All Manuals Search And Download.



*rainbow*<sup>®</sup>

BASED ON THE PRINCIPLE THAT

**Wet Dust Can't Fly<sup>®</sup>**

THE RAINBOW<sup>®</sup> USES

**The Power of Water<sup>®</sup>**

TO EFFECTIVELY REMOVE DIRT AND  
AIRBORNE PARTICLES FROM YOUR HOME.



## *customer care number*

As part of Rexair's Customer Care program, each Rainbow and Power Nozzle receives a Customer Care serial number only after passing Quality Control assurance testing. This serial number provides:

- ✓ Ownership identification for you
- ✓ Warranty identification for your Distributor
- ✓ Assurance of passing Quality Control testing
- ✓ Assurance of "factory-fresh" condition

For future reference, record the serial number in the space provided below. No authentic, new Rainbow or Power Nozzle should be sold without this number. If the serial number is missing, Rexair makes no claim as to the origin, age, or condition of the unit. If you are unable to locate a serial number on your Rainbow or Power Nozzle, please contact Rexair's Customer Service Department.

### RAINBOW SERIAL NUMBER

Model: e2 - 73 db(A)

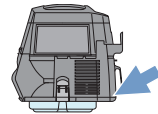

### YOUR AUTHORIZED RAINBOW DISTRIBUTOR

NAME	
ADDRESS	
CITY/STATE/POSTAL	
PHONE	
E-MAIL	



Contact your local Authorized Rainbow Distributor for advice on caring for your Rainbow, warranty coverage, replacement parts and service information.

## A MESSAGE FROM REXAIR®

We would like to take this opportunity to congratulate and thank you for choosing the Rainbow Cleaning System. Your new Rainbow is the result of more than 75 years of continuous product research, development and ingenuity. Today, Rainbow products are sold in all 50 states and in more than 75 countries around the globe. We believe the Rainbow is the most effective and versatile home cleaning system available.

With proper use and care, the Rainbow will significantly improve your indoor living environment and provide years of reliable service. Please take a few minutes to review this guide and familiarize yourself with your new Rainbow Cleaning System.

Should you have questions or experience any issues with your Rainbow, please contact the Distributor or dealer from whom you purchased your Rainbow. If you are unable to contact them, feel free to contact Rexair's customer service department for assistance.



Rexair is a proud member of the Direct Selling Association and adheres to the DSA's Code of Ethics.



The Rainbow® is certified **asthma & allergy friendly™** by the Asthma and Allergy Foundation of America\*.

**CERTIFIED**  
**asthma & allergy**  
**friendly™**

Meets  
ASP:03:03  
Standard for  
Vacuum Cleaners



Asthma and Allergy  
Foundation of America  
[aafa.org/certified](http://aafa.org/certified)

\* ASTHMA & ALLERGY FRIENDLY and ASTHMA & ALLERGY FRIENDLY LOGO are Certification Marks and Trademarks of ALLERGY STANDARDS LIMITED. THE ASTHMA AND ALLERGY FOUNDATION OF AMERICA is a Registered Trademark of AAFA.

**Rexair®**  
LLC

50 W. Big Beaver Road, Suite 350  
Troy, Michigan 48084  
United States of America

(248) 643-7222

[custserv@rexairllc.com](mailto:custserv@rexairllc.com)  
[rainbowsystem.com](http://rainbowsystem.com)

Rainbow®, RainbowMate®, RainMate®, AquaMate®, Rexair®, The Power of Water®, Wet Dust Can't Fly® and the configuration of the Rainbow® Cleaning System are registered trademarks of Rexair LLC, Troy, Michigan, United States.

# important safety instructions



**PLEASE READ ALL INSTRUCTIONS BEFORE USING THESE APPLIANCES  
USE ONLY MANUFACTURER'S RECOMMENDED ATTACHMENTS**

**! WARNING:** To reduce the risk of fire, electric shock, or injury, when using an electrical appliance, basic precautions should always be followed. This, of course, is true of any use of electricity when electrical fixtures or appliances that can develop shorts.

1. Close supervision is necessary when any appliance is used near children. Do not allow your Rainbow to be used as a toy or to run unsupervised at any time. Rainbow appliances and accessories are not intended for use by children.
2. Unplug the Rainbow when not in use. Turn it off at the master switch before unplugging. Grasp the plug to disconnect it from the wall outlet to avoid damage to cord, plug, prongs or receptacle. Do not pull or carry by cord, use cord as a handle, close a door on cord, pull or carry around sharp edges or corners. Do not run appliance over cord. Keep cord away from heated surfaces. Do not use with damaged cord or plug.
3. Do not leave appliance when plugged in. Unplug Rainbow from outlet when unattended and before servicing.
4. If your Rainbow or Rainbow accessory is in disrepair, do not attempt to operate. If the Rainbow is not working properly, has been dropped, damaged, left outdoors or dropped into water, contact an Authorized Rainbow Distributor or Service Center for inspection.
5. Do not clean the unit or unclog the hose until the Rainbow is switched off and the plug is removed from the wall outlet.
6. Do not connect to the receptacle of an incandescent light fixture or use any extension cords. Do not use with portable transformers or voltage converters.
7. Do not use the Rainbow or Rainbow accessory to unplug drains. If sewer gas is drawn into the Rainbow, it could cause an explosion.
8. Never touch a metal sink, cold or hot water pipe with one hand while touching the metal parts of any electrical appliance, light fixture or switch with the other hand. Your body could complete an electrical circuit to the ground. Additionally, wet skin surfaces can greatly increase this hazard. Do not handle plug or appliances with wet hands.
9. (A) Do not put any objects into openings; Do not use with any openings blocked; keep free of dust, lint, hair and anything that may reduce airflow; (B) Keep hair, loose clothing, fingers and all parts of the body from openings and moving parts; (C) Use extra care when cleaning on stairs.
10. Do not pick up anything that is burning or smoking, such as cigarettes, matches or hot ashes. Do not use to pick up flammable or combustible liquids, such as gasoline, or use in areas where they may be present.
11. To avoid the possibility of fire or explosion, do not use Rainbow or Rainbow accessories in areas where flammable and/or explosive vapor or dust is present. Some cleaning fluids can produce such vapors. Areas where flammable cleaning fluids have been used should be completely dry and thoroughly aired before being vacuumed.
12. This appliance is provided with double insulation. Use only identical replacement parts. See instructions for servicing of double-insulated appliances.
13. The Rainbow is equipped with an interlock switch that prevents the unit from operating if the water basin is not properly latched. **DO NOT ATTEMPT TO OVERRIDE THIS SAFETY FEATURE.**
14. **IMPORTANT:** The electrified hose contains electrical wires and should be inspected regularly. Do not use if damaged, cut or punctured. Avoid picking up sharp objects. Do not immerse in water for cleaning. Always turn off this appliance before connecting or disconnecting the hose or motorized nozzle.

15. Your Rainbow Power Nozzle contains a powerful revolving brush. To avoid bodily injury, the Rainbow Power Nozzle should not be placed against or close to loose clothing, jewelry, hair or body surfaces while Rainbow is connected to electrical outlet. The Power Nozzle does NOT protect against bodily injury or damage to objects that contact the revolving brush.
16. To reduce the risk of electric shock, this appliance has a polarized plug (one blade is wider than the other). This plug will fit in a polarized outlet only one way. If the plug does not fit fully in the outlet, reverse the plug. If it still does not fit, contact a qualified electrician to install the proper outlet. Do not change the plug in any way.
17. Type Y power cords must be replaced by an Authorized Rainbow Distributor. If the cord is damaged, turn off the power switch on the Rainbow and unplug the unit.
18. Do not operate any fan with a damaged cord or plug. Discard fan or return to an Authorized service facility for examination and/or repair.
19. Do not run cord under carpeting. Do not cover cord with throw rugs, runners, or similar coverings. Do not route cord under furniture or appliances. Arrange cord away from traffic area and where it will not be tripped over.

**⚠ WARNING:** The electrified hose contains electric wires. To reduce the risk of electric shock: Do not immerse in liquid. Do not use or repair a damaged hose. Use only with Rainbow accessories on carpet moistened by cleaning process.

**⚠ WARNING:** Because of the danger of shock, any electrical appliance should be used only as directed. There should be no unapproved use of any electrical product. Electrical leakage and shorts can occur whenever there is electricity. If the user is standing on the ground, in a basement or in a room where a film of water can reach the ground, severe shock could result. Therefore, use the Rainbow only as directed in this Owner's Manual.

**⚠ CAUTION:** The Rainbow water basin will not trap materials that are resistant to the wetting action of water, including oily or greasy compounds (such as soot or ashes) and powdery substances (such as ceramic, drywall or plaster dust). Do not use the Rainbow to pick up or in the vicinity of any volatile or toxic materials.

## SERVICING OF DOUBLE-INSULATED APPLIANCE

In a double-insulated appliance, two systems of insulation are provided instead of grounding. No grounding means is provided on a double-insulated appliance, nor should a means for grounding be added to the appliance. Servicing a double-insulated appliance requires extreme care and knowledge of the system and should be done only by qualified Rainbow service personnel. Replacement parts for a double-insulated appliance must be identical to the parts they replace. A double-insulated appliance is marked with the words "DOUBLE-INSULATION" or "DOUBLE-INSULATED." The Symbol (square within a square) may also be marked on the appliance. Any servicing other than cleaning should be performed by an Authorized Rainbow Distributor or Service Center.



**SAVE THESE  
INSTRUCTIONS**

THIS APPLIANCE IS INTENDED FOR HOUSEHOLD USE ONLY  
USE THE RAINBOW ONLY AS DIRECTED IN THIS OWNER'S MANUAL

# get acquainted with your rainbow®

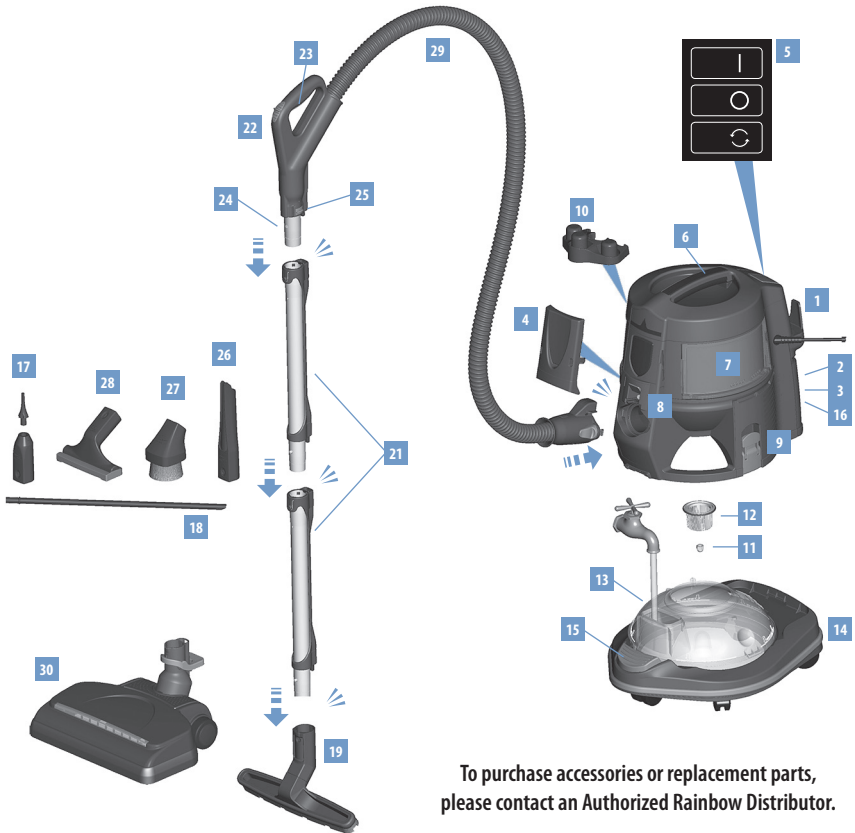

To purchase accessories or replacement parts,  
please contact an Authorized Rainbow Distributor.

- |                          |  |                             |
|--------------------------|--|-----------------------------|
| 1. Cord Wrap             | 12. Separator                              | 22. Pistol Grip Hose Handle |
| 2. Exhaust Vent Plate    | 13. Water Basin                            | 23. Hose Handle Trigger     |
| 3. Exhaust Air Opening   | 14. Dolly                                  | 24. Hose Handle Wand        |
| 4. Airflow Adapter       | 15. Dolly Foot Latch                       | 25. Airflow Control Vent    |
| 5. Power Selector Switch | 16. HEPA Neutralizer                       | 26. Crevice Tool            |
| 6. Handle                | 17. Confined Space Cleaner & Inflator Tool | 27. Dusting Brush           |
| 7. Power Unit            | 18. Refrigerator Coil Cleaner              | 28. Upholstery Tool         |
| 8. Air Inlet Opening     | 19. Floor & Wall Brush                     | 29. Electrified Hose        |
| 9. Water Basin Latches   | 20. Cushion Bag (Not shown)                | 30. Power Nozzle*           |
| 10. Attachment Caddy     | 21. Cleaning Wands                         |                             |
| 11. Separator Nut        |  |                             |

\* Shown with optional Power Nozzle

# power & control at your fingertips

## Power Selector Switch

The power selector switch controls the speed of the Rainbow's motor.

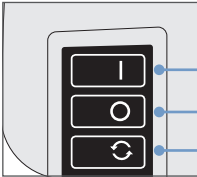

**HIGH:** Use this setting for general cleaning.

**OFF:** Turns the entire unit off.

**LOW:** Use this setting for cleaning the air. (See page 13.)

## Airflow Control Vent

The airflow control vent on the hose handle can be opened or closed to control airflow when vacuuming delicate items such as curtains and to make the Power Nozzle easier to push on dense carpet. As you clean, you can quickly determine the proper adjustment.

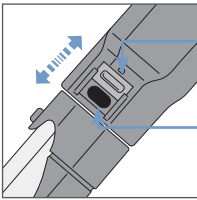

**REDUCED AIRFLOW:** Keep vent open and adjust as needed for different cleaning jobs.

**FULL POWER:** Keep vent fully closed for maximum cleaning performance.

## Trigger Lock Switch

The hose handle's trigger lock switch controls the functionality of the electrified hose when using the Power Nozzle, RainbowMate, RainJet and AquaMate.

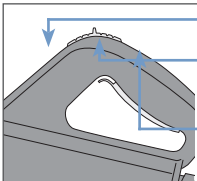

**FORWARD POSITION:** Locks trigger - power is off.

**MIDDLE POSITION:** (Recommended) Squeeze trigger to activate or release to turn off.

**BACKWARD POSITION:** Trigger is locked - power is on.

## Attachment Caddy



Bring along your most used tools as you clean from room-to-room using the convenient onboard Attachment Caddy. Attach to the front of the Rainbow by slipping over the front of the housing into notches located on either side. Press downward to lock in place. Attachments are stored by slipping them over the posts on the caddy. The attachment caddy can also be attached to the wand.



# *quick-start guide*

In just a few quick steps, you'll have your Rainbow assembled and ready to begin cleaning.

## **1. Fill water basin...**

Start with cool water from the faucet. Fill the water basin until the top of the dome in the bottom of the basin is covered. Overfilling or under filling will reduce cleaning performance. Water should be replaced when water action is visibly reduced.

## **2. Clamp Rainbow to water basin...**

Align and set the Rainbow on top of the water basin. Hook the two water basin latches on each side of the Rainbow to the rim of the water basin and snap up. To disconnect from water basin, release the two clamps and lift Rainbow. The Rainbow will not operate without the water basin attached.

## **3. Place Rainbow on dolly...**

Place Rainbow with water basin attached on dolly, matching the protruding end of the Rainbow with the protruding end of the dolly as shown. A foot latch locks Rainbow into place. To release, press foot latch.

## **4. Attach hose...**

Press hose coupling into air inlet opening of power unit until hose clicks. To remove, squeeze both latches and pull hose from power unit.

## **5. Connect Wands...**

Insert the male end of one wand into the female end of second wand. Press wands together until button lock clicks. To disconnect, press button on wands and pull apart.

## **6. Connect hose-handle wand...**

Insert the hose-handle wand into the female end of top wand. Push until button lock clicks. To disconnect, press button on wand and pull apart.

## **7. Select an attachment...**

Determine what type of cleaning you will be performing (see chart on page 11), then insert the desired attachment into the bottom wand or pistol grip hose handle wand. Button will lock into hole on either wand. To disconnect, press button on wand and pull off.

## **8. Plug in the Rainbow and turn on...**

Plug the power cord into your most convenient wall outlet. Select HIGH for maximum cleaning performance.

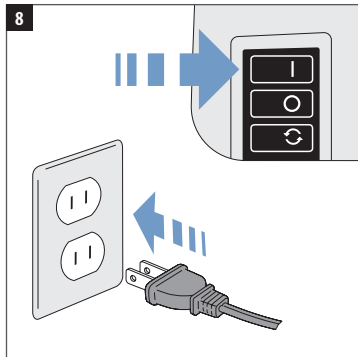
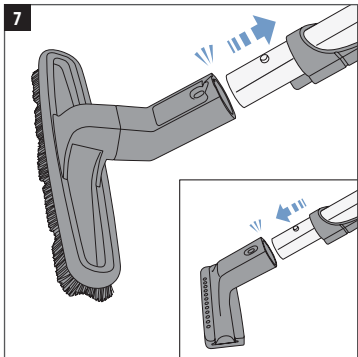
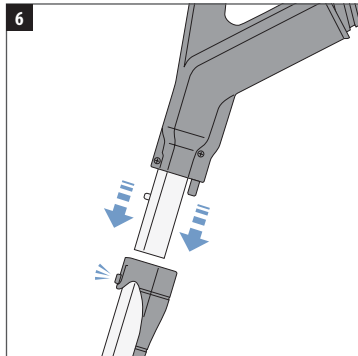
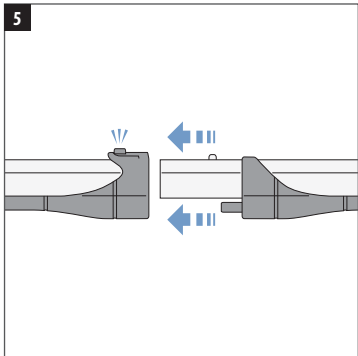
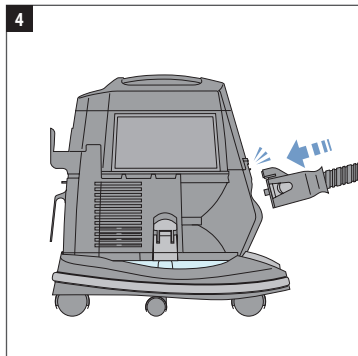
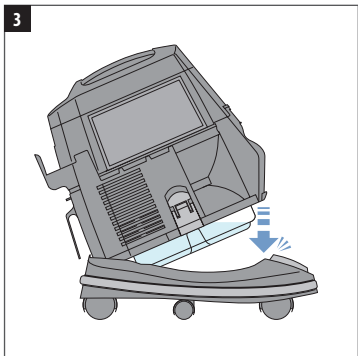
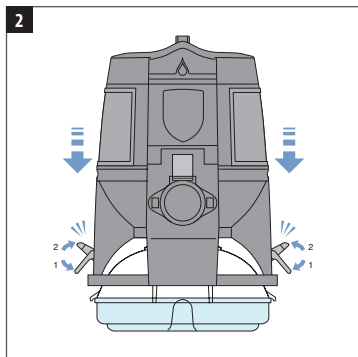
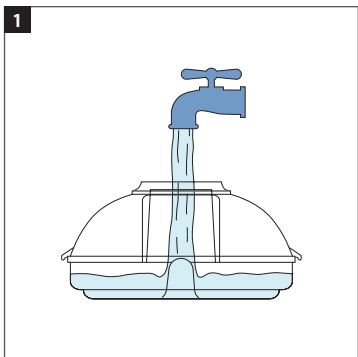

# proper use & care

Following a few basic maintenance routines will help provide you with years of trouble-free service from your Rainbow Cleaning System. Neglecting all or part of these instructions may lead to decreased cleaning efficiency and potentially unnecessary service expenses.

## Change the water when dirty...

Do not clean too long with one filling of water. Check water during cleaning, and if water becomes too thick with lint and dirt, empty water basin and add fresh, clean water. The correct water level is the top of the post in the center of the water basin. Never fill the water basin above this post.

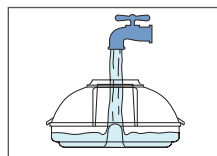

## Always empty and clean the water basin...

Immediately after using the Rainbow, remove the water basin and pour out the dirty water through the air intake opening. Heavier particles will settle to the bottom of the basin as the water is poured. Once water is poured, remove the remaining heavier debris and dispose. Then wash the water basin with soap and water. Rinse and dry thoroughly. **Do not** store the Rainbow on top of the water basin.

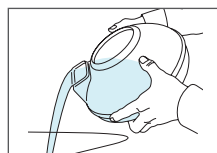

**⚠ CAUTION:** Always remove, empty and wash the water basin when cleaning job is finished. This helps to avoid odors, growth of germs and bacteria, and the development of water scum in the basin. Hand wash only. Not dishwasher safe.

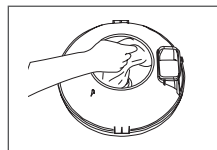

## Clean the separator...

For best performance, remove and clean the separator frequently. If necessary, use the supplied Rainbow Separator Brush/Wrench to loosen the nut. Clean separator inside and out with soap and water using the Rainbow Separator Brush. Clean and dry the flange under the separator. Immediately after cleaning, dry and replace the separator. Hand-tighten the separator nut. Do not force the separator onto the threaded shaft.

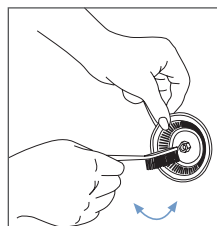

**⚠ WARNING:** Always replace the separator immediately after cleaning (hand-tighten only). Do not operate the Rainbow without the separator.

## Clearing an obstruction from the hose...

If you notice decreased airflow when using the hose, the hose may have become clogged. To clear obstruction, turn off Rainbow and disconnect from power source. Then, remove the exhaust vent door on the rear of the Rainbow. Connect the hose coupling to the exhaust air opening, making sure both latches are locked. Place the hose handle wand into the air intake opening on the front of the Rainbow. Turn the Rainbow on and jiggle the hose. Any dirt stuck in the hose will be trapped in the Rainbow water basin.

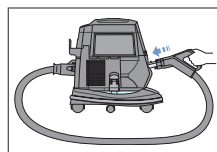

# a complete home cleaning solution

The Rainbow's wide assortment of cleaning tools provide the power and versatility to clean practically everything around your home.

ATTACHMENT	Furniture	Between cushions	Window Treatments	Stairs	Bare Floors	Carpeted Floors & Rugs	Walls	Hard-to-Reach Spaces
Dusting Brush	✓		✓					
Upholstery Tool	✓		✓	✓				
Crevice Tool	✓	✓		✓				✓
Floor and Wall Brush				✓	✓		✓	
Power Nozzle*					✓	✓		
RainbowMate*	✓			✓				
RainJet*					✓			
Squeegee*					✓			
Rexafoamer*						✓		
Inflator / Confined-Space Cleaner		✓						✓

\* Available as an optional accessory. For more information, contact an Authorized Rainbow Distributor.

**! CAUTION:** Always clean attachments before using on fabrics. To avoid abrasions to delicate surfaces, keep the dusting brush bristles clean.

**! CAUTION:** Do not use attachments to clean flat-screen televisions or computer screens.

## Cleaning the attachments...

The floor and wall brush, dusting brush and upholstery tool can be whisked clean with the open end of Rainbow hose while Rainbow is running; or remove attachment and clean in warm, soapy water. Allow to dry before replacing. If bristles wear out or become damaged, contact your local Rainbow Distributor for replacement.

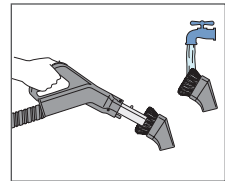

## Using the Airflow Adapter...

The Rainbow Airflow Adaptor reduces air noise through the air inlet opening. It is recommended to use the adaptor when the Rainbow is used as a blower or inflator. Simply snap the Airflow Adaptor into the air inlet opening before using the Rainbow as a blower or inflator.

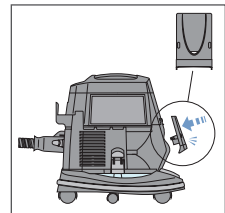

# *a complete home cleaning solution*

## **To clean bare floors...**

Use the **floor & wall brush**. For clean and attractive looking hardwood floors and linoleum tile, the floor and wall brush does an outstanding job of removing surface litter and dirt. Consistent use will help prevent scratches caused by floor debris. Set Airflow Control to FULL POWER.

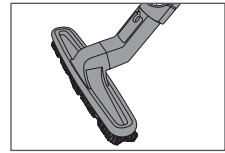

## **To clean carpeted floors...**

Use the **Power Nozzle™**. The lightweight Rainbow Power Nozzle removes dirt from deep within your carpet and large rugs. It's powerful revolving brush loosens lint, threads, hair and dirt, leaving your carpet soft and clean. Active brush edge cleaners help remove dirt trapped along carpet edges, along baseboards or next to furniture. Set Airflow Control to FULL POWER.

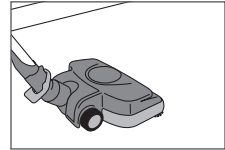

## **To dust...**

Use the **dusting brush**. Because the Rainbow traps dust in water and releases only water-washed air back into the home, your home will require less dusting. However, to keep your home thoroughly clean, don't forget to dust overlooked places such as windowsills, picture frames, venetian blinds, lamp shades, lighting fixtures, moldings, houseplants, hats, clothing, screens, drapes and curtains. On lamp shades and similar fragile objects, reduce the suction by opening the Airflow Control Vent. For delicate objects, airflow may be further reduced. **TIP:** Attach the dusting brush to the optional extended hose\* to reach ceiling fan blades, cornice boards and cobwebs.

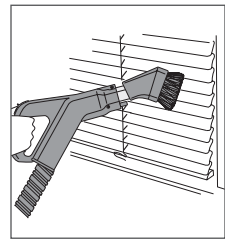

## **To clean walls...**

Use the **floor & wall brush**. All walls ... papered, paneled or painted ... stay cleaner longer when dust and dirt are removed regularly. Start from the ceiling and make your way to the floor, using slow downward strokes. For best results, allow only the top edge of brush to contact the wall. With a slight space between the wall and bottom edge of brush, dust is removed before the bristles touch it, thus avoiding streaks. Set Airflow Control to FULL POWER.

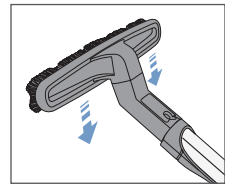

## **To clean narrow spaces...**

Use the **crevice tool**. Use the crevice tool to clean in narrow and tight spaces, such as between radiator sections, under radiators, along floor edges and baseboards and deep down between cushions. Set Airflow Control to FULL POWER.

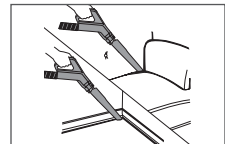

## **To clean carpeted stairs...**

Use the **upholstery tool**. To clean carpeted stairs, remove the Rainbow from the dolly. Allow the Rainbow to rest solidly on the stair above the one you are cleaning. Grasp the handle and move the Rainbow one step at a time as you continue cleaning each stair. Invert the upholstery tool 90 degrees to clean stair risers. Set Airflow Control to FULL POWER.

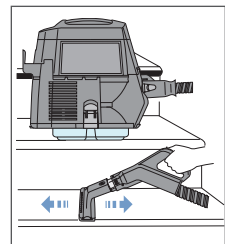

\* Available as an optional accessory. For more information, contact an Authorized Rainbow Distributor.

# a complete home cleaning solution

## For fresh, water-washed air...

The Rainbow not only cleans your floors and furnishings, it cleans the air! Simply add water to the basin, position the Rainbow in the center of a room and run in low-speed mode for about one hour. The Rainbow will remove heavy odors, airborne dust and other particles from the air, trapping them in the water.

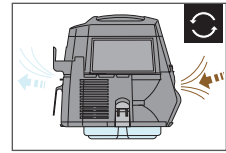

## To deodorize...

Use **Rainbow Fresh Air Solution**.<sup>®</sup> Before using the Rainbow, simply add one capful of Rainbow Fresh Air Solution to the water in the basin. The Rainbow will quickly circulate and refresh the air in the entire area while you clean, alleviating many objectionable household odors.

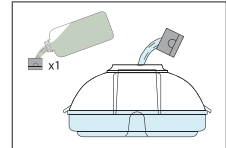

## To aromatize...

Use **Rainbow fragrances**. Add a few drops of any Rainbow fragrance to the water in the basin. Place the Rainbow in the center of the room and run in low-speed mode. In a matter of minutes, a pleasant fragrance will permeate your home.

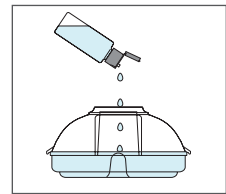

## To clean furniture fabric...

Use the **upholstery tool**. Deeply embedded dirt can reduce the life and vibrancy of fabric. The Rainbow Upholstery Tool effectively removes dirt from upholstered furniture. With Rainbow's exclusive jet brush attached, surface litter and pet hair disappears like magic. Use the upholstery tool on sofas, chairs, mattresses, pillows, blankets, closet shelves, drapes and curtains. The upholstery tool may be used alone or with the Jet Brush attached. **TIP:** This tool is also great for gently cleaning clothing and outerwear - including wool, fur coats and delicate fabrics. Adjust Airflow Control to fit your cleaning situation.

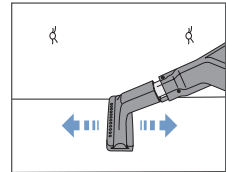

## To clean vents...

Use the **dusting brush**. Floor and ceiling vents collect and recirculate dust throughout your home. The soft dusting brush bristles get in between the vent slots, easily removing stubborn dirt and trapped debris. Set Airflow Control to FULL POWER.

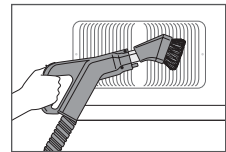

## To fluff cushions and pillows...

Use the **cushion bag**. This handy plastic bag removes stale, dusty air from cushions and pillows and is sized to fit even your largest cushions. Begin by placing a cushion in the bag. With the upholstery tool attached to end of hose handle wand, hold the cushion bag tightly in place around the wand, turn on the Rainbow and watch as stale, dusty air is sucked out. Without letting go of the bag at the wand, disconnect the hose from the front of the Rainbow and attach to the Rainbow's exhaust air opening. Your cushion is now being "fluffed" with clean, water-washed air.

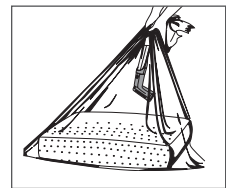

# a complete home cleaning solution

## To freshen bedding...

Use the upholstery tool. Mattresses, box springs, bed frames, pillows, cots and sleeping bags can be thoroughly cleaned with the Rainbow Cleaning System. Use the upholstery tool to loosen and eliminate hairs, dead skin, bed bugs, crumbs and other particles from your bedding.

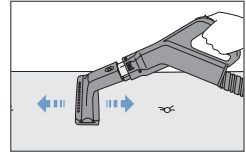

## To inflate or blow air...

Use the inflator tool. The Rainbow inflator tool works great for quickly inflating air mattresses, beach balls and other inflatable toys.

**⚠ WARNING:** Be sure inflator pin is properly locked in place. If not, it will be blown forcefully from the tool body.

### INSTRUCTIONS:

1. Remove the rear exhaust panel on the Rainbow.
2. Attach Rainbow hose to exhaust opening.
3. Attach Inflator Tool to hose handle wand end.
4. Set Airflow Control Setting to FULL POWER.
5. Attach inflator tool to hose handle.
6. Carefully insert the inflator pin into the inflator stem of the object to be inflated.
7. Turn Rainbow switch to HIGH.

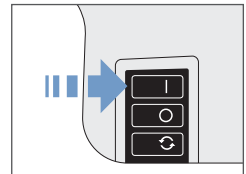
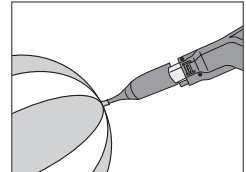
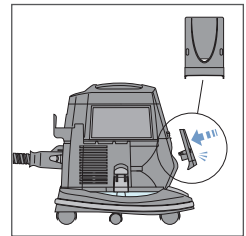
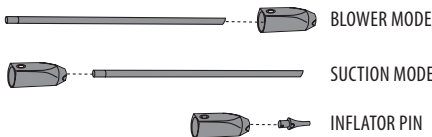

## To clean tight areas...

Use the confined-space cleaner. For detailed cleaning of extra difficult-to-reach areas, use the confined-space cleaner. This versatile tool can be used with either the inflator pin or flexible coil cleaner, depending on your specific cleaning situation.

**TIP:** The confined-space cleaner works great for detailing the interior of your vehicle.

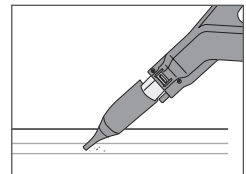

## To clean under refrigerators...

Use the coil cleaner. One of the most commonly overlooked areas when cleaning the home is underneath the refrigerator. Refrigerator cooling coils attract dust and crumbs, and can become less effective and energy-efficient when covered in dirt. Due to its slender design, the coil cleaner can be used to easily vacuum off the visible cooling coils of your refrigerator and underneath your washer or dryer.

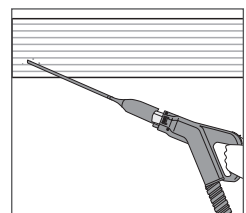

# enhance your rainbow® with accessories

For more information about these products, please contact an Authorized Rainbow Distributor.

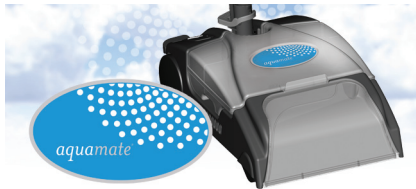

The AquaMate carpet cleaning extraction unit allows you to achieve professional results without the professional price tag. The AquaMate works effectively on most carpet types and dries quickly. Stains caused by spilled beverages, pets and tracked mud can be removed quickly. Your neighbors will think your carpets were professionally cleaned. Use with AquaMate Carpet Cleaning solution for superior cleaning results.



Goes where no mop has ever gone before. The RainJet's self-contained, large-capacity solution tank allows superior cleaning for those bigger cleaning jobs. The Sponge and Brush attachments can be used interchangeably on tile or linoleum floors to scrub away embedded dirt and debris. Flip the Sponge over and the Squeegee Pickup Blade leaves floors spotless. Use with Clean Floor solution for superior cleaning results.



The RainbowMate's sleek, lightweight design allows you to access and clean smaller surfaces such as stairs, upholstery and vehicle interiors. The RainbowMate has a motor-driven brush for maximum cleaning performance.



Ready for a Breath of Fresh Air? The RainMate gives you sweet-smelling air in the most practical, unique and attractive manner possible. Simply add a few squirts of your favorite Rainbow fragrance or Rainbow Fresh Air solution into the RainMate water basin and experience the great outdoors.

## Jumbo Floor & Wall Brush

The 14-inch wide Jumbo Floor & Wall Brush covers a larger area, allowing you to clean large surface more quickly.

## 4-Quart (3.76 Liter) Water Basin

The 4-Quart Water Basin is available for larger cleaning jobs, allowing you to clean for longer periods without changing the water. The 4-Quart water basin fits the Rainbow dolly and doubles the cleaning capacity of the Rainbow.

## Extended Hose

The 14-foot Extended Hose provides additional reach when using Rainbow attachments and the Power Nozzle. Convenient for cleaning large stairways and tall ceilings.

## Rexafoamer

The Rexafoamer creates "dry" suds from liquid shampoo. Your rugs and carpets can be shampooed inexpensively, yet professionally, right in the home. Use with Rexafoamer Shampoo solution for superior cleaning results.



# the rainbow® power nozzle™\*

The lightweight Rainbow Power Nozzle removes dirt from deep within your carpet, large rugs and hard surface floors. Its powerful revolving brush loosens lint, threads, hair and dirt, leaving your carpet soft and clean. Active brush edge cleaners help remove dirt trapped along carpet edges, along baseboards or next to furniture. Set Airflow Control to FULL POWER.

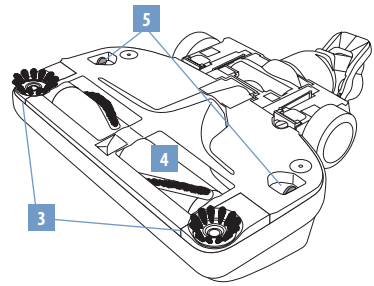
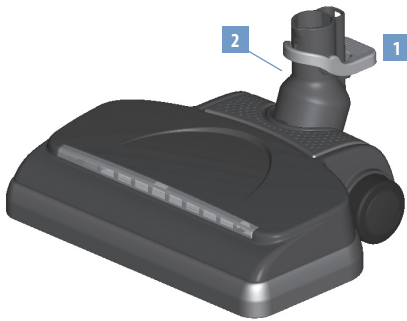

\* Available as an optional accessory. For more information, contact an Authorized Rainbow Distributor.

1. Foot Release
2. Pivot Arm
3. Active Edge Brushes

4. Brush Roll
5. Sole Plate Release Tabs

Contact an Authorized Rainbow Distributor for replacement Power Nozzle belts and other supplies.

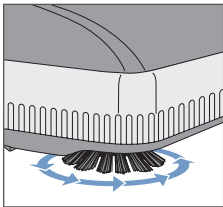

## Active Edge Cleaning...

The Rainbow Power Nozzle features active brush edge cleaners on both sides. Guide either side of the Power Nozzle along baseboards or next to furniture to help remove dirt trapped along carpet edges.

- ⚠ WARNING:** To avoid risk of electrical shock, NEVER pick up water or any other fluids with the Power Nozzle.
- ⚠ CAUTION:** Use the Power Nozzle for dry pick-up only. Do not use outdoors or on wet surfaces.
- ⚠ CAUTION:** Never pick up hard or sharp objects with the Rainbow Power Nozzle. Items such as pins, hairpins, tacks, crayons and pencil stubs may cause damage to the brush roll or belt.
- ⚠ CAUTION:** Always make sure your Rainbow is unplugged before attaching your Power Nozzle.
- ⚠ CAUTION:** Always disconnect unit from electrical supply when servicing.
- ⚠ CAUTION:** Do not oil motor. The motor is permanently lubricated and sealed.

# power nozzle™ assembly & operation

## Assembly

- a. Prior to using the Power Nozzle, follow the Quick Start Guide on pages 8-9 to prepare the Rainbow.
- b. Insert the bottom wand with male end into the opening located on top of the Power Nozzle. Press downward until button lock clicks.

## Operation

- a. Plug in the Rainbow.
- b. Turn the Rainbow power switch to HIGH mode.
- c. On the hose handle, turn the Airflow Control Vent to FULL POWER.
- d. To disengage from the upright position, place your left foot on top of the Power Nozzle. Next, grasp the wand assembly and pull backward.
- e. Squeeze the trigger on pistol grip hose handle to activate the Power Nozzle. Release trigger to turn Power Nozzle off. Optional: Use the trigger lock switch. (See page 7.)
- f. Guide Power Nozzle slowly back and forth over carpet with free and easy strokes. Let the Power Nozzle and Rainbow do the work.
- g. To lock Power Nozzle into the upright position, place your left foot on top of the Power Nozzle. Next, grasp the wand assembly and push forward until wand system is fully engaged in locking tabs.
- h. To disconnect the Power Nozzle from the wand, place your foot on the foot release above the pivot arm.

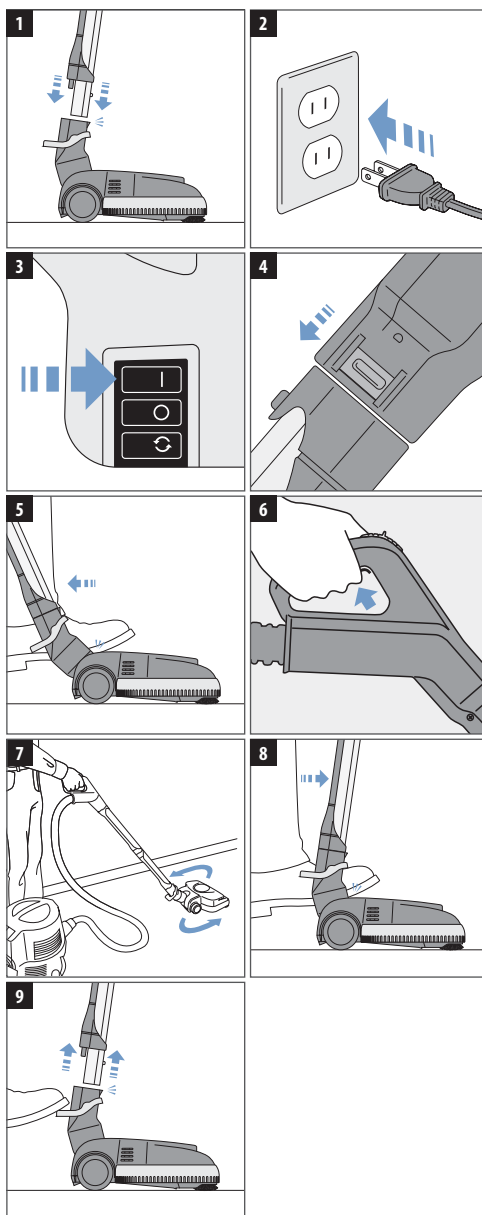

# replacing the power nozzle™ belt

For best performance, we recommend you replace your Rainbow Power Nozzle belt every 12 to 18 months, or when you notice decreased cleaning performance. Your Power Nozzle comes with one replacement belt, and can be easily changed in just a few minutes. This replacement belt is located in the spare belt pocket under the sole plate. For additional replacement belts, contact an Authorized Rainbow Distributor.

**⚠ WARNING:** Always disconnect from electrical supply when servicing.

1. Turn the Power Nozzle upside down. Using a flat-bladed screwdriver or coin, turn the fastener a quarter-turn to the left (counterclockwise).
2. Using both thumbs, push tabs on both sides of sole plate outward while lifting to unlock.
3. Next, insert index fingers into two side openings near wheels. Pull side tabs up while pushing in to lift off sole plate.
4. Rotate brush roll assembly forward (note that edge cleaning brushes are upside down) and remove.
5. a) Slide worn or broken belt off motor shaft with finger; b) Lift brush roll out and remove worn belt.
6. a) Place new belt over the end of brush roll assembly and slide on; b) Loop new belt around the pulley and position in the center of the brush roll.
7. a) Place brush roll upside down with edge cleaning brushes centered on top of two side tabs. Slide belt over end of motor shaft; b) Rotate brush roll assembly forward until edge cleaning brushes are face up. Spin brush roll toward you to position the belt on the center of the pulley.
8. Position sole plate over top of Power Nozzle cover. Press down until front, two side tabs and back tabs snap and lock in.
9. Using a flat-bladed screwdriver or coin, turn the fastener a quarter-turn to the right (clockwise) to lock sole plate. Assembly is complete.

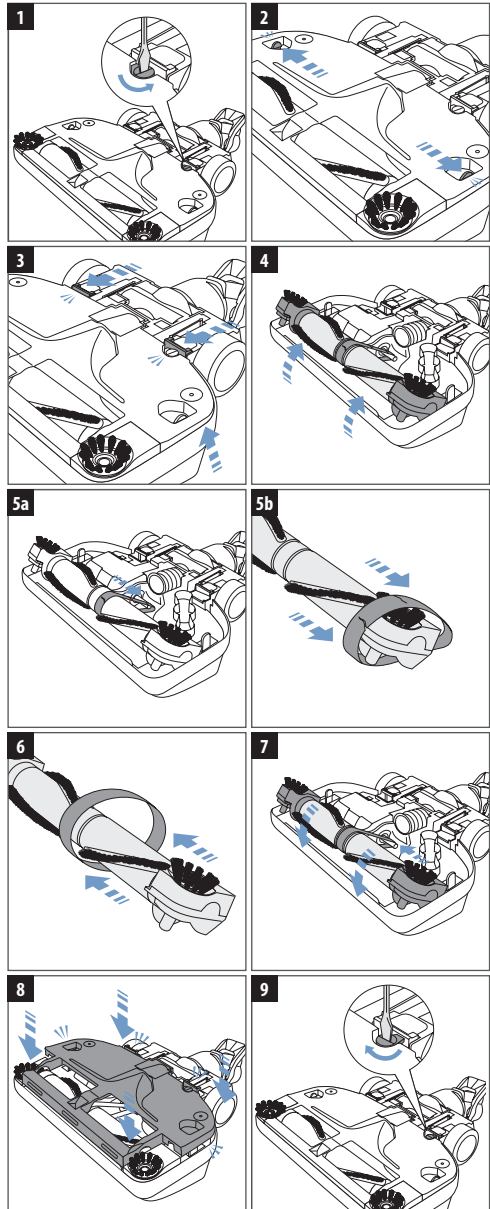

# HEPA neutralizer maintenance

If you observe a decrease in the performance of your Rainbow you should inspect the HEPA Neutralizer. It may require cleaning. Carefully follow these directions to clean the HEPA Neutralizer. We recommend that you have an Authorized Rainbow Service Center inspect your HEPA Neutralizer after two years of use. After five years of use, the HEPA Neutralizer should be replaced (by an Authorized Service Center) to ensure your Rainbow performs its best.

**⚠ WARNING:** Unplug the Rainbow before servicing.

**⚠ CAUTION:** Do not operate the Rainbow without the HEPA Neutralizer.  
NOTE: Do not use detergent or soap to wash the HEPA Neutralizer—use clean water only.

## 1. Remove the HEPA Neutralizer

- Using a screwdriver, remove the panel from the back of the Rainbow by pressing up on the two latches on the underside of the rear panel.
- Move the bottom of the rear panel towards you, lifting up.
- Remove the HEPA Neutralizer.

## 2. Rinse the HEPA Neutralizer

- Place the dirty HEPA Neutralizer in the sink, oval opening facing up.
- Fill the oval opening in the HEPA Neutralizer with cool water from a faucet until the water comes out of the opening. Continue to let the water run over the HEPA Neutralizer for approximately one minute.
- Turn off the water supply. Turn the HEPA Neutralizer over and tap into the sink so that the water escapes from the oval opening.
- Repeat steps B and C until no substantial amount of dirt is seen coming out of the HEPA Neutralizer.
- Shake the HEPA Neutralizer briskly, with oval opening facing down, to remove any excess water.
- To reinstall the HEPA Neutralizer and rear panel, follow the instructions in reverse order.

## 3. Dry the HEPA Neutralizer

- Begin with an empty water basin. Set the Rainbow on the edge of a towel or other absorbent cloth, such that the vent door side of the Rainbow is facing the cloth or towel.
- Install the airflow adaptor onto the front of the Rainbow to dampen noise.
- Run the Rainbow on low speed for a minimum of 5 hours and then on high speed for 1/2 hour to dry the HEPA Neutralizer.
- Excess water from the rinsing process may be emitted onto the towel or absorbent cloth during the high speed portion of the 1/2-hour drying time.
- If cleaning ability is not adequately restored after the HEPA Neutralizer is dry, contact an Authorized Rainbow Distributor.

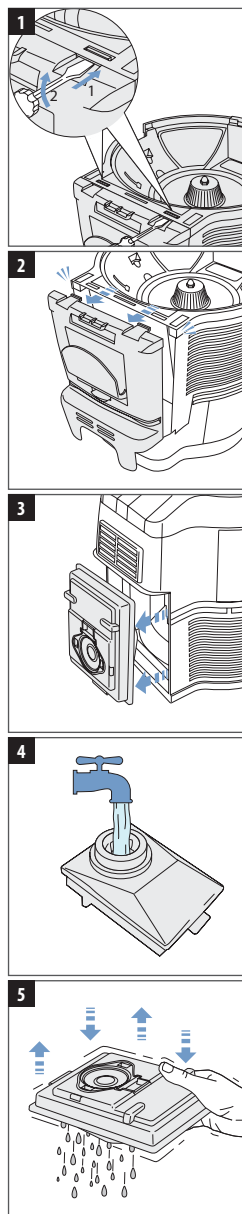

# troubleshooting guide

This Rainbow appliance has been thoroughly tested and inspected. If a minor issue develops, the following troubleshooting procedures may help identify and correct the issue. If you are unable to resolve the issue, contact an Authorized Rainbow Distributor for service. Any service procedure not listed below should be performed by an Authorized Rainbow Distributor or Service Center.

**⚠ WARNING:** Disconnect electrical supply before performing maintenance to the unit. Failure to do so could result in electrical shock or personal injury.

ISSUE	POSSIBLE CAUSE	POSSIBLE SOLUTION
The Rainbow motor is not running.	Rainbow not properly latched to water basin. Air inlet screen is plugged with debris.	Ensure side latches of water basin are locked.
	Not firmly plugged in.	Plug unit in firmly or try another outlet.
	Air inlet screen is plugged with debris.	Clean off debris thoroughly.
	Automatic resetting motor protector has tripped.	Turn Rainbow off. Leave off for 30 seconds. Turn Rainbow back on.
Noticeably reduced airflow.	Defective cord, switch or Rainbow.	Contact an Authorized Rainbow Distributor or Service Center.
	Rainbow not correctly positioned on water basin.	Ensure Rainbow is properly seated and latched onto water basin.
	Plugged hose, wand, attachment or Power Nozzle.	Remove obstruction from clogged area.
	HEPA Neutralizer needs servicing or replacement.	Remove HEPA Neutralizer and clean or replace. (See page 19)
	Rainbow is running on low speed.	Turn power switch to high speed.
	Separator is clogged or dirty.	Remove separator and clean. (See page 10)
Unit discharges dust.	Low level of water in basin.	Fill water basin to correct level.
	Excessively dirty water in basin.	Replace with clean water.
	Hole in HEPA Neutralizer.	Contact an Authorized Rainbow Distributor or Service Center.
Heavy foaming in water basin.	Soapy contaminant in water basin.	Replace with clean water.
	High level of water in basin.	Empty water basin and refill to correct level.

ISSUE	POSSIBLE CAUSE	POSSIBLE SOLUTION
Unit discharges a musty odor	Water basin not cleaned or dumped after use.	Clean water basin and use Deodorant Air Freshener while cleaning.
	Separator clogged or dirty.	Remove separator and clean. (See page 10)
	Damp HEPA Neutralizer.	Remove HEPA Neutralizer and clean or replace. (See page 19)
Machine running hot; Burning odor noticed.	Rainbow stored on water basin.	Do not store Rainbow on water basin.
	Plugged hose, wand, attachment or Power Nozzle.	Remove obstruction from clogged area.
Unusual tone, noise or vibration.	Rainbow not seated on water basin properly.	Ensure Rainbow is properly seated and latched onto water basin.
	Separator clogged or dirty.	Remove separator and clean.
The Power Nozzle motor is not running.	Water level is above center dome in water basin.	Empty water basin and refill to correct level.
	Trigger Lock Switch is in the off position.	Move the switch to the middle position and depress trigger.
	Handle switch is not activated.	Must squeeze actuator in electrified hose handle.
	Wands not connected.	Make sure wands are properly connected.
	Wand connections not made	Make sure wands are seated properly.
	Automatic resetting motor protector has tripped.	Turn Rainbow off. Leave off for 30 second. Turn Rainbow back on.
The Power Nozzle motor is running but brush is not revolving.	Broken belt.	Disconnect power; Remove sole plate; Make sure brush rotates freely; Replace belt.
The Power Nozzle brush is stopped and cannot be rotated by hand.	Object lodged in brush chamber.	Disconnect power; Remove sole plate; Remove foreign object; Make sure brush rotates freely.
	Bearing worn out.	Contact an Authorized Rainbow Distributor or Service Center for a replacement brush.
The Power Nozzle is not picking up debris well.	Clogged air chamber.	Disconnect power; Remove sole plate; Clear out entire air chamber;
	Clogged wands or hose.	Disconnect power; Remove obstruction; Connect to Rainbow; Make sure air is flowing freely through hose.
	Bristles not in contact with carpet.	Make sure sole plate is completely in position before latching; Replace brush if bristles are worn too short.
	Edge cleaning brushes are worn.	Contact an Authorized Rainbow Distributor or Service Center for a replacement edge brushes.

# rainbow® fragrances & cleaning solutions

For more information about these products, please contact an Authorized Rainbow Distributor.



## rainbow® fragrances

Bring the sweet and refreshing smell of a spring garden or the great outdoors into your home with Rainbow fragrances.

*Eucalyptus*  
*Berry*  
*Orange*  
*Lemon*  
*Apple Blossom*

*Pine*  
*Vanilla*  
*Violet*  
*Gardenia*  
*Spice*



## the luxury collection

Indulge your senses with the Rainbow® Luxury Collection, available in four intriguing spa scents.

*Tea Tree Mint*  
*Mandarin Rosewood*

*Orange Ginger*  
*Lavender Juniper*



## fresh air

This highly-concentrated deodorizer and air freshener solution alleviates objectionable household odors such as fish, tobacco, cabbage, paint, etc., while you clean.



## clean floor

Rainbow Clean Floor solution is ideal for thoroughly cleaning linoleum or tile floors. Just spread on Clean Floor solution in and let it do the work.



## aquamate®

Specially formulated for use with the Rainbow AquaMate, the AquaMate Carpet Cleaning solution combines cleaner, deodorizer, protector and reconditioner for superior cleaning results.



## rexafoamer

Rexafoamer Shampoo solution quickly removes unsightly traffic film from rugs and carpets. No hard scrubbing required. Cleanses thoroughly, dries quickly.

## *limited warranty*

Rexair provides to its independent Authorized Rainbow Distributors, and only to them, a written four (4) year warranty on the Rainbow Cleaning System and attached accessories and an eight (8) year warranty on the vacuum cleaner motor/electronic controller. Replacement parts can be new or remanufactured as provided at Rexair's sole discretion. These warranties do not cover normal wear-and-tear arising from usage of the products. Even though Rexair, as the manufacturer, does not deal directly with the consumer nor provide the consumer with a written warranty, the law imposes certain responsibilities on all manufacturers who make consumer products. The products must not be defective and must be generally fit for their intended uses. These implied warranties of merchantability and fitness are honored by Rexair. Further, Rexair requires each Authorized Distributor to pass through to the consumer, by way of the Authorized Distributor's own written warranty, the benefit of Rexair's warranty to such Distributor.

---

**Rexair sells the Rainbow to its independent Authorized Rainbow Distributors for resale by those Distributors and their agents solely through in-home demonstrations to ultimate user-owners. Any other sale, including sales through the Internet, is strictly prohibited. Any product purchased in any other sale is not covered by the Authorized warranties.**

---

The manufacturer, Rexair, has established a proud heritage of selling a superior product through independent Authorized Distributors for more than 75 years, and is committed to the service and support of Rainbow owners.

Rexair sells the Rainbow Cleaning System only to independent Authorized Distributors who are experienced in direct in-the-home selling. These Authorized Distributors assume responsibility for the legitimate distribution and service of the Rainbow Cleaner directly through their own dealers, or indirectly through independent sub Distributors and their dealers.

Rexair has no agreement or legal relationship with the independent resellers who acquire products directly or indirectly from an Authorized Distributor, and can only attempt to correct any customer complaints about such resellers by acting through the responsible Authorized Distributor. Rexair's announced policy is to hold each Authorized Distributor responsible for remedying any complaint from any member of the buying public relating to sales or service by any of these independent resellers.

Rexair further requires that each Authorized Distributor make prompt and workmanlike service available through its own service outlets or through responsible independent service outlets in those communities in which it sells Rexair products through its independent sub Distributors and dealers.

Do not lose the name and address of the Dealer or Distributor from whom you bought the Rainbow Cleaner. Contact him or her for advice on caring for your Rainbow, warranty coverage, service and the nearest service outlet. If you are unable to contact them, or feel you are not receiving proper assistance from the Authorized Distributor, feel free to contact Rexair's customer service department for assistance. They will provide you the name, address and phone number of an Authorized Distributor for your area.





# Clean Air Delivery Rate

Rainbow  
e SERIES e<sup>2</sup>

Certified Rating

From air cleaner to air cleaner, compare the Clean Air Delivery Rate (CADR) numbers. First, look at suggested room size. Then refer to the tobacco smoke, dust and pollen CADR numbers.

**The Rainbow® e<sup>2</sup> is suggested for use in a single closed room up to 90 square feet.**

*Room size ratings conform to the AHAM Certification Program criteria of 80% smoke reduction. Higher Clean Air Delivery Rates provide improved performance in all room sizes. Portable air cleaners will be much more effective in rooms where all doors and windows are closed.*

## CADR Ratings

**Tobacco Smoke: 55**

**Dust: 61**

**Pollen: 67**

The higher the numbers, the faster the unit filters the air.

*These values represent performance that can be expected within the first 72 hours of operation. Subsequent performance may vary with use.*

Association of Home Appliance Manufacturers



ID #: 75932

# SILVER

## Green Label Certified Vacuums

## Superior Cleaning and Indoor Air Quality

- Soil Removal
- Dust Containment
- Fiber Protection

[carpet-rug.org](http://carpet-rug.org)

## Free Manuals Download Website

<http://myh66.com>

<http://usermanuals.us>

<http://www.somanuals.com>

<http://www.4manuals.cc>

<http://www.manual-lib.com>

<http://www.404manual.com>

<http://www.luxmanual.com>

<http://aubethermostatmanual.com>

Golf course search by state

<http://golfingnear.com>

Email search by domain

<http://emailbydomain.com>

Auto manuals search

<http://auto.somanuals.com>

TV manuals search

<http://tv.somanuals.com>