

Paragon II

User Manual

Paragon II



This page intentionally left blank

Paragon II

User Manual Paragon II



Copyright © 2003 Raritan Computer, Inc.
PII-0A-E
December 2003
255-30-6000

Raritan Computer Inc.
400 Cottontail Lane
Somerset, NJ 08873
USA
Tel. 1-732-764-8886
Fax. 1-732-764-8887
E-mail: sales@raritan.com
<http://www.raritan.com>

Raritan Computer Europe, B.V.
Eglantierbaan 16
2908 LV Capelle aan den IJssel
The Netherlands
Tel. 31-10-284-4040
Fax. 31-10-284-4049
E-mail: sales.europe@raritan.com
<http://www.raritan.com>

Raritan Computer Japan, Inc.
Kuga Building 7F
11-6, Kuramae 4-chome
Taitoo-ku, Tokyo 111-0051, Japan
Tel. 81-3-5833-6360
Fax. 81-3-5833-6336
E-mail: sales.japan@raritan.com
<http://www.raritan.co.jp>

Raritan Computer Taiwan, Inc.
5F, 121, Lane 235,
Pao-Chiao Rd., Hsin Tien
Taipei Hsien, Taiwan, ROC
Tel. 886-2-8919-1333
Fax. 886-2-8919-1338
E-mail: sales.asia@raritan.com
<http://www.raritan.com.tw>

This page intentionally left blank

FCC Information

This equipment has been tested and found to comply with the limits for a Class A digital device, pursuant to Part 15 of the FCC Rules. These limits are designed to provide reasonable protection against harmful interference in a commercial installation. This equipment generates, uses, and can radiate radio frequency energy and if not installed and used in accordance with the instructions, may cause harmful interference to radio communications. Operation of this equipment in a residential environment may cause harmful interference.

Product names mentioned in this document are trademarks or registered trademarks of their respective companies. Z-Series, Paragon, MasterConsole MX⁴, MasterConsole MXU2, MasterConsole II, MasterConsole SMX, ConsoleSwitch and their respective logos are registered trademarks of Raritan Computer, Inc. PS/2, RS/6000, and PC/AT are registered trademarks of International Business Machines Corporation. Apple and Macintosh are registered trademarks of Apple Computer, Inc. Lexan is a registered trademark of GE. Windows is a registered trademark or trademark of Microsoft Corporation in the United States and other countries. Sun is a registered trademark of Sun Microsystems. All other marks are the property of their respective owners.

Japanese Approvals

この装置は、情報処理装置等電波障害自主規制協議会（VCCI）の基準に基づくクラスA情報技術装置です。この装置を家庭環境で使用すると電波妨害を引き起こすことがあります。この場合には使用者が適切な対策を講ずるよう要求されることがあります。

*Contact Raritan Technical Support Team at (732) 764-8886 or e-mail us at support@raritan.com
Ask for Technical Support – Monday through Friday, 8:00am to 8:00pm, EST.*



Table of Contents

Chapter 1: Introduction	1
Paragon II Overview.....	1
Product Photos.....	2
Product Features.....	3
Package Contents.....	4
Chapter 2: Installation.....	5
Basic Installation	5
Initial Administrative Testing	7
Paragon II Front Panel Display and Controls	8
Initial Configuration	12
Using the OSUI for Initial Configuration.....	12
Installing a Paragon System with a Single Base Unit.....	13
Installing a Cascaded Paragon System.....	17
Installing a Paragon Stacking Switch	20
Chapter 3: Operation – User Functions	21
Login.....	21
Selecting a Server.....	23
User Customization.....	26
User Profile Parameters and How to Change Settings	27
Help Menu.....	28
Keyboard-Controlled OSUI Functions.....	29
Information Menu	30
Chapter 4: Operation – Administrator Functions	31
The Administration Menu	31
Guidelines for System Configuration	32
System Configuration.....	32
User Configuration	34
Channel Configuration	36
User Station Profile	38
Keyboard Type	38
Video Delay	38
Group Settings (Access Rights).....	39
Recommendations	40
Network Settings.....	41
Autoscanning and Autoskipping.....	42
Power Management.....	43
Configuring and Naming the Power Strip	43
Associating a Target with a Power Outlet	43
Controlling Power to an Outlet.....	44
Paragon II Network Port.....	44
Chapter 5: Paragon II and Z-CIM	45
Connecting Z-CIMs as Tiers	46
Chapter 6: IBM x330	49
Chapter 7: Configurations	51
Principles of Re-Connection	51
Tiered Configurations.....	52
Standard Tiering Configurations.....	52
Stacked Configurations.....	54
Standard Stacking Configurations.....	55
Non-Standard Tier Configuration	58
Guidelines for Existing Firmware Versions.....	58

Illegal Configuration	62
Loop-Back Configuration.....	62
Appendix A: Specifications	63
CAT5 Cable Guidelines.....	64
Appendix B: User Station Direct Mode	65
Appendix C: Configuration and Compatibility.....	67
Configuration Matrix.....	67
Compatibility Matrix.....	67
Appendix D: Paragon II Rack Mount	69
Forward Mount.....	69
Rear Mount	70
Appendix E: Using AUATC for RS-232 Access	71
Introduction to the AUATC.....	71
Installing the AUATC.....	71
Operating the AUATC	72
Screen Layout	72
On-Line Mode.....	73
Help Mode	73
Buffer Edit Mode.....	74
Configuring the AUATC.....	75
Troubleshooting the AUATC.....	77
Appendix F: Emulating Sun Keys with a PS/2 Keyboard	79
Appendix G: Troubleshooting.....	81
Multi-Tier Installation.....	82
Appendix H: FAQ.....	83

Table of Figures

Figure 1 Paragon II Base Units	2
Figure 2 P2-UMT832, P2-UST, and P2CIM-PS2	2
Figure 3 Installation Diagram.....	6
Figure 4 Login Menu.....	7
Figure 5 Selection Menu.....	7
Figure 6 Paragon II Front Panel Buttons.....	8
Figure 7 LCD Normal Display.....	9
Figure 8 Power Up Clear Database.....	9
Figure 9 LCD Functions.....	9
Figure 10 Function Selection.....	9
Figure 11 Display Ver. and SN.....	10
Figure 12 User Station Test.....	10
Figure 13 Channel CIM (UKVM) Test.....	10
Figure 14 Stacking Support.....	10
Figure 15 Set LCD Contrast.....	10
Figure 16 Auto Configure.....	11
Figure 17 Format of OSUI screens.....	12
Figure 18 Rear panel of a Paragon User Station and P2-UMT832M unit.....	13
Figure 19 Login Menu for a P2-UMT832M.....	14
Figure 20 Selection Menu for a P2-UMT832M.....	14
Figure 21 Administration Menu.....	15
Figure 22 Channel Configuration Menu of a P2-UMT832M.....	16
Figure 23 Sample cascaded system.....	17
Figure 24 Selection Menu.....	18
Figure 25 Administration Menu.....	18
Figure 26 Channel Configuration Menu for a P2-UMT832M.....	19
Figure 27 Login Menu for a P2-UMT832M.....	21
Figure 28 Selection Menu for a P2-UMT832M.....	22
Figure 29 Selection Menu in order by Channel Port Number.....	23
Figure 30 Selection Menu in order by Name.....	24
Figure 31 User Profile Menu.....	26
Figure 32 Help Menu.....	28
Figure 33 Information Menu.....	30
Figure 34 Administration Menu.....	31
Figure 35 System Configuration Menu.....	32
Figure 36 The “left end” of the User Configuration Menu.....	34
Figure 37 The “right end” of the User Configuration Menu.....	35
Figure 38 The “left end” of the Channel Configuration Menu.....	36
Figure 39 The “right end” of the Channel Configuration Menu.....	37
Figure 40 User Station Profile Screen.....	38
Figure 41 Network Settings Menu.....	41
Figure 42 Connecting a Z-CIM as a Tier to Paragon II.....	46
Figure 43 IBM x330 Tiered from a Paragon II Matrix Switch.....	49
Figure 44 Single Base Configuration.....	52
Figure 45 Multiple Base Configuration.....	53
Figure 46 Stacking - Single Base Configuration with P2-UMT1664M and P2-UMT1664S.....	55

Figure 47 Stacking - Single Base Configuration with P2-UMT832M and P2-UMT832S.....	55
Figure 48 Stacking - Single Base Configuration with P2-UMT832M and P2-UMT832S.....	55
Figure 49 Stacking - Single Base Configuration with P2-UMT832M and P2-UMT832S.....	56
Figure 50 Stacking - Single Base Configuration with P2-UMT1664M and P2-UMT832S.....	56
Figure 51 Stacking - Single Base Configuration with P2-UMT832M and P2-UMT1664S.....	56
Figure 52 Stacking - Single Base Configuration with P2-UMT1664M and P2-UMT832S.....	57
Figure 53 Stacking - Single Base Configuration with P2-UMT832M and P2-UMT1664S.....	57
Figure 54 Triangle Configuration.....	59
Figure 55 Diamond Configuration.....	60
Figure 56 Redundant Configuration	61
Figure 57 Recommended Redundant Configuration connection scheme.....	62
Figure 58 Illegal Loop-Back Configuration	62
Figure 59 Cat5 Cable Diagram.....	64
Figure 60 Front rackmount of a P2 Base Unit.....	69
Figure 61 Front rackmount of a P2 User Station.....	69
Figure 62 Rear rackmount of a P2 Base Unit.....	70
Figure 63 Rear rackmount of a P2 User Station	70
Figure 64 AUATC screen layout (On-Line Mode)	72
Figure 65 Help screen	73
Figure 66 Buffer Edit Mode screen.....	74
Figure 67 Setup Communication Screen	75
Figure 68 Set Up Programmable Keys screen.....	76

Chapter 1: Introduction

Congratulations on your purchase of Raritan's Paragon II! The Paragon family is about breaking away from the traditional, expensive model of server management – one server, one dedicated monitor, one dedicated keyboard. Paragon allows for a single user station (monitor, keyboard, and mouse) for multiple servers – even servers of different platforms! Why not a pair of user stations, each of which can control multiple servers? Why not many monitors or user stations for the same server? Why not access or display any of your servers, anywhere in the world, with any of your user stations or monitors?

With our Paragon products, there's no reason why not. We carry a broad line of robust solutions for all these applications:

- Do you have just two PCs and need an economical alternative to keeping two mice, keyboards, and monitors on your desk? Or do you need to share many servers, including a mix of IBM PC, RS/6000, Apple Macintosh, Sun Microsystems, and SGI types among multiple worldwide users with different access levels?
- Do you have to send video from one server to two different local monitors? Or do you need to send video from multiple servers to dozens of remote monitors?
- Does your switch have to sit solidly on a worktable and use regular everyday cables? Or does it have to be mounted in an equipment rack, use convenient many-to-one cables, and have a rackmounted user station that folds and slides into 1U of space?

No matter how large or small your setup, no matter how simple or how complex, Raritan is confident that there is a Paragon system just right for you. The Paragon family from Raritan – the one-stop answer for all your video and KVM switching and extension needs!

Paragon II Overview

The Paragon II is designed to perform heavy-duty multiple-user-to-many-server keyboard/video/mouse (KVM) matrix switching without burdening you with big, confusing hydra-headed cables. Instead, the Paragon II uses standard Category 5 unshielded twisted-pair (UTP) cabling, like the type that is already installed at many sites. It can connect users with servers across as much as 1000 ft. (304 m) of such cabling. Paragon II systems consist of three components: Base Units, which do the matrix switching; Computer-Interface Modules (CIMs) connected to each server; and User-Station Modules (User Stations) connected to each set of user-station equipment.

There are a number of Base Unit models that support different numbers of directly attached users and server CPUs:

- Product code P2-UMT242 supports 2 users and 42 CPUs
- P2-UMT442 supports 4 users and 42 CPUs
- P2-UMT832M supports 8 users and 32 CPUs
- P2-UMT1664M supports 16 users and 64 CPUs

There are also several different CIMs for different types of servers (all must output VGA video):

- P2CIM-PS2 and ZCIM-PS2 support CPUs with IBM PS/2 type keyboard and mouse ports; Z-CIM has an extra RJ-45 port to support a "local CPU" installed between a User Station and a Base Unit, as well as chaining of ZCIMs for clustered access.
- P2CIM-SUN supports CPUs with Sun type keyboard and mouse ports
- P2CIM-USB and P2CIM-SUSB support CPUs with USB keyboard and mouse ports
- AUATC supports CPUs connected through their RS-232 serial ports

There is one universal User Station (P2-UST) that supports PS/2, Sun, or USB keyboards and mice. (We recommend that you use a Sun keyboard if there are any Sun CPUs in your system; if you must use a PS/2 keyboard to control Sun CPUs, please see **Appendix F: Emulating Sun Keys with a PS/2 Keyboard** for additional information.) If you want to connect one user station to one CPU across a long stretch of CAT5 or higher cable, you can run such a cable between a "direct mode" User Station and a P2CIM-PS2 (please see **Appendix B: User Station Direct Mode** for additional information).

Product Photos



Figure 1 Paragon II Base Units



Figure 2 P2-UMT832, P2-UST, and P2CIM-PS2

Product Features

- 2U design supports 16 users, 64 servers (model P2-UMT1664M)
- 1U design supports 8 users, 32 servers (model P2-UMT832M)
- 1U design supports 4 users, 42 servers (model P2-UMT442)
- 1U design supports 2 users, 42 servers (model P2-UMT242)
- Expands to 32 users with Raritan's UKVMP2 or CIMPAC8
- Expands to 64 users with Raritan's HUBPAC8
- Locates users and servers up to 1,000 feet apart
- Supports high-resolution video – up to 1600 x 1200
- Supports up to 512 customized user profiles (with optional Memory Card)
- Adds remote access over IP or modem with Raritan's IP-Reach
- Expands to 10,000 servers via multi-dimensional expansion (with optional Memory Card)
- Stacking switches provide 100% non-blocked expansion with a single cable
- Enclosed 19" rack mounts with included brackets
- Simple plug-and-play auto-configure installation
- Hot-swappable components with no impact on server operation
- Platform-specific CIMs for PS/2, Sun, USB, Sun USB, ASCII/serial devices
- Powerful, intuitive on-screen user interface for simple operation
- Flexible, multi-level security for authorized server access
- Three system operation modes - private, public, and share
- Flash firmware upgrades via network port
- Paragon Manager™ Windows application provides streamlined administration of Paragon II infrastructure, including adding, deleting or modifying user profiles, event logging, and database backup/restore
- OSUI support for IBM x330 with C2T technology
- Seamless compatibility with Raritan's MasterConsole MXU2 and Z-Series 4200U
- Administrator can logoff any connected user
- Turn on, off, or reboot power to any connected device
- Network admin port
- Set power control permissions on a per outlet basis

Package Contents

Each Paragon Base Unit (P2-UMT242, P2-UMT442, P2-UMT832M, or P2-UMT1664M) ships with:

- (1) Base Unit
- (2) 20-ft. (6.1-m) CAT5 test cables
- (1) Pair of rackmount brackets and associated screws
- (1) 6-ft. (1.8-m) AC power cord
- RUMT-1U-LM304 Rackmount kit
- CAT5 admin cable
- Raritan's User's Manual CD
- Quick Setup and Installation Guide

The Paragon Stacking Units ship with:

- (1) Stacking Switch
- RUMT-1U-LM304 Rackmount kit
- 6" Stacking Cable (P2-UMT832M) or 12" Stacking Cable (P2-UMT1664M)
- AC Power Cord

The Paragon User Station ships with:

- (1) User-Station Module
- (1) 6-ft. (1.8-m) AC power cord
- (1) 6-ft. (1.8-m) AC power-extension cord for the attached monitor
- (1) 10-ft. (3-m) DB9 male-to-female serial administration cable

Chapter 2: Installation

Important! The Paragon and all devices you want to attach to it must be unplugged and powered OFF prior to installation.

Basic Installation

1. Connect power cord to the Main Switching Unit.
Optional Stacking Support:
 - Connect power cord to a Stacking Unit.
 - Connect one end of a stacking cable to the "Expansion Port Out" on the back of the Stacking Unit. Connect the other end of the cable to the "Expansion Port" on the Main Switching Unit
 - Power ON all switching units
 - On the front panel LCD of the Main Switching Unit:
 - Press the [FUNC] button and use the [↑] and [↓] keys to select "Stacking Support." Press the [ENT] button.
 - Select the total number of Stacking Units desired (0-3). Press the [ENT] button.
 - On the front panel LCD of the Stacking Unit:
 - Press the [FUNC] button and use the [↑] and [↓] keys to select "Set Stack ID." Press the [ENT] button.
 - Assign the Stacking Unit ID using the [↑] and [↓] keys. Each Stacking Unit MUST HAVE A UNIQUE ID (1-3)
 - Press the [ENT] button (sequential order is not necessary).
2. Power ON the Main Switching Unit.
3. Connect one end of a Category 5e UTP cable to User Port #1 on the back of the Main Switching Unit. Connect the other end of the cable to the "Cat5 Port" on the back of the User Station (P2-UST)
4. Connect a power cord to the User Station. Power ON the User Station.
5. Connect a PS/2 keyboard, mouse, and VGA monitor to the User Station. Power ON the monitor.
6. Connect one end of a Category 5e UTP cable to Channel Port #1 on the back of the Main Switching Unit (or Stacking Unit, if attached). Connect the other end of the cable to the RJ45 port on a Computer Interface Module (P2-CIM).
7. Connect the P2-CIM to server's keyboard, video, and mouse ports.
8. Power ON server.

Repeat steps 3 through 8 for all other CPUs you want to attach.

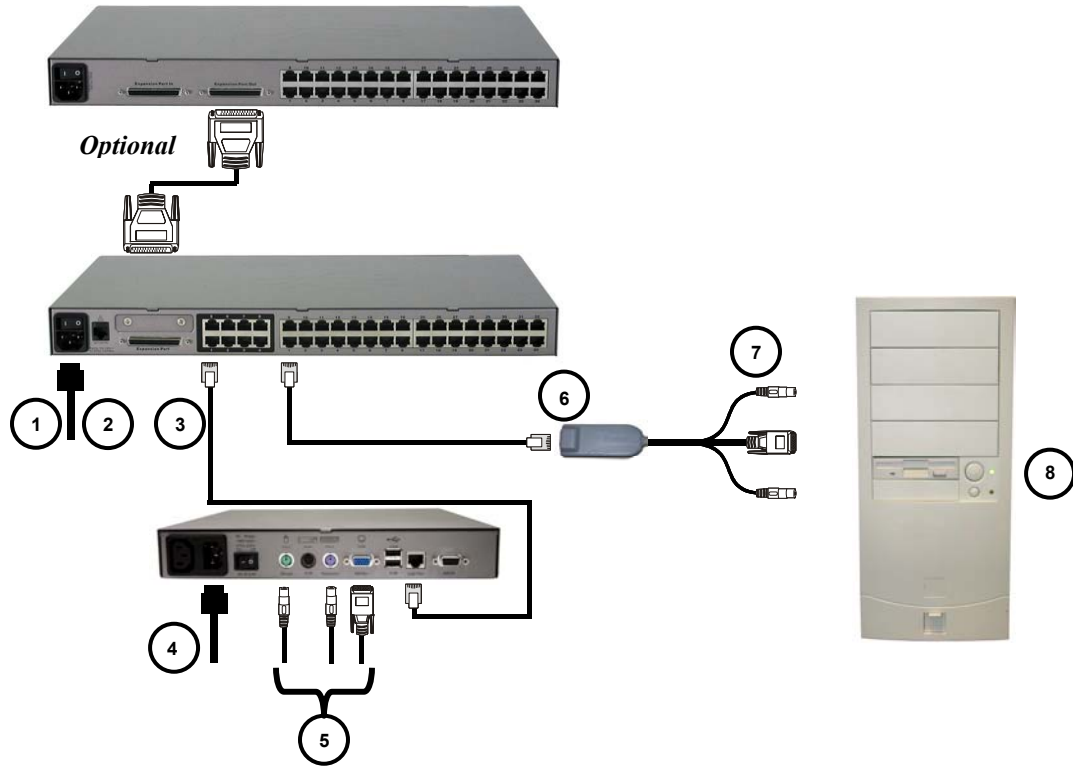

Figure 3 Installation Diagram

Initial Administrative Testing

To verify that an attached server can be viewed and controlled through the Paragon system:

1. When you first power ON the Paragon Base Unit, an attached User Station, and the User Station's attached monitor; a Login Menu will be displayed on the monitor. Type **admin** (all lowercase) in the **User Name** field and press the [Enter] key. Type **raritan** (all lowercase) in the **Password** field and press the [Enter] key.

*Note: The factory-default user names are **user01** through up to **user16** (depending on the model of the Base Unit) for regular users and **admin** for the admin user. User names are not case-sensitive. By default, a password is required only for the admin user, and that password is **raritan**. Passwords are case-sensitive.*



Figure 4 Login Menu

2. The monitor will display an On-Screen User Interface (OSUI) Selection Menu with the port of the connected CPU displayed in green. (It will have no default name – the Name field will be blank.)

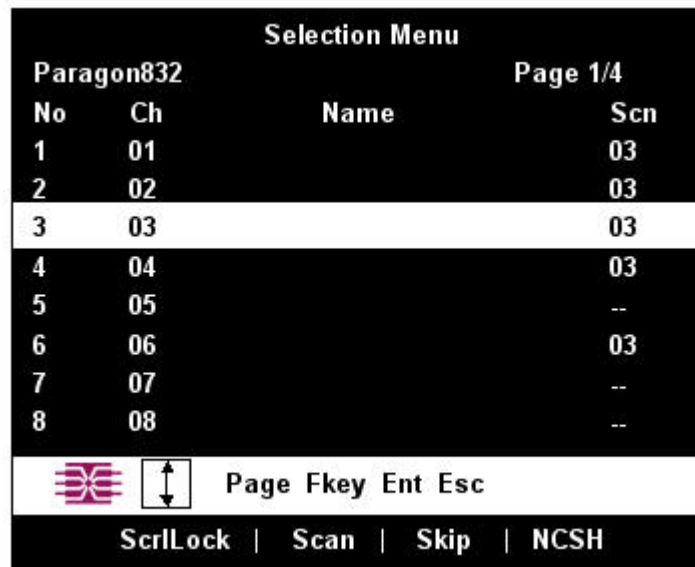

Figure 5 Selection Menu

3. Use the up- and down-arrow keys on the user station's keyboard to move the highlight to the green server port and press the [Enter] key.
4. Normal server access and operation indicates a successful connection.

A video-gain adjustment is available to focus the video image, which can be especially useful if you are using an LCD flat-panel monitor. To make this adjustment, activate the OSUI (if you have not done so already) by rapidly pressing the keyboard's [Scroll Lock] key twice. Use the [+] and [-] (plus- and minus-sign) keys on the keyboard's numeric keypad to adjust the video image until it appears to be in focus.

Paragon II Front Panel Display and Controls

The control buttons and LCD display on the Paragon II unit provide systems management and technical support functions. For most situations, there is no need to use the front panel beyond viewing status.

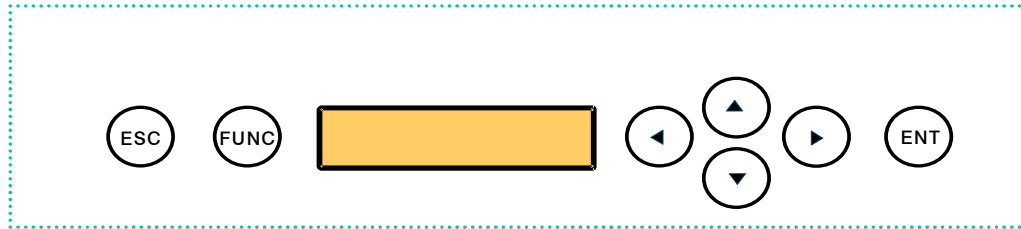

Figure 6 Paragon II Front Panel Buttons

Front Panel Components and Functions:

1. The [ESC] button is used for canceling displayed function and returning system to normal state.
2. The [FUNC] button is used to select various functions.
3. The LCD displays system status and indicates functions that can be selected by pressing front panel control buttons.
4. The [←], [↑], [→], and [↓] buttons are used for selecting or setting various options, depending on function being performed.
5. The [ENT] button is used for confirming and executing selected function.

Start-Up Display:

When a Paragon II unit is powered ON, it performs a start-up test. It checks each channel and user port to ensure proper operation.

Normal Display:

After start-up test, LCD panel displays two lines of messages:

1. **Line 1:** Running message: "Raritan Computer Paragon II: Paragon832/1 Ready"
For a Paragon II unit model P2-UMT832M, "Paragon832" is the default name of the Matrix Switching Unit (this name may be changed through the System Configuration Menu).

2. **Line 2:** User port status message: “A/N User (1, 2, 3 ...) → None”

User port status displays a scrolling status of all user ports, one user port per second. The User’s active channel, 1 through 256, is displayed after the user port number.

Raritan Computer Paragon II: Paragon832/1
 Ready
 A User (1, 2, 3 ... 8) → None

A=Active User # 1-8

- OR -

Raritan Computer Paragon II: Paragon832/1
 Ready
 N User (1, 2, 3, ... 8) → None

N=Non-Active User # 1-8

Figure 7 LCD Normal Display

Power Up Option:

If you hold down the [FUNC] button on the front panel of the Paragon II unit during Power Up, the Paragon II unit will clear its database and reset to factory defaults. Confirm functions by pressing the [ENT] button on the front panel.

Clear Database
 Hit Ent/ESC?

Figure 8 Power Up Clear Database

Function Selection Screen:

Several administrative functions can be performed on the Function Selection Screen on the Paragon II unit’s front panel.

Display Ver./SN
Test User UST1
Test Chan. UKVM
Test Stack Unit
Stacking Support
Set LCD Contrast
Re-Configure
Set IP Address
Reset Unit

Figure 9 LCD Functions

Selecting a Function:

Press the [FUNC] button on the front panel of the Paragon II unit to enter Function Selection mode and use the [↑] and [↓] buttons to scroll through the Function List. Press the [ENT] button on the front panel to select displayed function and use the instructions below for each specified function. Press the [ESC] button on the front panel at any time to return to Normal Display.

Function Menu
 Display Ver./SN

Figure 10 Function Selection

1. **Display Ver./SN** (Firmware Version and Serial Number): Displays current version of firmware and unit's serial number.

```
Firmware: 2C1
SN: CPB80347
```

Figure 11 Display Ver. and SN

2. **Test User UST1** (User Station): Used by administrator to check if user stations (UST1s) are functioning properly. Press the [↑] or [↓] button to change user port number. Display will read "OK", "None", or "Failed. Press [ESC] to return to normal display." If a "failed" condition is detected, make sure Category 5e UTP cable is installed properly and secured, or try using another UST1 to see if UST1 under test has become defective.

```
Test User UST1
UST1: 3 OK
```

Figure 12 User Station Test

3. **Test Channel UKVM** (CIM UKVM): Used by administrator to check if CIM is functioning properly. Press the [↑] or [↓] button to change channel number. Display will read "OK", "None", or "Failed." Press [ESC] to return to normal display. If a "failed" condition is detected, make sure Category 5e UTP cable is installed properly and secured, or try using another CIM (UKVM) to see if CIM under test has become defective.

```
Test Chan. UKVM
UKVM: 60 OK
```

Figure 13 Channel CIM (UKVM) Test

4. **Test Stack Unit:** Press the [↑] or [↓] button to select the corresponding Stacking Unit ID for any connected units. If there are no Stacking Units connected, the LCD will display "None". If there are Stacking Units connected, the LCD should read "Ok" for each unit. Press [ESC] to return to normal display.
5. **Stacking Support:** Press the [↑] or [↓] button to set the Stacking Unit ID number (0 – 3 for a P2-UMT832M or "0" or "1" for a P2-UMT1664M). The default is set to "0" (no Stacking Units connected). If you wish to add Stacking Units, this number must be equal to the number of Stacking Units connected. Press [ESC] to return to normal display.

```
Stacking Support
Unit(s): 0-3
```

Figure 14 Stacking Support

6. **Set LCD Contrast:** Modifies contrast level of front panel LCD Display. Press the [↑] or [↓] button to increase or decrease contrast, and press the [ESC] button to return to normal display.

```
Set LCD Contrast
Use Up/Down Keys
```

Figure 15 Set LCD Contrast

Note: LCD contrast can also be adjusted by holding the [←] button and pressing the [↑] or [↓] button at any time.

7. **Re-Configure:** Paragon II will automatically configure the system as computers or devices are added or removed. However, the system administrator can use this function to scan and re-configure the system manually. When complete, it will return to normal display.



Figure 16 Auto Configure

8. **Set IP Address:** As administrator, you may change Paragon II's IP address directly from the front panel of the device. The Paragon II's current IP address will be displayed, along with a cursor. Use the [←] and [→] keys to move the cursor over digit-by-digit, and use the [↑] or [↓] arrow keys to change the value of that digit. Press the [ENT] button when the new IP address has been set. Press the [ENT] button again to save changes and reboot the unit when asked to "Save Changes?" The unit will restart with the new network address.

Note: Stacking units do not have their own databases and configurations settings, and likewise, do not have their own network addresses. You cannot configure one using the front panel controls on UMT E units.

9. **Reset Unit (Paragon II Unit Switch):** Enables restart of Paragon II unit as if unit's power had been physically turned off and back on again. However, the Paragon II unit will not perform start-up test unless ENT button is held down during restart.
With Paragon II unit firmware 2B1 and User Station (UST1) firmware 2K10 or higher, either a power reset or a factory "function" reset can be performed from the front panel of the Paragon II unit using shortcut button combinations.

Power Reset:

Hold the [↑] and [↓] buttons on the front panel of the Paragon II unit simultaneously for approximately three seconds. When the front panel stops scrolling, release the buttons.

Factory "Function" Reset:

Hold the [↑] and [↓] buttons on the front panel of the Paragon II unit simultaneously while pressing the [FUNC] button. When the front panel stops scrolling, release the [↑] and [↓] buttons, wait an additional three seconds, then release the [FUNC] button.

Initial Configuration

Note: This section includes full instructions for how to install single Base Units, cascades of multiple base units, or stacking switches. Follow the simplified procedure previously outlined in **Basic Installation** to install a simple Paragon system with a single Base Unit. See **Appendix B: User Station Direct Mode**, to install a “direct mode” User Station-to-CIM system with no Base Units. See **Chapter 5: Paragon II and Z-CIM** to install a Z-CIM and a local PC in your system.

Using the OSUI for Initial Configuration

You will use the Paragon II On-Screen User Interface (OSUI) while you install the Paragon system, so here are some basics of the OSUI to familiarize yourself before starting your installation. Once the User Station and user-station equipment are in place and powered ON, activate the OSUI by rapidly pressing the default hotkey ([**Scroll Lock**]) twice on an attached keyboard. Each OSUI menu contains the following sections: a menu-title line, a menu/screen body (for text and fields), a prompt/message bar, and a status line that consists of:

- The current OSUI hotkey
- Scan/Skip status
- NCS ([**Num Lock**], [**Caps Lock**], and [**Scroll Lock**]) status indicator
- A communication-speed indicator (“**L**” for low or “**H**” for high, which will depend on your Paragon components) showing the communication speed between the User Station and Base Station.

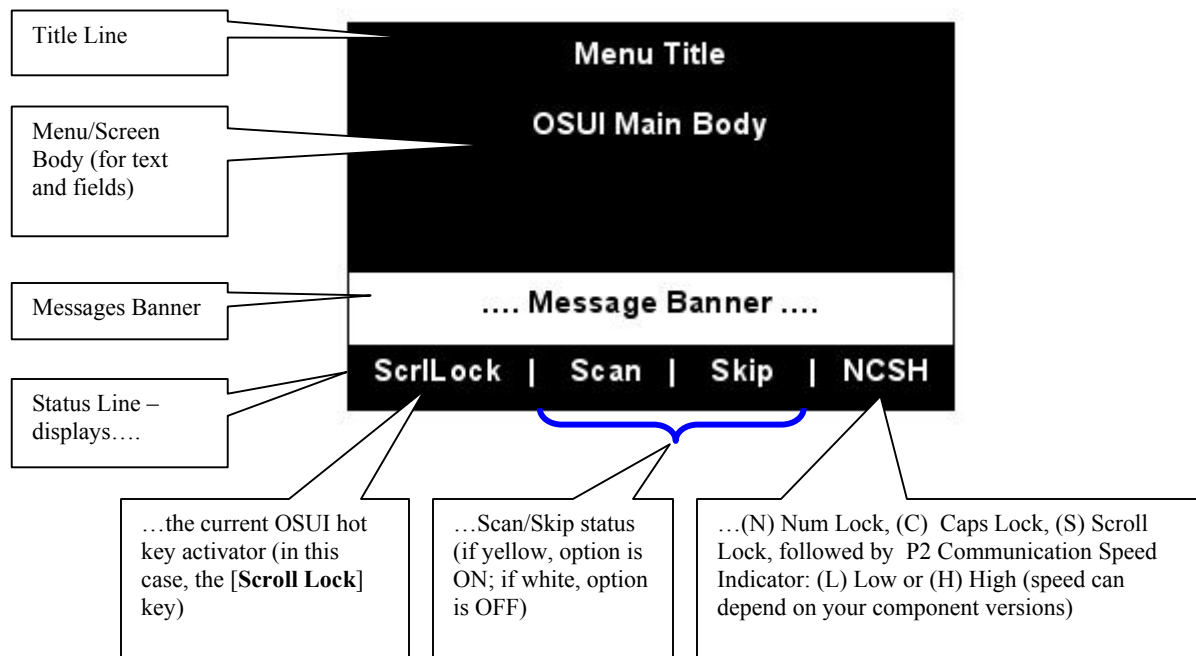

Figure 17 Format of OSUI screens

Use function keys [**F1**], [**F2**], [**F3**], [**F4**], [**F8**], and [**F12**] to toggle between first-level menus. Press [**F1**] while the OSUI is displayed to activate the Help Menu, a list of available help options. While the OSUI is on screen, the user-station keyboard’s [**Scroll Lock**] LED indicator blinks.

Installing a Paragon System with a Single Base Unit

If installing a single Paragon Base Unit, keep in mind the maximum numbers of user stations and server CPUs you can connect:

- 2 user stations and 42 CPUs to a P2-UMT242
- 4 user stations and 42 CPUs to a P2-UMT442
- 8 user stations and 32 CPUs to a P2-UMT832M
- 16 user stations and 64 CPUs to a P2-UMT1664M

Important! All Paragon components, CPUs, and monitors must be turned OFF and unplugged before installation.

1. Initialize the Base Unit.
 - a. Run the Base Unit's included power cord from the IEC 320 inlet on its rear panel to a working AC outlet.
 - b. Power ON the Base Unit.
2. Connect a User Station and its attached devices.
 - a. Connect one end of a CAT5 UTP cable to user port # 1 on the back of the Base Unit. Connect the other end of the cable to the RJ-45 CAT5 port on the back of the User Station.
 - b. Run the User Station's included power cord from the IEC 320 inlet on its rear panel to a working AC outlet.
 - c. Power ON the User Station. It will power up and establish communication with the Base Unit.
 - d. Connect a PS/2 keyboard, PS/2 mouse, and VGA monitor to the User Station. (If there will be any Sun CPUs in your system, you can connect a Sun keyboard and mouse later, after you have configured the system for Sun input. To control Sun CPUs with a PS/2 keyboard, please see **Appendix F: Emulating Sun Keys with a PS/2 Keyboard** for additional information.)
 - e. Plug in and power ON the monitor.



Figure 18 Rear panel of a Paragon User Station and P2-UMT832M unit

3. Initially configure the User Station.
 - a. The Login Menu should be displayed on the User Station's attached monitor. If the [Scroll Lock] LED on the User Station's attached keyboard is blinking, the Paragon is ready to accept hotkey commands, which can be used with the OSUI to login, select servers, or administer the system.

Figure 19 Login Menu for a P2-UMT832M

If the monitor instead displays a “.....No connection to Paragon.....” message, the User Station is not properly connected to the Base Unit. Check for loose connections and make sure you are using good, intact CAT5 cables.

- b. Type **admin** in the **User Name** field and press the [Enter] key. In the **Password** field, type the default password **raritan** (all lowercase) and press the [Enter] key.
- c. The OSUI's Selection Menu will appear, indicating that the User Station is correctly installed.

No	Ch. ID	Name	Scn
1	01	Rich	03
2	02	NT 4.0 Mail	03
3	03		03
4	04	Wins98.Jack	03
5	05	MX4-Wing.2	--
6	06	NT4.0-Fax	03
7	07	MC2-16.Reg1	--
8	08		

Figure 20 Selection Menu for a P2-UMT832M

4. Repeat steps 2 and 3 for each User Station you want to connect to the Base Unit.

5. Connect a P2CIM-PS2 and its server CPU.
 - a. Connect the cable strands of an appropriate P2CIM-PS2 to the desired ports on a server CPU:
 - i. P2CIM-PS2 (IBM PS/2 compatible CPUs): Plug the HD15 strand into the CPU's HD15 VGA video port. Plug the purple 6-pin mini-DIN keyboard strand into the CPU's 6-pin mini-DIN keyboard port. Plug the light green 6-pin mini-DIN strand into the CPU's 6-pin mini-DIN mouse port.
 - ii. P2CIM-SUN (Sun compatible CPUs): Plug the HD15 strand into the CPU's HD15 VGA video port. Plug the 8-pin mini-DIN strand into the CPU's 8-pin mini-DIN keyboard/mouse port.
 - iii. P2CIM-USB (USB CPUs of any platform or P2 CIM-SUSB): Plug the HD15 strand into the CPU's HD15 VGA video port. Plug the USB Type A strand into one of the CPU's USB Type A ports.
 - iv. AUATC (serial CPUs, routers, etc.): Please see **Appendix E: Using AUATC for RS-232 Access** for installation instructions.
 - v. Z-CIM (local [single-user] IBM PS/2 compatible CPUs): Please see **Chapter 5: Paragon II and Z-CIM** for installation instructions.
 - b. Plug in and power ON the CPU. If the P2CIM-PS2 is installed and operating properly, the P2CIM-PS2's green LED will start blinking: once per second while the P2CIM-PS2 is idle, more quickly while data is passed in either direction.
 - c. Connect one end of a CAT5 UTP cable to RJ-45 port #1 on the back of the Base Unit. Connect the other end of cable to the RJ-45 port on the P2CIM-PS2.
6. Configure the P2CIM-PS2 and the attached CPU.
 - a. The monitor attached to the User Station will display the Selection Menu; with the CPU you just connected displayed in green. Use the up- and down-arrow keys to move the highlight to that entry and press the **[Enter]** key. If you can access and operate the CPU normally, the P2CIM-PS2 is connected successfully. Raritan recommends you give the server a meaningful system name at this time, as described in the next steps.

*Note: If your video image is fuzzy (especially if you are using an LCD flat-panel monitor), you can adjust the video gain to focus the video image. If the OSUI is not already displayed, activate it by pressing the **[Scroll Lock]** key twice rapidly, then use the numeric keypad's **[+]** and **[-]** (plus and minus) keys to adjust the video image until it appears to be in focus.*

- b. Press **[F5]** to activate the Administration Menu. Use the up- and down-arrow keys to move the highlight to the Port Configuration entry and press the **[Enter]** key to select it.

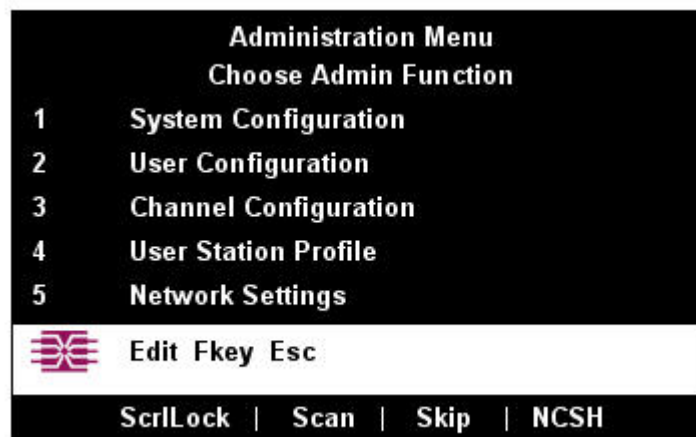



Figure 21 Administration Menu

- c. The Channel Configuration menu will appear. Use the up- and down-arrow keys to move the yellow highlight to the **Name** field for the channel port number where you installed the CPU and press the [**Enter**] key. The highlight should turn light blue.

Channel Configuration			
Paragon832		Scn	Page 1/4→ Device
Ch. ID	Name		
1	MC_Rich	03	CPU
2	NT 4.0 Mail	03	CPU
3	Wins95.Bob	03	CPU
4	Wins98.Jack	03	CPU
5	MX4-Wing.2	--	
6	NT4.0-Fax	03	CPU
7	MC2-16.Reg1	--	
8	UMT8 Switch-Wing4	--	

 Edit G Fkey S Esc

ScrLock | Scan | Skip | NCSH

Figure 22 Channel Configuration Menu of a P2-UMT832M

- d. Edit the name (it should turn green when you start typing). Press the [**Enter**] key when you finish, and then press [**S**] to save the new name.
- e. Press the [**Enter**] key to return to the Selection Menu. Verify that the new name appears in the Selection Menu in green.
7. Repeat steps 5 and 6 for each P2CIM-PS2 and CPU you want to connect to the Base Unit's channel ports.

Installing a Cascaded Paragon System

Paragon II's channel port capacity can be expanded by installing a cascade of Base Units. In a "two-tiered" cascaded system, one or more subsidiary Base Units are connected to the channel ports of a master Base Unit. If you fully populate a second tier, you can add a third tier by connecting additional subsidiary Base Units to the channel ports of Base Units in the second tier. Three tiers is the maximum depth of a cascaded system; only CIMs may be attached to the channel ports of Base Units in the third tier. A three-tier system can accommodate up to 2048 CPUs.

Note: In cascaded configurations, the subsidiary Base Units in the third tier (if there is one) must be powered ON first, then the subsidiary Base Units in the second tier, then the master Base Unit. User Stations can be powered ON and OFF at any time as needed.

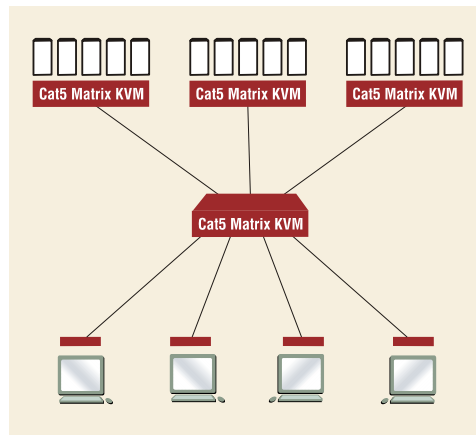



Figure 23 Sample cascaded system

1. Connect one end of a CAT5 UTP cable to user port #1 on the back of the master Base Unit. Connect the other end of the cable to the RJ-45 CAT5 port on the back of the User Station. Connect a PS/2 keyboard, PS/2 mouse, and VGA monitor to the User Station. Do not plug in or turn on the User Stations or monitors yet. (Do not attach anything to the Base Unit's channel ports and do not plug it in or turn it on yet.)
2. For each subsidiary Base Unit you want to attach directly to the master, run CAT5 UTP cables from consecutive channel ports on the master Base Unit to the subsidiary Base Unit's user ports.
3. If you are installing a third tier: Run CAT5 UTP cables from consecutive channel ports on a second-tier Base Unit to the user ports on a third-tier Base Unit. Repeat for all other subsidiary Base Units in the third tier.
4. Follow step 5 of **Installing a Paragon System with a Single Base Unit** to attach CIMs and CPUs to the channel ports of any third-tier Base Units, any free channel ports on your second-tier Base Units, and any free channel ports on your master Base Unit.
5. Following step 1 of **Installing a Paragon System with a Single Base Unit**, plug in and power ON any third-tier Base Units, then plug in and power ON second-tier Base Units, then plug in and power ON your master Base Unit. Following steps 2b, 2c, and 2e of **Installing a Paragon System with a Single Base Unit**, plug in and power ON your User Stations and monitors. The master Base Unit should automatically recognize the connected subsidiary Base Units and update its configuration. All monitors should display the Login Menu. If any monitors instead display a ".....No connection to Paragon....." message, the User Station they are attached to is not properly connected to the master Base Unit. Check for loose connections and make sure you are using good, intact CAT5 cables. (See **Appendix A: Specifications** for UTP-cabling information.)

Note: If your video image is fuzzy (especially if you are using an LCD flat-panel monitor), you can adjust the video gain to focus the video image. If the OSUI is not already on screen at a given monitor, activate it by pressing the [Scroll Lock] key twice rapidly, then use the numeric keypad's [+] and [-] (plus and minus) keys to adjust the video image until it appears to be in focus.

6. Configure the channel ports in your system. (Check the [Scroll Lock] LED on one of your user-station keyboards. If it is blinking, the Paragon is ready to accept hotkey commands from that user station. Hotkey commands can be used with the OSUI to login, select servers, or administer the system.)
 - a. At the Login Menu, type **admin** in the **User Name** field and press the [Enter] key. In the **Password** field, type the default password **raritan** (all lowercase) and press the [Enter] key.
 - b. The monitor will display the Selection Menu, indicating that the User Station is correctly installed.

Selection Menu			
→Paragon 832		Page 1/4 →	
No	Ch. ID	Name	Scn
1	01	Rich	03
2	02	NT 4.0 Mail	03
3	03		03
4	04	Wins98.Jack	03
5	05	MX4-Wing.2	--
6	06	NT4.0-Fax	03
7	07	MC2-16.Reg1	--
8	08		



 Page Fkey Ent Esc

ScrlLock | Scan | Skip | NCSH

Figure 24 Selection Menu

- c. Press [F5] to activate the Administration Menu. Use the up- and down-arrow keys to move the highlight to the Channel Configuration entry and press the [Enter] key to select it.

Administration Menu	
Choose Admin Function	
1	System Configuration
2	User Configuration
3	Channel Configuration
4	User Station Profile
5	Network Settings



 Edit Fkey Esc

ScrlLock | Scan | Skip | NCSH

Figure 25 Administration Menu

- d. The Channel Configuration menu will appear. Use the up- and down-arrow keys and [**PageUp**] and [**PageDown**] keys to approach channel ports to which subsidiary Base Units are connected. These will be shown in white with their default device names in the Name column and their types in the Device column: “P242” for a 2 x 42 Base Unit (P2-UMT242), “P442” for a 4 x 42 Base Unit (P2-UMT442), “P832” for an 8 x 32 Base Unit (P2-UMT832M), or “P1664” for a 16 x 64 Base Unit (P2-UMT1664M).

Channel Configuration			
Paragon832		Scn	Page 1/4→ Device
Ch. ID	Name		
1	MC_Rich	03	CPU
2	NT 4.0 Mail	03	CPU
3	Wins95.Bob	03	CPU
4	Wins98.Jack	03	CPU
5	MX4-Wing.2	--	
6	NT4.0-Fax	03	CPU
7	MC2-16.Reg1	--	
8	UMT8 Switch-Wing4	--	

 Edit G Fkey S Esc

ScrlLock | Scan | Skip | NCSH

Figure 26 Channel Configuration Menu for a P2-UMT832M

- e. Continue using the up- and down-arrow keys and [**PageUp**] and [**PageDown**] keys to move the yellow highlight to the **Name** field for the channel port number where a subsidiary Base Unit is installed and press the [**Enter**] key. The highlight should turn light blue.
- f. Type in the name you want to assign to the subsidiary Base Unit on this channel port (the highlight should turn green when you start typing). Press the [**Enter**] key when finished, and then press [**S**] to save the new name. All other paths (channel ports) by which that subsidiary Base Unit is attached to the Base Unit above it will be given the same name automatically.
- g. Press [**F2**] to reopen the Selection Menu; make sure that the channel port(s) of the second-tier Base Unit are properly established. All paths to that Base Unit should be displayed in purple.
- h. Press [**F5**] to return to the Administration Menu. Select Channel Configuration again. Select a channel port that has been configured for the subsidiary Base Unit you just set up. Press [**G**] to activate a dedicated Channel Configuration menu for the subsidiary Base Unit.
- i. Edit the names of all server CPUs attached to this subsidiary Base Unit. Each highlight should turn green as you start typing. Press the [**Enter**] key when finished with each name. Press [**S**] to save all of the new names.
- j. Press the [**Enter**] key to access the dedicated Selection Menu for that subsidiary Base Unit. Verify that new names appear in the Selection Menu in green.
- k. If you are configuring a second-tier subsidiary Base Unit, and there are any third-tier Base Units attached to it, repeat steps c through j for a third-tier path. Press [**S**] to save the configuration. Press [**F2**] to activate the third-tier Selection menu and verify that the third-tier Base Unit is properly configured: Select a channel port for the second-tier path and press the [**Enter**] key, then a channel port for the third-tier path and press the [**Enter**] key, then a channel port for a CPU attached to the third-tier Base Unit and press the [**Enter**] key. If you can properly access and operate the chosen CPU, the third-tier Base Unit is properly installed.

Note: Repeat step k for all remaining third-tier Base Units (if any) attached to this second-tier Base Unit.

- l. Press [**S**] to save the configuration. Press [**F2**] to activate the Selection menu and verify that the second-tier Base Unit is properly configured: Select a channel port for the second-tier path and

- press the [Enter] key, then a channel port for a CPU attached to the second-tier Base Unit and press the [Enter] key. If you can properly access and operate the chosen CPU, the second-tier Base Unit is properly installed.
- m. Repeat steps **c** through **I** for all remaining (if any) second-tier Base Units attached to the master Base Unit.
 - n. Edit the names of any server CPUs directly attached to the master Base Unit and verify the master Base Unit's configuration as described in steps **6b** through **6e** of the section **Installing a Paragon II with a Single Base Unit**, earlier in this chapter.

Important! If you rearrange a cascaded system or dismantle one and rebuild it differently later, you must perform a soft reset on each Base Unit in the new cascade. A soft reset allows each Base Unit to retain all user and system profiles, and to auto-detect the current status of its channel port and user ports. Follow the installation steps in this section to install the new cascade, but when you power on each Base Unit (which must be done in proper tier order), press the [FUNC] and the [↓] buttons on the unit's front panel until "Reset Unit" appears on the LED panel. Press the [ENT] button to reset the unit. Starting with a subsidiary Base Unit in the third tier (if there is one), power on the unit, press [FUNC] and [↓] until the LED panel flashes, then press the [ENT] button, and wait until the LEDs cycle through and return to their original state. Repeat for any other third-tier units, then all second-tier units, and finally the master unit.

Installing a Paragon Stacking Switch

- Connect power cord to a Stacking Unit.
- Connect one end of a stacking cable to the "Expansion Port Out" on the back of the Stacking Unit. Connect the other end of the cable to the "Expansion Port" on the Main Switching Unit
- Power ON all switching units
- On the front panel LCD of the Main Switching Unit:
 - Press the [FUNC] button and use the [↑] and [↓] keys to select "Stacking Support." Press the [ENT] button.
 - Select the total number of Stacking Units desired (0-3). Press the [ENT] button.
- On the front panel LCD of the Stacking Unit:
 - Press the [FUNC] button and use the [↑] and [↓] keys to select "Set Stack ID." Press the [ENT] button.
 - Assign the Stacking Unit ID using the [↑] and [↓] keys. Each Stacking Unit MUST HAVE A UNIQUE ID (1-3)
- Press the [ENT] button (sequential order is not necessary).

Chapter 3: Operation – User Functions

User functions for configuration and operation of your Paragon II system are processed through the On-Screen User Interface (OSUI). To activate the OSUI at any time, press the system's hotkey (the factory default is [Scroll Lock]) twice in quick succession.

Login

Log on to access servers and other devices connected to the Paragon II system. The Login Menu is automatically displayed on every user station monitor after the single or master Paragon II Base Unit is powered on. To activate the Login Menu on a user-station monitor at any other time, press the system's hotkey (the factory default is [Scroll Lock]) twice in quick succession to activate the OSUI, then press function key [F9].

Note: If a user station monitor displays the message "...No Connection to Paragon..." instead of the Login Menu, either the User Station is not connected properly to the Base Unit, the Base Unit is powered OFF, or the Base Unit is malfunctioning. Make sure that the cabling between the User Station and the Base Unit is intact and is securely connected at both ends. Make sure that when you turn the Base Unit off and back on, the LEDs run through the sequence described in step 1b of Chapter 2: Installation, Installing a Paragon System with a Single Base Unit.

The Device ID field in the login menu will initially contain the single or master Base Unit's default device name: "Paragon II" followed by "2x42" for a P2-UMT242, "4x42" for a P2-UMT442, "8x32" for a P2-UMT832M, or "16x64" for a P2-UMT1664M. (The Administrator can assign it a different name.) The User Port is the number of the user port on the Base Unit – from 1 to 16 depending on the model – to which this user and User Station are attached.

Figure 27 Login Menu for a P2-UMT832M

To log on at the Login Menu and start operating the system:

1. Type in the user name assigned to you by the System Administrator. (If user names have not been assigned, use default names: **user01** through **user16**, depending on the model, for regular users and **admin** for the administrator. User names are not case-sensitive.) When finished, press the [Enter] key.
2. Paragon II will prompt you if a password is necessary. If so, type your password and press the [Enter] key. The default password for the admin user is **raritan** (all lowercase; passwords are case-sensitive). (We recommend changing this password right away; please see the section **User Customization** in this chapter for additional information.)

3. The Selection Menu will appear. To view other menus, use the function keys as described in the **Help Menu** section later in this chapter.



Selection Menu			
→Paragon 832		Page 1/4 →	
No	Ch. ID	Name	Scn
1	01	Rich	03
2	02	NT 4.0 Mail	03
3	03		03
4	04	Wins98.Jack	03
5	05	MX4-Wing.2	--
6	06	NT4.0-Fax	03
7	07	MC2-16.Reg1	--
8	08		
  Page Fkey Ent Esc			
ScrlLock Scan Skip NCSH			

Figure 28 Selection Menu for a P2-UMT832M

Note: To Log out of the Paragon II system, press the function key [F9] while the OSUI is on-screen.



Selecting a Server

Immediately following user login, the Selection Menu appears. Users who are already logged in can activate the Selection Menu by pressing the hotkey (the factory default is [Scroll Lock]) twice in quick succession, then pressing function key [F2].

The Selection Menu lists devices sorted either by channel port-ID number (“Ch. ID”) or alphabetically by the name of the server or other device on that channel port (“Name”). You can toggle between these two views by pressing [F12]. Default sorting is by channel port-ID number, but unless the system is re-initialized, the last selected sort order will be shown the next time that the Selection Menu is activated.

Other columns in the channel port-ID view include “No” – the channel port’s “key number” (internally assigned by the Paragon II and not changeable by user) and “Scn” – the individual scan-delay time in seconds (unless the channel port has a subsidiary Base Unit attached to it, in which case the Scn column will show “- -”.)

Selection Menu			
→Paragon 832		Page 1/4 →	
No	Ch. ID	Name	Scn
1	01	Rich	03
2	02	NT 4.0 Mail	03
3	03		03
4	04	Wins98.Jack	03
5	05	MX4-Wing.2	--
6	06	NT4.0-Fax	03
7	07	MC2-16.Reg1	--
8	08		



 Page Fkey Ent Esc

ScrlLock | Scan | Skip | NCSH

Figure 29 Selection Menu in order by Channel Port Number

Selection Menu by Name	
→Paragon 832	Page 1/4 →
Name	Ch. ID
MC2 -16.Reg1	Paragon832.001
MX4-Wing.2	Paragon832.002
NT 4.0 Mail	Paragon832.003
000.000.000.004	
UMT8 Switch-Wing4	Paragon832.008
Wins95.Bob	Paragon832.007
Wins98.Jack	Paragon832.005
▶ NT4.0-Fax	Paragon832.006
 	Page Fkey Ent Esc
ScrLck Scan Skip NCSH	

Figure 30 Selection Menu in order by Name

The Selection Menu displays up to eight channel ports per page; total number of pages appears in the upper right-hand corner, for example “Page 2/5” indicates that you are on the second of five pages. Use the [PageUp] and [PageDown] keys on your keyboard to move between the pages. Once you have selected a CPU as described on the following pages, Paragon II will switch to that channel port. If “ID Display” is enabled, a display will appear to identify the chosen channel port for the number of seconds set at the top of your screen.

To choose a server from the Selection Menu:

1. Press [F12] to toggle the menu to sort-order view of your choice (by channel port-ID number or alphabetically by device name). The entry for the channel port you currently have selected (if any) will be highlighted and will have a small red arrow to the left of its channel port name.

*Note: In the channel port-ID view, the Selection Menu can display either all channel ports or only those channel ports that the current user is allowed to select (the default view). If the system administrator has set the “Display All Computers” option in the System Configuration menu (see **Chapter 4: Operation – Administrator Functions, System Configuration**) to “Yes,” you can press [F10] to toggle between the restricted and unrestricted views. In the unrestricted “all channel ports” view, the Paragon displays a red “S” next to the scan rate of any channel port that the user is not permitted to access.*

2. Use the up- and down-arrow keys (and, for longer lists, the [PageUp] and [PageDown] keys) to move the highlight bar to the channel port you want to select, and then press the [Enter] key. Note that although the highlight will move, the small red arrow to the left of the channel port name will remain stationary, indicating the user’s currently-selected channel port, until a new selection is made.
 - a. In channel port-ID view, once all channel ports page are assigned, you can press the desired channel port’s key number ([1] through [8]) to move the highlight to that channel port instantly.
 - b. In name view, you can type the first few characters of the desired channel port’s name to move the highlight to the first channel port whose name begins with that character sequence.
3. Press the [Enter] key to select a channel port. If there is a server CPU attached to the channel port that you are permitted to access, Paragon II automatically switches you to that channel port for normal server operation, and the OSUI disappears. If there is a cascaded Base Unit attached to that channel port, an additional dedicated OSUI Selection Menu will appear for that device; keep moving through the Selection Menu layers until you reach the CPU you want.

Note: To return to the main Selection Menu from any second- or third-tier device-specific Selection Menu, press the [Home] key on your keyboard once, or press the [Esc] key once or twice depending which tier you are currently on.

Once you switch to a different channel port, you can continue switching by pressing the hotkey (factory default is [**Scroll Lock**]) twice rapidly to activate the Selection Menu. If you want to return to your previously selected channel port without seeing any OSUI menus, press the “previous channel port” command key (factory default is [**Num Lock**]) twice rapidly.

In the Selection Menu, each channel port’s availability is visually indicated by the following text colors. (For additional information about Private Mode, Public View Mode, and PC Share Mode, please see the section **Operation Mode** in **Chapter 4: Administrator Functions, System Configuration**.)

Black	No device is connected or the connected device is powered OFF.
Green	Server CPU is connected and the channel port is active and available. However, if the Paragon system is in PC Share Mode, another user may currently be accessing the server.
Red	Channel port is unavailable, currently being accessed by another user. (This happens only when the Paragon II system is in Private Mode.)
Yellow	Channel port is unavailable for control (being controlled by another user), but video can be viewed. (This happens only when the Paragon system is in Public View Mode. Please refer to the paragraphs below for information about other OSUI displays that appear when the system is in Public View Mode.)
Purple	A second- or third-tier cascaded Base Unit is connected to this channel port (please see Chapter 2: Installation, Installing a Cascaded Paragon II System).
White	Channel port’s current status is unknown. This should not happen if the Paragon II is operating normally.

When the system is set to Public View Mode, if one user has already selected a server, another user can also select it, but the second user can only view video output, not control it or input any data with the keyboard and mouse. In this mode, other OSUI graphic elements will appear on screen when you select various CPUs:

- When you select a server that someone else is already controlling, a message showing the name of the server being viewed will appear on your monitor. It cannot be removed, but will disappear after three seconds. Press [**Esc**] to return to the main Selection Menu.
- If another user chooses to view the video of a server you have already selected, you will see a message bearing that user’s name for three seconds, twice – first when the second user begins viewing and then when the second user stops viewing.

User Customization

When the OSUI is active, invoke the User Profile Menu by pressing function key [F4]. This menu displays Paragon II's configuration and allows you to set preferred operating parameters for individual user accounts.



Figure 31 User Profile Menu

To view or change your user profile:

1. If the OSUI is not already active, activate it by pressing the hotkey (factory default is [Scroll Lock]) twice in quick succession.
2. Press [F4] to access the User Profile screen. The topmost fields are identifiers that cannot be changed by the user:
 - a. The Connected field displays the name and channel port ID of the currently selected device or server, if you are currently connected to a channel port.
 - b. The User field displays the user name you entered at login.
 - c. The User Port field shows which user port on the Base Unit your User Station and user station are attached to.
 - d. The Admin field shows whether or not you have Administrator privileges.
 - e. The Group field displays the user's group ID(s) (see **Chapter 4, Operation – Administrator Functions, Group Settings**).
3. To change any of the other fields, use your keyboard keys to select the field you want to edit: Press [Tab] to move forward through the editable fields, [Shift]+[Tab] to move backward, the up- and down-arrow keys to move up and down, and the left- and right-arrow keys to move left and right. Press the [Enter] key to begin editing; the highlighted area will turn green, and the prompt in the prompt/message bar will change to "-Change Ent-Done ESC-Cancel." Follow the instructions below for interpreting and editing each specific User Profile parameter.

When finished, press either the [Enter] key to retain the changes (the highlighted area will turn yellow) or press the [Esc] key to cancel the changes. The prompt in the prompt/message bar will change to "Save the changes (Y/N/ESC)" (It will do this before you leave the screen if you pressed a function key.) Press [S] to save the changes to long-term memory, [N] to discard your changes, or [Esc] to discard your changes and exit the menu.

Note: When you type in new numeric values, always use the number keys at the top of your keyboard rather than the number keys on your keypad. Paragon does not support the keypad number keys.

User Profile Parameters and How to Change Settings

- **Scan Mode:** Indicates how Paragon II determines the length of time to pause at each channel port during autoscanning. Default setting is “**Global**” – the system pauses at each channel port for the same length of time (length of your choosing). “**Individual**” setting indicates that the Administrator has set a specific length of time for individual channel ports (as displayed in the Selection Menu). Use any of the arrow keys to toggle between these values.
- **Global Scan Rate:** If Scan Mode is set to “**Global**,” this parameter determines the length of time that the system pauses at each channel port while scanning. Using leading zeroes if necessary, type in a two-digit number of seconds from 01 to 24, or use the up- and down-arrow keys to increment and decrement the current value by 1 respectively. The default setting is **03**.
- **ID Display:** The ID Display is a small window that can appear on-screen to display the name and ID of each channel port as you switch between them or scan them. Edit the two fields to determine how the system will show you this window:
 - Possible values in the first field are “**On**” (ID Display is shown, the default value) and “**Off**” (ID Display isn’t shown). Use any of the arrow keys to toggle between these values.
 - If the ID Display is set to “**On**,” the number in the second field indicates how many seconds it will remain on-screen. Using leading zeroes if necessary, type in a two-digit number of seconds from 01 to 24, or use the up- and down-arrow keys to increment and decrement the current value by 1 respectively. If you type in a number greater than 24, the second field will be filled with a “- -”, indicating that the ID Display will be shown at all times. The default setting is **03**. If the ID Display is set to “**Off**,” the number in this field will have no effect.
- **Green Mode:** A “power-saving mode” that blanks the monitor screen if the user station is idle (no keyboard or mouse activity) for a specified amount of time. You can edit the two fields to determine how the system handles this feature:
 - Possible values in the first field are “**On**” (Green Mode is enabled and the screen is blanked after a period of inactivity) and “**Off**” (Green Mode is disabled and the screen displays normal video indefinitely). Use any of the arrow keys to toggle between these values.
 - If Green Mode is set to “**On**,” the number in the second field is how many minutes of inactivity must elapse before Green Mode is triggered. Using leading zeroes if necessary, type in a two-digit number of minutes from 01 to 99, or use the up- and down-arrow keys to increment and decrement the current value by 1 respectively. The default setting is **05**. If Green Mode is set to “**Off**,” the number in this field will have no effect.
- **Hotkey:** The keyboard key that, when pressed twice quickly, activates the OSUI. The four alternatives are [**Scroll Lock**] (the default), [**Caps Lock**], the left [**Alt**] key, and the left [**Shift**] key. Use any of the arrow keys to switch between the choices. You cannot select the key currently being used as the Previous Channel Key (see below).
- **Display Position:** This position indicates where the OSUI menus and ID Display appear on your monitor. Move the highlight to “Menu” (for the OSUI) or “ID” (for the ID Display) and press the [**Enter**] key to highlight it, then use the left-, right-, up-, and down-arrow keys to move the chosen window as desired. When finished, press the [**Enter**] key to save the change.
- **Previous Channel Key:** The keyboard key that, when pressed twice quickly, causes Paragon II to return to the previously selected channel port (provided that that channel port is still available) *without* going through the OSUI. The four alternatives are the left [**Alt**] key, the left [**Shift**] key, [**Caps Lock**], [**Num Lock**] (the default), and “**None**” (no Previous Channel Key; function disabled). Use any of the arrow keys to switch between the choices. You cannot select the key currently being used as the Hotkey (see above).
- **Help:** This parameter determines the format of the help message at the bottom of each OSUI menu. It is always set to “**Single Line**” and cannot be selected or altered.
- **Local PC:** Use any of the arrow keys to toggle Local PC Mode **On** or **Off** (the default) for the attached User Station. Turn PC Mode “**On**” only if you have used a Z-CIM to attach a local PC between the User Station and the Base Unit.

You can change, delete, or reinstate your password (if “Allow Blank Password” is set to “Yes”) while the User Profile Menu is on-screen by pressing [P]. Type your old password at the first prompt. Type a new password up to eight characters long at the next prompt, and press the [Enter] key. To delete your password, press the [Enter] key without typing anything in the field. Confirm the new password by typing it again at the third prompt; then either press the [Enter] key to save the new password or [Esc] to abort the change and continue using the old password.

Note: Be careful when you change your password! If you forget or lose it, the Administrator has no way of recovering or erasing it – your account will have to be deleted and recreated.

Help Menu

When the OSUI is open, activate the Help Menu by pressing function key [F1]. This menu displays a list of the function keys and their help functions.

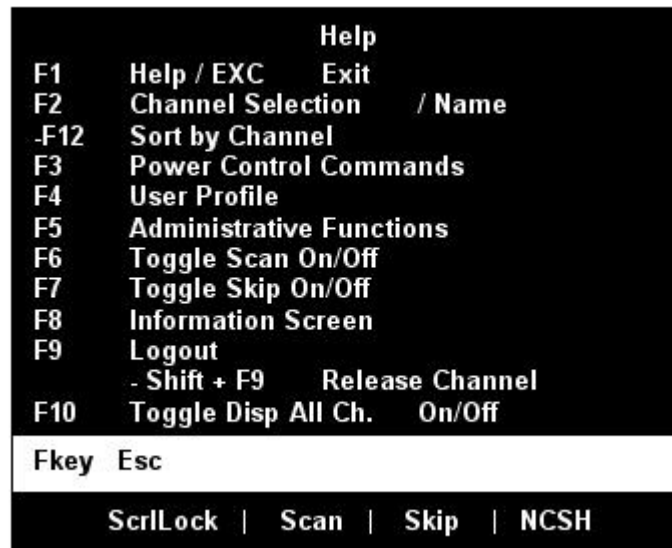

Figure 32 Help Menu

Keyboard-Controlled OSUI Functions

Use the following function keys to access the Paragon’s OSUI functions:

PRESS...	WHEN YOU WANT TO...
[F1]	View the Help Menu
[F2]	Access the Selection Menu in order to view or select channel ports or view group IDs or scan rates
[F3]	Access Power Control Menu for associated Channel
[F4]	Access the User Profile Menu in order to view and change user-specific operating parameters
[F5]	Administrator only: View the Administration Menu
[F6]	Administrator only: Toggle autoscan on or off
[F7]	Administrator only: Toggle autoskip on or off
[F8]	View the Information Menu to see the version numbers of the Paragon II’s firmware and hardware, the number of accessible Base Units, the total number of accessible servers, etc.
[F9]	Log out of the Paragon system (logs user out and invokes the login screen)
[Shift] + [F9]	If any OSUI screen is displayed; disconnect yourself from the active channel port without logging out
[F10]	If the administrator has set “Display All Computers” to “Yes” and the Selection Menu is sorted by channel port ID, toggle the display of all channel ports (including inaccessible ones) on or off
[F11]	Unit Status Menu for connected Raritan Remote Power Control unit (available only from Power Control Menu)
[F12]	If you are at the Selection Menu: Toggle the Selection Menu between sorting the channel port entries by name or by channel port ID
[Esc]	Exit the OSUI (returns user to the Selection Menu, or to the login screen when no channel port is selected)

Notes:

→ If a user does not have administrator privileges, then functions [F5], [F6], and [F7] are displayed in red in the Help Menu, indicating that these functions are not available to them.

→ If a system administrator has set Display All Computers to “No,” then [F10] is displayed in red in the Help Menu for all users, indicating that this function is not available (even for administrators).

→ We recommend that you use a Sun keyboard if there are any Sun CPUs in your system, control Sun CPUs with a PS/2 keyboard (see **Appendix F: Emulating Sun Keys with a PS/2 Keyboard**).

Information Menu

When the OSUI is open, activate the Information Menu by pressing function key [F8]. This menu displays the “vital statistics” of the User Station that your user station is attached to, including its firmware and hardware revisions, its serial number, which console port (user port) on the Base Unit attached to it, and the number of KVM switches and PC CPUs that can be accessed through it.

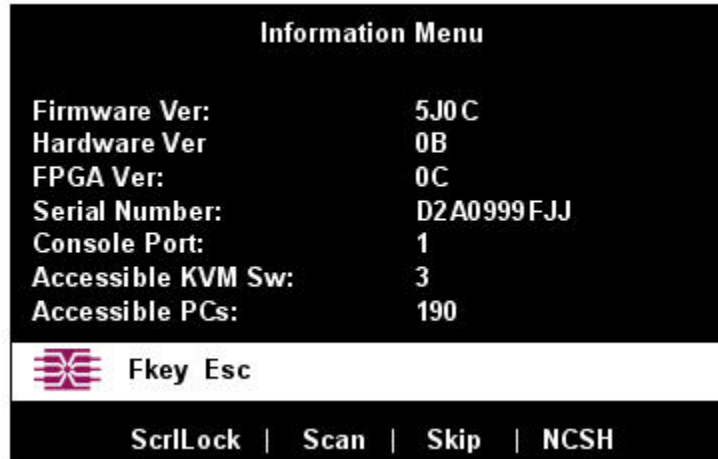

Figure 33 Information Menu

Chapter 4: Operation – Administrator Functions

The Administration Menu

Administrators can use the Administration Menu to set security classes, maintain user names and privileges, and manage the system configuration, including controlling user access to Paragon II and all connected devices.

Note: Administrative user IDs assigned to group 00 have complete access to all of the Administration Menu's submenus. Other administrative users have limited access and cannot select the System Configuration and User Configuration submenus.

To reach any of the Administration Menu's submenus:

1. Log on using the **admin** user name (or your own user name if you have administrator privileges). The default password for the admin user is **raritan**, all lowercase, but we recommend this password be changed as soon as Paragon II is initially installed. The Selection Menu will appear.
2. Press [**F5**]. The Administration Menu will appear.

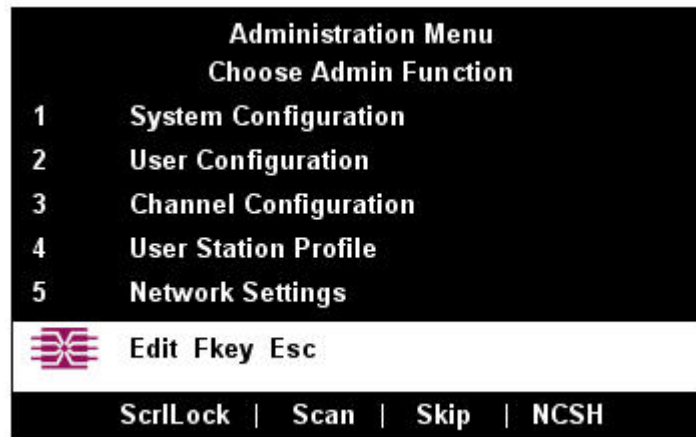

Figure 34 Administration Menu

3. Press any keyboard number from 1 through 5, or use the up- and down-arrow keys to move the highlight to your desired option, and press the [**Enter**] key. This chapter describes the submenus that appear.

Guidelines for System Configuration

- Only one user should attempt to modify/update the System Administration Menu at one time (especially the User Configuration and Channel Configuration options).
- Z-CIMs should be added one at a time to a Z-CIM chain. The Administrator should read from message banner that the database has been completely updated before adding a new Z-CIM.
- If in a tier environment, make certain that the tiered units are powered ON before the base is powered ON, e.g., 3rd tier, then 2nd tier, then base.
- If updating the system is necessary at Installation, make certain all users have logged off.

System Configuration

Administrators can use the System Configuration Menu for setting certain global parameters.

1. From the Administration Menu, press [1] or use the up- and down-arrow keys to move the highlight to “System Configuration” and press the [Enter] key. The System Configuration Menu will appear, displaying the current parameters (described below and on the following pages).
2. Press the down-arrow or [Tab] key to move the highlight forward, or the up-arrow or [Shift] + [Tab] to move the highlight backward to a desired field. Press the [Enter] key to edit the field. The highlighted area will turn green. Some fields have character or numeric values you can type in; others have values you can toggle between with the arrow keys. When editing is complete, either press the [Enter] key followed by [S] to save your changes, or press [Esc] to abort the changes and continue using the previous settings.

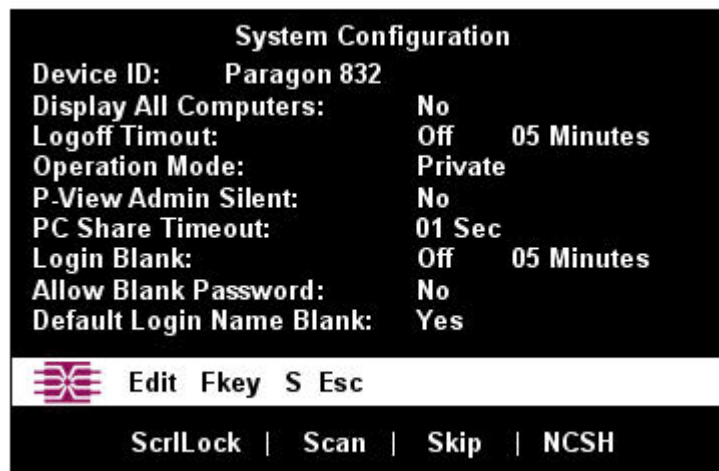

Figure 35 System Configuration Menu

- **Device ID:** Type in the desired name for the single or master Paragon II Base Unit. It is important for Base Units in a cascaded system with multiple Base Units to have distinctive names, so that users can tell them apart. (The system will assign each Base Unit the default name “Paragon [users]x[channel ports]”: each P2-UMT242 will be named “Paragon 242, each P2-UMT442 “Paragon 442,” etc.)
- **Display All Computers:** This option can be “Yes” or “No” to respectively allow or disallow users from viewing channel port listings for all connected devices through the OSUI, even if the user doesn’t have the security privileges to access them. The factory-default setting is **No**.
- **Logoff Time Out:** If enabled, the amount of time in minutes that a user station can remain inactive (no keyboard or mouse activity) before the logged-in user at that station is logged out of the Paragon II system.
 - Possible values in the first field are “On” (logoff timeout is enabled) and “Off” (Logoff Timeout is disabled – the default value). Use the up- and down-arrow keys to toggle between these values.
 - If Logoff Timeout is set to “On,” the number in the second field is the number of minutes of inactivity that must elapse before the timeout is triggered and the user is logged out. Using leading

- zeroes if necessary, type in a two-digit number of minutes from 01 to 99, or use the up- and down-arrow keys to increment and decrement the current value by 1 respectively. The default setting is **05**. If Logoff Timeout is set to “**Off**,” the number in this field will have no effect.
- **Operation Mode:** Any of the three ways in which the Paragon system handles requests from multiple users for access to the same channel port. Use the up- and down-arrow keys to switch between the choices:
 - **Private:** A server or other device on a specific channel port can be accessed exclusively by only one user at a time. No other users can see or control that device until its controlling user selects a different channel port.
 - **Public View:** While one user is accessing a server or other device on a specific channel port, other users can select that channel port and view the video output from that device, but only the first user will have keyboard and mouse control. When the first user selects a different channel port, the waiting user who is first to type or move his/her mouse is given keyboard and mouse control. Status messages showing users’ identities appear on video-sharing users’ monitors when Public View mode is in effect.
 - **PC Share:** A server or other device on a specific channel port can be selected and accessed by more than one user, but only one user has keyboard and mouse control at any one time. If the PC share timeout is enabled and the user in control is idle (no keyboard or mouse activity) for the duration of the timeout, the waiting user who is first to type or move his/her mouse is given keyboard and mouse control of the PC.
 - **P-View Admin Silent:** When Operation Mode is set to “**Public View**,” the user in control of a server is normally notified when other users start and stop viewing the channel port’s video. However, when P-View Admin Silent is set to “**Yes**,” administrators can view other users’ video without activating this viewing-notification message. Use the up- and down-arrows to toggle between “**Yes**” and “**No**.” The default setting is **No**.
 - **PC Share Timeout:** If Operation Mode is set to “**PC Share**” and more than one user has selected a server, the first user to type or use his/her mouse will have control of the server. However, another user can gain control of the server if the first user’s keyboard and mouse remain idle for the length of this timeout. Using leading zeroes if necessary, type in a two-digit number of seconds from 01 to 99, or use the up- and down-arrow keys to increment and decrement the current value by 1 respectively. The default setting is **01**.
 - **Login Blank:** If enabled, the amount of time in minutes that a user station can remain inactive (no keyboard or mouse activity) at the Login Menu before the monitor goes blank. Press any of the keys on the keyboard to restore normal video.
 - Possible values in the first field are “**On**” (login blank is enabled) and “**Off**” (login blank is disabled – the default value). Use the up- and down-arrow keys to toggle between these values.
 - If the login blank is set to “**On**,” the number in the second field is how many minutes of inactivity must elapse before the timeout is triggered. Using leading zeroes if necessary, type in a two-digit number of minutes from 01 to 99, or use the up- and down-arrow keys to increment and decrement the current value by 1 respectively. The default setting is **05**. If the Logoff Timeout is set to “**Off**,” the number in this field will have no effect.
 - **Allow Blank Password:** Determines whether a user can specify a blank password, that is, delete any existing password and have no password at all. Use the up- and down-arrow keys to toggle between “**Yes**” (users may delete their existing passwords) and “**No**” (the default setting; starting with the first time they change their password, users must always have a non-blank password). Newly created users always start with no password, and must assign one to themselves during initial setup.
 - **Default Login Name Blank:** Determines whether the User Name field in the Login Menu will be blank when the menu appears, or if the field will contain the default user name (the first available “**userxy**” name, where “xy” is a two-digit number with leading zeroes—“user01,” “user02,” and so on). Use the up- and down-arrow keys to toggle between “**Yes**” (the field is blank – the default value) and “**No**” (field contains the user name).

User Configuration

As administrator, use the User Configuration Menu to add, delete, and edit user names and security rights, and to display the current connection status for each user.

User Configuration						
User:	ADMIN					Page: 1/2 →
Name	Adm	Group				
ADMIN	Yes	00	--	--	--	--
User01	No	00	--	--	--	--
User02	No	00	--	--	--	--
User03	No	00	--	--	--	--
User04	No	00	--	--	--	--
User05	No	00	--	--	--	--
User06	No	00	--	--	--	--
User07	No	00	--	--	--	--

 Edit Ins Del Fkey S L Esc

ScrLLock | Scan | Skip | NCSH

Figure 36 The “left end” of the User Configuration Menu

This menu displays one user’s information in each row. There are two “sides” of this menu, indicated by the right-pointing arrow at the top of the menu. The fields and columns on the “left side” of this menu:

- **User:** Your user name. This field cannot be edited.
- **Name:** The user names assigned to all user accounts. Except for the special user name “**admin**,” these user names can be edited: You can type in new names up to eight alphanumeric characters long (not case-sensitive).
- **Group:** The ID numbers of the security groups to which users are assigned.
- **Adm:** Indicates whether any given user has administrator privileges. You can use the up- and down-arrow keys to toggle between “Yes” and “No” (the default setting).

Use the arrow keys, [Tab], [Shift] + [Tab], [PgUp] (page up), [PgDn] (page down), [Home], and [End] to move within this menu and its submenus. Press the [Enter] key to edit a highlighted field; it will turn green. When you finish editing a field, press either the [Enter] key to save the changes or press the [Esc] key to abort changes.

Press the **[Tab]** key or the right-arrow key to move to the “right end” of the menu and display users’ connection information: The Connection column displays which channel port (if any) each active user is currently connected to.

User Configuration						
User:	ADMIN					Page: 2/2 ←
Name		Group				
ADMIN	00	--	--	--	--	
User01	00	--	--	--	--	
User02	00	--	--	--	--	
User03	00	--	--	--	--	
User04	00	--	--	--	--	
User05	00	--	--	--	--	
User06	00	--	--	--	--	
User07	00	--	--	--	--	

 Edit Ins Del Fkey S L Esc

ScrlLock | Scan | Skip | NCSH

Figure 37 The “right end” of the User Configuration Menu

You can also perform three other functions at this menu:

- Add a new user by pressing the **[Insert]** key. A new default user name will be added to the existing list (for example, if users “user01” through “user25” already exist and a new one is added, its default name will be “user26”); you can edit the name as desired. The maximum number of users is 127 (512 with memory card); the default names of users added after “**user99**” will contain three digits.
- Delete a user by moving the highlight to a user name and pressing **[Delete]**. Paragon II will ask for confirmation; if you respond by pressing **[Y]**, that user account will be deleted from the system.
- A user with administrator privileges can log off another connected user by highlighting a user name and pressing **[L]**. That user name will then be disconnected from the Paragon system.

Channel Configuration

As administrator, use the Channel Configuration Menu to edit or initialize a P2CIM-PS2. You can change the device name, individual scan rate, device type, and group IDs associated with each server or device. When you save Channel Configuration changes, Paragon II will update each affected P2CIM-PS2 as necessary.

Channel Configuration			
Paragon832		Scn	Page 1/4→ Device
Ch. ID	Name		
1	MC_Rich	03	CPU
2	NT 4.0 Mail	03	CPU
3	Wins95.Bob	03	CPU
4	Wins98.Jack	03	CPU
5	MX4-Wing.2	--	
6	NT4.0-Fax	03	CPU
7	MC2-16.Reg1	--	
8	UMT8 Switch-Wing4	--	

 Edit G Fkey S Esc

ScrlLock | Scan | Skip | NCSH

Figure 38 The “left end” of the Channel Configuration Menu

This menu displays one channel port’s information in each row. If the Paragon system detects a powered device on that channel port, it will display the text in that row in green; otherwise, it will display it in black. There are two “sides” of this menu, indicated by the right-pointing arrow at the top of the menu. The fields and columns on the “left side” of this menu:

- **ChID:** The channel port’s channel port-ID number.
- **Name:** The name of the device attached to that channel port. Device names are case-sensitive and may be up to twelve alphanumeric characters long. As shown with channel port #1 in and elsewhere, you may leave a device name blank if you wish, but Raritan does not recommend this.
- **Scn:** Displays the device’s individual scan rate (the length of time that the system pauses while scanning that channel port for any user with Scan Mode set to “Individual” rather than “Global”). Using leading zeroes if necessary, type in a two-digit number of seconds from 01 to 24, or use the up-and-down-arrow keys to increment and decrement the current value by 1 respectively. The default setting is **03**.

Use the arrow keys, [Tab], [Shift] + [Tab], [PgUp] (page up), [PgDn] (page down), [Home], and [End] to move within this menu and its submenus. Press the [Enter] key to edit a highlighted field; it will turn green. When you finish editing a field, press either the [Enter] key followed by [S] to save the changes, or press the [Esc] key to abort them.

While the cursor is in the Device column, press [Tab] or the right-arrow key to move to the “right end” of this menu and display devices’ group information: The Group columns display which groups (if any) the device has been assigned to.

Channel Configuration			
Paragon832		Page 3/4 ←	
Page:		Scn	Device
Ch. ID	Name		
1	MC_Rich	03	CPU
2	NT 4.0 Mail	03	CPU
3	Wins95.Bob	03	CPU
4	Wins98.Jack	03	CPU
5	MX4-Wing.2	--	
6	NT4.0-Fax	03	CPU
7	MC2-16.Reg1	--	
8	UMT8 Switch-Wing4	--	
 Edit G Fkey S Esc			
ScrlLock Scan Skip NCSH			

Figure 39 The “right end” of the Channel Configuration Menu

User Station Profile

As administrator, select Option 4 from the Administration Menu to activate the User Station Profile to set the global keyboard type and video delay.

Keyboard Type

The Paragon's OSUI supports three types of keyboard mappings: Select either "English" – the default is U.S. English, "French," or "German". If you prefer using a non-English keyboard, temporarily attach an English-language keyboard; use any of its arrow keys to move the highlight to the "Keyboard Type" field, press the [Enter] key to turn the highlight green, use any of the arrow keys to toggle the field to the correct keyboard type, and press the [Enter] key again to select it. You can now swap in the type of keyboard you want to use.

Video Delay

If your monitor switches too much between resolutions, or takes too long to sync up when you scan or switch channel ports on Paragon II (if it is an LCD monitor), you can set a video delay for channel port switching at your user station.

If you set the video delay to any number of seconds greater than zero, Paragon II will wait until a video signal is constant for that number of seconds before passing it through to the monitor. To set video delay, use any of the arrow keys to move the highlight to the "Video delay--switching" field, press the [Enter] key to turn the highlight green, type in the desired two-digit delay from 00 to 30 seconds (or use the up-and down-arrow keys to increment or decrement the field by 1), and press the [Enter] key again to select it.

When you finish making any changes to either of these values, press [S] to save the changes to memory, or press [Esc] to abort them. The changes are applied only to your user station (the station at which the change was made).

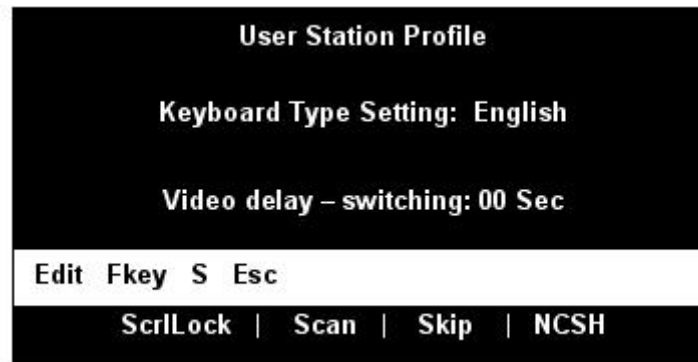

Figure 40 User Station Profile Screen

Group Settings (Access Rights)

To assign access rights to users and security levels to server CPUs in a Paragon system, assign users to user groups with defined rights and CPUs to channel port groups with defined accessibility. Each group can contain multiple users or CPUs. By default, all users start out assigned to user group 00 and all CPUs start out assigned to channel port group 00. You can create groups numbered from 00 to 99 for both users and CPUs; each user can belong to a maximum of five user groups and each CPU can belong to a maximum of eight channel port groups.

Note: Cascade channel ports cannot be assigned to groups.

	USER GROUPS:	COMPUTER GROUPS:
Available Group IDs for Assignment	00 – 99	00 – 99
Maximum Number of Group IDs Which Can Be Assigned	5	8

Users and computers communicate according to the following Group ID access rules:

GROUP ID FOR USERS:	CAN ACCESS COMPUTERS WITH GROUP IDs:
00	00 through 99 (all computers)
For IDs 01 through 09:	
0X through 0X	00, 0X; and X0, X1, X2, X3, X4, X5, X6, X7, X8, and X9
<i>For example:</i>	
05	00, 05; and 50, 51, 52, 53, 54, 55, 56, 57, 58, and 59
For IDs 10 through 99:	
X0 through X9	00, 0X, and exact same computer ID# as the user's ID#
<i>For example:</i>	
98	00, 09 and 98

GROUP ID FOR COMPUTERS:	CAN BE ACCESSED BY USERS WITH GROUP IDs:
00	00 through 99 (all users)
For IDs 01 through 09:	
0X through 0X	00, 0X; and X0, X1, X2, X3, X4, X5, X6, X7, X8, and X9
<i>For example:</i>	
08	00, 08; and 80, 81, 82, 83, 84, 85, 86, 87, 88, and 89
For IDs 10 through 99:	
X0 through X9	00, 0X, and exact same user ID# as the computer's ID#
<i>For example:</i>	
12	00, 01, and 12

THESE USER GROUPS...	...CAN ACCESS THESE CHANNEL PORT GROUPS:
00	00 through 99 (all CPUs)
0x (01 through 09)	00, 0x, and x0 through x9
<i>For example:</i>	
<i>01 can access 00, 01, and 10 through 19;</i>	
<i>02 can access 00, 02, and 20 through 29, etc.</i>	
xy (10 through 99)	00, 0x, and xy
<i>For example:</i>	
<i>10 can access 00, 01, and 10</i>	
<i>23 can access 00, 02, and 23</i>	
<i>97 can access 00, 09, and 97, etc.</i>	
THESE CHANNEL PORT GROUPS...	...CAN BE ACCESSED BY THESE USER GROUPS:
00	00 through 99 (all users)
0x (01 through 09)	00, 0x, and x0 through x9
<i>For example:</i>	
<i>01 can be accessed by 00, 01, and 10 through 19</i>	
<i>02 can be accessed by 00, 02, and 20 through 29, etc.</i>	
xy (10 through 99)	00, 0x, and xy
<i>For example:</i>	
<i>10 can be accessed by 00, 01, and 10</i>	
<i>45 can be accessed by 00, 04, and 45</i>	
<i>86 can be accessed by 00, 08, and 86, etc.</i>	

Recommendations

Systems Requiring High Security:

Raritan Computer recommends assigning IDs of **10 through 99** to computers requiring high protection. This will make them less accessible than computers with IDs of **00 or 01 through 09**.

Main System Administrator and Assistant Administrators:

Although any user may be assigned Administrative Privileges, Raritan recommends the user ID "00" for the Main System Administrator, and user IDs **01 through 09** for Assistant Administrators. These IDs provide a broader scope of access.

Correspondingly, Raritan recommends that those CPUs that all users will need to access, such as application or document servers, be assigned to channel port group **00**, and that servers needing the most security protection be assigned to channel port groups from **10 to 99**.

Network Settings

Configure the Paragon II's network settings from the OSUI by pressing [F5] to activate the Administration Menu. Select option 5, Network Settings to adjust the network settings of the device.

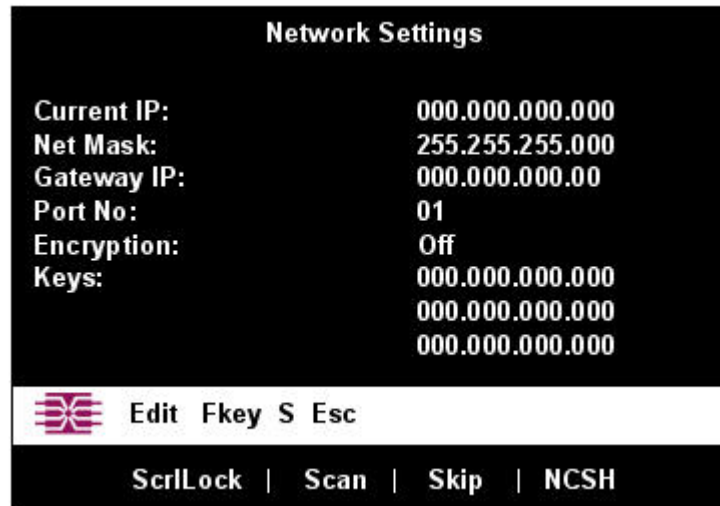

Figure 41 Network Settings Menu

- **Current IP Address:** This field allows administrators to configure the Paragon II's address on the network. Use the arrow keys to scroll over to each byte and change the IP as needed. The default IP address is **192.168.0.192**.
- **Net Mask:** The net mask for the Paragon II unit is set at a default value of **255.255.255.0**. Reset this as necessary.
- **Gateway IP:** This default is set to **192.168.0.1**. Reconfigure as needed.
- **Port No:** Default is **3000**.
- **Encryption:** If you enable Encryption for the network port, communications between the Paragon II unit and Paragon Manager clients run from an admin PC are encrypted with a 128-bit key. Default setting is **Off**.
- **Keys** (followed by 16 fields): These fields are designed to contain the hexadecimal encryption keys used in encrypting network traffic. Only valid HEX values will be accepted in these fields. Default value is set to **00**.

After saving the changes, the Paragon II will automatically reboot with the new network settings.

When building a tiered system of Paragon II units, each Paragon II should be connected to the network with a unique IP address. In such a system, changing the network settings through a user station will change the network settings of the Paragon II that user station is physically connected to. For example, a P2-UST connected to the base tier of a system will change the IP address only of that base unit, while a P2-UST connected to a third tier Paragon II will change the IP address of that particular third tier unit.

It is essential to put all base units in a Paragon II system on the network, as firmware upgrades are pushed across the system through TCP/IP. While the firmware upgrade needs to be sent only once to the base unit to update the entire system, that base unit will be unable to upgrade the other units in the system if they do not have properly configured network access.

Autoscanning and Autoskipping

As administrator, you can press [F6] to turn autoscanning on and off. When autoscanning is turned on, Paragon II switches sequentially and automatically from one channel port to the next, displaying each channel port's video for the duration of the user's global scan rate or the channel port's individual scan rate (see **Chapter 3: Operation – User Functions, User Customization**), starting over at port 1 when it reaches the last channel port.

In a cascaded system, when the scan reaches a channel port to which a subsidiary Base Unit is attached, it “drops down” to the subsidiary's channel ports and scans them before resuming with the higher-level channel ports.

To take keyboard and mouse control of the CPU on a given channel port, autoscanning must be turned **off**. The word “Scan” at the bottom of the OSUI menus will appear in white when autoscan is off or yellow when autoscan is on.

In Paragon II's default setting, autoscanning will display all of system's channel ports (including vacant ones), except those occupied by CPUs that the user has not been granted the keyboard and mouse-control rights for, that is, the CPUs that are not in one of the user's permitted groups – see the section **Group Settings** in this chapter. To allow a user to see CPUs that he or she cannot otherwise access, an administrator must set “Display All Computers” to “**Yes**” (see the section **System Configuration** in this chapter). To force the system to skip over vacant channel ports, an administrator must turn on autoskipping.

While logged in to Paragon II, administrators can press [F7] to turn autoskipping on and off. When autoskipping is turned on, the Paragon will automatically skip vacant ports while autoscanning or when a user tries to switch to such a port manually. The word “Skip” at the bottom of the OSUI menus will appear in white when autoskip is off or yellow when autoskip is on.

Power Management

An administrator can control power to connected devices directly via the Paragon II OSUI. To use the power management features of Paragon II, you will need Raritan's Remote Power Control Unit in one of three models, depending on your needs:

- PCR8 – 8 port, 1U rack mount
- PCS12 – 12 port, “zero-U” vertical mount
- PCS20 – 20 port, “zero-U” vertical mount

A special Raritan Power CIM (P2CIM-PWR) is available for use with this power strip. Attach this CIM to the RJ45 port on the Power Strip, and then connect the power strip in to an AC source. Connect the CIM to one of the target ports on a UMT unit. The P2CIM-PWR is required for integration with the Paragon OSUI.

Configuring and Naming the Power Strip

Activate the Paragon II OSUI. The new power strip should appear in the appropriate channel port under the name PCR8, PCS12, or PCS20, depending on the model type. The Power Strip will be treated exactly like a second tier device.

1. Press **[F5]** to activate the Administrative Menu and select the Power Strip channel port for configuration.
2. Edit the name of the Power Strip as it is displayed in the OSD. The model type should already be selected as the appropriate type.
3. Press **[G]** to configure the individual power outlets on the power strip.

Associating a Target with a Power Outlet

Since Paragon II cannot determine the type of device through a power outlet connection, associations of targets with individual power outlets must be done manually.

1. Press **[F5]** to select the “Administration Menu” and select option 3, “Channel Configuration”
2. Highlight the connected power strip and press **[G]** to enter the “Outlet Configuration” Menu. The outlet number corresponds to the number under the “Ch. ID” column.
3. Under the “Type” column, highlight an outlet and press **[Enter]** to configure the device type:
 - a. **PWR**: This is the default association type and refers to devices not connected to the Paragon II system (a router or a monitor).
 - b. **CPU**: Select this type for all devices connected to the Paragon II system (including “non-server” targets such as UMT switches).
4. Press the right arrow to highlight the name field then press **[Enter]** to configure the name of a target associated with that outlet.
 - a. If the type is set to **PWR**, users will be able to change the name of the device as desired.
 - b. If the type is set to **CPU**, the OSD will request you to save changes (“Y/N/ESC”), then display a “Select Powered Device” menu. This is an alphabetized list of all devices connected to the Paragon II system, allowing the user to indicate which target is powered by the newly configured outlet.
5. Highlight the desired device and press **[Enter]**. The selected target will be automatically associated with that power outlet. The outlet name will be the Channel ID of the target. Press **[S]** to save the configuration.
6. Press the right arrow key to scroll to the next page of the configuration menu for setting security groups for a power outlet. See **Group Settings**, earlier in this chapter for more information on setting access rights. This allows administrators to limit who is authorized to control power to various targets. The default setting for each group on that outlet is “- -“, which means no access to any user other than the Admin user. Note, once a group ID setting is changed, it can never return to the original “- -“ state.

Controlling Power to an Outlet

The addition of a power strip to the Paragon II system allows administrators to control the power to targets in two ways:

Controlling power from the Server Selection Menu:

Normal Paragon II operation involves browsing the list of devices in the OSUI and pressing **[Enter]** to switch to that target. By pressing **[F3]** instead of **[Enter]** when a target is highlighted, Paragon II will check that target for Power Strip associations:

- If Paragon II does not detect any associations with that target, a message indicating "No Outlets / Access Denied" appears, and the action is cancelled.
- If the target has associated power outlets, but the user is not authorized to control those outlets, a "No Outlets / Access Denied" message will appear and the action will be cancelled.
- If Paragon II sees that this target is associated with at least one power outlet, it will switch to that target. The OSUI will remain on-screen, displaying a list of power outlets associated with the target. This allows users to see the target before power is cycled to it.
 - You will be given four choices from this menu: **Power Off (X)**, **Power On (O)**, **Recycle Power (R)**, and **Select All (A)**
 - If the target is powered OFF, pressing **[O]** will power ON the outlet instantly.
 - If the target is powered ON, pressing **[X]** or **[R]** will activate a confirmation dialog "Are you sure (yes/no)?" As a safeguard, type in the whole word "yes", to confirm cutting power to the target. Typing in "y," or anything other than "yes" will be accepted as a "no."
 - In the case of a target associated with multiple outlets, such as a server with dual power supplies, pressing **[A]** will highlight all the associated outlets, allowing them to be turned on, off, or recycled simultaneously.

Controlling Power from the Outlet Selection Menu

A connected power strip is treated as a second tier device. The power strip, therefore, has its own device menu consisting of "ports" for each power outlet with which power can be controlled on a per-outlet basis.

- Navigate the Paragon II OSUI, select the Raritan Power Strip and press **[Enter]**. You will now be at the "Outlet Selection" menu.
- A list of outlets (up to 8 per page) will appear. Targets in green are switched ON; targets in black are switched OFF.
- As with the "Server Selection" Menu, press **[X]**, **[O]**, or **[R]** to turn off, turn on, or recycle power to the target respectively. Type "yes" to confirm turning off the power if you select **[X]** or **[R]**.

Getting Power Strip Unit Status from the Outlet Selection Menu

At any time while navigating the "Outlet Selection" Menu, pressing **[F11]** will provide a status screen showing certain parameters of the connected power strip. These parameters include:

- Average power
- True RMS Current
- True RMS Voltage
- Internal Temperature
- Apparent Power
- Maximum Detected
- Outlet Circuit Breaker

Note: Unlike second tier channel ports, the power outlet "channel ports" will not appear in the list of targets when the OSUI is in "channel port selection by Name" mode.

Paragon II Network Port

Paragon II contains a network port and is designed as a network-aware device. This network port is used to communicate with Paragon Manager administrative software, packaged with the Paragon II unit (please refer to Paragon Manager User Guide).

Chapter 5: Paragon II and Z-CIM

If you have a local PC CPU that you want only the user(s) at a certain user station to be able to access, but you want that user station to be able to access the CPUs attached to the Paragon system as well, insert a P2CIM-PS2 dual-access CIM between a User Station and a Base Unit.

To do this for a given user station:

1. If you have not already done so, install your Paragon system as described in **Chapter 2: Installation**.
2. Take the cable that connects the user station's User Station to the Base Unit and disconnect it from the Base Unit's user port.
3. Connect the free end of this cable to the RJ-45 port labeled "UTP OUT" on the ZCIM-PS2.
4. Run another CAT5 cable from the RJ-45 port labeled "UTP IN" on the ZCIM-PS2 to the same user port on the Base Unit from which you disconnected the other cable.
5. Plug the ZCIM-PS2's HD15 strand into the HD15 VGA video port of the CPU you want the user station to have local access to. Plug its purple 6-pin mini-DIN keyboard strand into the CPU's 6-pin mini-DIN keyboard port. Plug its light green 6-pin mini-DIN strand into the CPU's 6-pin mini-DIN mouse port.
6. Plug in and power ON the CPU. If the P2CIM-PS2 is installed and operating properly, the P2CIM-PS2's green LED will start blinking: once per second while the P2CIM-PS2 is idle, or more quickly while data passes in either direction.

Once this installation is finished, activate Local PC Mode on the User Station:

1. Log on at the attached user station.
2. Press the hotkey ([**Scroll Lock**] is the default) twice in quick succession to activate the OSUI.
3. Press [**F4**] to activate the User Profile Menu (see **Chapter 3: Operation – User Functions, User Customization**).
4. Use [**Tab**] or the up- and down-arrow keys to move the highlight to the **Local PC** field.
5. Press the [**Enter**] key. The **Local PC** field will turn green.
6. Use the up- or down-arrow key to toggle the value of the field to "**On**."
7. Press the [**Enter**] key. The highlight will turn yellow.
8. Press [**S**] to save the change and return to the User Profile Menu. If you do not wish to save changes, press the [**Esc**] key to abort the change and return to the User Profile Menu.

Once Local PC Mode is turned on, you can access the dedicated local PC CPU from this user station by pressing the [**Home**] key twice in quick succession while the OSUI is on-screen. The User Station will immediately switch you to the local PC. To return to the Paragon system and its switched CPUs, activate the OSUI by pressing the hotkey twice ([**Scroll Lock**] is the factory default), then press [**F2**] to activate the Selection Menu and access any of the listed servers.

Connecting Z-CIMs as Tiers

The following diagram shows the final setup when connecting Z-Series Z4200U Z-CIMs as a tier:

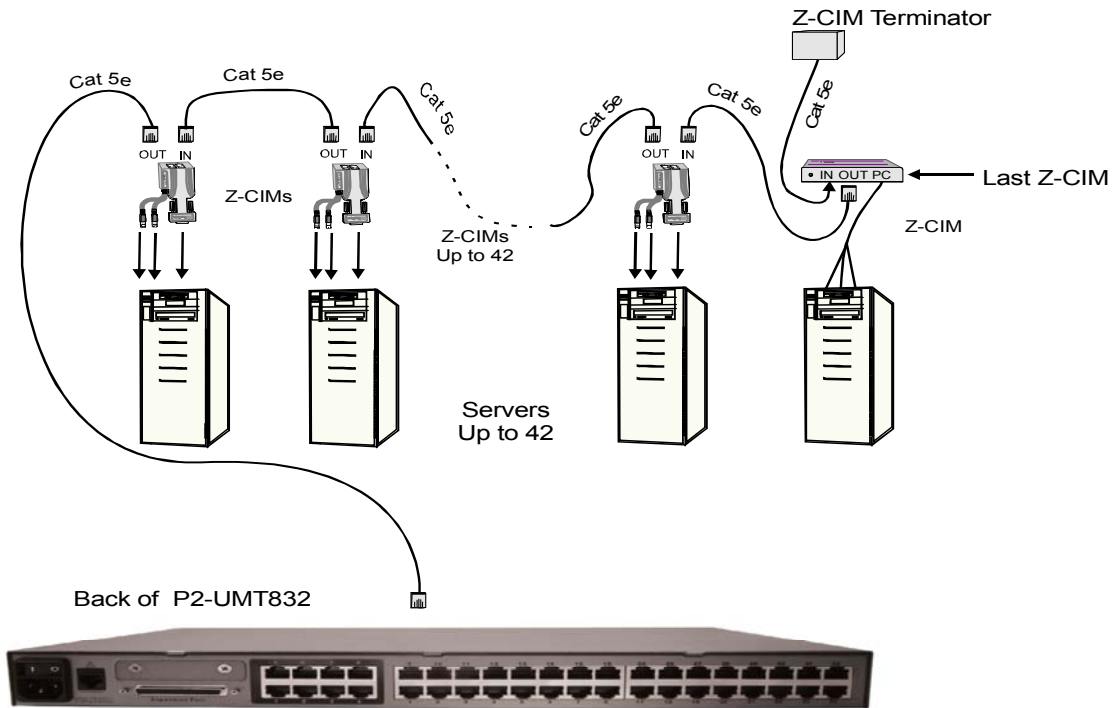

Figure 42 Connecting a Z-CIM as a Tier to Paragon II

Important: Z-Series installation requires that each computer be assigned a channel name as it is added to the Z-CIM chain. Computer channels are organized alphabetically by assigned name (or the default name, the Z-CIM's serial number), rather than in the order of their placement within the Z-CIM chain. We recommend that installers assign channel names before connecting all computers to eliminate any difficulty in locating the respective channel for each computer.

Note: When following the installation and configuration instructions below, sort the Selection Menu by Channel ID Number, not by Name. Display the menu by pressing [F2] and change the sorting method by pressing [F12].

All Paragon II components must be powered ON prior to Z-CIM tier installation. All computers in the Z-CIM chain and all Z4200U components must be powered OFF prior to installation.

Connect a Z-CIM as a Tier:

1. Connect a Category 5e UTP cable to the channel port on the Paragon II unit reserved for the Z-CIM chain.
2. Connect the other end of this Category 5e UTP cable to the UTP OUT port on a Z-CIM, which will be the first Z-CIM in the chain.
3. Connect a computer to the first Z-CIM.

For UKVMSPD Z-CIM:

- a. Connect the 6-pin mini-DIN keyboard and mouse and HD15 video connectors on the UKVMSPD Z-CIM to computer's keyboard, mouse, and video ports.
- b. Place the Z-CIM Terminator in the Z-CIM's UTP IN port.
- c. Power ON computer.

For UKVMSC Z-CIM with local port:

- a. Connect DB25 male end of CCPnn cable to DB25 female port on back of a Z-CIM (UKVMSC).
- b. Connect other end to computer's keyboard, video, and mouse ports.

- c. Place the Z-CIM Terminator in the Z-CIM's UTP IN port.
- d. Power ON computer.
- e. **Optional:** Connect a local user console to the UKVMSC Z-CIM.

Perform Channel Configuration:

1. At a User Station Login Menu, type **admin** in the User Name field and press [**Enter**].
2. Type "aritan" (all lowercase) in the Password field and press [**Enter**].
3. Press [**F5**] to go the Administration Menu and select the Channel Configuration submenu.
4. Use the [**↑**] and [**↓**] or the [**Page Up**] and [**Page Down**] keys to highlight the Paragon II channel where the Z-CIM was just added.
5. Ensure that the Device field reads **Zseries**.
6. If Zseries does not appear in the Device field:
 - a. Press [**Tab**] until the Device field is active, then press [**Enter**] - the highlight will turn green.
 - b. Use the [**↑**] and [**↓**] keys to change device type to Z-Series and press [**Enter**] - the green highlight will return to yellow.
 - c. Press [**S**] to save the change, or press [**Esc**] to exit without saving.
7. If a more descriptive name is desired:
 - a. Hold the [**Shift**] key and press [**Tab**] to go back to the Name column, then press [**Enter**] - the highlight will turn blue.
 - b. Edit the default name and press [**Enter**] - the highlight will turn green as you begin to type.
 - c. Press [**S**] to save the change, or press [**Esc**] to exit without saving.
8. Press [**F2**] to go to the Selection Menu to validate that the second-tier Z-CIM is properly configured. Select the tiered Z-CIM device and press [**Enter**].

Name the Computer Channel on the Z-CIM tiered Selection Menu:

1. When viewing the Paragon II Selection Menu or any OSUI menu, press [**F5**] to go to the Administration Menu.
2. Select the Channel Configuration submenu.
3. Select the Z-CIM device channel.
4. Press [**G**] to bring up a Channel Configuration menu for the Z-CIM chain.
5. Use the [**↑**] and [**↓**] keys to highlight the Name field of the computer just connected via Z-CIM. The channel for this computer is displayed in green, and the highlight will turn yellow when it is selected.
6. Press [**Enter**] - the highlight will turn blue.
7. Type the desired computer name - the highlight will turn green as you begin to type.
8. Press [**Enter**] - the highlight will turn yellow.
9. Press [**S**] to save the new name.

Verify and Save Changes:

1. Press [**F2**] to return to the Selection Menu.
2. The Selection Menu will display with the new computer name highlighted in white.
3. Press [**Enter**] to switch to this selected computer.
4. Normal computer access and operation indicates a successful connection.

Note: Repeat the steps on the previous pages:

→ Connect Z-CIMs as a Tier

→ Perform Channel Configuration

→ Name the Computer Channel on the Z-CIM tiered Selection Menu

→ Verify and Save Changes

for each server to be added to the chain. Name and test each computer as it is added. Follow the steps below to build the rest of the Z-CIM chain of servers.

Attach Z-CIM to Computer to be Added:**For UKVMSPD Z-CIM:**

1. Connect the 6-pin mini-DIN keyboard and mouse and HD15 video connectors on the UKVMSPD Z-CIM to computer's keyboard, mouse, and video ports.

For UKVMSC Z-CIM with local port:

1. Connect CCPnn cable's 6-pin mini-DIN and HD15 connectors to computer's keyboard, mouse, and video ports.
2. Connect DB25 male end of CCPnn cable to DB25 female port on back of Z-CIM (UKVMSC).

Attach new Z-CIM to the existing Z-CIM chain:

1. Remove Z-CIM Terminator from the last Z-CIM's UTP IN port and set aside.
2. Connect a Category 5e UTP cable to UTP IN port on the Z-CIM that is currently last in the chain.
3. Connect the other end of this Category 5e UTP cable to the UTP OUT port on the next Z-CIM/computer currently being added to the chain.
4. Place the Z-CIM Terminator in the added Z-CIM's UTP IN port.
5. Power ON computer.
6. Optional: Connect a local user console to the UKVMSC Z-CIM.

Name Computer:

1. At the Selection Menu, press [F5] to go to the Administration Menu.
2. Select the Channel Configuration submenu.
3. Select the Z4200U device channel.
4. Press [G] to bring up a Channel Configuration menu for the Z-CIM chain.
5. Use the [↑] and [↓] keys to highlight the Name field of the computer just connected via Z-CIM. The channel for this computer is displayed in green, and the highlight will turn yellow when it is selected.
6. Press [Enter] - the highlight will turn blue.
7. Type the desired computer name - the highlight will turn green as you begin to type.
8. Press [Enter] - the highlight will turn yellow.
9. Press [S] to save the new name.

Verify and Save Changes:

1. Press [F2] to return to the Selection Menu.
2. The Selection Menu will display with the new computer name highlighted in white.
3. Press [Enter] to switch to this selected computer.
4. Normal computer access and operation indicates a successful connection.

Important: At least half of all machines in the Z-CIM chain must be powered ON at any given time in order for the Z-CIM chain to function properly. There must be enough power to support all of the Z-CIMs in the chain.

Chapter 6: IBM x330

Paragon II unit firmware versions 1P0 (UMT2161), 2C2 (UMT242, UMT442, and UMT8), or 3A2 (UMT1664) and User Station (UST1) firmware 4L2 or higher supports an IBM x330 chain of computers as a second tier by utilizing IBM's Cable Chaining Technology (C2T) and Raritan Computer Interface Modules (CIMs), UKVMP-x330 or UKVMC-x330.

An IBM x330 rack of up to 42 servers can be accommodated for each Paragon II Matrix Switch channel port. This Paragon II feature lets users name each x330 server in the rack and see that name in a Paragon II Selection Menu, instead of utilizing blind x330 shortcut key switching techniques.

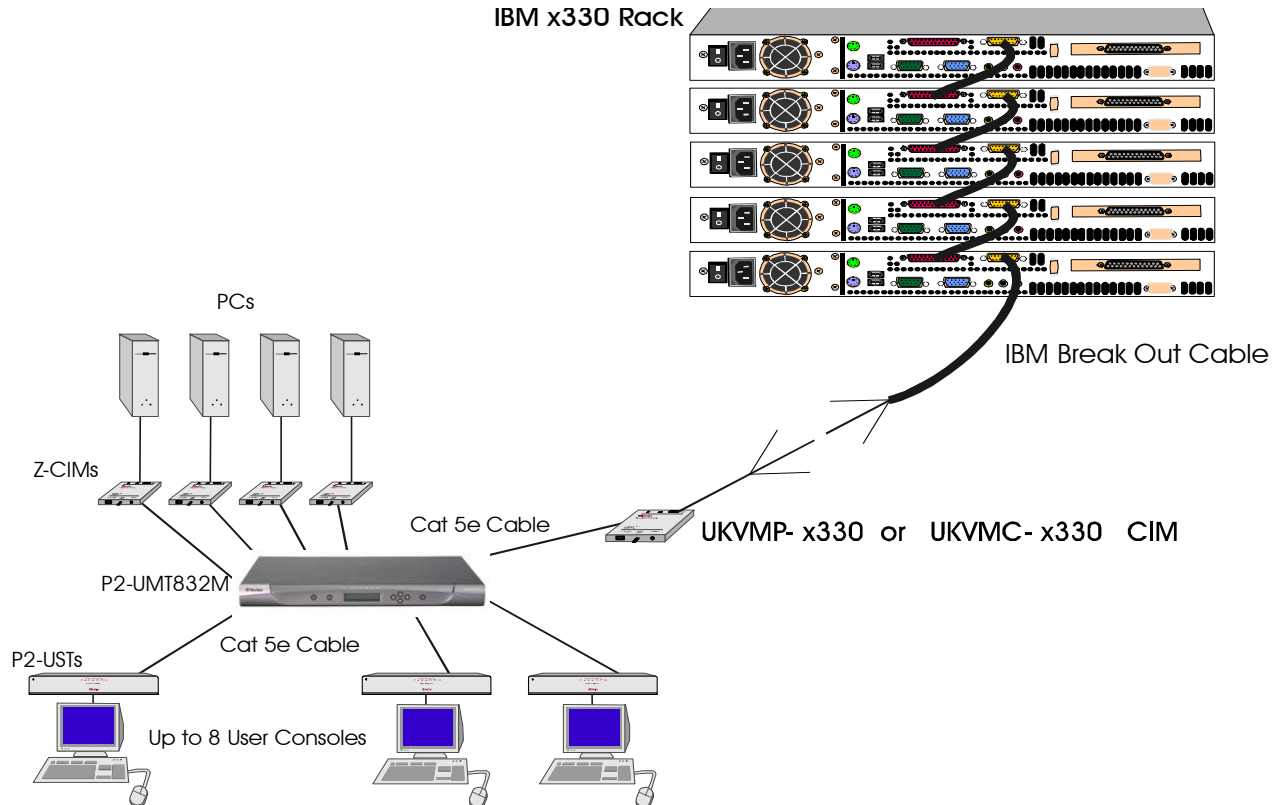

Figure 43 IBM x330 Tiered from a Paragon II Matrix Switch

Install an IBM x330 Rack of Servers as a Tier to Paragon II:

1. Set up Paragon II following Basic Installation instructions, but reserve one channel port for each rack of IBM x330 servers to be connected.
2. Connect a Category 5e UTP cable to the reserved channel port on the back of the Paragon II unit.
3. Connect the other end of the category 5e UTP cable to the RJ45 port on a Raritan CIM - UKVMP-x330 or UKVMC-x330.
4. Attach the CIM to IBM Break Out Cable from the x330 rack.

UKVMP-x330:

- a. Connect keyboard, monitor, and mouse cable legs attached to CIM to appropriate 15-pin female video port and 6-pin mini-DIN mouse and keyboard ports on IBM Break Out Cable.

UKVMC-x330:

- b. Connect DB25 male end of CCPnn cable to DB25 female port on UKVMC-x330.
- c. Connect the other end of the CCPnn cable to appropriate 6-pin mini-DIN mouse and keyboard ports, and HD15 video port on IBM Break Out Cable.

Set the IBM x330 Rack as a Second Tier Device:

1. From a User Station, login as **admin**, or use your user name if you have administrator privileges, and enter your password.
2. Press the [F5] key to go the Administration Menu, then select Channel Configuration submenu.
3. Use the [↑] and [↓] or the [Page Up] and [Page Down] keys to select the channel to which the IBM x330 rack is connected.
4. Press the [Tab] key to advance to the Device field - the highlighted area will be yellow.
5. Press the [Enter] key - the highlighted area turns green.
6. Use the [↑] and [↓] keys to change device type to IBM x330, then press the [Enter] key - the highlighted area turns yellow.
7. Hold the [Shift] key and press the [Tab] key to go back to the Name column.
8. Press the [Enter] key and edit the default name.
9. Press the [S] key to save the new configuration.

Save and Verify Changes:

1. Press [F2] to go Selection Menu to validate that second-tier IBM x330 rack is properly configured. Select and switch to one of the IBM x330 channels. Normal computer access and operation indicates a successful connection.
2. Press [F5] to go to Administration Menu. Select Channel Configuration submenu. Select the IBM x330 channel. Press [G] to bring up a Channel Configuration menu of the IBM x330. Edit names for each IBM x330 server in the rack.
3. Press [S] to save the new configuration.

Chapter 7: Configurations

When implementing complex tiered and stacked architectures for a Paragon system, there are important guidelines describing the legal and illegal configurations among devices in a Paragon system, and the procedures to make the system function in the appropriate manner that you must follow and procedures to make the system function in an appropriate manner.

Principles of Re-Connection

- Whenever a change is made to a connected tiered device, it is recommended that power to all devices is recycled, if possible. This includes the device where the connection is changed directly, as well as all devices below it in the system architecture.
- The sequence of power recycling should start from highest tiered device and end with the Main base unit. For example, in a “Single Base” configuration (only one UMT Matrix Switch as the base unit), if a connection change is made at a device on the third tier, the sequence of power recycling should be as follows:
 - The third tier device with the changed connection
 - The second tier device connected to the third tier device
 - The base unit

In the event that a change is required for an existing configuration, the chapter illustrates proper procedures for adding or removing units and changing tier paths.

Tiered Configurations

Standard Tiering Configurations

Single Base Configuration

Definition of Single Base configuration:

- Only UMT matrix switches can serve as base units.
- The base unit must always be the latest released version, both in hardware and firmware.
- A maximum of three (3) tiers, including the base unit, is permitted.
- Devices that are not Paragon II Matrix Switches but have two or more channel ports, such as Raritan MasterConsole or CompuSwitch, *are* treated as tier devices. These devices cannot act as base devices in a Paragon II system and can be connected only to a base unit or to a second tier Paragon II.

Initialization of a single base configuration with tiered devices from upper to lower tier:

- After all devices have been connected, power ON the devices from upper tier to lower tier.
- After initialization, each tiered device has an updated database.

Guidelines for changing connections of tiered devices:

Example A: Relocating an upper-tier device (refer to red colored dotted line)

1. Disconnect some or all of the user ports on the tiered unit (UMT-3A) that connect to the channel ports of the lower-tiered unit (UMT-2A) and re-connect the user ports to the channel ports of another lower-tier unit (UMT-2B).
2. Recycle the power of tiered devices. This is recommended to build a clean database for the UMT Matrix Switches. Sequence of recycling power is from the highest tier (tier 3) to the base unit. In our example: UMT-3A → UMT-2A → UMT-2B → UMT-Base.
3. The operation is the same for devices that are not UMT Matrix Switches.

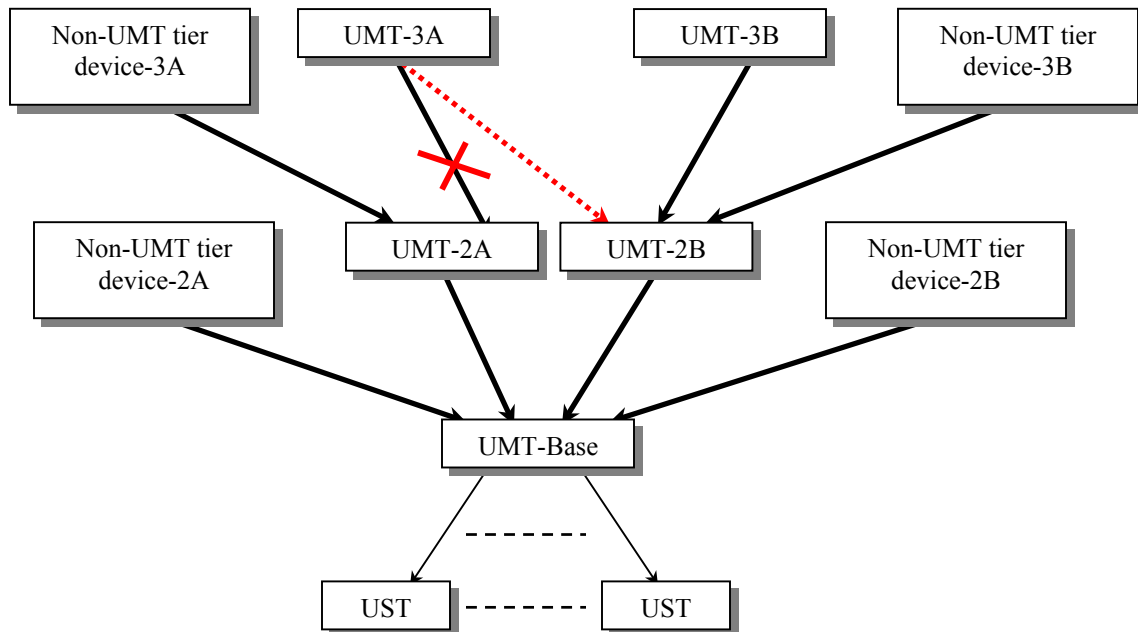

Figure 44 Single Base Configuration

Multiple Base Configuration

Definition of Multiple Base configuration:

- Two or more UMT Matrix Switches serve as base units.
- The base unit must always be the latest released version, both in hardware and firmware.
- A maximum of three (3) tiers, including the base unit, is permitted.
- Upper-tier devices connect to two or more base UMTs.
- Devices that are not UMT Matrix Switches but have two or more channel ports, such as Raritan MasterConsole or CompuSwitch, *are* treated as tier devices. These devices cannot act as base devices in a Paragon system and can be connected only to a base unit or a second tier UMT(s)

Initialization of a multiple base configuration with tiered devices

- After all devices have been connected, power ON the devices from upper tier to lower tier.
- After initialization, each tiered device has an updated database.

Guidelines for changing connections of tiered devices:

Example A: Relocating a 3rd tier device with multiple 2nd tier connections (refer to red colored dotted line in diagram):

1. Disconnect some or all of the user ports on an upper-tier unit (UMT-3A) that connect to the channel ports of a lower-tier unit (UMT-2A) and re-connect the user ports to the channel ports of lower-tier unit (UMT-2B).
2. Change the cable connections of the upper-tier unit (UMT-3A).
3. Recycle the power of tiered devices. This is recommended to build a clean database for the UMT Matrix Switches. Sequence of recycling power is from the highest tier (tier 3) to the base unit. In our example: UMT-3A → UMT-2A → UMT-2B → UMT-Base 1 → UMT-Base 2.

Example B: Relocating a 2nd tier device with multiple base tier connections (refer to blue colored dashed line in diagram):

1. Disconnect some or all of the user ports on a tiered unit (UMT-2C) that connect to the channel ports of a base unit (UMT-Base 1) and re-connect those user ports to another base unit (UMT-Base 2).
2. Change the cable connections of the tiered unit (UMT-2C).
3. Recycle the power of tiered devices. This is recommended to build a clean database for the UMT Matrix Switches. Sequence of recycling power is from the highest tier (tier 3) to the base unit. In our example: UMT-2C → UMT-Base 1 → UMT-Base 2.
4. The operation is the same for devices that are not UMT Matrix Switches.

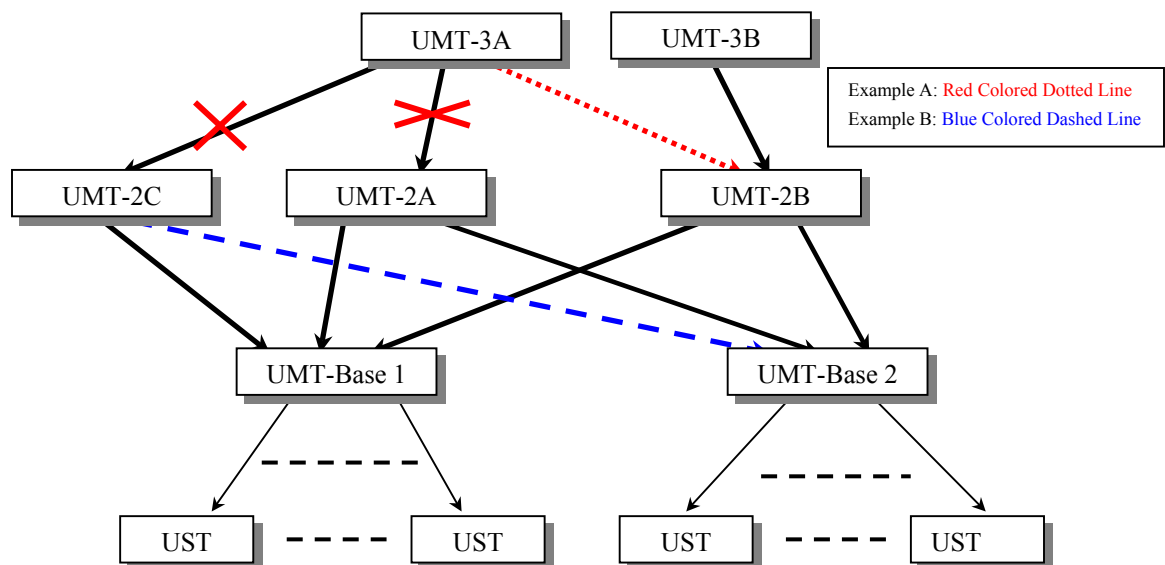

Figure 45 Multiple Base Configuration

Stacked Configurations

Definition of stacking configuration:

- The P2-UMT Stacking Switch, a new switch device required for stacking configurations, expands the number of available channel ports in a single switch. It does not add user ports.
 - UMT Stacking Switch P2-UMT1664S has four 68-pin expansion ports. Two are input ports and two are output ports. The P2-UMT832S has only one 68-pin expansion input port and one output port.
- The P2-UMT1664M has two 68-pin expansion ports, and P2-UMT832M has one 68-pin expansion port. These represent input ports.
- One or more UMT Stacking switches connect to a P2-UMT Matrix Switch through stacking cables in a daisy chain connection – that is, the expansion port of a P2-UMT832M connects to the expansion output port of a P2-UMT832S, and the expansion input port of this P2-UMT832S connects to the expansion output of another P2-UMT832S to form a daisy chain.
- For purposes here, this P2-UMT Matrix Switch is called the Master Device, and the UMT Stacking Switch is called the Stacking Device.
- The Master Device can be a base unit or a tiered unit.
 - The stacking device that connects to a master device becomes an automatic extension of the master unit.

System Constraints:

- The base unit should be a P2-UMT1664M / P2-UMT832M Matrix Switch
- The base unit must always be the latest release of P2-UMT Matrix Switch (hardware and firmware) in a closed configuration system.
- A Paragon I HW3 (with P2 firmware) can accommodate only one stacking switch.
- Up to three P2-UMT832S stacking units can be connected to each P2-UMT832M matrix unit.
- Only one P2-UMT1664S stacking units can be connected to each P2-1664M matrix unit.
- A maximum of 128 channel ports (Master Device + Stacking Devices) is permitted. When a P2-UMT1664M Matrix Switch acts as the Master Device, only one P2-UMT1664S Stacking Switch can be in daisy chain with it. When a P2-UMT832M Matrix Switch acts as the Master Device, up to three (3) P2-UMT832S Stacking Switches can be in the daisy chain.
- A P2-UMT1664M can have only P2-UMT1664S Stacking Switches daisy chained to it. A P2-UMT832M can have only P2-UMT832S Stacking Switches daisy chained to it. You cannot mix unlike configurations of Master Devices and Stacking Switches. For example, you cannot use a P2-UMT832S Stacking Switch with a UMT1664 Master Device and vice-versa.
- P2-UMT1664M / P2-UMT832M Matrix Switch and UMT1664/UMT832 hardware III Matrix Switch cannot act as Stacking Devices.
- Base units can never act as stacking units.

Standard Stacking Configurations

Single Base with Stacking

Example A: Non-blocked System – P2-UMT1664M

Standard configuration – any user can access any channel port in the system.

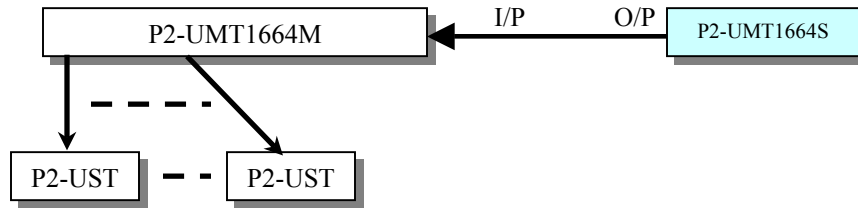

Figure 46 Stacking - Single Base Configuration with P2-UMT1664M and P2-UMT1664S

Example B: Non-blocked System – P2-UMT832M

Standard configuration – any user can access any channel port in the system.

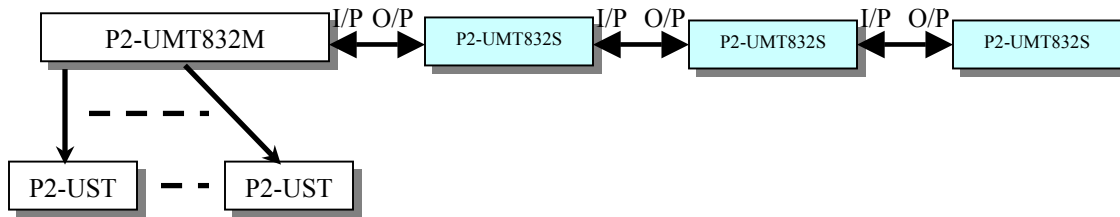

Figure 47 Stacking - Single Base Configuration with P2-UMT832M and P2-UMT832S

Example C: P2-UMT1664M Stacked and Tiered

Standard configuration – any user can access any channel port in the system.

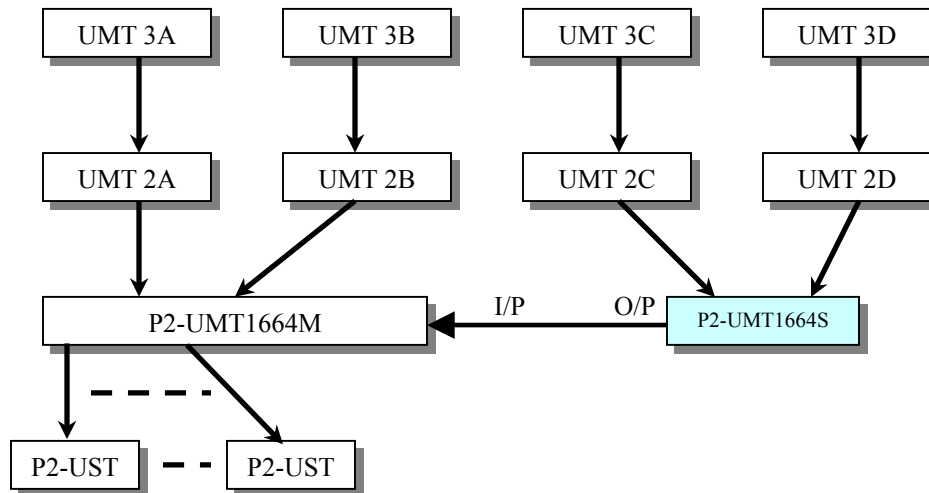

Figure 48 Stacking - Single Base Configuration with P2-UMT832M and P2-UMT832S

Example D: P2-UMT832M Stacked and Tiered

Standard configuration – any user can access any channel port in the system.

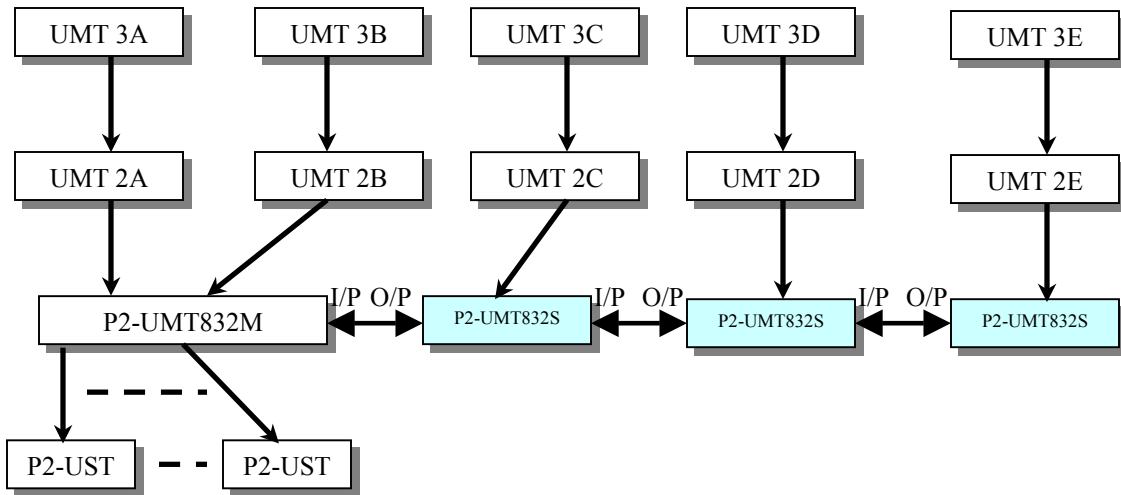

Figure 49 Stacking - Single Base Configuration with P2-UMT832M and P2-UMT832S

Example E: Illegal Configuration

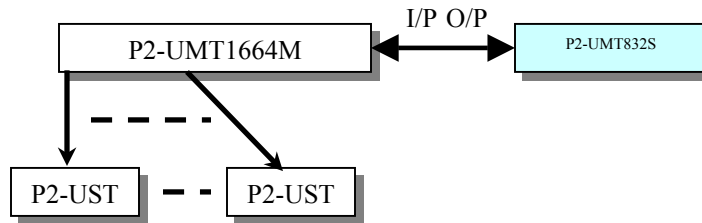

Figure 50 Stacking - Single Base Configuration with P2-UMT1664M and P2-UMT832S

Example F: Illegal Configuration

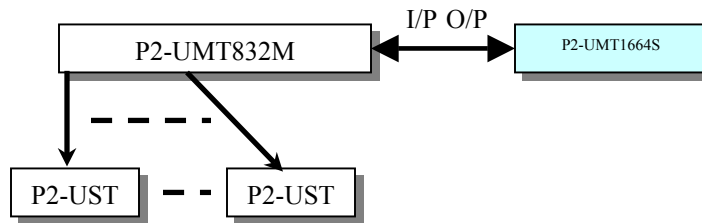

Figure 51 Stacking - Single Base Configuration with P2-UMT832M and P2-UMT1664S

Example G: Illegal Configuration

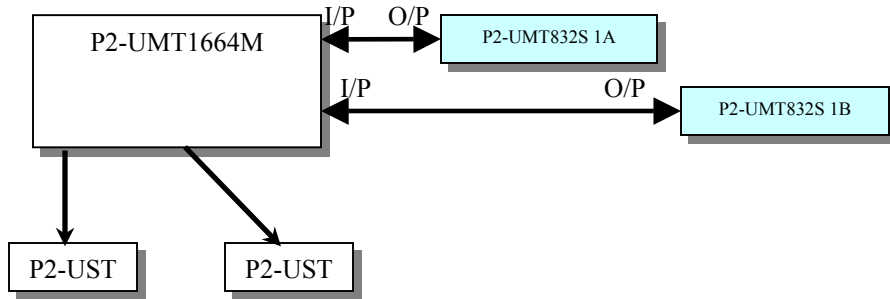

Figure 52 Stacking - Single Base Configuration with P2-UMT1664M and P2-UMT832S

Example H: Illegal Configuration

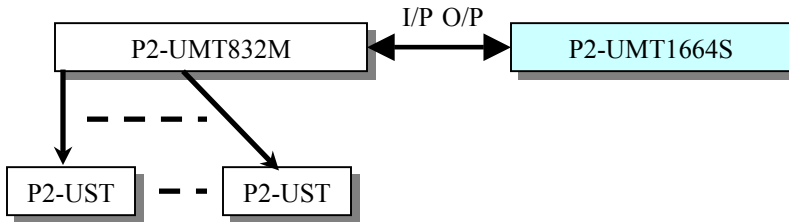

Figure 53 Stacking - Single Base Configuration with P2-UMT832M and P2-UMT1664S

Non-Standard Tier Configuration

Guidelines for Existing Firmware Versions

- Non-Standard tier configurations are those configurations supported by Paragon II, but require special procedures in order to function properly. These include:
 - Triangle Configuration
 - Diamond Configuration
 - Redundant Configuration

- When a Non-Standard tier configuration is detected, Paragon will do the following:
 - Display the message “**Illegal Connect/Check CTxxxxxx**” on the LCD panel, where CTxxxxxx is the serial number of UMT that has the Non-Standard configuration on its user ports
 - Stop normal function and continue displaying the message until the connection is removed and the unit is reset
 - While the UMT is trapped on the message, it will send the broadcasting message to all UST1s every two (2) seconds, “**Illegal connection on CTxxxxxx**”
 - The message will also appear on the OSD until the Non-Standard tier configuration is removed

- Recovery:
 - After any re-connection subsequent to the Non-Standard tier configuration, all UMT Matrix Switches should undergo a **FUNC** reset to clear the switch database. This procedure should be performed starting from the third tier device down to the base unit.
 - Whenever a third tier UMT Matrix Switch is replaced, all of the second tier and base UMT Matrix Switches should undergo a **FUNC** reset.
 - Whenever a second tier UMT Matrix Switch is replaced, all of the base UMT Matrix Switches should undergo a **FUNC** reset.
 - Whenever a base UMT Matrix Switch is replaced, only the new UMT Matrix Switch should undergo a **FUNC** reset.

Triangle Configuration

The following procedure must be followed to ensure this configuration functions properly:

- After re-connection, all UMT Matrix Switches must undergo a **FUNC** reset to clear the switch database. This procedure should be performed starting from the third tier device down to the base unit.
- Execute the **FUNC** reset in the following order: UMT-3A → UMT-2A → UMT-Base 1.

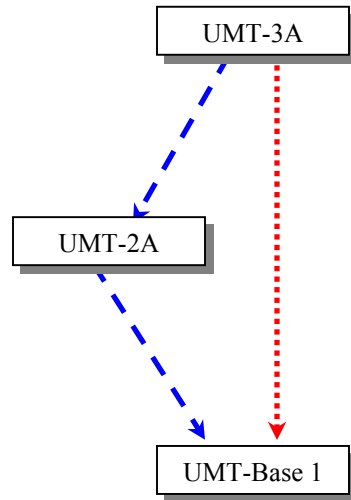

Figure 54 Triangle Configuration

Diamond Configuration

The following procedure must be followed to ensure this configuration functions properly:

- After re-connection, all UMT Matrix Switches should undergo a **FUNC** reset to clear the switch database. This procedure should be performed starting from the third tier device down to the base unit.
- Execute the **FUNC** reset in the following order: UMT-3A → UMT-2A → UMT-2B → UMT-Base 1.

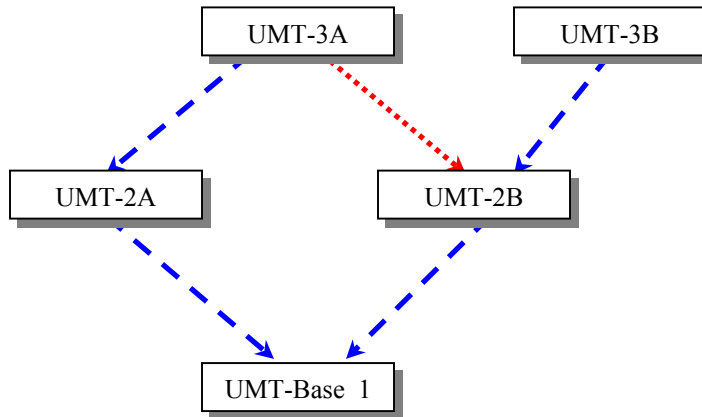

Figure 55 Diamond Configuration

Redundant Configuration

The procedure outlined below must be followed to ensure this configuration functions properly:

- After installation, all UMT Matrix Switches should undergo a **FUNC** reset to clear the switch database. This procedure should be performed starting from the third tier device down to the base unit.
- Execute the **FUNC** reset in the following order: UMT-3A → UMT-3B → UMT-2A → UMT-2B → UMT-Base 1 → UMT-Base 2.
- Whenever a third tier UMT Matrix Switch is replaced, all of the second tier and base UMT Matrix Switches should undergo a **FUNC** reset.
- Whenever a second tier UMT Matrix Switch is replaced, all of the base UMT Matrix Switches should undergo a **FUNC** reset.
- Whenever a base UMT Matrix Switch is replaced, only the new UMT Matrix Switch should undergo a **FUNC** reset.

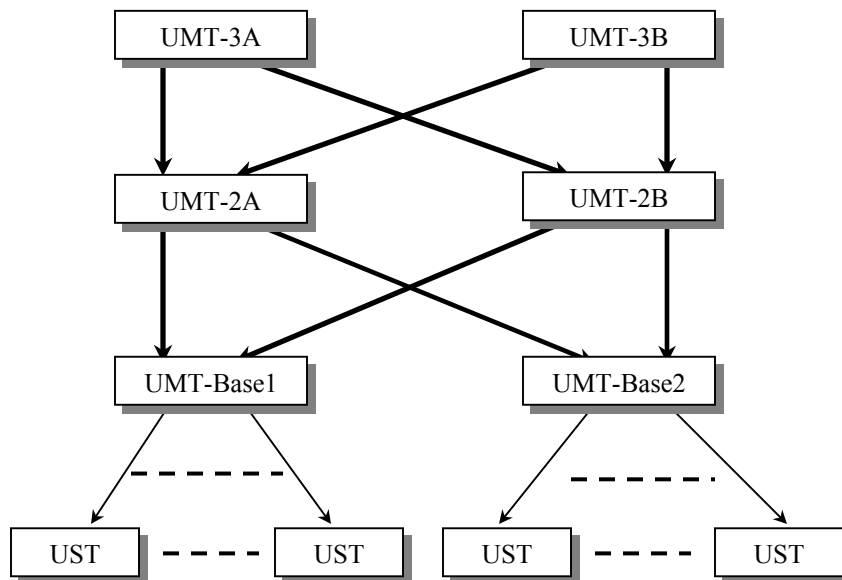

Figure 56 Redundant Configuration

In order to make a redundant configuration system operate more efficient, the following connection scheme between tiers is recommended:

- Assume there are two UMT Base devices, the UMT-Base1 and UMT-Base2
- Assume there are three UMT second tier devices, the UMT-2A, UMT-2B, and UMT-2C
- Channel connection of UMT-Base1
 - Channel ports $3*N+1$ (1, 4, 7....) connect to UMT-2A user ports sequentially, starting from user port 1
 - Channel ports $3*N+2$ (2, 5, 8....) connect to UMT-2B user ports sequentially, starting from user port 1
 - Channel ports $3*N$ (3, 6, 9....) connect to UMT-2C user ports sequentially, starting from user port 1
- Channel connection of UMT-Base2
 - Channel ports $3*N+1$ (1, 4, 7....) connect to UMT-2A user port sequentially, starting from user port 9 if UMT-2A has 16 user ports.
 - Channel ports $3*N+2$ (2, 5, 8....) connect to UMT-2B user port sequentially, starting from user port 9 if UMT-2A has 16 user ports.
 - Channel ports $3*N$ (3, 6, 9....) connect to UMT-2C user port sequentially, starting from user port 9 if UMT-2A has 16 user ports.

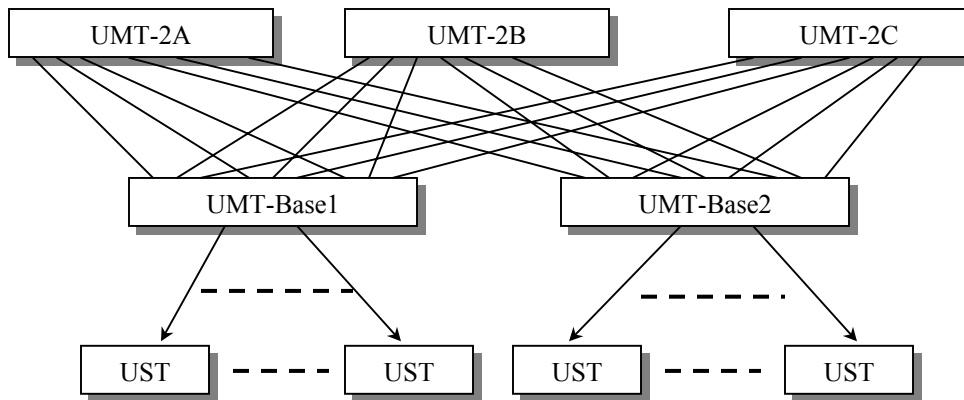

Figure 57 Recommended Redundant Configuration connection scheme

Illegal Configuration

Illegal configurations are those that are not currently supported by Paragon. Please use one of the configurations described in this chapter.

Loop-Back Configuration

This dead-loop setup will cause Server database conflict and should therefore never be used.

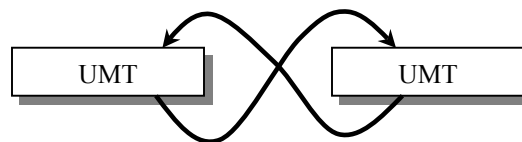

Figure 58 Illegal Loop-Back Configuration

Appendix A: Specifications

PARAGON II UNIT	DESCRIPTION	DIMENSIONS	WEIGHT	POWER
P2-UMT1664M	16 users x 64 server ports, expansion slot, stacking port, network port	11.41" (W) x 17.32" (D) x 1.75" (H) 290mm (W) x 440mm (D) x 44mm (H)	12.52 lbs 5.68 kg	100V/240V 50/60 Hz 0.6A
P2-UMT832M	8 users x 32 server ports, expansion slot, stacking port, network port	11.41" (W) x 17.32" (D) x 1.75" (H) 290mm (W) x 440mm (D) x 44mm (H)	9.83 lbs 4.46 kg	100V/240V 50/60 Hz 0.6A
P2-UMT442	4 users x 42 server ports, expansion slot, network port	11.41" (W) x 17.32" (D) x 1.75" (H) 290mm (W) x 440mm (D) x 44mm (H)	10.13 lbs 4.59 kg	100V/240V 50/60 Hz 0.6A
P2-UMT242	2 users x 42 server ports	11.41" (W) x 17.32" (D) x 1.75" (H) 290mm (W) x 440mm (D) x 44mm (H)	10.03 lbs 4.54 kg	100V/240V 50/60 Hz 0.6A

PARAGON II STACKING UNITS	DESCRIPTION	DIMENSIONS	WEIGHT	POWER
P2-UMT1664S	64 expansion server ports for stacking with P2-UMT1664M	11.41" (W) x 17.32" (D) x 1.75" (H) 90mm (W) x 440mm (D) x 80 (H)	11.99 lbs 5.44 kg	100V/240V 50/60 Hz 0.6A
P2-UMT832S	32 expansion server ports for stacking with P2UMT832M unit	11.41" (W) x 17.32" (D) x 1.75" (H) 290mm (W) x 440mm (D) x 44mm (H)	8.99 lbs 4.08 kg	100V/240V 50/60 Hz 0.6A

PARAGON II USER STATIONS	DESCRIPTION	DIMENSIONS	WEIGHT	POWER
P2-UST	Analog access point with PS/2, USB and Sun console	11.4" (W) x 10.1" (D) x 1.75" (H) 290mm (W) x 255mm (D) x 44mm (H)	4.3 lbs 1.9 kg	100V/240V 50/60 Hz 0.6A

PARAGON CIMS	DESCRIPTION	DIMENSIONS	WEIGHT	POWER
P2CIM-PS2	CIM for PS/2	1.3" (W) x 3.0" (D) x 0.6" (H) 32mm (W) x 77.4mm (D) x 15.6mm (H)	0.20 lb 0.07 kg	n/a
P2CIM-SUN	CIM for SUN	1.3" (W) x 3.0" (D) x 0.6" (H) 32mm (W) x 77.4mm (D) x 15.6mm (H)	0.13 lb 0.06 kg	n/a
P2CIM-USB	CIM for USB	1.3" (W) x 3.0" (D) x 0.6" (H) 32mm (W) x 77.4mm (D) x 15.6mm (H)	0.20 lb 0.07 kg	n/a
P2CIM-SUSB	CIM for SUN USB	1.3" (W) x 3.0" (D) x 0.6" (H) 32mm (W) x 77.4mm (D) x 15.6mm (H)	0.148 lb 0.067 kg	n/a
P2CIM-PWR	CIM for Integrated Power Control	1.3" (W) x 3.0" (D) x 0.6" (H) 32mm (W) x 77.4mm (D) x 15.6mm (H)	0.066 lb 0.03 kg	n/a

CAT5 Cable Guidelines

Use only straight-through-pinned four-pair (eight-wire) Category 5 unshielded twisted pair (UTP) cables, terminated with standard RJ-45 plugs, for the CAT5 cabling links in your Paragon system.

If your existing CAT5 site-wiring system meets these requirements, feel free to send the signals through your site's patch panels, existing wiring, etc., but you should keep the number of patches and splices to a minimum to avoid degrading the video signals. Maximum end-to-end cabling distance from any CPU to any user station should not exceed 1000 ft. (304 m).

Looking into an RJ-45 socket on any Paragon component, or looking at the cable plug from behind with the tab on the bottom, Pin 1 should be on the left and Pin 8 on the right, and the wires should be arranged this way, as per the TIA-568B standard:

Pin	Color	Function, Pair
1	White/Orange	TX, Pair 2
2	Orange/White	RX, Pair 2
3	White/Green	TX, Pair 3
4	Blue/White	RX, Pair 1
5	White/Blue	TX, Pair 1
6	Green/White	RX, Pair 3
7	White/Brown	TX, Pair 4
8	Brown/White	RX, Pair 4

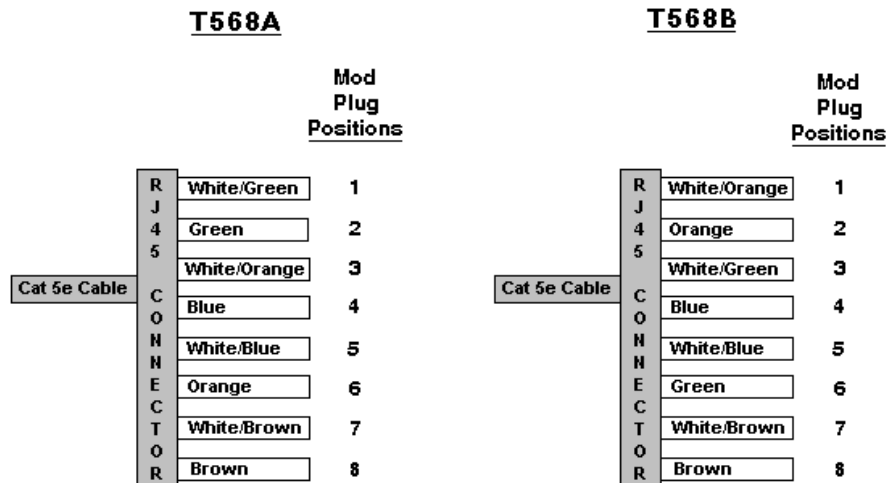

Figure 59 Cat5 Cable Diagram

Appendix B: User Station Direct Mode

A Paragon User Station set to Direct Mode can be directly connected to a Paragon CIM, either temporarily for emergency “crash cart” access or permanently for non-switched extension purposes, without having to go through a Base Unit.

To make this kind of “Direct Mode” connection, take these steps:

1. If you have not already done so, follow the instructions in steps 5a and 5b of **Chapter 2: Installation, Installing a Paragon System with a Single Base Unit** to attach the CIM to the CPU.
2. If you have not already done so, plug in and turn on the CPU.
3. Power off the User Station.
4. Run CAT5 cabling directly between the User Station and the CIM.
5. At the user station attached to the User Station, simultaneously press and hold the **[Ctrl]** and **[Alt]** keys.
6. Continue holding down these keys while you power on the User Station. The User Station should beep twice; after the second beep, it should display a “DIRECT Mode: CIM connected” message on the monitor.
7. Release **[Ctrl]** and **[Alt]**. The “DIRECT Mode” message will continue to be displayed for ten seconds, then disappear.

While the User Station is in Direct Mode, if the CAT5 cabling between the User Station and the P2CIM-PS2 becomes disconnected at any point for more than three to four seconds, the User Station will exit Direct Mode. To re-establish Direct Mode, repeat the above steps.

To return a User Station that’s in Direct Mode to normal operation, take these steps:

1. Power OFF the User Station.
2. Disconnect the opposite end of the CAT5 cabling from the CIM.
3. Connect the opposite end of the CAT5 cabling to a user port of a Base Unit.
4. Run other CAT5 cabling from the channel port of a Base Unit to the CIM.
5. Power ON the User Station.

Appendix C: Configuration and Compatibility

Configuration Matrix

		Base/Lower Tiers					
		Paragon II UMT1664/832/4 42/242	UMT1664S/832S	UMTx HW3 w/3.2 FW	UMTx HW3 w/Current FW	UMTx HW2	UMTx HW1
Upper Tiers	Paragon II UMT1664 /832 /442 /242	X	X				
	UMT1664S/832S	Stack	Stack	Stack			
	UMTx HW3 w/3.2 FW	X	X	X			
	UMTx HW3 w/Current FW	X	X	X	X		
	UMTx HW2	X	X	X	X	X	
	UMTx HW1	X	X	X	X	X	X
	Other Current Paragon Ready Devices	X	X	X	X	X	X

As a general rule, the very latest hardware and firmware should reside on the lowest tier

Compatibility Matrix

Feature/Component	Paragon I			Paragon II
	HW1	HW2/2Z	HW3	HW3M
P2CIMs	Yes	Yes	Yes	Yes
C, P, PD CIMs	Yes	Yes	Yes	Yes
Z-CIMs	No	Yes	Yes	Yes
P2-UST	No	No	Yes, with 3.2 FW	Yes
UST1	Yes	Yes	Yes	Yes
Stacking ready	No	No	Yes, with 3.2 FW	Yes
Paragon Manager	No	No	Yes - via admin, 3.2	Yes - via LAN
Network FW upgrade	No	No	No	Yes
Integrated Power Control	No	No	Yes, with 3.2 FW	Yes
Max Targets - 1664	N/A	N/A	2,048	10,000
Max Targets - 832	750	2,048	2,048	10,000
Max Targets - 442	N/A	2,048	2,048	10,000
Max Targets - 242	N/A	2,048	2,048	2,048
Max Targets - 2161	N/A	2,048	2,048	N/A
Max User Names	60	127	127	512

Note: Only one Stacking Unit can be connected per Paragon HW3 switch

Appendix D: Paragon II Rack Mount

Paragon II User Stations and most Base Units can be mounted in 1U (1.75", 4.4 cm) of vertical space in a standard 19" equipment rack; P2-UMT1664M Base Units can be mounted in 2U (3.5", 8.9 cm) of space. To rackmount a Base Unit, use the brackets and screws that came with the unit; to rackmount a User Station, use the RMKSMU rackmount kit. (If you lose or damage a Base Unit's brackets, replace them with the RMKSM1 kit [for any 1U Base Unit] or RMKSM2 [for a P2-UMT1664M].) You can mount a Base Unit or User Station facing the front of the rack or facing the rear.

Forward Mount

1. Secure the cable-support bar to the back end of the side brackets using two of the included screws.
2. Slide the User Station or Base Unit between the side brackets, with its rear panel facing the cable-support bar, until its front panel is flush with the "ears" of the side brackets.
3. Secure the User Station or Base Unit to the side brackets using the remaining included screws (three on each side).
4. Mount the entire assembly in your rack and secure the side brackets' ears to the rack's front rails with your own screws, bolts, cage nuts, etc.
5. When you attach cables to the connectors on the rear panel of the User Station or Base Unit, drape them over the cable-support bar.

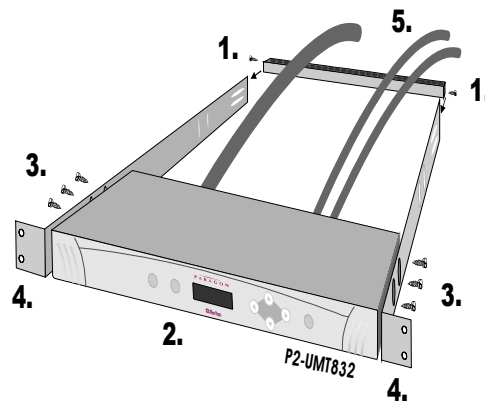

Figure 60 Front rackmount of a P2 Base Unit

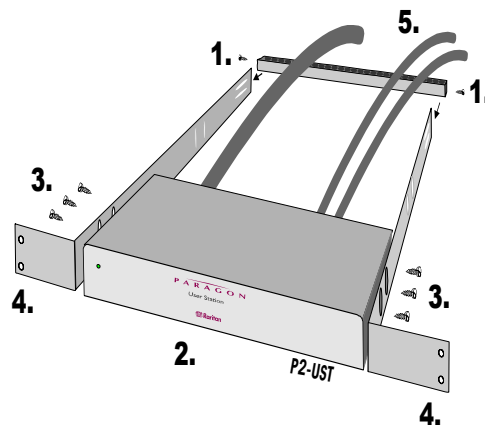

Figure 61 Front rackmount of a P2 User Station

Rear Mount

1. Secure the cable-support bar to the front end of the side brackets, near the side brackets' "ears," using two of the included screws.
2. Slide the User Station or Base Unit between the side brackets, with its rear panel facing the cable-support bar, until its front panel is flush with the back edges of the side brackets.
3. Secure the User Station or Base Unit to the side brackets using the remaining included screws (three on each side).
4. Mount the entire assembly in your rack and secure the side brackets' ears to the rack's front rails with your own screws, bolts, cage nuts, etc.
5. When you attach cables to the connectors on the rear panel of the User Station or Base Unit, drape them over the cable-support bar.

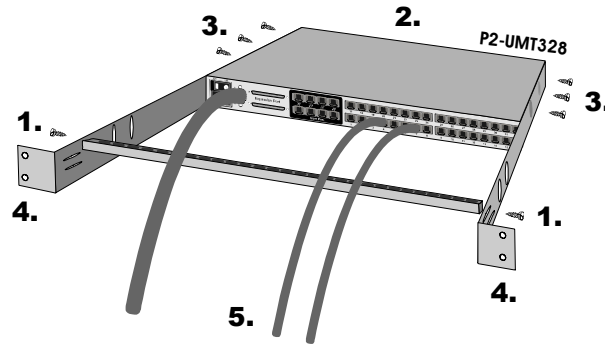

Figure 62 Rear rackmount of a P2 Base Unit

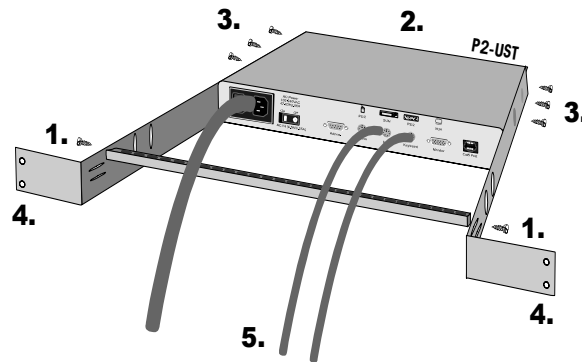

Figure 63 Rear rackmount of a P2 User Station

Appendix E: Using AUATC for RS-232 Access

Introduction to the AUATC

To use your Paragon II system to access a CPU or other device through an RS-232 port, attach one of our RS-232 serial CIMs (product code AUATC) to the device's serial port as described in the first section of this Appendix. The AUATC is designed to emulate an ASCII terminal, converting keyboard input to RS-232 data input and converting RS-232 data output for display on a VGA monitor. This conversion allows any device that can be accessed by an ASCII terminal to be operated with a user station attached to your Paragon system, across an end-to-end distance of up to 1000 ft. (305 m) as opposed to the normal RS-232 maximum of 50 ft. (15 m).

Here are some of the AUATC's useful features:

- It maintains eight pages of data in a circular buffer.
- In its Buffer Edit Mode, you can edit data, copy it, mark it, and/or resend it to the server or other device.
- In its On-Line Mode, you can operate the ASCII device as if it were attached to a text terminal.
- It has twelve programmable keys for frequently performed character-string commands.
- You can directly attach a local PS/2 or Sun user station (keyboard and monitor) if necessary.

Installing the AUATC

Take these steps to attach an AUATC to the serial port of a server CPU or other device and to your Paragon system:

1. Run an appropriate cable from the AUATC's DB25 female DTE connector to the device's serial port. The type of cable will depend on what type of connector the port is and whether it's pinned as DTE (for a data source/destination such as a CPU) or DCE (for a data-communicating device such as a modem). Here are the product codes of some cables we recommend if the port is:
 - a. DB9 male DTE (most PCs, some routers, etc.)
 - b. DB25 male DTE (some older PCs, routers, etc.)
 - c. DB25 female DCE (many external modems, etc.)If the device has some other type of serial port, call Raritan Technical Support.
2. If you need temporary "crash cart" access or permanent local control, you can attach a local user station (consisting of a keyboard and VGA monitor only) to the AUATC. The user station's keyboard can be either be PS/2 or Sun type; a Sun keyboard will require a special setting in the Setup Screen. To install a local user station, plug a PS/2 keyboard into the AUATC's 6-pin mini-DIN connector, or a Sun keyboard into its 8-pin mini-DIN connector. Plug a VGA monitor into the AUATC's HD15 connector.

Note: This local station will contend for keyboard control with the remote user stations attached to Paragon User Stations based on a fixed one-second activity timeout. As soon as there has been no keyboard activity from the local station for one second, a remote station can take keyboard control, and vice versa.

3. Plug in and turn on the device. If possible, set it to communicate at 9600 bps, 8 data bits, no parity, and 1 stop bit. (These don't have to be the permanent serial settings, but the device must be set this way to establish initial communication with the AUATC; later you can configure both the device and the AUATC to better settings. If the device can't be configured for these settings, you'll need to temporarily attach a CPU or other device that can be.)
4. Plug the AUATC's power supply into the AUATC and a working AC outlet. If the AUATC is installed and operating properly, the AUATC's green LED will start blinking: once per second while the CIM is idle, more quickly while it's passing data in either direction.
5. Connect one end of a CAT5 UTP cable to the RJ-45 port on the AUATC. Connect the other end of the cable to RJ-45 channel port #1 on the back of one of your Paragon Base Units, or to the RJ-45 port on the back of a User Station if you want Direct Mode access (see **Appendix B: User Station Direct Mode** for additional information).

If the CIM is installed properly and the attached device or port is configured correctly, you are ready to start using the P2CIM-PS2 for your serial communication.

Operating the AUATC

Screen Layout

The AUATC produces eight-color video at 800 x 600 resolution, which can accommodate 32 lines of 80 text characters each. A typical ASCII terminal uses 24 lines, so the AUATC uses the eight extra lines to provide system-status and help information. These eight lines are divided so that four are at the top of the screen and four are at the bottom.

```

1 2 3 4 5 6 7 8
1234567890123456789012345678901234567890123456789012345678901234567890
1  Raritan Computer, Inc. ©Copyright 1999          V1.05
2  ASCII Terminal Converter, Model: AUATC
3  Line 03 Position 10 Page 8                        VT100  9600 Baud
4  _____ Status: On Line _____ LOC _____
5
6  %
7  Login: Huinin
8  Password:
9
10
11
12
13
14
15
16
17
18
19
20
21
22
23
24
25
26
27
28
29
30
31
32
<Alt-F1> = Display Help Menu Screen  <Alt-F2> = Setup serial Communication
<Alt-F3> = Set Up Programmable Keys  <Alt-F4> = Review/Edit Buffer
<Ctrl-Break> = Reset Serial Communication and AUATC
<Ctrl-S>/<Ctrl-Q> = Stop/Resume output from Computer

```

Figure 64 AUATC screen layout (On-Line Mode)

- In line 1 of the top pane, the AUATC's firmware version is displayed at the right.
- In line 3 of the top pane, the cursor position and buffer-page number are displayed at the left and the terminal type and data rate are displayed at the right.
- In line 4 of the top pane, the communication status is displayed. This status can be:
 - **On Line:** The AUATC is communicating with the server and displaying the interactions in its terminal-screen area
 - **Help:** If you press [Alt] + [F1], the Help screen will appear
 - **Set Up:** If you press [Alt] + [F2] or [Alt] + [F3], the AUATC enters Setup Mode
 - **Buffer Edit:** If you press [Alt] + [F4], the AUATC enters Buffer Edit Mode
- In addition, the access type is shown at the right of line 4 of the top pane. The access type can be **LOC** (the local keyboard/monitor user station is active), **RMT** (a remote Paragon user station is active), or **NO** (there is no current user-station activity – the AUATC is idle and will grant keyboard and mouse control to the first user station that attempts to assert it).
- The four lines in the bottom pane display command keys specific to the current screen.

On-Line Mode

When you operate the AUATC in On-Line Mode, the main screen area displays your interactions with the ASCII device, as if it were the screen of an ASCII terminal. Simultaneously, the data stream being output by the device is stored in an eight-page circular buffer, so you can not only access and operate the device, but you can also review its historical data as needed. Because the buffer is circular, it always retains the most recent eight pages of data from the device; the newest data will overwrite the oldest data.

Conveniently, you may program any of the PC keyboard's twelve function keys to trigger your most-often-used data-stream commands. Pressing any key set this way causes Paragon II to send the corresponding command to the device. During the online session, you can also send any of the following key combinations (press and hold [Ctrl] or [Alt], press and release the command key, and release [Ctrl] or [Alt]) to control your communication with the device or to access the AUATC's help and setup screens:

- [Ctrl] + [Break] (the [Pause/Break] key next to the [Scroll Lock] key): Resets both the AUATC and the serial communication with the device.
- [Ctrl] + [S] (not case-sensitive): Sends an X-OFF command to the device to temporarily stop it from sending any data; until the flow is allowed to resume, all output data will be queued by the device. (If the device doesn't support X-ON/X-OFF flow control, this command has no effect.)
- [Ctrl] + [Q] (not case-sensitive): Sends an X-ON command to allow the device to resume sending data after being halted by the [Ctrl] + [S] command.
- [Alt] + [F1]: Displays the Help screen.
- [Alt] + [F2]: Displays the Setup screen.
- [Alt] + [F3]: Displays the Set Up Programmable Keys screen.
- [Alt] + [F4]: Switch to Buffer Edit Mode.

Help Mode

```

1234567890123456789012345678901234567890123456789012345678901234567890
1  Raritan Computer, Inc. ©Copyright 1999 V1.05
2  ASCII Terminal Converter, Model: AUATC
3  Line 03 Position 10 Page 8 VT100 9600 Baud
4  Status: Help LOC
5
6  ASCII Terminal Converter
7  Help Screen
8
9  On Line Commands
10 <Ctrl-Break> = Reset Serial Communication and AUATC
11 <Ctrl-S>/<Ctrl-Q> = Stop/Resume output from Computer
12
13 Set Up commands
14 <Alt-F1> = Display Help Menu
15 <Alt-F2> = Setup Screen
16 <Alt-F3> = Set up Programmable keys
17 <Alt-F4> = Review/Edit Buffer
18 <Esc> = Exit
19
20 Buffer edit
21 <Home>/<End> = Go To First Page/Last page
22 <PageDown>/<PageUp> = Go To Next Page/Previous Page
23 <↑>/<↓>/<←>/<→> = Move Cursor
24 <Insert> = Toggle insert mode
25 <Delete>/<Del> = Erase a character in position
26 <Back Space> = Erase a character on the left
27 <F6> = Begin Mark
28 <F7> = Send "Marked" buffer to computer, and return On Line
29 <F10> = Clear Buffers, and return on line
30 <Esc> = Exit, return to On Line
31
32 <Alt-F1> = Display Help Menu Screen <Alt-F2> = Setup Screen
33 <Alt-F3> = Set Up Programmable Keys <Alt-F4> = Review/Edit Buffer
34
35 <Ctrl-Break> = Reset Serial Communication and AUATC
36

```

Figure 65 Help screen

Buffer Edit Mode

The AUATC stores the most recent eight pages of data from the attached ASCII device in a circular buffer. After you switch the AUATC from On-Line Mode to Buffer Edit Mode by pressing [Alt] + [F4], you can review the contents of the buffer by moving the cursor with the arrow keys, [PageUp], [PageDown], [Home], and [End]. You can also edit the data in the buffer with [Insert], [Delete], [Backspace], and the other keys listed in the Help screen.

```

1234567890123456789012345678901234567890123456789012345678901234567890
1  Raritan Computer, Inc. ©Copyright 1999 V1.05
2  ASCII Terminal Converter, Model: AUATC
3  Line 03 Position 10 Page 8 VT100 9600 Baud
4  Status: Buffer Edit LOC
5
6  $ls -l
7  total 25
8  -rwxrwxrwx 1 0 0 189024 Oct 25 1993 tklaunch.exe
9  -rwxrwxrwx 1 0 0 14598 Sep 22 1993 touch.exe
10 -rwxrwxrwx 1 0 0 14078 Sep 22 1993 tr.exe
11 -rwxrwxrwx 1 0 0 10722 Sep 22 1993 tsort.exe
12 -rwxrwxrwx 1 0 0 7420 Sep 22 1993 tty.exe
13 -rwxrwxrwx 1 0 0 9228 Sep 22 1993 uname.exe
14 -rwxrwxrwx 1 0 0 29074 Sep 28 1993 uncompress.exe
15 -rwxrwxrwx 1 0 0 11238 Sep 22 1993 unexpand.exe
16 -rwxrwxrwx 1 0 0 11318 Sep 22 1993 uniq.exe
17 -rwxrwxrwx 1 0 0 13288 Sep 22 1993 unpack.exe
18 -rwxrwxrwx 1 0 0 11518 Sep 22 1993 unstrip.exe
19 -rwxrwxrwx 1 0 0 12670 Sep 22 1993 uudecode.exe
20 -rwxrwxrwx 1 0 0 10342 Sep 22 1993 uuencode.exe
21 -rwxrwxrwx 1 0 0 188928 Oct 21 1993 vdiff.exe
22 -rwxrwxrwx 1 0 0 76358 Oct 7 1993 vi.exe
23 -rwxrwxrwx 1 0 0 240752 Oct 22 1993 viw.exe
24 -rwxrwxrwx 1 0 0 493971 Oct 22 1993 viw.hlp
25 -rwxrwxrwx 1 0 0 766 Sep 27 1993 viwdoc.ico
26 -rwxrwxrwx 1 0 0 5632 Aug 19 1993 viwf.fon
27 -rwxrwxrwx 1 0 0 10598 Sep 22 1993 wc.exe
28 -rwxrwxrwx 1 0 0 9758 Sep 22 1993 which.exe
29
30 <Home>/<End> = First/Last page <PageDown>/<PageUp> = Next/Previous Page
1 <↑><↓><←><→> = Move Cursor <Insert> = Toggle insert mode
2 <Delete> = Erase a character <Back Space> = Erase a character on the left
<F6>/<F7> = Mark Begin/End <F8> = Send <F10> = Clear Buffer <Esc> = Exit

```

Figure 66 Buffer Edit Mode screen

Configuring the AUATC

Press [Alt] + [F2] to activate the Setup Screen, where you can select your desired serial-communication parameters (baud rate, etc.) and type of local video output. The initial parameters will always start at their factory defaults, so make sure that the serial port or device to which the AUATC is attached is temporarily configured for 9600 bps, 8 data bits, no parity, and 1 stop bit. (If the port or device cannot support all of these settings, you must temporarily attach one that can.) Also, if you want to perform initial configuration with a local user station, it must consist of a PS/2 keyboard and VGA monitor.

Available data-rate (“Baud Rate”) settings are 2400, 4800, 9600, and 19,200 bps. You can select even, odd, or no (“None”) parity; 7 or 8 data bits; and 1 or 2 stop bits (but 7 data bits requires 2 stop bits). The terminal type is fixed at VT100.

To force local VGA output even when your local keyboard is a Sun type, access the AUATC from a user station with a PS/2 keyboard and a VGA monitor. Activate the Setup Screen and change the video option from **Sun keyboard** to **VGA**. You can then access the AUATC from Sun type user stations.

```

1234567890123456789012345678901234567890123456789012345678901234567890
1
2
3
4
5
6
7
8
9
10
11
12
13
14
15
16
17
18
19
20
21
22
23
24
25
26
27
28
29
30
31
32

```

```

Raritan Computer, Inc. Copyright 1999 V1.05
ASCII Terminal Converter, Model: AUATC
Line 03 Position 10 Page 8 VT100 9600 Baud
Status: Set Up LOC

ASCII Terminal Converter
Setup Screen

Baud Rate : 9600
Parity : None
Data Bit : 8
Stop Bit : 1

Terminal Type : VT100

Video Output:
PS/2 Keyboard: VGA Only
Sun Keyboard: Sun Composite

Set up: Default

Use <Tab>/<Shift-Tab> to go to a field to edit
Use <↑> or <↓> to change parameter in a field
<Esc> return to On Line

<Alt-F1> = Display Help Menu Screen <Alt-F2> = Setup Screen
<Alt-F3> = Set Up Programmable Keys <Alt-F4> = Review/Edit Buffer
<Ctrl-Break> = Reset Serial Communication and AUATC

```

Figure 67 Setup Communication Screen

To program any of your keyboard's twelve function keys with commands or data items you frequently have to send the device, activate the Set Up Programmable Keys screen by pressing [Alt] + [F3]. Once a string (with a maximum length of sixteen characters) has been assigned to a key, pressing that key while in On-Line Mode will send the entire string to the device.

```

1234567890123456789012345678901234567890123456789012345678901234567890
1          2          3          4          5          6          7          8
2          Raritan Computer, Inc. ©Copyright 1999          V1.05
3          ASCII Terminal Converter, Model: AUATC
4          Line 03 Position 10 Page 8          VT100 9600 Baud
5          Status: Set Up          LOC
6
7          ASCII Terminal Converter
8          Set Up Programmable Keys
9
10         F1          = ^D
11         F2          = <default>
12         F3          = ^U
13         F4          = <default>
14         F5          = <default>
15         F6          = <default>
16         F7          = <default>
17         F8          = <default>
18         F9          = <default>
19         F10         = <default>
20         F11         = <default>
21         F12         = This is my name.
22
23         <Tab>/<Shift><Tab> to a field to edit; max. of 16 characters
24         Use <Ctrl-V> to enter special character; e.g., <Ctrl-V>+<Esc>,
25         <CTRL-V>+<CTRL-C>, <CTRL-V>+<CTRL-M> or <CTRL-V>+<Enter> for CR key
26         <F11>/<F12> = Load/Save programmable key
27         <Esc> return to On Line
28
29         <Alt-F1> = Display Help Menu Screen  <Alt-F2> = Setup serial Communication
30         <Alt-F3> = Set Up Programmable Keys  <Alt-F4> = Review/Edit Buffer
31         <Ctrl-Break> = Reset Serial Communication and AUATC
32

```

Figure 68 Set Up Programmable Keys screen

Troubleshooting the AUATC

If you do not get a device prompt:

1. If the AUATC's screen is displayed on your monitor with the top and bottom help windows, make sure that it indicates **On Line** status. If not, press **[Esc]** to return to On-Line Mode.
2. Make sure that the AUATC and the attached device are both receiving power. The AUATC's power supply should be securely connected to both the AUATC and a working outlet. Its LED (next to the 6-pin mini-DIN PS/2 mouse connector) should flicker quickly if data is being transmitted and blink once per second at other times.
3. Make sure that the cable between the AUATC and the device is securely attached at both ends. This must be the null-modem cable included with the AUATC or one just like it.
4. Make sure that the serial-communication settings of the AUATC match those of the device. Press **[Alt] + [F2]** to check the AUATC's settings in its Setup Screen.

If you do not get any video or the video is degraded or distorted:

1. Make sure that all of your cables are connected securely.
2. Make sure that your monitor can handle 800 x 600 video resolution at a refresh rate of 60 Hz.
3. If you are at a remote user station's monitor, make sure that you are not running CAT5 cable too far end-to-end. The total length of CAT5 cabling from the serial device to the monitor should not be greater than 1000 ft. (304 m).
4. If you are using a Sun keyboard at the local user station, the AUATC will, by default, try to output legacy Sun compatible composite video on its HD15 connector. You must temporarily attach a PS/2 keyboard, press **[Alt] + [F2]** to activate the Setup Screen, and change the video setting so that the AUATC outputs VGA video even when a Sun keyboard is attached.

Appendix F: Emulating Sun Keys with a PS/2 Keyboard

We recommend that you use a Sun keyboard and mouse at your user stations if there are any Sun CPUs in your Paragon system. If you must use a PS/2 keyboard to control a Sun CPU attached to your Paragon system, the Paragon is able to perform some keyboard emulation. To emulate most of the special “extra” keys that are present on Sun keyboards but not PS/2 keyboards, first press and hold either **[Scroll Lock]** or the combination of **[Ctrl]** and **[Alt]**; these function as permanent “Sun keystroke hotkeys.” (If **[Scroll Lock]** is your OSUI hotkey or previous-channel key you will want to use **[Ctrl] + [Alt]**.) Then press the corresponding character on the PS/2 keyboard:

WHILE PRESSING A CHARACTER HOTKEY, PRESS THIS PS/2 KEYBOARD KEY...	...TO GENERATE THIS SUN KEYBOARD KEYSTROKE:
[F2]	[Again]
[F3]	[Props]
[F4]	[Undo]
[F5]	[Front]
[F6]	[Copy]
[F7]	[Open]
[F8]	[Paste]
[F9]	[Find]
[F10]	[Cut]
[F11]	[Help]
[F12]	[Mute]
[*] on the keypad	[Compose]
[+] on the keypad	[Vol +]
[-] on the keypad	[Vol -]

The one exception to this procedure is the Sun keyboard’s **[Stop]** character. To generate **[Stop]** with a PS/2 keyboard, hold down the **[Pause/Break]** key and press the letter **[A]**.

Appendix G: Troubleshooting

SYMPTOM:	PROBABLE CAUSE:
No Power.	Loose Power Cord. Power switch is off. Paragon II Matrix Switch or User Station (P2-UST) surge protection invoked during a power recycling process. Power off unit, wait 20 seconds, then power unit on.
All computers have no video display.	Loose Category 5e UTP cable. Loose monitor connection P2-UST is connected and functioning properly if [Num Lock] key lights keyboard's Num Lock LED.
Monitor video display for some connected computers is distorted.	Monitor type does not match video output designation from computer.
Keyboard non-functional, even though there is no keyboard error at power up. Cannot input to any computer.	Loose keyboard connection to P2-UST1. Loose Category 5e UTP cable. Keyboard broken. Hot-swap with a new keyboard.
Repeated "Keyboard ERROR" at computer power-up.	Loose cable from computer to CIM. Loose Category 5e UTP cable. Paragon II components may be out of order. Verify that computer works with a keyboard directly connected. Contact Raritan Technical support for assistance.
Keyboard suddenly locks-up when a particular computer is selected, but works normally when other computers are selected.	Loose keyboard cable connection. Voltage spike (increase) or brown out (decrease) in power supply to connected Paragon II Matrix Switch unit. Power down Switch, wait 20 seconds, then power on unit. Powering Switch from a UPS avoids variation in power supply to Switch.
Repeated "MOUSE INSTALLATION FAILURE" at computer power-up.	Loose mouse cable from computer to CIM Loose Category 5e UTP cable If error occurs only with new computers being added to system, contact Raritan Technical Support for assistance – mouse emulation firmware may need to be upgraded for compatibility with newer computers.
Mouse suddenly locks up when a particular computer is selected, but works normally when other computers are selected.	Loose cable from computer to CIM. Loose Category 5e UTP cable. Paragon II components may be out of order. Verify that computer works with a mouse directly connected. Contact Raritan Technical support for assistance.
On-Screen User Interface (OSUI) non-functional.	Replace keyboard. OSUI works only with PS/2 or extended AT-style keyboards.
Video is "fuzzy" or out of focus.	Video Gain Adjustment is required (especially needed with LCD flat panel monitors). Activate OSUI (by hitting [Scroll Lock] key twice rapidly). Use numeric keypad [+] and [-] keys to adjust video image until in focus.

Multi-Tier Installation

In a multi-tier configuration, the order of powering ON is critical to proper function.

- Last tier switches must be powered ON before the intermediate level of tier
- Intermediate tier switches must be powered ON before the base Paragon II unit can be powered ON.
- User Stations (UST1s) can be powered ON and OFF at any time as needed.
- There is a five-second ON/OFF down time in the UST1 or Paragon II power cycle.

Appendix H: FAQ

SUBJECT:	QUESTION:	ANSWER:
What's Different between Paragon and Paragon II	What is the primary difference between Paragon and Paragon II?	Paragon II is the next generation of KVM switch. While it builds upon the original Paragon technology, it adds advanced features including stacking, integrated power management, network firmware upgrade capability and optional IP-access.
Backward Compatibility	Will Paragon II work with my current Paragon installation?	Yes. The new Paragon switch is backwards compatible with older Paragon components. Please consult the Paragon II manual for configuration and compatibility guidelines.
Stacking	Paragon II is a stackable switch. Does this mean that I can stack logical units to increase the number of ports available?	Yes. Paragon II provides a stacking capability that eliminates the need to run cable between logical 'tiers' and instead uses only a single stacking cable.
	I would like to eliminate all the cables between cascaded Paragon units. Can I do this?	Yes, with Paragon II you get exclusive stacking capability that allows you to increase port density to 128 ports per switch.
	Is the stacking cable that connects base and expansion units together common to all Paragon II switches?	Yes, the stacking cable is common to all Paragon II switches.
	What is the maximum length of the stacking cable?	The maximum length of the stacking cable is 1'.
	Will stacking use up my ports like cascading does?	No, you can stack Paragon II units with just a single cable! 100% non-blocked access without sacrificing server or user ports.
	How many Paragon II switches can be stacked?	You can stack 4 P2-UMT832 switches (1 P2-UMT832M + 3 P2-UMT832S) and 2 P2-UMT1664 switches (1 P2-UMT1664M + 1 P2-UMT1664S).
	Can you stack second and third tier units?	Yes. Please consult the Paragon II manual for configuration and compatibility guidelines.
Administrative Capability	Is there an easier way to upgrade the firmware without having to plug in a serial cable for each Paragon component?	Yes, Paragon Manager allows you to 'push' the firmware to any device connected to Paragon II.
	Paragon II has event logging capabilities. Is there a way I can save this to an offline file for future auditing purposes?	Yes, Paragon Manager will allow you to save and store all system events to an appropriate text file.

SUBJECT:	QUESTION:	ANSWER:
	Can I restore my saved Paragon Overview files on Paragon II?	Yes, Paragon Manager can read Paragon Overview files and restore this information into a Paragon II switch.
	Does each unit have a network port for firmware upgrades or just the base?	All Paragon II switches have a network port for firmware upgrades. Each unit can be assigned an IP Address and is recognized by the Paragon Manager software via the network.
Integrated Power Management	What is "Integrated Power Management"?	Integrated Power Management is a single, consolidated view (and control of) Raritan Remote Power Control Units connected to Paragon II.
	So I can access and control all my connected Power Units via the Paragon II OSD?	Yes! Paragon II lets you control power to any connected device, set security permissions on a per-outlet basis, recycle power to multi-power supply servers, and get status information from each connected strip.
Connecting Serial Devices	I have a serially controlled device (i.e. Unix server, hub). Can I use Paragon II to access and control this device?	Yes. Raritan's ASCII Terminal Converter (AUATC) adapter will convert the RS-232 connection to PS/2 and VGA video. Connect the AUATC to your serially controlled device, then connect to your Paragon II switch with UTP Cable for access up to 1000 feet.
Connecting Macs and SUN	I have Suns and/or Macs in addition to PCs. Can I access and control them all with Paragon II?	Yes. The Paragon II User Station has built-in ports for PS/2, Sun, or USB keyboards and mice. Use Raritan's SUN or Mac adapters to convert keyboard and video ports to PS/2 keyboard/mouse and VGA video.
	I have a Digital Alpha running UNIX and another running OpenVMS that use a special LK111 or LK461 keyboard. How will that affect operation with my switch?	The Alphas will operate flawlessly. Raritan's emulation incorporates unique functions to support LK111 or LK461 keyboard running UNIX and OpenVMS.
	I have a Digital Alpha running UNIX and want to use a standard PS/2 keyboard. How will that affect operation with my switch?	Merely connect a Raritan converter (AUKME) to any Alpha running UNIX and all computers will operate flawlessly with a standard PS/2 keyboard.

SUBJECT:	QUESTION:	ANSWER:
Cabling	What UTP cable does Raritan recommend for use with Paragon II?	Paragon II will work with any Cat5, Cat5e, Cat6, or Cat 7 cable. Paragon II uses a very sophisticated circuit to automatically adjust signal to ensure the highest quality video and enhance the user experience. Further, Paragon II has a manual adjustment for finer granularity in video adjustment that no other KVM manufacturer offers.
	Can I use standard Ethernet (10BASE-T) cable?	No. Standard Ethernet cable does not have the necessary bandwidth characteristics for transmitting high-quality video over long distances.
Hot-key Functions	Hot-key Functions - I don't want to use the "scroll lock" to activate hot-key. What are my options?	The hot-key activator can be easily changed to a variety of different keys. When in hot-key mode, touch the desired new hot-key activator followed by the enter key.
Hot-plugging	We have some mission critical servers and there are occasions when we may wish to disconnect a server from the Raritan switch and "hot-plug" a physical keyboard and mouse to operate the server. Is that possible?	Yes. Paragon II CIMs have "keep alive" technology which allow you to disconnect the switch without losing keyboard and mouse functionality. Simply remove the UTP cable from the Paragon II switch and connect directly to the User Station for "crash cart" access.
Trackball keyboard	Can I use a trackball keyboard?	You can plug any PS/2 keyboard in the keyboard user port of a Raritan KVM switch.
Connecting USB Devices	My computer has USB connectors. Can I connect it to a Raritan KVM switch?	Yes, with the Paragon II User Station, you can connect a USB keyboard or mouse. Paragon II also has CIMs that connect to USB servers (P2CIM-USB, P2CIM-SUSB).

255-30-6000

Free Manuals Download Website

<http://myh66.com>

<http://usermanuals.us>

<http://www.somanuals.com>

<http://www.4manuals.cc>

<http://www.manual-lib.com>

<http://www.404manual.com>

<http://www.luxmanual.com>

<http://aubethermostatmanual.com>

Golf course search by state

<http://golfingnear.com>

Email search by domain

<http://emailbydomain.com>

Auto manuals search

<http://auto.somanuals.com>

TV manuals search

<http://tv.somanuals.com>