



PC Card Adapter
CBS52U

User's Manual

Dec. 2002

Rev.1.0

 **RATOC Systems, Inc.**

CBS52U

1. Introduction	3
1-1. Package Content	3
1-2. System Requirements	3
1-3. Restrictions	3
2. Installation	4
2-1. Installing on Windows XP	4
2-2. Confirmation of the driver installation	5
2-3. Installing on Windows Me/2000/98SE.....	6
(1)Running [Setup.exe] at the CD-ROM	7
(2)Installing the CBS52 into an available PCI slot	8
(3)Installing the driver	8
(3-1)Windows Me	9
(3-2)Windows 2000	9
(3-3)Windows 98SE	9
(4)Driver Confirmation	10
(4-1)Driver Confirmation for Windows Me/98SE	10
(4-2)Driver Confirmation for Windows 2000	11
3. Troubleshooting	13
4. Registration and Tech-support	15
4-1. How to Register	15
4-2. Software Update and Support	15
Appendix	16



1. Introduction

This User's Guide describes how to install the RATOCS CBS52U PC Card Adapter (called CBS52U in this User's Guide).

The information in the README.TXT file on the CD-ROM may include the latest information.

Be sure to read the file as well. Refer to our web site for the information on Linux.

(<http://www.ratocsystems.com/english/>)

1-1. Package Content

Check the package contents:

- REX-CBS52 PCI Board
- CD-ROM
- User's manual

NOTE

If any of these items are missing from the CBS52U retail package, contact your supplier immediately.

1-2. System Requirements

- PC with an available PCI slot
- Windows XP/Windows Me/Windows 2000/Windows 98SE

1-3. Restrictions

1. There may be some PC Cards which don't run with the CBS52. Refer to our web site for our latest information(<http://www.ratocsystems.com/english/>).
2. You need to prepare the followings before you install the CBS52.
 - 1) You need to finish updating the latest BIOS in your PC.
 - 2) You need to finish updating the latest Service Pack for your OS.
3. ZV/Multi-function PC Cards don't run with the CBS52.
4. The CBS52 doesn't support ACPI mode of Windows 98SE.
5. The CBS52 doesn't run on SOTEC PC STATION M760, COMPAQ PROLINEA590, DELL OptiPlex GXPro.
6. The CBS52 doesn't run on P3C series mother board made by ASUS, GA-7ZXR made by GIGABYTE.
7. Multi-processor, Dual CPU aren't supported.
8. The CBS52 may not run on a modified PC.
9. The CBS52 may not run with a server computer.
10. The other PC Card Adapters other than the CBS52 must not be used with the CBS52 simultaneously.
11. The specifications of hardware/software are subject to change without notice.

2. Installation

This chapter describes how to install the CBS52.

If you have **Windows XP**, proceed to **2-1**.

If you have **Windows Me,2000,98SE** proceed to **2-3**.

2-1. Installing on Windows XP



If you install the CBS52 on Windows XP, you don't need the bundled CD-ROM. Don't use the CD-ROM.

Turn off the PC and install the CBS52 into an available PCI slot.
After installing it, turn on the PC.



1. **Intall the CBS52 straight into an available PCI slot.**
2. **Install the CBS52 into the PCI slot until the board seats firmly.**
3. **Fasten the CBS52 with screws, as shown below.**

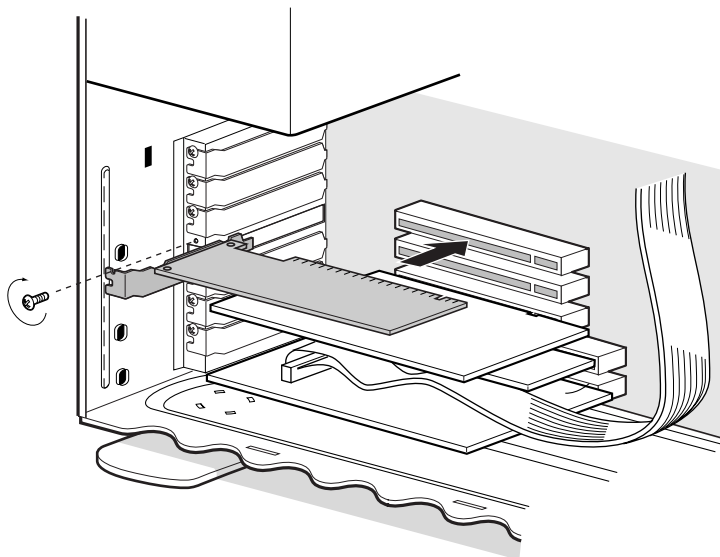

2-2. Confirmation of the driver installation

1. Right-click on [My Computer] and select [Properties]. Click the [Hardware] tab and click the [Device Manager] button. Check there are two [Ricoh R/RL/5C476(II) or Compatible CardBus Controller] strings under the [PCMCIA adapters]. Double-click a [Ricoh R/RL/5C476(II) or Compatible CardBus Controller] string.

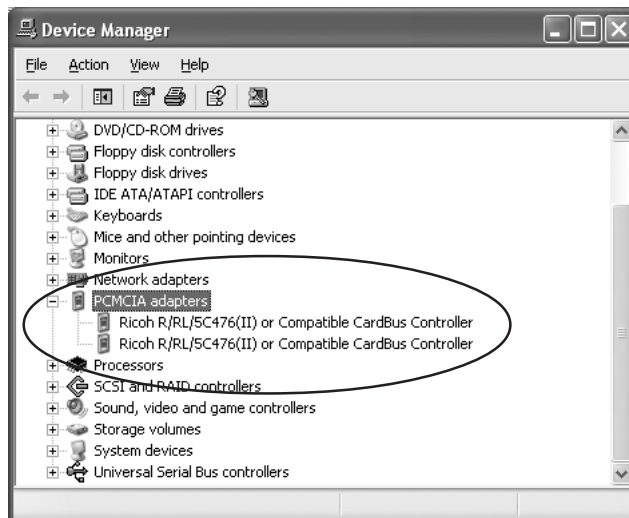

2. If you can find a [This device is working properly] under the [Device status], you have completed the installation successfully.

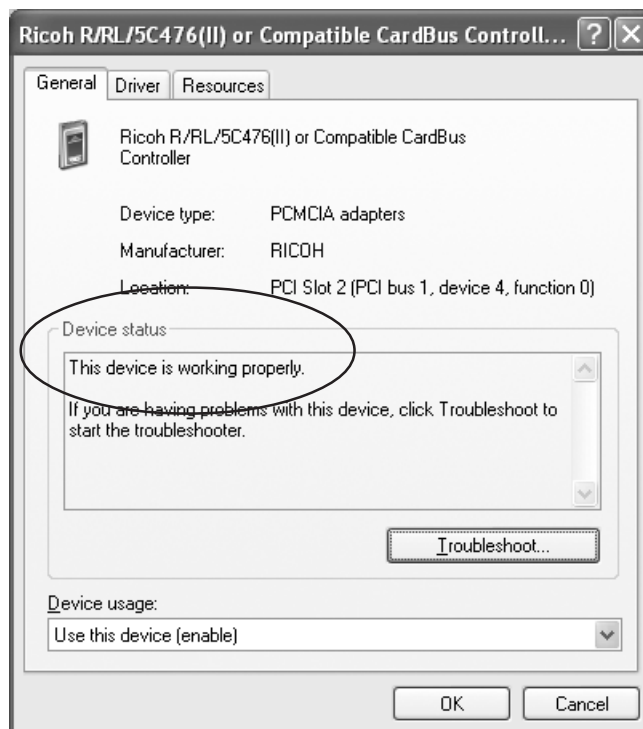

2-3. Installing on Windows Me/2000/98SE



If you use a 16bit PC Card on Windows Me/2000/98SE, you need to install the driver from the bundled CD-ROM before installing the CBS52 into a PCI slot. If you don't use a 16bit PC Card, you don't need to install the driver from the bundled CD-ROM.

Follow the steps through:

- (1) **Running [Setup.exe] at the CD-ROM**



- (2) **Installing the CBS52 into an available PCI slot**



- (3) **Installing the driver**



- (4) **Driver confirmation**

(1)Running [Setup.exe] at the CD-ROM

Run [Setup.exe] at the CD-ROM before you install the CBS52.

1. Close other programs running on your PC. Run [Setup.exe].
2. The installation program will start. Click [Next].

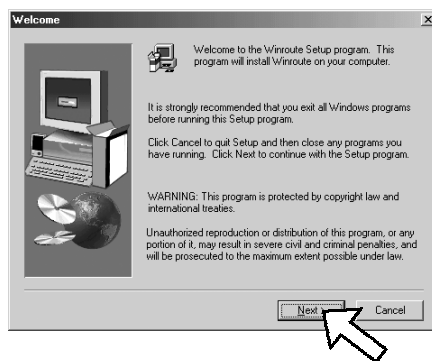

3. If you agree on the License Agreement, click [Yes].

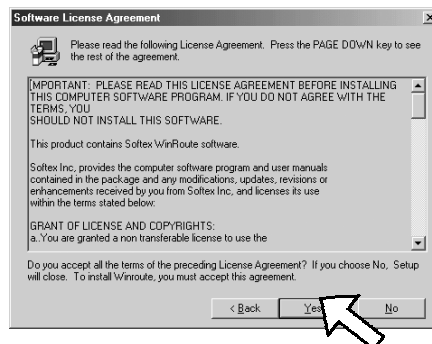

4. Confirm the destination of the program, and click [Next].



5. Select [No, I will restart my computer later] and click [Finish]. Shut down your PC.

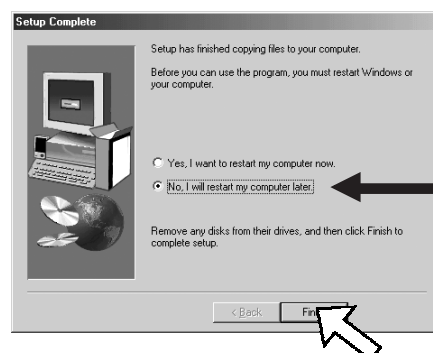

(2)Installing the CBS52 into an available PCI slot

Turn off the PC and install the CBS52 into an available PCI slot.

After installing it, turn on the PC.



1. Intall the CBS52 straight into an available PCI slot.
2. Install the CBS52 into the PCI slot until the board seats firmly.
3. Fasten the CBS52 with screws, as shown below.

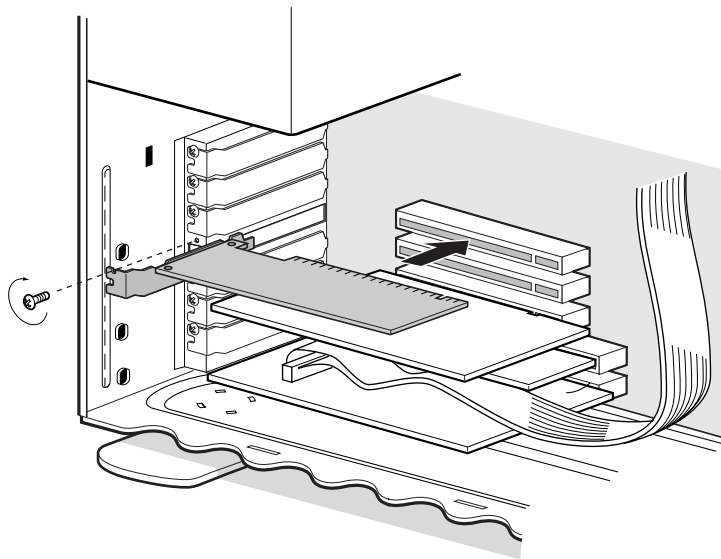

(3)Installing the driver

If you have **Windows Me**, proceed to (3-1).

If you have **Windows 2000**, proceed to (3-2).

If you have **Windows 98SE** proceed to (3-3).

(3-1) Windows Me

If you start your PC after installing the CBS52, you are requested to restart your PC, as shown. Click [Yes] to restart your PC. Proceed to (4-1) Driver confirmation for Windows Me/98SE.

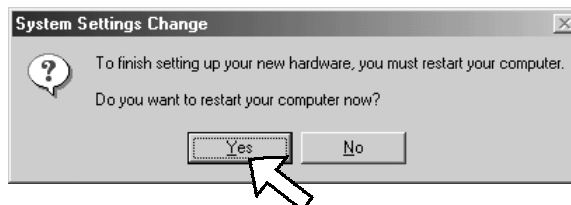

(3-2) Windows 2000

If you start your PC after installing the CBS52, you are requested to restart your PC, as shown. Click [OK] to restart your PC. Proceed to (4-2) Driver confirmation for Windows 2000.

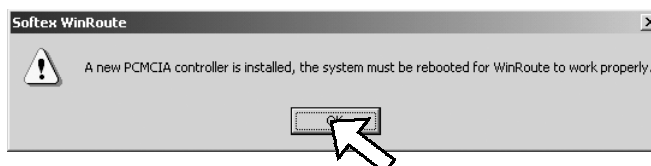

(3-3) Windows 98SE

1. If you start your PC after installing the CBS52, the following wizard will appear. Select [No] and click [Next].

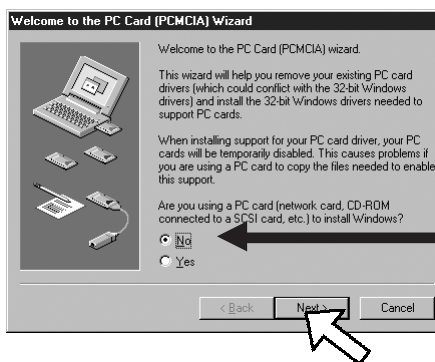

2. Select [No] and click [Next].

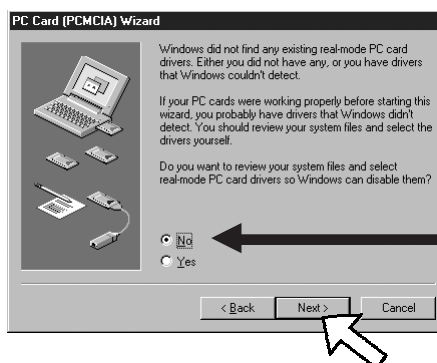

3. Click [**Finish**] and restart your PC. Proceed to **(4-1)Driver confirmation for Windows Me/98SE**.

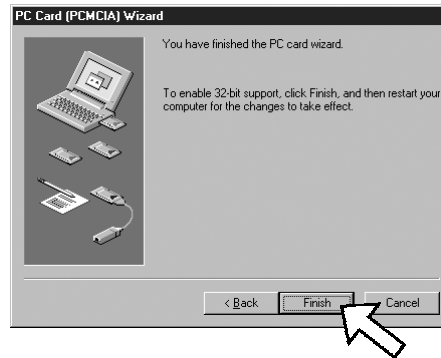

(4)Driver Confirmation

(4-1)Driver Confirmation for Windows Me/98SE

1. Right-click on [**My Computer**] and click the [**Device Manage**] tab. Check there are two [**Ricoh RL5C476 CardBus Controller**] strings under the [**PCMCIA socket**]. Double-click a [**Ricoh RL5C476 CardBus Controller**] string.

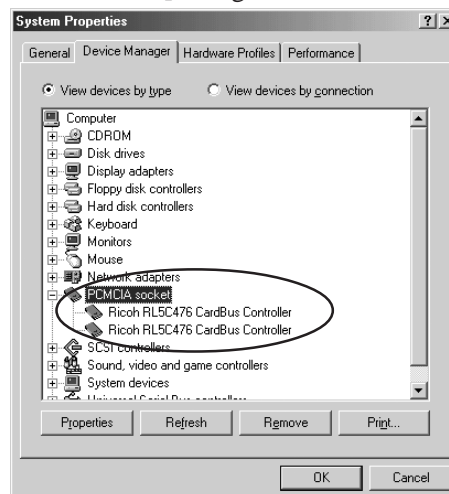

2. If you can find a [**This device is working properly**] under the [**Device status**], you have completed the installation successfully.

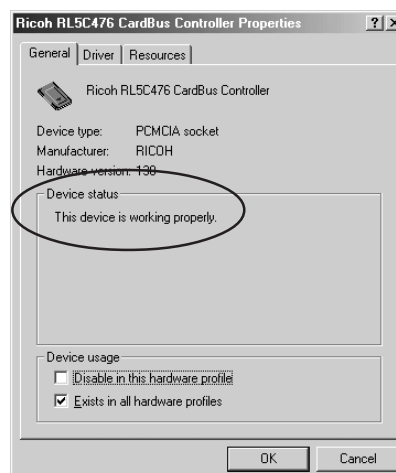

3. Run [GetDrvVer.exe] at the [GetDrvVer] folder in the CD-ROM. You can know the version of the installed programs. You have now finished the installation.



(4-2) Driver Confirmation for Windows 2000

1. Right-click on [My Computer] and select [Properties]. Click the [Hardware] tab and click the [Device Manager] button. Check there are two [Ricoh R/RL/5C476(II) or Compatible CardBus Controller] strings under the [PCMCIA adapters]. Double-click a [Ricoh R/RL/5C476(II) or Compatible CardBus Controller] string.

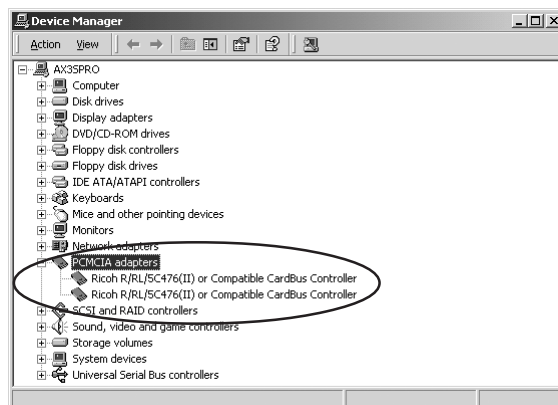

2. If you can find a [This device is working properly] under the [Device status], you have completed the installation successfully.

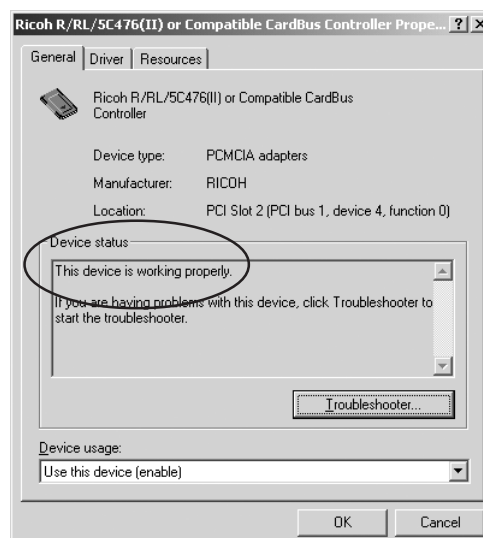

3. Run [**GetDrvVer.exe**] at the [**GetDrvVer**] folder in the CD-ROM. You can know the version of the installed programs. You have now finished the installation.

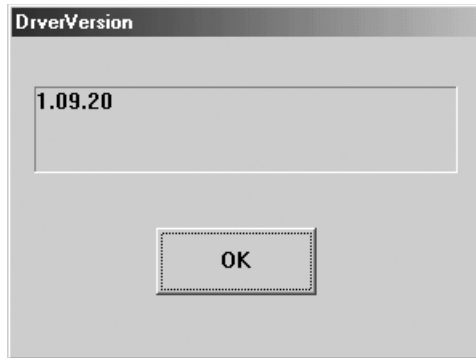

3. Troubleshooting

(1) How to uninstall the programs(Windows Me/2000/98SE users only)

If you want to delete the programs installed from the bundled CD-ROM, follow the step:

- a. Double-click [My Computer]->[Control Panel]->[Add/Remove Programs] and select [Winroute]. Then, delete it.

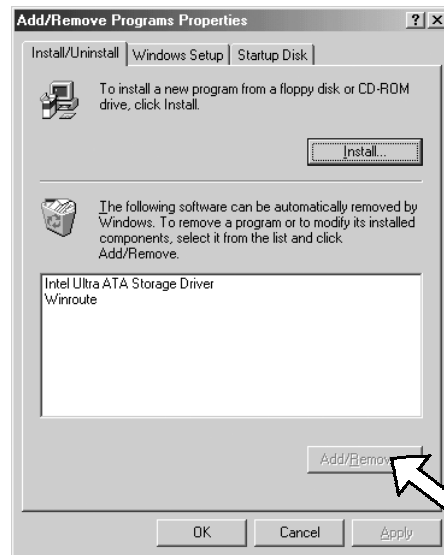

(Windows Me/98SE)

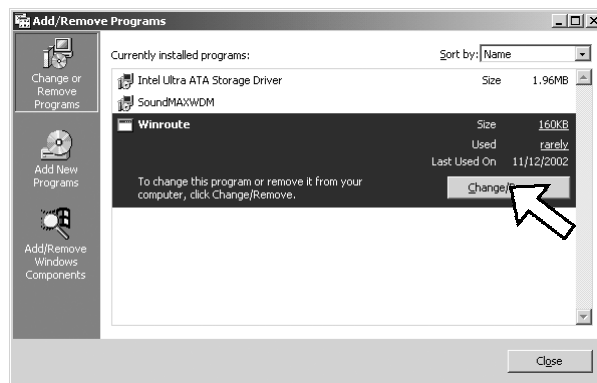

(Windows 2000)

- b. Click [Yes].

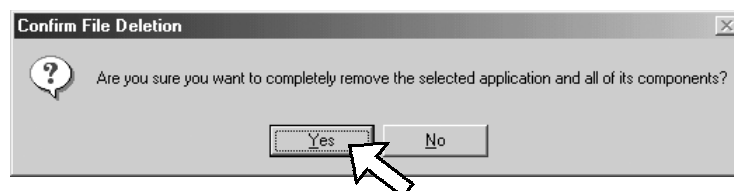

c. Click [OK].

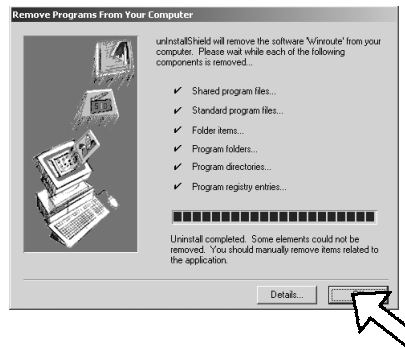

d. Click [OK]. Restart your PC. You have now completed deleting the programs.



(2)How to update the programs(Windows Me/2000/98SE users only)

If you have a latest program available through our web site, follow the steps to update the programs.

- A)Delete the programs first, as described in step (1)
- B) Run a latest programs and follow on-screen instructions.

(3)Troubleshooting

Q. [PCMCIA Card Service]stirng appears with “!”marks in Windows Me.

A. Restart your PC.

Q. I am using a ATA type of memory card. It seems I installed the driver correctly, but its driver icon doesn't appear in [My Computer].

A. This problem may happen to Windows 98SE/Me. To resolve this problem, open [Device Manager] and show the properties on the appropriate drive under the [Disk drives]. Put a check mark at [Removable] at the [Settings] tab and click [OK]. Then, restart your PC.

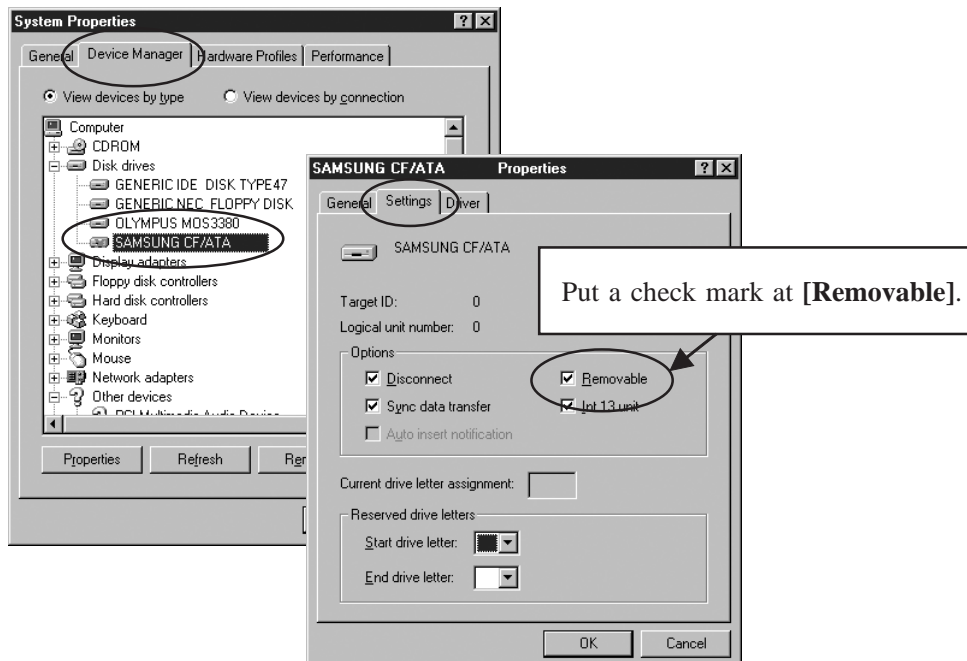

4. Registration and Tech-support

4-1. How to Register

We highly recommend to register yourself as our customer through our on-line registration.

1. On the Internet, access our site (<http://www.ratocsystems.com/english/>)
2. Follow window menu guide to register.
3. Fill out and submit the registration form.

4-2. Software Update and Support

-Driver Update-

The latest driver or utility software are subject to change for improvement or bug fix.

You can download the latest version from our web site.

(<http://www.ratocsystems.com/english/>)

-Technical Support-

You can get a Tech support from RATO C at the following.

(Open Monday - Friday, 9:30A.M. to 5:00P.M(PST))

RATO C Systems International, Inc. Tech support

Address: 1933 O'Toole Avenue Suite A109

SanJose, CA 95131, U.S.A.

Phone : (408)955-9400

Fax : (408)955-9402

E-mail : int-support@rexpccard.co.jp

Web : <http://www.ratocsystems.com/english/>

NOTE:

Please include the following information to help us to assist you in the event of a problem:

- Our product name, serial number, and product description
- Host Computer Name, OS version
- Driver version

Appendix

Copyright

©2002 RATOC Systems, Inc. All rights reserved. No part of this publication may be reproduced, stored in a retrieval system, or transmitted in any form or by any means (electronic, mechanical, photocopying, recording or otherwise) without the prior written consent of RATOC Systems, Inc.

Trademarks

- Windows is a registered trademark of Microsoft Corporation.
- Other brand and product names may be registered trademarks or trademarks of their respective holders.

Changes

The information in this User's Manual is furnished for information only and is subject to change without notice. RATOC Systems, Inc. reserves the right to make changes in the product design or product improvements without reservations and without notification to its users. RATOC Systems, Inc. assumes no responsibility or liability for any errors or inaccuracies that may appear in this document.

Regulatory Compliance Statements

FCC Compliance Statement

This equipment has been tested and found to comply with the limits for a Class B digital device, pursuant to Part 15 of the FCC Rules. These limits are designed to provide reasonable protection against harmful interference in a residential installation. This equipment generates, uses and can radiate radio frequency energy and, if not installed and used in accordance with the instructions, may cause harmful interference to radio communications. However, there is no guarantee that interference will not occur in a particular installation. If this equipment does cause harmful interference to radio or television reception, which can be determined by turning the equipment off and on, the user is encouraged to try to correct the interference by one or more of the following measures:

- (1) Reorient or relocate the receiving antenna.
- (2) Increase the separation between the equipment and receiver.
- (3) Connect the equipment into an outlet on a circuit different from that to which the receiver is connected.
- (4) Consult the dealer or an experienced radio/TV technician for help.

Changes or modifications not expressly approved by the party responsible for compliance may result in this unit not complying with FCC Rules Part 15.



Free Manuals Download Website

<http://myh66.com>

<http://usermanuals.us>

<http://www.somanuals.com>

<http://www.4manuals.cc>

<http://www.manual-lib.com>

<http://www.404manual.com>

<http://www.luxmanual.com>

<http://aubethermostatmanual.com>

Golf course search by state

<http://golfingnear.com>

Email search by domain

<http://emailbydomain.com>

Auto manuals search

<http://auto.somanuals.com>

TV manuals search

<http://tv.somanuals.com>