



*packet moud*™



# OWNER'S MANUAL

**Read and understand this entire manual before riding!**

**Español.....Página 14**

**Français.....Page 29**

Item Number:

**Bistro 15130640**

**Bella 15130662**

**Betty 15130661**

# CONTENTS

Safety Warnings .....	1	Troubleshooting Guide.....	7-8
Before You Begin.....	2	Pocket Mod Parts.....	9-10
Assembly and Set-Up.....	3	Safety Reminders.....	12
Repair and Maintenance.....	4-6	Warranty .....	12

# SAFETY WARNINGS

**⚠ WARNING:** Riding the Pocket Mod can be a hazardous activity. Certain conditions may cause the equipment to fail without fault of the manufacturer. Like other electric vehicles, the Pocket Mod can and is intended to move, and it is therefore possible to lose control, fall off and/or get into dangerous situations that no amount of care, instruction or expertise can eliminate. If such things occur you can be seriously injured or die, even when using safety equipment and other precautions. **RIDE AT YOUR OWN RISK AND USE COMMON SENSE.**

This manual contains many warnings and cautions concerning the consequences of failing to maintain, inspect or properly use your Pocket Mod. Because any incident can result in serious injury or even death, we do not repeat the warning of potential serious injury or death each time such a possibility is mentioned.

## APPROPRIATE RIDER USE AND PARENTAL SUPERVISION

This manual contains important safety information. It is your responsibility to review this information and make sure that all riders understand all warnings, cautions, instructions and safety topics and assure that young riders are able to safely and responsibly use this product. Razor recommends that you periodically review and reinforce the information in this manual with younger riders, and that you inspect and maintain your children's vehicle to insure their safety.

The recommended rider age of 12 and older for Pocket Mod is only an estimate, and can be affected by the rider's size, weight or skills. Any rider unable to fit comfortably on the Pocket Mod should not attempt to ride it. **A parent's decision to allow his or her child to ride this product should be based on the child's maturity, skill and ability to follow rules.**

Keep this product away from small children and remember that this product is intended for use only by persons who are, at a minimum, completely comfortable and competent while operating the vehicle.

**DO NOT EXCEED THE WEIGHT LIMIT OF 220 pounds.** Rider weight does not necessarily mean a person's size is appropriate to fit or maintain control of the Pocket Mod.

Do not touch the motor on your Pocket Mod when in use as it can become very hot.

Refer to the section on safety for additional warnings.

## ACCEPTABLE RIDING PRACTICES AND CONDITIONS

Always check and obey any local laws or regulations which may affect the locations where the Pocket Mod may be used on public property. The Pocket Mod is meant to be used only in controlled environments free of potential traffic hazards and not on public streets or sidewalks. Do not ride your Pocket Mod in any areas where pedestrian or vehicle traffic is present.

Ride defensively. Watch out for potential obstacles that could catch your wheel or force you to swerve suddenly or lose control. Be careful to avoid pedestrians, skaters, skateboards, scooters, bikes, children or animals who may enter your path, and respect the rights and property of others.

Do not attempt or do stunts or tricks on your Pocket Mod. The Pocket Mod is not made to withstand abuse from misuse such as jumping, curb grinding or any other type of stunts.

Maintain a hold on the handlebars at all times.

Never carry passengers or allow more than one person at a time to ride the Pocket Mod.

Never use near steps or swimming pools.

Keep your fingers and other body parts away from the drive chain, steering system, wheels and all other moving components.

Never use headphones or a cell phone when riding.

Never hitch a ride with another vehicle.

Do not ride the Pocket Mod in wet weather and never immerse the Pocket Mod in water, as the electrical and drive components could be damaged by water or create other possibly unsafe conditions.

The Pocket Mod is intended for use on solid, flat, clean and dry surfaces such as pavement or level ground without loose debris such as rocks or gravel. Wet, slick or uneven and rough surfaces may impair traction and contribute to possible accidents. Do not drive the Pocket Mod in mud, ice, puddles or water. Avoid excessive speeds that can be associated with downhill rides. Never risk damaging surfaces such as carpet or flooring by use of a Pocket Mod indoors.

Do not ride at night or when visibility is impaired.

## PROPER RIDING ATTIRE

Always wear proper protective equipment such as an approved safety helmet, elbow pads and kneepads. A helmet may be legally required by local law or regulation in your area. Always wear shoes, never drive barefooted or in sandals, and keep shoelaces tied and out of the way of the wheels, motor and drive system.

## USING THE CHARGER

The charger supplied with the Pocket Mod should be regularly examined for damage to the cord, plug, enclosure and other parts, and in the event of such damage, the bike must not be charged until the charger has been repaired or replaced.

Use only with the recommended charger.

The charger is not a toy.

Always disconnect from the charger prior to wiping down and cleaning your Pocket Mod with liquid.

**FAILURE TO USE COMMON SENSE AND HEED THE ABOVE WARNINGS INCREASES RISK OF SERIOUS INJURY. USE WITH APPROPRIATE CAUTION AND SERIOUS ATTENTION TO SAFE OPERATION.**

# BEFORE YOU BEGIN

Remove contents from box. Remove the foam separators that protect the components from damage during shipping. Inspect the contents of the box for scratches in the paint, dents or kinked cables that may have occurred during shipping. Because the Pocket Mod was 95 percent assembled and packed at the factory, there should not be any problems, even if the box has a few scars or dents.

## Estimated Assembly and Set-Up Time

Razor recommends assembly by an adult with experience in bicycle mechanics.

Allow up to 15 minutes for assembly, not including initial charge time.

Allow up to 12 hours for initial charge (see page 3 for charging information).

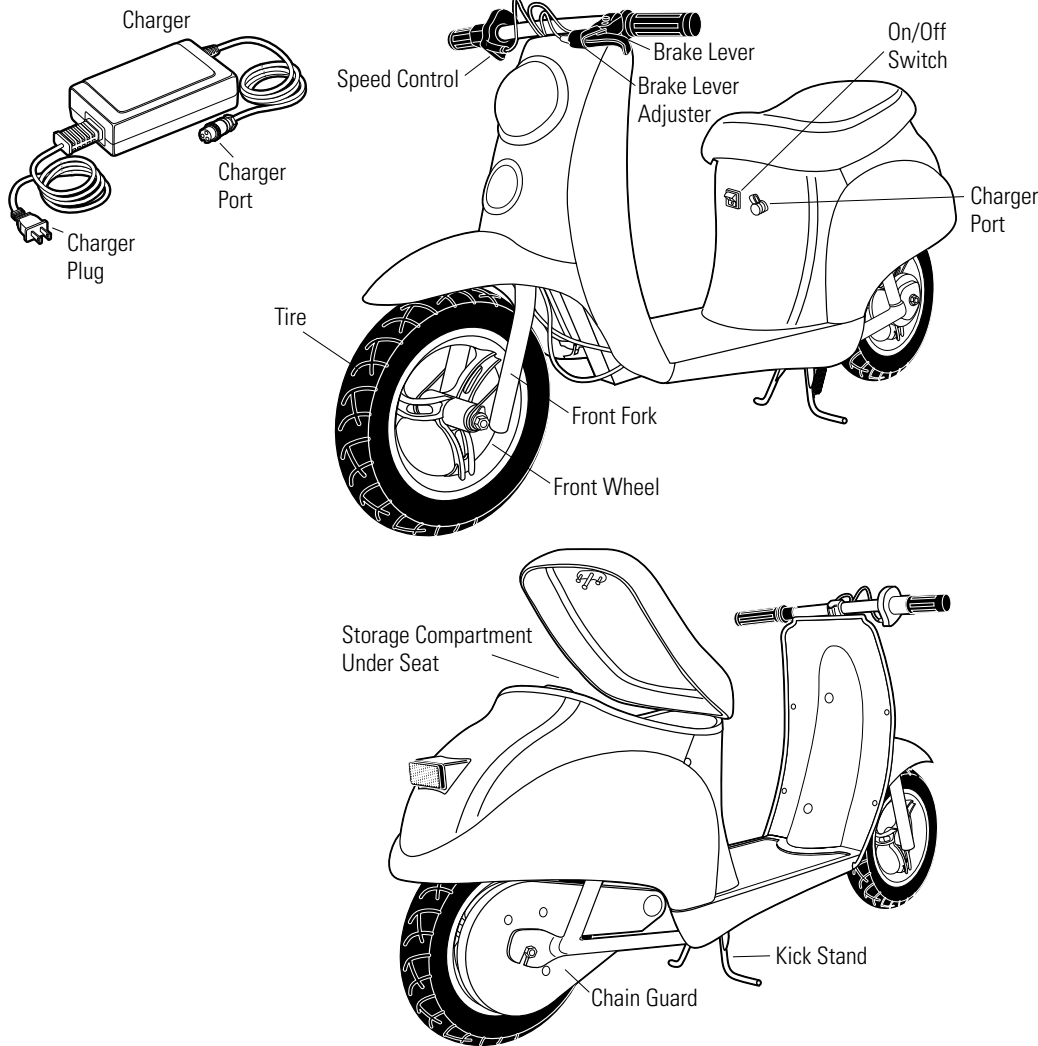

**WARNING:**  
DO NOT USE NON-RAZOR PRODUCTS WITH YOUR RAZOR POCKET MOD. The Pocket Mod has been built to certain Razor design specifications. The original equipment supplied at the time of sale was selected on the basis of its compatibility with the frame, fork and all other parts. Certain aftermarket products may or may not be compatible.

## Required Tools

Some tools may be supplied; however, we recommend the use of mechanic's grade tools. Use the supplied tools only as a last resort.

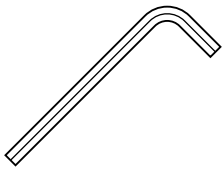

5mm hexagonal key wrench (included)

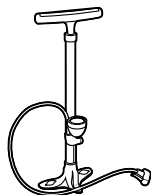

Bicycle-style tire pump for Schrader valve tires, with pressure gauge

**Need Help?** Visit our web site for updates and a list of authorized service centers at [www.razor.com](http://www.razor.com) or call toll-free at **866-467-2967** Monday - Friday 8:00 AM - 5:00 PM Pacific Time.

# ASSEMBLY AND SET-UP

## Charging the Battery

Your Pocket Mod may not have a fully charged battery; therefore it is a good idea to charge the battery prior to use.

- Initial charge time: 12 hours
- Recharge time: up to 8 hours depending on the level of depletion
- Run time: up to 40 minutes
- Average battery life: 250 charge/discharge cycles

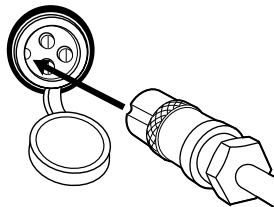
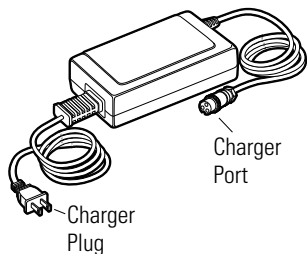

**1** Plug the charger port into the port on the Pocket Mod. The charger works with the power switch in either the on or off position.

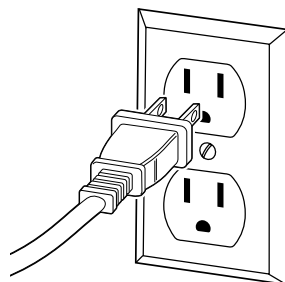

**2** Plug the charger plug into a wall outlet.

### **⚠ WARNING:**

Rechargeable batteries are only to be charged under adult supervision. Always disconnect your Pocket Mod from the charger before cleaning with liquid.

**Note:** If your charger does not look like the one illustrated, your unit has been supplied with an alternative charger. The specifications and charging procedure would not change.

The charger has a small window with one LED or two LEDs to indicate the charge status. Refer to the illustration on the charger unit for the actual "charging" and "charged" status indications for your model charger.

Chargers have built-in over-charge protection to prevent battery from being over-charged.

**Be sure to properly align the groove on the charger input plug with the corresponding socket on the case; otherwise, no charging action will occur.**

### **⚠ WARNING:**

Failing to properly adjust and tighten the clamps and retainers that affix the handlebar can cause you to lose control and fall.

## Attaching the Handlebars

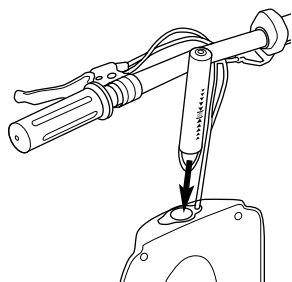

**1** Insert handlebar assembly through front fairing and into fork until it stops. Raise to desired height keeping the stem and fairing aligned within the red arrows of the safety zone.

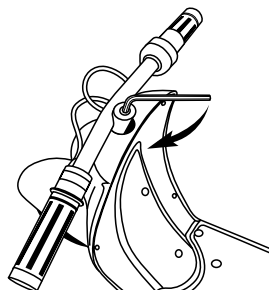

**2** Tighten down the hexagonal bolt with the 5mm hexagonal key wrench.

## Attaching the Front Wheel

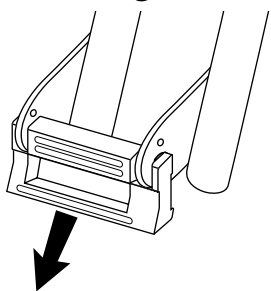

**1** Remove the packing material from the front fork.

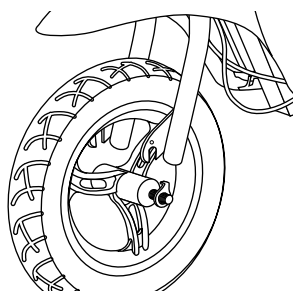

**2** Insert the wheel into the front fork with the lock washers on the outside of the fork.

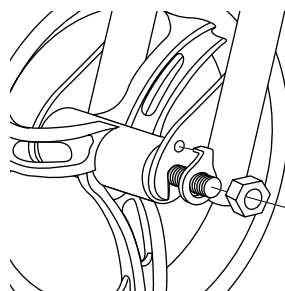

**3** Insert the tab on the lock washer into the hole on the front fork and tighten the nuts with the supplied wrenches.

## ASSEMBLY AND SET-UP

### Testing the Brakes

To use the brake, squeeze the lever to increase the pressure on the brake. The brake lever is fitted with a cable adjuster to compensate for cable stretch and/or to fine-tune the lever movement to brake engagement. If brake is not engaging properly, follow instructions for adjusting the brakes outlined on the next page.

Check the Razor web site for any updates on the latest repair and maintenance procedures.

**Turn power switch off before conducting any maintenance procedures.**

### □ Adjusting the Brakes

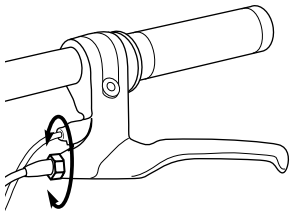

**1** To adjust the play, thread the brake lever adjuster in or out 1/4 to 1/2 turn until the desired brake adjustment is attained. Most adjustments are complete at this step. If brake still needs further adjustment, proceed to step 2.

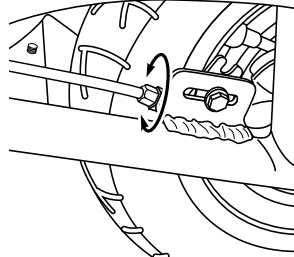

**2** If the brake lever adjuster is threaded outward and the brake still has too much slack, use the rear brake adjuster for additional adjustment.

**⚠ WARNING:** The brake is capable of skidding the tire and throwing an unsuspecting rider. Practice in an open area free from obstacles until you are familiar with the brake function. Avoid skidding to a stop as this can cause you to lose control or damage the rear tire.

**Note:** The brake lever contains a safety switch to stop the motor when the brake is applied. In an emergency, applying the brake will always stop the motor. Do not disable or replace this lever with anything other than a genuine Razor replacement part.

## REPAIR AND MAINTENANCE

### □ Inflating the Tires

Tires are inflated when shipped, but they invariably lose some pressure between the point of manufacturing and your purchase.

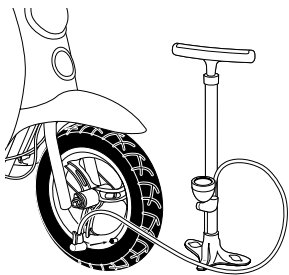

**1** Using a bicycle style tire pump equipped for a Schrader-type valve, inflate the front tire to the PSI indicated on the sidewall of the tire.

**Note:** The pressurized air supplies found at gasoline stations are designed to inflate high-volume automobile tires. If you decide to use such an air supply to inflate your Pocket Mod tires, first make sure the pressure gauge is working, then use very short bursts to inflate to the correct PSI. If you inadvertently over-inflate the tire, release the excess pressure immediately.

# REPAIR AND MAINTENANCE

## □ Chain and Rear Tire Replacement

**Tools required:** Phillips screwdriver, 10mm wrench, two (2) 8mm wrenches, and two (2) 17mm wrenches.

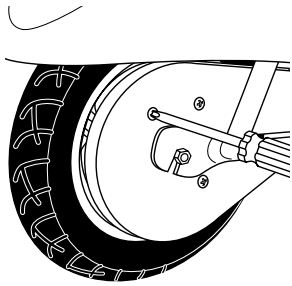

**1** With a Phillips screwdriver, remove the screws that secure the chainguard. Remove chainguard.

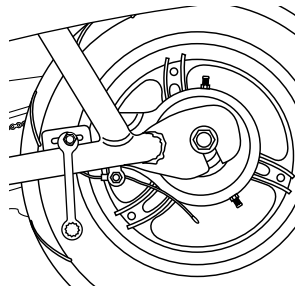

**2** With a 10mm wrench, loosen the brake cable anchor and disconnect the cable.

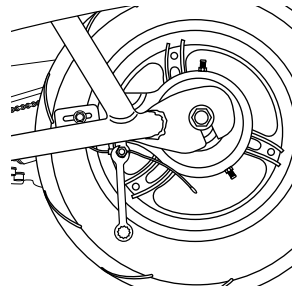

**3** With two 8mm wrenches, loosen brake housing anchor and disconnect. Keep the spacer and washers together.

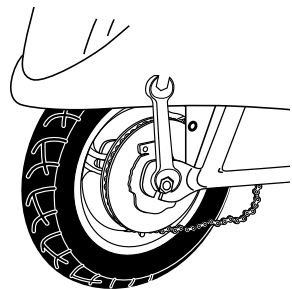

**4** With two 17mm wrenches, loosen the axle. Push the wheel forward in the slots to loosen the chain.

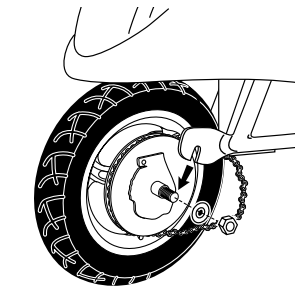

**5** Pull the wheel out. Note the arrangement of the hardware sequence.  
**Note:** Your hands will get greasy doing this.

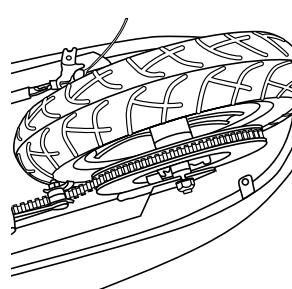

**6** Install the new chain or wheel by slipping the chain around the axle. Slide the axle into the slots on the frame. Slide the wheel forward and maneuver the chain onto the rear sprocket, front sprocket and chain tensioner.

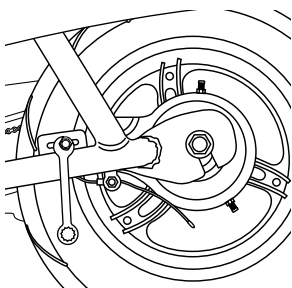

**7** Tighten the brake housing anchor securely.

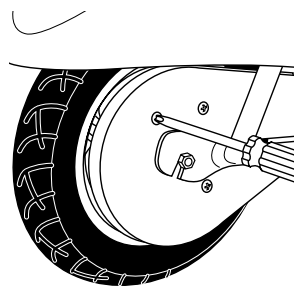

**8** Re-attach the chain guard. Test ride and check. Readjust as needed.

# REPAIR AND MAINTENANCE

## □ Replacing the Fuse

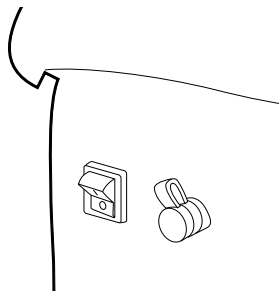

**1** Make sure the power switch is turned off.

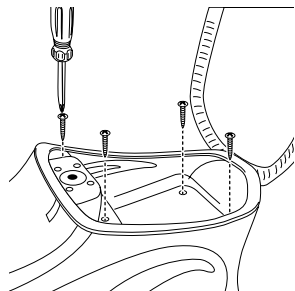

**2** lift up the seat and unscrew the four corner screws in storage compartment.

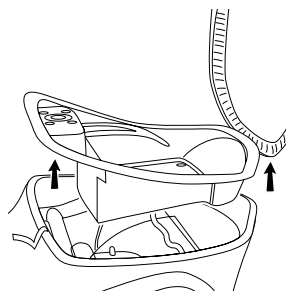

**3** Remove seat/storage compartment.

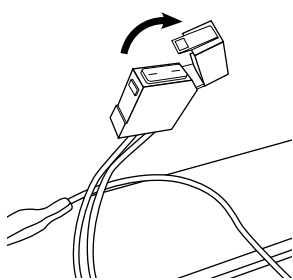

**4** Locate fuse cover on top of battery assembly. Open the fuse cover to expose the fuse.

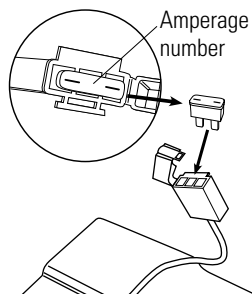

**5** Remove the fuse and replace with a new one of equal amperage.  
**Note:** Amperage rating is located on top of fuse. Fuse must be replaced with one of equal amperage.

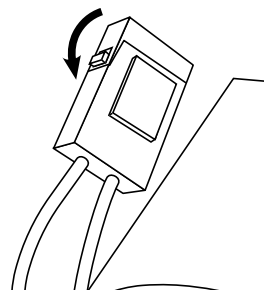

**6** Close the fuse cover. Replace seat/storage compartment and secure with the four corner screws.

## ⚠ WARNING:

To prevent shock or short circuit, please follow the instructions accordingly and do not skip or combine any steps.

## □ Battery Care and Disposal

Do not store the battery in temperatures above 75° or below -10° F.



CONTAINS SEALED LEAD BATTERY. BATTERY MUST BE RECYCLED.

**Disposal:** Your Razor product uses sealed lead-acid batteries which must be recycled or disposed of in an environmentally sound manner. Do not dispose of a lead-acid battery in a fire. The battery may explode or leak. Do not dispose of a lead-acid battery in your regular household trash. The incineration, land filling or mixing of sealed lead-acid batteries with household trash is prohibited by law in most areas. Return exhausted batteries to a federal or state approved lead-acid battery recycler or a local seller of automotive batteries. If you live in Florida or Minnesota, it is prohibited by law to throw away lead-acid batteries in the municipal waste stream.

## □ Charger

The transformer/charger supplied with the Pocket Mod should be regularly examined for damage to the cord, plug, enclosure and other parts, and, in the event of such damage, the bike must not be charged until it has been repaired or replaced.

Use ONLY with the recommended charger.

## □ Replacement Parts

The most frequently requested replacement parts (wheels, tires, tubes, batteries and chargers) are available for purchase at some Razor retail partners or online at [www.razorama.com](http://www.razorama.com). For other parts contact an authorized Razor repair center.

## □ Repair Centers

For a list of authorized Razor repair centers:

- Check online at [www.razor.com](http://www.razor.com).
- Send e-mail to [customerservice@razorusa.com](mailto:customerservice@razorusa.com) or call 866-467-2967 for the center nearest you.

## ⚠ WARNING:

If a battery leak develops, avoid contact with the leaking acid and place the damaged battery in a plastic bag. Refer to the disposal instructions at left. If acid comes into contact with skin or eyes, flush with cool water for at least 15 minutes and contact a physician.

# TROUBLESHOOTING GUIDE

<b>Problem</b>	<b>Possible Cause</b>	<b>Solution</b>
Vehicle does not run	Undercharged battery	<p>Charge the battery. A new battery should have been charged for at least 12 hours before using the vehicle for the first time and up to 8 hours after each subsequent use.</p> <p>Check all connections. Make sure the charger port is tightly plugged into the charging port on the Pocket Mod, and that the charger is plugged into the wall.</p> <p>Make sure power flow to the wall outlet is on.</p>
	Charger is not working	You may check to see if your charger is working by using a volt meter or asking your local Razor authorized service center to test your charger for you.
Vehicle was running but suddenly stopped	Loose wires or connectors	Check all wires and connectors to make sure they are tight.
	Tripped circuit breaker	<p>The circuit breaker (next to on/off switch) will automatically shut off the power if the motor is overloaded.</p> <p>An excessive overload, such as too heavy a rider or too steep a hill, could cause the motor to overheat. If the Pocket Mod suddenly stops running, wait a few seconds and then push the breaker to reset the circuit. Correct the conditions that caused the breaker to trip and avoid repeatedly tripping the breaker.</p>
Short run time (less than 30 minutes per charge)	Undercharged battery	<p>Charge the battery. A new battery should have been charged for at least 12 hours before using the vehicle for the first time and up to 8 hours after each subsequent use.</p> <p>Check all wires and connectors. Make sure the battery connector is tightly plugged into the charger connector, and that the charger is plugged into the wall.</p> <p>Make sure power flow to the wall outlet is on.</p>
	Battery is old and will not accept full charge	Even with proper care, a rechargeable battery does not last forever. Average battery life is 1 to 2 years depending on vehicle use and conditions. Replace only with a Razor replacement battery.
	Brakes are not adjusted properly	Refer to adjusting the brakes instructions on page 4.
Vehicle runs sluggishly	Driving conditions are too stressful	Use only on solid, flat, clean and dry surfaces such as pavement or level ground.
	Tires are not properly inflated	The tires are inflated when shipped, but they invariably will lose some pressure between the point of manufacturing and your purchase. Refer to instructions on page 4.
	Vehicle is overloaded	Make sure you do not overload the vehicle by allowing more than one rider at one time, exceeding the 220 lb. maximum weight limit, going up a hill or towing objects behind the vehicle. If the vehicle is overloaded, the circuit breaker may trip and shut off power to the motor. Correct the driving conditions that caused the overload, wait a few seconds, and then push the breaker to reset the circuit. Avoid repeatedly tripping the circuit breaker.



## TROUBLESHOOTING GUIDE

<b>Problem</b>	<b>Possible Cause</b>	<b>Solution</b>
Sometimes the vehicle doesn't run, but other times it does	Loose wires or connectors	Check all wires around the motors and all connectors to make sure they are tight.
	Motor or electrical switch damage	Contact your local Razor authorized service center for diagnosis and repair.
Charger gets warm during use	Normal response to charger use	No action required. This is normal for some chargers and is no cause for concern. If your charger does not get warm during use, it does not mean that it is not working properly.
Vehicle does not stop when applying the brake	Brakes are not adjusted properly	Refer to adjusting the brakes instructions on page 4.
Vehicle makes loud noises or grinding sounds	Chain adjustment is too tight or too loose	Refer to instructions on page 5 of this manual to properly adjust chain and sprocket.
	Chain is too dry	Apply a lubricant such as 3 in 1™ or Tri-Flow™ to the chain.

**Need Help?** Visit our web site for updates and a list of authorized service centers at [www.razor.com](http://www.razor.com) or call toll-free at **866-467-2967** Monday - Friday 8:00 AM - 5:00 PM Pacific Time.

# POCKET MOD PARTS

Keep your Pocket Mod running for years with genuine Razor parts. Visit our web site or e-mail us for more information on spare part availability. (Specifications subject to change without notice.)

1. Screw, self-threading for faux head lamp cover
2. Faux head lamp cover
3. fairing, front
4. Grip, left side
5. Brake lever, left side w cut-off switch
6. Brake cable w/housing
7. Wedge for handlebar stem
8. Handlebar, T-shape
9. Bolt for handlebar
10. Speed controller w/LEDs
11. Grip, half length right side
12. Screw, self-threading for fairing cover
13. Cover, for front fairing
14. Switch, main on/off
15. Input plug, charging
16. Fairing, seat front
- 17-30. Seat and seat tray assembly
31. 12v 7AH battery set
32. Screw for chain cover
33. Chain cover top
34. Screws for chain cover bottom
35. Chain cover bottom
36. Screw for right rear fairing
37. Right rear fairing
38. Rear fairing
39. License plate blank
40. Rear fairing trim
41. Axle nut, rear wheel
42. Chain guide for rear sprocket, outside
43. Chain for Pocket Mod
44. Rear sprocket for Pocket Mod
45. Chain guide for rear sprocket, inside
46. Spacer
47. Rear wheel assembly (tire, tube, wheel, bearings, spacer)
48. Axle, rear
49. Spacer, for brake
50. Brake assembly
51. Spacer outside brake
52. Washer
53. Left rear fairing
54. Motor
- 55-62. Chain tension assembly parts
- 63-68. Kickstand
69. Control module
70. Base fairing
71. Screws for base to side fairings
72. Screws for base to frame
73. Axle nut, front wheel
74. Washer, front axle
75. Axle, front wheel
76. Inner tube (front and rear wheel)
77. Spacer, front wheel
78. Front wheel assembly (tire, tube, bearings, spacer)
79. Safety retainer for front wheel
80. Fork
81. Steering bearings
82. Main frame

# POCKET MOD PARTS

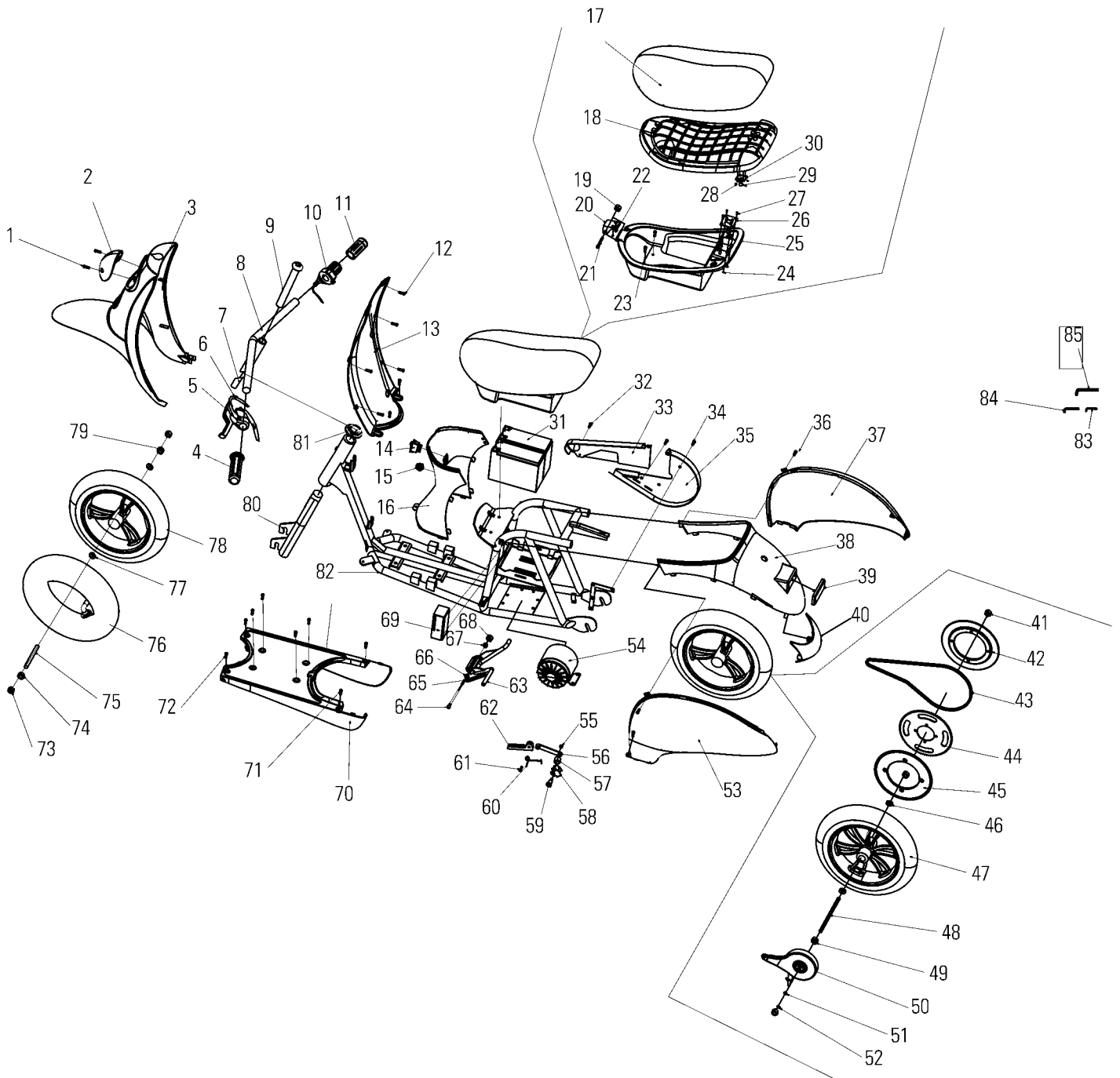

**SB 1918 (CALIFORNIA) DECLARATION**

YOUR INSURANCE POLICIES MAY NOT PROVIDE COVERAGE FOR ACCIDENTS INVOLVING THE USE OF THIS SCOOTER/ELECTRIC VEHICLE. TO DETERMINE IF COVERAGE IS PROVIDED, YOU SHOULD CONTACT YOUR INSURANCE COMPANY OR AGENT.

## SAFETY REMINDERS

### PRE-RIDE CHECKLIST



#### Loose Parts

Check and secure all fasteners before every ride. Make sure steering stem clamp bolts are locked properly in place. There should not be any unusual rattles or sounds from loose parts or broken components. If you are not sure, ask an experienced mechanic to check.



#### Brake

Check the brake for proper function. When you squeeze the lever, the brake should provide positive braking action. When you apply the brake with the speed control on, the brake cut-off switch will stop the motor.



#### Frame, Fork and Handlebars

Check for cracks or broken connections. Although broken frames are rare, it is possible for an aggressive driver to bash into a curb or wall and wreck and bend or break a frame. Get in the habit of inspecting yours regularly.



#### Tire Inflation

Periodically inspect the tires for excess wear, and regularly check the tire pressure and re-inflate as necessary. If you get a flat tire, the inner tube can be patched or a new tube can be purchased from Razor or an authorized repair center.



#### Safety Gear

Always wear proper protective equipment such as an approved safety helmet, elbow pads and kneepads. Always wear shoes (lace-up shoes with rubber soles), never drive barefooted or in sandals, and keep shoelaces tied and out of the way of the wheels, motor and drive system.

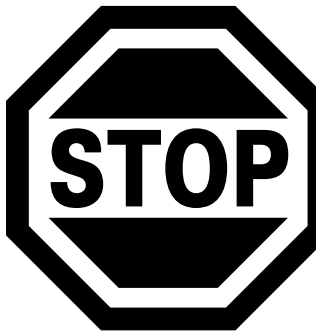

## DO NOT RETURN TO STORE

**Do not use this vehicle for the first time until you have inflated the tires to the correct PSI and charged the battery for at least 12 hours.**

**Failure to follow these instructions may damage your vehicle and void your warranty.**

## WARRANTY

### Razor Limited Warranty

The manufacturer warrants this product to be free of manufacturing defects for a period of 90 days from date of purchase. This Limited Warranty does not cover normal wear and tear, tires, tubes or cables, or any damage, failure or loss caused by improper assembly, maintenance, or storage or use of the Razor Pocket Mod.

This Limited Warranty will be void if the product is ever

- used in a manner other than for recreation;
- modified in any way;
- rented.

The manufacturer is not liable for incidental or consequential loss or damage due directly or indirectly to the use of this product.

Razor does not offer an extended warranty. If you have purchased an extended warranty, it must be honored by the store at which it was purchased.

For your records, save your original sales receipt with this manual and write the serial number below.

Item Number:

**Bistro 15130640**

**Bella 15130662**

**Betty 15130661**

**Need Help?** Visit our web site for updates and a list of authorized service centers at [www.razor.com](http://www.razor.com) or call toll-free at **866-467-2967** Monday - Friday 8:00 AM - 5:00 PM Pacific Time.

Patent Pending  
Printed in China for:  
Razor USA LLC  
PO Box 3610  
Cerritos, CA 90703  
© Copyright 2006 Razor USA. All rights reserved.



## Free Manuals Download Website

<http://myh66.com>

<http://usermanuals.us>

<http://www.somanuals.com>

<http://www.4manuals.cc>

<http://www.manual-lib.com>

<http://www.404manual.com>

<http://www.luxmanual.com>

<http://aubethermostatmanual.com>

Golf course search by state

<http://golfingnear.com>

Email search by domain

<http://emailbydomain.com>

Auto manuals search

<http://auto.somanuals.com>

TV manuals search

<http://tv.somanuals.com>