



LCD TV User's Manual

Model Number.

LED42A55RS

LED47A55RS

Part No.:ES-J100256

Changing Entertainment. Again.
www.rca.com



FCC Statement

NOTE:

The manufacturer is not responsible for any radio or TV interference caused by unauthorized modifications to this equipment. Such modifications could void the user's authority.



NOTE:



This equipment has been tested and found to comply with the limits for a class B digital Device, pursuant to part 15 of the FCC Rules. These limits are designed to provide reasonable protection against harmful interference in a residential installation. This equipment generates, uses and can radiate radio frequency energy and, if not installed and used in accordance with the instructions, may cause harmful interference to radio Communications. However, there is no guarantee that interference will not occur in a particular installation. If this equipment does cause harmful interference to radio or television reception, which can be determined by turning the equipment off and on, the user is encouraged to try to correct the interference by one or more of the following measures:

1. Reorient or relocate the receiving antenna.
2. Increase the separation between the equipment and the receiver.
3. Connect the equipment into an outlet on a circuit different from that to which the receiver is connected.
4. Consult the dealer or an experienced radio/TV technician for help.

Important Safety Precautions

Safeguards

	The lightning flash with arrowhead symbol, within an equilateral triangle, is intended to alert the user to the presence of un-insulated "dangerous voltage" within the product's enclosure that may be of sufficient magnitude to constitute a risk of electric to persons.
	The exclamation point within an equilateral triangle is intended to alert the user to the presence of important operating and maintenance (servicing) instructions in the literature accompanying the appliance.

	CAUTION RISK OF ELECTRIC SHOCK DO NOT OPEN!	
TO REDUCE THE RISK OF AN ELECTRIC SHOCK, DO NOT REMOVE THE COVER (OR BACK). THERE ARE NO USER SERVICEABLE PARTS INSIDE. FOR ANY REQUIRED SERVICING, PLEASE CONTACT QUALIFIED SERVICE PERSONNEL.		

Important safety instructions

CAUTION:

USE OF ANY CONTROLS, ADJUSTMENTS, OR PROCEDURES OTHER THAN THOSE SPECIFIED HEREIN MAY RESULT IN HAZARDOUS RADIATION EXPOSURE.

CAUTION:

These servicing instructions are for use by qualified service personnel only. To reduce the risk of electric shock, do not perform any servicing other than that contained in the operating instructions unless you are qualified to do so. Refer to service manual for servicing instructions.

Important safety instructions

1. Read these instructions
2. Keep these instructions
3. Heed all warnings
4. Follow all instructions
5. Do not use this apparatus near water
6. Clean only with dry cloth
7. Do not block any ventilation openings
8. Do not install near any heat sources
9. Do not defeat the safety purpose of the polarized or grounding-type plug
10. Protect the power cord from being damaged particularly at plugs, convenience receptacles, and at points in which they exit from the apparatus.
11. Only use attachments/accessories specified by the manufacturer.
12. Use only with cart, stand, tripod, bracket, or table specified by the manufacturer or sold with the apparatus. When a cart is used, use caution when moving the cart/apparatus combination to avoid injury from tip-over.
13. Unplug this apparatus during lightning storms or when unused for long periods of time.

Important Safety Precautions

Safeguards

14. Refer all servicing to qualified service personnel. Servicing is required when the apparatus has been damaged in any way, such as when the power-supply cord or plug is damaged, when liquid has been spilled or when objects have fallen into the apparatus, or when the apparatus has been exposed to rain or moisture, does not operate normally, or has been dropped.



S3126A

15. **POWER SOURCE:** This TV should be operated only from the type of power source indicated on the marking label. If you are not sure of the type of power supply to your home, consult your appliance dealer or local power company. For TVs intended to operate from battery power, or other sources, refer to the operating instructions.

16. **POWER CORD PROTECTION:** Power-supply cords should be routed so that they are not likely to be walked on or pinched by items placed upon or against them, paying particular attention to cords at plugs, convenience receptacles, and the point where they exit from the appliance.

17. **OUTDOOR ANTENNA GROUNDING :** If an outside antenna or cable system is connected to the TV, be sure the antenna or cable system is grounded to provide some protection against voltage surges and built-up static charges. Section 810 of the National Electrical Code, ANSI/NFPA NO.70, provides information with respect to proper grounding of the mast and supporting structure, grounding of the lead-in wire to an antenna discharge unit, size of grounding conductors, location of antenna discharge unit, connection to grounding electrodes, and requirements for the grounding electrode. (Fig.A)

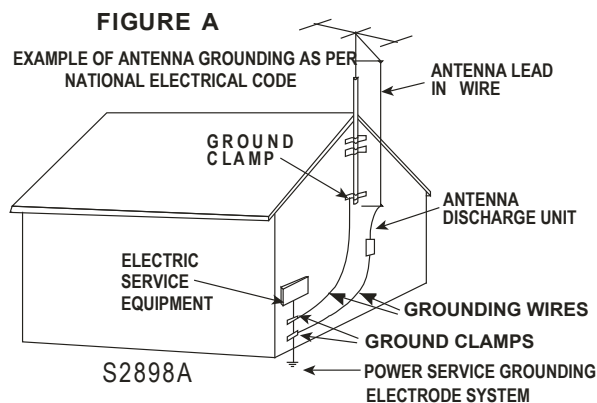

18. **LIGHTNING:** For added protection for this TV receiver during a lightning storm, or when it is left unattended and unused for long periods of time, unplug it from the wall outlet and disconnect the antenna or cable system. This will prevent damage to the TV due to lightning and power line surges.

19. **POWER LINES:** An outside antenna system should not be located in the vicinity of overhead power lines, or other electric light or power circuits, or where it can fall into such power lines or circuits. When installing an outside antenna system, extreme care should be taken to keep from touching such power lines or circuits as contact with them might be fatal.

Important Safety Precautions

Safeguards

20. **OVERLOADING:** Do not overload wall outlets and extension cords as this can result in a risk of fire or electric shock.
21. **OUTDOOR USE:** Do not install this TV outdoor. If the TV is exposed to rain, it may result in a fire or an electric shock. If the TV is exposed to direct sunlight, the TV may heat up and cause damage to the TV.
22. **VEHICLE:** Do not install the TV in a vehicle. Bumping of the vehicle may cause the TV to fall down and cause injury.
23. **SHIP AND VESSEL:** Do not install this TV in a ship or vessel. If the TV is exposed to seawater, it may cause a fire or damage the TV.
24. **OBJECT AND LIQUID ENTRY:** Never push objects of any kind into this TV through openings as they may touch dangerous voltage points or short out parts that could result in fire or electric shock. Never spill liquid of any kind into the TV.
25. **SERVICING:** Do not attempt to service this TV yourself as opening or removing covers may expose you to dangerous voltage or other hazards. Refer all servicing to qualified service personnel.
26. **REPLACEMENT PARTS:** When replacement parts are required, be sure that the service technician uses replacement parts with the same characteristics as the original parts specified by the manufacturer. Unauthorized substitutions may result in fire, electric shock, injury to persons or other hazards.
27. **SAFETY CHECK:** Upon completion of any service or repairs to this TV, ask the service technician to perform routine safety checks to determine that the TV is in proper operating condition.
28. The apparatus should not be exposed to any dripping or splashing, and no objects filled with liquids (such as a vase) should be placed on the apparatus.
29. **WARNING:** Plug the power cord into a power outlet where access to the power cord connector is readily accessible, in case if the power needs to be immediately disconnected.
30. **ATTENTION:** This device complies with Part 15 of the FCC Rules. Operation is subject to the following two conditions: (1) this device may not cause harmful interference, and (2) this device must accept any interference received, including interference that may cause undesired operation.
 - a). **Disposal of packaging:**The packaging of this product is intended to be recycled. Apply to the local authorities for correct disposal.
 - b). **Disposal of batteries:** The batteries supplied do not contain the heavy metals mercury and cadmium. Please check on how to dispose exhausted batteries according to local regulations.
 - c). **Note Specifications and information are subject to change without notice.** If you need further assistance, please call the customer support service in your country.
31. **POWER-CORD INSERT CHECK:**When connecting the power cord to the connector of the TV, make sure the power cord is fully inserted in the place. Bad contact may cause high temperature of the connector and the risk of fire or other damages.

Important Safety Precautions

Safety Strap

CAUTION



Tipping, shaking or climbing on the TV may cause the TV to fall. Don't allow children to climb or play with the TV. Care should be taken to place or install the TV where it can not be pushed, pulled over or knocked down. Always place the TV on a sturdy, level, stable surface that can hold the weight of the TV.

To secure TV to stand or Wall, use hardware listed below (Not Supplied)

1. Attach the wall anchor on the stand.
 2. Tie the ropes or chains with TV pedestal screws.
Ropes or chains should be secure tightly.
 3. Fasten the anchor bolts into top wall-mount holes.
 4. Attach the wall anchors on the wall strong enough to support the weight of the TV. (Attach to the Wall Stud).
 5. Make sure to connect anchor bolts to wall anchors.
- Anchor bolt – M6 x 10mm (42" and 47") or M6x 16mm(55")

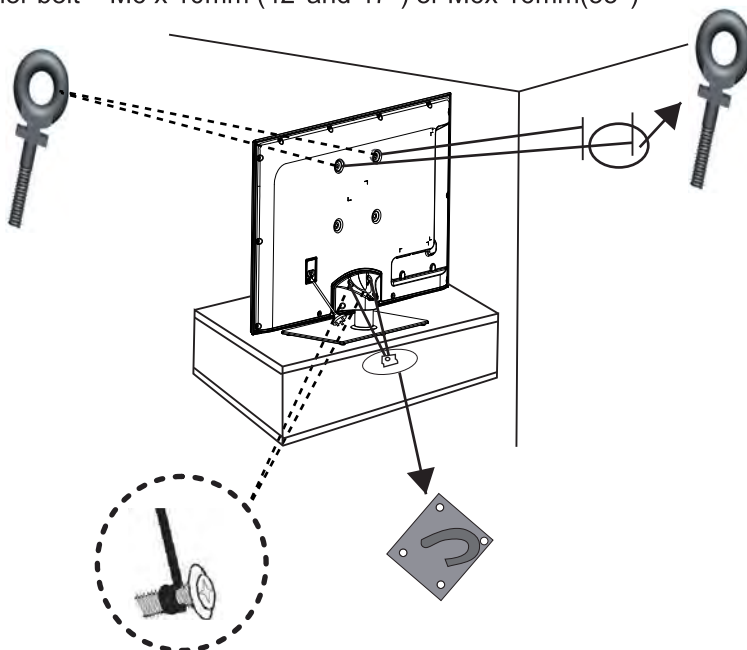

6. Check that all connections are properly secured. Periodically check for any sign of fatigue or failure. If you have any doubt about the security of your connections, contact a professional installer.

Table of Contents

Table of Contents

1.Important to user.....	i
2.Important safety precautions.....	ii
Safeguards.....	ii
Safety Strap.....	V
3.Table of Contents.....	6
4.Setting Up.....	7
Installing the Stand.....	7
Wall mount specifications.....	7
Wall mount.....	8
TV Front.....	10
TV Rear.....	11
Connect to other devices.....	12
5.Using the Remote Control.....	15
Installing the remote control batteries.....	15
Learning about the Remote Control Panel.....	16
Quick starts.....	17
6.Changing the TV Settings.....	19
Using the TV Menu.....	19
Using the Video Menu.....	20
Using the Audio Menu.....	22
Using the Setup menu.....	23
Using the Parental menu.....	26
7.Appendix.....	29
Trouble shooting.....	29
Specifications.....	30

Installing the Stand/Wall mount specifications

Installing the Stand

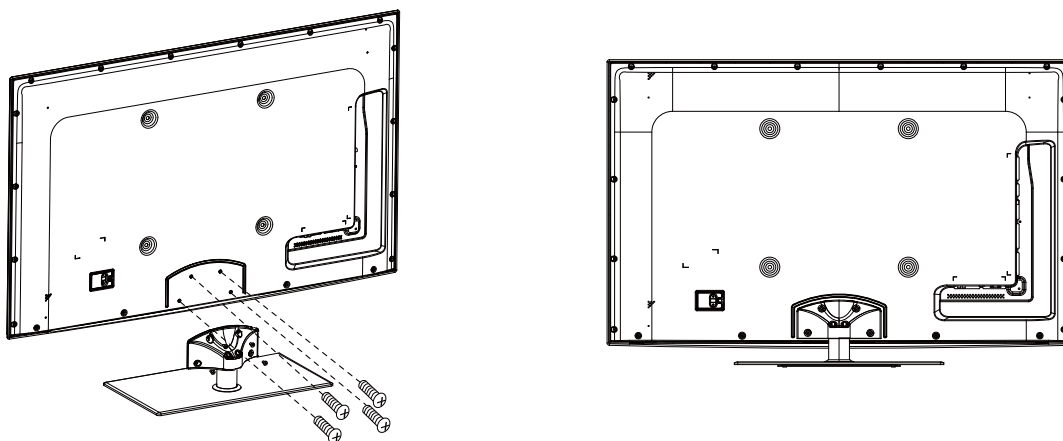

1. Lay a cloth or another soft material on a flat surface to avoid damage to the LCD screen.
2. Put the TV back upward and the LCD screen downward and keep it flat on the table-board.
3. Take out the stand and insert the stand into the installing slot in the lower part of the TV, then put the stand to relevant position of the TV set until all the holes match each other completely.
4. Fasten the stand and the TV set together with the 4 screws provided. Erect the TV set, and put it on the proper position for watching.

Note:

The above figures are for reference only, please refer to the actual units to determine the appearances. Every hole of the stand must be fastened with screws!

Wall mount specifications

Install your wall mount on a solid wall perpendicular to the floor. When attaching to other building materials, please contact your nearest dealer. If installed on a ceiling or slanted wall, it may fall and result in severe personal injury.

- Dimensions for wall mount kits and wall-mount screws pattern please refer specifications table.
- Do not use screws longer than the standard dimension, as they may cause damage to the inside of the TV set.
- For wall mounts that do not comply with the VESA standard screw specifications, the length of the screws may differ depending on their specifications.
- Do not use screws that do not comply with the VESA standard screw specifications.
- Do not fasten the screws too strongly, this may damage the product or cause the product to fall, leading to personal injury.
- Manufacturer is not liable for product damage or personal injury when a non-VESA or non-specified wall mount is used or the consumer fails to follow the product installation instructions.
- Do not exceed 15 degrees tilt when mounting this TV.

Setting Up

Wall mount

Wall-mounting Bracket Installation

	LED42A55RS	LED47A55RS
Unit Dimension(Unit:mm)	200×200	200×200
Screw Diameter	M6	M6
Screw Length(Unit:mm)	25	25

NOTE: *Wall mount bracket is not included with TV and mounting of wall mount bracket to wall may vary depending on brand and size of bracket. Customer should consult bracket mounting instructions that came with wall mount for specific information on how to mount bracket to wall.*

Removing TV Stand

1. Cover the surface of the table with soft cloth to avoid damage to LCD panel.
2. Lay the TV on a plane table which could bear a weight enough.
3. Remove the 4 bolts fixing the stand and remove the stand from TV.

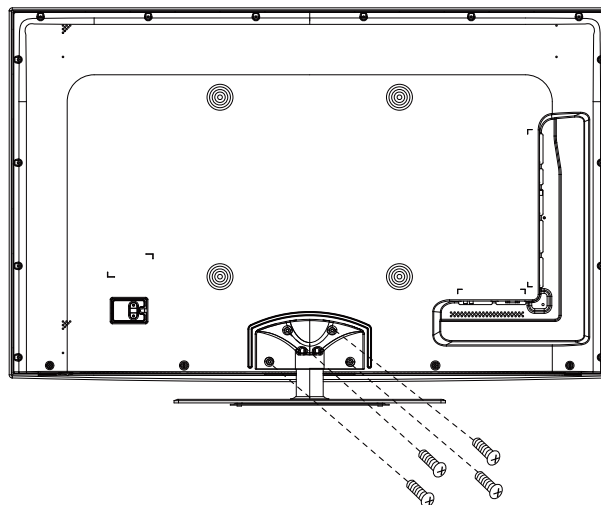

Before reading the installing instruction, please notice:

- A. The wall mount is not contained in the accessories sold with television. We only provide the installing specifications but not the wall mount itself. If you need the mount, please consult with the local dealer for the assorted fitting parts.
- B. We strongly suggest to set the wall mount with equipments of specification we ordered. If not, inappropriate installing may cause damage to both the device and yourself.

Setting Up

Wall mount

When Installing the TV Against a Wall or Enclosed Area

Make sure that your TV has adequate air circulation. Allow enough space around the TV as shown below. Avoid operating the TV at temperatures below Inadequate air 45° F (5°C)

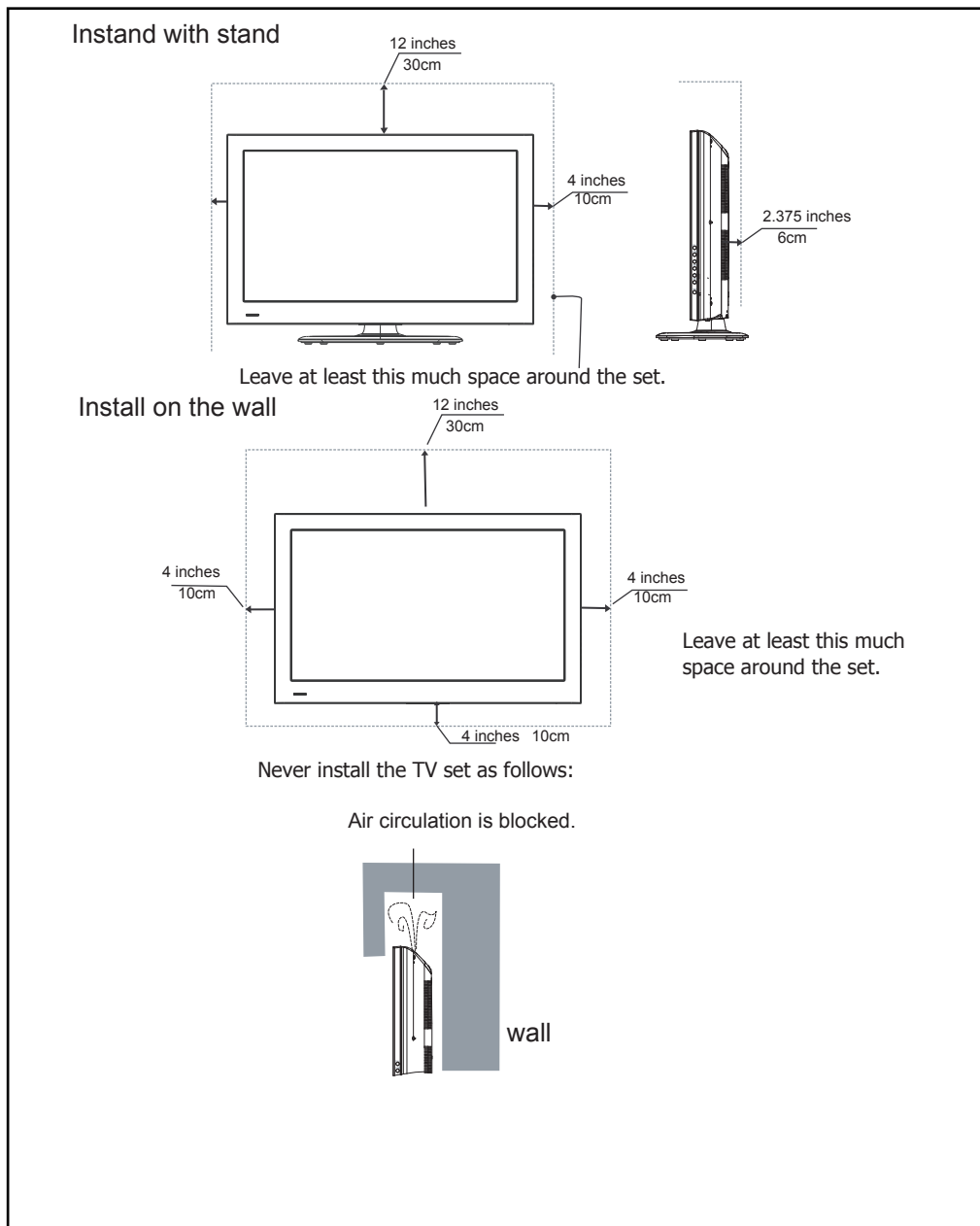

Inadequate air circulation can lead to overheating of the TV and may cause damage to your TV or cause a fire.

Setting Up

TV Front

TV Front

Model Number
LED42A55RS
LED4755ARS

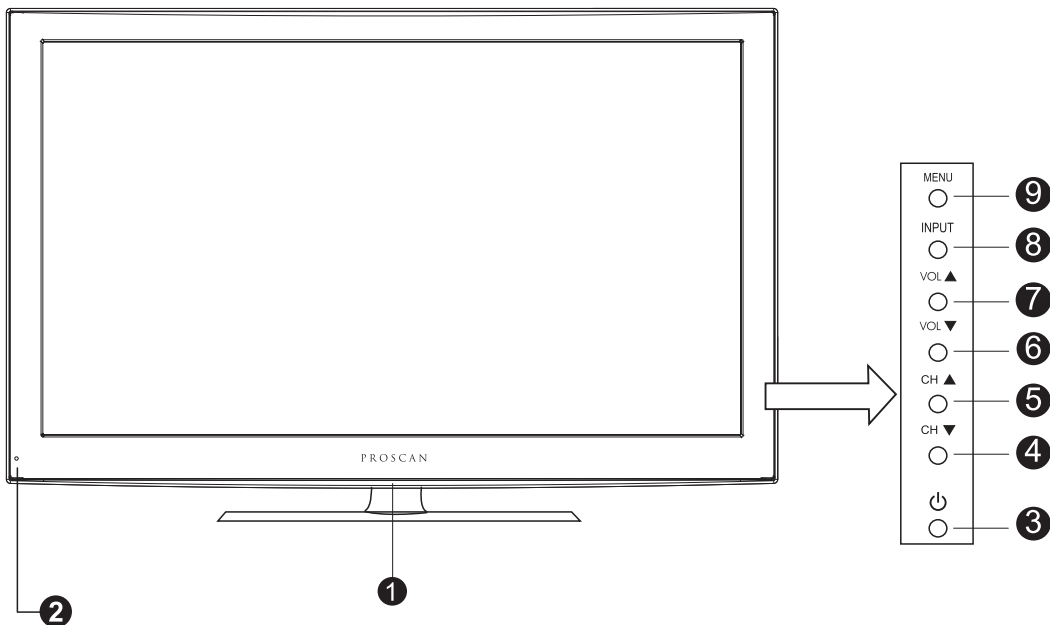

Note: Touch the silk print area according to the need, the TV will response correctly.

No.	Component	Component Description
1	POWER Indicator	Blue light indicates standby mode. Flashing led shows the unit is powering on. The light is off when TV is turned on.
2	Remote sensor	Receives signals from the remote control. Do not block.
3	Standby button	Press to turn your TV on or off(Standby mode)
4	CH ▼	Press to go to the previous channel.
5	CH ▲	Press to go to the next channel.
6	VOL ▼	Press to decrease the volume.
7	VOL ▲	Press to increase the volume.
8	Input	Press to select the signal source for your TV.
9	MENU	Press to activate the on-screen display (OSD).

Setting Up

TV Rear

TV Rear

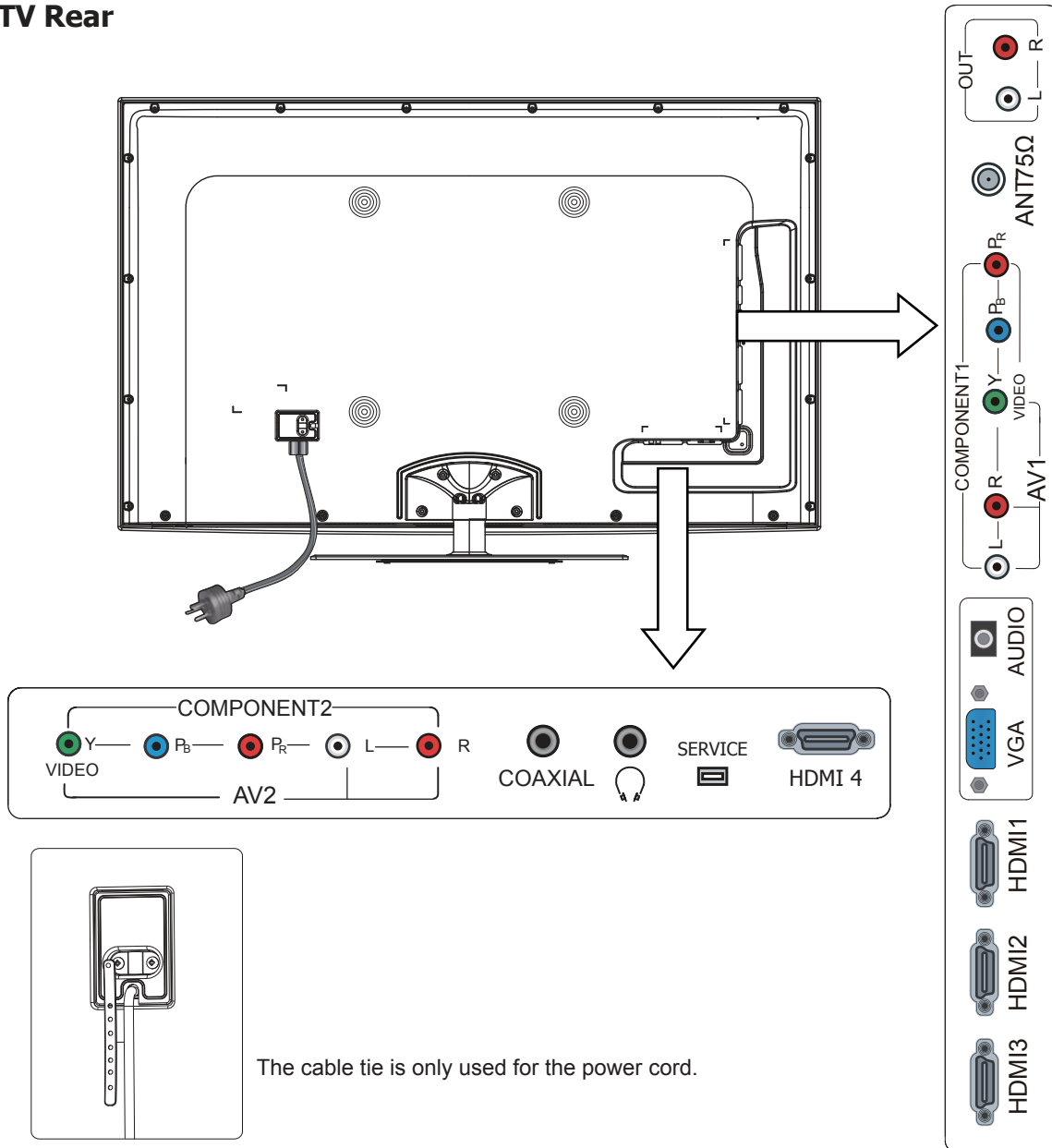

Note: The appearance of LED42A55RS, LED47A55RS are similar, the picture above is for reference only.

Setting Up

Connect to other devices

Warning: Before connecting the TV to any other electronic device, unplug the TV and electronic device AC cords from the AC input.

Note: Not all following terminals are included on your TV. The actual one refer to "TV Rear".

1. Connect to broadcast antenna or the cable TV

To have an optimal picture quality, it is strongly recommended to have an external antenna or a cable TV.

Note:

- It is recommended that coaxial cable (75Ω) be used to eliminate the interference caused by the mismatched impedance.
- The antenna cable should not be bound together with the power cord.
- When using the cable TV, please insert the plug of the coaxial cable (75 Ω) directly into the antenna outlet.

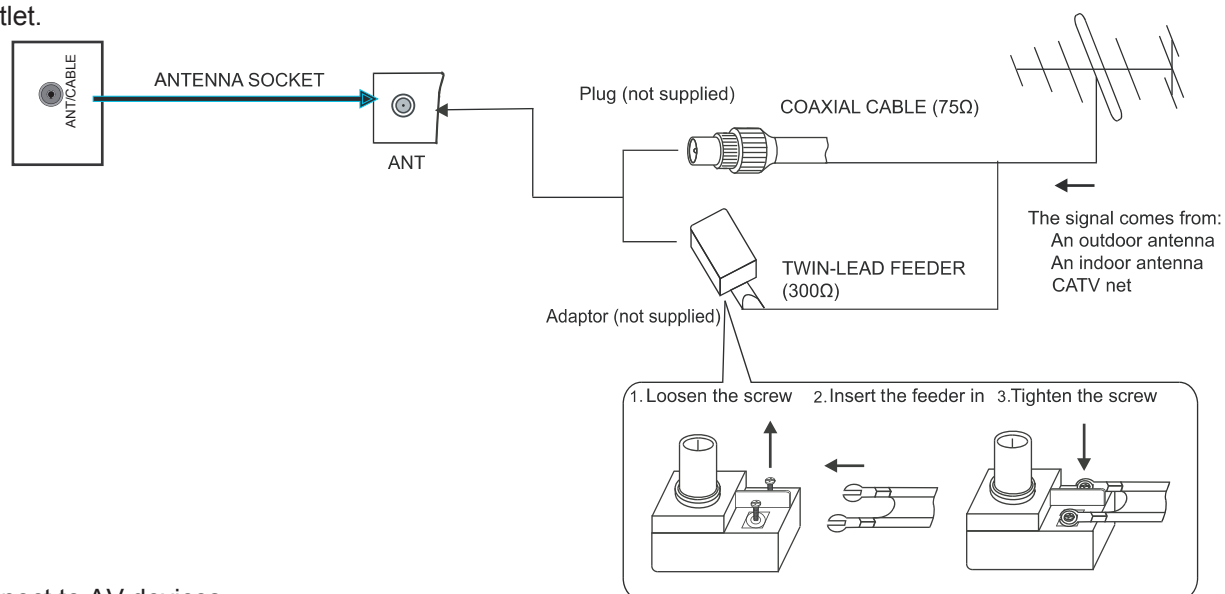

2. Connect to AV devices

- Connect a Video RCA cable to an appropriate external A/V device such as a VCR, DVD or Camcorder.
- Connect RCA audio cables to "R -AUDIO - L" on your set and the other ends to corresponding audio out connectors on the A/V device.

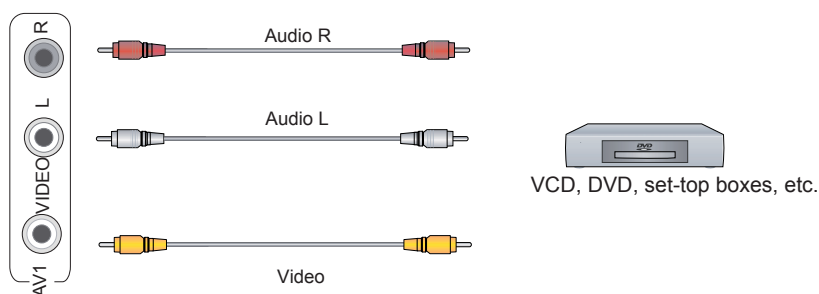

Setting Up

Connect to other devices

3. Connecting Component Devices (DVD, DVR (digital video recorder), Blu-Ray) Component video(Y, Pb, Pr)transmits video as separate Y, Pb, Pr signals. Use this connection for high-definition video signals from a DVD or other equipment.
- Connect Component video and audio cables to Component inputs ("PR/CR", "PB/CB", "Y") of your set and the other ends to corresponding component video out connectors on the PVR or DVD.
 - The "Y, PB/CB and PR/CR" connectors on your component devices ((DVD, DVR (digital video recorder), Blu-Ray) are sometimes labeled Y, B-Y and R-Y or Y, CB and CR. (Colors for inputs and cables must correspond on both devices.)

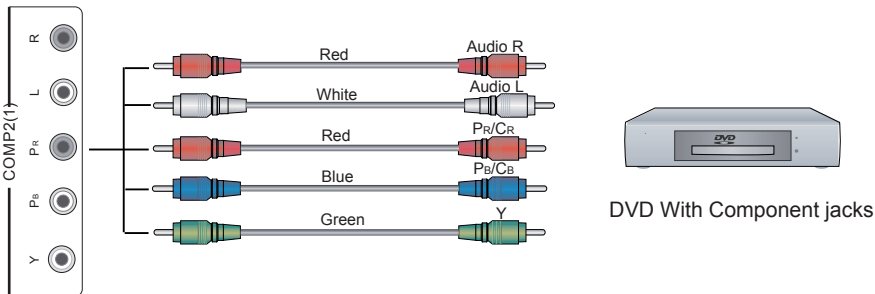

4. Connect to devices with HDMI interface

HDMI: High Definition Multimedia Interface

HDMI transmits an all-digital signal and is the recommended choice for playback from a digital DVD or DVR. No sound connection is needed for HDMI to HDMI connection.

- HDMI cable connected to the HDMI connector on the TV.



Setting Up

Connect to other devices

5. Connect to PC

- Connect the D-Sub cable to "VGA" on the side of your set and the other end to the Video Card of your computer.
- Connect the stereo audio cable to "PC AUDIO" on the side of your set and the other end to "Audio Out" of the sound card on your computer.

Note: For some sets "PC AUDIO" share with component.

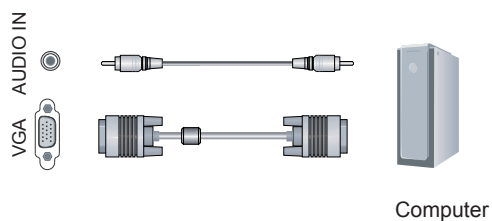

6. Connect to headphone

- Connect the headphone jack of the TV set.
- The volume of the headphone is automatically adjusted with the main volume of the TV set.

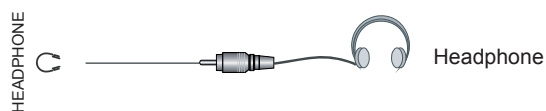

Using the Remote Control

Installing batteries

Installing the remote control batteries

1. Open the battery cover on the back of the remote control.
2. Install two AAA size(1.5V) batteries. Match the “+” and “-” signs on the batteries to the signs on the battery compartment.
3. Close the battery cover.



Note:

1. Dispose of your batteries in a designated disposal area. Do not throw the batteries into fire.
2. Do not mix battery types or combine used batteries with new ones.
3. Remove depleted batteries immediately to prevent battery acid from leaking into the battery compartment.
4. If you do not intend to use the remote control for a long time, remove the batteries.
5. The effective range of remote control is suggested below.

Remote control range

1. The remote control distance: 8 meters(26.2 feet) in front of the TV set.
2. The remote control angle: taking the television infrared light receiver window as an apex, 6 meters (19.7 feet) away, its controlled angle (left to right) is within 30 degrees, while the vertical angle (up to down)is within 30 degrees.

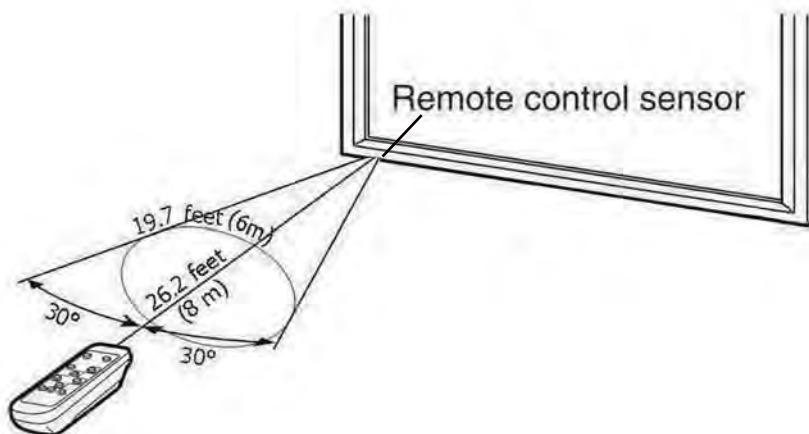

Using the Remote Control

Learning about the remote control panel

Remote Control Panel

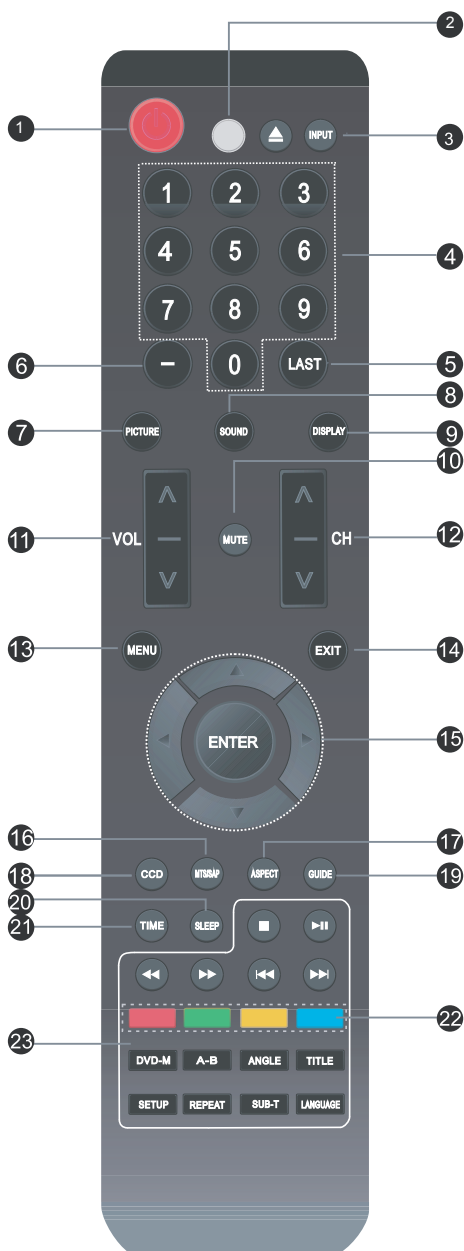

Buttons instructions

- (1) Power On/Off.
- (2) Power indicator.
- (3) INPUT: Switch among TV, Video, Component, HDMI and VGA.
- (4) 0-9 Numbers: For direct channel access.
- (5) Last: Return to previous channel.
- (6) — : Select digital channels.
- (7) PICTURE: Picture Mode selecting.
- (8) SOUND: Sound Mode selecting.
- (9) DISPLAY: Display current status information.
- (10) MUTE: Mute the sound.
- (11) VOL ▲/▼: Volume increase/Volume decrease.
- (12) CH ▲/▼: Next channel/Previous channel.
- (13) MENU: Display the main menu/Back menu display.
- (14) EXIT: On screen display (OSD) menu exit.
- (15) ENTER: Enter or confirm the operation/return to the previous menu.
▲/▼/◀/▶: Up/Down/Left/Right operation.
- (16) MTS/SAP: Choose stereo, mono or Separate Audio Program (SAP broadcast).
- (17) ASPECT: Select screen mode.
- (18) CCD: Closed caption decoder function.
- (19) GUIDE: ATSC tuners feature the Electronic Program Guide (EPG) function.
- (20) Sleep: Set the sleep timer.
- (21) TIME: Display the current timer.
- (22) Electronic Program Guide(EPG) function: After pressing the "GUIDE" button in the digital TV channel option, the 4 same color buttons will appear with explanations in the OSD. Follow the steps illustrated in the OSD.
- (23) NOT supported in this TV. These buttons are for DVD Combo TV.

Note: The design of the remote control is subject to change and may be different from the actual one. Those buttons without comment have no relations with this TV.

Using the Remote Control

Quick starts

Basic Operation

Connecting power cord to the TV

1. Connect the power cord to the connector on the back of the TV, if the power cord in accessories.
Note: When connecting the power cord to the connector of the TV, make sure the power cord is fully inserted in the place. Bad contact may cause high temperature of the connector and the risk of fire or other damages.
2. Connect the power cord to the AC power outlet.

Power ON/OFF

1. Connect the TV to a power outlet. If the power indicator is blue, it means that the TV is STANDBY. Press the Standby button on the front control or on the remote control to turn the TV on. Once the TV is turn on, the power indicator will be turned off. Several seconds later, the TV picture will be displayed on the screen.
2. Press the Standby button on the front control or on the remote control to turn the TV off temporarily.
3. Always remove the AC power plug from the outlet when not using this TV for a long period of time.

Signal source selection

Press the [INPUT] button to select TV, AV, Component, VGA and HDMI inputs. There are two ways to select the source: One is to press the [INPUT] button continuously, while the other is to use the ARROW and [ENTER] buttons to confirm the source.

Select channels

Please use [CH \wedge / CHV] button on the remote panel to select channels. [CH \wedge] indicates channel number up; [CHV] indicates channel number down. Press [CH \wedge / ChV] button on the side panel of the TV to select the channels. If you want to choose any of the skipped channels, press the number directly.

Use [Mute] button

Press the [Mute] button to mute the sound. Press the [Mute] button again to resume the sound.

Select picture modes

Press the [PICTURE] button to select the picture mode from four options: Standard, Cinema, User or Vivid. You can adjust the picture mode based upon your personal preference.

Select sound modes

Press the [AUDIO] button to select sound modes from Standard, Speech, User or Music.

Select screen modes

Press the [ASPECT] button to select from six zoom modes: Wide, Normal, Zoom, Cinema, Dot-to-Dot or Auto.

Use [GUIDE] button

Press the [GUIDE] button to display features of the ATSC program and the EPG function.

Use [DISPLAY] button

Press the [DISPLAY] button to view current source information.

Using the Remote Control

Quick starts

Use [EXIT] button

Press the [EXIT] button to exit the OSD menu.

Select channels by numbers

To select a channel: Press the channel number you would like to go to. For example, to select channel number 120, press buttons 1, 2 and 0, respectively and then press [ENTER] to confirm.

Use [MENU] button

Press the [MENU] button to display the TV OSD menu.

Use [LAST] button

Press the [LAST] button to return to the previous channel.

Use [ENTER] button

Press the [ENTER] button to select a particular item.

Adjust Volume

Press [VOLA / VOLV] button to adjust the volume.

Use [CCD] button

Press the [CCD] button to change the CCD mode. Using this button will set the Closed Caption mode when viewing a DTV or TV channel.

Note: Set the default Closed Caption setting for all channels in the Menu. For ATV the options are CC1, CC2, CC3, CC4, TEXT1, TEXT2, TEXT3, TEXT4 or Off. For DTV, the options are from Service1 to Service6 or Off.

Use [MTS/SAP] button

Press the [MTS/SAP] button to change the sound mode (Mono, Stereo, SAP). This button will select the MTS options of Stereo, SAP, or Mono in TV mode, alternate audio channels, and when available, in DTV mode.

Use [SLEEP] button

Press the [SLEEP] button repeatedly to set the sleep time, which can be set to: 10 Mins, 20 Mins, 30 Mins, 40 Mins, 50 Mins, 60 Mins, 90 Mins, 120 Mins or Off.

Use [TIME] button

Press the [TIME] button to display the current time.

Changing the TV Settings

Using the TV Menu

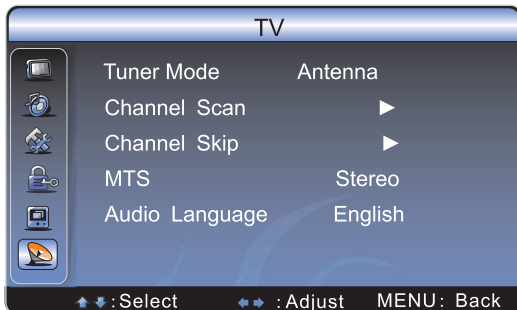

- 1 Press [MENU] button to display the main menu.
- 2 Press [▲/▼] button to select TV item.
- 3 Press [▶/ENTER] button to enter TV menu.
- 4 Press [▲/▼] button to select the option, press [▶/ENTER] button to enter or press [◀/▶] button to adjust the option.
- 5 Press the [Menu] button to close the menu.

You can adjust:

- Tuner Mode – Select the TV signal source. You can select Antenna or Cable.
- Channel Scan – Scans for channels that have signals and stores the channels information in memory.

DTV: The scanned TV programmes in digital signals.

TV: The scanned programmes in analog signals.

- Channel Skip – Deletes a channel stored in memory. When you press CH Δ or CHV, your TV skips the channel you deleted. You can still tune to the channel using the number buttons on the remote control.
- MTS – Selects the sound mode. You can select Mono, Stereo, or SAP (Second Audio Program)
- Audio Language – Selects the audio language for a program.

SAP (Second Audio Program) – Depending on the particular program being broadcast, you can listen to a foreign-language translation.

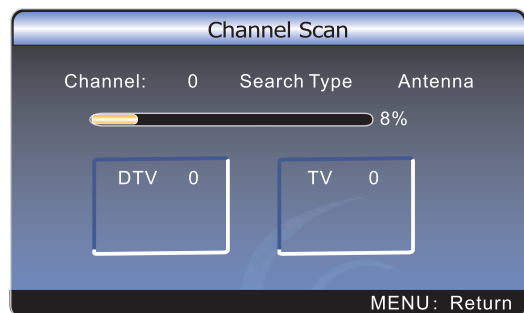

Changing the TV Settings

Using the Video Menu

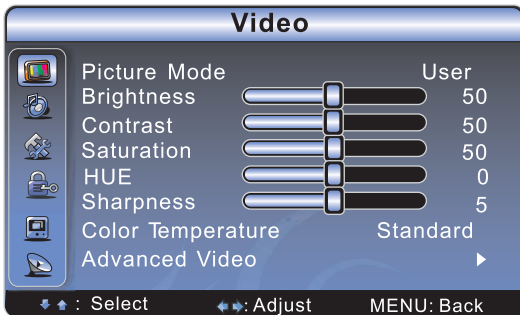

- 1 Press [MENU] button to display the main menu.
- 2 Press [▲/▼] button to select Video item.
- 3 Press [▶/ENTER] button to enter Video menu.
- 4 Press [▲/▼] button to select the option, press [▶/ENTER] button to enter or press [◀/▶] button to adjust the option.
- 5 Press the [Menu] button to close the menu.

You can adjust:

- Picture Mode – Adjusts the Picture Mode. You can select Standard, Cinema, User or Vivid.
- Brightness – You can increase or decrease the brightness of the picture. Increasing the brightness can add more light to dark areas of the picture, while decreasing the brightness can add more darkness to light areas of the picture.
- Contrast – You can increase or decrease the contrast of the picture. Increase the contrast to adjust the white areas of the picture or decrease the contrast to adjust the black areas of the picture.
- Saturation – Adjusts the intensity of the colors.
- Sharpness – You can increase the sharpness level for clearer images or decrease the sharpness level for smoother images.
- Color temperature – Changes the color temperature. You can select the color temperature from three options: Cool, Standard or Warm.
- Advanced Video – Accesses advanced video settings such as DNR, Adaptive Luma Control, Flesh Tone and MFC.

- ◇ DNR: It can optimize the picture signal from time and space; reduce the outside noise interference and return the pure initial signal. It has four ratings: Low, Standard, Strong and Off.
- ◇ Adaptive Luma Control: According to the content of picture, it can adjust brightness automatically.
- ◇ Flesh Tone: When this feature is "on" state, the TV could be the basis of image content, for color correction.



Changing the TV Settings

Using the Audio Menu

- ◇ MFC: To improve the perception of moving images. The weak setting is suitable for most programs and is recommended for general viewing. normal and strong settings can further enhance motion, however on some cases can create a halo effect on edges of moving objects. You may need to switch settings pending the contents your viewing.

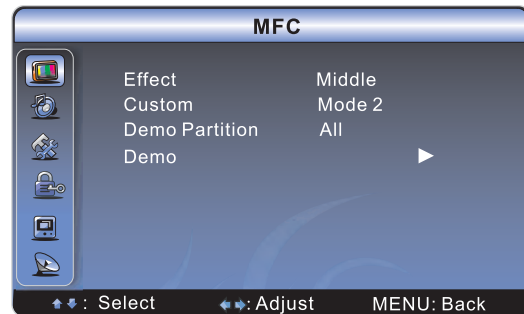

RCA using MFC's unique motion compensation technology, which eliminates the tail and jitter of dynamic images effectively, and makes the image edge clearer. It reduce the dynamic screen blur which is difficult to be perceived by human eyes. Even playing rolling subtitles, the font edge is also clear.

Effect - Removes drag from fast scenes with a lot of movement to provide a clearer picture.
If you enable MFC (Motion Flow Compensation), noise may appear on the screen.
If this occurs, set "Effect" to off.

Custom : The TV can be set to automatically sense and process film signals from all sources and adjust the picture for optimum quality.
- Mode 1 : Adjusts the judder reduction level from video sources when playing 24Hz films.
- Mode 2 : Adjusts the blur reduction level from video sources.

Demo Partition - Press [◀/▶] buttons to choose left, right or all in the screen for MFC Demo.

Demo - This is only intended for use in retail environments.

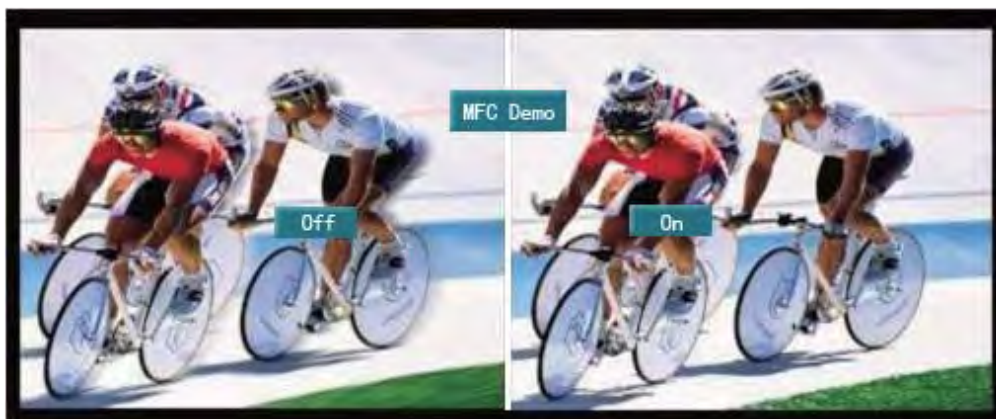

Changing the TV Settings

Using the Audio Menu

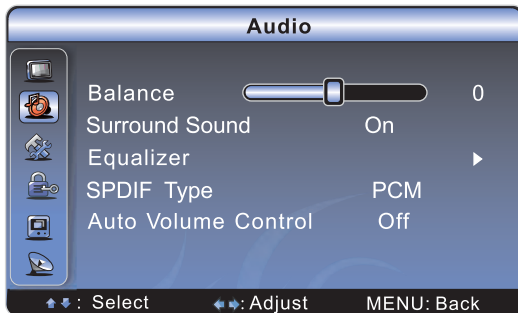

- 1 Press [MENU] button to display the main menu.
- 2 Press [▲/▼] button to select Audio item.
- 3 Press [▶/ENTER] button to enter Audio menu.
- 4 Press [▲/▼] button to select the option, press [▶/ENTER] button to enter or press [◀/▶] button to adjust the option.
- 5 Press the [Menu] button to close the menu.

You can adjust:

- Balance – Adjusts the volume of the left and right speakers.
- Surround Sound – Turns the surround sound effect on or off.
- Equalizer – Weaken or enlarge the sound of the main frequency points.
- SPDIF Type – Selects the SPDIF type. You can select PCM, Dolby Digital or Off.

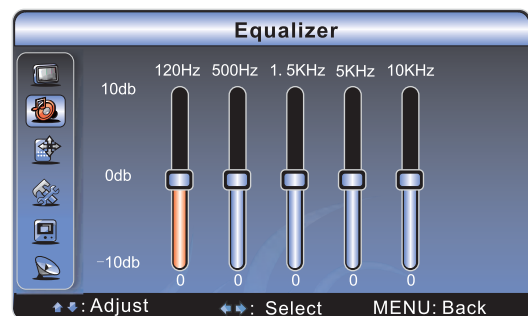

PCM - PCM is an encoding, mainly used for analog signal, Dolby mainly used for digital signal.

Dolby - when the data stream carries Dolby signal, digital SPDIF outputs Dolby data stream. When the data stream carries no Dolby signal, it transports PCM data stream.

Auto - when the data stream carries Dolby signal, digital SPDIF outputs Dolby data stream. When the data stream carries no Dolby signal, it transports PCM data stream. No matter the data stream carries Dolby stream or not, it outputs PCM data stream.

- Auto Volume Control – Adjust volume according to different audio signal.

Note: Via SPDIF Type, you can choose the digital audio out type. If Auto Volume Control is On, that means audio out control is activated.

Changing the TV Settings

Using the Setup Menu

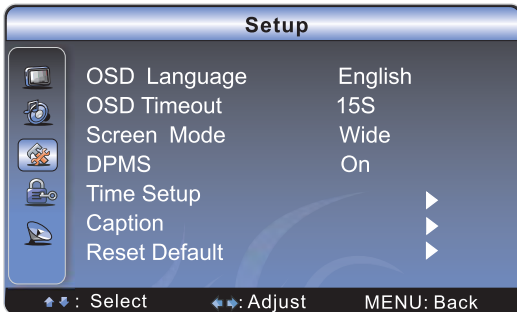

- 1 Press [MENU] button to display the main menu.
- 2 Press [▲/▼] button to select Setup item.
- 3 Press [▶/ENTER] button to enter Setup menu.
- 4 Press [▲/▼] button to select the option, press [▶/ENTER] button to enter or press [◀/▶] button to adjust the option.
- 5 Press the [Menu] button to close the menu.

You can adjust:

- OSD Language – Use the right or left arrow button to choose the OSD Language among English, Spanish and French.
- Screen Mode – Use the arrow button to choose the screen aspect ration from Wide, Normal, Zoom, Cinema, Dot-to-Dot or Auto.

1 Normal

The original 4:3 aspect ratio (1.33:1 signal) is preserved, so black bars are added to the left and right of the image. Standard TV broadcasts are displayed with a 4:3 aspect ratio.

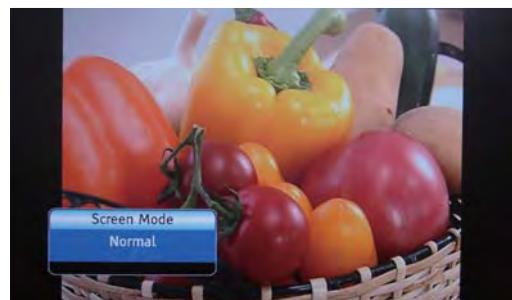

2 Wide

When watching a standard broadcast or full-frame movie in this mode, the display image is stretched proportionately to fill the TV screen.

When watching a widescreen (1.78:1 signal) program or movie, the display image fills the TV



3 Zoom

Stretches the 4:3 aspect ratio image vertically and horizontally to fill the screen at 1:1.78 aspect ratio.



Changing the TV Settings

Using the Setup Menu

- 4** Cinema
Stretches the 4:3 aspect ratio image vertically and horizontally to fill the screen at 1:2.35 aspect ratio.



- 5** Dot to dot
Use the function to see the full image without any cutoff, when HDMI (720p/1080i/1080p), Component (1080i/1080p), DTV (1080i) or VGA signals are inputs.



- DPMS – This is a good function for a computer monitor. When DPMS is on, the computer will control the screen on or off. For example, if the computer is in sleep mode, the screen will be switched off. If the computer is activated, the screen also is activated.
- Time Setup – You can set up the exact time by yourself. You can also set up Sleeper Time and Auto Sleep Time.

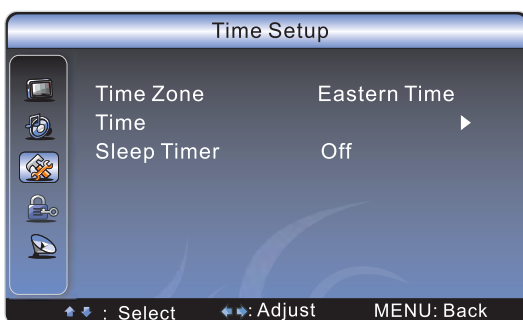

Changing the TV Settings

Using the Setup Menu

- Caption: There are three items in it – Analog Closed Caption, Digital Closed Caption and Digital Caption Style.

This is a function about caption, display caption by analog signal and display caption by digital signal.

Analog Closed Caption: CC1, CC2, CC3, Cc4,
TEXT1, TEXT2, TEXT3, TEXT4.

Digital Closed Caption: Service1, Service2, Service3,
Service4, Service5, Service6.

Digital Caption Style: There are two Caption Styles. One is the automatic function set as the broadcaster, while the other is the custom style where you can adjust the font size, color, opacity, background color etc. , accordingly.

- Reset Default – Every TV has its original setting before leaving the factory. So this function helps you restore these settings.

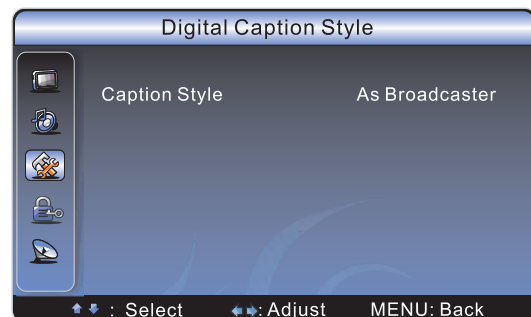
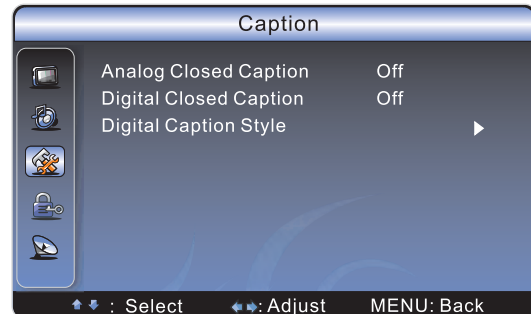

Changing the TV Settings

Using the Parental Menu

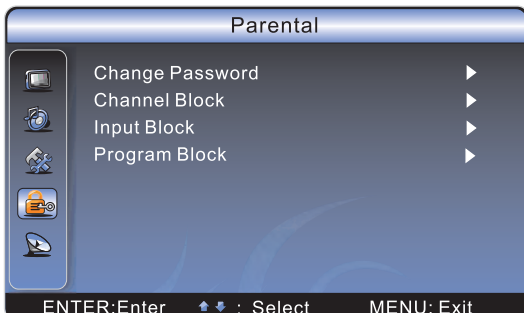

- 1 Press [MENU] button to display the main menu.
- 2 Press [▲/▼] button to select Parental item.
- 3 Press [▶/ENTER] button to enter Parental menu.
- 4 Press [▲/▼] button to select the option, press [▶/ENTER] button to enter or press [◀/▶] button to adjust the option.
- 5 Press the [Menu] button to close the menu.

When you first use this function, the default password is [0000].

Once you input this password, you can: Press ▲/▼ to highlight an option, then press ◀/ ▶ to adjust the option. You can adjust:

- Change Password – The first time you use this function, use the default password. If you want to change it, first enter the new password then enter the same password again.
- Channel Block – This function will let you block any channel you want.
- Input Block – You can block the input source with this function. For example, if you want to block AV input, just highlight [AV] and press [ENTER]. The AV input will not be seen in the screen.
- Clean All – This function will let you clean all the channels stored on this TV.

Note: If you choose this function, all the programs you preset will be lost.

- Program Block–
 - A. Rating Enable is on.
 - B. U. S. TV Ratings: You can choose TV ratings according to the illustration on the screen.
 - C. The settings for U. S. Movie Ratings, Canada (English) Ratings and Canada (French) Ratings follow Step B.

If you want to block the unrated program, please turn on this function.

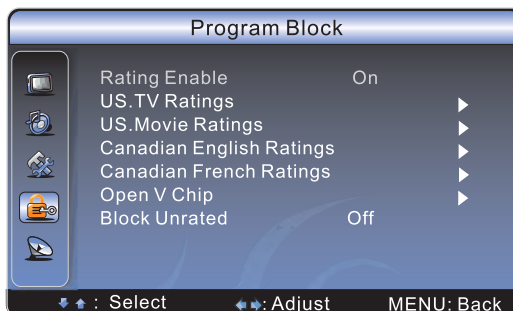
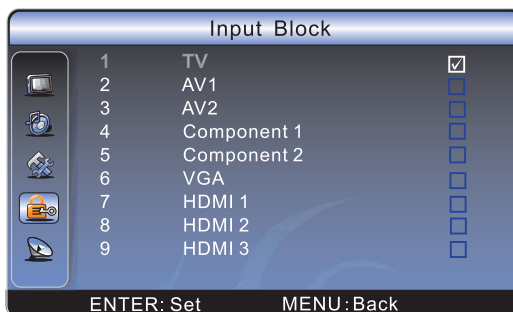
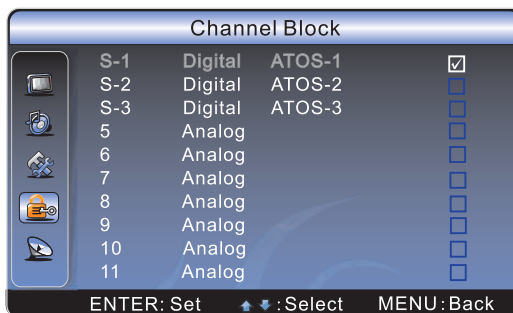

Changing the TV Settings

Using the Parental Menu

Following is the description of these ratings.

Age	Defined as
TV-Y	All children
TV-Y7	Directed to older children
TV-G	General audience
TV-PG	Parental Guidance suggested
TV-14	Parents Strongly cautioned
TV-MA	Mature Audience only

Contents	Defined as
FV	Fantasy Violence
D	Suggestive dialogue
L	Strong language
S	Sexual situations
V	Violence

Rating	Defined as
G	General audience
PG	Parental Guidance suggested
PG-13	Parents strongly cautioned
R	Restricted
NC-17	No one 17 and under admitted
X	Adult audience only

Changing the TV Settings

Using the parental Menu

About Canada (French)

Rating	Description
G	General
8 ans+	8+General; Not recommended for young children
13 ans+	Programming may not be suitable for children under the age of 13
16 ans+	Programming is not be suitable for children under the age of 16
18 ans+	Programming restricted to adults

About Canada (English)

Rating	Description
C	Children
C8+	Children eight years and older
G	General Programming, suitable for all audiences
PG	Parents Guidance
14+	Viewers 14 years and older
18+	Adult programming

NOTE: As you block rating, all rating higher than the ones you select are blocked as well. For example, if you choose to block the MPAA rating R, the higher ratings, NC-17 and X, are automatically blocked too .

Trouble shooting

Before calling a service technician, please check the following table for a possible cause of the problem and some solutions.

Customer important notice: If the TV can not be operated, please unplug the power and restart .

Symptoms	Possible Solutions
TV will not turn on	<ul style="list-style-type: none"> Make sure the power cord is plugged in, then press Power (Standby). The remote control batteries may be dead. Replace the batteries. Unplug the VGA wire and plug the power wire again.
No picture, no sound	<ul style="list-style-type: none"> Check if you have set the timer off. Check the antenna/cable connections. Press [Display] to see if you have selected the right signal source.
No sound, picture OK	<ul style="list-style-type: none"> The sound may be muted. Press [VOL+] on the remote control. The station may have broadcast difficulties. Try another channel. Check the speakers cable connections.
Poor sound, picture OK	<ul style="list-style-type: none"> The station may have broadcast difficulties. Try another channel Check the speakers cable connections.
Poor picture, sound OK	<ul style="list-style-type: none"> Check the antenna connections. The station may have broadcast difficulties. Try another channel. Adjust the picture from the menu.
Unable to select a certain channel	<ul style="list-style-type: none"> The channel may be skipped. Choose this channel by directly selecting the buttons from the remote control.
Poor colour or no colour	<ul style="list-style-type: none"> The station may have broadcast difficulties. Try another channel. Adjust Saturation in the Video settings menu.
The remote control does not operate	<ul style="list-style-type: none"> There may be an obstruction between the remote control and the remote control sensor. The batteries may be installed with a wrong polarity. The remote control batteries may be dead. Replace the batteries.
Disorder display at power on	<ul style="list-style-type: none"> This may be caused because of a very short interval between POWER OFF and ON. Unplug the power and restart.

Specifications

Model	LED42A55RS	LED47A55RS
Screen Diagonal Size	42 inches	47 inches
Screen Resolution	1920X1080 Pixels	1920X1080 Pixels
Power Consumption	165W	180W
Wall-mount screws pattern	M6X25mm (4 pcs)	M6X25mm (4 pcs)
Wall-mount dimension(VESA)	200mm X 200mm	200mm X 200mm
Size with base(inch)(L X WX H)	40.6×11.5×28.1	45×11.2×30.7
Weight with base(lbs)	44.2 lbs	56.1 lbs
Power Supply	AC 60Hz 120V	
Television System	American TV standard NTSC / ATSC system	
Audio multiplex	BTSC system	
Channel coverage	VHF: 2~13 UHF: 14~69 CATV: 1~125	
	Digital Terrestrial Broadcast (8VSB): 2~69	
	Digital Cable(64/256 QAM): 1~135	
Sound Output Power (RMS)	10W+10W	
Component (Y/Pb/Pr) mode	480I/60Hz, 480P/60Hz, 720P/60Hz, 1080I/60Hz	
PC (VGA) mode	640X480/60Hz, 800X600/60Hz,1024X768/60Hz	
HDMI mode	480I/60Hz, 480P/60Hz, 720P/60Hz, 1080I/60Hz, 1080P/60Hz	
	640X480/60Hz, 800X600/60Hz,1024X768/60Hz	
Environmental Conditions	Temperature 5°C~35°C (41F~95F)	
	Humidity : 20%-80%RH	
	Atmospheric pressure: 86kPa-106kPa	
Supplied accessories	Remote control, Batteries, User Manual, Quick Start Guide, Remote Control Guide, Children Safety Guide, Warranty Card, Registration Card	

Note: Design and specifications are subject to change without notice.

CUSTOMER NOTICE: Use carefully when operating to prevent damage to the screen.



SRS® restores the original three-dimensional sound field of stereo recordings by retrieving spatial information buried in the recordings to create an immersive 3D sound-field using only two speakers or headphones.



Manufactured under license from Dolby Laboratories.

Dolby and the double D symbol are trademarks of Dolby Laboratories.



Energy Star qualified TV



This product contains electrical or electronic materials. The presence of these materials may, if not disposed of properly, have potential adverse effects on the environment and human health. Presence of this label on the product means it should not be disposed of as unsorted waste and must be collected separately. As a consumer, you are responsible for ensuring that this product is disposed of properly. To find out how to properly dispose of this product, please go to www.proscanus.com and click on Sustainability.



This TV incorporates High-Definition Multimedia Interface (HDMI™) technology. HDMI, the HDMI logo and High-Definition Multimedia Interface are trademarks or registered trademarks of HDMI Licensing LLC.

Free Manuals Download Website

<http://myh66.com>

<http://usermanuals.us>

<http://www.somanuals.com>

<http://www.4manuals.cc>

<http://www.manual-lib.com>

<http://www.404manual.com>

<http://www.luxmanual.com>

<http://aubethermostatmanual.com>

Golf course search by state

<http://golfingnear.com>

Email search by domain

<http://emailbydomain.com>

Auto manuals search

<http://auto.somanuals.com>

TV manuals search

<http://tv.somanuals.com>