

RCA

USER'S GUIDE

highdefinitiontelevisionhighdefi
nitiontelevisionhighdefinitiontel
evisionhighdefinitiontelevisionhi
ghdefinitiontelevisionhighdefinit
iontelevisionhighdefinitiontelevi
sionhighdefinitiontelevisionhigh
definitiontelevisionhighdefinitio
ntelevisionhighdefinitiontelevi
onhighdefinitiontelevisionhighd
efinitiontelevisionhighdefinition
televisionhighdefinitiontelevi
nhighdefinitiontelevisionhighdef
initiontelevisionhighdefinitionte
levisionhighdefinitiontelevisionh
ighdefinitiontelevisionhighdefini
tiontelevisionhighdefinitiontelev
isionhighdefinitiontelevisionhigh
definitiontelevisionhighdefinitio
ntelevisionhighdefinitiontelevi
onhighdefinitiontelevisionhighd
efinitiontelevisionhighdefinition
televisionhighdefinitiontelevi
nhighdefini tiontelevi
sionhigh hdefiniti
ontelevi sionhigh
hdefi niti
ontelevi vi
sionhigh d
efinitio nte
levisio nte
levi si
on h



IMPORTANT INFORMATION

WARNING

To reduce the risk of fire or electric hazard, do not expose this product to rain or moisture.

WARNING

RISK OF ELECTRIC SHOCK DO NOT OPEN

To reduce the risk of electric shock, do not remove cover (or back). No user-serviceable parts inside. Refer servicing to qualified service personnel.



This symbol indicates "dangerous voltage" inside the product that presents a risk of electric shock or personal injury.



This symbol indicates important instructions accompanying the product.

Refer to the identification/rating label located on the back panel of your product for its proper operating voltage.

This device complies with part 15 of the FCC rules. Operation is subject to the condition that this device does not cause harmful interference. FCC Regulations state that unauthorized changes or modifications to this equipment may void the user's authority to operate it. Use of this device without the supplied power cord may cause this set to be non-compliant with FCC part 15 regulations.

If fixed (non-moving) images are left on the screen for long periods, they may be permanently imprinted on the screen. Such images include network logos, phone numbers, and video games. This damage is not covered by your warranty. Extended viewing of channels displaying these images should be avoided.

Cable TV Installer: This reminder is provided to call your attention to Article 820-40 of the National Electrical Code (Section 54 of the Canadian Electrical Code, Part 1) which provides guidelines for proper grounding and, in particular, specifies that the cable ground shall be connected to the grounding system of the building as close to the point of cable entry as practical.

PRODUCT REGISTRATION

Please fill out the product registration card and return it immediately. Returning the card allows us to contact you if needed.

Keep your sales receipt to obtain warranty parts and service and for proof of purchase. Attach it here and record the serial and model numbers in case you need them. The numbers are located on the back of the product.

Model No. _____

Serial No. _____

Purchase Date: _____

Dealer/Address/Phone: _____

TABLE OF CONTENTS

SETUP AND CONNECTIONS	5
Step 1: Unpack the System	6
Step 2: Connect Your TV to Other Components	6
Jacks and Cables	7
Front Buttons	8
Back of the TV	10
The Basic Connection	12
The Advanced Connection	13
Connecting Speakers to the TV	14
Connecting a Stereo Amplifier	15
Step 3: Place Batteries in the Remote Control	16
Step 4: Plug in and Turn on the System	16
Step 5: Complete the Interactive Setup	16
Step 6: Order Programming	16
USING THE REMOTE	17
Remote Control Buttons	18
Programming the Remote Control	20
Using the Remote to Control a Component	21
Remote Control Codes	22
BASIC TV OPERATION	23
About the Channel Banner	24
Changing Between DIRECTV and TV Mode	26
Changing Channels	27
PIP (Picture-in-Picture) Operation	28
PIP Buttons	28
Using the PIP Feature	28
PIP Problems?	29
Using the INPUT Button	30
USING THE PROGRAM GUIDES	31
Bringing Up the Program Guides	32
Anatomy of the TV Program Guide	33
Anatomy of the DIRECTV® Programming Guide	34
Tuning to a Program	35
Getting Around in the Guides	35
Using the GUIDE Button	36
The Other Guides Icon	36
Exiting A Program Guide	37

TABLE OF CONTENTS

Sorting the DIRECTV® Programming Guide	38
The Other Icons	42

ADJUSTING TV CONTROLS..... 43

Picture Quality Controls	44
Picture Settings	44
Color Warmth	44
Noise Filter	45
Convergence	45
Picture Tilt	45
Picture Presets	45
Reset Controls	45
Audio Controls	46
Mute	46
Tone Controls	46
Audio Processor	46
Speakers	47
Sound Logic	47
SAP	47
Optical Output	47
Audio Language	47

USING THE PROFILES 49

About Profiles	50
The DIRECTV Setup	50
Editing Channels in a DIRECTV List	50
Selecting or Deleting All DIRECTV Channels	51
Setting the DIRECTV Spending Limit	51
Setting the TV Rating	54
Choosing Your Profile	60
Locking and Unlocking a User Profile	61
Locking the System	62
Unlocking the System	62

TABLE OF CONTENTS

OPTIONS AND PREFERENCES	63
Changing the Signal Source	64
Changing the Signal Type	64
Auto Tuning	65
Channel Search	66
Mailbox	66
Purchases: Pay Per View Programs	67
Setting the Time and Date	71
Using the Preferences Menu	71
Color Scheme	71
Translucency	72
Default Guide	72
Screen Format	72
Caption Display	73
Caption Mode	73
Using Fetch	74
GETTING ASSISTANCE	75
Running the Interactive Setup	76
Getting Antenna Information	76
Dish Pointing	77
Your New Access Card	79
Running the System Test	79
Off-Air Guides	80
Upgrades	80
REFERENCE	81
Troubleshooting	82
Care and Cleaning	83
RCA HDTV Limited Warranty	84
FCC Registration Information	85
Accessory Information	86
Index	91

WELCOME TO HDTV

High Definition refers to a new way of sending programming information over the airwaves and into your TV. There are two types of TV display formats available. One is ATSC format, which originated from the Advanced Television Systems Committee. The other is NTSC format, which is named for the National Television System Committee. What makes your High Definition Television (HDTV) special is that it has tuners capable of receiving several types of signals: analog (in NTSC format) and digital (in ATSC format), cable (in NTSC and ATSC formats), and digital satellite and high definition satellite (coming from DIRECTV if you subscribe to DIRECTV® programming†). This makes receiving all types of signals seamless. Below is an example of how your HDTV can receive the different types of signals.

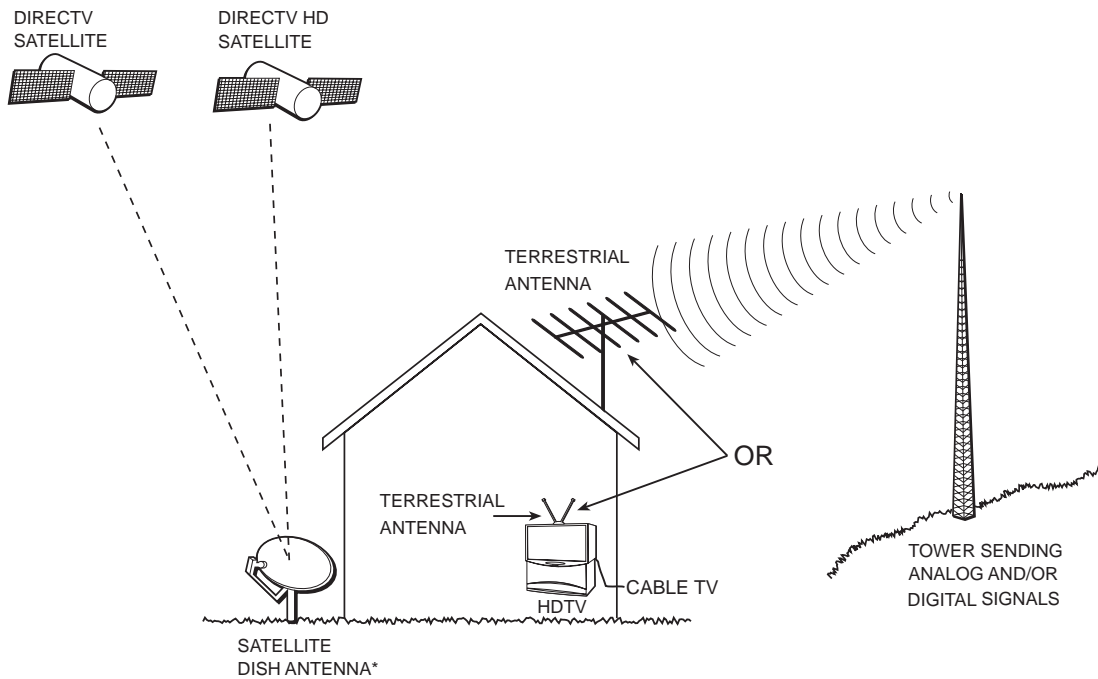

PARTS OF A COMPLETE HIGH DEFINITION SYSTEM

So why is it called High Definition? Definition—commonly called resolution—refers to the sharpness of the image and is determined by the number of dots, or pixels, your screen uses to create the image. The more pixels the sharper the image. An HDTV normally has either 1080 or 720 rows and over 1,000 columns of pixels. This results in a display of over one million pixels. Your HDTV also has a wide screen, or “wide aspect ratio” of 16:9 as opposed to the common 4:3 ratio. It is normally capable of displaying both interlaced images (like today’s analog TVs) and progressive images (like a computer monitor).

What this all means is that while digital broadcasting will bring many new possibilities, only people with HDTVs like yours will actually be capable of realizing many of them. A wide aspect ratio, one million pixel resolution, CD-quality audio with Dolby Digital surround sound, and improved interactivity are features of many digital broadcasts, and your HDTV will help bring it all into your home.

† Receipt of DIRECTV programming is subject to the terms of the DIRECTV Customer Agreement, a copy is provided with your first billing statement. DIRECTV is a trademark of DIRECTV, Inc., a unit of Hughes Electronics Corp., and is used with permission.

* The appearance of your satellite dish antenna may differ from that shown here. If your satellite dish antenna is round instead of oval, you can receive programming from only one DIRECTV satellite.

SETUP AND CONNECTIONS

GETTING STARTED

This section tells you how to get your HDTV set up and connected. It describes the cables you will need, explains the front and back panels, and walks you through the steps needed to start using your TV.

1 SETUP AND CONNECTIONS



2 USING THE REMOTE



3 BASIC TV OPERATION



4 USING THE PROGRAM GUIDES



5 ADJUSTING TV CONTROLS



6 USING THE PROFILES



7 OPTIONS AND PREFERENCES



8 GETTING ASSISTANCE



9 REFERENCE

SETUP AND CONNECTIONS

STEP 1: UNPACK THE SYSTEM

Make sure to locate the remote control and power cord.

STEP 2: CONNECT YOUR TV TO OTHER COMPONENTS

During the satellite dish antenna installation, the TV may have been connected with just a coaxial cable for the system test. Depending on what components you have, another connection may provide better picture and audio quality. The following sections provide cable and connection information to help you decide what connection is best for you.



Remote Control



Power Cord

THINGS TO KNOW BEFORE CONNECTING COMPONENTS

Protect Your Components from Power Surges

- Connect all components before plugging any power cords into the wall outlet.
- Always turn off the TV and other components before you connect or disconnect any cables.

Position Cables Correctly to Avoid Audio Hum or Interference

- Insert all cable plugs firmly into their jacks.
- Place the audio/video cables to the sides of the TV's back panel instead of straight down the middle after you connect your components.
- Try not to coil any twin-lead cables; keep them away from the audio/video cables as much as possible.
- Make sure all antennas and cables are properly grounded. Refer to the safety sheet packed with your unit.

Protect Your Components from Overheating

- Do not block ventilation holes in any of the components. Arrange the components so that air can circulate freely.
- Do not stack components.
- Allow adequate ventilation when placing your components in a stand.
- Place an amplifier on the top shelf of the stand so that heated air rising from it will not flow around other components.

SETUP AND CONNECTIONS

JACKS AND CABLES

Below is a description of the jacks and cables you can use to make connections. Note that not all cables come with your television unit.

S-Video Jack and Cable

The S-Video jack provides the best picture quality for your system.

This jack is available on this TV and is used in conjunction with audio cables. Remember also to connect the left and right audio cables because the S-Video jack carries only the picture signal, not the sound.

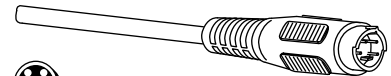

S-Video Jack

Audio/Video Jacks and Cables (RCA-type)

The audio/video jacks provide very good picture and stereo sound quality.

These jacks are used for most audio/video connections between components. The audio/video jacks are often color coded (yellow for video, red for right audio, and white for left audio). If your component has only one input for audio (mono), connect it to the left (white L/Mono) audio jack on the TV.

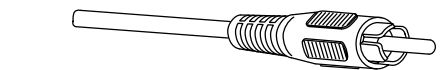

Audio/Video Jacks

RF Jacks and Coaxial Cables (F-type)

The RF jacks are necessary for reception of off-air broadcasts, cable, and DIRECTV signals.

These jacks are required for antenna or cable connections. The RF and coaxial jacks on the TV are labeled SATELLITE IN, ANTENNA A IN, and ANTENNA B IN. An RG-6 coaxial cable is required for all satellite signal distribution.



RF Jack

Optical Jack and Cables

The optical cable is used for connecting a Dolby Digital receiver. If you own a Dolby Digital receiver that uses an optical cable-type input, you can use an optical cable to connect the TV to that receiver for the best sound quality.

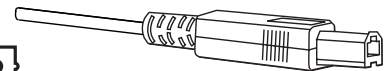

Digital Audio Out Jack

Telephone Jack and Cord

The telephone line cord is required to connect your TV to a phone line. If you choose to subscribe to DIRECTV® programming, some services require this phone line connection. The phone line connection is used to periodically call out to DIRECTV. You will need an RJ11 type modular jack, which is the most common type of phone jack and might look like the one pictured here. If you don't have a modular jack, call your local telephone company to find out how to get one installed.

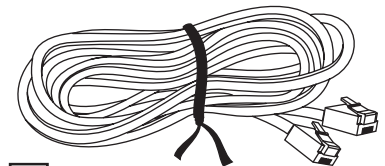

Phone Jacks

Y P_B P_R Jacks and Cable

The Y P_B P_R jacks allow you to connect an optional component video source, such as a DVD player. This connection provides optimum quality by maintaining the video source as three separate signals through these jacks. To ensure maximum picture quality, use three video-grade cables for the connection.

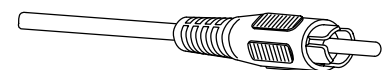

Y P_B P_R

SETUP AND CONNECTIONS

FRONT BUTTONS

The diagrams below describe the front panel and front input jacks on the TV. Please note that the exact look of the buttons pictured here may be different from yours.

If you cannot find your remote control, you can use the front panel of the TV to operate many of the TV's features.

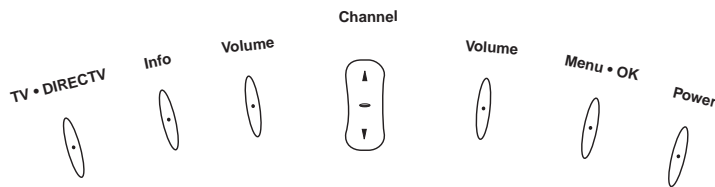

Front panel buttons on model P61310

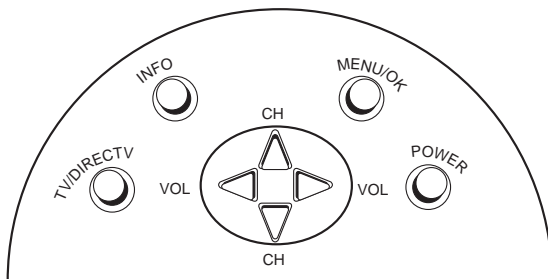

Front panel buttons on model F38310

TV/DIRECTV Toggles between TV mode and DIRECTV mode.

INFO Brings up the on-screen channel banner. Press when in the program guide to get more information on the highlighted program or channel.

VOL < Decreases the volume. When in the menu system, VOL < moves the highlight left and adjusts menu controls.

VOL > Increases the volume. When in the menu system, VOL > moves the highlight right and adjusts menu controls.

CH v Scrolls down through the current channel list. If you are in TV mode and press CH v, you scroll down through TV channels. If you subscribe to DIRECTV® programming and are in DIRECTV mode, you scroll down through DIRECTV channels. In the menu system, CH v moves the highlight down one page at the time and adjusts menu controls. In the program guides, CH v advances the highlight one screen down.

CH ^ Scrolls up through the channel list. If you are in TV mode and press CH ^, you scroll up through TV channels. If you subscribe to DIRECTV® programming and are in DIRECTV mode, you scroll up through DIRECTV channels. In the menu system, CH ^ moves the highlight up one page at the time and adjusts menu controls. In the program guides, CH ^ advances the highlight one screen up.

MENU/OK Brings up the main menu. When in the menu system, it selects highlighted items.

POWER Turns the TV on and off.

SETUP AND CONNECTIONS

FRONT INPUTS

The monitor has front inputs for convenience; one set of audio/video inputs and a headphone jack. These jacks let you connect a baseband NTSC (analog) component such as a VCR, Internet access device, game, or camcorder. Look for a hinged door and gently lift the cover open. Please note that the exact look of the jacks or the TV pictured here may be different from yours.

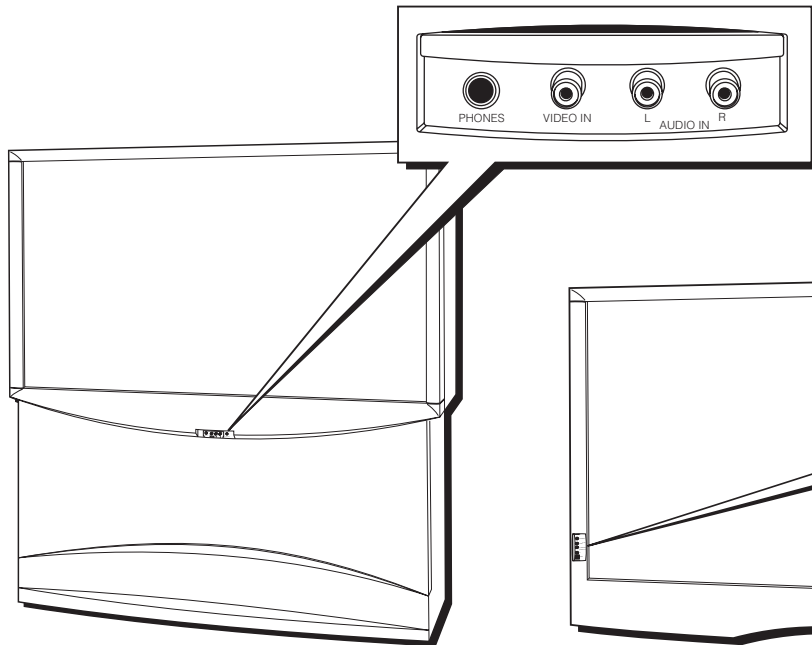

Front panel jacks on model P61310

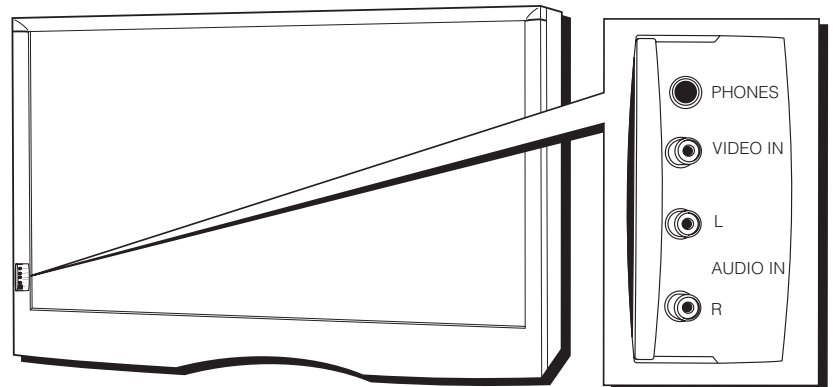

Front panel jacks on model F38310

PHONES Provides a connection for headphones.

VIDEO IN Provides video connection. The video connector is usually yellow.

AUDIO IN L Provides left audio connection. The left audio connector is usually white. When connecting devices that use a monaural cable, such as some camcorders, use the left input jack to get sound from both speakers.

AUDIO IN R Provides right audio connection. The right audio connector is usually red.

SETUP AND CONNECTIONS

BACK OF THE TV

The diagram below describes each of the back panel jacks found on the TV. When connecting A/V cables, be sure to connect corresponding outputs and inputs (video to video, right audio to right audio, etc.).

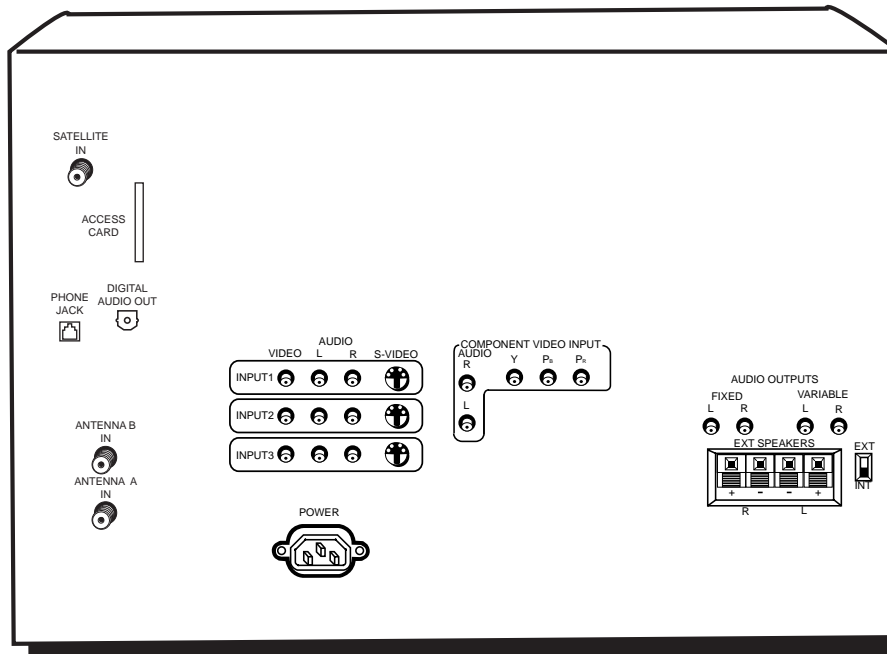

SATELLITE IN Use to connect the satellite dish antenna to the TV using an RG6 cable.

ACCESS CARD Insert the access card into the slot so your program provider can identify you. Make sure the contacts on the access card are facing left and the top of the card is facing right while inserting. (Refer to "New Access Card" in this manual's "Assistance" section for details.) The DIRECTV System requires a valid card.

PHONE JACK Use to connect a phone line to the TV. The DIRECTV System requires a continuous phone line connection to periodically call out to program providers.

DIGITAL AUDIO OUT Use a digital optical cable (or SPDIF cable) to connect your TV to a compatible Dolby Digital receiver or decoder. Dolby Digital offers theatre-quality sound (six audio channels).

ANTENNA B IN Use to connect an off-air or terrestrial antenna or cable TV signal to the TV.

ANTENNA A IN Use to connect a second off-air or terrestrial antenna or cable TV signal to the TV.

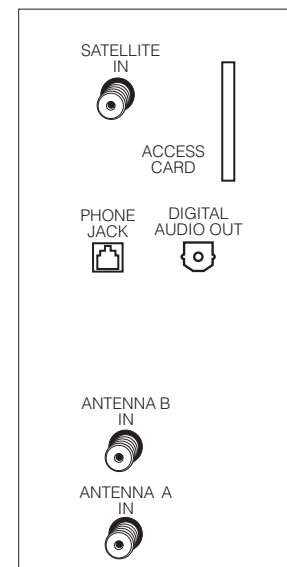

You can also use the ANT B IN (or ANT A IN) for video games and switch between the two inputs using the ANTENNA button on the remote control. When using TV games, computers, and similar products with your TV, keep the contrast at a low setting. If a fixed (non-moving) pattern is left on the screen for long periods of time at a high contrast setting, the image can be permanently imprinted onto the picture tubes. These types of imprints are not covered by your warranty because they are the result of misuse.

SETUP AND CONNECTIONS

INPUT 1 Lets you connect a baseband NTSC (analog) component such as a VCR, laserdisc player, Internet access device, or DVD player.

- VIDEO provides composite video connection. The video connector is usually yellow.
- L AUDIO provides left audio connection. The left audio connector is usually white.
- R AUDIO provides right audio connection. The right audio connector is usually red.
- S-VIDEO lets you connect an S-Video cable for better video quality picture to a component with S-Video capability, such as a VCR or DVD player. When using S-Video, make sure to connect the two audio cables as well as the S-Video connector.

INPUT 2 Provides connection to a second NTSC (analog) video component such as a VCR or laserdisc player. Its jacks are the same as described for INPUT 1, above.

INPUT 3 Provides connection to a third NTSC (analog) video component, such as a VCR or laserdisc. Its jacks are the same as described for INPUTS 1 and 2.

COMPONENT VIDEO INPUT Use to connect an optional component video source, such as a DVD player. This connection provides optimum quality. Note that it is essential to match the color coded connectors between a compatible device and the monitor.

Grey side panels protecting against screen burn-in are not always generated when watching a 4:3 image via the COMPONENT VIDEO INPUT jacks. *Therefore, limited viewing of a 4:3 image is recommended when no side panels are present.* Also note that when watching an image via the COMPONENT VIDEO INPUT jacks, you will not be able to manipulate the screen format.

- **AUDIO R/L** The audio jacks provide stereo sound. When connected, audio volume from the main front and rear speakers is variable audio.
- **Y P_B P_R** Unlike a single video input, component video maintains the video signal as three separate signals through these three jacks. To ensure maximum picture quality, use three video-grade cables for the Y, P_B, and P_R connections.

AUDIO OUTPUTS

- **FIXED L/R** Provides fixed-level audio output from the television. This audio output is ideal for audio recording or for connecting to an A/V receiver amplifier (an auxiliary baseband component) when you want to control the volume through the A/V receiver instead of the TV.
- **VARIABLE L/R** Use to connect an A/V receiver or amplifier (an auxiliary baseband component) for variably-controlled stereo output.
- **RIGHT and LEFT Speaker Terminals** Use to connect external speakers for right and left surround sound.
- **INT. / EXT. (switch)** INT sends audio only to the monitor's internal speakers. EXT sends audio to only external speakers.

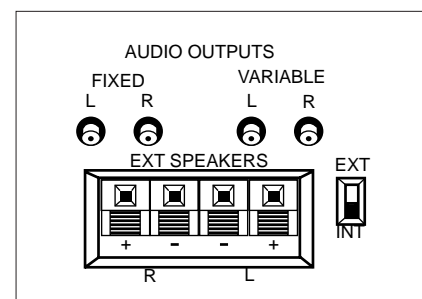
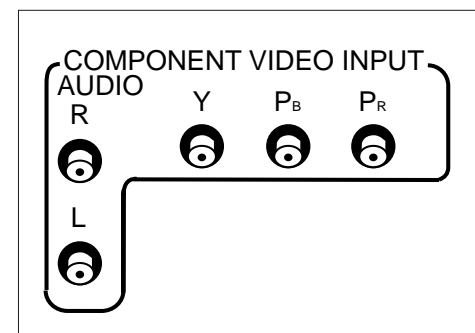
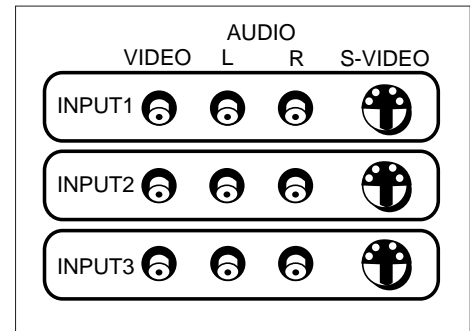

To turn the TV's internal speakers on and off, press MENU on the remote control and choose *Audio*. Then choose *Speakers* from the menu.

SETUP AND CONNECTIONS

THE BASIC CONNECTION

TV and VCR

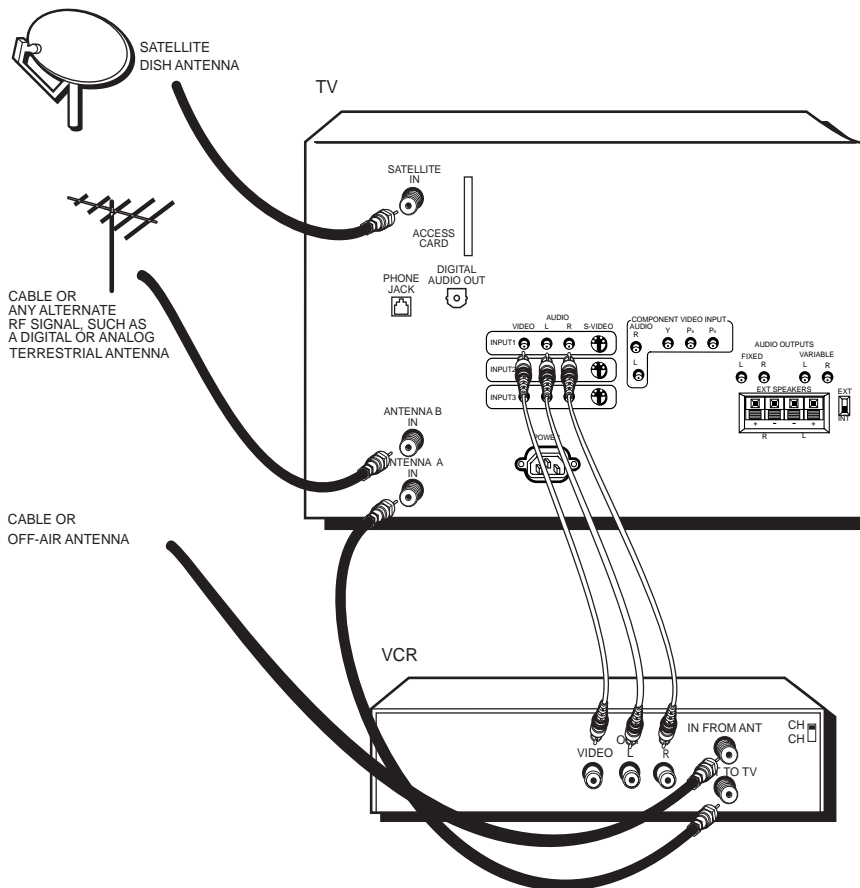

How to view programming:

- To watch cable TV or off-air TV programs from an antenna in this connection, press ANTENNA on the remote control until ANTENNA A is displayed in the channel banner.
- To watch cable or any other alternate RF signal, such as digital or analog terrestrial, press ANTENNA on the remote control until ANTENNA B is displayed in the channel banner.
- To watch satellite programming, press DIRECTV on the remote control and channel up or down to the desired program.

How to view your VCR:

- Press INPUT on the remote control and select the video input (in this example, VID1) in the channel banner. Because the digital decoder is in the TV, not the VCR, digital channels cannot be recorded. If an off-air antenna is used, the VCR output should be viewed using one of the video inputs.
- If you've already set up auto tuning, press the VCR1 button on your remote control.
- NOTE: Viewing a VCR while in AIR mode may result in poor picture performance. Instead, select *System Options* from the main menu, then select *Signal Type* and select *Cable*.

The ANT B and ANT A jacks can receive digital or analog RF signals. The illustrations here are recommended connections in a cable environment.

Some cable systems may require a "conversion box." If so, consult your cable company's box tuning instructions for details.

SETUP AND CONNECTIONS

THE ADVANCED CONNECTION

TV, VCR, and DVD Player With Amplifier

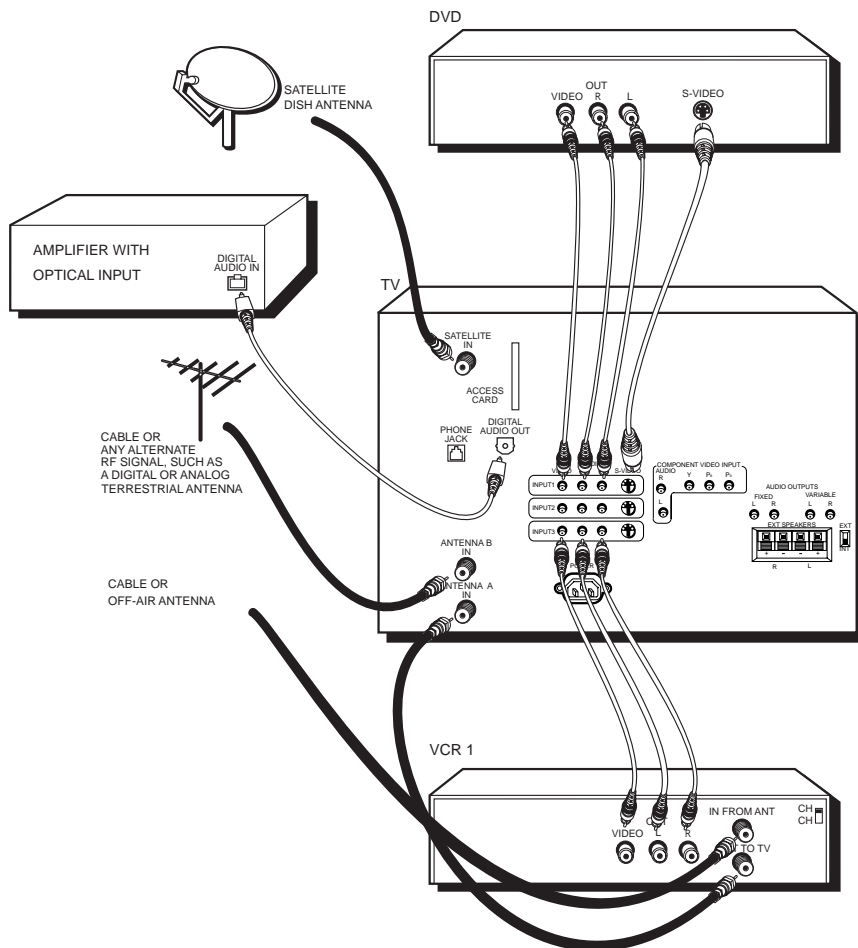

After you have made your connections, program the TV to tune to the correct video input channel to see and hear audio and video from the attached component (VCR, DVD player, etc.). Program your TV as described in the "System Options and Preferences" section of this book.

How to view your DVD and VCR:

- To watch the VCR in this connection, press INPUT on the remote control until the correct video input appears (in this example, VID3). Note that because the digital decoder is in the TV, not the VCR, you cannot record digital channels.
- To watch the DVD player in this connection, press INPUT on the remote control until the correct video input appears (in this example, S-VID1).

Some cable systems may require a "conversion box." If so, consult your cable company's box tuning instructions for details.

Please Read Before Using the Digital Audio Out Jack

This TV's optical digital output jack fully complies with the international standard governing this type of jack (IEC958), and is designed for connection to a Dolby Digital (AC-3® or PCM) receiver or Dolby Digital (AC-3 or PCM) decoder. Older equipment, some of which is not fully compliant with IEC958, may not be compatible with the Dolby Digital bitstream. Such a connection using anything other than Dolby Digital AC-3 or PCM receiver or decoder could create a high noise level, causing damage to headphones or speakers.

*AC-3 is a registered trademark of Dolby Laboratory Licensing Corporation.

SETUP AND CONNECTIONS

CONNECTING SPEAKERS TO THE TV

You can connect up to two additional speakers to the TV: one to the RIGHT terminal, and one to the LEFT terminal.

1. If necessary, remove the vinyl covering from the ends of the speaker wire and twist the wire core.



Speaker wire

2. Open the lever on the speaker terminal.
3. Insert the wire core into the hole. Be sure to connect the (+) to (+) and (-) to (-).
4. Close the lever. Pull gently on the wire to see that it's connected securely.

To turn on or off the TV's internal speakers, press MENU on the remote control and choose *Audio*. Then choose *Speakers* from the menu.

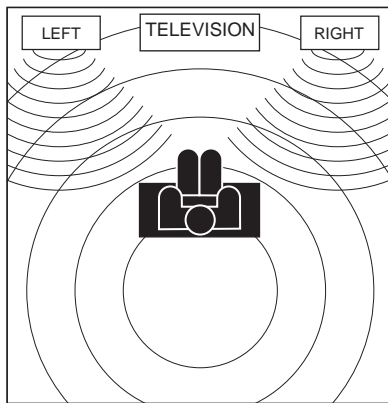

Arrange the speakers in your TV room to achieve maximum sound quality.

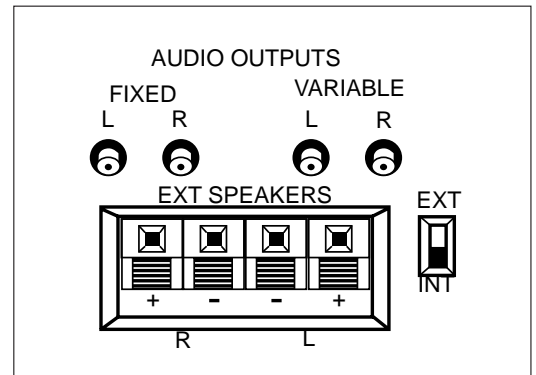

When connecting the speaker wire, make sure you connect the positive (+) terminal on the TV to the positive (+) terminal on the speaker. One side of the speaker wire is usually marked with a white stripe to help you match the terminals correctly. If the (+) and (-) terminals are not matched properly, the speakers will not be "in phase," causing reduction in bass frequencies.

Do not allow the wire core to touch other wires or terminals. Damage to components could result if the cores of two wires touch.

SETUP AND CONNECTIONS

CONNECTING A STEREO AMPLIFIER

1. Use RCA cables to connect either the **FIXED** or **VARIABLE AUDIO OUTPUT** from the monitor to an AV receiver.
 - **FIXED** provides fixed-level audio output from the monitor. This audio output is ideal for connecting to an AV receiver that has its own volume control.
 - **VARIABLE** provides variable-level audio output. Volume levels are controlled by the volume controls on the monitor and monitor remote control.
2. Use speaker wire to connect the monitor to external speakers.
 - The **EXT/INT** switch beside the jacks let you turn speakers on or off. **EXT** sends audio to external and internal speakers. **INT** sends audio only to the monitor's internal speakers.
3. You may prefer to turn off the TV's internal speakers. Select *Audio* from the main menu and then select *Speakers*.

Important: Do not use the amplifier's **PHONO** inputs. Consult the amplifier's owner's manual for the manufacturer's recommended hookup.

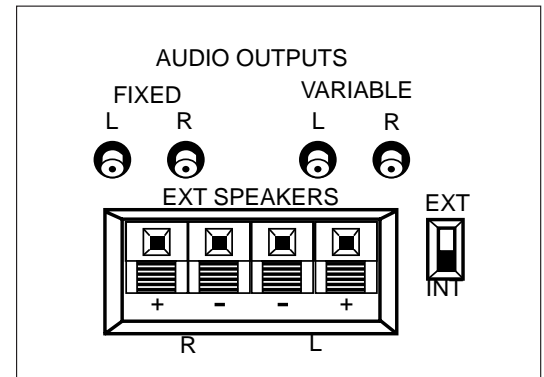

The **FIXED/VARIABLE OUT** jacks on the back panel provide a fixed or variable audio signal. When connected to "variable", they are ideal for use with an audio amplifier that does not have its own remote volume control. When connected to "fixed," the output volume stays the same no matter how the volume changes on the TV.

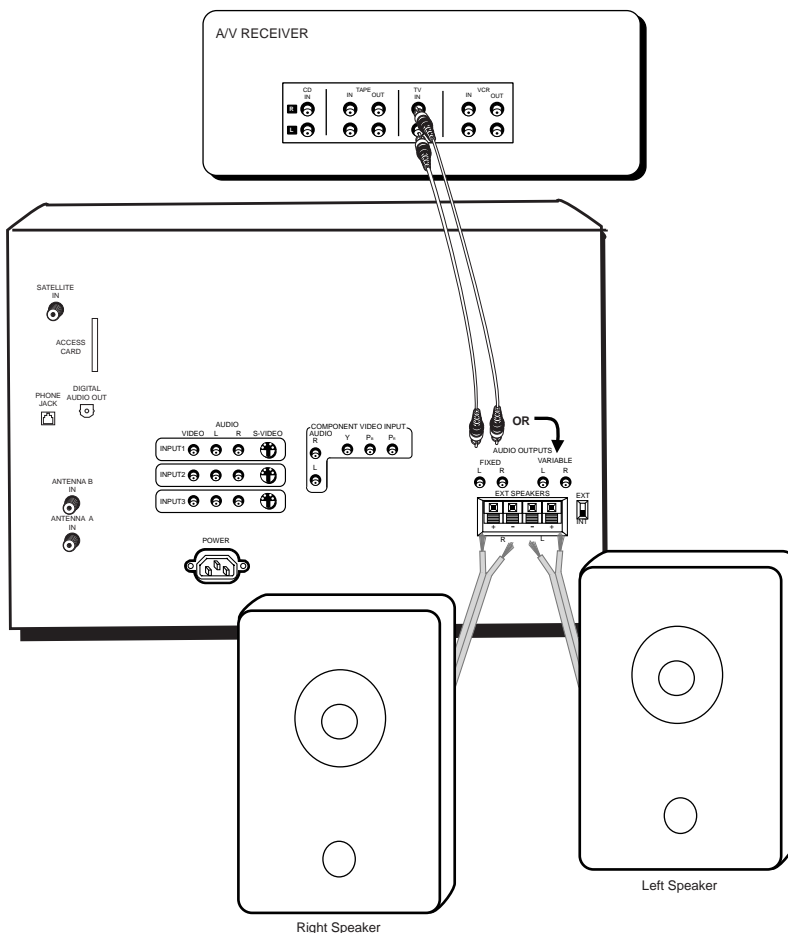

SETUP AND CONNECTIONS

STEP 3: PLACE BATTERIES IN THE REMOTE CONTROL

Follow these steps whenever you need to install or change the batteries in your TV's remote control.

1. Remove the cover from the battery compartment.
2. Insert batteries into the battery compartment, matching the + and – end of each battery.
3. Replace the cover.

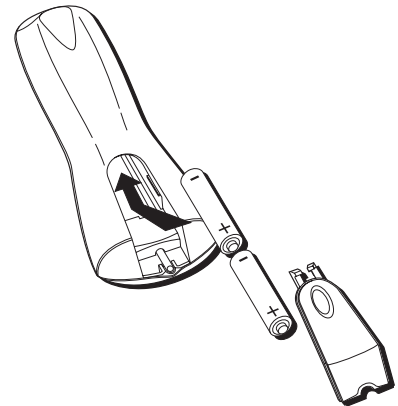

STEP 4: PLUG IN AND TURN ON THE SYSTEM

Plug one end of the power cord into the back of the television as shown on right. Plug the other end into a wall outlet. Be sure to insert the plugs completely.

To turn on the TV, press the TV or ON•OFF button on the remote control or the POWER button on the front panel. It may take several seconds for the TV to turn on.

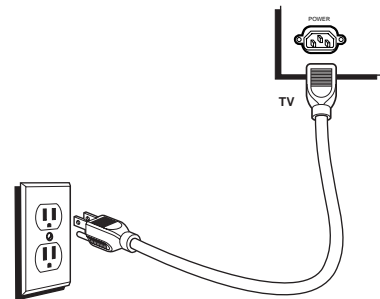

STEP 5: COMPLETE THE INTERACTIVE SETUP

Interactive setup appears when you turn on your TV for the first time. Follow the steps to configure the basics of your system, such as setting up the time and day, searching for available channels, and setting up speakers. To run it again, select *Assistance* from the main menu, then select *Interactive Setup*. For more details, see the section "Getting Assistance" in this book.

STEP 6: ORDER PROGRAMMING

You should decide if you would like to receive DIRECTV® programming*. To receive DIRECTV programming, your satellite dish antenna must be installed and pointed correctly. You must also contact your service provider, DIRECTV.

Programming with DIRECTV: Call 1-800-347-3288

* Receipt of DIRECTV programming is subject to the terms of the DIRECTV Customer Agreement, a copy is provided with your first billing statement. DIRECTV is a trademark of DIRECTV, Inc., a unit of Hughes Electronics Corp., and is used with permission.

When you order programming, you need to know your access card number. To get the number, select *Assistance* from the main menu and then select *System Test*.

Wait for the system to run all of its tests. The access card number is displayed at the end of the system test.

Write the access card number in the space below for easy reference:

USING THE REMOTE

HOW TO USE YOUR UNIVERSAL REMOTE

In this section you will find out how to use your universal remote control. This section:

- defines the buttons on the remote control.
- describes how you toggle between TV “mode” and DIRECTV “mode.”
- shows you how to change between analog terrestrial, digital terrestrial, and DIRECTV® channels.
- walks you through using the PIP (picture-in-picture) feature.
- describes how to program the remote to control other devices such as a VCR.

Important: Because this universal remote can control several different components (TV, VCR, etc.), it uses operational modes triggered by the component buttons. For example, if you want the remote to control the VCR, you would press the VCR button to put the remote into VCR mode so you could control the VCR.

1 SETUP AND CONNECTIONS



2 USING THE REMOTE



3 BASIC TV OPERATION



4 USING THE PROGRAM GUIDES



5 ADJUSTING TV CONTROLS



6 USING THE PROFILES



7 OPTIONS AND PREFERENCES



8 GETTING ASSISTANCE



9 REFERENCE

USING THE REMOTE

REMOTE CONTROL BUTTONS

ON•OFF When the remote control is in TV or DIRECTV mode, ON•OFF turns the TV on or off. If in another component mode, (VCR, DVD, etc.) and programmed, the remote will turn the component on and off. When pressed twice within two seconds, all components that are on will be turned off (this feature only works with most RCA, GE, and PROSCAN products).

VCR1 Places the remote control in VCR mode and if auto tuning is enabled, it will turn on the TV and tune to the correct video input channel for viewing VCR1.

TV Turns on the TV and tunes to the last-viewed TV channel. Also places the remote control in TV mode. Placing the remote in TV mode enables you to access the TV's menu system as well as tune to analog, digital, or cable TV channels.

DVD Places the remote control in DVD mode and if auto tuning is enabled, it will turn on the TV and tune to the correct video input channel for viewing your RCA, GE, or PROSCAN DVD player.

VCR2 Places the remote control in VCR2 mode and if auto tuning is enabled, it will turn on the TV and tune to the correct video input channel for viewing VCR2.

(LED) Light that indicates you're in programming mode when programming the remote control. Also displays when a valid remote control button is pressed.

AUX Places the remote in auxiliary mode in order to control the component (such as a laserdisc player) that you have programmed it to control. Acts as a "wildcard" button, as it can be programmed to control another VCR, cable box, satellite receiver, or an RCA, GE, or PROSCAN audio component.

DIRECTV Places the remote control in DIRECTV mode, turns on the TV, and tunes to the last-viewed DIRECTV® channel. If you subscribe to DIRECTV® programming, you must be in DIRECTV mode to view DIRECTV® channels. Placing the remote in DIRECTV mode enables you to access the TV's menu system as well as tune to DIRECTV® channels.

MUTE Reduces the TV's volume to its minimum level. Press again to restore volume.

SKIP Press once before changing channels and the TV will return to the original channel after 30 seconds. Press repeatedly to add more time. If no other displays are present, pressing CLEAR will cancel the commercial skip timer.

CH +/- Scrolls up or down through the current channel list. Press once to change the channel up or down; press and hold to continue changing channels. If you are in TV mode and press CH+/-, you scroll through TV channels. If you subscribe to DIRECTV® programming and are in DIRECTV mode, you scroll through DIRECTV® channels. In DVD mode, CH +/- will skip chapters on a disc played by RCA, GE, or PROSCAN DVD players.

VOL UP/DOWN Adjusts the TV's audio volume.

FETCH Brings up the Fetch menu, which is a list of most commonly accessed menu items.

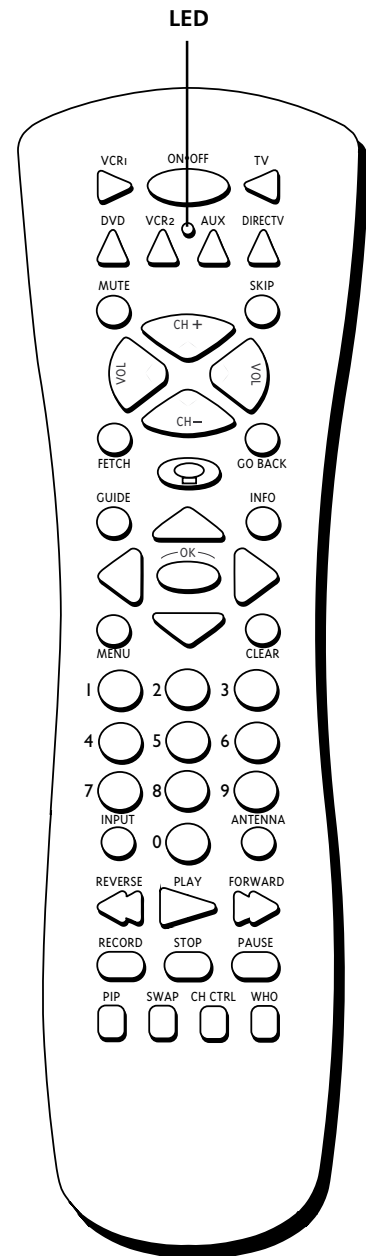

USING THE REMOTE

GO BACK Moves you back and forth between the last two channels selected in either DIRECTV mode or TV mode. For example, if you have been viewing both DIRECTV® and TV channels (and thus using both the DIRECTV and TV “modes”), pressing GO BACK while watching a DIRECTV® channel moves you back to the last DIRECTV® channel you viewed. Pressing it while watching a TV channel moves you to the last TV channel you viewed. In the menu system, pressing GO BACK returns you to the previous menu screen.

(Light Bulb Button) Press to illuminate some of the remote control’s buttons. To conserve battery power, the light turns off after several seconds.

GUIDE When in TV mode, brings up the TV program guide. In DIRECTV mode, brings up the DIRECTV® programming guide. Subsequent presses of the GUIDE button scroll through the different types of guides. Press GUIDE after pressing INPUT to get a guide-like list of available video input channels.

INFO Brings up channel and viewing information via the channel banner. Quickly press again to bring up an extended channel banner and press a third time to remove the banner. Press when in the program guides to get more information on the highlighted program or channel.

ARROWS Used to point to different items in the menu system and adjust the menu controls. Also move the PIP window when no menus are on the screen.

OK When in the menu system and other on-screen displays, selects highlighted items.

MENU Brings up the main menu and selects highlighted items. When in using an RCA, GE, or PROSCAN VCR and in VCR mode, it functions as a PROGRAM button.

CLEAR Removes on screen displays and returns to normal viewing. If no displays are present and the skip timer is set, CLEAR will cancel the commercial timer.

DIGIT BUTTONS (0 - 9) Enters channel numbers and time settings directly through the remote control. For more information on entering digits to change channels, see the section “Basic TV Operation.” When in the menus, the digit buttons can be used to directly select items without using the arrows. 0 can be used to return to the previous menu screen.

INPUT Toggles through the available external input sources.

ANTENNA Switches the source of the off-air signal between the HDTV’s ANTENNA A and B. When in VCR mode, the ANTENNA button also functions as a TV/VCR button.

REVERSE, PLAY, FORWARD, RECORD, STOP, PAUSE If programmed, provides transport control for some remote-controllable VCRs, DVD players, laserdisc players, tape decks, and CD players when the remote is in that mode. When in TV or DIRECTV mode, FORWARD will toggle through screen formats.

PIP (Picture-in-Picture) When viewing an analog signal, brings up the small PIP window. Press again to hide PIP.

SWAP Exchanges the main analog picture with the analog PIP window.

CH CTRL (Channel Control) Selects the picture window (either the main or PIP window) that will change when you press the CH +, CH -, INPUT, or digit buttons on the remote control.

WHO Toggles through user profiles.

Don’t worry about getting stuck inside a menu. Pressing the CLEAR button on the remote control takes you out of the menu system.

USING THE REMOTE

PROGRAMMING THE REMOTE CONTROL

The universal remote can be programmed to control most brands of remote controllable components, such as VCRs. The remote is already programmed to control most RCA, GE and PROSCAN TVs, VCRs, DVD players, and laserdisc players.

TESTING THE REMOTE CONTROL

To determine whether the universal remote control requires programming, turn on a component, such as a VCR, point the remote control at the VCR, and press the VCR1 button. Then press ON•OFF or CH + (channel up) or CH - (channel down) to see if the VCR responds to the remote control commands. If not, the remote control requires programming.

PROGRAMMING THE REMOTE CONTROL

Using Automatic Code Search

The following instructions can be used to program the remote control. If you want to exit the automatic code search without programming any of your components, press and hold CLEAR until the LED light on the remote control turns off.

1. Turn on the component you want to control (VCR, etc.).
2. Press and hold the button you want to program (VCR1, VCR2, etc.). Note that the AUX button can only be programmed using direct entry (see the next section for details). While holding the component button, press and hold ON•OFF until the LED light on the remote control turns on, then release both buttons.
3. Point the remote control at the component you want it to control.
4. Press and release PLAY, then wait five seconds or until the LED light stops flashing.

At this point the remote control is searching for the correct code to program. If, after five seconds, the component you want to control does not turn off, press PLAY again to tell the remote control to search the next set of codes.

Continue pressing PLAY until the component turns off or you have searched through all of the codes. There are 20 total sets of codes. If the component does not turn off after pressing PLAY 20 times, then the remote cannot control that particular component.

If the component you want to control *does* turn off:

1. Press and release REVERSE, then wait two seconds. Repeat this step until the component turns back on.
2. To finish, press and hold STOP until the LED light on the remote control turns off.

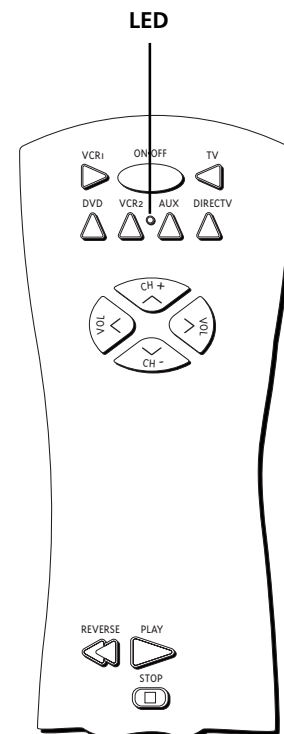

You'll use these buttons when you program the remote to control any component.

The remote may not operate all models of all brands.

USING THE REMOTE

Using Direct Entry

1. Turn on the component to be programmed.
2. Look up the brand and code number(s) for the component on the code list in the section "Remote Control Codes" on the following page.
3. Press and hold the remote control button you want to program.
4. Enter the code from the code list.
5. Release the button, and then press ON•OFF to see if the component responds to the remote control commands. If it doesn't, try pressing the component button and then ON•OFF again.
6. If you get no response, repeat these steps using the next code listed for your brand until the component responds to the remote control commands.

This remote control may not operate all models of the brands that are shown. Use the codes shown in this manual, or on the sheet packed with your remote control.

Use the AUX button to control a separate satellite receiver, if necessary. Do not reprogram the DIRECTV button.

USING THE REMOTE TO CONTROL A COMPONENT

Once the remote has been programmed successfully, you are ready to use it to control your components, such as a VCR, DVD player, or laserdisc player.

To operate the component:

1. Press the component button (VCR1, VCR2, DVD, or AUX) to set the remote to control the component.
2. Press ON•OFF to turn the component on or off.
3. Use the remote control buttons that apply to that component.

USING THE REMOTE

REMOTE CONTROL CODES

VCR	
Admiral	2131
Adventura	2026
Aiko	2027
Aiwa	2002, 2026
Akai	2003, 2004, 2005, 2007, 2008, 2111, 2112, 2113
American High	2021
Asha	2013
Audio Dynamics	2009, 2010
Audiovox	2014
Bell & Howell	2011
Beaumarck	2013
Broksonic	2012, 2025
Calix	2014
Candle	2013, 2014, 2015, 2016, 2017, 2018, 2019
Canon	2021, 2022, 2114
Capehart	2020, 2110
Carver	2062
CCE	2027, 2061
Citizen	2013, 2014, 2015, 2016, 2017, 2018, 2019, 2027
Colortyme	2009
Colt	2061
Craig	2013, 2014, 2023, 2061
Curtis-Mathes	2000, 2002, 2009, 2013, 2016, 2018, 2021, 2022, 2024, 2115
Cybernex	2013
Daewoo	2015, 2017, 2019, 2025, 2026, 2027, 2028, 2110
Daytron	2110
Dbx	2009, 2010
Dimensia	2000
Dynatech	2002, 2026
Electrohome	2014, 2029
Electrophonic	2014
Emerson	2002, 2012, 2014, 2015, 2021, 2024, 2025, 2026, 2029, 2030, 2032, 2033, 2034, 2035, 2036, 2037, 2038, 2039, 2040, 2041, 2042, 2044, 2045, 2047, 2065, 2105, 2113, 2116, 2117, 2130
Fisher	2011, 2023, 2048, 2049, 2050, 2051, 2052, 2118
Fuji	2021, 2119
Funai	2002, 2026
Garrard	2026
GE	2000, 2001, 2013, 2021, 2022, 2053, 2115, 2120
Goldstar	2009, 2014, 2018, 2054, 2121
Gradiente	2026
Harley Davidson	2026
Harman Kardon	2009
Harwood	2061
Headquarter	2011
Hitachi	2002, 2055, 2056, 2057, 2107, 2111, 2120, 2122
HI-Q	2023
Instant Replay	2021
JCL	2021
JC Penney	2009, 2010, 2011, 2013, 2014, 2021, 2022, 2055, 2056, 2058, 2059, 2060, 2107, 2118
Jensen	2055, 2056, 2111
JVC	2009, 2010, 2011, 2018, 2058, 2111, 2123
Kenwood	2009, 2010, 2011, 2016, 2018, 2058, 2111, 2123
KLH	2061
Kodak	2014, 2021
Lloyd	2002, 2026
Logik	2061
LXI	2014
Magnavox	2021, 2022, 2062, 2063, 2104, 2108, 2124
Magnin	2013
Marantz	2009, 2010, 2011, 2016, 2018, 2021, 2058, 2062, 2064
Marta	2014
Masushita	2021
MEI	2021
Memorex	2002, 2011, 2013, 2014, 2021, 2023, 2026, 2104, 2131
MGA	2029, 2065, 2113
MGN Technology	2013
Midland	2053
Minolta	2055, 2056, 2107
Mitsubishi	2029, 2055, 2056, 2065, 2066, 2067, 2069, 2070, 2071, 2072, 2073, 2074, 2106, 2113, 2123
Montgomery Ward	2075, 2131
Motorola	2021, 2131
MTC	2002, 2013, 2026
Multitech	2002, 2013, 2016, 2026, 2053, 2061
NEC	2009, 2010, 2011, 2016, 2018, 2058, 2064, 2076, 2078, 2079, 2111, 2123
Nikko	2014
Noblex	2013
Olympus	2021
Optimus	2014, 2131
Optonica	2096
Orion	2035
Panasonic	2021, 2022, 2109, 2125, 2126, 2127
Pentax	2016, 2055, 2056, 2107, 2120
Pentax Research	2018
Philco	2021, 2022, 2062, 2063
Philips	2021, 2062, 2096, 2124
Pilot	2014
Pioneer	2010, 2055, 2080, 2081, 2123
Portland	2016, 2017, 2019, 2110
PROSCAN	2000, 2001, 2061
Protec	2104
Pulsar	2011
Quarter	2011
Quartz	2011
Quasar	2021, 2022, 2125
RCA	2000, 2001, 2003, 2013, 2021, 2055, 2056, 2082, 2083, 2084, 2085, 2086, 2087, 2088, 2089, 2090, 2091, 2107, 2115, 2120, 2125
Radioshack/Realistic	2002, 2011, 2013, 2014, 2021, 2022, 2023, 2026, 2029, 2049, 2050, 2096, 2131
Radix	2014
Randex	2014
Ricoh	2128
Runco	2104
Samsung	2005, 2013, 2015, 2033, 2053, 2112
Sanky	2131, 2104
Sansui	2010, 2092, 2111, 2123
Sanyo	2011, 2013, 2023
Scott 2012	2015, 2025, 2032, 2035, 2038, 2065, 2093, 2116
Sears	2011, 2014, 2021, 2023, 2048, 2049, 2050, 2051, 2055, 2056, 2107, 2118
Sharp	2002, 2017, 2029, 2094, 2095, 2096, 2131
Shintom	2004, 2056, 2061, 2098
Shogun	2013
Signature	2002, 2131
Singer	2021, 2061, 2128
Sony	2002, 2004, 2098, 2099, 2119, 2128
STS	2021, 2107
Sylvania	2002, 2021, 2022, 2026, 2062, 2063, 2065, 2124
Symphonic	2002, 2026
Tandy	2002, 2011
Tashiko	2014
Tatung	2058, 2111
TEAC	2002, 2026, 2058, 2085, 2111
Technics	2021, 2109
Teknika	2002, 2014, 2021, 2026, 2100, 2129
TMK	2013, 2024, 2047
Toshiba	2015, 2049, 2051, 2055, 2065, 2093, 2116
ToteVision	2013, 2014
Unitech	2013
Vector Research	2009, 2010, 2015, 2016
Victor	2010
Video Concepts	2009, 2010, 2015, 2016, 2113
Videosonic	2013
Wards	2002, 2013, 2014, 2015, 2021, 2023, 2026, 2029, 2055, 2056, 2061, 2096, 2101, 2102, 2103, 2107, 2116, 2131
XR-1000	2021, 2026, 2061
Yamaha	2009, 2010, 2011, 2018, 2058, 2111
Zenith	2004, 2098, 2104, 2119, 2128
TV86	5027
Unika	5008, 5009, 5011
United Artists	5002
United Cable	5053
Universal	5008, 5009, 5010, 5011
Videoway	5044
Viewstar	5015, 5025, 5027, 5040
Zenith	5026, 5050, 5051

Satellite Receivers	
Chapparral	5056, 5057
Drake	5058, 5059
GE	5000, 5001
General Instruments	5060, 5061, 5062
Panasonic	5075
Primestar	5076
PROSCAN	5000, 5001
RCA	5000, 5001
Realistic	5063
Sony	5072
STS1	5064
STS2	5065
STS3	5066
STS4	5067
Toshiba	5068
Toshiba	5073
Uniden	5069

Cable Boxes	
ABC	5002, 5003, 5004, 5005, 5006, 5007, 5053
Antronix	5008, 5009
Archer	5008, 5009, 5010, 5011
Cabletenna	5008
Cableview	5008
Century	5011
Citizen	5011
Colour Voice	5012, 5013
Comtronics	5014, 5015
Contec	5016
Jasco	5011
Jerrold	5003, 5005, 5007, 5018, 5023, 5024, 5046, 5053
Magnavox	5025
Memorex	5026
Movie Time	5002, 5027, 5028
NSC	5002, 5027, 5028
Oak	5002, 5016, 5029
Panasonic	5048, 5052
Paragon	5026
Philips	5011, 5012, 5013, 5019, 5025, 5030, 5031, 5032
Pioneer	5033, 5034
Pulsar	5026
RCA	5047, 5049, 5052
Realistic	5009, 5049
Regal	5022, 5035
Regency	5017
Rembrandt	5003
Runco	5026
Samsung	5014, 5034
Scientific Atlanta	5006, 5036, 5037, 5038
Signal	5014, 5018
Signature	5003
SL Marx	5014
Sprucer	5052
Starcom	5007, 5018, 5053
Stargate	5014, 5018
Starquest	5018
Tandy	5040
Television	5014
Tocom	5004, 5023, 5041
Toshiba	5026
Tusa	5018

Audio	
(for RCA and Dimensia brands only)	
AM/FM	4003
Aux	4004
Phono	4005
CD	4007
Tape	4006

DVD Players	
RCA, GE, PROSCAN	2001
Realistic	5009, 5049
Regal	5022, 5035
Regency	5017
Rembrandt	5003
Runco	5026
Samsung	5014, 5034
Scientific Atlanta	5006, 5036, 5037, 5038
Signal	5014, 5018
Signature	5003
SL Marx	5014
Sprucer	5052
Starcom	5007, 5018, 5053
Stargate	5014, 5018
Starquest	5018
Tandy	5040
Television	5014
Tocom	5004, 5023, 5041
Toshiba	5026
Tusa	5018
TV86	5027
Unika	5008, 5009, 5011
United Artists	5002
United Cable	5053
Universal	5008, 5009, 5010, 5011
Videoway	5044
Viewstar	5015, 5025, 5027, 5040
Zenith	5026, 5050, 5051

BASIC TV OPERATION

THE INS AND OUTS OF USING YOUR HDTV

This section tells you about the interactive channel banner, which appears when you change channels or press INFO on the remote.

It also describes how to change channels and modes and how to use PIP (Picture-In-Picture).

This section gives you a broad, clear view of how to operate the basics of your TV.

1 SETUP AND CONNECTIONS



2 USING THE REMOTE



3 BASIC TV OPERATION



4 USING THE PROGRAM GUIDES



5 ADJUSTING TV CONTROLS



6 USING THE PROFILES



7 OPTIONS AND PREFERENCES



8 GETTING ASSISTANCE



9 REFERENCE

BASIC TV OPERATION

ABOUT THE CHANNEL BANNER

The channel banner appears whenever you tune to a channel or press INFO on the remote control. When the banner is displayed, pressing INFO gives extended information, when available. Use the arrow buttons and OK to choose an icon in the channel banner.

Channel banner icons represent frequently-used features. Some icons change appearance to show the item's status or availability.

Please note that when you're in TV mode, the channel banner will not look the same as when you're in DIRECTV mode (if you subscribe to DIRECTV® programming).

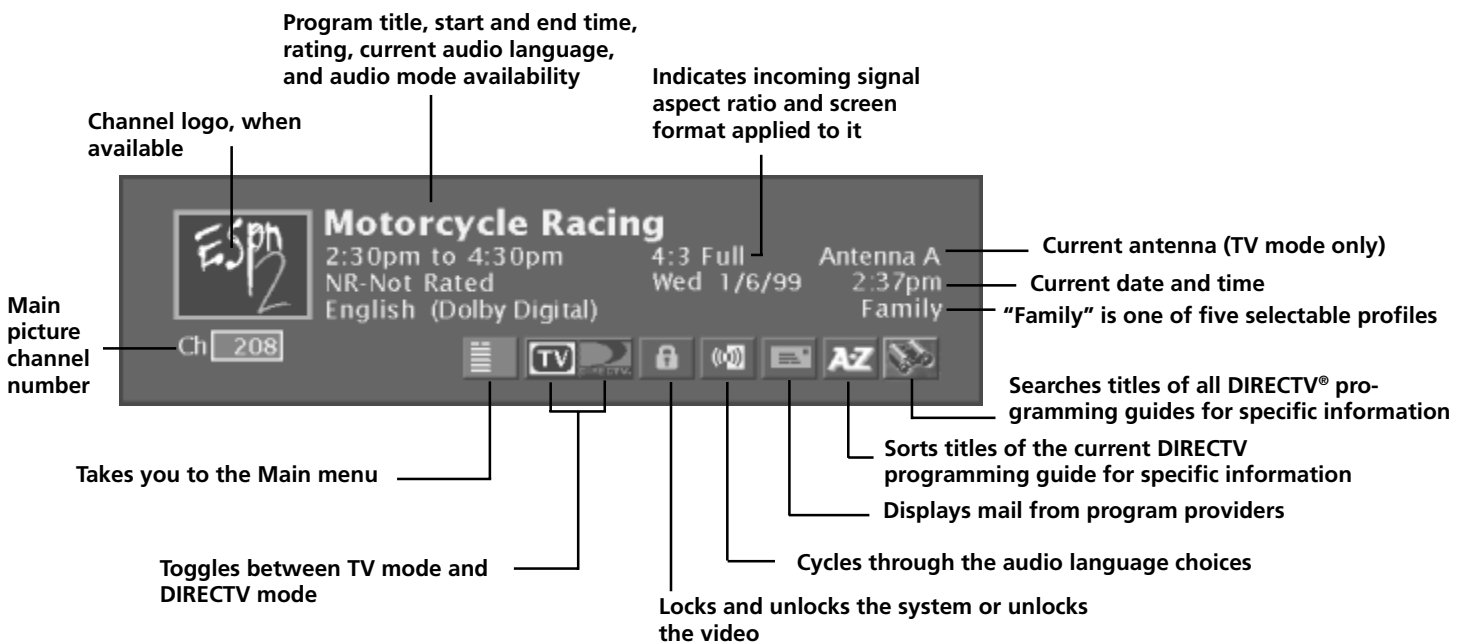

BASIC TV OPERATION

CHANNEL BANNER ICONS

Main menu icon When selected, takes you to the main menu.

TV/DIRECTV logo When selected, toggles between TV and DIRECTV viewing. The highlighted icon indicates the current viewing state.

Green unlock icon Indicates that the system is unlocked. Spending, viewing and other limits can be accessed and changed. When selected, locks the system.

Yellow unlock icon Indicates that a password has been entered to override profile limits. No limits can be accessed or changed. When selected, locks the system.

Red lock icon Indicates that no limits can be accessed or changed. A password is required to override limits or access the system.

Audio language icon If the icon is highlighted while watching a digital (ATSC) or DIRECTV® channel, two or more audio languages are available. Selecting the icon repeatedly scrolls through and plays the options.

If the icon is highlighted when watching an analog (NTSC) TV channel, a Second Audio Program (SAP) is available. Selecting the icon will play the SAP for the current channel until the channel is changed.

Highlighted mail icon Indicates that you have a message in your mailbox from your DIRECTV® programming provider. Select this icon to access the mailbox and read your mail.

AlphaSort™ (A-Z) icon When selected, allows you to sort currently-listed program titles alphabetically.

Highlighted Scout™ (binoculars) icon When highlighted, indicates a Scout has found a program. If selected when highlighted, you view the Scout's results. If you select the icon when it is not highlighted, you can set up a Scout to find a program for you.

Press INFO on the remote control twice to view an expanded channel banner that shows a program description (when available).

BASIC TV OPERATION

CHANGING BETWEEN DIRECTV AND TV MODE

When you change channels by entering numbers with the remote control, you tune to programming that can come from one of three different sources: the DIRECTV satellite (if you have DIRECTV service), a terrestrial off-air antenna, or cable TV. You tune to one of these sources by pressing either TV or DIRECTV on the remote control; then you can enter the channel numbers. The diagrams below show how your remote control communicates with the three sources.

In **DIRECTV mode**, you tune to channels that come from the DIRECTV satellite signal (if you subscribe to DIRECTV® programming). Enter channel numbers that are one to four digits long. Then press OK to tune.

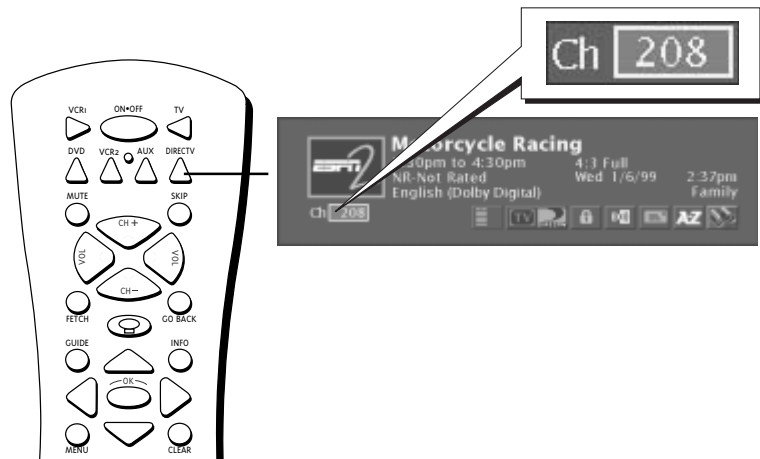

In **TV mode**, you tune to channels that carry the terrestrial off-air or cable TV signal.

- To tune to an analog channel, enter channel numbers that are up to three digits long. Press OK to tune.
- To tune to a digital channel, enter channel numbers that are one, two, or three digits long. If necessary, press the right arrow and enter a subchannel number. These subchannel numbers appear in the box to the right of the primary channel number. Press OK to tune.

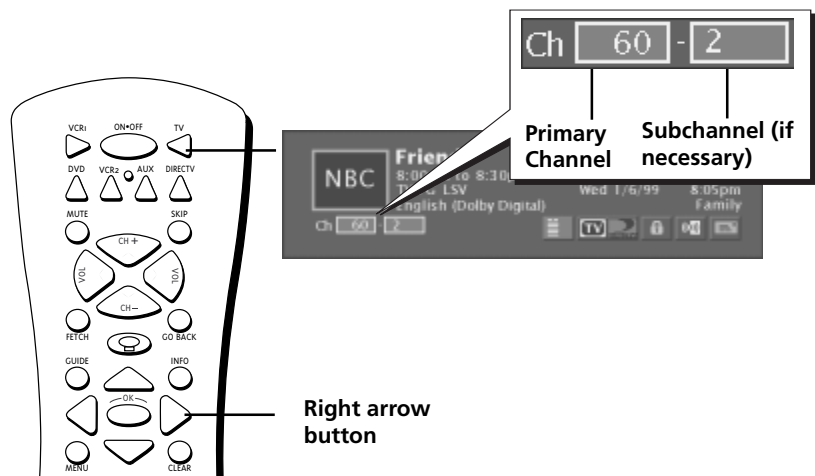

BASIC TV OPERATION

CHANGING CHANNELS

To change channels by entering numbers with the remote control, the remote needs to be in the correct "mode": either DIRECTV mode (if you subscribe to DIRECTV) or TV mode.

When you want to watch DIRECTV® programming, put the remote in DIRECTV mode

1. Make sure the TV is in DIRECTV mode by pressing DIRECTV on the remote control.
2. Enter the channel number and press OK. If you do not enter at least three digits, "???" will appear in the channel entry box, and the system will wait for a valid entry.

When you want to watch a digital or analog TV channel, put the remote in TV mode

If you want to watch a digital channel:

1. Make sure the TV is in TV mode by pressing TV on the remote control.
2. Enter the primary channel number. This number will appear in the primary channel entry box. If there is no subchannel, press OK.
3. If the primary channel number has fewer than three digits and you want to enter subchannel numbers, press the right arrow to advance to the subchannel entry box.
4. Enter the number of the subchannel. This number will appear in the subchannel entry box.
5. Press OK on the remote control to tune to the channel.

If you want to watch an analog channel:

1. Make sure the TV is in TV mode by pressing TV on the remote control.
2. Enter the channel number. This number will appear in the primary channel entry box. (Analog channels don't have subchannels.)
3. Press OK on the remote control to tune to the channel.

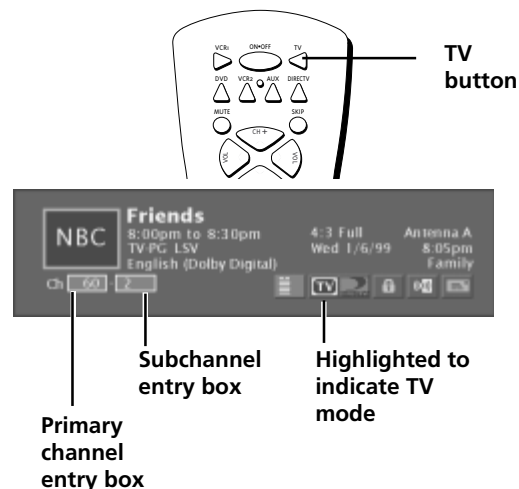
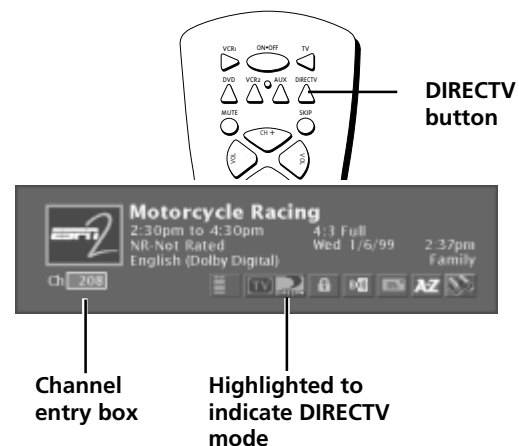

Note that you can always use the channel up and down buttons on the remote control to change channels within the DIRECTV and TV modes.

BASIC TV OPERATION

PIP (PICTURE-IN-PICTURE) OPERATION

The PIP (Picture-In-Picture) feature lets you display a second, smaller analog (NTSC format) picture on top of the main analog picture.

Your TV is equipped with a dual NTSC tuner that tunes to cable or off-air television signals. You will only be able to use the PIP window and main picture with analog channels.

PIP BUTTONS

There are certain remote buttons that control the way the PIP window works:

PIP Brings up the PIP window. Press PIP again to remove the window.

Arrows Let you move the PIP window to different areas of the screen.

SWAP Switches, or "swaps," the video from the PIP window with the main picture.

CH CTRL (Channel Control) Lets you switch channel control between the PIP window and the main picture. To determine whether you are controlling the PIP or the main picture, look at the channel banner as you change channels. The triangular indicator is beside the channel number for the picture you're controlling.

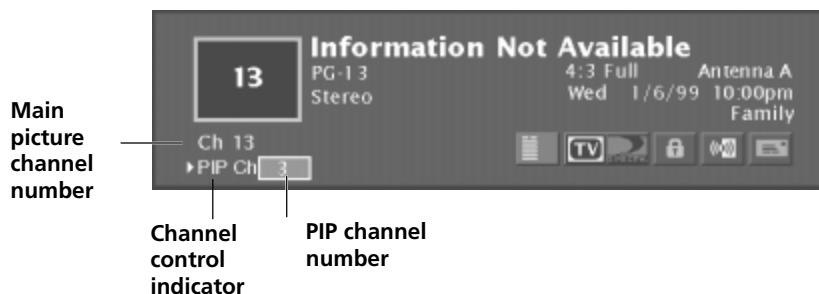

USING THE PIP FEATURE

While you may use PIP in different ways, this basic PIP scenario should get you started. When watching an analog channel, follow these steps.

1. Press the PIP button on the remote control. The PIP window appears on the screen.
2. Use the channel up and down or digit buttons to change the PIP channel.
3. To change the program in the main picture window, press CH CTRL. Then use the channel up and down or digit buttons.

To go back and forth between controlling the PIP window and the main picture, press the CH CTRL button.

Note that you will only be able to use PIP with analog channels.

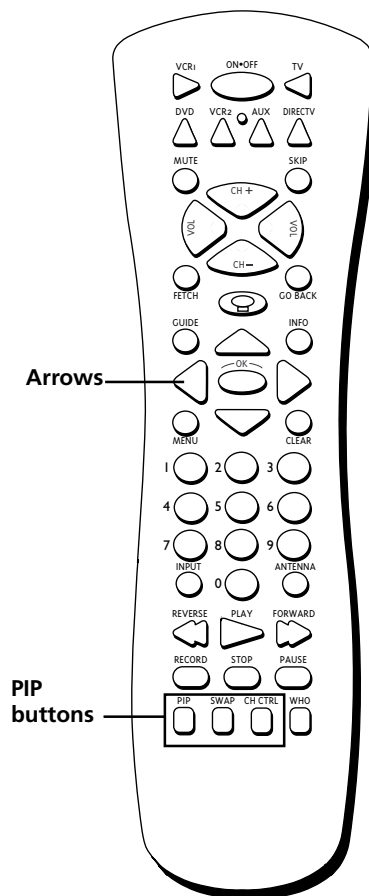

BASIC TV OPERATION

PIP PROBLEMS?

- If you are channel surfing and the PIP disappears, you may have tuned to a digital channel. To view PIP and the main picture, make sure that both the main and PIP channels are analog inputs, or signals. Continue changing the channel until you find an analog (NTSC format) channel. The PIP window will reappear.



The message "PIP Not Viewable or Exceeds Rating" in the channel banner lets you know that PIP is not available on this channel and you should tune to another channel.

- If you press PIP and the PIP box is grayed, you may have movie or TV rating limits set. These limits may block your access to the PIP channel. For information on removing limits, see the section "Using the Profiles."
- If the PIP window disappears when closed captioning is displayed or you press the MUTE button on the remote control, you have a conflict in your settings. You cannot view PIP when parental controls have blocked the current program or closed captioning is displayed. In order to view PIP, either unlock parental controls or change the closed captioning setting.
- You cannot view closed captioning in the PIP window.

BASIC TV OPERATION

USING THE INPUT BUTTON

1. Repeatedly press the INPUT button to scroll through the available input sources until you find the input associated with the component (such as VCR or DVD player) you want to view.

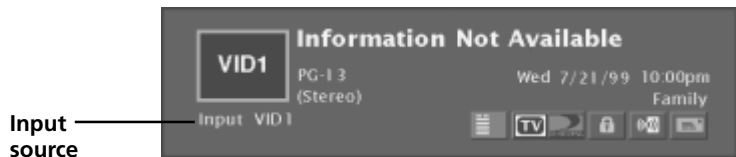

Watch the channel banner to see the input sources change with each press of the INPUT button.

2. Once you have found the input source you want, stop pressing INPUT.
 - If you tune to VID1 and your VCR is connected to that input, you will be able to view your VCR. To play, stop, or rewind the VCR1 tape using the remote that came with your TV, you must first press the VCR1 button to put the remote control in VCR mode.

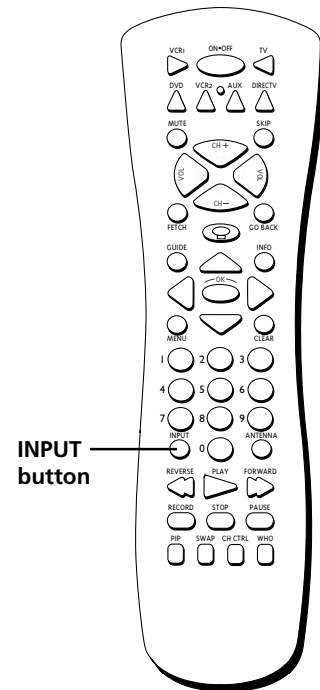

There are other ways of selecting an input channel:

- Program the component (VCR, DVD, etc.) buttons on the remote control to automatically tune to the correct input channel when pressed. See the section in this book, "System Options and Preferences" for information on auto tuning.
- After pressing INPUT on the remote, enter the digits 1, 2, 3, 4, or 5 to tune to (S)VID1, 2, 3, FRONT, or CMPNT respectively.
- After pressing INPUT on the remote, press GUIDE on the remote control to view a guide-like list of your line inputs and corresponding channels.

USING THE PROGRAM GUIDES

WHAT IS A PROGRAM GUIDE?

A program guide is an on-screen programming schedule. It is a list of the current and future programs. There are separate guides for TV programs and DIRECTV® programming (available if you subscribe to DIRECTV® programming).

Both of these guides can be viewed in different formats.

Using the program guides is easy as long as you remember to highlight items on the screen by pressing the arrow buttons on the remote control. Then, press OK to tune to that channel.

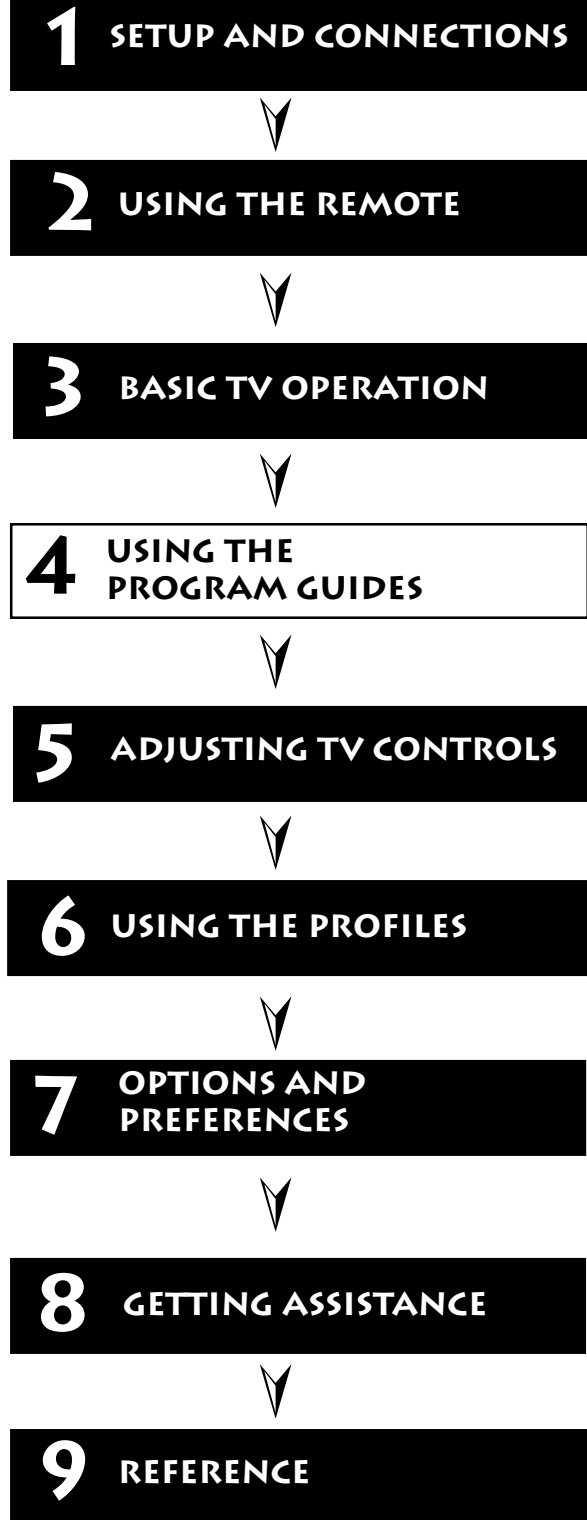

USING THE PROGRAM GUIDES

BRINGING UP THE PROGRAM GUIDES

If you subscribe to DIRECTV® programming, you have access to two program guides: a DIRECTV® programming guide and a TV program guide (for terrestrial programming). If you do not subscribe to DIRECTV® programming, you will have one guide: the TV program guide.

You can access the program guides by:

- Pressing the GUIDE button on the remote control, or
- Pressing MENU on the remote control and selecting *Program Guide*.



Note that when you access a program guide, you view the guide corresponding to the "mode" you are in. For example, if you are in DIRECTV mode and press the GUIDE button, you will view the DIRECTV® programming guide. Similarly, if you are in TV mode and press the GUIDE button, you will view the TV program guide.

If you are viewing the TV program guide and would like to view the DIRECTV guide, press DIRECTV on the remote control to change "modes" and view the DIRECTV® programming guide.

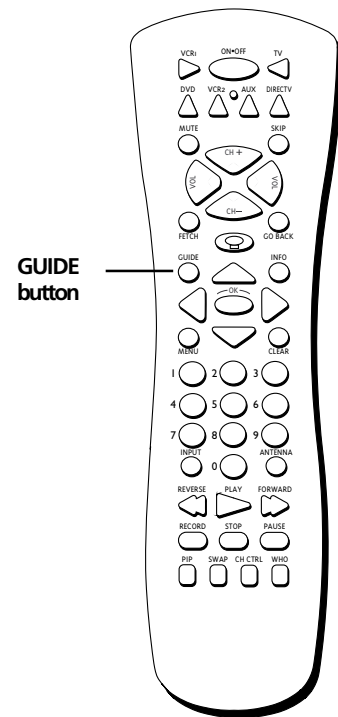

USING THE PROGRAM GUIDES

ANATOMY OF THE TV PROGRAM GUIDE

To access the TV program guide:

1. Press the TV button on the remote control.
2. Press GUIDE on the remote control. The following diagram shows you the kind of information you will see in the TV program guide. Note that the availability of TV program titles and information is dependent upon information provided by local broadcasters.

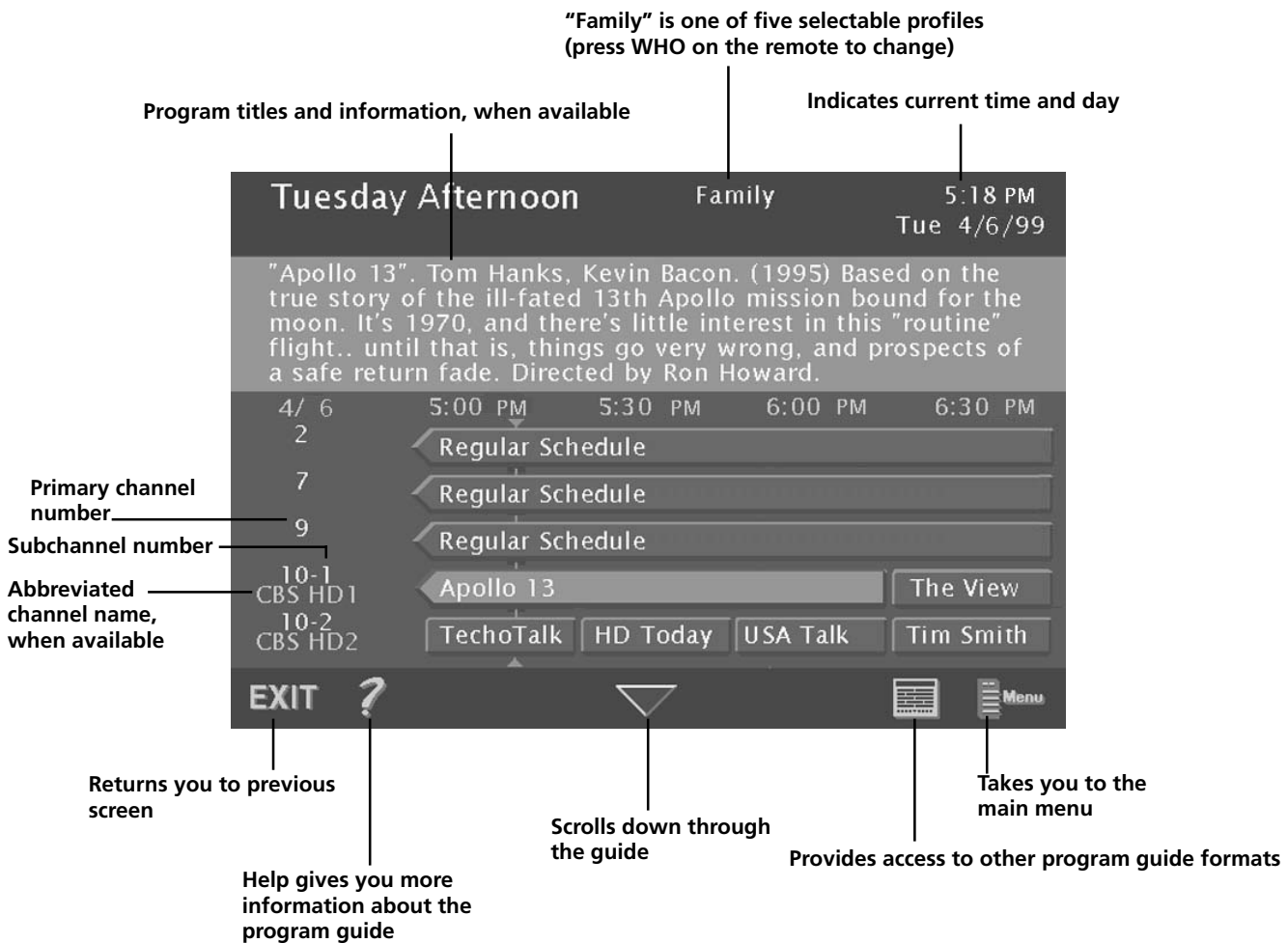

When you are viewing the TV program guide, you can press DIRECTV on the remote control and view the DIRECTV® programming guide if you subscribe to DIRECTV® programming.

USING THE PROGRAM GUIDES

ANATOMY OF THE DIRECTV® PROGRAMMING GUIDE

To access the DIRECTV® programming guide, you must subscribe to DIRECTV® service. Press the DIRECTV button, then press GUIDE on the remote control. The following diagram shows you the kind of information you will see in the DIRECTV® programming guide.

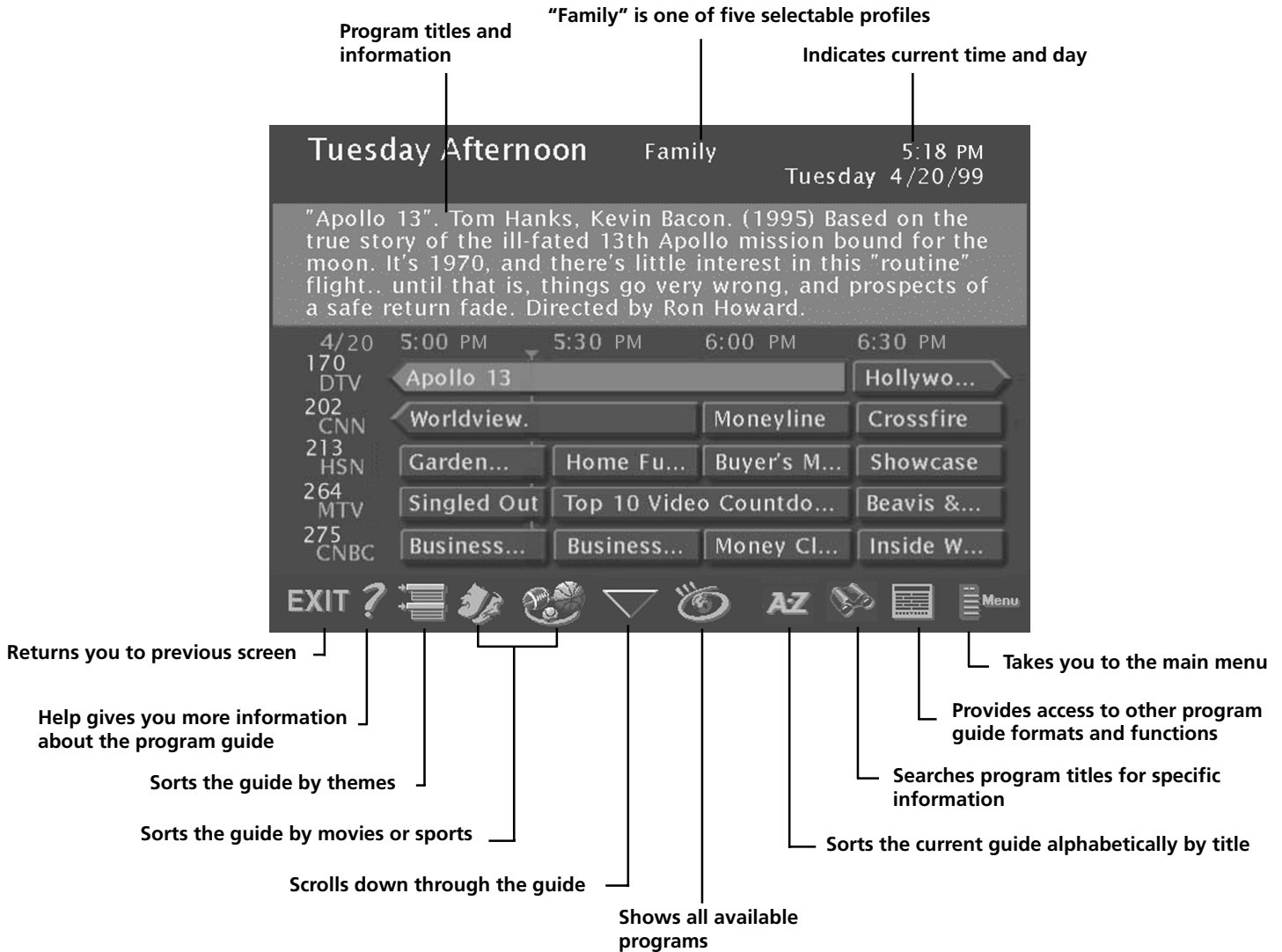

When you are viewing the DIRECTV® programming guide, you can press TV on the remote control and view the TV program guide.

USING THE PROGRAM GUIDES

GETTING AROUND IN THE GUIDES

There are several ways to change channels and move around the TV and DIRECTV® programming guides.

- **Point to channels with the number buttons (0-9)**
You can quickly highlight any channel in the program guides by entering the channel number with the number buttons (0-9). For example, to highlight channel 228, press the numbers 2-2-8 and press OK on the remote control. To highlight channel 73, press 7-3 and OK.
- **Scroll channel by channel**
The programs that you see on the TV screen make up one section—or page—of the total program guide. You can scroll to other sections using the arrows: highlight other times with the left and right arrows; highlight other channels with the up and down arrows.
- **Scroll page by page**
If you want to scroll up or down through the program guides faster, press the channel up and down buttons on the remote control. The highlight scrolls a page at a time.

To view a listing of future programming in the guide, continuously press the right arrow button on the remote control to scroll to the right.

TUNING TO A PROGRAM

- To tune directly to a current program listed in a guide, highlight the program name and press OK.
- To see information about a program or channel in the guide, highlight the program or channel name and press INFO.

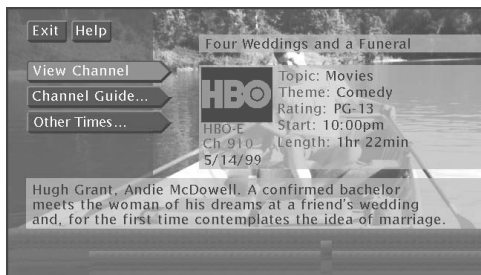

After you highlight a HBO program name and press INFO, the Program Details screen appears and gives you several options.

Then, if the program is not a Pay Per View (PPV) program, your options are to choose:

- *View Channel* to tune to that channel
- *Channel Guide* to see a program lineup for that channel
- *Other Times* to see what other times the program is available

The options available to you may vary according to the type of program you select. If the program is PPV, you will have the option to buy the program.

USING THE PROGRAM GUIDES

USING THE GUIDE BUTTON

Each press of the GUIDE button on the remote control takes you to an alternate type of TV or DIRECTV® programming guide: Detail Guide, SurfGuide™ (DIRECTV only), or Grid Guide.

By default, the Detail Guide appears when you press GUIDE on the remote control. You can change the default guide from the Detail Guide to the Grid Guide or the SurfGuide feature (DIRECTV only) using the following steps:

1. Select *Preferences* from the main menu.
2. Select *Default Guide*.
3. Use the arrows and OK to choose the guide you want to appear first when you press GUIDE. If SurfGuide is selected as the default guide, Grid Guide will appear when you access the TV program guide since the SurfGuide feature isn't available as a TV program guide.

The Detail Guide

The Detail Guide shows five channels in a time-and-channel format, with program information for the highlighted program (if available) at the top of the guide.

The SurfGuide™ (DIRECTV only)

The SurfGuide feature displays seven DIRECTV® channels in a half-hour time-and-channel format, if you subscribe to DIRECTV® programming. The full name of the program and its rating are listed at the bottom of the screen. Press the right arrow button to extend the SurfGuide to show two hours of programming.

The Grid Guide

The Grid Guide shows seven channels in a time-and-channel format, with the full title of the highlighted program at the top of the guide.

THE OTHER GUIDES ICON

The *Other Guides* icon at the bottom of the TV and DIRECTV® programming guides lets you sort the guides by different variables, such as by channels, data, channel lists, and channel groups. You can access these guides by highlighting then selecting the *Other Guides* icon at the bottom of the Detail Guide and Grid Guide.

- **Channel Guide** Displays a channel's DIRECTV® or TV programming schedule in a channel-by-channel format. You may also directly enter channel numbers and press OK to go to another channel's listing.

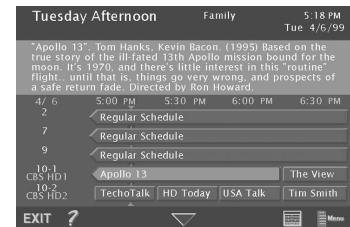

The TV Detail Guide

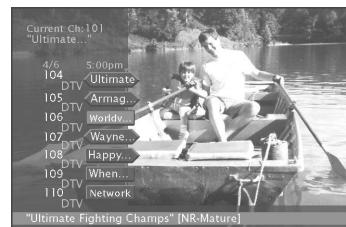

The SurfGuide feature



The TV Grid Guide



Other Guides icon

USING THE PROGRAM GUIDES



Channel Guide lets you see programs on a specific channel.

- **SurfGuide™** (available with DIRECTV only) Displays seven DIRECTV® channels in a half-hour time-and-channel format, if you subscribe to DIRECTV® programming. The full name of the program and its rating are listed at the bottom of the screen. Press the right arrow button to extend the SurfGuide to show two hours of programming.
- **Guide Data** Shows you the future guides that are available and lets you select one to view in either the TV or DIRECTV® programming guide.
- **Channel Lists** Displays a list of profiles. You can choose a profile from this list and the guide will display only the DIRECTV® or TV channels which have been included in that profile's channel list. You can also access profiles by pressing WHO on the remote when in the program guide.
- **Channel Groups** Lets you sort only the DIRECTV® programming guide to include only channels that fall into the selected category. For example, you could sort the DIRECTV® programming guide to show only Pay Per View movies that are available at a future time.
- **Attractions...** Displays a list of DIRECTV® channels that show coming attractions and special events information.

You can highlight any program then tune to that channel by pressing OK or get more information by pressing the INFO button.

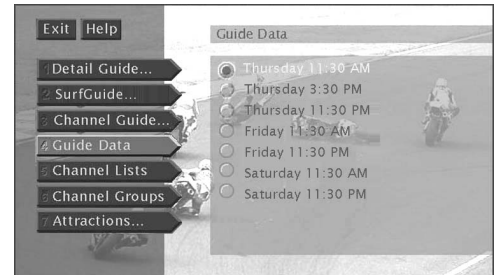

Guide Data shows you future guides.



The Attractions Guide shows coming DIRECTV events and programs.

EXITING A PROGRAM GUIDE

There are three ways to exit a guide:

- Highlight a channel and press OK.
- Highlight *Exit* and press OK.
- Press CLEAR or GO BACK on the remote control.

USING THE PROGRAM GUIDES

SORTING THE DIRECTV® PROGRAMMING GUIDE

Sorting the guide is a way of organizing the DIRECTV® programming guide to show only the types of programs that interest you. There are several on-screen buttons that sort the DIRECTV guide in different ways.



The Sorting icons appear at the bottom of the Grid Guide and Detail Guide.

SORTING THE DIRECTV® PROGRAMMING GUIDE BY TOPICS

The topics icon sorts the DIRECTV® programming guide according to the current user's preferences. Select the topics icon to sort the guide.

After you select the topics icon, it changes to the topics themes icon. Select the topics themes icon to edit the current user's themes preferences. These preferences are saved in each user's profile.



Topics button



Topics themes button

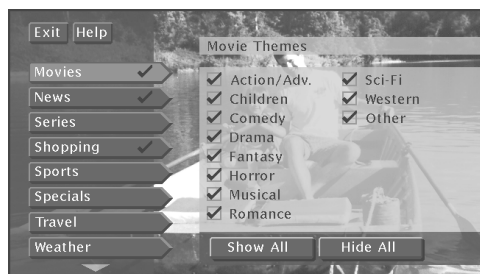

Checkmark the themes that interest you.

Select the topic categories, and checkmark the themes you would like to appear when you select the topics icon in the guides. Programming that fits the description of checkmarked themes will appear in the DIRECTV® programming guide when you sort by the topics icon.

USING THE PROGRAM GUIDES

SORTING THE DIRECTV® PROGRAMMING GUIDE BY MOVIES

Select the movies icon to tell the DIRECTV® programming guide to list only DIRECTV movies. After you select the movies icon, it changes to a movies themes icon.

Select the movies themes icon to sort the guide to list movies by type, such as comedies or musicals.



Select a movie theme that interests you.



Movies icon



Movies themes icon

SORTING THE DIRECTV® PROGRAMMING GUIDE BY SPORTS

Select the sports icon to tell the DIRECTV® programming guide to list only DIRECTV® sporting events. After you select the sports icon, it changes to the sports themes icon.

Select the sports themes icon to sort the guide to list sports by type, such as basketball or soccer.



Select a sports theme that interests you.



Sports icon



Sports themes icon

LISTING ALL DIRECTV® PROGRAMMING

The all icon resets the DIRECTV® programming guide to show all available topics, channels and listings for the current profile.



All icon

USING THE PROGRAM GUIDES

SORTING THE CURRENT DIRECTV® PROGRAMMING GUIDE ALPHABETICALLY

The AlphaSort™ feature lists all the program titles in the current DIRECTV® programming guide in alphabetical order. You can also find this icon in the channel banner. Select the AlphaSort icon to search for specific program titles that are in the current guide. After listing programs whose first letter or number match your entry, AlphaSort lists programs in the current DIRECTV® programming guide that have your entry anywhere in the title.

In the AlphaSort menu, use the arrow buttons on your remote control to highlight a character, then press OK.

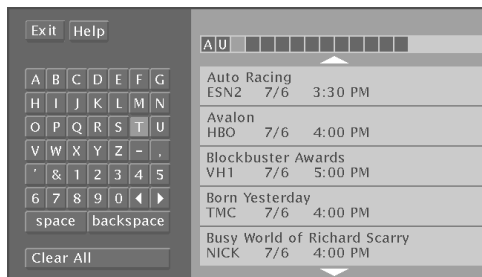

For example, to search for the program Auto Racing, the first letter you should highlight and select is "A." (Words like "The", "A", and "An" appear at the end of a title.) All titles that begin with "A" appear in the AlphaSort list. Next, enter the letter "U". All titles beginning with "AU" appear in the list. Programs that contain "AU" anywhere in their titles will appear at the end of the list.

FINDING DIRECTV PROGRAMS USING SCOUT™

The Scout icon at the bottom of the DIRECTV® programming guide lets you assign "Scouts" to search all DIRECTV® programming guides (both current and future) for very specific program title information.

To use the Scout feature:

1. Highlight the Scout icon in the program guide and select it.
2. Highlight one of the Scout 1-8 menu items from the next screen and press OK. If you're setting up a new Scout, make sure to select a Scout menu item **without** a check beside it, since the check means you have already set up that Scout.

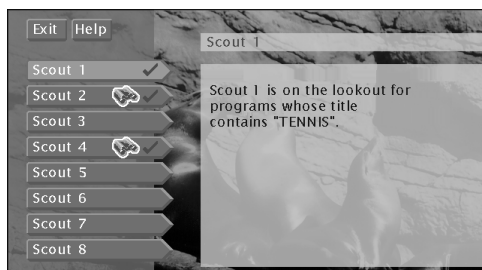

Select a Scout menu item without a check to set up a new Scout.



AlphaSort icon



Scout icon

USING THE PROGRAM GUIDES

3. Select *Enter Text* to set up the information the Scout feature will look for in all program guide titles.
4. Use the on-screen keyboard to enter the desired search parameters. For example, if you are interested in tennis events, enter a common term you might see in program titles, like "tennis."

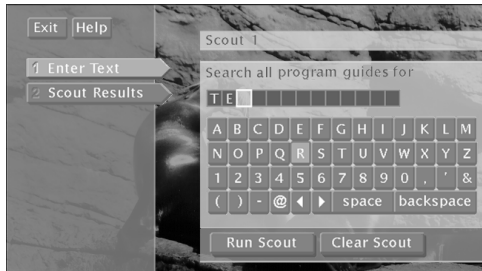

Select *Enter Text* to set up a Scout.

5. Select *Run Scout*. The Scout feature will search for information in all DIRECTV® programming guide titles.
6. Check the Scout search's results by selecting the Scout icon from the program guide or channel banner, then selecting the Scout menu item that has the binoculars icon next to it.
7. Select *Scout Results*. If the characters you entered appear anywhere within a program title, the program will be included in the Scout Results program list. If no match is found, check again after the receiver has been off for approximately 30 minutes.



Scouts look for specific program information.

On-screen icons represent the status of the scout feature:



Indicates the Scout feature is set to find specific information.



Indicates the Scout feature has found the information you specified.

USING THE PROGRAM GUIDES

THE OTHER ICONS

These icons are located on both the DIRECTV and TV program guides.

Exit

Exits the guide and returns you back to where you were before entering the program guides.

Help

Brings up additional information about the guide. Press OK to continue.

Down Arrow

The arrow icon allows you to scroll down through other channels in the guide. Highlight the down arrow, and then press either OK or the down arrow on the remote to scroll down through the program guide.

The Main Menu

Brings up the main menu. Press OK to continue.



Exit icon



Help icon



Arrow icon



Main menu icon

ADJUSTING TV CONTROLS

MAKE ADJUSTMENTS TO YOUR PICTURE AND AUDIO

The following section tells you how to adjust the picture quality and audio quality of your TV.

- The Picture Quality menu contains the controls that let you adjust the picture.
- The Audio menu contains the controls that let you adjust the way the audio sounds.

1 SETUP AND CONNECTIONS



2 USING THE REMOTE



3 BASIC TV OPERATION



4 USING THE PROGRAM GUIDES



5 ADJUSTING TV CONTROLS



6 USING THE PROFILES



7 OPTIONS AND PREFERENCES



8 GETTING ASSISTANCE



9 REFERENCE

ADJUSTING TV CONTROLS

PICTURE QUALITY CONTROLS

The Picture Quality menu contains all of the TV's video configuration controls. To access the Picture Quality menu, press **MENU** on the remote control to go to the main menu, then select *Picture Quality*.

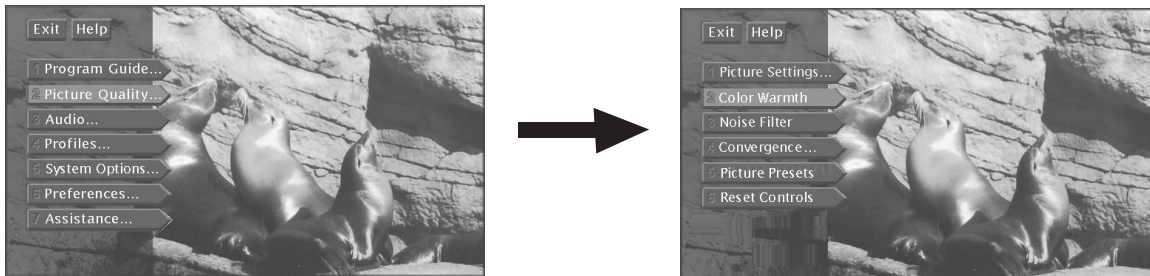

Picture Quality menu for model P61310 is pictured here.

PICTURE SETTINGS

The Picture Settings menu displays the controls for adjusting the way the picture looks. The picture settings you specify apply to your current mode. Use the left and right arrow buttons on the remote control to move the slider to the desired position. Then select *Exit* when you are finished.

Your options under the Picture Settings menu are:

- **Contrast** Adjusts differences between the light and dark areas of the picture.
- **Color** Adjusts the richness of the color.
- **Tint** Adjusts the balance between the red and green levels.
- **Black Level** Adjusts the brightness of the picture.
- **Sharpness** Adjusts the crispness of edges in the picture.

You can have seven different picture settings: one for analog channels, one for digital channels (including DIRECTV channels), and one for components attached to CMPNT (component video input), and INPUT 1, 2, 3, and 4 (FRONT).

To make settings:

1. Enter the "mode" for which you would like to apply the setting (for example, press **DIRECTV** or **TV**).
2. Then press **MENU**.
3. Select *Picture Quality*, and then select *Picture Settings* to set picture settings.

COLOR WARMTH

Color Warmth displays a choice list that lets you set one of three automatic color adjustments: *Cool* for a more blue palette of picture colors, *Normal* for an ordinary picture color, and *Warm* for a more red palette of picture colors. The warm setting corresponds to the NTSC standard of 6500 K and the normal setting corresponds to 9300 K.

ADJUSTING TV CONTROLS

NOISE FILTER

Noise filter displays a list that lets you set one of three automatic settings that allows you to reduce picture "static" or any type of interference. You can set Noise Filter to Off, Low, or High.

Off When set to Off, no noise reduction occurs.

Low When set to Low, the television produces a softer, smoother picture and retains picture sharpness and detail. This is especially useful for providing a cleaner picture in weak analog signal conditions.

High When set to High, the television produces an even softer, smoother picture. This is especially useful for providing a cleaner picture in weak analog signal conditions. However, when Noise Filter is on High, picture detail is somewhat decreased.

CONVERGENCE

Convergence is available in model P61310 only. Selecting *Convergence* lets you adjust the TV's tubes. When the TV tubes' images are precisely aligned, they create the color images you see on the screen. Over time, the picture can drift out of alignment. If your picture seems fuzzy or has a yellow tint, using Convergence could correct this misalignment.

Once you are in the Convergence menu, selecting *Auto Converge* will cause the monitor to self-correct color images. For best results, leave the TV turned on for 30 minutes before running Auto Convergence. Selecting *Blue Centering* or *Red Centering* begins a process that lets you align the red and blue picture tubes to produce the best picture quality. Use the arrows on the remote control to adjust the red and blue projection tubes until the test patterns on the TV screen appear white.

PICTURE TILT

Picture Tilt is available in model F383190 only. Your TV has an extra-large picture tube, which makes it vulnerable to the effects of the Earth's magnetic field. You may need to adjust picture tilt. Use the left and right arrows to adjust the picture tilt.

PICTURE PRESETS

Picture Presets displays a choice list that lets you select one of three preset picture settings: *Bright Lighting*, *Normal Lighting*, *Soft Lighting*, or *Personal Picture Preset*. Based on the degree of lighting in your room, you should choose Bright, Normal, or Soft Lighting. After you select one, the contrast, color tint, black level, and sharpness settings found under the Picture Settings menu are automatically adjusted according to your selection.

RESET CONTROLS

Allows you to reset all picture quality controls to their original defaults.

If you choose *Personal Picture Preset*, you can customize color, tint, black level, and sharpness to your desired level, and the television "saves" those settings. After you've done this, it allows you to go back into the menu and select *Bright*, *Normal*, or *Soft Lighting* when you need to without losing your customized settings. For example, if you normally use *Personal Picture Preset* but wanted to watch a show in *Bright Lighting* today, you can choose *Bright Lighting* now, watch the show, and then afterwards return to your customized settings by choosing *Personal Picture Presets* again.

ADJUSTING TV CONTROLS

AUDIO CONTROLS

The Audio menu lets you adjust the controls that involve the TV's audio outputs. To access the Audio menu, press MENU on the remote, then select *Audio* from the main menu.

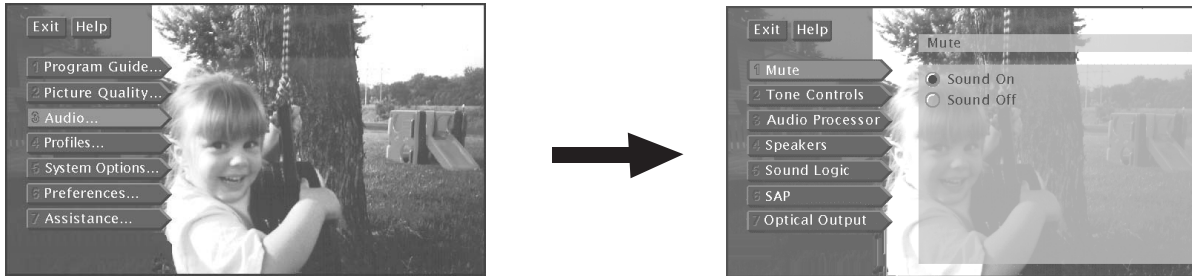

MUTE

Turn Mute on (select *Sound Off*) to set the TV's volume to its minimum level. The same can be accomplished by pressing MUTE on the remote control.

TONE CONTROLS

Lets you adjust the Bass, Treble and Balance. Use the right and left arrow buttons on your remote to adjust the sliders. Increasing the bass and treble output from the TV's internal speakers increases the low and high tones, respectively. Adjusting the balance shifts the audio output between the left and right internal speakers.

AUDIO PROCESSOR

Displays a choice list of available audio modes, which control the way the sound comes through your speakers.

To make settings:

1. Press MENU to access the main menu.
2. Select *Audio*, and then select *Audio Processor*. Depending on your speaker setup, any combination of the following options will appear:
 - *Mono* Plays the sound in monophonic audio only. This should only be used when receiving broadcasts where distance from the broadcasters makes the stereo signal weak. The channel banner displays the word Mono when you tune to a program that is broadcast in mono.
 - *Stereo* Splits the incoming stereo audio signal into left and right front channels. Most TV programs and recorded materials have stereo audio. The channel banner displays the word Stereo when you tune to a program that is broadcast in stereo.

For information on connecting external speakers to your HDTV, see the section "Setup and Connections."

ADJUSTING TV CONTROLS

- ***SRS Stereo (•)** Is an audio processing technology that adds greater depth and stereo separation to stereo audio signals.
- ***SRS Focus (•)** Focuses audio signals by adding treble and making dialog more understandable.

SPEAKERS

Allows you to turn on or off internal speakers.

SOUND LOGIC

Monitors a program's audio track and limits volume excursions to a minimum and maximum volume range from the current volume setting. Acting like a dynamic range limiter, it compresses the dynamic range to limit sudden volume increases, like when a commercial begins.

SAP

When turned on, Second Audio Program (SAP) plays the program's audio in a second language, if one is available. SAP is also used to broadcast a program's audio with descriptions of the video for the visually impaired. SAP is broadcast in mono and is not available for digital programs.

OPTICAL OUTPUT

Select *Auto Select* if your TV is connected to a Dolby Digital[†] and PCM decoder. Your television will automatically choose Dolby Digital or PCM based on the signal source. Select *Dolby Digital* if the TV is connected to a Dolby Digital only decoder; it will provide six independent soundtrack channels through the optical output jack (labeled DIGITAL AUDIO OUT). Select *PCM* if connected to a PCM only decoder; it will then provide two independent soundtrack channels. Select *Off* if you want no audio output provided.

AUDIO LANGUAGE

The Audio Language menu lets you choose the default audio language you want to hear when it is available. The system will automatically set the audio program to the selected audio language when the channel you are viewing is either a DIRECTV or a digital channel and the specified language is available.

In the Audio Language menu, highlight the audio language you want using the up and down arrows, then press OK to select.

For more information on the variable and fixed audio jacks, see the section "Setup and Connections" under "Back of the TV" and "Connecting a Stereo Amplifier."

When the TV is connected to an optional, compatible six-channel amplifier/receiver and speakers via the DIGITAL AUDIO OUT jack on the back panel, you receive Dolby Digital Surround Sound, if transmitted. Use the Optical Output menu to specify Auto Select, PCM, Dolby Digital, or Off.

* SRS, SRS-Focus, Sound Retrieval System, and the SRS logo are registered trademarks of SRS Labs, Inc.

† Manufactured under license from Dolby Laboratories. "Dolby", "Pro Logic" and the double-D symbol are trademarks of Dolby Laboratories. Confidential Unpublished Works. ©1992-1997 Dolby Laboratories, Inc. All rights reserved.

ADJUSTING TV CONTROLS

Icon in the Channel Banner

You will find an audio language icon in the channel banner.



Audio language icon

- If the icon is highlighted while watching a digital (ATSC) or DIRECTV channel, two or more audio languages are available. Selecting the icon repeatedly scrolls through and plays the options.
- If the icon is highlighted when watching an analog (NTSC) TV channel, a Second Audio Program (SAP) is available. Selecting the icon will play the SAP for the current channel until the channel is changed.

USING THE PROFILES

CREATING USER PROFILES

This section describes the user profiles feature. It includes information about:

- creating a profile's TV and DIRECTV viewing lists.
- setting spending limits.
- setting DIRECTV® programming, TV, and movie rating limits.
- blocking unrated TV programs.
- locking and unlocking a profile.

1 SETUP AND CONNECTIONS



2 USING THE REMOTE



3 BASIC TV OPERATION



4 USING THE PROGRAM GUIDES



5 ADJUSTING TV CONTROLS



6 USING THE PROFILES



7 OPTIONS AND PREFERENCES



8 GETTING ASSISTANCE



9 REFERENCE

USING THE PROFILES

ABOUT PROFILES

When you select *Profiles* from the main menu, you can create four different profiles in addition to the default "Family" profile. You can set up specific channels, rating limits, and spending limits for each profile. After you've set up these profiles, exit the menu system. Then, press the WHO button on the remote control to scroll through your profiles and press OK to access a certain one.

But first, personalize a profile by entering a name.

1. Select *Profiles* from the main menu.
2. Select a profile to edit: *User 1*, *User 2*, *User 3*, or *User 4*.
3. Select *Edit User Name* from the next menu.
4. Use the up, down, and right arrows on the remote control to find and select a letter.
5. Press OK.



You can personalize each profile.

To continue editing the profile, select *DIRECTV Setup* (if you have ordered DIRECTV® programming) or *TV Setup*. The following sections describe how to set up these features.

THE DIRECTV SETUP

The DIRECTV Setup menu item is only accessible if you subscribe to DIRECTV® programming. Through this menu you can establish DIRECTV channel lists, set spending limits, and set rating limits for DIRECTV® programs.

EDITING CHANNELS IN A DIRECTV LIST

You should create a DIRECTV channel list to establish which DIRECTV channels the selected profile can access. To create the DIRECTV channel list:

1. Highlight and select a user name, then select *DIRECTV Setup*.
2. Highlight *Edit Channels* and press OK.

Use the MENU button on the remote control to bring up the main menu, use the arrows to highlight an option, and press OK to select it.

If the main menu does not appear, the remote control might not be in TV or DIRECTV mode. Try pressing the TV or DIRECTV button and then MENU.

You can also set up profiles as categories instead of as users. For example, name a profile "Sports" and include only sports channels in the profile. Or, name it "Movies," include only movie channels, and set a rating and spending limit for yourself or your family.

USING THE PROFILES



Check the channels you want to include in the list (programming subject to change).

3. Use the arrow buttons to point to a DIRECTV channel, and press OK to remove (or replace) the check mark. To go directly to a certain channel, enter its number using the digits on the remote control. Or, page through the list using the channel up and down buttons.

Checkmarked items appear in the DIRECTV channel list. In other words, when you select that profile and begin surfing through DIRECTV channels with the channel up and down buttons, only the checkmarked channels will appear as you surf.

SELECTING OR DELETING ALL DIRECTV CHANNELS

You might be able to save time when creating a DIRECTV channel list by using the *Select All Chans* option or the *Delete All Chans* option to either add or delete all channels before removing or adding individual channels.

Also, DIRECTV program providers may make additional channels available. To prevent new channels from appearing in a profile channel list, choose *Delete All Chans* and checkmark only the channels you want to appear in the list.

SETTING THE DIRECTV SPENDING LIMIT

Use the *Spending Limit* option to indicate a profile's per-event spending limit for Pay Per View (PPV) programs. To set the spending limit, choose the user profile name, select *DIRECTV Setup*, then follow these steps:

1. Highlight *Spending Limit*, and press OK.

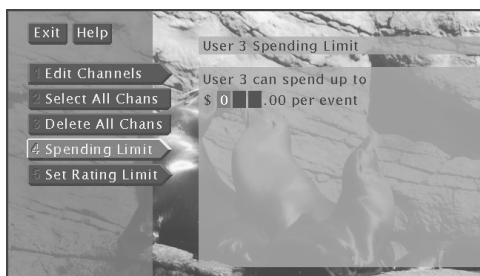

You can set a per-event spending limit for each profile.

Tip

You can also access spending limits by selecting *System Options* from the main menu and then selecting *Purchases*. You can then select *Spending Limit* and set limits for all users from one location instead of accessing each profile individually.

USING THE PROFILES

2. Use the digits or the arrow buttons on the remote control to enter a single-program spending limit.
3. Lock the system. See “Locking the System” near the end of this section for details.

After a spending limit is set and the system is locked, you must enter a password to purchase a Pay Per View program that costs more than your spending limit allows. The system will then temporarily unlock the limits you have set until the power is turned off. When the system is turned back on, the system will be locked again.

SETTING THE DIRECTV RATING LIMIT

The Set Rating Limit menu enables you to set a maximum viewing limit for rated movies (based on the MPAA ratings system).

- Note that the rating limit cannot be enforced if a program has not been rated, if rating information for that program is not transmitted by the program provider, or if the system has not been locked.
1. Select a user.
 2. Select *DIRECTV Setup*.
 3. Highlight *Set Rating Limit* and press OK.

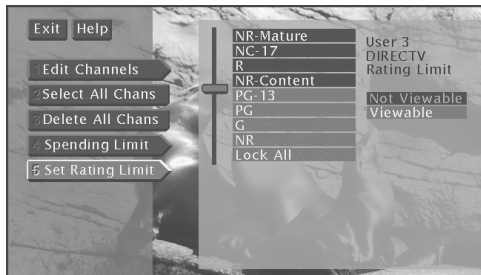

Use the arrow buttons on the remote control to move the selector up and down.

4. Use the up and down arrows to move the rating selector to the highest rating you want to be able to view. In the preceding illustration, movies that are rated up to and including a PG-13 rating can be viewed.

After the rating limit is set and the system is locked, you must enter the system password to watch programs with a rating higher than the limit. The system will then temporarily unlock the limits you have set until the power is turned off. When the system is turned back on, the system will be locked again.

Important!

You need to lock the system in order for rating limits, channel limits, and spending limits to go into effect.

To edit the limits after you lock the system, you need to enter the system password, See “Locking the System” for details.

Please note that the rating limit you set while in the DIRECTV Setup menu applies only to the selected profile and to DIRECTV® programs—it does not apply to TV programs.

To set limits for TV programming, select a profile, select *TV Setup* and then select *Set TV Rating* or *Set Movie Rating*.

USING THE PROFILES

THE TV SETUP

You can establish TV channel lists, set spending limits, and set rating limits for TV programs using the TV Setup menu.

EDITING CHANNELS IN A TV LIST

You should create a TV channel list to establish which TV channels (including both analog and digital) the selected profile can access. To create the TV channel list:

1. Select a user.
2. Select Edit Channels.



To start, you can add or delete all channels.

3. Use the arrow buttons to highlight a TV channel, and press OK to remove (or replace) the check mark. To go directly to a certain channel, enter its number using the digits on the remote control. Or, page through the list using the channel up and down buttons.

Checkmarked items appear in the channel list. In other words, when you select that profile and begin surfing through TV channels, only the checkmarked channels will appear as you surf. Note that the only channels you can add to a list are ones that were found during the channel search (see the "Getting Assistance" section in this book for details on automatically searching for channels).

SELECTING OR DELETING ALL TV CHANNELS

You might be able to save time when creating a TV channel list by using the *Select All Chans* option or the *Delete All Chans* option to either add or delete all channels before removing or adding individual channels.

Also, terrestrial program providers may make additional channels or subchannels available. To include new channels in your TV channel list:

1. Select *System Options* from the main menu, then select *Channel Search*. The system will run a channel search, making it aware of the new channel(s).
2. Select *Profiles* from the main menu.
3. Select the user profile name, then *TV Setup*.
4. Choose *Edit Channels* and checkmark the new channel.

Note that if you're using two terrestrial antennas, pressing the ANTENNA button on the remote allows you to edit the other antenna's channel list when you are in TV mode.

Another way to add a channel to the channel list is to directly tune to it using the digit buttons on the remote control. If the system can obtain that channel's signal, that channel will be added into the channel list.

Don't forget about the CLEAR button. Press the CLEAR button on the remote control to remove the on-screen menus and return to normal viewing.

USING THE PROFILES

SETTING THE TV RATING

The Set TV Rating menu enables you to program your TV so children cannot see certain programs or channels.

The last three choices in the TV Setup menu involve software inside your TV (often called V-Chip) which allows you to “block” TV programs and movies based on violence, sex, or other content you may believe children should not view. In other words, it lets you program your TV so it will not display certain programs. Once you block programs, you or other adults are not limited to only parent-approved programs; you can “unblock” programs by entering the system password.

The V-Chip software inside your TV is initially turned “off,” so if you choose not to implement it, you can just ignore it.

When turned “on,” the V-chip software reads a code that most broadcasters send with programs. That code tells the V-Chip software the program’s age-based rating (TV-MA, TV-14, etc.) and content themes (Violence (V), Adult Language (L), etc.). If you have blocked the rating or content themes that the program contains, you will receive the message, “Program exceeds the TV rating limit you set,” when you turn to that particular channel. Broadcasters are not required to provide ratings. However, you can block out programs that have been given a rating of “Not Rated,” and programs that are considered “unrated” because no code has been sent by the broadcaster.

The TV age-based ratings and content themes you can block are listed in the table below.

Age-Based Rating	Description and Content Themes for Age-Based Ratings
TV-MA	Mature Audience Only. Specifically designed to be viewed by adults and may be unsuitable for children under 17. It contains one or more of the following content themes: crude indecent language (L), explicit sexual activity (S), or graphic violence (V).
TV-14	Parents Strongly Cautioned. Contains some material that many parents would find unsuitable for children under 14. Parents are strongly urged to exercise greater care in monitoring this program and are cautioned against letting children under the age of 14 watch unattended. This program contains one or more of the following content themes: intensely suggestive dialogue (D), strong coarse language (L), intense sexual situations (S), or intense violence (V).
TV-PG	Parental Guidance Suggested. Contains material that parents may find unsuitable for younger children. Many parents may want to watch it with their younger children. The program contains one or more of the following content themes: some suggestive dialogue (D), infrequent coarse language (L), some sexual situations (S), or moderate violence (V).
TV-G	General Audience. Most parents would find this program suitable for all ages. It contains little or no sexual dialogue (D), no strong language (L) or situations (S), and little or no violence (V).
TV-Y7	Directed to Children 7 years and older. Designed for children ages 7 and above. It may be more appropriate for children who have acquired the developmental skills needed to distinguish between make-believe and reality. Themes and elements in this program may include mild fantasy violence (FV) or comedic violence, or may frighten children under the age of 7.
TV-Y	All Children. Themes and elements in this program are designed for a young audience, including children from ages 2-6. It is not expected to frighten younger children.

USING THE PROFILES

To set TV programming limits:

1. From the main menu, select *Profiles*.
2. Select the user name you would like to set limits for through the *Profiles* menu.
3. Select *TV Setup* from the next menu.
4. Select *Set TV Rating*.

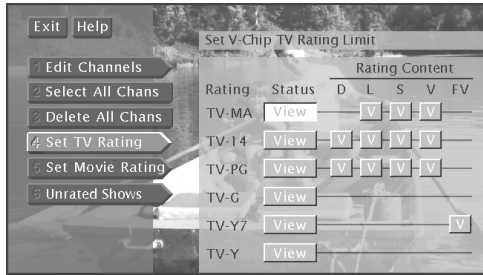

Selecting *TV Rating* allows you to set a limit for TV programs based on rating and content.

Remember you are only blocking TV programs and movies for the one Profile you select in the Profiles menu. If you would like to block different programs for different users, be sure to complete the process for each of them.

Once you get to the Set TV Rating screen, use the arrows and OK buttons on your remote control to change the status of a TV program rating from *View* to *Block*. The following sections give you more details about how to change the status of TV program limits.

THE RATING LIMIT SCREEN

Below is an example of where items are located within the Rating Limit screen.

You must remember to lock the system for rating limits to take effect.

Age-Based Rating Limit

Lists the available ratings you can block or view with the rating status buttons.

Rating Status Buttons

Lets you know whether the status of the age-based rating limit to the left is *View* or *Block*.

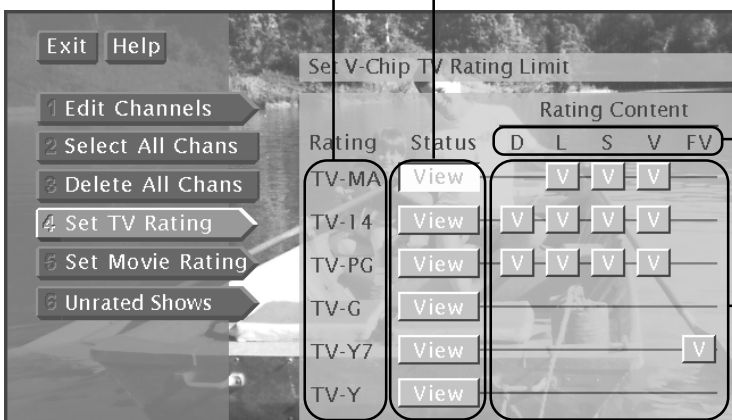

Content Themes

Lists the content themes you can block or view with the content status buttons.

Content Status Buttons

Lets you know which content themes are available for that rating, and whether the status of the content theme is *View* (V) or *Block* (B).

USING THE PROFILES

BLOCKING AGE-BASED RATINGS

You can automatically block all program ratings above a specified age-based rating level. For example, if you only want your child to watch programs that have a TV-G rating and lower (in other words, you want the child to watch only TV-G, TV-Y7, and TV-Y programs), then you need to block other programming with higher ratings.

To block programs with higher ratings:

1. First, determine the lowest level rating you do not want the child to watch.
2. Highlight the rating status button that corresponds with the lowest rating you do not want the child to watch. (In the example above, you would point to the rating status button corresponding to TV-PG, since the highest rating you want her to watch is TV-G.)
3. Press OK to change the button from *View* to *Block*. The status for this and all higher ratings automatically change to *Block* (and *B*).

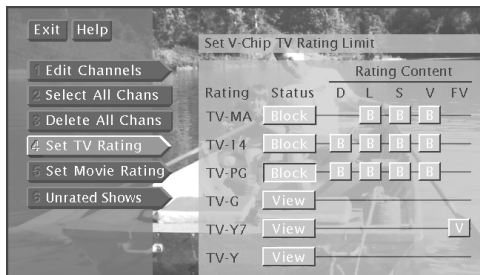

Changing the TV-PG rating status button from View to Block causes the buttons for the higher ratings and content to change to Block and B.

4. Press the left arrow button on the remote control to return to the menu.

Viewing Age-Based Ratings

After you block age-based ratings, you have the option of going back and changing some of the ratings to *View*.

1. Determine the rating you want to view that is currently blocked.
2. Use the arrows on the remote control to highlight the rating status button, such as TV-14, whose status is *Block*.
3. Press OK to change the status to *View*. Your child would then be able to watch all programs with a TV-14, TV-G, TV-Y7, and TV-Y rating.

Note that the content theme buttons corresponding to TV-14 change to *View* as well. They and the age-based rating status buttons are the only buttons that automatically change back to

When you change the status of a rating to **Block**, the system will automatically block higher ratings and all corresponding content themes.

Hierarchy of Age-Based Ratings	
TV-MA	Mature Audience Only
TV-14	Parents Strongly Cautioned
TV-PG	Parental Guidance Suggested
TV-G	General Audience
TV-Y7	Directed to Children 7 Years and Older
TV-Y	All Children

USING THE PROFILES

Blocking Specific Content Themes

You can block programs based on their content. (Content is represented by the D, L, S, V, and FV on your screen. See "Setting the TV Rating" for details.) When you block a content theme for a particular rating, you automatically block that content theme for higher rated programs as well.

For example, if you do not want your child to watch programs that have adult language (L) rated TV-PG or higher, you need to block adult language in all programming rated TV-PG and above.

To block program content:

1. Determine the lowest level of content you do not want the child to watch.
2. Highlight the content button that corresponds with the lowest content you do not want the child to watch. (In the example above, you would highlight the V button located under the L and to the right of TV-PG.)
3. Press OK to change the button from V to B. All higher ratings' language content theme button will automatically change to B.

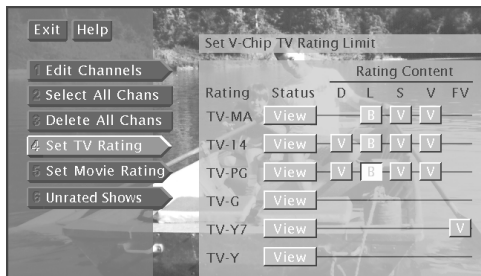

Selecting the content theme button corresponding with adult language (L) and TV-PG blocks all programs with adult language (L) rated TV-PG and higher.

4. Press the left arrow to return to the menu or exit the screen.

Viewing Specific Content Themes

After you block specific content themes, you have the option of going back and changing some of the content themes back to View (V):

1. Determine the content themes you want to change to View (V).
2. Use the arrows to highlight a particular content button, such as the B under language (L) corresponding with TV-14.
3. Press OK to change its status back to V. Your child would then be able to watch programs with TV-14 adult language content, but not programs with TV-PG or TV-MA language content.

Note that only the content theme status button corresponding to TV-14 language (L) changes to View (V). Higher rated content theme buttons, such as that for TV-MA language, do not change.

You must remember to lock the system for rating limits to take effect.

Content Themes	
D	Sexually Explicit Dialogue
L	Adult Language
S	Sexual Situations
V	Violence
FV	Fantasy Violence

USING THE PROFILES

SETTING THE MOVIE RATING

You set movie rating limits by blocking movies rated above a specified level. To access the Set Movie Rating menu:

1. From the main menu, select *Profiles*.
2. Select the user for whom you would like to set limits.
3. Select *TV Setup* from the next menu.
4. Select *Set Movie Rating*.

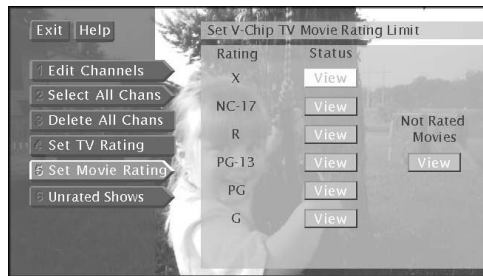

Selecting *Set Movie Rating* allows you to set a limit for movies based on rating.

Please note that the rating limits you set while in the TV Setup menu apply only to TV programs—they do not apply to DIRECTV® programs.

To set limits for DIRECTV® programming, select a profile, select *DIRECTV Setup* and then select *Set Rating Limit*.

Blocking Movie Ratings

If you only want your child to watch movies that have a PG rating and lower (in other words, movies rated PG and G), then you can automatically block out all other movies with higher ratings.

To block movies:

1. Determine the lowest level rating you do not want the child to watch.
2. Highlight the rating status button corresponding to the lowest rating you do not want the child to watch. (In the example above, you would highlight the rating status button corresponding to PG-13, since the highest rating you want the child to watch is PG.)
3. Press OK to change the button from *View* to *Block*. All higher ratings' *View* buttons will automatically change to *Block*.



Change the button from *View* to *Block* and all higher rated movies will also be blocked.

You must remember to lock the system for rating limits to take effect.

4. Press the left arrow to return to the menu or exit the screen.

USING THE PROFILES

Viewing Moving Ratings

After you block movie ratings, you have the option of going back and changing some of the rating status buttons back to View:

1. Determine the movie ratings you want to change to *View (V)*.
2. Use the arrows to highlight the status button you want to change.
3. Press OK to change its status back to *View*.

For example, if movies with a rating of PG-13 and higher are blocked, you can change the rating status button corresponding with NC-17. Your child would then be able to watch all movies with a G, PG, and NC-17 rating.

Some movies may be given a "Not Rated" rating. After blocking movie ratings, you must separately set "Not Rated Movies" to View to see these movies.

BLOCKING UNRATED TV SHOWS

Some TV programming is not rated and may contain material you do not want your children to see. These shows must be blocked separately.

To block unrated shows:

1. Select the user you would like to set limits for through the Profiles menu.
2. Select *TV Viewing*.
3. Select *Set TV Rating*.
4. Now select *Unrated Shows*.
5. Highlight the radio button beside your choice of *View Unrated Shows* or *Block Unrated Shows* and press OK to select it.

Note that "unrated" TV shows may include news, sports, political, religious, local and weather programs, emergency bulletins, public announcements, and programs sent without ratings. It could also include programs whose ratings are either "None" or "N/A."



Selecting *Unrated Shows* allows the user to view or block all unrated programs.

USING THE PROFILES

CHOOSING YOUR PROFILE

Each time you turn on the TV, the Family profile is selected by default. To select a different profile:

1. Press the WHO button to scroll through the profiles in the channel banner.

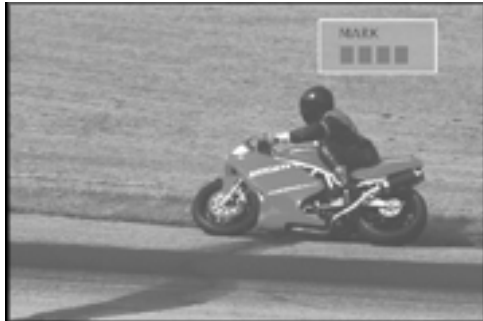

The WHO button toggles through the profiles.

2. When your profile appears, enter your four-digit personal password to access your profile. If the profile is not password protected, you can just press OK to activate it.

The channel, spending, ratings and viewing limits associated with the chosen profile will be active only when the system is locked.

USING THE PROFILES

LOCKING AND UNLOCKING A USER PROFILE

When you lock a profile, you prevent anyone who does not know the user password from accessing the locked profile. This applies only when they press WHO on the remote control. It does not prevent them from accessing and editing the profile via the main menu if they first enter the system password.

When you lock a profile (excluding "Family"), you lock its channel limits, rating limits, and spending limits. After locking the profile, you need to enter the system password to edit these settings.

1. Choose the profile you want to lock or unlock from the Profiles menu, highlight *Lock User* or *Unlock User*, and press OK.

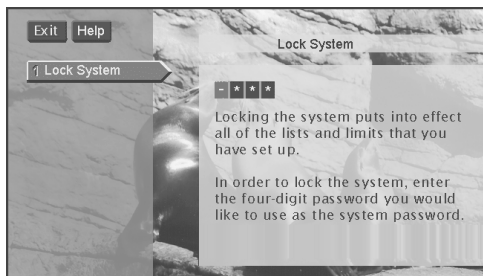

Locking the user profile protects the limits you set up.

2. When locking a user, use the arrows or the digits on the remote control to enter a four-digit user password.

Some other things to remember about locking and unlocking profiles are:

- For a lock to be effective, you must exit out of the menu system.
- When you attempt to access a profile's channel that is blocked by one or more limits and the system is locked, you will be asked to unlock the video by entering the SYSTEM password.
- If you enter the system password to override a limit, the lock on the channel banner will turn yellow, and all limits are temporarily unlocked until you turn off the television. When you turn on the television again, the system will be locked, and the Family profile channel list will be active. If you want to re-lock without turning off the television, you can select the lock icon in the channel banner.
- If a profile is locked and you want to access its channels, press WHO on the remote control and then enter the user password.
- If a profile is locked and you want to access its settings, you can access it through the menu system by choosing *Profiles*, then choosing the profile name. Then enter the system password.

Don't Forget Your Password

If you forget a USER password and the system is locked, you need to unlock the system and then assign a new user password. If the system is not locked, select *Profiles* from the main menu, choose *Unlock User*, and enter a new password.

USING THE PROFILES

LOCKING THE SYSTEM

When you lock the system, all limits set up for all profiles are put into effect, regardless of whether the profile is locked or unlocked. Unlocked profiles require no user password to access their channel list if the system is locked.

When the system is locked, you can still access a profile and watch a channel in its channel list (if the profile is locked, however, you must have the user password). Locking the system activates all rating, spending, viewing, and channel limits for all profiles. When you lock the system, no one can modify any of these settings without first entering the four-digit system password.

1. Select *Profiles* from the main menu. Then select *Lock System* and press OK. Or, press INFO on the remote control and select the green unlock icon from the channel banner.

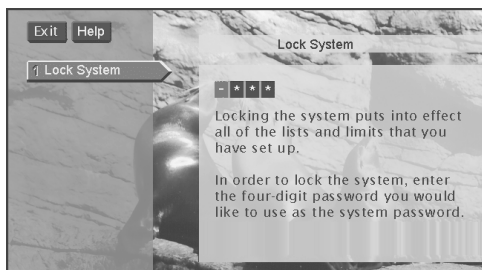

You can lock the system via the channel banner by entering a password.

2. Use the arrows or the digits to enter a four-digit system password.
3. Enter the password a second time to confirm it.

For the changes to be effective, you must exit out of the menu system.

UNLOCKING THE SYSTEM

When the system is unlocked, the channel, spending, viewing, and ratings limits that you set are no longer in effect. To unlock:

1. Highlight *Unlock System* in the Profiles menu and press OK.
2. Highlight *Yes* and press OK to confirm that you want to unlock the system.

When you attempt to access a channel that is blocked by one or more limits and the system is locked, you will be asked to temporarily unlock the system by entering the four-digit system password.

If you enter the system password to override a limit, all limits are unlocked until you turn off the TV. When you turn on the TV again, the system will be locked, and the Family profile channel list will be selected. If you want to re-lock the system without turning off the TV, you can select the lock icon in the channel banner.



The Lock/Unlock icons in the channel banner are an easy way to lock or unlock the system. Press INFO and select the icon to change the lock status.

- *Green Unlock icon*
The system is unlocked. Spending, viewing and other limits can be accessed and changed.
- *Yellow Unlock icon*
A password has been entered to override limits. No limits can be accessed or changed in the menu without a system password.
- *Red Lock icon*
Limits cannot be accessed or changed without the system password and all limits are in effect.

If you subscribe to DIRECTV® programming and forget the SYSTEM password, contact your satellite program provider's authorization center.

If you forget the system password and do not have DIRECTV® programming, remove the access card from the TV's back panel (store it in a safe place, or reinsert it upside down to store it in the TV). Press and hold the INFO button on the front panel; simultaneously press and hold the WHO button on the remote control. Continue to hold for three seconds. All passwords will be cleared.

OPTIONS AND PREFERENCES

DIFFERENT WAYS TO ADJUST YOUR HDTV

This chapter describes the other options available to you such as:

- selecting a signal source and type
- auto tuning your remote control to tune to the VCR1, VCR2, or DVD channel
- searching for all available channels
- checking your mailbox
- purchasing programs
- setting up personal preferences
- using the FETCH button on the remote control

1 SETUP AND CONNECTIONS



2 USING THE REMOTE



3 BASIC TV OPERATION



4 USING THE PROGRAM GUIDES



5 ADJUSTING TV CONTROLS



6 USING THE PROFILES



7 OPTIONS AND PREFERENCES



8 GETTING ASSISTANCE



9 REFERENCE

OPTIONS AND PREFERENCES

CHANGING THE SIGNAL SOURCE

The Signal Source menu allows you to choose the source from which you would like the signal to come: Antenna A, Antenna B, DIRECTV, or Video Inputs. The same can be accomplished using the ANTENNA, DIRECTV, and INPUT buttons on your remote control. If you misplace your remote control, use the front panel buttons to access this menu and change the signal source.

To access the Signal Source menu:

1. Press MENU on the remote control to access the main menu.
2. Select *System Options* from the main menu.
3. Select *Signal Source* from the next menu.

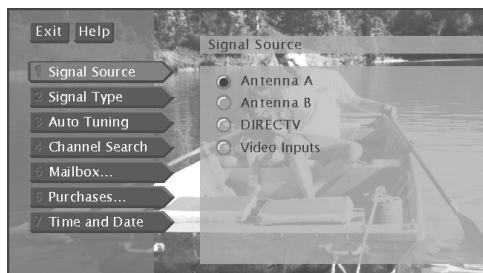

Select the appropriate signal source.

4. Use the arrows and OK to select which source from which you would like to receive a signal.

CHANGING THE SIGNAL TYPE

The Signal Type menu lets you choose whether you are receiving a signal from cable TV or an off-air antenna. When you run Channel Search (see "Channel Search" in this section for details), the TV automatically detects your signal and you don't have to specify it here. However, if you decide to change the source, you will need to use the Signal Type menu. Note that when your signal source is coming from DIRECTV, this menu will not be available.

Note that viewing a VCR while in AIR mode may result in poor picture performance. If you have a VCR connected to Antenna A or Antenna B, set the Signal Type to Cable for that Antenna.

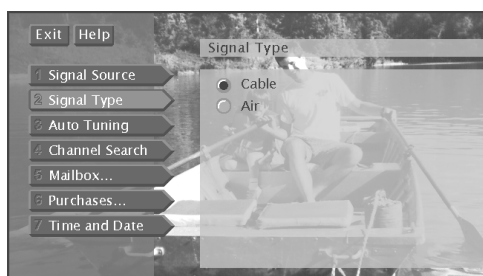

Select whether you are receiving signals from an off-air antenna or cable.

OPTIONS AND PREFERENCES

AUTO TUNING

This menu displays the various components you have connected to your TV. It lets you set up the TV to automatically tune to the correct input channel when you press a device button (VCR1, VCR2, or DVD) on the remote control.

1. Use the arrow buttons on the remote control to highlight the field corresponding with a device.

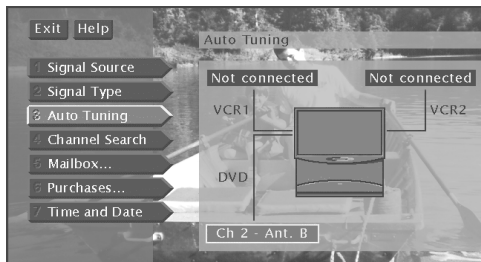

Selecting any of the fields on this screen enables you to specify which input or channel the component will use.

2. Press the OK button on the remote to choose which input channel you want to tune to when you press that device button. Choices for each device are:

Not Connected Select this if you don't have that device connected to the antenna or video input jack on the back of the TV or if you don't want the TV to tune to a channel when the particular device button (VCR1, VCR2, or DVD) is pressed.

Ch 2 (or 3 or 4) - Ant A Select this if your device is connected to Antenna A on the back of the TV and you want the TV to tune to channel 2 (or 3 or 4) when you press the device button (VCR1, VCR2, or DVD).

Ch 2 (or 3 or 4) - Ant B Select this if your device uses Antenna B on the back of the TV and you want the TV to tune to channel 2 (or 3 or 4) when you press the device button (VCR1, VCR2, or DVD).

Video INPUT 1 (or 2 or 3) Select this if your device is connected to the Video INPUT 1 (or 2 or 3) jack on the back of the TV and you want the TV to tune to the input channel VID1 (or VID2 or VID3) when you press the button. If you have an S-Video cable connected, the input channel will read S-VID1 (or S-VID2 or S-VID3).

Cmpnt Video (Component Video Input) Select this if your device is connected to the COMPONENT VIDEO INPUT jack on the back of the TV and you want the TV to tune to the input channel CMPNT when you press the device button (VCR1, VCR2, or DVD).

3. Now you can use the device buttons (VCR1, VCR2, or DVD) on the remote control to tune to the correct input channel when you press the button.

If you have programmed your remote control and completed the above steps to auto tune, you can—for example—press the VCR button and both tune to the VCR's input channel and enter into "VCR mode." You can then begin using the REVERSE, PLAY, FORWARD, RECORD, STOP, and PAUSE buttons to control your VCR.

Reminder: Make sure the Ch 2/3/4 switch on the back of the component is set to the channel you specify in the Auto Tuning screen.

OPTIONS AND PREFERENCES

CHANNEL SEARCH

Engaging in a channel search tells the TV to search automatically for all the terrestrial TV channels available through the antenna inputs. When the TV finds an active channel, it places it in the channel list. Inactive channels (weak stations or channels with no signal at all) will not be placed in the channel list.

The Channel Search screen lets you choose to do either a Full Search or a Quick Search. A Full Search searches both Antenna A and B, automatically detects whether you are using cable or an off-air antenna, and may take many minutes. Quick Search searches only for channels on the antenna you're currently using and uses the current Air or Cable setting. Quick Search is also completed faster than a Full Search and is needed after you adjust a terrestrial antenna for optimum reception.

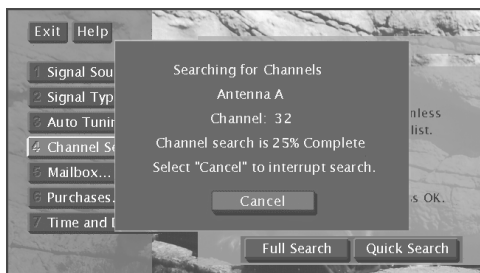

Running Channel Search collects all available TV channels in a channel list.

You can also edit the TV channel list and remove unwanted channels by using the Profiles menu.

Another way to add TV channels is to directly tune to them using the digit buttons on the remote control. If the system can obtain that channel's signal, it will be added into the channel list.

MAILBOX

If you have ordered DIRECTV® programming, the mailbox shows you messages that are sent—or “mailed”—from your program providers. For example, you may receive a message calling your attention to a new service or special program offering. If you have new or unread mail, the mail icon in the channel banner is highlighted.

CHECKING YOUR MAIL

1. Select *Mailbox* from the System Options menu or the mail icon from the channel banner to view your mail.
2. Highlight a message and press OK. The message opens for you to read.
2. Press OK again to close the message.
3. If you want to erase a message, highlight *Erase Message* and press OK. When you exit the display screen, messages not erased are saved in memory.

OPTIONS AND PREFERENCES



Mail provides the latest information from program providers.

PURCHASES: PAY PER VIEW PROGRAMS

Pay Per View programs (PPV) are DIRECTV programs that you purchase—like a movie ticket—if you subscribe to DIRECTV® programming. You can preview movies on certain channels to determine if you would like to purchase them.

You may need to enter your four-digit system password to order a PPV program if it costs more than the spending limit you set up in the Profiles menu.

PREVIEWING AND PURCHASING

You can preview and purchase DIRECTV® Pay Per View movies and events if you subscribe to DIRECTV® programming.

To preview a movie or event:

1. When in the DIRECTV program guide, use the down arrow on the remote to move the highlight to the bottom of the screen.
2. Select the *Other Guides* icon.



The *Other Guides* icon

3. Select *Attractions Guide* and select a channel to preview.



The *Attractions Guide* gives you a choice of which channel to preview.

OPTIONS AND PREFERENCES

To purchase a movie or event, you can take one of two actions:

- Tune to a PPV by channel surfing within DIRECTV® channels and finding a PPV channel. When you find it, press the INFO button find more information and details about how to purchase it.
- or-
- Highlight a PPV program from the DIRECTV program guide and press INFO. The Program Details screen will appear and give you more information about the program. From this screen you can also purchase the program.

You need to connect your phone line to your television to be able to order PPV programs using the on-screen menus.

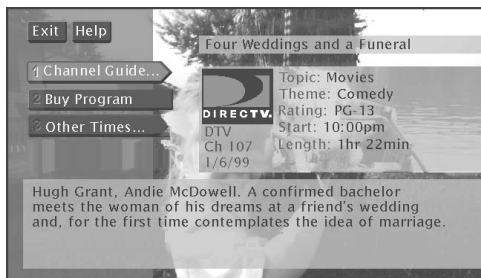

Use the program guide to get to the Program Details screen.

From the Program Details screen, you can select:

- *Channel Guide* to see a program lineup for that channel
- *Buy Program* to purchase the program
- *Other Times* to see what other times the program is available

The options available to you may vary according to the type of program you select.

OPTIONS AND PREFERENCES

USING THE ATTRACTIONS GUIDE

Your program providers may offer future programming events not currently listed in your DIRECTV program guide. These events are called "coming attractions" and can be previewed in the Attractions Guide. To access the Attractions Guide:

1. Press the DIRECTV button on the remote control. Then press GUIDE.
2. Use the down arrow icon to move the highlight to the bottom of the screen.
3. Select the *Other Guides* icon.
4. Select *Attractions Guide*.
5. Select a channel.



The Attractions Guide is accessed through the Other Guides menu.



The Other Guides icon

OPTIONS AND PREFERENCES

USING THE PURCHASES MENU

The Purchases menu allows you to review upcoming and past DIRECTV Pay Per View purchases and edit spending limits.



The Purchases menu shows you upcoming or past DIRECTV purchases and spending limits.

The list of purchases may be longer than one screen; use the down arrow button on the remote control to see more items. The display also shows the title, channel, date, time, and cost of each program.

- Note that the past purchases list might not be updated until the end of the billing cycle and therefore may show purchases for which you have already paid.

REVIEWING AND CANCELING AN UPCOMING PURCHASE

You can review the program description, as well as cancel an upcoming purchase. Highlight an upcoming purchase from the DIRECTV Future Purchases screen and press OK. To cancel, select the program, and then press OK.

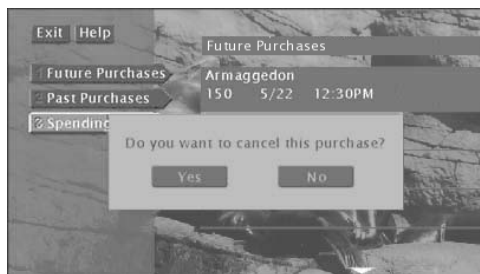

The Future Purchases screen lets you cancel an upcoming purchase.

OPTIONS AND PREFERENCES

SETTING THE TIME AND DATE

You can set the current time and day, the current date, the time zone, and whether or not you observe daylight saving time.

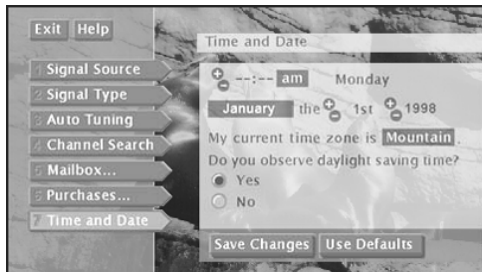

Indicate the settings for your area.

Use the arrow buttons to move around the menu screen, OK to select an item, and the digit buttons on your remote control to enter numbers. If you have already acquired a digital signal, the time was automatically set and you cannot reset it. You can, however, reset the time zone and whether you observe daylight saving time. Important: After making changes, be sure to select *Save Changes*. If you do not, your choices will be discarded.

If you select *Use Defaults*, any changes you made will be discarded and the time and date will be reset to the last saved settings.

USING THE PREFERENCES MENU

The Preferences menu allows you to change some aspects of your TV to fit your personal preference. The following sections outline what you can do in this menu.

COLOR SCHEME

You can change the color that appears in the menu and guides. To change the color, select *Preferences* from the main menu and select *Color Scheme*.



Use the up and down arrows and OK button to select the menu color scheme you prefer.

OPTIONS AND PREFERENCES

TRANSLUCENCY

You can adjust the level of translucency that the menu screens and program guides possess. Adjust the slider up for more translucency (the video behind the menu and guides will be more visible) or down for less translucency (less video will be shown behind the menu or guides).

DEFAULT GUIDE

By default, the Detail Guide appears when you press GUIDE on the remote control, no matter if you access the DIRECTV® programming guide or the TV program guide. You can change the default guide from the Detail Guide to the Grid Guide or SurfGuide (DIRECTV only).

1. Select *Preferences* from the main menu, then select *Default Guide*.
2. Use the arrows and OK to choose which guide you want to appear first when you press the GUIDE button on the remote control.

If you choose SurfGuide as the default, the Grid Guide will appear when you access the TV program guide, since the SurfGuide isn't available as a TV program guide.

SCREEN FORMAT

If you receive an image with a 4:3 aspect ratio, the image will be displayed at that ratio on your HDTV unless you specify otherwise. Note that when watching an image via the COMPONENT VIDEO INPUT jacks, you will not be able to manipulate the screen format or view the screen format in the channel banner.

The Screen Format menu allows you to adjust the image through the following options:

Normal Choose this when receiving a 4:3 image and you want the on-screen appearance of the video to be a centered picture with gray side panels (blank areas) on the right and left sides.

Full Choose this when you want the television to adjust the 4:3 image horizontally so it fills your 16:9 screen. No gray side panels will be added, and the image is vertically unaltered. This setting is especially useful for viewing 16:9 formatted DVDs.

Fill Choose this when receiving a 4:3 image and you do not want gray side panels on the right and left sides of the screen. The television will adjust the image both horizontally and vertically so it fills the height and width of your 16:9 screen with no gray side panels added. It will also maintain the correct image proportion. Use with material such as "letterboxed" laserdiscs or VCR tapes.

Also note that when in TV or DIRECTV mode, pressing the FORWARD button on the remote will toggle through screen formats.

Note that when tuned to the device connected to the component video input jacks, translucency is set to opaque and cannot be changed. Once you return to watching another device, the original setting is restored.

For more information about the three types of guides, see the section, "Using the Program Guides."

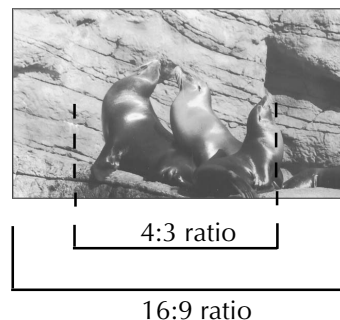

Some digital (ATSC format) stations may transmit 4:3 images in a way that will not allow expansion. You will be unable to adjust the screen format.

OPTIONS AND PREFERENCES

CAPTION DISPLAY

The Caption Display menu displays a choice list that lets you choose when closed captioning information is shown on the screen.

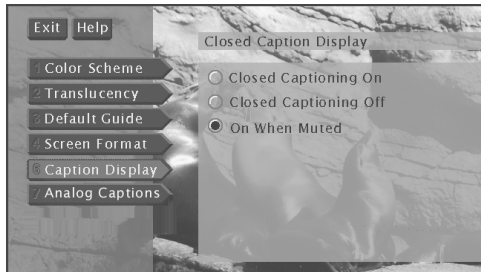

Closed Captioning On Captioning information is shown always, when available.

Closed Captioning Off No captioning information is displayed.

On When Muted Captioning information is only shown when the TV's sound is muted, when available. (To mute the sound, press the MUTE button on the remote control.)

ANALOG CAPTIONS

You can select a closed caption mode, which is the mode, or source, used for displaying captioning information for all types of channels except digital terrestrial. The content of CC and Text are different; you can select which one you want to see on the screen.

- CC displays information at any position on the screen. It overlays the text on top of the picture as it is received.
- Text displays information at one particular position (such as the bottom third) of the screen. You cannot see the picture underneath the text.

You can choose between eight closed caption modes, or sources:

- **CC1 and Text 1** are the primary caption and text services. The captioning or text is displayed in the same language as the program's dialog.
- **CC3 and Text 3** serve as the preferred data channels. The captioning or text is often a secondary language translation, simplified English, or displayed at a slower rate.
- **CC2 and CC4 and Text 2 and Text 4** are rarely available and broadcasters use them only in special conditions, such as when CC1 and CC3 are not available, or Text1 and Text3 are not available.

OPTIONS AND PREFERENCES

USING FETCH

The Fetch menu is a list of eight convenient menu items. It serves as a shortcut to access these menu items.

For instance, instead of going through four steps to access the Signal Meter (pressing MENU, selecting *Assistance*, selecting *Dish Pointing*, then selecting *Signal Meter*), you can press FETCH on the remote and select Signal Meter with only two button presses.

To view the Fetch menu, press FETCH on the remote control.



Using FETCH is a convenient way to access frequently used menu items.

GETTING ASSISTANCE

NEED HELP?

If you run across any problems or need to rely on the system to give you feedback, you should use the Assistance menu to get information. This section explains the different types of assistance your system is capable of giving you. It walks you through the Assistance menu, which is accessed by pressing MENU then selecting *Assistance*.

This section:

- tells you about the interactive setup process
- helps you get antenna and signal meter information
- explains the on-screen signal meter
- tells you how to validate a new access card
- describes how to use the system test
- explains how to acquire off-air guides
- discusses possible upgrades for your TV

Most of the screens contain information to help you decide what to do next. If you get stuck, look for the help text at the bottom of the screen. Or, select the Help button from the top of a menu to view more information about your options.

1 SETUP AND CONNECTIONS



2 USING THE REMOTE



3 BASIC TV OPERATION



4 USING THE PROGRAM GUIDES



5 ADJUSTING TV CONTROLS



6 USING THE PROFILES



7 SYSTEM OPTIONS AND PREFERENCES



8 GETTING ASSISTANCE



9 REFERENCE

GETTING ASSISTANCE

RUNNING THE INTERACTIVE SETUP

You should have completed the interactive setup the first time you plugged in your TV. However, if you need to access the interactive setup again, you can access it through the Assistance menu.

1. Press MENU on the remote control to access the main menu.
2. Select *Assistance* from the main menu.
3. Select *Interactive Setup* and follow the on-screen directions.

The steps involved in the interactive setup include:

- Setting the time and date
- Searching for channels
- Setting up speakers
- Selecting an audio processor
- Specifying your satellite dish antenna type and finding coordinates
- Viewing the signal meter and running the system test

Note that if you do not subscribe to DIRECTV® programming, you can select "Skip this step" for specifying satellite dish antenna type and running the system test.

GETTING ANTENNA INFORMATION

The Antenna Info menu helps you assess the availability of available TV channels. It is useful for checking the strength of digital channels, obtaining all channels possible, and adjusting any terrestrial TV antennas.

- Press MENU to bring up the main menu, select *Assistance*, then *Antenna Info*.

The Antenna Info screen reports the status of the signal search and lists channels that are being received or have been received from all terrestrial antennas. To switch between antennas, highlight a channel and then press ANTENNA on the remote control.

When getting antenna information, the screen lists:

- the channel number,
- the station name, if available,
- whether the channel is digital or analog,
- which antenna is receiving the signal, and
- if a digital channel, the current signal strength.

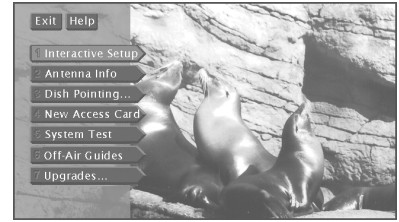

The interactive setup process allows you to complete all steps or selectively skip steps.

Note that if you highlight a channel in the Antenna Info menu, you tune to the channel and, if digital, get a real-time update of the signal strength.

GETTING ASSISTANCE

DISH POINTING

The Dish Pointing menu helps you set up your HDTV and optimize your reception of the satellite signal.

SELECTING DISH TYPE

It is important to complete each of the following steps required for your satellite dish antenna. If you do not, you will not receive proper dish pointing coordinates and will not be able to take full advantage of your system.

Specify the type of dish you are using:

1. Press MENU on the remote control to bring up the Main menu.
2. Select *Assistance*, then *Dish Pointing*.
3. Use the arrows to highlight *Select Dish*, then press OK.
4. Specify the type of dish you are using: a round satellite dish or an oval dish.

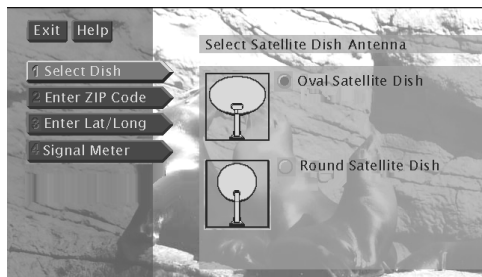

Depending on the type of dish you have, the *Select Dish* menu will prompt you for more information about your satellite dish antenna.

5. If you are using a round satellite dish, you are finished selecting your dish.
6. If you are using an oval satellite dish, specify the number of satellite locations from which your satellite dish antenna will be receiving signals. This number is equal to the number of LNBS (Low Noise Blocks) mounted on your dish. For example, if you have two LNBS, select *2 Satellite Location Dish*.

Peak Signal

The "Peak Signal" indicates the highest signal strength you have obtained, which is not necessarily the highest possible signal.

While the maximum signal strength is 100, the signal strength you achieve will probably be less. Although there is no difference in picture quality between signal strengths of 60 and 85, the higher the signal, the less likely you are to experience negative effects in degraded conditions such as rain or snow (called "rain fade").

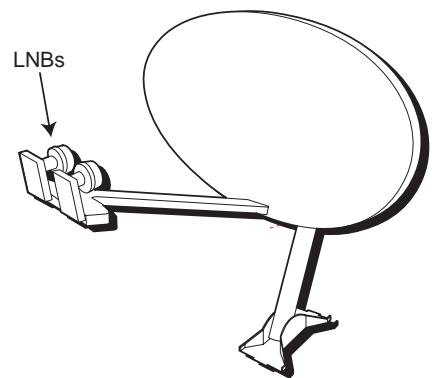

An oval satellite dish with two LNBS.

GETTING ASSISTANCE

FIND YOUR DISH POINTING COORDINATES

Use one of the available methods (ZIP Code, Latitude/Longitude) to find your dish pointing coordinates.

Follow these steps to obtain your dish pointing coordinates using the ZIP Code of the dish installation location:

1. Press MENU on the remote control to bring up the Main menu.
2. Select *Assistance*, then *Dish Pointing*.
3. Select *Enter ZIP Code*.
4. Enter the ZIP Code for the satellite dish antenna installation location.

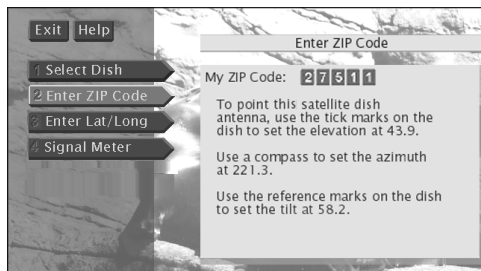

5. Record the elevation, azimuth, and tilt (oval satellite dish only) numbers below.

Elevation _____ Azimuth _____

Tilt (oval satellite dish only) _____

Azimuth is the side-to-side direction that the satellite dish antenna is pointed.

Elevation is the up/down angle that the satellite dish antenna is pointed.

Tilt is the circular rotation of the dish itself, like the motion of a steering wheel.

USING THE ON-SCREEN SIGNAL METER

Use the signal strength meter to determine whether or not you are receiving a satellite signal. You can also use it to find the strength of the satellite signal.

Follow these steps to bring up the on-screen signal meter:

1. Press MENU on the remote control to bring up the Main menu.
2. Select *Assistance*, then *Dish Pointing*.
3. Select *Signal Meter*.

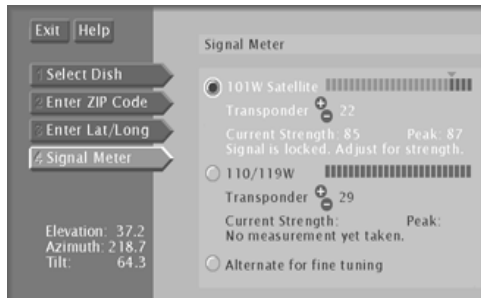

The signal meter screen you see may look somewhat different from the one pictured above.

GETTING ASSISTANCE

4. Select a satellite location (such as 101W). If the satellite dish antenna is pointed correctly, the signal meter will show you the current signal strength and you should hear a continuous tone.
5. If you are using an oval satellite dish, select the second satellite group and obtain a signal.

Once you have a signal locked for both satellite locations (this may require some tweaking), you can select *Alternate for fine tuning* to improve your reception of both signals. When this button is selected, the signal meter alternates between the two signals every four seconds. Make small adjustments to your dish's position until both signals are satisfactory.

If you are not receiving a signal and you have entered all Select Dish information correctly, please see your satellite dish antenna Installer's Guide for detailed instructions.

To change transponders, press the right arrow button on the remote, then use either the digit buttons on the remote or the on-screen + and - buttons to enter the transponder number.

YOUR NEW ACCESS CARD

Periodically, your program provider may issue you a replacement access card if you subscribe to DIRECTV® programming. The New Access Card Setup screen allows you to transfer the information from the old card onto the new one. The access card fits into the TV through the back panel.

To replace the card:

1. Select *Assistance* from the main menu.
2. Select *New Access Card*.
3. Follow the on-screen directions to validate the new card.

RUNNING THE SYSTEM TEST

The System Test display screen is accessed through the Assistance menu and allows you to initiate diagnostic procedures on the DIRECTV System, if you subscribe to DIRECTV® programming. You should use this feature to get your access card number or when your television doesn't seem to be receiving satellite signals correctly.

See the section "Setup and Connections" for details about where to insert your access card.

A message screen appears when you select *System Test* from the Assistance menu. This screen tells you whether the system passed each test. If your system fails the test, run the system test several times before concluding that there is a problem. Occasional fluctuations in the phone line or satellite signal can give temporary false readings. Note that if you do not subscribe to DIRECTV® programming or do not have your satellite dish antenna installed, the test will fail.

GETTING ASSISTANCE

OFF-AIR GUIDES

If you are certain your antenna is properly set up and receiving a strong signal, but you are receiving invalid program guide information or are having trouble tuning to a channel, you can disable your system's ability to acquire off-air TV program guides. If you subscribe to DIRECTV® programming, you will still receive DIRECTV® programming guides if you do not receive TV program guides.

To disable the TV program guide:

1. Select *Assistance* from the main menu.
2. Select *Off-Air Guides* from the Assistance menu.

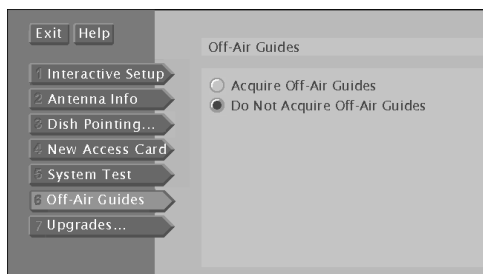

Select *Off-Air Guides* from the Assistance menu.

3. Use the arrows on the remote to highlight *Do Not Acquire Off-Air Guides* and press OK to select it. Then exit from the menu.
4. You should now rebuild the channel list by selecting *System Options* from the main menu and selecting *Channel Search*.

UPGRADES

Your HDTV is able to receive upgrades or modifications to some of its features and functions. These modifications will occur automatically, usually at times when your TV would likely be turned off. If your TV is on when an upgrade or modification is sent, you may experience a disruption in reception for a minute or two. Your reception should return to normal after the modification is complete. Please consult the Upgrades Menu to find a schedule of upgrades or modifications planned by DIRECTV. The Upgrades feature is enhanced by *RSA™ Secure.



The "RSA Secure" logo ensures that only authorized upgrades or modifications are delivered to your HDTV.

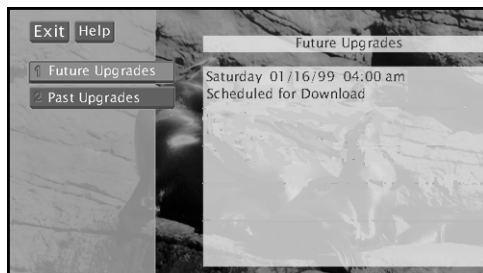

Future Upgrades lets you review upcoming upgrades. *Past Upgrades* shows you the current software version number.

*RSA™ Secure and the RSA™ Secure logo are trademarks of RSA Data Security, Inc.

REFERENCE

GETTING INFORMATION

This section contains troubleshooting information, your RCA limited warranty, and accessory ordering information.

1 SETUP AND CONNECTIONS



2 USING THE REMOTE



3 BASIC TV OPERATION



4 USING THE PROGRAM GUIDES



5 ADJUSTING TV CONTROLS



6 USING THE PROFILES



7 OPTIONS AND PREFERENCES



8 GETTING ASSISTANCE



9 REFERENCE

TROUBLESHOOTING

Can't select certain channel

- Channel may be blocked or not approved in the Profiles menu.
- If using a VCR, check to make sure the TV/VCR button on the VCR is in the correct "mode."

Noisy stereo reception

- May be a weak station. Change to mono mode instead of stereo in the Audio menu under Special Audio.

No picture, no sound but TV is on

- Maybe a vacant channel or input is tuned.
- If watching VCR (connected only through antenna input), make sure TV is tuned to channel 3 or 4 – same as CH3/4 switch on VCR. Also check to make sure the TV/VCR button on the VCR is in the correct "mode."
- Simultaneously press the POWER and CHANNEL DOWN buttons on the front panel to reset the TV.

Sound okay, picture poor

- Check antenna connections and pointing and also check for interfering sources.
- Try adjusting the picture quality, especially sharpness, to improve weak signals.
- Viewing a VCR while in AIR mode may result in poor picture performance. To exit AIR mode, select *System Options* from the main menu, then select *Signal Type* and select *Cable*.

Black box appears on the screen

- Captioning may be turned on and in text mode. Check the Caption Display in the Options menu.

Wrong picture

The TV and most VCRs let you toggle between pictures: one can be the picture from DIRECTV signal or a terrestrial antenna (or cable) and one can be from the VCR. If you don't see the picture you think you should be seeing, try using these buttons to toggle between the pictures:

- Press the TV/VCR button on the VCR remote or on the VCR's front panel.
- Press the ANTENNA button on the remote control.

Taking either of these actions lets you switch the source of the video signal from DIRECTV to the off-air antenna or cable, and vice versa.

Problems with the remote control

- Maybe something is between the remote control and the remote sensor on the front of the TV.
- Maybe the remote control is not in the correct mode. Press the DIRECTV button so the remote will be in DIRECTV mode or press the TV button so the remote will be in TV mode.
- Maybe the batteries in the remote control are weak, dead or installed incorrectly. Try replacing batteries. (Note, if you remove the batteries, you may have reprogram the remote to control other components.)
- Remove the batteries and hold the number 1 button for at least 60 seconds to drain the microprocessor inside the remote control. Release the button, replace the batteries, and (if necessary) reprogram the remote control.

REFERENCE

Blank screen

- Maybe the component (VCR, DVD, etc.) connected to the input jacks is not on.
- Try another channel, because there may just not be any programming on at that time.
- Cables in back may be disconnected.

TV will not turn on

- Check to make sure it is plugged in, and try the front panel POWER button.
- Check the wall receptacle (and extension cord, if applicable) to make sure it is "live" by plugging in something else.
- Maybe remote control is not aimed at remote sensor.
- Unplug. Wait five minutes. Plug in again.

TV turns off while playing

- Electronic protection circuit may have been activated because of a power surge. Wait 30 seconds and then turn on again. If this happens frequently, the voltage in your house may be abnormally high or low.

Problems with your system password

- If you forget your system password and subscribe to DIRECTV® programming, you should call DIRECTV to obtain a new one.

Invalid program guide information

- Make sure your antenna is properly set up and receiving a strong signal. If this still does not correct the problem, disable your system's ability to acquire off-air TV program guides by selecting *Assistance* from the main menu and then selecting *Off-Air Guides*.

CARE AND CLEANING

CAUTION: Turn OFF your TV before cleaning.

You can clean the TV as required, using a soft lint-free cloth. Be sure to occasionally dust the ventilation slots in the cabinet to help assure adequate ventilation.

The TV's screen may be cleaned with a soft, lint-free cloth as well. Take care not to scratch or mar the screen. If necessary, you may use a cloth dampened with warm water.

Never use strong cleaning agents, such as ammonia-based cleaners, or abrasive powder. These types of cleaners will damage the TV.

While cleaning do not spray liquid directly on the screen, or allow liquid to run down the screen and inside the TV. Also, avoid placing drinks, vases, or potted plants with water on top of the TV. This could increase the risk of fire or shock hazard or damage to the TV.

Caution: If fixed (non-moving) images are left on the screen for long periods, they may be permanently imprinted on the screen. Such images include network logos, phone numbers, and video games. This damage is not covered by your warranty. Extended viewing of channels displaying these images should be avoided.

RCA HIGH DEFINITION TELEVISION (HDTV) LIMITED WARRANTY

What your warranty covers:

- Any defect in materials or workmanship.

For how long after your purchase:

- One year for labor charges.
- One year for parts.
- Two years for the picture tube.

The warranty period for rental units begins with the first rental or 45 days from date of shipment to the rental firm, whichever comes first.

What we will do:

- Pay any Authorized RCA Digital Television Service Center the labor charges to repair your HDTV.
- Pay any Authorized RCA Digital Television Service Center for the new or, at our option, refurbished replacement parts and picture tube required to repair your HDTV.

How you get service:

- Call 1-877-RCA-HDTV and have your unit's date of purchase and model number ready.
- A representative will troubleshoot your problem over the phone.
- If the representative determines that you should receive service they will provide you with name(s) of the closest RCA Digital Television Authorized Service Center(s).
- Contact the Service Center and arrange for home service.
- Show the Authorized Service Center Representative your sales receipt or other evidence of purchase date or first rental.

What your warranty does not cover:

- Customer instruction. (Your Owner's Manual clearly describes how to install, adjust, and operate your HDTV. Any additional information should be obtained from your dealer.)
- Installation and related adjustments.
- Signal reception problems not caused by your HDTV.
- Damage from misuse or neglect.
- Batteries.
- Images burned onto the screen.
- Units purchased, serviced, or operated outside the continental U.S.A. and Alaska.
- For units intended for use in Alaska, this warranty does not cover installation or the dish antenna. If only covers the HDTV.
- An HDTV that has been modified or incorporated into other products or used for institutional or other commercial purposes.
- Acts of God, such as but not limited to lightning damage.

Product Registration:

- Please complete and mail the Product Registration card packed with your HDTV. It will make it easier to contact you should it ever be necessary. The return of the card is not required for warranty coverage.

How state law relates to this warranty:

- This warranty gives you specific legal rights, and you also may have other rights that vary from state to state.

If you purchased your HDTV outside the United States:

This warranty does not apply. Contact your dealer for warranty information.

Service calls that do not involve defective materials or workmanship are not covered by this warranty. Costs of such service calls are the sole responsibility of the purchaser.

FCC REGISTRATION INFORMATION

Your HDTV is registered with the Federal Communications Commission and is in compliance with parts 15B and 68, FCC Rules and Regulations.

1. Notification to the Local Telephone Company.

On the back of this equipment is a label indicating among other information, the FCC Registration number and Ringer Equivalence Number (REN) for the equipment. You must, upon request, provide this information to your telephone company.

The REN is useful to determine the number of devices you may connect to your telephone line and still have all these devices ring when your telephone number is called. In most (but not all) areas, the sum of the RENs of all devices connected to one line should not exceed 5. To be certain of the number of devices you may connect to your line as determined by the REN, you should contact your local telephone company.

Note: This equipment may not be used on coin service provided by the telephone company. Party lines are subject to state tariffs, and therefore you may not be able to use your own telephone equipment if you are on a party line. Check with your local telephone company. Notice must be given to the telephone company upon permanent disconnection of your equipment from your line.

2. Rights of the Telephone Company.

Should your equipment cause trouble on your line which may harm the telephone network, the telephone company shall, where practicable, notify you that temporary discontinuance of service may be required. Where prior notice is not practicable and the circumstances warrant such action, the telephone company may temporarily discontinue service immediately. In case of such temporary discontinuance, the telephone company must: (1) promptly notify you of such temporary discontinuance (2) afford you the opportunity to correct the situation and (3) inform you of your right to bring a complaint to the Commission pursuant to procedures set forth in Subpart E of Part 68, FCC Rules and Regulations.

The telephone company may make changes in its communications facilities, equipment, operations of procedures where such action is required in the operation of its business and not inconsistent with FCC Rules and Regulations. If these changes are expected to affect the use or performance of your telephone equipment, the telephone company must give you adequate notice, in writing, to allow you to maintain uninterrupted service.

ACCESSORY INFORMATION

The following accessories are available from most dealers and electronics supply stores in case you want to position your components farther apart or need additional cables.



Standard Audio/Video cable with RCA-type phono plugs. VH83

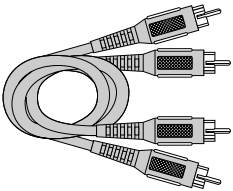

Monaural VCR Dubbing Audio/Video Cable is a double cable that lets you connect the video and audio jacks of two VHS VCRs to duplicate tapes. It can also be used to connect a VCR to your TV. The cable is color-coded and shielded. It has RCA-type phono plugs on each end. Gold-Tipped cable, VH83 (6-ft)

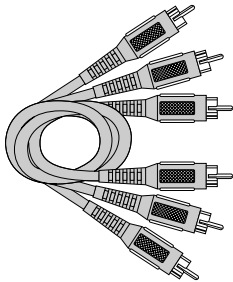

Stereo VCR Dubbing Audio/Video Cable is a triple cable that lets you connect the VIDEO and AUDIO jacks of stereo components. Gold-Tipped cable, VH84 (6-ft)

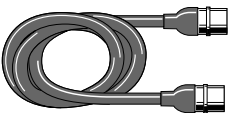

Push-on Cable* attaches to the round antenna connectors (called 75-ohm F-type) on the back of your VCR or TV. The ends push on for a quick connection. VH89 (6-ft)

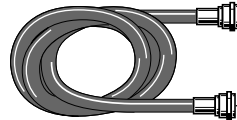

Screw-on Cable* attaches to the round antenna connectors (called 75-ohm F-type) on the back of your VCR or TV. The ends screw onto the connectors for a secure connection. VH82 (6-ft), VH81 (3-ft)

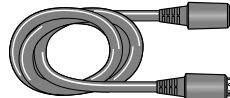

S-Video Cable has multi-pin connectors on each end for connecting S-Video components to your TV. VH976 (6-ft), VH913 (12-ft)

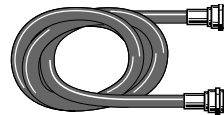

RG-6 Coaxial Burial Cable with weatherproof "F" connectors. D905

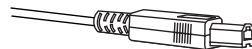

Optical/SPDIF cables help you connect to a component with an Optical Audio In jack, such as a Dolby Digital decoder or receiver. DV3 (3-ft), DV6 (6-ft)

REFERENCE

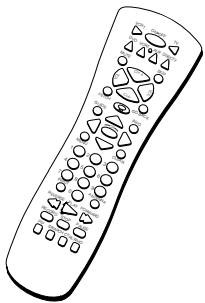

CRK76TCL3

Remote Control This is the remote control that came packed with your TV. Replacements or spares can be ordered as needed.

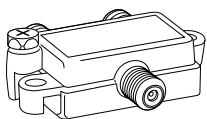

2-way Splitter (VH47)
4-way Splitter (VH49)

2-way Signal Splitter, 4-way Signal Splitter* helps you connect to other components.



ANT200

Amplified VHF/UHF/FM Antenna allows you to easily switch from the antenna signal to cable or satellite easily without disconnecting antenna.

* This accessory is intended for use with an off-air or cable TV signal distribution and is not suitable for distribution of the satellite signal originating from your satellite dish antenna.

Accessory Order Form

Description	Part No.	Price	Qty	Total
Screw-on antenna cable* (3-ft)	VH81	\$3.99		
Screw-on antenna cable* (6-ft)	VH82	\$3.95		
Push-on antenna cable* (6-ft)	VH89	\$5.95		
Weatherproof "F" Connector (2)	D905	\$5.95		
Monoaural VCR Dubbing Cable (6-ft)	VH83	\$5.95		
Stereo VCR Dubbing Cable (6-ft)	VH84	\$9.95		
S-Video Cable (6-ft)	VH976	\$7.95		
S-Video Cable (12-ft)	VH913	\$14.95		
2-way Signal Splitter*	VH47	\$3.95		
4-way Signal Splitter*	VH49	\$6.95		
Amplified Antenna	ANT200	\$49.95		
Antenna Mixer	193984	\$11.15		
Remote Control (CRK76TCL3)	244876	\$32.00		
Optical/SPDIF Cable (3-ft)	DV3	\$15.95		
Optical/SPDIF Cable (6-ft)	DV6	\$19.95		
Audio•Video Adapter	228449	\$4.45		
Diplexer	D920	\$19.95		

Total Merchandise	\$
Sales Tax	\$
We are required by law to collect the appropriate sales tax for each individual state, country, and locality to which the merchandise is being sent.	
Shipping and Handling*	\$ 5.00
Total Amount Enclosed	\$
Use VISA, MasterCard, or Discover Card preferably.	
Money order or check must be in U.S. currency only.	
No COD or CASH.	



Detach Here

Prices are subject to change without notice.

All accessories are subject to availability.

Where applicable, we will ship a superseding model.

Please complete other side also

REFERENCE

Charge your order on your VISA,
MasterCard, or Discover Card by
filling in below

USE YOUR CREDIT CARD

IMPORTANT: Copy complete account number
from your VISA card



My card expires:

IMPORTANT: Copy complete account number
from your MasterCard



Copy Number
above your
name on
MasterCard

My card
expires:

IMPORTANT: Copy complete account number
from your Discover Card



My card expires:

AUTHORIZED SIGNATURE
(Credit card order will not be processed without signature)

Print or type your name and
address clearly.



A complete and correct
order will save you days
of waiting.

Name: _____
Street: _____
_____ Apt: _____
City: _____
State: _____ Zip: _____
Daytime Phone Number: _____

Please make sure that both sides of this form
have been filled out completely.

- Allow 4 weeks for delivery.
- All accessories are subject to availability.
- Prices are subject to change.

Placing an Order

To place your order by phone, have your Visa, MasterCard
or Discover Card ready and call the toll-free number listed
below.

Use this number only to place an order for accessory items
listed on this order form.

1-800-338-0376

To place your order by mail, detach and mail the completed
order form with credit card information, money order or
check in US currency (made payable to Thomson Consumer
Electronics, Inc.) to the following address:

**Video Accessories
PO Box 8419
Ronks, PA 17573**

(This page intentionally left blank)

(This page intentionally left blank)

REFERENCE

INDEX

- A**
 - A-Z icon 34, 40
 - Access card 10, 79
 - Number 16
 - Accessories 86
 - Age-based ratings 54
 - Blocking 56
 - Viewing 56
 - AIR mode 12, 64
 - All icon 39
 - AlphaSort icon 34
 - Amplifier
 - Connecting 15
 - Analog captions 73
 - Analog terrestrial 26
 - Anatomy of the TV program guide 33
 - Antenna
 - A 64, 65
 - ANTENNA IN jacks 10
 - B 64, 65
 - Button on the remote 19
 - Information 76
 - Receiving signals 76
 - AphaSort 40
 - Arrows on remote 19
 - Assistance menu 75
 - Attractions guide 69
 - Audio
 - AUDIO jacks 9
 - Audio/Video jacks, cable 7
 - Processor 46
 - Quality controls 46
 - Audio language icon 25
 - Auto
 - Converge 45
 - Tuning 65
 - AUX button 18
 - Available channels 66
 - Azimuth 78
- B**
 - Back of the TV 10
 - Batteries 16, 82
 - Binocular icon 25
 - Black level 44
- Blocking
 - Age-based ratings 56
 - Content themes 57
- Bright lighting 45
- Buy programs 68
- C**
 - Cables 10
 - Jacks 7
 - Canceling purchases 70
 - Caption
 - Display 73
 - Care and cleaning 83
 - Changing
 - Channels 26, 27
 - From the TV guide to the DIRECTV guide 32
 - Channel
 - Banner
 - Icons 24
 - Control button on the remote 19
 - Groups 37
 - Lists 37
 - Delete channels 51
 - Retrieving channel number 76
 - Search 66
 - Up and down 8, 18
 - CLEAR button 19
 - Closed captioning 73, 82
 - Codes
 - remote 22
 - Color 44
 - Scheme 71
 - Warmth 44
 - Colors
 - Of icons 62
 - Connections
 - To the back panel 6
 - Content themes 54
 - Viewing 57
 - Contrast 44
 - Convergence 45
- D**
 - Date and time 71
 - Default guide 36, 72
 - Detail guide 36
 - DIGITAL AUDIO OUT jack 10, 47
 - Digital terrestrial 26
 - DIRECTV
 - Button 16, 18, 82
 - Channel list 50
 - Rating limit 52
 - Setup 50
 - Spending limit 51
 - Dish Pointing 77
 - coordinates 78
 - Dish type 77
 - Dolby
 - Digital 47
 - Receiver 7
 - DVD button 18
- E**
 - Editing
 - Channels 50
 - Profiles 50
 - Elevation 78
 - Exit icon 42
 - Exiting
 - Program guides 37
- F**
 - FCC information 85
 - Fetch
 - Button 18
 - Using 74
 - Fill screen format 72
 - Fine tuning the dish 79
 - Fixed
 - Images 83
 - Variable out jack 11
 - Fixed Output 15
 - FORWARD
 - Button on the remote 19
 - Front
 - And rear speaker jacks 11
 - Input jacks 8
 - Of the TV 8
 - Panel 8
 - Speaker INT./ EXT. switch 11
 - Front inputs 9
 - Full screen format 72

REFERENCE

G

Getting around in the guides 35

GO BACK

Button on the remote 19

GO BACK button 19

Grid guide 36

Guide

Button on the remote

19, 33, 34, 36

Data 36, 37

H

Headphone jack 9

Help 42

I

Icons 25, 34, 40, 62

Lock, Unlock 62

INFO

Button on front panel 8

Button on the remote 19, 35

INPUT

1 jacks 11

2 jacks 11

3 jacks 11

Button on the remote 19

Interactive setup 16, 76

J

Jacks 10

And cables 7

L

Latitude and longitude 78

LED button on the remote 18

Listing all DIRECTV programs 39

LNB (Low Noise Block) 77

Lock icon 62

Locking

The system 25, 58, 62

M

Mail icon 66

Mailbox

Checking your mail 66

Deleting mail 66

Icon 25

Main menu 42

Maximum signal strength 77

MENU button 8, 19

Menus

Icons 62

Profiles 50

Modes 8

Of operation 26

SAT and TV 26

Mono sound 46

Movie

Icon in the program guide 39

Ratings 58

Blocking 58

Viewing 59

Themes icon 39

Mute 18, 46

N

Naming profiles 50

New access card 79

Noise filter 45

Normal lighting 45

Normal screen format 72

Not rated

Movies 59

Programs 54

Number buttons on the remote 35

O

Off-Air Guides 79

OK button 19

ON•OFF button 18

Optical

Jacks and cables 7

Output menu 47

Other guides

Attractions guide 69

Icon 36

Overheated components 6

P

Password

System 61

User 61

Pay Per View program 52

PCM

Decoder 47

Personal picture preset 45

Phone

Jack 7, 10

Line 7

PHONES jack 9

Picture 44

Controls 44

Presets 45

Quality 44, 77

Settings 44

Picture tilt 45

PIP (Picture in Picture)

Button 19

Buttons 28

Problems 29

Positioning cables 6

POWER button 8

Preferences menu 71

Profiles

Choosing 60

Locking

Unlocking 61

Menu 50

Unlocking 60

Program guides

Anatomy 34

Default guide 72

Detail guide 36, 72

DIRECTV 32

Down arrow 42

Exiting 37

Grid guide 36, 72

Help 42

Scrolling 35

SurfGuide 36, 37, 72

Tuning to a program 35

TV 32

Programming the remote to control components 20

Purchases

Cancelling 70

Menu 70

Pay Per View programs 67

Previewing 67

Reviewing 70

Q

Quality controls 44

REFERENCE

R

- Rain fade 77
- Rating limit 52
- Ratio (16:9 and 4:3) 72
- RCA-type cables 7
- Remote control 82
 - Buttons 18
 - codes 22
 - Programming 20
- Reset picture controls 45
- Reviewing purchases 70
- RF jacks
 - Cables 7

S

- S-VIDEO jack 7
- Satellite 26
 - In jack 10
- Satellite dish type 77
- Scout 25
 - Icon 40
- Screen format 72
- Scrolling 35
- Search for channels 66
- Second Audio Program (SAP) 47
- Set
 - Movie ratings 58
 - Rating limit 52
 - Time and date 71
- Sharpness 44
- Signal
 - Meter
 - Peak Signal 77
 - Source
 - Changing 64
 - Strength
 - Of a digital signal 76
 - Type
 - Changing 64
- Signal meter 78
- SKIP button 18

- Soft lighting 45
- Sorting
 - The DIRECTV guide
 - By movies 39
 - By sports 39
 - By title 34
 - By topics 38
 - Using movies icon 39
 - Using sports icon 39
 - Using topics icon 38
- Sorting by
 - Scout button 40
- Sound
 - Logic 47
- Speaker
 - Connecting 14
 - Setup 14
- Speakers 47
- Spending limit 51
- Sports
 - Icon 39
 - Themes icon 39
- SRS Stereo 47
- Station name
 - Retrieving 76
- Stereo sound 46
- Subchannel number 33
- SurfGuide 36, 37
- SWAP
 - Button on the remote 19
- System
 - Lock 58, 62
 - Password 62
 - Test 79
 - Unlock 62

T

- Telephone jack and cord 7
- Terrestrial antennas 76
- Text
 - Closed caption 73
- Tilt 78
- Time and date 71
- Tint 44
- Tone controls 46
- Translucency 72
- Troubleshooting 82

- Tuning to a program 35
- TV
 - And DIRECTV button on remote 8
 - Button 18
 - Mode 27
 - Rating limit 54

U

- Unlocking
 - Profiles 60
 - The system 25, 62
- Unrated
 - Movies 59
 - Programs and shows 54
 - Shows 59
- Upgrades 80

V

- V-Chip
 - Age-based ratings 54
 - Content themes 54
- Variable Output 15
- VCR
 - VCR1 button 18
 - VCR2 button 18
- Video
 - Configuration 44
 - Games 10
 - Jack 9
- Viewing
 - Age-based ratings 56
 - Content themes 57
- Volume
 - Button 8, 18

W

- Weak reception 82
- WHO button on the remote 19, 60

Z

- ZIP code 78

(This page intentionally left blank)

Please do not send any products to the Indianapolis address listed in this manual or on the carton. This will only add delays in service for your product.

Thomson multimedia Inc.

10330 North Meridian Street
Indianapolis, IN 46290

©2001 Thomson multimedia Inc.

Trademark(s)® Registered

Marca(s) Registrada(s)

DIRECTV is a trademark of DIRECTV, Inc., a unit of Hughes Electronics Corp., and is used with permission. DIRECTV® programming is sold separately and independently of DIRECTV System hardware. A valid programming subscription is required to operate DIRECTV System hardware. Please contact DIRECTV directly at 1-800-DIRECTV to order programming.

Printed in USA

TOCOM 1550852A

Free Manuals Download Website

<http://myh66.com>

<http://usermanuals.us>

<http://www.somanuals.com>

<http://www.4manuals.cc>

<http://www.manual-lib.com>

<http://www.404manual.com>

<http://www.luxmanual.com>

<http://aubethermostatmanual.com>

Golf course search by state

<http://golfingnear.com>

Email search by domain

<http://emailbydomain.com>

Auto manuals search

<http://auto.somanuals.com>

TV manuals search

<http://tv.somanuals.com>