

# user's guide





**RCA** | LCD FLAT PANEL HDTV

For use with models: L42FHD2X48/L46FHD2X48  
/L52FHD2X48

## contents

connections	7
remote	20
features	28
menus	34
FAQs	41
warranty	47

# Important Information

	<b>CAUTION</b> RISK OF ELECTRIC SHOCK. DO NOT OPEN			This symbol indicates that this product incorporates double insulation between hazardous main voltage and user accessible parts. When servicing, use only identical replacement parts.
<p>Caution: To reduce the risk of electric shock, do not remove cover (or back). No user serviceable parts inside. Refer servicing to qualified service personnel.</p>				
	This symbol indicates "dangerous voltage" inside the product that presents a risk of electric shock or personal injury.		This symbol indicates important instructions accompanying the product.	

**WARNING**  
To reduce the risk of fire or electric shock, do not expose this product to rain or moisture. This product should not be exposed to dripping or splashing. No objects filled with liquids, such as vases, should be placed on the component.

**WARNING**  
The TV is unstable if it is not properly attached to the base or mounted to the wall. Please follow the base or wall mounting instructions provided in the User's Guide to ensure your safety.



This symbol indicates that this product contains mercury. Special disposal of this product for environmental reasons may be required under the laws applicable to your jurisdiction. For disposal or recycling information, please contact your local authorities or the Electronic Industries Alliance: [www.eiae.org](http://www.eiae.org).

Refer to the identification/rating label located on the back panel of your product for its proper operating voltage. FCC regulations state that changes or modifications to this unit not expressly approved by the party responsible for compliance could void the user's authority to operate the equipment.

Cable TV Installer: This reminder is provided to call your attention to Article 820-40 of the National Electrical Code (Section 54 of the Canadian Electrical Code, Part 1) which provides guidelines for proper grounding and, in particular, specifies that the cable ground should be connected to the grounding system of the building as close to the point of cable entry as practical.

Important: This television is a table model and is designed to sit on a firm, flat surface. Don't place the TV on soft carpeting or a similar surface, as the ventilation slots on the bottom of the unit may be blocked, resulting in reduced lifetime from overheating. To assure adequate ventilation for this product, maintain a spacing of 4 inches from the top and sides of the TV receiver and 2 inches from the rear of the TV receiver and other surfaces.

Also, make sure the surface or stand is of adequate size and strength to prevent the TV from being accidentally tipped over, pushed off, or pulled off. This could cause personal injury and/or damage to the TV. Refer to the Important Safety Instructions on the next page.

The power button (followed by the power symbol) on this TV and your remote control puts the TV into a very low-power standby mode but will not completely shut the power off. In order to shut the power off, you will need to disconnect the power cord from your outlet. Therefore, you should make sure the TV is installed in a way that allows you to disconnect the power cord when desired.

## Product Registration

Please fill out the product registration card (packed separately) and return it immediately. For US customers: Your RCA Consumer Electronics product may also be registered at [www.rca.com/television](http://www.rca.com/television). Registering this product allows us to contact you if needed.

## Product Information

Keep your sales receipt to obtain warranty parts and service and for proof of purchase. Attach it here and record the serial and model numbers in case you need them. These numbers are located on the product.

Model No. \_\_\_\_\_ Serial No. \_\_\_\_\_ Purchase Date \_\_\_\_\_  
Dealer/Address/Phone \_\_\_\_\_

# Important Safety Instructions

1. Read and follow all instructions.
2. Do not block any ventilation openings. Install in accordance with the manufacturer's instructions.
3. Do not install near any heat sources such as radiators, heat registers, stoves, or other apparatus (including amplifiers) that produce heat.
4. Do not negate the safety purpose of the polarized or grounding-type plug. A polarized plug has two blades with one wider than the other. A grounding type plug has two blades and a third grounding prong. The wide blade or the third prong is provided for your safety. If the provided plug does not fit your outlet, consult an electrician for replacement of the obsolete outlet.
5. Protect the power cord from being walked on or pinched particularly at plugs, receptacles, and the point where it exits from the component.
6. Do not use this component near water.
7. Only use the attachments/accessories specified by the manufacturer.
8. Clean only with dry cloth.
9. Use only with the cart, stand, tripod, bracket, or table specified by the manufacturer, or sold with the component. When the TV is placed on a cart, use caution when moving the cart to avoid injury from tip-over.
10. Unplug this component during lightning storms or when unused for long periods of time.
11. Refer all servicing to qualified service personnel. Service is required when the component is damaged in any way, such as power supply cord or plug damage, liquid spilled on or objects falling onto the component, rain or moisture exposure, abnormal operation, or if the component has been dropped.
12. If an outside antenna or cable system is connected to the product, be sure the antenna or cable system is grounded so as to provide some protection against voltage surges and built-up static charges. Section 810 of the National Electrical Code, ANSI/NFPA No. 70-1984 (Section 54 of Canadian Electrical Code, Part 1) provides information with respect to proper grounding of the mast and supporting structure, grounding of the lead-in wire to an antenna-discharge unit, size of grounding conductors, location of antenna-discharge unit, connection to grounding electrodes, and requirements for the grounding electrode. See following example:

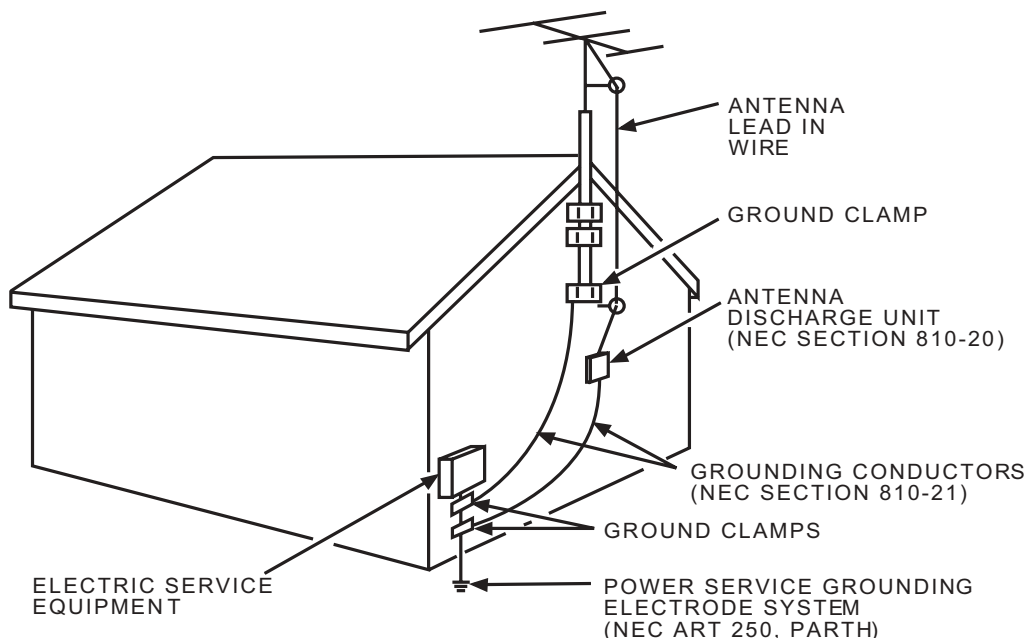

# Table of Contents

Important Safety Instructions .....	i
Chapter 1   Connections & Setup	
<b>Before Initial Setup .....</b>	<b>7</b>
Protect Against Power Surges .....	7
Safety Information .....	7
Avoid Audio Interference .....	7
Avoid Direct Light .....	7
Check Supplied Parts .....	7
<b>Removing the Table Stand .....</b>	<b>8</b>
<b>Mounting Your TV to the Wall .....</b>	<b>8</b>
<b>Obtain the Signal .....</b>	<b>9</b>
What You Need .....	9
What you Need to Know .....	9
<b>Choose Your Connections .....</b>	<b>10</b>
Connecting a Component with Composite Video (Good) .....	11
Connecting a Component with Component Video (Better) .....	11
Connecting a Component with HDMI (Best) .....	12
Connecting a PC Component .....	13
Viewing the Picture from the Connected Component .....	14
Viewing a PC .....	14
<b>Plug in the TV .....</b>	<b>15</b>
<b>Put Batteries in the Remote .....</b>	<b>15</b>
<b>Turn on the TV .....</b>	<b>15</b>
<b>Using the Remote Control to Complete Initial Setup .....</b>	<b>15</b>
<b>Complete the Initial Setup .....</b>	<b>16</b>
Set the Menu Language .....	16
Set the TV Location Mode .....	16
Complete Channel Setup .....	16
<b>What To Expect .....</b>	<b>17</b>
Watching TV-Analog Channels .....	17
Watching TV-Digital Channels .....	17
Changing Channels .....	17

<b>Explanation of Jacks (in alphabetical order)</b> .....	<b>18</b>
<b>Buttons and Other Jacks on Your TV</b> .....	<b>19</b>
Side Input Jacks .....	19
Side Panel Buttons .....	19

## Chapter 2 | Using the Remote Control

<b>Remote Control Buttons</b> .....	<b>20</b>
TV Functions .....	20
INPUT Button .....	21
<b>Programming the Remote to Operate Other Components</b> .....	<b>21</b>
<b>Determine If You Need to Program Remote</b> .....	<b>21</b>
<b>Programming the Remote</b> .....	<b>22</b>
<b>Using Direct Entry</b> .....	<b>22</b>
<b>Using a Manual Code Search</b> .....	<b>22</b>
<b>Using Automatic Code Search</b> .....	<b>22</b>
<b>Using the Remote</b> .....	<b>23</b>
<b>Modes of Operation</b> .....	<b>23</b>
<b>Manual Reset</b> .....	<b>23</b>
<b>Remote Code List</b> .....	<b>24</b>

## Chapter 3 | Using TV Features

<b>Channel Banner</b> .....	<b>28</b>
<b>Autotuning</b> .....	<b>28</b>
<b>Parental Controls and V-Chip</b> .....	<b>29</b>
V-Chip - US and Canada .....	29
Lock Parental Controls .....	30
Unlock Parental Controls .....	30
V-Chip Rating Screen .....	30
US V-Chip TV Ratings .....	30
Blocking Specific Content Themes .....	31
US V-Chip Movie Rating Limit .....	31
Blocking Canada V-Chip Ratings .....	32
Block Channel .....	32
Block Buttons .....	32
Blocking Unrated/Exempt Programs .....	32
Future Rating Region .....	32
<b>Additional Features</b> .....	<b>33</b>
Fetch Feature .....	33
Screen Formats .....	33

## Chapter 4 | Using the TV Menu

<b>Using the Menu System</b> .....	<b>34</b>
<b>Sound Menu</b> .....	<b>34</b>
<b>Picture Menu</b> .....	<b>35</b>
<b>Channel List Menu</b> .....	<b>37</b>
<b>Setup Menu</b> .....	<b>37</b>
<b>Parental Control Menu</b> .....	<b>39</b>
<b>Time Menu</b> .....	<b>39</b>
<b>USB Menu</b> .....	<b>40</b>
<b>USB Connection</b> .....	<b>40</b>

## Chapter 5 | Other Information

<b>Frequently Asked Questions (FAQs)</b> .....	<b>41</b>
<b>Troubleshooting</b> .....	<b>42</b>
<b>V-Chip Rating Explanations</b> .....	<b>45</b>
US V-Chip Rating System .....	45
Canadian English V-Chip Rating System .....	45
Canadian French V-Chip Rating System .....	46
<b>Limited Warranty</b> .....	<b>47</b>
<b>Care and Cleaning</b> .....	<b>51</b>

# 1 Connections and Setup

## Before Initial Setup

### Protect Against Power Surges

- Connect all components before you plug any power cords into the wall outlet or power strip. NEVER plug your TV into an outlet that is controlled by a wall switch.
- Turn off the TV before you connect or disconnect any cables.
- Make sure all antennas and cables are properly grounded. Refer to the Important Safety Instructions.

### Safety Information

- Protect components from overheating.
- Don't block ventilation holes on any of the components. Arrange the components so that air can circulate freely.
- Don't stack components.
- If you place the component in a stand, make sure you allow adequate ventilation.
- If you connect an audio receiver or amplifier, place it on the top shelf so the heated air from it won't harm other components.

### Avoid Audio Interference

- Position cables properly; insert each cable firmly into the designated jack.
- If you place components above the TV, route all cables down one side of the back of the TV instead of straight down the middle.
- If your antenna uses 300-ohm twin lead cables, do not coil the cables.
- Keep twin lead cables away from audio/video cables.

### Avoid Direct Light

Don't place the TV where sunlight or room lighting is directed toward the screen. Use soft or indirect lighting.

### Check Supplied Parts

Check that the following parts were packed with your product.

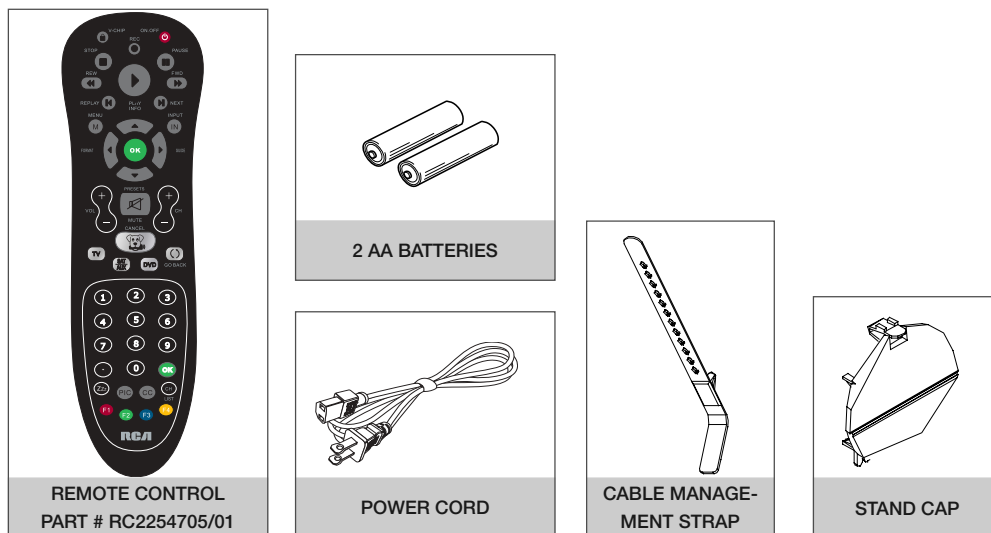

#### Replacing your remote

If you need to replace your remote, call 1-800-338-0376. A shipping and handling fee, and the appropriate sales tax, will be charged upon ordering. Have your Visa, MasterCard, or Discover Card ready.

## Removing Table Stand

Your TV comes with the table stand attached. If you want to mount your TV to the wall, remove the table stand by following the instructions below:

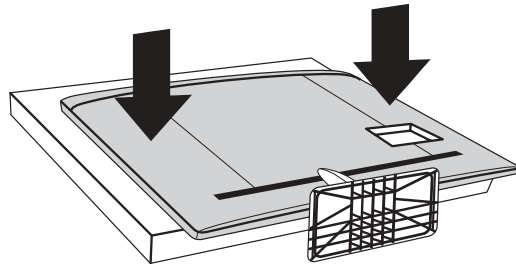

### Step 1

1. Take the TV bag and place it on a flat table.
2. Take the TV set and place it face down on the TV bag.

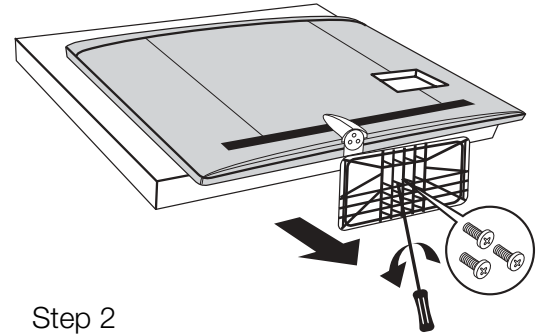

### Step 2

Remove the Table Stand from the TV cabinet by taking off the three size M6 St-screws with a screwdriver. (Note: there are four M5 St-screws for models L46FHD2X48 & L52FHD2X48)

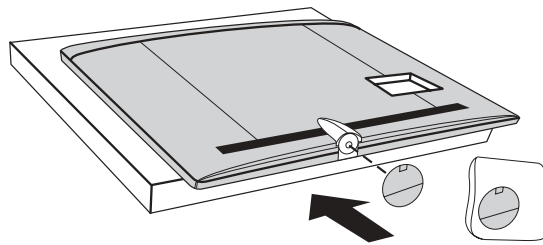

### Step 3

Attach the Stand Cap to the TV cabinet .

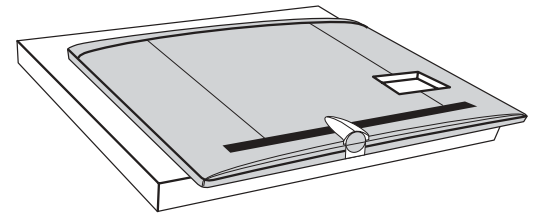

TV cabinet with Stand Cap attached.

## Mounting Your TV to the Wall

**Caution:** Your wall mount must be able to bear a minimum of five times the TV's net weight to avoid causing damage.

*To mount your TV to the wall, purchase a VESA wall mount*

Models L42FHD2X48  
/L46FHD2X48/L52FHD2X48

Purchase a VESA 600 x400, M6 screw

The VESA number is the horizontal and vertical measurement of the mounting holes. For example, 600x400 refers to fact that the mounting measurements are 600mm horizontally and 400mm vertically. Follow the directions included with the wall mount to mount the TV to the wall.



# Obtain the Signal

The first step in connecting your TV is obtaining the signal. The back panel of your TV allows you to receive analog and/or digital channels by using the ANTENNA/CABLE INPUT.

Before you connect your TV, you have to determine whether you will be using an antenna or a cable service to obtain the signal.

## What You Need

### Antenna (Rabbit Ears) or Outdoor Antenna with Coaxial Cable

Plug the antenna or coaxial cable from the wall outlet into the ANTENNA/CABLE INPUT on the back of the TV. You are ready to receive off-air local digital and analog channels.

### Cable Service

Plug the coaxial cable from the wall outlet into the ANTENNA/CABLE INPUT on the back of the TV. You are ready to receive your cable channels.

### Set-Top Box

If you have a set-top box, you may need to call your cable company or satellite service provider. They may recommend special cables to allow you to view digital channels.

## What You Need to Know

- Visit [www.antennaweb.org](http://www.antennaweb.org) for help in deciding what type of antenna to use in order to receive the local digital channels available to you. Enter your location, and the program will list local analog and digital stations available using your antenna.
- When you watch TV, the Channel Banner displays the type of channel currently viewed. A “D” at the bottom of the screen denotes digital channels and an “A” denotes analog channels. For more information on Channel Banners, see page 28.

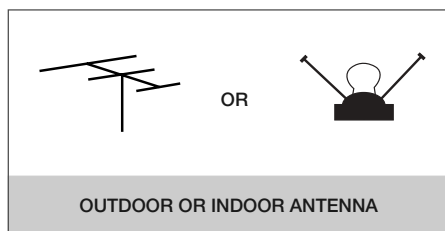
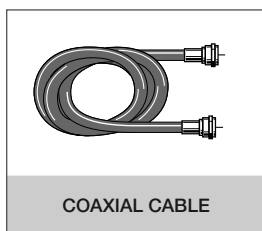

# Choose Your Connections

**Note for US Customers:** If you prefer, we can provide you with the name of an Authorized Service Representative who will, for a fee, install your electronic entertainment system and instruct you in its operation. For details about this service, call 1-888-206-3359.

There are several ways to connect components, such as DVD players and setup boxes, to your TV. Please use the following chart to determine which connections are best for you. Proceed to the appropriate pages to connect your components.

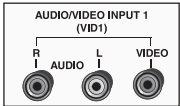
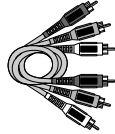
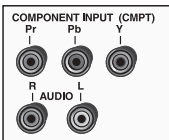
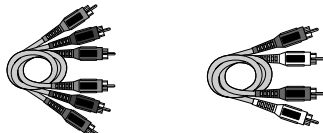
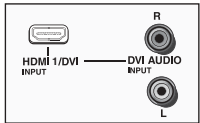
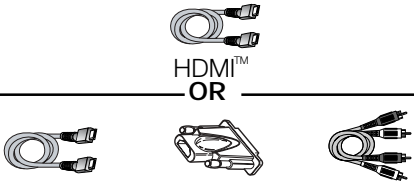
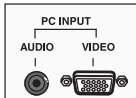
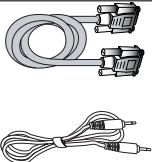
Jacks Used	Cable Needed	Go to...
 <p>Audio R and L    Video</p>	 <p>Audio/Video</p>	page 11
 <p>Y Pb Pr Audio R and L</p>	 <p>Component Video    Audio</p>	pages 11-12
 <p>HDMI/DVI    Audio R and L</p>	<p>HDMI™ OR</p>  <p>HDMI™ + HDMI/DVI Adapter + Audio</p>	pages 12-13
 <p>Audio VGA</p>	 <p>VGA Audio</p>	pages 13-14

HDMI, the HDMI logo, and High-Definition Multimedia Interface are trademarks or registered trademarks of HDMI Licensing LLC.

Input	Signal Compatibility
Ant/Cable	480i, 480p, 720p, 1080i (NTSC, ATSC, and QAM formats)
Composite Video	480i
S-Video	480i
Component Video	480i, 480p, 720p/60Hz, 1080i/60Hz
PC	VGA, SVGA, XGA
HDMI	480i, 480p, 720p/60Hz, 1080i/60Hz, 1080p

## Customer Support

For additional assistance in using your RCA product, please visit [www.rca.com/customersupport](http://www.rca.com/customersupport).

## Connecting a Component with Composite Video (Good)

To connect a component with a video output jack, such as a DVD player, follow these steps:

Example: DVD Player

1. Connect your cable and/or off-air antenna as described on page 9.
2. Connect the video cable to the (VID 2) VIDEO jack on the side of the TV and to the video output jack on the DVD player.
3. Connect the red and white audio cables to the (VID 2) right and left audio jacks on the side of the TV and to the audio output jacks on the DVD player.

## Composite Video Connection

This is an example of a connection using the composite video jack.

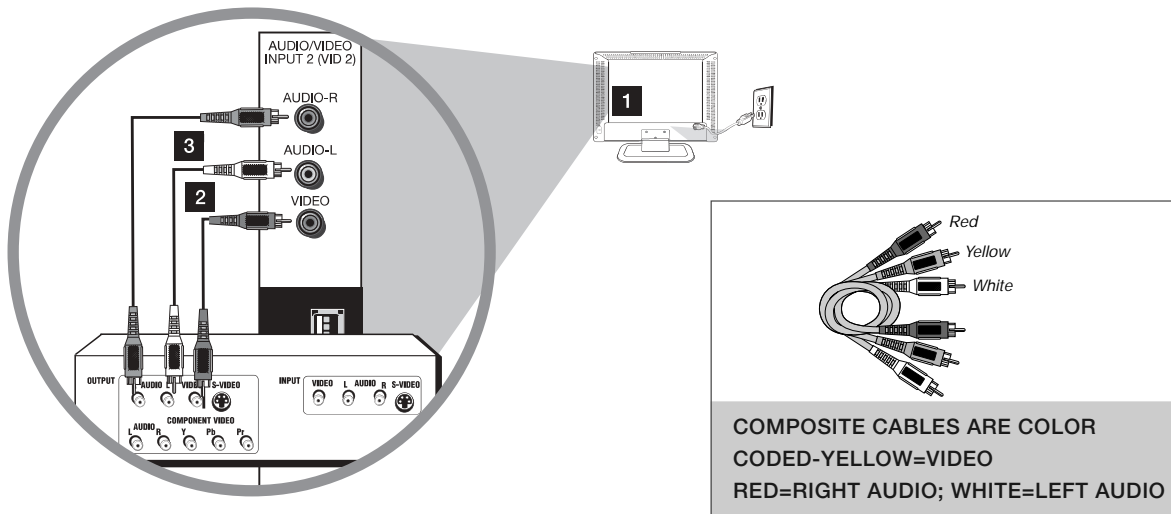

### **Don't forget:**

*If necessary, connect antenna or cable to get a picture. Go to page 9 for instructions.*

## Connecting a Component with Component Video (Better)

To connect a component that has Y Pb Pr jacks, such as a DVD player, follow these steps:

Example: DVD Player

1. Connect your cable and/or off-air antenna as described on page 9.
2. Connect three video cables or special Y Pb Pr cables to the COMPONENT INPUT (CMPT) Y Pb Pr jacks on the back of the TV and to the Y Pb Pr outputs on the DVD player.
3. Connect your red and white audio cables to the COMPONENT INPUT (CMPT) right and left AUDIO jacks on the back of the TV and to the audio output jacks on the DVD player.

## Component Video Connection

This is an example of a connection using the component video jacks. Go to page 11 for specific instructions.

### Don't forget:

If necessary, connect antenna or cable to get a picture. Go to page 9 for instructions.

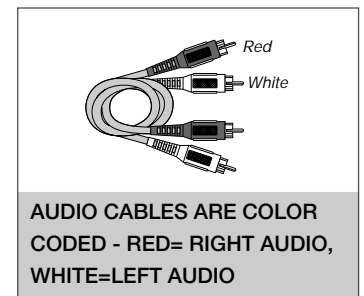
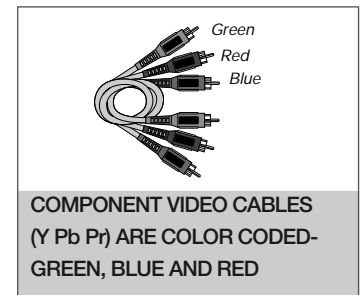
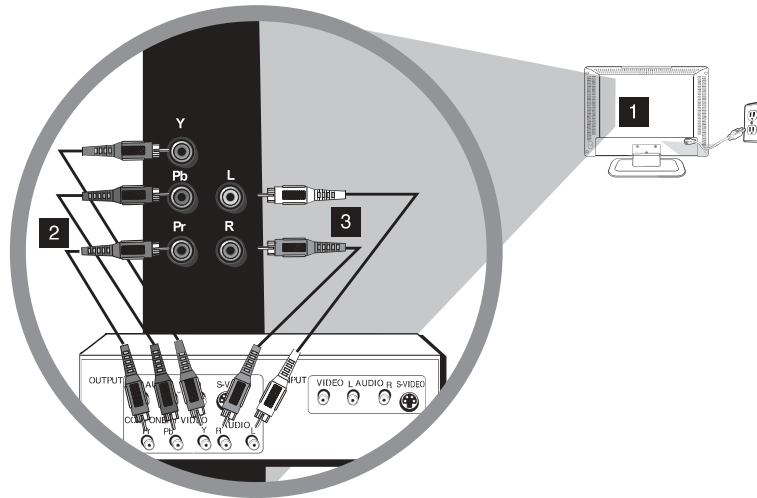

## Connecting a Component with HDMI (Best)

High-Definition Multimedia Interface (HDMI) technology is an uncompressed digital connection that carries both video and audio data by way of an integrated mini-plug cable. Since HDMI technology is based on Digital Visual Interface (DVI), the jack on the back of your TV is also compatible with components that have a DVI output jack.

Example: Set-top box with HDMI jack:

1. Connect an HDMI cable to the HDMI/DVI INPUT 1 jack on the back (or the HDMI INPUT 2/HDMI INPUT 3 jacks on the back or HDMI INPUT 4 on the side panel of the TV) and to the HDMI output jack on the back of the set-top box.

Example: Set-top box with DVI jack

To connect an HDMI cable and an HDMI/DVI adapter:

1. Connect an HDMI cable to the HDMI/DVI INPUT 1 jack on the back of the TV.
2. Attach an HDMI/DVI adapter to the end of the HDMI cable; then connect the adapter to the DVI output jack on the set-top box.
3. Since you're using an HDMI/DVI adapter, you need to connect separate audio cables to the DVI AUDIO INPUT right and left jacks on the back of the TV and to the right and left audio jacks on the back of the set-top box.

## HDMI/DVI Connection (Best)

This is an example of a connection using the HDMI/DVI INPUT 1 jack. Go to page 12 for specific instructions.

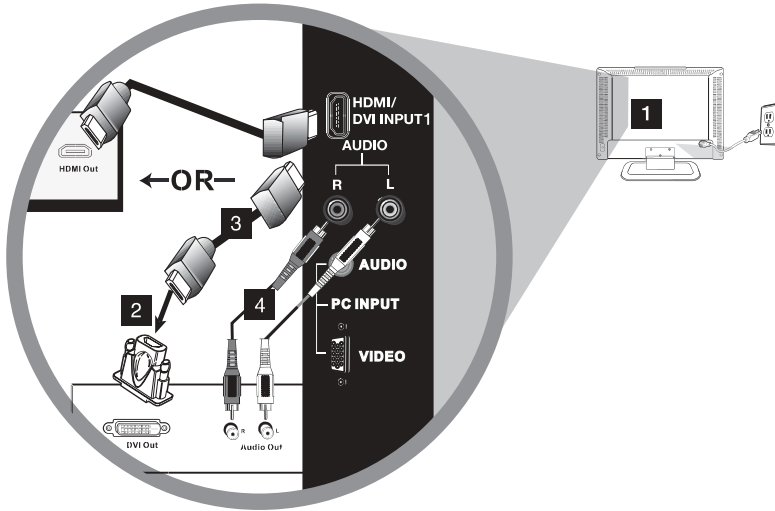

### Don't forget:

If necessary, connect antenna or cable to get a picture. Go to page 9 for instructions.

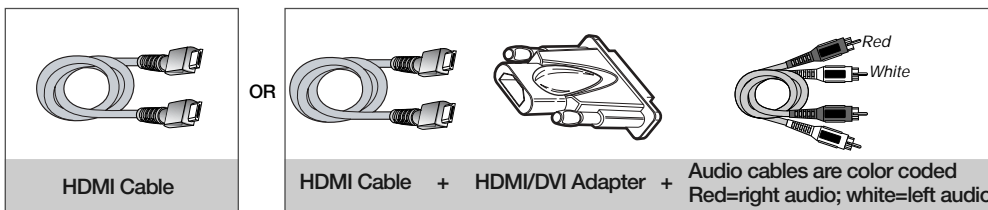

## Connecting a PC Component

To connect a personal computer and use your TV as a monitor, follow these steps:

1. Connect your cable and/or off-air antenna as described on page 9.
2. Connect one end of a 15-pin monitor cable to the PC VIDEO jack on the TV and the other end to the PC's video output jack.

**Note:** If your PC's video output isn't 15-pin, you'll need an adapter that can connect to a 15-pin monitor cable.

3. Connect a 3.5mm stereo mini-pin audio cable (sometimes referred to as 1/8" stereo mini-pin) to the PC AUDIO jack on the back of the TV and the other end to the audio output jack on the PC.

**Note:** The maximum resolution is 1024x768. Be sure to set your PC monitor setting accordingly.

## PC Connection

This is an example of a connection using the PC VIDEO jack. Go to page 13 for specific instructions.

### Don't forget:

If necessary, connect antenna or cable to get a picture. Go to page 9 for instructions.

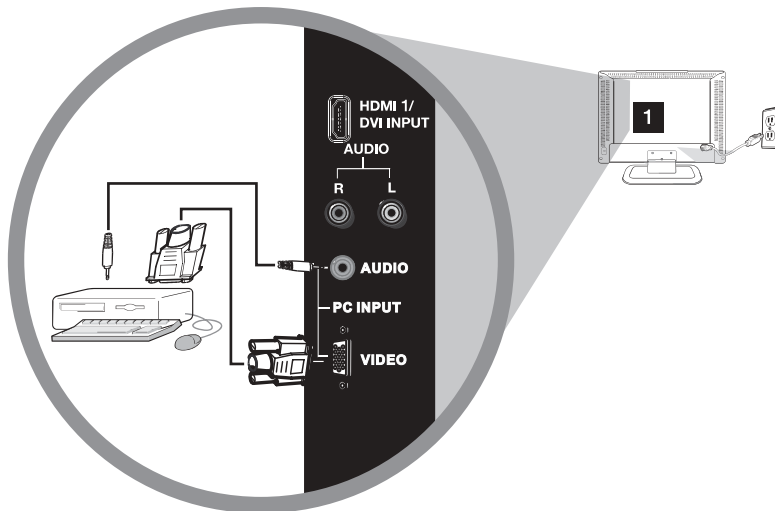

## Viewing the Picture from the Connected Component

1. Plug in the TV (see page 15 for details) and the component, such as a DVD player or a VCR.
2. Turn on the TV and the component you want to view.
3. Repeatedly press the INPUT button on the remote control to select VID 1 (if connected to the AUDIO/ VIDEO INPUT 1 jacks), CMPT (if connected to the COMPONENT INPUT jacks) or HDMI1 (if connected to the HDMI/DVI INPUT 1 jack) displayed at the top left of the TV screen. To return to viewing TV channels, use the number buttons to enter the channel you wish to view.

**Note:** If the picture from the DVD player appears black and white and your component is connected to the VIDEO INPUT, you may be tuned to the wrong input. Make sure you press INPUT until you select VID 1, CMPT or HDMI 1 displayed at the top left of the TV screen.

**Note:** When you have connected all additional components to your TV, go to page 16 for initial setup instructions.

## Viewing a PC

1. Plug in the TV and the computer.
2. Turn on the TV and the computer.
3. Repeatedly press the INPUT button on the remote control until you select PC displayed at the top left of the TV screen. To go back to viewing TV channels, use the digit keys to enter the channel or press CH+ or CH- buttons continuously.

**Note:** When you have connected all additional components to your TV, go to page 16 for initial Setup Instructions.

## Plug in the TV

Plug the end of the power cord into the back of the TV. Plug the other end into an outlet, inserting the plug completely. Do not plug the TV into an outlet controlled by a light switch.

## Put Batteries in the Remote

- Remove the battery compartment cover from the back of the remote control by pushing the tab and lifting off the cover.
- Insert 2 AA batteries, making sure the polarities (+ and -) are aligned correctly.
- Replace the cover.

## Turn on the TV

Turn on your TV by pressing the Power button (⏻) on the side of the TV or the ON•OFF button on the remote control.

## Using the Remote Control to Complete Initial Setup

You will need to use the remote control to complete the setup of your TV. The remote control allows you to navigate through and select items that appear in the on-screen menus. The process works the same on all menu screens: highlight your choice and select it.

To select a menu item, press the arrows to highlight one of the items listed on the screen. Use the up or down arrows to move up or down. Use the right or left arrow to view other selections for a menu choice or to display a sub-menu.

**Note:** Highlighted items stand out from other menu items on the list (appear darker, brighter, or a different color).

# Complete the Initial Setup

The menu system in your TV allows all of the TV's features to work properly. The first time you turn on your TV, the language screen appears.

## Set the Menu Language

The first step of the setup requires you to select your preferred language for the menu system. If English is your preferred language, press the OK button or right arrow and proceed to set the TV Location Mode. To choose another language, press the down arrow until that language is highlighted, and select it by pressing the OK button or right arrow.



## Set the TV Location Mode

After choosing the language, a menu screen asks you to set the TV Location. Choosing "Home" for the TV Location assigns the optimal picture settings for most home environments. This is also the most energy-efficient setting. Press OK to display the Channel Setup menu.

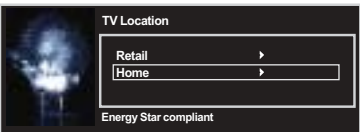

## Complete Channel Setup

Make sure you've connected the TV to the cable or an off-air signal before you start the next part of the setup.

## Set the Signal Type

From the Channel Setup menu, press the up or down arrow to highlight *Signal Type*. If you have connected the cable to your ANTENNA/CABLE INPUT jack, the option is chosen for you. Simply press the down arrow to continue.

To choose *Antenna*, press the OK button or right arrow; then press the down arrow to continue.

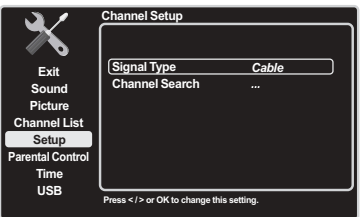

## Complete the Channel Search

With *Channel Search* highlighted, press the OK button to begin the channel search. If you chose *Cable* as your signal type, the search takes a while because it is looking for both analog and digital channels. Then, it removes scrambled channels.

The Channel Search process includes the following steps:

1. The search first seeks analog channels and places the number of channels found next to *Analog Channels Found*.
2. The search then looks for digital channels and places the number of channels found next to *Digital Channels Found*. This number may seem high. This is because the number includes both scrambled (for example, Pay-Per-View) and non-scrambled channels. These channels are dependent upon what your cable company is sending.
3. The search might appear as if it is complete, but as long as the search says *Running*, it is still in progress. The TV is now removing scrambled channels from the channel list.
4. When *Channel Search* is in progress, you can press the CANCEL button to cancel the search. Any channels already found will be stored.
5. When the search is complete, the Channel Setup Menu displays the following help text: "Channel Search complete. Press OK to review channels. Press CANCEL to exit, MENU for Setup Menu." If this is the TV's first installation, the help text displays "Channel Search complete. Press OK to review channels. Press CANCEL to exit."

You may find there are still some channels in your list that are unavailable to view. To delete these channels, press MENU and choose *Setup*. Highlight and select *List and Labels*.

**Note:** Removing channels from your channel list may be time-consuming, so you may want to do it later. Go to page 37 for details on editing your channel list.

**Note:** If you are using a satellite or cable set-top box, you do not need to complete Channel Search.

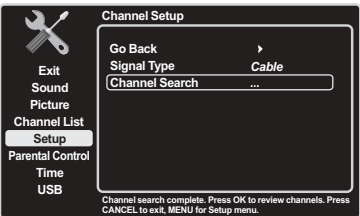
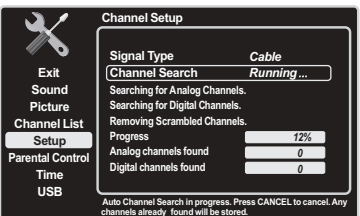



# What To Expect

## Watching TV

### Analog Channels

An "A" at the bottom of the screen denotes that you are watching an analog channel. Analog video is sent in a 4/3 format. Your TV can display these channels in a 16/9 format by pressing the FORMAT buttons to view the different formats available. Go to page 33 for more explanation of screen formats.

### Digital Channels

A "D" at the bottom of the screen denotes that you are watching a digital channel. Most digital video is sent in a 16/9 format, which fills the screen. However, it is sometimes sent in 4/3 format, which does not fill your screen. The format is dependent on how the station or source component is configuring the video.

***Note:** If there are bars on-screen, press the FORMAT button to try a different format. This may eliminate the bars. Some bars can't be removed because of the way the format is sent by the broadcaster. Go to page 33 for more explanation of screen formats.*

## Changing Channels

- Digital channels can have both primary channels (like the analog channel number) and sub-channels. To tune to a digital channel with a sub-channel, such as 10.1, enter the primary channel number (10), then press the right arrow button. Enter the sub-channel number (1) and press OK.
- Depending upon the type of signals you have connected to your HDTV, you may notice that the channels change more slowly than usual. This is perfectly normal. Digital channels sometimes take longer to tune.

## Explanation of Jacks (in alphabetical order)

This section describes the jacks on the back panel of your TV/DVD. There are several ways to connect components.

**ANTENNA/CABLE** Lets you connect a coaxial cable to receive the signal from your antenna, cable, or cable box.

**AUDIO/VIDEO INPUT 1 (VID 1)** Lets you connect a component that has composite video jacks, such as a VCR or DVD player.

- **L AUDIO** Provides left audio connection when using the VIDEO INPUT 1 jack. The left audio connectors are usually white. Use when connecting to the VIDEO or S-VIDEO INPUT. For mono audio sources, be sure to use the left AUDIO INPUT.
- **R AUDIO** Provides right audio connection when using the VIDEO INPUT 1 jack. The right audio connector is usually red. Use when connecting to the VIDEO or S-VIDEO INPUT.

**COMPONENT INPUT** Lets you connect a component that has component video jacks, such as a DVD player.

- **CMPT Y Pb Pr (Component Video)** Provides optimum picture quality because the video is separated into three signals. Use three video-grade or component video cables for the connection. When using CMPT Y Pb Pr, make sure you connect left and right audio cables to the CMPT L and R AUDIO jacks.
- **CMPT L AUDIO** Provides left audio connection when using the CMPT VIDEO inputs. The left audio connector is usually white. For mono audio sources, be sure to use the left AUDIO input.
- **CMPT R AUDIO** Provides right AUDIO connection when using the CMPT VIDEO inputs. The right audio connector is usually red.

**DIGITAL AUDIO OUTPUT (optical)** Use a digital optical cable to connect your TV to a compatible audio receiver.

**FIXED AUDIO OUTPUT** Use the left and right audio cables to connect your TV to a compatible audio receiver.

**HDMI INPUT 2 or HDMI INPUT 3** Lets you connect a component, such as a digital cable box, with an HDMI output for the best picture quality.

**HDMI/DVI INPUT 1** (High-Definition Multimedia Interface/Digital Visual Interface) Provides an uncompressed digital connection that carries both video and audio data by way of an integrated mini-plug cable. Since HDMI technology is based on Digital Visual Interface (DVI), the jack on the back of your TV is also compatible with DVI components.

- **DVI AUDIO L (used for DVI only)** Provides left audio connection when using the HDMI 1 jack for DVI. The left audio connector is usually white. For mono audio sources, be sure to use the left AUDIO input.
- **DVI AUDIO R (used for DVI only)** Provides right audio connection when using the HDMI 1 jack for DVI. The right audio connector is usually red.

**PC VIDEO INPUT** Connect your computer or other component with a VGA output to this jack using a 15-pin, D-sub cable.

**PC AUDIO (Stereo mini jack)** Use to obtain sound when a PC is connected to the PC input. Use a 3.5mm stereo mini-pin cable (sometimes referred to as 1/8" stereo mini-pin) to connect a PC to your TV.

**S-VIDEO INPUT** Allows you to connect an S-VIDEO cable from another component. Make sure you also connect audio cables from the component to the TV. To access a component connected to the S-VIDEO jack, press the INPUT button on your remote until you select VID 1.

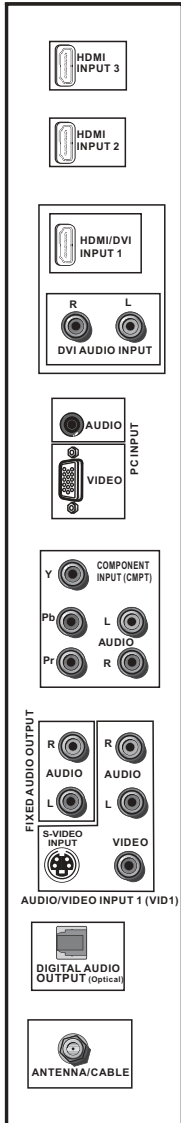

*Note: If using a DVI component, remember to connect the left and right audio cables because the DVI cable carries only the picture signal, not the sound.*

*Note: Do not connect the S-VIDEO and VID1 at the same time.*

# Buttons and Other Jacks on Your TV

## Side Input Jacks

**HEADPHONES** Allow you to connect headphones to listen to the sound coming from the TV.

**AUDIO/VIDEO INPUT 2 (VID 2)** Lets you connect a component that has composite video jacks, such as a VCR or DVD player.

- **L AUDIO** Provides left audio connection when using the VIDEO INPUT 2 jack. The left audio connectors are usually white. Use when connecting to the VIDEO INPUT. For mono audio sources, be sure to use the left AUDIO INPUT.
- **R AUDIO** Provides right audio connection when using the VIDEO INPUT 2 jack. The right audio connect or is usually red. Use when connecting to the VIDEO INPUT.

**HDMI INPUT 4** Allows you to connect a component with an HDMI OUTPUT.

**USB** This connection allows you to plug in a USB flash drive or connect to a compatible mass storage device with USB.

## Side Panel Buttons

If you cannot locate your remote, you can use the side panel buttons on your TV to operate many TV features.

**(⏻) POWER** Turns the TV on and off.

**MENU/(OK)** Brings up the TV Main Menu. When in the menu system, it displays sub-menus and selects highlighted items.

**VOL (▶)** Increases the volume. In the TV menu system, it acts like the right arrow on the remote control and can be used to select menu options.

**VOL (◀)** Decreases the volume. In the TV menu system, it acts like the left arrow on the remote control and can be used to select menu options.

**CH (▲)** Scans up through the channel list. In the TV menu system, it acts like the up arrow on the remote control and can be used to select menu options.

**CH (▼)** Scans down through the channel list. In the TV menu system, it acts like the down arrow on the remote control and can be used to select menu options.

**(🐶) (FETCH=MENU + VOL (▶))** Press the MENU and VOL (▶) at the same time and the remote control barks to be located.

## 2 Using the Remote Control



Remote control part number RC2254705/01

This is a multi-component remote control and many of the buttons have multiple functions.

**Note:** If you need to replace your remote, call 1-800-338-0376. A shipping and handling fee, and the appropriate sales tax, will be charged upon ordering. Have your Visa, MasterCard, or Discover Card ready.

### Remote Control Buttons

#### TV Functions

**Alphanumeric Buttons** Using these buttons, enter channel numbers, time setting.

To enter a channel, press the number buttons and press OK (or let the entry timeout).

To enter a digital channel with a sub-channel, enter the main channel; then, press the right arrow to enter the sub-channel and press OK.

**Arrows** (◀/▶/▲/▼) Use the four arrows to highlight different items in the TV menu and to adjust the menu controls. When viewing a channel, arrow functions are as follows:

- **Left Arrow/FORMAT** Press to change the screen format. Go to page 33 for more information on screen formats.
- **Right Arrow/GUIDE** Press this button first to display the electronic program guide-EPG (when available). Press again to view the program in the schedule.
- **UP Arrow/INFO** Press the up arrow once to display the Channel Banner; press again to remove the menu.
- **Down Arrow/PRESETS** Press this button to enter the PRESET Menu. Display *Picture* and *Sound* preset; *CC Setting*; *Current Audio Track*.

**CC** Takes user directly into the Closed Caption sub-menu.

**CH + or CH -** Scans up or down through the current channel list. Press once to change the channel up or down; press and hold to continue changing channels.

**CH LIST** When you tune to a particular channel, press the CH LIST button to enter the List and labels Menu directly to add/remove the channel from channel list.

**FETCH/CANCEL** Cancels the barking when Fetch has been activated. Cancel function: removes any menu or display from the screen and returns to normal viewing. Go to page 19 or 33 for more details.

**DVD** Places the remote in DVD Mode. If auto-tuning is enabled, turns on the TV and tunes it to the DVD channel. The DVD button illuminates when you press a valid button in DVD Mode (see Modes of Operation on page 23 for more details).

**F1-F4** Favorite channel buttons. Set a favorite channel button (F1/F2/F3/F4) to the current channel by holding the button down for two seconds. Each button can be set to a favorite channel, and you can change your selections at any time.

**GO BACK** Returns to the previous channel.

**INPUT** Accesses the available input channels (WATCH TV, VID 1, VID 2, CMPT, PC, HDMI 1, HDMI 2, HDMI 3 and HDMI 4.). To resume TV viewing, press the number buttons to enter the channel or press the CH+ or CH- buttons.

**MENU** Accesses the Main Menu.

**MUTE** Reduces the TV volume to its minimum level. Press again to restore the volume.

**OK** When in the menu system, pressing the OK button selects the highlighted item.

**PIC** Press the PIC button to display the *Picture* sub-menus.

**ON•OFF** When in TV Mode, pressing the ON•OFF button turns the TV on or off. If in another programmed mode (SAT/AUX or DVD), pressing the ON•OFF button turns the component on or off.

**REW, REPLAY, PLAY, NEXT, FWD, REC, STOP, PAUSE (buttons at TOP of the remote)**

If programmed, these buttons provide transport control for some remote-controllable components, such as VCRs or DVD players.

**ZZZ (SLEEP)** Press this button to display the TIME Menu and set the *Sleep Timer*.

**SAT/AUX** Places the remote in SAT/AUX mode. If Autotuning is enabled, pressing this button turns on the TV and tunes it to the satellite or cable box Video Input Channel. This button illuminates when you press a valid button in SAT/AUX mode (see Modes of Operation on page 23 for more details).

**TV** Turns on the TV, displays current status and puts the remote in TV Mode.

**V-CHIP** Press to display the Parental Control sub-menu.

**VOL - or VOL +** Decreases or increases the TV volume.

### **INPUT Button**

Use the INPUT button to scroll through the available video input channels and view components connected to the TV.

1. Make sure the component is turned ON.
2. Press INPUT to tune to an available video input source and view the component.
3. To return to the previous channel, press the INPUT button until you return to the channel.

## Programming the Remote to Operate Other Components

The universal remote can be programmed to operate many brands of remote-controllable components, such as VCRs, audio components, DVD players, cable boxes, and satellite receivers. Your remote control also comes pre-programmed to control some RCA components.

**Notes:**

- *The TV button can't be programmed to control other components.*
- *The remote may not be compatible with all models of all brands of components. It also may not provide complete functionality.*

### **Determine If You Need to Program Remote**

To determine whether the universal remote needs to be programmed to operate one of the components connected to your TV, such as a DVD player, follow these steps:

1. Turn on the component (for example, the DVD player).
2. Point the remote at the component.
3. Press the corresponding component button (DVD button).
4. Press ON•OFF to see if the DVD responds. If it doesn't, you need to program the remote to operate it.

## Programming the Remote

The CANCEL button is used as visual feedback during the programming operation. During programming, the CANCEL button illuminates when buttons are pressed and turns off when buttons are released. When programming is finished, the CANCEL button blinks slowly to indicate success and blinks rapidly to indicate failure.

**Note:** All component buttons are inoperable during Programming Mode.

There are three ways to program the remote control to operate other components: Direct Entry, Manual Code Search, and Automatic Code Search. You must try Direct Entry for at least one code before trying the other methods.

### Using Direct Entry

1. Turn on the component you want to control.
2. On your remote control, simultaneously press and hold the ON•OFF and MUTE buttons (approximately 3 seconds) until the CANCEL button illuminates. Release the buttons.
3. Press and release the component button.
4. Enter the appropriate four-digit code for the component you want to operate. The first digit indicates the component type (0 for DVD, 1 for Satellite TV, 2 for Cable, 3 for DVR, 4 for VCR, 5 for Audio, 6 for CD); the other three digits indicate the brand and model. Look up the brand and codes for the component in the list at the end of this section. Codes are listed by component type and are arranged alphabetically.
5. The CANCEL button blinks slowly to indicate success. Repeat these steps until you've tested all codes for your component's brand, or try to run a Manual Code Search.

### Using a Manual Code Search

**Note:** Before using Manual Code Search, use Direct Entry. This lets the remote know which type of component you are programming. Then proceed with the following steps:

1. Turn on the component you want to control.
2. On your remote control, simultaneously press and hold the ON•OFF and MUTE buttons (approximately 3 seconds) until the CANCEL button illuminates. Release the buttons.
3. Press and release the component button.
4. Repeatedly press and release the left or right arrow, watching for the component to respond. If the component turns off, press and release the OK button to save the code. The CANCEL button blinks slowly to indicate success.
5. When all codes have been searched, the CANCEL button blinks rapidly to indicate failure, and the remote returns to normal operation.

**Note:** Use the right arrow to search ahead; use the left arrow to search back. Press the ON•OFF button to switch to Automatic Code Search Mode.

### Using Automatic Code Search

1. Turn on the component you want to control.
2. On your remote control, simultaneously press and hold the ON•OFF and MUTE buttons (approximately 3 seconds) until the CANCEL button illuminates. Release the buttons.
3. Press and release the component button.
4. Press and release the ON•OFF button once. The remote starts the code search.
5. Once the component turns off, quickly press the OK button to save the code. The CANCEL button blinks slowly to indicate success.

6. When all codes have been searched, the CANCEL button blinks rapidly to indicate failure, and the remote returns to normal operation.

*Note: If you accidentally passed the code before saving it, use the left arrow to backtrack through the codes. Use the right arrow to go forward through the codes again. Once the left or right arrow has been pressed, the search mode changes to Manual Code Search.*

## Using the Remote

Once the remote has been programmed successfully, it is ready to operate your components.

To operate the component:

1. Press the component button (SAT/AUX or DVD) to set the remote to control the component. For example, press DVD to control your DVD player.
2. Press ON•OFF to turn the component ON or OFF.
3. Use the remote buttons that apply to that component.

## Modes of Operation

The button that corresponds to the mode the remote is in illuminates when you press any button that applies to the component. For example, if you're in TV Mode and you press the VOL+ button, the TV button lights up. This tells you that the command to increase the volume is being sent to the TV.

*Note: The remote control may not be compatible with all brands and models of components.*

## Manual Reset

The Manual Reset is used to reset the remote settings to default.

*Note: The reset can also be accomplished by replacing the batteries; however replacing the batteries does not always cause a reset. You can perform a manual reset by following these steps:*

1. On your remote control, simultaneously press the V-Chip, ON•OFF and MUTE buttons.
2. The CANCEL button will blink slowly to indicate success, and the remote control returns to normal operation.

# Remote Code List

**Note:** The codes are programmable to any of the device buttons (SAT /AUX or DVD) on the remote. The remote code is a 4-digit code. The first digit indicates the database device type (0 for DVD, 1 for Satellite TV, 2 for Cable, 3 for DVR, 4 for VCR, 5 for Audio and 6 for CD), the following 3 digits indicate the brands as follows:

## Audio Codes

Accuphase .....	032
Accurus .....	033
ADC .....	074
Adcom .....	056
Admiral .....	150
ADS .....	151
Aiwa 014 072 073 109 214 225 279 287 335 369	
Akai .....	142
Alco .....	093
Alpine .....	152
Altec Lansing .....	140
Amphion Media Works .....	104 107
Amplifier Technologies .....	118
ANMW .....	104 107
Anam .....	080 148
Angstrom .....	034
Apex .....	403 407 095
Aragon .....	033
Arcam .....	131
Atlantic technology .....	120
Audio Research .....	154
Audio Source .....	035
AudioPhase .....	388
Audiotronic .....	061
Audiovox .....	093 399 417
B & K .....	155
Bang & Olufsen .....	353
Bel Canto Design .....	036
Biamp .....	037
BOSE .....	010 075 082 117 371 384
Boston Acoustics .....	121
Brix .....	146
California Audio Lab .....	028
CambridgeSoundWorks .....	418
Cpnetronic .....	074
Carver .....	061 073
Cary Audio Design .....	031
Casio .....	125
CCE .....	177
Chase Technologies .....	029
Cinema Sound .....	038
Clarinet .....	125
Claron .....	156
Classe .....	039
Classic .....	411
Coby .....	018
Counterpoint .....	157
Creative .....	129
Criterion .....	136
Curtis .....	409
Cary Audio Design .....	031
Curtis .....	409
Curtis Mathes .....	022
Daewoo .....	132
Dell .....	134
Delphi .....	158
Denon .....	009 058 090 205 220 226
227 242 259 263 267 282 286 304 305 309 310	
311 312 315 341 344 345 368 413	
Digital Audio Control .....	030
Durabrand .....	040 434
EAD .....	159
Eclipse .....	209
Elan .....	041
ESA .....	160
Fisher .....	114
Fosgate .....	042
Garrard .....	128
Gateway .....	145
GE .....	020
Glory Horse .....	133
Go Video .....	144
GPX .....	404 421
Gradiente .....	389
Halfer .....	161
Harman/Kardon .....	013 026
073 078 088 264 319 397	
Hitachi .....	114
Honyas .....	162
iLive .....	429
Initial .....	137
Inkel .....	122
Insignia .....	337 338 416
Integra .....	055
Jamo .....	275
JBL .....	051 088 397
Jensen .....	163
Jerrold .....	391
JVC .....	004 023 092 097 201231 249 261 272
273 300 303 307 318 355 359 360 366 373 376	
377 408	
Kenwood .....	005 089 105 106 185 186 188
189 198 200 219 223 232 237 240 251 255 296	
308 320 331 370 380	
KLH .....	093 094
Knoll System .....	043
Koss .....	091 394
Krell .....	326
Lasonic .....	149
Left Coast .....	026
Lenox .....	138
Lexion .....	130
LG .....	406 432
Linn .....	073
Liquid Video .....	141
Lloyds .....	125
Logitech .....	044
Luxman .....	045
LXI .....	124
Magnadyne .....	164
Magnavox .....	016 061 073 074 100 401
Marantz .....	026 061 073 329 340
Mark Levinson .....	046
McIntosh .....	047
MCS .....	126
Memorex .....	165
Midland .....	048
Mitsubishi .....	290 313
Modulaire .....	125
Motorola .....	139
NAD .....	066
Nakamichi .....	065 067 070
NEC .....	027
Neo .....	158
Nexxtech .....	119
Niro .....	166
Norcent .....	135
Nova .....	167
Omnifi .....	147
Onkyo .....	006 055 057 069 077 101 190 194 203
210 213 233 252 260 265 266 269 270 271 274	
278 291 292 306 323 324 348 350 398	
Optimus .....	022 074 076 079 080
Oritron .....	091
Panasonic .....	002 087 102 108 112 113 153
229 289 301 316 354 357 364 375 385 386 390	
395 396 422 423 424 425 426 427 433	
Parasound .....	062
Penny .....	125
Philco .....	168
Philips .....	012 026 061 073
085 349 362 379 412	
philips Magnavox .....	435
Pioneer .....	003 022 052 071 074 079 183
184 192 193 195 212 221 222 224 238 239 241	
353 314 330 336 342 343 346 352 383	
Polaroid .....	436
Polk Audio .....	026 073 328
Proscan .....	083
Pyle .....	169
Radio Shack .....	133 434
RCA .....	007 022 074 079 080
083 093 099 363 367 372 380 393 434	
RCA & Dimensia .....	437
Realistic .....	125
Regent .....	138
Rio .....	116
Rotel .....	334
Saba .....	143
Samsung .....	011 068 098 332 428 431
Sansui .....	073
Sanyo .....	096 114 414
Schneider .....	170
Scientific Atlanta .....	127
Scott .....	123
Sharp .....	015 361 378 419
Sharp Image .....	133

Sherwood .....	297 339 420
Shinsonic .....	171
shure .....	027
Skyfi .....	158
Sonic Blue .....	116
Sony .....	000 025 050 084 103 110 111
115 178 179 180 181 182 187 197 207 215 216	
217 218 230 235 276 277 293 294 295 325 356	
358 365 374 382 387 392 400 430	
Soundesign .....	020 076
Soundmatters .....	063
SoundStream .....	049
Starcom .....	391
Stereophonics .....	079
STS .....	172
Sunfire .....	089
Sylvania .....	327
Symphonic .....	150
TAG McLaren .....	173
Tao .....	158
Teac .....	080 093
Technics .....	008 204 208 211 228
280 281 283 299	
Techwood .....	174
Thomson .....	175
Thorens .....	061
Toshiba .....	410
Vector Research .....	176
Venturer .....	093 415
Victor .....	023
Wards .....	020 071 073 346
XM Radio .....	158
Yamaha .....	001 021 024 053 054 055
059 060 064 081 086 191 196 199 206 234 236	
243 244 245 246 247 262 268 284 285 288 302	
317 321 347 351 402 405	
Yorx .....	125
Zenith .....	019 333 406

## Cable Codes

ABC .....	008 009 022 026 032 034
040 041 042 081 085	
Adelphia .....	005 025
Americast .....	092
Antronix .....	045 046
Archer .....	046 047
AT & T .....	002
Bell South .....	092
Cable Vision .....	004 102
Cabletenna .....	045
Cableview .....	044
Citizen .....	051
Clearmaster .....	091
ClearMax .....	091
Colour Voice .....	049 050
Comcast .....	000 001 039
Comtronics .....	035 051
Contec .....	026 031 053
Coolmax .....	091
COX .....	001
Director .....	001 089
Eastern .....	054
Everquest .....	035 086
Focus .....	088
GC Electronics .....	046 051
GE .....	040 041
Gemini .....	055 056 086
General Instrument .....	000 001 041 083 089 101
Goldstar .....	035 036
Hamlin .....	057 058 059 065 071 074 082 095 096
Hitachi .....	041
illico .....	102
Jasco .....	086
Jerrold .....	001 041 055 060 061 075 081 083
086 087 089 101	
Magnavox .....	062
Memorex .....	063 085
Monarch .....	051
Motorola .....	001 002 018 039 087 089 094 101 103
Movie Time .....	051 064
Multi Canal .....	051
Multitech .....	091
NEC .....	043



NET Brazil	006	Aiwa	017 232	Kendo	109
Novavision	027	Akai	022 236	Kenwood	004 024 116 198 204 214 230
NSC	064	Alco	027	231 252	
Oak	053 066	Allegro	059	KLH	027 046 147
Pace	007 008 009 010 011 012 013	Alpine	220	Konka	018 019
014 015 016 017 022 024 025		Amphion MediaWorks	014 033	Koss	015 026 035 448
Panasonic	077 080 085	AMW	014 033	Lasonic	253
Paragon	085	Anaba	067	Landel	222
Philips	048 049 050 052 056	Anam	068	Lenoxx	034 051 054
062 067 068 069 098 099		Apex	005 045 046 126 136 164 166 176	Lexia	110
Philips Magnavox	056 098	188 242 243 244 324 390 457 461		Lexicon	085
Pioneer	007 019 024 025 036 037 070	Apple	426	LG	013 284 331 333 352 369
084 090 102		Arrgo	050	370 373 460 486 488	
Popular Mechanics	088	Aspire	032	Lifetec	111
Proscan	040 041	Astar	351	Limit	110
Pulsa	051 085	Audiologic	069	Liquid Video	035
Quasar	085	Audiovox	004 011 027 224 454 471 475	Liteon	323 332 348 353
Radio Shack	086 091	Axion	070	Loewe	086
RCA	044 076 078 080 083	B & K	071	Logiclab	104
Realistic	046	Bang & Olufsen	048	Logix	112
Recoton	088	Bel Canto Design	072	Luxman	113
Regal	059 071 082 096 097	Blaupunkt	046 153	Luxor	109
Regency	054	Blue Parade	043	Magnavox	010 023 039 042 052 150
Rembrandt	041	BOSE	245 430 441	156 185 326 356 380 388 437 456	
Rogers	102	Boss Audio System	073 444	Malata	087
Runco	085	Broksonic	022 233 372 406	Marantz	042 156 275
Samsung	035 036 037 038 051	California Audio Labs	024	Memorex	010 022 140 254
Scientific Atlanta	002 005 007 008 009 019	BridgeSoundWorks	474	Microsoft	041
020 022 023 024 025 026 027 028 029 030 031		CAVS	074	Mintek	046 255
032 033 034 102		CineVision	049 113 414	Mitsubishi	016 038 040 161 194
Signal	035 051 055 086	Clarion	246	Momitsu	088
Signature	041	Classic	216 247 463	Mustek	458
SL Marx	035	Coby	012 030 031 157 192 206 451	NAD	248 256
Sony	004 093	Criterion	075	Nakamichi	257
Sprucer	080	Curtis	451	Nesa	046
Standard Component	072 073	Curtis Mathes	060	Next Base	058
Starcom	055 081 086	CyberHome	006 050	Nexxtech	055 276
Stargate	035 051 055 086	Cytron	491	Niro	089
Starquest	055 086	Daewoo	141 234 271 419	Nissoho Iwai	079
Supercable	087 104	Denon	004 024 116 165 175 195 296 467	Norcent	030 222 237 258 279
Supermax	091	DiamondVision	289	Onkyo	025 039 159 190 225 453
TeleView	035 051	Disney	010 140	Oppe	047
TIME WARNER	003 102	Dual	076	Optiview	067
Timeless	035	Duarabrand	027 051 054 113 259	Oritron	026 035 260
Tocom	042 060	DVD2000	040	Orion	022
Toshiba	085	Eclipse	301	Panasonic	004 024 039 116 117 127 149
Tristar	091	Elta	084	152 172 173 178 208 265 266 267 290 291 292	
Tusa	055 086	Eitax	064	299 300 312 336 341 371 383 385 386 387 407	
TV86	064	Emerson	010 023 052 248 391 395 465	431 432 434 436 438 443 449 450 476 477 478	
U.S.Electronics	026	Enterprise	056	479 480 489 490	
Unika	045 046	ESA	052 235	Philco	065
United Cable	081	Fahrenheit	077	Philips	002 010 039 042 150 156 162
Universal	045 046 047	Fisher	249 280	196 209 294 305 334 337 342 391 437 448	
V2	091	Flex Vision	078	philips Magnavox	162 209 337
Verizon	105	Fun TV	079	Pioneer	009 036 043 134 146 160 170 181 193
Videotron	102	Funai	010 052 340 379 391	201 203 238 282 295 313 314 315 339 377 429	
View Star	053 062 064	Gateway	323	Polaroid	014 390 423
Vision	091	GE	041 046 125 167 205 250	Polk Audio	042
Vortex View	091	Go Video	003 187 226 227 323 402	Portland	090
Zenith	079 085 092 100	404 413 418 420 421		Presidian	010 391
Zentek	088	Goldstar	425	Prima	091
		GPX	251 278 451 458	Princeton	092
		Gradiente	024 274	Proceed	045
		Greenhill	046	Proscan	041 125 184
		Grundig	042	Provision	093
		Harman/Kardon	199 210	Pye	356
		Hitachi	003 144 200 217 299 376 417	Qwestar	026 239 260
		Hiteker	045	RCA	000 008 027 041 043 046 125 130 179
		Honda	080	184 191 197 228 288 338 389 401 411 422 447	
		Honyas	081	regent	034
		iLive	484	Rio	066
		iLo	053	Rotel	044
		Ingelen	105	Rowa	028
		Initial	046	Saba	094
		Insignia	013 052 113 375 470	Sampo	261
		Integra	025 043 057 062	Samsung	003 024 120 124 139 145 148 183
		Irradio	346	189 285 293 322 325 330 336 355 357 368 384	
		Jamo	082	396 405 412 415 439 445 472 481 485 487	
		Jaton	083	Sansui	022 233 378
		JBL	452	Sanyo	022 280 347 424 468
		Jenken	106	Sensory Science	323
		Jensen	031	SEG	014
		JMB	107	Sharp	010 128 137 320 343 344 374
		JVC	007 044 142 143 207 212 219 269	379 410 473	
		281 317 318 319 321 364 365 366 367 397		Sharper Image	095
		398399 400 403 409		Sherwood	262 474
		Jwin	084	Shinco	166 240
		Karcher	108	Shinsonic	037
		Kawasaki	027	Sigma Designs	092

## CD Codes

Aiwa	009
BOSE	011
Denon	007 019
Harman/Kardon	004
JVC	001 013 025 026
Kenwood	010 014
Marantz	015
Onkyo	006 016
Panasonic	000 017 023 029
Philips	003 032
Pioneer	005
RCA	028
Sanyo	022
Sharp	002
Sherwood	020
Sony	012 024 027 030 031
Teac	021
Technics	008
Yamaha	018

## DVD

Accel Vision	177
Accurian	353
Advent	029

Sonic Blue	.....059 061 063 066
Sony	.....001 020 037 115 118 121 122 123
131 133 135 154 155 158 163 168 223 229 268	
283 306 307 308 335 354 358 360 362 381 392	
394 427 428 433 435 440 442 446 455 464 466	
482 483	
Sungale	.....270
Superscan	.....023
SVA	.....096
Sylvania	.....010 023 052 340 391 395 416
Symphonic	.....010 391
Teac	.....027 224
Technics	.....004 024
Technosonic	.....097
Techwood	.....241 263
Terapin	.....098
Theta Digital	.....043
Tivo	.....099
Toshiba	.....002 021 022 039 119 129 132
138 171 180 182 286 297 302 303 304 309 310	
311 316 327 328 329 359 363 382 393 408 462	
Tredex	.....100
Trutech	.....273
TView	.....067
Urban Concepts	.....039
US Logic	.....224
Venturer	.....027 469
Vizio	.....101
Vocopro	.....102
Westinghouse	.....492
Xbox	.....041
Xwave	.....103
Yamaha	.....024 042 116 150 169 174
196 202 211 215 218 277 345 459	
Zenith	.....013 039 113 151 186 213 227 264
298 349 350 369 425 460	
WHITE WESTINGHOUSE	.....492

## DVD/VCR Combo Codes

Where the code is listed as [### ###] the first is for the DVD and the second is for the VCR. Otherwise just the one code operates both the DVD and the VCR. Remember to add the code for the database device type 0 for DVD, 4 for VCR, [0### 4###].

Broksonic	.....[372 062] [022 072] [406 088]
Hitachi	.....[376 013] [417 103]
Insignia	.....[375 016] [013 047] [113 117]
JVC	.....[364 052] [365 053] [366 054]
[367 055] [317 056] [318 058] [319 059] [403 094]	
[397 079] [398 080] [399 081] [400 082] [403 085]	
[409 095] [317 056] [318 058] [319 059]	
LG	.....[369 016] [373 060] [013 047]
[331 060] [370 060]	
Pioneer	.....[377 064]
Sansui	.....[378 065] [022 072]
Sharp	.....[374 124] [379 125] [410 111]
Toshiba	.....[363 051] [382 067] [119 091]
[119 096] [393 076] [408 092] [393 115]	
Zenith	.....[369 016] [151 116] [227 099]
Apex	.....[390 074]
CineVision	.....[113 101] [414 117]
Daewoo	.....[419 107]
Durabrand	.....[113 117]
Emerson	.....[395 010] [395 103]
Funai	.....[379 125]
Go Video	.....[227 100] [402 084] [404 086]
[413 087] [418 106] [420 108] [421 109]	
Goldstar	.....[425 114]
Magnavox	.....[156 009] [380 126] [156 104]
[388 071]	
Memorex	.....[022 072]
Panasonic	.....[383 061] [385 068] [386 069]
[407 089] [407 105] [371 061]	
Philips	.....[156 009] [391 075]
Polaroid	.....[390 074] [423 112]
Presidian	.....[391 075]
RCA	.....[389 073] [401 083] [411 097] [422 110]
Samsung	.....[368 005] [384 070] [396 078]
[405 087] [412 098] [415 087]	
Sanyo	.....[424 113]
Sony	.....[360 048] [361 049] [362 050]
[381 066] [392 093] [394 093] [394 077] [392 090]	
Sylvania	.....[391 075] [395 102] [416 103]
Symphonic	.....[391 075]
Diamond Vision	.....[289 126]
AKAI	.....[236 127]
Superscan	.....[023 128]

## DVR Codes

ABS	.....020
Alienware	.....020
AT&T	.....030
Bang & Olufsen	.....023
Cyberpower	.....020
Dell	.....020
DIRECTV	.....002 007 008 010 011 012 015
019 021 024 026 027	
Dish Network	.....017 018
Dishpro	.....017
Echostar	.....017 018
Expressvu	.....017
Gateway	.....020
GOI	.....017
Hewlett Packard	.....020
HNS	.....009
Howard Computers	.....020
HP	.....020
HTS	.....017
Hughes	.....001 010 011 012 015
Hughes Network System	.....001 010011
012 015 024 026 027	
Humax	.....015
Hush	.....020
iBUYPOWER	.....020
JVC	.....001 017 018
Linksys	.....020
Media Center PC	.....020
Microsoft	.....020
Mind	.....020
Niveus Media	.....020
Northgate	.....020
Panasonic	.....005 022 030
Philips	.....001 009 012 015 024 025
Pioneer	.....031
Proscan	.....019
RCA	.....001 002 009 016 019 021
ReplayTV	.....004 022 030
Samsung	.....009 024
Sonic Blue	.....004 022 030
Sony	.....000 013 014 020
Stack 9	.....020
Systemax	.....020
Tagar Systems	.....020
Tivo	.....000 001 002 003 010 013
014 015 025 026 027 028	
Toshiba	.....006 020
Touch	.....020
UltimateTV	.....021
Viewsonic	.....020
Voodoo	.....020
ZT Group	.....020

## Home Theatre in a Box

Where the code is listed as [### ###] the first is for the DVD and the second is for the AUDIO. Otherwise just the one code operates both the DVD and the AUDIO. Remember to add the code for the database device Type, 0 for DVD, 5 for Audio [0### 5###].

Apex	.....[457 403] [461 407]
Audiovox	.....[471 417] [475 399] [454 399]
BOSE	.....[430 384] [441 010]
CambridgeSoundWorks	.....[474 418]
Classic	.....[463 411]
Coby	.....[451 018]
Curtis	.....[451 409]
Denon	.....[467 413]
Emerson	.....[465 017]
GPX	.....[451 421] [458 404]
iLive	.....[484 429]
Insignia	.....[470 416]
Jamo	.....[082 275]
JBL	.....[452 397]
Koss	.....[448 394]
LG	.....[284 432] [460 406] [486 406]
[488 406]	
Magnavox	.....[437 016] [456 401]
Onkyo	.....[453 398]
Panasonic	.....[431 385] [432 390] [434 386]
[436 385] [438 385] [449 395] [450 396] [476 422]	
[477 423] [478 425] [479 426] [480 427] [489 433]	
[490 434] [438 424]	
Philips	.....[437 016] [448 412]
Pioneer	.....[429 383]
RCA	.....[447 393]
Samsung	.....[439 011] [445 011] [481 332]
[485 431] [487 431] [481 428]	

Sanyo	.....[468 414]
Sharp	.....[473 419]
Sherwood	.....[474 420]
Sony	.....[427 382] [433 430] [435 387]
[440 430] [442 387] [446 430] [455 400] [464 387]	
[466 430] [482 430] [483 430] [433 392]	
Toshiba	.....[462 410]
Venturer	.....[469 415]
Yamaha	.....[459 405]
Zenith	.....[460 406] [425 019] [425 333]
Durabrand	.....[259 434]
JVC	.....[143 408]

## Satellite TV Codes

Alphastar	.....051
Amstrad	.....100
Chaparral	.....045
DIRECTV	.....001 006 007 008 009 010
013 014 015 031 032 034 036 039 043 044 054	
055 057 058 059 062 063 064 066 067 068 069	
074 078 079 080 081 084 086 087	
Dish Network	.....002 004 017 018 019 020
021 022 023 024 025 026 027 028 029 030 033	
035 037 041 061 083	
Dishpro	.....035 037 061
Drake	.....046
Echostar	.....002 004 033 035 037 061 071 083
Expressvu	.....037 061 07
BELL EXPRESSVU	.....071
FORTEC STAR	.....101
GE	.....063 087
General Instrument	.....047 048 056
GOI	.....061
Grundig	.....100
Hisense	.....060
Hitachi	.....009
HTS	.....061
Hughes Network Systems	.....003 006
008 015 031 043 057 064 073	
Humax	.....090
iLo	.....060
Jerrold	.....056
JVC	.....002 004 033 052 061 083
LG	.....011 059
Magnavox	.....014
Memorex	.....014
Mitsubishi	.....006 008 064 093
Motorola	.....038 056 065
Next Level	.....056
Pace	.....100
Panasonic	.....010 062 086 092 096 100
Pansat	.....088
Paysat	.....014
Philips	.....001 003 009 014 015 031
054 055 057 064 081	
Philips Magnavox	.....009 054 055
Pioneer	.....015
Primestar	.....050
Proscan	.....013 036 063 095
Proton	.....060
Radio Shack	.....056
RCA	.....000 003 013 034 040 044
058 063 075 076 077 078 080 082 091 094 095	
097	
Realistic	.....049
Samsung	.....003 007 015 057 070 085 098
Sharp	.....016
SKY NETWORK	.....100
Sony	.....005 032 042 066 074 079 084
Star Choice	.....038 056 072
STS	.....053
Sylvania	.....099
Tivo	.....003 015 057
Toshiba	.....006 008 009 064
UltimateTV	.....058
Uniden	.....014
US Digital	.....060
USDTV	.....060
Viewsat	.....089
Voom	.....056
Zenith	.....012 067

## VCR Codes

ABS	.....038
Adventura	.....010 028 125
ADMIRAL	.....097
Aiwa	.....010 028 035 125
Aiko	.....107

Akai .....	.017 018 033 127	MGN Technology .....	.021	Videosonic .....	.021
Alienware .....	.038	MGA .....	.008	Viewsonic .....	.038
American High .....	.025	Microsoft .....	.038	Villain .....	.010 125
Apex .....	.074	Midland .....	.029	Voodoo .....	.038
Asha .....	.021	Mind .....	.038	Wards .....	.010 021 022 023 025
Audio Dynamics .....	.019	Minolta .....	.030	026 028 030 125	
Audiovox .....	.022 035 121	Mitsubishi .....	.008 030	White Westinghouse .....	.036
Bang & Olufsen .....	.037	Motorola .....	.025	Westinghouse .....	.046
Beaumont .....	.021	MONTGOMERY WARD .....	.097	XR-100 .....	.010 025 028 125
Bell & Howell .....	.020	MTC .....	.010 021 125	Yamaha .....	.019 020 024 033
Broksonic .....	.027 062 072 088	Multitech .....	.010 021 028 029 125	Zenith .....	.007 010 016 018 032 034 099 116
Calix .....	.022 035	NEC .....	.019 020 024 033	117 120 122 125	
Candle .....	.021 022 023 024	Nikko .....	.022 035	ZT Group .....	.038
Canon .....	.015 025	Niveus Media .....	.038		
CARVER .....	.104	Noblex .....	.021		
CCE .....	.107	Northgate .....	.038		
CineVision .....	.101 117	Olympus .....	.025		
Citizen .....	.021 022 023 024 035	Orion .....	.014		
Colortyme .....	.019	Panasonic .....	.000 015 025 039 061 068 069		
COLT .....	.046	089 105 118 119			
Craig .....	.021 022 026 035	Penney .....	.035		
Curtis Mathes .....	.012 015 019 021	Pentax .....	.030		
024 025		Pentax Research .....	.024		
Cybernex .....	.021	Philco .....	.015 025		
CyberPower .....	.038	Philips .....	.009 025 075 104		
Cyberpower .....	.038	Philips Magnavox .....	.104		
Daewoo .....	.011 023 027 028 107	Pilot .....	.022 035		
Davidson .....	.010 125	Pioneer .....	.030 064		
DBX .....	.019	Polaroid .....	.074 112		
Dell .....	.038	Polk Audio .....	.104		
Denon .....	.030	Presidian .....	.075		
DiamondVision .....	.126	Proscan .....	.012 043 044		
Dimensia .....	.012	PROTEC .....	.046		
Durabrand .....	.017 117	PROFITRONIC .....	.021		
Dynatech .....	.010 028 125	Pulsar .....	.007 032		
Electrohome .....	.022 035	Quarter .....	.020		
Electrophonic .....	.022 035	Quartz .....	.020		
Emerson .....	.010 017 022 023	Quasar .....	.015 025		
025 027 028 035 075 103 125		Radio Shack .....	.010 022 125		
Emerex .....	.001	Radio Shack/Realistic .....	.015 020 021 022		
ESA .....	.047	025 026 028			
Fisher .....	.020 026 045	Radix .....	.022 035		
Fuji .....	.018 025	Randex .....	.022 035		
Funai .....	.010 028 036 075 125	RCA .....	.003 012 017 021 025 030 042		
Garrard .....	.010 028 125	073 083 097 110			
Gateway .....	.038	Realistic .....	.010 015 020 021 022 023 025		
GE .....	.012 015 021 025	026 028 035 125			
Go Video .....	.084 086 087 100 106 108 109	Ricavision .....	.038		
Goldstar .....	.019 022 024 035 114	Ricoh .....	.034		
Gradiente .....	.010 028 125	Runco .....	.007 032		
Harley Davidson .....	.028	Samsung .....	.005 021 023 029 070 078 087 098		
Harman/Kardon .....	.019	Sanky .....	.007 032		
HARWOOD .....	.046	Sunsui .....	.010 014 033 065 072 125		
Headquater .....	.020	Sanyo .....	.020 021 026 045 113		
Hewlett Packard .....	.038	Scott .....	.023 027		
Hi-Q .....	.026	Sears .....	.010 020 022 025 026 030 035 125		
Hitachi .....	.010 013 030 033 103 125	Sharp .....	.010 063 111 124 125		
Howard Computers .....	.038	Shintom .....	.018		
HP .....	.038	Shogun .....	.021		
Hush .....	.038	Singer .....	.025 034		
Hughes Network Systems .....	.030	SIGNATURE .....	.110		
iBUYPOWER .....	.038	Sony .....	.001 010 018 031 038 040 048 049		
Insignia .....	.016 047 117	050 066 077 090 093 123 125			
Instant Replay .....	.025	Stack .....	.038		
JC Penney .....	.015 019 020 021 022 025 0230	Stack 9 .....	.038		
JCL .....	.025	STS .....	.025		
Jesen .....	.030 033	Superscan .....	.128		
JVC .....	.004 019 020 024 033 041	Sylvania .....	.010 015 025 028 075 102 103 125		
052 053 054 055 056 057 058 059 079 080 081		Symphonic .....	.010 028 036 075 125		
082 085 094 095		Systemax .....	.038		
KEC .....	.035	Tagar Systems .....	.038		
Kenwood .....	.019 020 024 033	Tandy .....	.020		
Kodak .....	.022 025 035	Tashiko .....	.022		
KLH .....	.046	Tatung .....	.033		
LG .....	.016 022 047 060	Teac .....	.010 028 033 125		
Linksys .....	.038	Technics .....	.025		
Lloyd's .....	.010 028 125	Teknika .....	.010 022 025 028 035 125		
LOGIK .....	.046	Thomas .....	.010 125		
LXI .....	.022 035	TMK .....	.021		
magnavox 006 007 010 015 025 032 071 104 125		Toshiba .....	.002 023 030 038 051 067 076 091		
Magnin .....	.022	092 096 115			
magnasonic .....	.010	Totevision .....	.021 022 035		
Marantz .....	.019 020 024 025	Touch .....	.038		
Marta .....	.022 035	Unitech .....	.021		
Matsushita .....	.025	Vector Research .....	.019 023		
Media Center PC .....	.038	Vector .....	.002		
MEI .....	.025	Video Concepts .....	.019 023		
Memorex .....	.007 010 014 020 021 022	Videomagic .....	.035		
025 026 028 032 035 046 072 125					

## 3 Using TV Features

### Channel Banner

There are several indicators that may appear when you press the INFO button on the remote control. This display is called the Channel Banner. The following list describes the items on the Channel Banner screen (left to right and top to bottom).

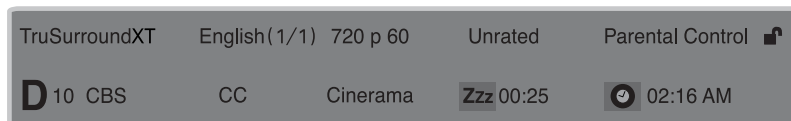

- TruSurroundXT** This is sound mode. Go to page 34 for more information.
- Stereo** This is sound type. If the current channel is analog, “Stereo” appears when broadcasting in stereo and “Mono” appears when the current channel is broadcasting in mono. If the current channel is digital and the sound mode is off, this space is blank.
- SAP** If the current channel is analog, this shows it is broadcasting SAP (Second Audio Program) information. If the current channel is digital, this area shows the language.
- 720 p 60** Broadcast signal resolution.
- Unrated** Rating information of the current program.
- Parental Control** The Parental Control state (locked or unlocked) of the current program.
- D 10 CBS** The “D” denotes a digital channel; an “A” denotes an analog channel. The channel, sub-channel (if available for digital channels) and program (only for digital channels) are displayed.
- CC** Closed Captioning is available on the current channel.
- Cinerama** Current screen format. If there are bars on the screen, you may be able to delete them by pressing the FORMAT button on the remote. Go to page 33 for more information on screen formats.
- ZZZ 00:25** Current time left on sleep timer, if the sleep timer is set.
- (⌚) 02:16 AM** Current time.

### Autotuning

*Note: This feature only works with other RCA components.*

The Autotuning feature automatically tunes the TV to the correct video input channel for the different components connected to your TV. When you set up Autotuning in the menu system, you don't have to remember to change your TV to the VID 1 input, for example, when you want to watch a tape on the VCR. To set up the Autotuning feature, follow these steps:

1. Press the MENU button (the *Main Menu* appears).
2. Highlight *Setup* and press OK on your remote control.
3. Highlight *Autotuning* and press OK.

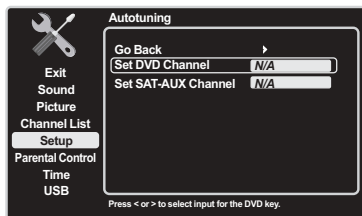

*Note: This feature only works with other RCA devices.*

4. Choose which component button you would like to set:

**Set DVD Channel** - Allows you to set the channel the TV tunes to when you press the DVD button.

**Set SAT-AUX Channel** - Allows you to set the channel the TV tunes to when you press the SAT/AUX button.

5. Press the left or right arrow to select the choice that matches the way you have the component connected to this TV.

You can select from the following inputs or channels:

**N/A** – Choose this option if you don't have a component connected to the TV, or if you don't want the TV to automatically tune to the correct channel/input when you're using this component.

**Channel 3 or 4** - Choose this option if the component is connected to the ANTENNA/CABLE jack on the back of the TV, and you want the TV to tune to channel 3 when you press the corresponding button on the remote. Reminder: Make sure the component's Channel 3/4 switch is set to channel 3.

**VID 1 or VID 2 (Video Input)** – Choose this option if the component is connected to the VIDEO INPUT 1 jack on the back of the TV or the VIDEO INPUT 2 jack on the side of the TV and you want the TV to tune to the VIDEO INPUT channel when you press the corresponding component button.

**CMPT (Component Video Input)** – Choose this option when a compatible component video source, such as an HDTV tuner, satellite receiver, or DVD player, is connected to the three component VIDEO INPUT jacks (Y Pb Pr) on the back of the TV and you want the TV to tune to the component VIDEO INPUT channel (CMPT) when you press the corresponding component button.

**PC** – Choose this option when the component is connected to the PC INPUT jack on the back of the TV and you want the TV to tune to the PC input when you press the corresponding component button.

**HDMI 1, HDMI 2, HDMI 3 or HDMI 4** – Choose this option when the component is connected to the HDMI 1/DVI or the HDMI 2/HDMI 3 INPUT on the back of the TV or HDMI 4 on the side of the TV, and you want the TV to tune to the HDMI INPUT channel when you press the corresponding component button.

## Parental Controls and V-Chip

The choices in the *US V-Chip* and *Canada V-Chip* menus involve software inside your TV, referred to as V-Chip, which allows you to block TV programs and movies. TV programs can be blocked by age-based ratings, such as *TV-MA* (See page 30). If available, TV programs can also be blocked by content, such as adult language (*L*) (See page 31). Movies can only be blocked by age-based ratings (See page 31). Once you block programs, you can unblock them by entering a password. By default, the software inside your TV is turned off or unlocked. For instructions to lock V-Chip, see page 30.

### V-Chip - US and Canada

V-Chip reads the program's age-based rating (*TV-MA*, *TV-14*, etc.) and content themes (Violence (*V*), Adult Language (*L*), etc.). If you have blocked the rating and/or content themes that the program contains, you receive a message that the channel is currently blocked. Change the channel or press OK to enter your password and temporarily deactivate the parental controls.

Broadcasters are not required to provide content themes, so programs received with no content themes are blocked only if you block their age-based rating. You can also block programs that have been given an Exempt rating, and programs that are considered unrated. See page 45 for the US and Canada ratings explanations.

**Note:** Parental control settings are not available for HDMI 1, HDMI 2, HDMI 3, HDMI 4, CMPT or PC INPUTS. These settings must be set in the connected component's parental controls.



**Note:** If you do not lock parental controls, none of the settings for V-Chip, Block Buttons or Block Channel will take effect.

**Note:** If you forget your password, turn off the TV, simultaneously press and hold VOL DOWN on the side panel and CANCEL on the remote for 5 seconds. The next time you enter the Parental Control Menu, enter a new password.

## Lock Parental Controls

- When the Parental Control Menu is accessed from the Main Menu and the parental controls are permanently unlocked, the following message is displayed: "Parental Controls are UNLOCKED. Rating limits and Channel Block will NOT require a password to view the picture. Use 'Lock Parental Control' to lock. Press any key to continue."
- Pressing any key displays the Parental Control Menu and highlights *Lock Parental Control*.
- To lock parental controls, enter a four-digit password using the digit keys. After a password is entered and parental controls are still unlocked, you must repeat entering the password. Once the password is confirmed, this message is displayed: "Parental Controls are LOCKED. Blocked programs will require a password to view the picture."

## Unlock Parental Controls

If parental controls are locked or temporarily unlocked, the Password Menu appears when the user tries to enter the Parental Control Menu. After the correct password is entered, the parental controls are unlocked.

## V-Chip Rating Screen

The following graphic details where items are located within the TV Ratings option with the US V-Chip menu.

### Rating Status Field

Lets you select whether the status of the age-based rating to the left limit is view or block.

### Rating Field

Lets you select from a list of age-based ratings you can block or view.

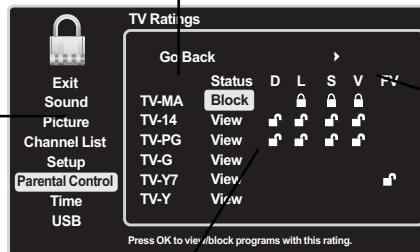

**Content Themes**  
Lists the content themes you can block or view.

### Content Status Fields

Lets you select which content themes to view for the selected rating, and whether the status of the content theme is currently unlocked (□) or locked (■).

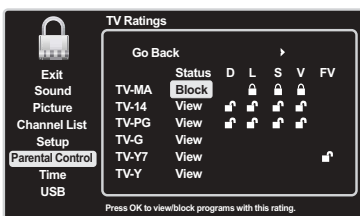

## US V-Chip TV Ratings

### Blocking Age-Based Ratings

You can automatically block all program ratings above a specified age-based rating level.

- Choose *Parental Control* from the Main Menu. If parental controls have previously been locked, you must enter your password.
- Highlight and select *US V-Chip*. Press OK or right arrow to enter the menu.
- Highlight and select *TV Ratings*.
- Press the up or down arrow to scroll to the rating corresponding with the lowest rating you wish to block.

5. Press the OK button to toggle between *View* and *Block*. The status for the rating and all higher ratings automatically changes to *Block*.
6. Use the MENU button repeatedly to return to the Parental Control Menu.
7. Select *Lock Parental Control* from the Parental Control Menu. For rating limits to take effect, enter the correct password twice.

To view age-based ratings after you've locked them, follow the same steps as above to unlock.

### Blocking Specific Content Themes

You can block programs based on their content. (Content is represented by the *D*, *L*, *S*, *V* and *FV* on your screen.) When you block a content theme for a particular rating, you automatically block that content theme for higher-rated programs as well. To block program content:

1. Choose *Parental Control* from the Main Menu. If parental controls have previously been locked, you must enter your password.
2. Highlight and select *US V-Chip*. Press OK or right arrow to enter the menu.
3. Highlight and select *TV Ratings*.
4. Determine the content themes you want to block.
5. Press the down arrow to scroll to the rating whose content theme you want to change.
6. Press the right arrow to highlight a particular content theme.
7. Press the OK button to change its status to block. (For example, if you block the language (L) corresponding with *TV-14*, the language for *TV-MA* is blocked as well.)

To view content themes after you've locked them, follow the same steps as above to unlock.

**Note:** If you unlock the language corresponding with *TV-14*, the language for *TV-MA* doesn't unlock. You have to unlock the content theme status for each rating separately.

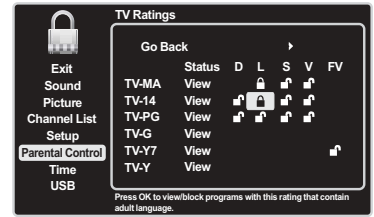

**Note:** Broadcasters are not required to provide content themes or age-based ratings. You must remember to lock Parental Controls for rating limits to take effect.

Hierarchy of Age-Based Ratings	
TV-MA	Mature Audience Only
TV-14	Parents Strongly Cautioned
TV-PG	Parents Guidance Suggested
TV-G	General Audience
TV-Y7	Directed to Children 7 Years and Older
TV-Y	All Children

Content Themes	
D	Sexually Explicit Dialogue
L	Adult Language
S	Sexual Situations
V	Violence
FV	Fantasy Violence

**Note:** If you forget your password, turn off the TV, simultaneously press and hold VOL DOWN on the side panel and CANCEL on the remote for 5 seconds. The next time you enter the Parental Control Menu, enter a new password.

### US V-Chip Movie Rating Limit

Set movie rating limits by blocking movies rated above a specified level. To access the Movie Rating Limit Menu, follow these steps:

1. Press MENU on the remote control (the Main Menu appears).
2. Select *Parental Control*. Press OK or the right arrow to enter menu.
3. Highlight and select *US V-Chip*.
4. Highlight and select *Movie Ratings*.
5. Press the down arrow to scroll to the rating you want to change.
6. Press the OK button to change its status to block (all ratings above the one you selected change to block).
7. Press the MENU button repeatedly to exit the Parental Control Menu.

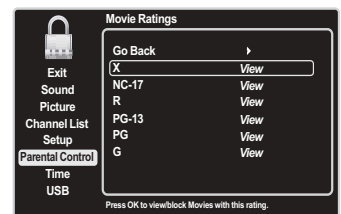

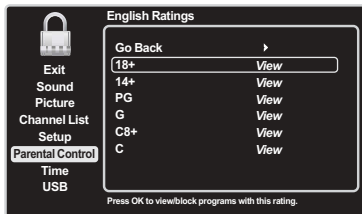

**Note:** These ratings are available only if the broadcaster is sending them.

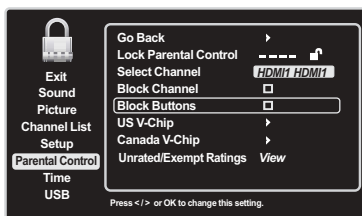
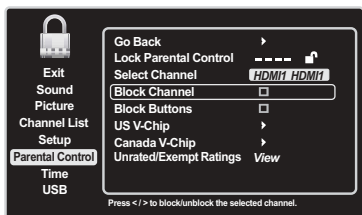

**Note:** You must remember to lock Parental Controls for rating limits to take effect.

**Note:** These ratings are available only if the broadcaster is sending them.

## Blocking Canada V-Chip Ratings

If you receive Canadian programs, you can block Canadian English and French V-Chip by ratings only. When you block a particular rating, you automatically block the higher-rated programs as well. To block Canadian English and French program ratings, follow these steps:

1. Press MENU on the remote control (the Main Menu appears).
2. Select *Parental Control*.
3. Select *Canada V-Chip*.
4. Highlight *English Ratings* or *French Ratings* and press OK.
5. Press the down arrow to scroll to the rating you want to change.
6. Press the OK button to change its status to block (all ratings above the one you selected change to block).
7. Press the MENU button repeatedly to exit the Parental Control Menu.

## Block Channel

Turn this option on to block the channel you choose in the *Select Channel* option. Use the digit keys to enter the channel you want to block. Then press the down arrow to select *Block Channel*. Press the OK or right arrow button to place a checkmark in the *Block Channel* box to block the channel. When you tune to that channel, you'll need to enter a password to view the channel if parental control is locked.

## Block Buttons

Select this option to block (disable) or unblock (enable) the TV's side panel buttons so that they can't be used. The remote still tunes to any channel. If you're using this to keep children from changing channels, remove access to any remote that is capable of operating the television while you have the side panel blocked. Don't forget to lock parental controls after you change the status. If you don't, the *Block Buttons* action will not take effect.

## Blocking Unrated/Exempt Programs

The *Unrated/Exempt Ratings* option lets you decide if programs that the V-Chip recognizes as unrated or exempt can be viewed. Unrated TV programs may include news, sports, political, religious, local and weather programs, emergency bulletins, public announcements, and programs without ratings. The Exempt option applies to both US and Canadian unrated programs and Canadian programs rated E.

Press the down arrow to highlight *Unrated/Exempt Ratings*. Then press the OK button or the right arrow to toggle between *View* and *Block*.

**View** All unrated programs are available.

**Block** All unrated programs are not available.

## Future Rating Region

You may notice an option in your Parental Control Menu that wasn't there before. This is because broadcasters have the capability to add a new rating system for TV programs. These ratings let you define additional parameters for parental controls. This option and its name are dependent on the content acquired from the broadcaster.



# Additional Features

There are additional features available unrelated to parental controls. These features can be found in other menus.

## Fetch Feature

This is a unique “Fetch” remote control finder function on the HDTV. Pressing the MENU and VOLUME UP buttons on the side panel of the TV set at the same time causes the remote control to bark from its current location.

## Screen Formats

Screen format refers to the way the picture is displayed on your TV. Press the FORMAT button on your remote to see if a different format is available for the video you are viewing. The format changes as you press the FORMAT button and the format type is displayed at the top left of the screen.

Analog video is sent in a 4/3 format, which your TV displays in a 16/9 format. Most digital video is sent in a 16/9 format which fills your screen, but it sometimes is sent in 4/3, which does not fill your screen. It depends on how the station or component connected to your TV is formatting the video. If there are bars on the screen, press the FORMAT button to try a different format that may eliminate the bars. Some bars can't be removed because of the way the format is sent by the broadcaster.

Examples of the different formats appear below available for SD video :

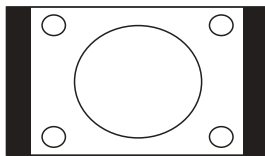

**Normal**

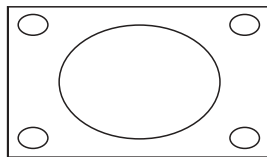

**Full**

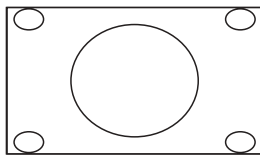

**Cinerama**

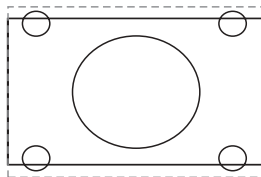

**Zoom**

**Note:** For HD video, press **FORMAT** to choose among **Full**, **Expand**, **Cinerama** and **Zoom**; for VGA signal, you can choose format among **Normal** or **Full** ; **NO Overscan** for **HDMI/CMPT** signal.

# 4 Using the TV Menu

## Using the Menu System

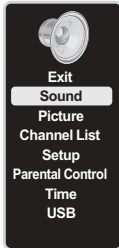

This section explores the menus of your TV. Each menu is outlined and detailed to help you get the most from your TV. The Parental Control Menu is discussed in Chapter 3. To access the menu system, follow these steps:

1. Press the MENU button.
2. Use the up or down arrow to highlight an option and press OK to display it. The name of the menu is displayed at the top of the menu screen.
3. Press the up or down arrow to move to a different option within the menu. If necessary, press the OK button to display the choices of the option you've highlighted. If available, use the text at the bottom of each screen for help.
4. To return to the Main Menu, press the MENU button repeatedly until it is displayed.

Descriptions of each menu are discussed in the order they appear.

There are two ways to exit a menu:

- Press the CANCEL button. The menus are cleared from the screen and you return to TV viewing.
- Press the MENU button repeatedly until the menus disappear.

## Sound Menu

The Sound Menu lets you adjust audio output. To access the Sound Menu, press MENU on the remote, and then select Sound from the Main Menu. The following audio items can be adjusted:

**Equalizer** The five-band graphic equalizer allows you to adjust the audio frequency settings. You can select one of the five-band Equalizer Presets or create your own personal preset.

**Sound Preset** Allows you to choose a specific Sound Preset. Press the right arrow to cycle through the options: Standard, Movie, Voice, Music and Personal.

**Frequency Range** Displays the different graphic equalizer bands set for each Sound Preset option. Choose a band and make adjustments. When you make adjustments, the Sound Preset option automatically changes to Personal. Press the left or right arrow to select the frequency (100Hz, 300Hz, 1KHz, 3KHz, 10KHz) you want to adjust. Use the up or down arrow to adjust the level. When you are done adjusting the levels, press the MENU button to exit.

To view the frequency of another Sound Preset option, press the left or right arrow until no band is selected and Frequency Range is highlighted. Press the up arrow to highlight Sound Preset.

**Sound Type** Controls the manner in which the sound comes through the speakers. The available options vary according to the input selected.

**Mono (available for regular TV viewing only)** – This option plays the sound in mono only. Use this setting when receiving broadcasts with weak stereo signals.

**Stereo** This option splits the incoming stereo audio signal into left and right channels. Most TV programs and recorded materials have stereo audio. The word “Stereo” appears in the Channel Banner when you tune to a program that is broadcast in stereo.

**Sound Mode** Provides special processing through the speakers (depending on the setting chosen as the Sound Type). The available Sound Modes are:

**Off** No special sound processing.

**TurSurroundXT**

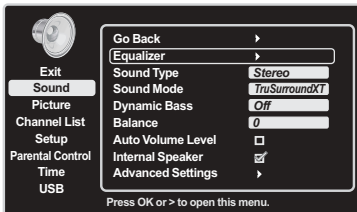

**Note:** All digital channels are broadcast in stereo.

**Dynamic Bass** Improves bass output. Displays a choice list of available settings: *Off* and *On*.

**Balance** Press the left or right arrow to adjust the level of audio sent to the left and right speakers.

**Auto Volume Level** Reduces the annoying blasts in volume during commercial breaks and also amplifies softer sounds in program material. Eliminates the need to constantly adjust the volume.

**Internal Speakers** Turns the internal speakers off and on. If you have a component connected to the AUDIO OUTPUT jacks on the back of the TV and you want to control the sound by the component instead, uncheck the box.

### Advanced Settings

**Second Audio Program (SAP)** – This option plays the program’s audio in a second language, if available. The letters “SAP” appear in the Channel Banner when you tune to a program that is broadcast with SAP information. SAP audio is broadcast in mono only. SAP is also used to broadcast a program’s audio with descriptions of the video for the visually impaired.

**Default Audio Language** – Use this selection to choose the language you prefer for dialog on digital channels. If your preferred language is being broadcast with a program, the TV plays it. If not, the TV plays the default option for the program (usually English in the US). The default digital channel audio language options are *English, Spanish, French, German and Italian*.

**Current Audio Track (not available for analog channels)** – Press the right arrow to choose from the list of languages available for the program you’re watching. The language chosen becomes your preferred language for all digital channels until you turn the TV off. If the language chosen is not being broadcast with a program, the TV plays the default language for the program (usually English in the US).

*Note: The Current Audio Track menu item grays out when the current channel selected is analog.*

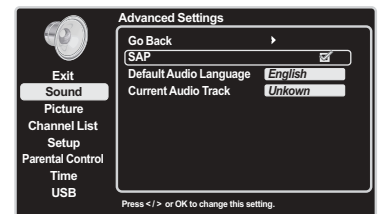

## Picture Menu

The Picture Menu contains menus and controls to configure the way the picture appears. The Picture Menu options apply to the video for the main TV and VIDEO INPUT selections. All picture options can be applied to each input - *VID 1, VID 2, CMPT, HDMI 1, HDMI 2, HDMI 3, HDMI 4 and PC*.

**Picture Preset - (not available on PC)** Allows you to select one of the preset picture settings: *Vibrant, Sports, Personal, Natural, or Cinematic*. Choose the setting that is best for your viewing environment.

**Brightness** - Use the left or right arrow to adjust the brightness of the picture.

**Contrast** - Use the left or right arrow to adjust the difference between the light and dark areas of the picture.

**Color** - Use the right or left arrow to adjust the richness of the color.

**Sharpness (not available on PC)** - Use the right or left arrow to adjust the crispness of the edges in the picture.

**Tint (not available on PC)** - This option adjusts the balance between the red and green levels.

**Color Warmth** - This option allows you to select one of three automatic color adjustments: *Cool* for a bluer palette of picture colors; *Normal*; or *Warm* for a redder palette of color. The warm setting corresponds to the NTSC standard of 6500 K. Use the left or right arrow to make adjustments.

**Phase (only available on PC)** - Adjusts the picture if there is flicker of screen letters, color misalignment or blurring.

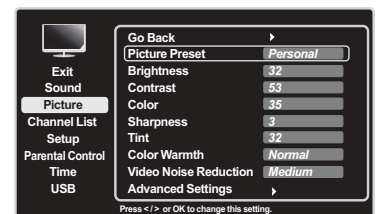

**Video Noise Reduction (not available on PC)** - This setting reduces picture “static” or any type of interference. This feature is especially useful for providing a clearer picture in weak analog signal conditions. Press the right arrow to choose between these options:

*Off* for no noise reduction.

*Low* for a softer, smoother picture that retains picture sharpness and detail.

*Medium* for a slightly softer picture than the *Low* setting.

*High* for an even softer, smoother picture than the other settings (the picture detail is somewhat decreased).

### Advanced Setting

**Motion Enhancer** Provides smoother picture movement and reduces picture blur.

*On*: Provides more sharpness on moving picture

*Off*: Turns off the Motion Enhancer

**Cinema Drive** Provides improved picture movement when playing DVD or VCR images taken on film, reduces picture judder.

**Game Mode** The Game Video mode does not apply motion processing to the input video. This mode is also known as the low latency mode, because there is no video delay caused by motion processing. Provides the optimum screen for viewing images when input from video games equipment and PCs.

*On*: For video games equipment and PCs.

*Off*: For video or film-based contents.

**Color Enhancer** Make color more vivid.

*High*: Higher level

*Low*: Standard level, recommended mode

*Off*: Turns off the Color Enhancer

**Motion Profile** Choose high level to keep the picture sharp at all times; however, very small details may fade a little at high speed. Choose low or medium levels to reduce the motion compensation.

*High*: For high speed movement and higher motion compensation

*Medium*: For normal movement and less motion compensation

*Low*: Less motion compensation

**Demo Mode** Vertical split demo features Motion Enhancer/Cinema Drive and Color Enhance. The right side features the enhanced modes.

**Reset** Reset all the advanced settings to the default values. The default values are: Motion Enhancer = On; Cinema Drive = On; Game Mode = Off; Color Enhancer = Low; Motion Profile = High; Demo Mode = Off.

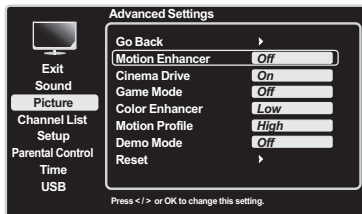

# Channel List Menu

The Channel List Menu allows you to view all the channels available in your channel list. Press the up or down arrow to highlight a channel. Press the OK button to tune to the channel.

# Setup Menu

The Setup Menu allows you to configure the TV with your preferences. Press MENU on the remote control; then highlight and select *Setup* from the Main Menu.

## Channel Setup

**Signal Type** Choose the type of signal you have connected to the ANTENNA/CABLE INPUT.

**Channel Search** Searches for channels currently being received. See page 16 for more information.

## List and Labels

Edit the channels in the list or choose labels for each video input channel.

**Channel Number** Use the number buttons on your remote to enter the channel number, or press the left and right arrows to select the VIDEO INPUT channel among VID 1, VID 2, CMPT, PC, HDMI 1, HDMI 2, HDMI 3 and HDMI 4.

**In Channel List (only available for TV channels)** If you've entered a channel you want to add to the channel list, highlight *In Channel List* and press the right arrow to place a check in the checkbox. If you've entered a channel you want to delete from the channel list, press the right arrow to uncheck the box. When an AV INPUT is displayed in the Channel Number field, the line "In Channel List" is grayed out.

**Channel Label (not available for TV channels)** Allows you to select a label for the video input channel selected in *Channel Number*. The label is displayed on the screen when you tune to this input channel. When a channel number is displayed in the *Channel Number* field, this is grayed-out.

**Autotuning** See Chapter 3 for details about the Autotuning feature.

## Closed Caption

Many programs are encoded with closed captioning information, which lets you display the audio portion of a program as text on the TV screen.

**Note:** Closed caption settings are not available for HDMI 1, HDMI 2, HDMI 3, HDMI 4, or CMPT INPUTS. These settings must be set in the connected component's menu. Closed captioning is not available on all channels at all times. Only specific programs are encoded with closed captioning information. When a program is closed captioned, CC is displayed in the Channel Banner. See Chapter 3 for more information about the Channel Banner.

The Closed Caption options are:

**CC Setting** Allows you to choose the way closed captioning information appears on the screen.

**OFF** No captioning information displayed.

**On always** Captioning information shown always, when available.

**On when muted** Displays captioning information, when available, whenever the TV's sound is muted by pressing the MUTE button. The captioning information is not displayed when the sound is not muted.

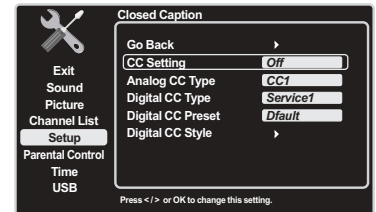
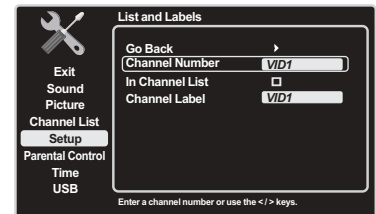
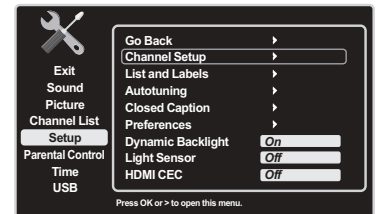

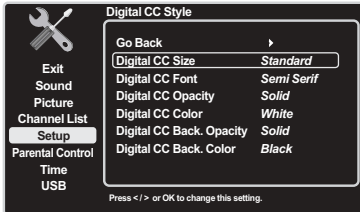

**Analog CC Type** If available, this option allows you to select the captioning mode used for displaying captioning information. If you are unsure of the differences among the modes, you may prefer to leave the closed captioning mode set to CC1, which displays complete text of the program in the primary language in your area.

**Digital CC Type** If available, this allows you to select a closed caption service mode (1-6) for digital channels.

**Digital CC Preset** If available, this allows you to select between Default and Custom options. The custom option changes according to what you set for the options below.

**Digital CC Style** If available, this allows you to customize the following display options:

**Digital CC Size** Allows you to set the size of the digital closed caption text: *Standard*, *Large* or *Small*.

**Digital CC Font** Allows you to select a character design for the digital closed caption text. A font is a complete assortment of letters, numbers, punctuation marks, etc, in a given design. Choose from a variety of fonts: *Semi Serif*, *Screen Serif*, etc.

**Digital CC Opacity** Allows you to set the appearance of the digital closed caption text: *Solid*, *Transparent*, *Translucent* or *Flashing*.

**Digital CC Color** Allows you to choose the color if the digital closed caption text: *White*, *Red*, *Green*, *Blue*, *Yellow*, *Magenta*, *Cyan* or *Black*.

**Digital CC Back. Opacity** Lets you set the appearance of the space behind the digital closed-caption text: *Solid*, *Transparent*, *Translucent*, or *Flashing*.

**Digital CC Back. Color** Lets you choose the color of the area of the screen behind the digital closed-caption text: *White*, *Red*, *Green*, *Blue*, *Yellow*, *Magenta*, *Cyan* or *Black*.

**Note:** These captioning style options only have an effect on true digital closed captions. Not all captioning on digital channels is digital captioning—it depends on what the broadcaster is sending. If the closed captioning for a program is not digital, the Digital CC style settings will not have an effect.

## Preferences

**Channel Number Display** Turn this feature on if you want the channel number always visible.

**Language** Allows you to select your preferred language for the menus: *English*, *Espanol*, or *Francais*.

**Power Save Mode** If no signal is detected from the Input/RF INPUT for five minutes, the TV set goes to Standby Mode.

**Dynamic Backlight** Option: On/Off. If you choose On, the TV continually monitors the video content being displayed and adjusts the backlight to achieve optimum contrast levels.

**Light Sensor** If you choose On, this feature is activated.

When activated, this feature monitors the ambient light conditions in the room and adjusts the TV's backlight for optimum viewing. It also serves as an energy-saving feature by lowering the backlight power level when appropriate (typically in darker room conditions).

## HDMI CEC (Consumer Electronics Control)

If you choose On, the HDMI CEC function is enabled. This feature provides expanded capabilities when your TV is connected to an HDMI CEC-compliant component using a certified HDMI 1.3 cable. Here is an example using an HDMI CEC-compliant DVD player connected to the TV.

- Upon activating the feature, the TV searches for HDMI CEC-compliant components that are connected. In this example, a connected DVD player is found.
- When both the TV and DVD player are on and a disc is inserted into the DVD player, the TV automatically switches to the associated input and initiates play.

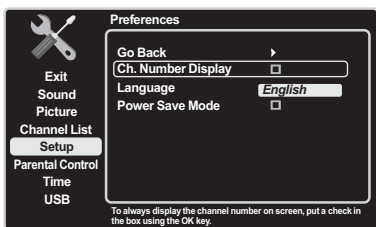

**Note:** The connected HDMI device must be HDMI CEC-compliant for this feature to work. Some HDMI may utilize specific protocols that are not fully CEC compliant and may prevent the feature from working properly.

- When the TV is on and the DVD player is turned on with the disc already loaded, the TV automatically switches to the associated input and initiates play.
- If you connect another HDMI CEC component and/or change the HDMI input used for an existing HDMI CEC component, you should turn the HDMI CEC function off and then turn it on again in order for the TV to complete a new search for the connected devices.

## Parental Control Menu

The Parental Control Menu is explained in Chapter 3. Go to Page 29 for more information.

## Time Menu

**Sleep Timer** Press the left or right arrow to set the TV to turn off after a given amount of time.

**Auto Time Channel** Choose a station to have the TV set the time for you. Wait approximately one minute after you program this for the time to be set.

**Time Zone** Select the current local time: *Atlantic, Newfoundland, Central, Mountain, Pacific, Alaska, Hawaii and Eastern.*

**Daylight Saving (DST)** Choose between *Off* and *Automatic* Modes.

**Enter Time** If you did not set the time reference channel, enter the current time manually. Use the number keys or the right or left arrow to set hours and minutes. Use the OK button to choose between AM/PM.

**Wake up Timer** Use the left or right arrow to choose between *Off, Once* or *Daily* to set the TV to turn itself on just one time or at the same time each day.

**Note:** *The Wake Up Timer is available only when the time has been set.*

**Wake up Time** Set the time you want the TV to turn itself on. Use the number keys or the right or left arrow to set hours and minutes. Use the OK button to choose between AM/PM.

**Turn off Timer** Use the left or right arrow to choose between *Off, Once,* or *Daily* to set the TV to turn itself off just one time or at the same time daily.

**Turn off time** Set the time you want the TV to turn itself off. Use the number keys or the right or left arrow to set hours and minutes. Use the OK button to choose between AM/PM.

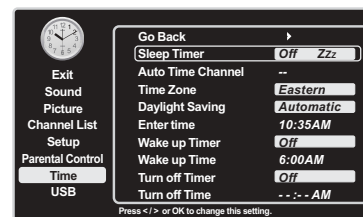

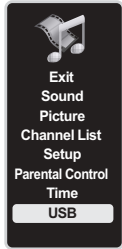

## USB Menu

The USB feature allows you to play audio files (format supported: MP3) or display pictures (format supported: JPEG). Select USB in the Main Menu; then select USB Device.

### USB Device

**Picture** If you have pictures on the USB component connected to your TV, this menu allows you to view the pictures individually by pressing the up or down arrow to highlight the pictures (the picture is displayed on the right).

**Note:** To play a slideshow of all the pictures available on your component, highlight a folder and press PLAY.

**Music** If you have MP3 audio files on the USB component connected to the TV, this menu allows you to play files individually by pressing the up or down arrow to highlight the song.

**Note:** To play all the music files available on your component, highlight a folder and press PLAY.

## USB Connection

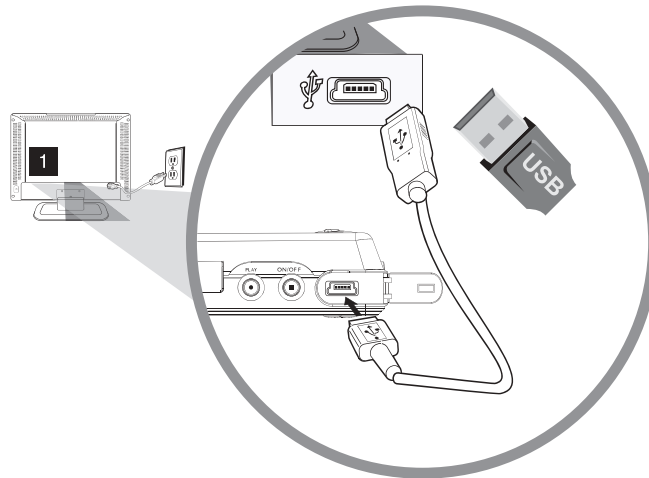

**Note:** When using a USB connection, a picture slideshow can only be set for a folder, not an individual picture.

### Connecting a Component with USB or a USB Flash Drive

This connection allows you to insert a USB flash drive directly or connect to a compatible mass storage device with USB, such as a digital camera, multi-format card reader, or MP3 player.

If you have a USB flash drive, plug in the drive directly.

If you have a component with USB:

- Connect one end of the USB cable to the USB component and the other end to the USB jack on the side of the TV.
- To access and adjust the options of the USB component, press MENU. Choose USB from the Main Menu.



## 5 Other Information

---

### Frequently Asked Questions (FAQs)

#### **What's the quickest way to view High Definition (HD) video?**

Connect an off-air antenna to the ANTENNA/CABLE Input to view free local digital channels. You may need to purchase an antenna. (See page 9 for more information).

Visit [www.antennaweb.org](http://www.antennaweb.org) for assistance in deciding what type of antenna to use to receive the local digital channels available to you. By entering your location, this mapping program tells you which local analog and digital stations are available using a certain antenna.

#### **Are there other ways to view High Definition (HD) video?**

Besides using an off-air antenna as mentioned above, you can also use a set-top box to receive digital video. Contact your cable company or satellite provider to purchase digital programming and have them connect the box to ensure you are viewing channels the best way.

#### **How do I tell an analog channel from a digital channel?**

Press the INFO button to display the Channel Banner. Look at the bottom left corner of the screen. An "A" is displayed for an analog channel. A "D" is displayed for a digital channel.

#### **Why are there bars on my screen, and can I get rid of them?**

Most digital video is sent in a 16/9 format which fills your screen, but is sometimes sent in 4/3 which does not fill your screen. It depends on how the station or device connected to your TV is formatting the video. If there are bars on the screen, press the FORMAT button to try a different format that may eliminate the bars. Some bars can't be removed because of the way the format is sent by the broadcaster. The format changes as you press the FORMAT button and the format type is displayed at the top left of the screen. For more information on screen formats, go to page 33.

#### **Why does channel search find a lot of channels, but when I try to tune to them, there's nothing there?**

Some channels enabled by the cable company don't carry programming, such as video ondemand. When channels are unavailable, your TV screen is blank or appears like snow. You probably want to remove these channels from your channel list. Remove these in the Channel List Menu. Go to page 37 for more information.

#### **Why does the first channel search take a long time?**

If you have both analog and digital channels, the TV is looking for all available channels in the channel list. If you do have digital channels, the TV is also searching for scrambled channels, non-scrambled channels, and each sub-channel of that digital channel.

# Troubleshooting

Most problems you encounter with your TV can be corrected by consulting the following troubleshooting list.

## TV Problems

### The TV won't turn on.

- Make sure the TV is plugged in.
- Check the wall receptacle (or extension cord) to make sure it is "live" by plugging in another device.
- The side panel controls may be locked (disabled). Use the remote control to unlock the side panel controls. Select the *Block Buttons* feature on the Parental Control menu and press OK to uncheck the box.

### There is no picture and no sound but the TV is on.

- You may be tuned to an input with no component connected to it. If you're trying to view a connected component, press INPUT until the picture from that component appears.
- The *Signal Type* option may be set incorrectly. Go to page 16 for detailed instructions.
- The channel may be blank. Try changing channels.
- If you're watching your VCR and it's connected with coaxial cable to the ANTENNA/CABLE jack, tune the TV to channel 3 or 4 (whichever channel is selected on the 3/4 switch on the back of your VCR). Also make sure the TV/VCR button on the VCR is in the correct mode (press the TV/VCR button on your VCR).

### The sound is fine, but the picture is poor quality.

- If you're getting a black and white picture from a component you've connected to your TV, you might have your video cables connected to the wrong jacks. A yellow video cable connects to the yellow VIDEO INPUT jack on the side or back of your TV; three video cables or bundled component video cables (red, blue, and green) connect to the corresponding COMPONENT INPUT jacks on the back of your TV.
- Check the antenna connections. Make sure all of the cables are firmly connected to the jacks.
- Try adjusting the sharpness function to improve weak signals. Go to page 35 for more instructions.

### There is no sound, but the picture is fine.

- The sound might be muted. Try pressing the volume up button to restore sound.
- If using DVI, S-Video, or Y, PB, PR, remember to also connect the device's left and right audio output jacks to the TV's L and R AUDIO INPUT jacks.
- The sound settings may not be set correctly. Go to page 34 for more information.
- The internal speakers might be turned off. Go to page 35 for more information.
- If your audio source has only one jack or is a (mono) audio source, make sure you have plugged the connection into the L AUDIO INPUT jack on the TV.

### **The screen is blank.**

- Check your connections. If you used red, white and yellow cables to connect, make sure they're connected to the red, white and yellow AUDIO/VIDEO INPUT jacks on the side or back of the TV.
- If you're trying to watch something that's playing on a component connected to the TV (like a DVD), press INPUT until you get to the correct video input channel.
- Make sure the component connected to the TV is turned on.
- Try another channel.

### **The buttons on the side panel don't work.**

- The side panel controls may be locked (disabled). Use the remote control to unlock the side panel controls by selecting the *Block Buttons* feature in the Parental Control Menu and press OK to uncheck the box.
- Unplug the TV for 10 minutes and then plug it back in. Turn the TV on and try again.

### **The TV turns off unexpectedly.**

- The Sleep Timer may have been activated. Go to page 39 for instructions.
- The electronic protection circuit may have been activated because of a power surge. Wait 30 seconds and then turn the TV on again. If this happens frequently, the voltage in your house may be abnormally high or low.
- Unplug. Wait 10 minutes. Plug in again.

### **The TV turns on unexpectedly.**

- Wake up timer might have been activated. Go to page 39 for instructions.

### **You can't select a certain channel.**

- The channel may be blocked or not approved in the Parental Control Menu.
- If using a VCR, check to make sure the TV/VCR button on the VCR is in the correct mode (press the TV/VCR button on your VCR).
- Press the TV button and then try to change channels.

### **The stereo reception is noisy.**

- It may be a weak station. Use the Sound Menu and Sound Type to choose *mono*.

### **A black box appears on the screen.**

- Closed captioning might be on. Check *Closed Caption* in the Setup menu. Go to page 37 for more instructions.

### **You are having problems with the HDMI Connection.**

- Make sure the HDMI or DVI component is turned on and the cables are firmly connected. If problems still occur, turn off your component and reconnect it. Reset the power by unplugging the power cord and plugging it back in.
- If you are tuned to the HDMI 1, HDMI 2, HDMI 3 or HDMI 4 INPUT and you're receiving an *Unusable Signal* message onscreen, press the INFO button on the remote. If *Acquiring Channel* appears in the Channel Banner, the HDMI or DVI device isn't responding. Contact the manufacturer of the HDMI or DVI device for further assistance.
- If you tune to the HDMI 1, HDMI 2, HDMI 3 or HDMI 4 INPUT and you see snow, the video goes in and out, or the video takes a long time to appear, your HDMI or DVI component is having trouble sending video information to the TV. Reconnect your device. Reset the power by unplugging the power cord and plugging it back in. If problems persist, try connecting the Y Pb Pr jacks if they are available or contact the manufacturer of the HDMI or DVI component for further assistance.
- If you have black bars on each side of your picture, the component you connected might have a switch or a menu option allowing you to change the picture quality output that will fix this. Choose either *720p* or *1080i*.

### **The Remote control doesn't work.**

- Something might be between the remote and the remote light sensor on the front of the TV. Make sure there is a clear path.
- The remote may not be aimed directly at the TV.
- The batteries in the remote may be weak, dead, or installed incorrectly. Put new batteries in the remote. (Note: If you remove the batteries, you may have to reprogram the remote to operate other component.)

### **You are experiencing problems with V-Chip/Parental Controls.**

- If the rating limits don't work, you must lock the settings. Go to the Main Menu (press MENU on your remote), select *Parental Control*, select *Lock Parental Control*.

### **I don't remember my password and I want to unlock the TV.**

- If you forget your password, turn the TV off. Simultaneously press and hold VOL DOWN on the side panel and CANCEL on the remote for 5 seconds. Next time you enter the Parental Control Menu, enter a new password.

### **What Else Can I Do?**

If you've been through the Troubleshooting section and nothing has fixed your problem, try rebooting your TV. Note that after a reboot, you may need to run your TV through the setup process again. To do a reboot, unplug the power cord from the wall outlet or power strip. Keep your TV unplugged for about 5 minutes. Then plug in the TV and turn it on. See if the problem is fixed. If the problem remains, then please click on the Customer Support Menu at [www.rca.com/television](http://www.rca.com/television) for updated FAQs or contact RCA Customer Support at the support number provided in your Warranty under *How To Get Service*.

# V-Chip Rating Explanations

## US V-Chip Rating System

**TV-MA (Mature Audience Only)** Specifically designed to be viewed by adults and may be unsuitable for children under 17. It contains one or more of the following content themes: crude indecent language (L), explicit sexual activity (S), or graphic violence (V).

**TV-14 (Parents Strongly Cautioned)** Contains some material that many parents would find unsuitable for children under 14. Parents are strongly urged to exercise greater care in monitoring this program and are cautioned against letting children under the age of 14 watch unattended. This program contains one or more of the following content themes: intensely suggestive dialogue (D), strong coarse language (L), intense sexual situations (S), or intense violence (V).

**TV-PG (Parental Guidance Suggested)** Contains material that parents may find unsuitable for younger children. Many parents may want to watch it with their younger children. The program contains one or more of the following content themes: some suggestive dialogue (D), infrequent coarse language (L), some sexual situations (S), or moderate violence (V).

**TV-G (Parental Audience)** Most parents would find this program suitable for all ages. It contains little or no sexual dialogue (D) or situations (S), no strong language (L), and little or no violence (V).

**TV-Y7 (Directed to Children 7 years and older)** Designed for children ages 7 and above. It may be more appropriate for children who have acquired the developmental skills needed to distinguish between make believe and reality. Themes and elements in this program may include mild fantasy violence (FV) or comedic violence, or may frighten children under the age of 7.

**TV-Y (All Children)** Themes and elements in this program are designed for a young audience, including children ages 2-6. It is not expected to frighten younger children.

## Canadian English V-Chip Rating System

**18+ (Adult)** Programming intended for adults 18 and older. It may contain elements of violence, language, and sexual content which could make it unsuitable for viewers under 18. Violence Guidelines: May contain violence integral to the development of the plot, character or theme, intended for adult audiences. Other Content Guidelines: May contain graphic language and explicit portrayals of nudity and/or sex.

**14+ (Viewer 14 and over)** Programming contains themes or content which may not be suitable for viewers under the age of 14. Parents are strongly cautioned to exercise discretion in permitting viewing by pre-teens and early teens. Violence Guidelines: May contain intense scenes of violence. Could deal with mature themes and societal issues in a realistic fashion. Other Content Guidelines: May contain scenes of nudity and/or sexual activity. There could be frequent use of profanity.

**PG (Parental Guidance)** Programming intended for a general audience but which may not be suitable for younger children (under the age of 8). Parents may consider some content inappropriate for unsupervised viewing by children aged 8-13. Violence Guidelines: Depictions of conflict and/or aggression will be limited and moderate; may include physical, fantasy, or supernatural violence. Other Content Guidelines: May contain infrequent mild profanity, or mildly suggestive language. Could also contain brief scenes of nudity.

**G (General Audience)** Programming considered acceptable for all ages groups. While not designed specifically for children, it is understood younger viewers may be part of the audience. Violence Guidelines: Will contain very little violence, either physical or verbal or emotional. Will be sensitive to themes which could frighten a younger child, will not depict realistic scenes of violence which minimize or gloss over the effects of violent acts. Other Content Guidelines: There may be some inoffensive slang, no profanity and no nudity.

**C8+ (Children 8 and older)** Programming generally considered acceptable for children 8 years and over to watch on their own. Violence Guidelines: Violence will not be portrayed as the preferred, acceptable, or only way to resolve conflict or encourage children to imitate dangerous acts which they may see on television. Any realistic depictions of violence will be infrequent, discreet, of low intensity and will show the consequences of the acts. Other Content Guidelines: There will be no profanity, nudity or sexual content.

**C (Children)** Programming intended for children under age 8. Violence Guidelines: Careful attention is paid to themes which could threaten children's sense of security and well being. There will be no realistic scenes of violence. Depictions of aggressive behavior will be infrequent and limited to portrayals that are clearly imaginary, comedic or unrealistic in nature. Other Content Guidelines: There will be no offensive language, nudity or sexual content.

### **Canadian French V-Chip Rating System**

**18+ (Adult)** Programming is for adults only. This program contains sustained violence or extremely violent scenes.

**16+ (Viewer 16 and over)** Programming is not suitable for those under age 16. This program contains frequent scenes of violence or intensely violent scenes.

**13+ (Viewer 13 and over)** Programming may not be suitable for children under the age of 13. This program either contains several violent scenes or one or more scenes that are violent enough to affect them. Viewing in the company of an adult is therefore strongly recommended for children under the age of 13.

**8+ (Viewer 8 and over)** Not recommended for young children. This program is suitable for most audiences, but it contains mild or occasional violence that could upset young children. Viewing in the company of an adult is therefore recommended for young children (under the age of 8) who do not distinguish between reality and imagination.

**G (General Audience)** This program is suitable for audiences of all ages. It contains no violence, or any violence that it does contain is either minimal or is presented in a humorous manner, as a caricature, or in an unrealistic way.

# TTE Technology, Inc. (“TTE”) Limited Warranty

## All LCD Models

**EXCEPT TO THE EXTENT PROHIBITED BY APPLICABLE LAW, THIS WARRANTY DOES NOT COVER, AND AS DESCRIBED BELOW TTE EXPRESSLY DISCLAIMS, ALL ACTUAL AND IMPLIED WARRANTIES WITH RESPECT TO ANY PRODUCT USED FOR INSTITUTIONAL OR OTHER COMMERCIAL PURPOSES (INCLUDING BUT NOT LIMITED TO RENTAL PURPOSES).**

**What your warranty covers:** Defects in materials or workmanship to the original owner

### New LCD Televisions - Screen Sizes 32” and smaller:

#### For how long after your purchase:

- Ninety (90) days from date of purchase for labor charges. After ninety (90) days, labor charges will be at owner expense.
- One (1) year from date of purchase for parts.

#### What we will do:

- At TTE’s discretion, pay an Authorized RCA Service Center for both labor charges and parts to repair your television, or replace your television with a new or refurbished/remanufactured unit. See “How to get service”

### New LCD Televisions - screen sizes 33” and larger:

#### For how long after your purchase:

- One (1) year from the date of purchase for labor charges.
- One (1) year from the date of purchase for parts.

#### What we will do:

- At TTE’s discretion, pay an Authorized RCA Service Center for labor charges and parts to repair your television, or replace your television with a new or refurbished/remanufactured unit. See “How to get service”

### All Remanufactured/Refurbished LCD Televisions:

#### For how long after your purchase:

- Ninety (90) days from date of purchase for labor charges.
- Ninety (90) days from date of purchase for parts.

#### What we will do:

- At TTE’s discretion, pay an Authorized RCA Service Center for both labor charges and parts to repair your television, or replace your television with a refurbished/remanufactured unit. See “How to get service”

### How to get service:

- Call **1-800-951-9582**. Please have your unit’s date of purchase and model/serial number ready. The model/serial number information can be found on the back of your unit.
- A representative will troubleshoot your problem over the phone.
- If it is determined that your unit requires service, the service location will be at the sole discretion of TTE based upon the TTE Limited Warranty statement.
- At the sole discretion of TTE, television screen sizes 32” and smaller are either consumer carry-in to an Authorized RCA Service Center or directly exchanged for a new or refurbished/remanufactured unit.
- At the sole discretion of TTE, television screen sizes 33” and larger are either consumer carry-in to an Authorized RCA Service Center or directly exchanged for a new or refurbished/remanufacture unit.
- Proof of purchase in the form of a bill of sale or receipted invoice from an Authorized Dealer which is evidence that the product is within the warranty period must be presented to obtain warranty service.

### **What your warranty does not cover:**

- Customer instruction. (Your Owner's Manual describes how to install, adjust, and operate your unit. Any additional information should be obtained from your dealer.)
- Installation and related adjustments.
- Damage resulting from non-approved installation methods.
- Signal reception problems not caused by your unit.
- Damage from misuse or neglect.
- Batteries.
- A television that has been modified or incorporated into other products or is used for institutional or other commercial purposes (including but not limited to rental purposes).
- A unit purchased or serviced outside the USA.
- Acts of nature, such as but not limited to lightning damage.
- Special, incidental or consequential damages.

### **Product Registration:**

Please complete and mail the Product Registration Card packed with your unit or register on-line at [www.rca.com/television](http://www.rca.com/television). It will make it easier to contact you should it ever be necessary. The return of the card is not required for warranty coverage.

### **Limitation of Warranty:**

- **THE WARRANTY STATED ABOVE IS THE ONLY WARRANTY APPLICABLE TO THIS PRODUCT. NO VERBAL OR WRITTEN INFORMATION GIVEN BY TTE TECHNOLOGY, INC., ITS AGENTS OR EMPLOYEES SHALL CREATE A GUARANTY OR IN ANY WAY INCREASE OR MODIFY THE SCOPE OF THIS WARRANTY.**
- **REPAIR OR REPLACEMENT AS PROVIDED UNDER THIS WARRANTY IS THE EXCLUSIVE REMEDY OF THE CONSUMER. TTE TECHNOLOGY, INC. SHALL NOT BE LIABLE FOR SPECIAL, INCIDENTAL OR CONSEQUENTIAL DAMAGES RESULTING FROM THE USE OF THIS PRODUCT OR ARISING OUT OF ANY BREACH OF ANY EXPRESS OR IMPLIED WARRANTY ON THIS PRODUCT. THIS DISCLAIMER OF WARRANTIES AND LIMITED WARRANTY ARE GOVERNED BY THE LAWS OF THE STATE OF INDIANA. EXCEPT TO THE EXTENT PROHIBITED BY APPLICABLE LAW, ANY IMPLIED WARRANTY OF MERCHANTABILITY OR FITNESS FOR A PARTICULAR PURPOSE ON THIS PRODUCT IS LIMITED TO THE APPLICABLE WARRANTY AND WARRANTY PERIOD SET FORTH ABOVE.**

### **How State Law relates to this warranty:**

- Some states do not allow the exclusion nor limitation of incidental or consequential damages, or limitations on how long an implied warranty lasts, so the above limitations or exclusions may not apply to you.
- This warranty gives you specific legal rights, and you also may have other rights that vary from state to state.

**If you purchased your unit outside the United States or seek warranty coverage outside the United States:**

This warranty does not apply. Contact your dealer for warranty information.

**Service calls which do not involve defective materials or workmanship are not covered by this warranty. Costs of such service calls are the sole responsibility of the purchaser.**



# TTE Technology Canada Ltd. (“TTE”) Limited Warranty

**EXCEPT TO THE EXTENT PROHIBITED BY APPLICABLE LAW, THIS WARRANTY DOES NOT COVER, AND AS DESCRIBED BELOW TTE EXPRESSLY DISCLAIMS, ALL ACTUAL AND IMPLIED WARRANTIES AND CONDITIONS WITH RESPECT TO ANY PRODUCT USED FOR INSTITUTIONAL OR OTHER COMMERCIAL PURPOSES (INCLUDING BUT NOT LIMITED TO RENTAL PURPOSES).**

## **What your warranty covers:**

- Defects in materials or workmanship to the original purchaser.

## **For how long after purchase:**

- All RCA televisions: One year parts and labour.
- All RCA Scenium televisions: One year parts and labour.

## **What TTE Technology Canada Ltd. will do:**

At TTE’s discretion, pay an Authorized RCA Service Centre for both labor charges and parts to repair your television, or replace your television with a new or refurbished/remanufactured unit. See “How to get service”

## **How to get service:**

- Call 1-866-465-7157 (French: 1-800-522-0445). Please have your unit’s date of purchase and model/serial number ready. The model/serial number information can be found on the back of your unit.
- A representative will troubleshoot your problem over the phone.
- If it is determined that your unit requires service, the service location will be at the sole discretion of TTE based upon the TTE Limited Warranty statement.
- At the sole discretion of TTE, RCA CRT DV televisions are either consumer carry-in to an Authorized RCA Service Centre or directly exchanged for a new or refurbished/remanufactured unit.
- At the sole discretion of TTE, RCA LCD televisions are either consumer carry-in to an Authorized RCA Service Centre, directly exchanged for a new or refurbished/remanufacture unit or provided in-home service.
- At the sole discretion of TTE, RCA Scenium LCD televisions are either consumer carry-in to an Authorized RCA Service Centre, directly exchanged for a new or refurbished/remanufacture unit or provided in-home service.
- Proof of purchase in the form of an original bill of sale or receipted invoice from an Authorized Dealer which is evidence that the product is within the warranty period must be presented to obtain warranty service.

**Your warranty does not cover damages which are caused by:**

- Fire, accident, lightning, flood and/or other acts of God;
- Faulty installation, set-up adjustments, improper antenna, inadequate signal reception, adjustment of consumer controls and/or improper maintenance; and/or
- Failure which results from misuse, abuse, neglect, mishandling, misapplication, and/or alteration.

**What your warranty does not cover:**

- Customer instruction (Your Owner's Manual describes how to install, adjust, and operate your unit. Any additional information should be obtained from your dealer);
- Transportation cost to and from the Service Centre (Unless you have made other arrangements with your dealer at the time of purchase whereby he undertakes this responsibility);
- Installation and set-up service adjustments;
- Products connected otherwise than as outlined in the Owner's Manual;
- Products on which the serial number has been altered or removed;
- External antenna or cable systems;
- Remote control batteries;
- A television that has been modified or incorporated into other products or is used for institutional or other commercial purposes (including but not limited to rental purposes);
- A unit purchased or serviced outside Canada;
- Special, incidental or consequential damages; and/or
- Normal wear or cosmetic damage.

**How Provincial law relates to this warranty:**

This warranty gives you specific legal rights, which are in addition to statutory warranties, which may vary from Province to Province and which take precedence over the terms of this warranty.

**If you purchased your unit outside of Canada:**

This warranty does not apply. Contact your dealer for warranty information.

©2009 TTE Technology Canada Ltd.

6605 Hurontario Street, Mississauga, Ontario L5T 0A3

# Care and Cleaning

*Caution:* Turn OFF your TV before cleaning.

You can clean the TV as required, using a soft lint-free cloth. Be sure to occasionally dust the ventilation slots in the cabinet to help assure adequate ventilation.

**IMPORTANT: Never use strong cleaning agents, such as ammonia-based cleaners, or abrasive powder. These types of cleaners will damage the TV. The TV's screen may be cleaned with a soft, lint-free cloth as well. Take care not to scratch or mar the screen. If necessary, you may use a cloth dampened with warm water. While cleaning, do not spray liquid directly on the screen, or allow liquid to run down the screen and inside the TV. Also, never place drinks or vases with water on top of the TV. This could increase the risk of fire, shock hazard or damage to the TV.**



**ENERGY STAR** is a set of power-saving guidelines issued by the U.S. Environmental Protection Agency (EPA).  
Manufactured under license from Dolby Laboratories.

"Dolby" and the double-D symbol are registered trademarks of Dolby Laboratories.

**SRS**  is a trademark of SRS Labs, Inc.

TruSurround XT technology is incorporated under license from SRS Labs, Inc.

## **FCC Information**

This equipment has been tested and found to comply with the limits for a Class B digital device, pursuant to Part 15 of the FCC Rules. These limits are designed to provide reasonable protection against harmful interference in a residential installation. This equipment generates, uses, and can radiate radio frequency energy and, if not installed and used in accordance with the instructions, may cause harmful interference to radio communications. However, there is no guarantee that interference will not occur in a particular installation. If this equipment does cause harmful interference to radio or television reception, which can be determined by turning the equipment off and on, the user is encouraged to try to correct the interference by one or more of the following measures:

- Reorient or relocate the receiving antenna.
- Increase the separation between the equipment and receiver.
- Connect the equipment into an outlet on a circuit different from that to which the receiver is connected.
- Consult the dealer or an experienced radio/TV technician for help.

This Class B digital apparatus complies with Canadian ICES-003.

Visit the RCA website at [www.rca.com/television](http://www.rca.com/television)

Please do not send any products to the Indianapolis address listed in this manual or on the carton. This will only add delays in service for your product.

# **TTE**

**TTE Technology, Inc.**

**101 West 103rd Street**

**Indianapolis, IN 46290**

**© 2009 TTE Technology, Inc.**

**RCA and associated marks are trademarks of THOMSON S.A.**

**used under license to TTE Corporation.**

**Printed in USA**

**Part No.: 72-NP90NA-E001C**

## Free Manuals Download Website

<http://myh66.com>

<http://usermanuals.us>

<http://www.somanuals.com>

<http://www.4manuals.cc>

<http://www.manual-lib.com>

<http://www.404manual.com>

<http://www.luxmanual.com>

<http://aubethermostatmanual.com>

Golf course search by state

<http://golfingnear.com>

Email search by domain

<http://emailbydomain.com>

Auto manuals search

<http://auto.somanuals.com>

TV manuals search

<http://tv.somanuals.com>