

RCA

SCENIUM

USER'S GUIDE FOR:
HIGH-DEFINITION PLASMA DISPLAY

PHD50300

Safety Information

WARNING

RISK OF ELECTRIC SHOCK
DO NOT OPEN



This symbol indicates "dangerous voltage" inside the product that presents a risk of electric shock or personal injury.



This symbol indicates important instructions accompanying the product.

TO REDUCE THE RISK OF ELECTRIC SHOCK, DO NOT REMOVE COVER (OR BACK). NO USER SERVICEABLE PARTS INSIDE. REFER SERVICING TO QUALIFIED SERVICE PERSONNEL.

Precautions

Please read this manual carefully before using your Monitor and keep the manual handy for future reference.

WARNING

TO PREVENT FIRE OR SHOCK HAZARDS, DO NOT EXPOSE THIS UNIT TO RAIN OR MOISTURE. ALSO DO NOT USE THIS UNIT'S PLUG WITH AN EXTENSION CORD RECEPTACLE OR OTHER OUTLETS, UNLESS ALL PRONGS CAN BE FULLY INSERTED. REFRAIN FROM OPENING THE CABINET AS THERE ARE HIGH-VOLTAGE COMPONENTS INSIDE. REFER SERVICING TO QUALIFIED SERVICE PERSONNEL.

Industry Canada Compliance Notice

This Class B digital apparatus meets all requirements of the Canadian Interference-Causing Equipment Regulations.

Declaration of Conformity

This device complies with Part 15 of the FCC rules. Operation is subject to the following two conditions: (1) This device may not cause harmful interference, and (2) this device must accept any interference received, including interference that may cause undesired operation.

Product: Cinema Screen Display

Equipment Classification: Class B Computer Peripheral

Model: PHD50300

We hereby declare that the equipment specified above conforms to the technical standards as specified in the FCC rules.

Thomson multimedia Inc.
10330 N. Meridian St.
Indianapolis, IN 46290
Phone: 1-800-433-8974

Cable TV Installer: This reminder is provided to call your attention to Article 820-40 of the National Electrical Code (Section 54 of the Canadian Electrical Code, Part 1) which provides guidelines for proper grounding and, in particular, specifies that the cable ground shall be connected to the grounding system of the building as close to the point of cable entry as practical.

FCC Information

- FCC Regulations state that unauthorized changes or modifications to this equipment may void the user's authority to operate it.
- This equipment has been type tested and found to comply with the limits for a Class B Digital Device in accordance with the specifications in Part 15 of the FCC rules. These rules are designed to provide reasonable protection against radio and television interference in a residential installation. This equipment generates and can radiate radio frequency and, if not installed and used in accordance with the instructions, may cause harmful interference to radio communications. However, there is no guarantee that interference will not occur in a particular installation.

If this equipment does cause interference to the radio or television reception (which you can determine by turning the equipment off and on), try to correct the interference by one or more of the following measures:

- Reorient or relocate the receiving antenna (that is, the antenna for the radio or television that is "receiving" the interference).
- Change the position of the monitor with respect to the radio or television equipment that is receiving the interference.
- Move the monitor away from the equipment receiving the interference.
- Plug the monitor into a different wall outlet so the receiver and the equipment are on different branch circuits.

If these measures do not eliminate interference, please consult your dealer or an experienced radio/television technician for additional suggestions. Also, the Federal Communications Commission has prepared a helpful booklet, "How to Identify and Resolve Radio/TV Interference Problems." This booklet is available from the U.S. Government Printing Office, Washington D.C., 20402. Please specify stock number 004-000-00345-4 when ordering copies.

Warnings and Safety Precautions

The monitor is designed and manufactured to provide long, trouble-free service. No maintenance other than cleaning is required. Use a soft dry cloth to clean the panel. Never use solvents such as alcohol or thinner to clean the panel surface.

The display panel consists of fine picture elements (cells). Although the display panels are produced with more than 99.99 percent active cells, there may be some cells that do not produce light or remain lit.

For operating safety and to avoid damage to the unit, read carefully and observe the following instructions.

To avoid shock and fire hazards:

1. Provide adequate space for ventilation to avoid internal heat build-up. Do not cover ear vents or install in a closed cabinet or shelves.

The unit is equipped with cooling fans. If you install the unit in an enclosure, be sure there is adequate space at the top of the unit to allow hot air to rise and escape.

If the monitor becomes too hot, the overheat protector will be activated and the monitor will be turned off. If this happens, turn off the power to the monitor and unplug the power cord. If the room where the monitor is installed is particularly hot, move the monitor to a cooler location, and wait for the monitor to cool for 60 minutes.

If the problem persists, contact your dealer for service.
2. Do not use the power cord plug with extension cords or outlets unless all prongs can be completely inserted.
3. Do not expose unit to water or moisture.
4. Avoid damage to the power cord, and do not attempt to modify the power cord.
5. Unplug unit during electrical storms or if unit will not be used over a long period.
6. Do not open the unit which has potentially dangerous high voltage components inside. If the unit is damaged from opening the cabinet the warranty will be void. Moreover, there is a serious risk of electric shock.
7. Do not attempt to service or repair the unit. Tmm is not liable for any bodily harm or damage caused if unqualified persons attempt service or open the back cover. Refer all service to authorized Service Centers.

IMPORTANT TIPS: Caring for Your Monitor

To avoid damage and prolong operating life:

1. Use only with 120V 50/60Hz AC power supply. Continued operation at line voltages greater than 120 Volts AC will shorten the life of the unit, and might cause a fire hazard.
2. Handle the unit carefully when installing it.
3. Locate set away from heat, excessive dust, and direct sunlight.
4. Protect the inside of the unit from liquids and small metal objects. In case of accident, unplug the unit and have it serviced by an authorized service center
5. Do not hit or scratch the panel surface as this causes flaws on the surface of the screen.
6. For correct installation and mounting it is strongly recommended to use a trained, authorized dealer
7. Like all phosphor-based display devices, monitors can be susceptible to uneven phosphor aging under certain circumstances. Certain operating conditions, such as the continuous display of a static image over a prolonged period of time, can result in uneven phosphor aging if proper precautions are not taken. To protect your investment in this monitor please adhere to the following guidelines and recommendations for minimizing the occurrence of uneven phosphor aging:
 - Always enable and use your computer's screen saver function during use with a computer input source.
 - Display a moving image whenever possible.
 - Always power down the monitor when you are finished using it.
 - If viewing with a 4/3 aspect ratio for long periods of time, set side gray level at 3 or 4.

If the monitor is in long term use or continuous operation take the following measures to reduce the likelihood of uneven phosphor aging:

- Lower the BRIGHTNESS and CONTRAST levels as much as possible without impairing image readability.
- Display an image with many colors and color gradations (i.e. photographic or photo-realistic images).
- Create image content with minimal contrast between light and dark areas (for example, white characters on black backgrounds). Use complementary or pastel color whenever possible.
- Avoid displaying images with few colors and distinct, sharply defined borders between colors.

Contents

Safety Information	1
Warnings and Safety Precautions	2
IMPORTANT TIPS: Caring for Your Monitor	2
Getting Started	5
Contents of the Package	6
Part Names and Functions – Front View	7
Part Names and Functions – Back View	8
Battery Installation	9
Connecting an HD Receiver	9
The Back of the HD Receiver	9
Connecting Your VCR Or Laserdisc Player	10
Connecting Your DVD Player	10
Connecting a Personal Computer	10
Connecting Components to the Monitor	11
Connecting External Speakers to the Monitor	12
A Quick Tour of the Remote Control	13
Using Your Remote Control	15
Inserting Batteries	15
Programming the Remote	15
Find Out If You Need to Program the Remote	15
How to Program the Remote	16
Using Automatic Code Search	16
Using Direct Entry	17
How To Use the Remote Control	
After You've Programmed It	17
Programmable Codes for the Remote Control	18
The Menu System	21
Basic Operations	22
Power	22
Volume	22
Mute	22
Navigating the Menus	22
The Multi-Screen Feature	23
Selecting the Input Signals to be displayed	24
On-Screen Menu Operation	24
The PICTURE QUALITY Menu	25
Setting the Picture Mode	25
Adjusting the Picture Settings in MEMORY Mode	26
Setting the Color Temperature	27
Reducing Noise in the Picture	28
The AUDIO Menu	29
The SCREEN Menu	30
Selecting a Viewing Size	30
Adjusting the Picture Position and Size	31
Auto Picture	31

Contents

The FUNCTION Menu	32
On-Screen Displays	32
Adjusting the Position of the Menu Display	32
Setting the POWER SAVER for Computer Images	33
The POWER/STANDBY Indicator	33
Setting the Gray Level for the Sides of the Screen	34
Adjusting for Flickering with Film Mode	34
Adjusting the Display in RGB3 Input Mode	35
Setting the Screen Saver	35
Setting the PLE	35
Turning Orbiter On	36
Setting the Inverse	36
Resetting to Default Values	37
The OPTIONS Menu	38
Setting the Audio Inputs	38
Setting the BNC Connectors	38
Setting a Computer Image to the Correct RGB Select Mode	39
Setting the Monitor to the correct HD Receiver Mode	40
Setting the Picture Size for RGB input signals	40
The SETUP Menu	41
Confirming the Frequencies, Polarities, mode and resolution of Input Signals	41
Selecting the Language for the Menus	42
Setting the Video Signal Format	42
The AUTOTUNING SETUP Menu	43
Autotuning the Component Buttons on he Remote Control.....	43
SLEEP TIMER	44
Setting the Sleep Timer	44
Cancelling the Sleep Timer	44
Other Information	45
Installing the Monitor	46
Attaching optional mounts or stand to the Cinema Screen monitor	46
Connecting Your PC Or Macintosh Computer	47
Mini D-sub 15 Pin VGA Signal Composition	47
Specifications	48
Troubleshooting	49
The Monitor Menu System	50
Supported Resolution	52
RCA Limited Warranty	54
Accessories	56
Index	57

Connections and Setup

Chapter Overview:

- Contents of the Package
- Part Names and Functions
- Battery Installation
- Connections
- A Quick Tour of the Remote Control

Connections and Setup

Contents of the Package

Cinema Screen monitor
Power cord
Ferrite cores
RGB cable (Mini D-Sub 15-pin to Mini D-Sub 15-pin connector)
Remote control unit with two AA batteries
User's manual

It is highly recommended that you have your monitor installed by a professional. If you are installing the monitor yourself, refer to the Reference section.

NOTE: If you are planning on attaching the floor stand to your monitor (and not the optional wall mount unit) you may want to use the safety metal fittings (provided) to give your monitor extra stability.

The safety metal fittings attach to the back of the screen and can then be used to secure the monitor to the wall with strong wire. Contact your trained, authorized dealer for professional installation.

In order to conform to mandatory FCC standards, you must attach the supplied ferrite cores to both ends of the power cable (see below).

If you are connecting a computer to the monitor, you must attach the ferrite cores to both ends of the DVI cable to meet FCC standards.

Attaching the ferrite cores

Set the ferrite cores on the both ends of the DVI cable (supplied), and one end of the power cable (supplied). Close the lid tightly until the clamps click. Use the band (supplied) to secure the ferrite core.

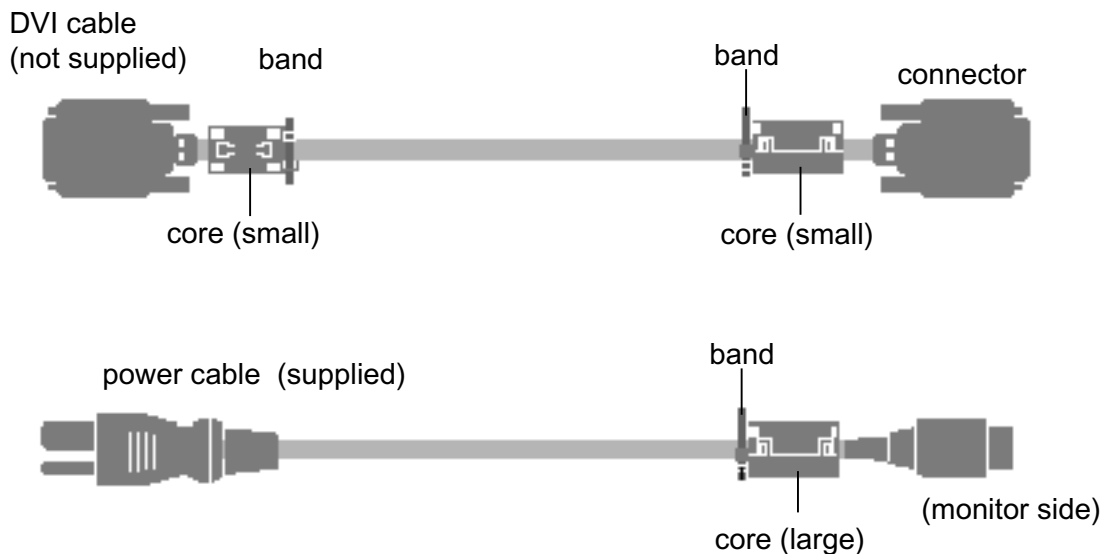

Part Names and Functions – Front View

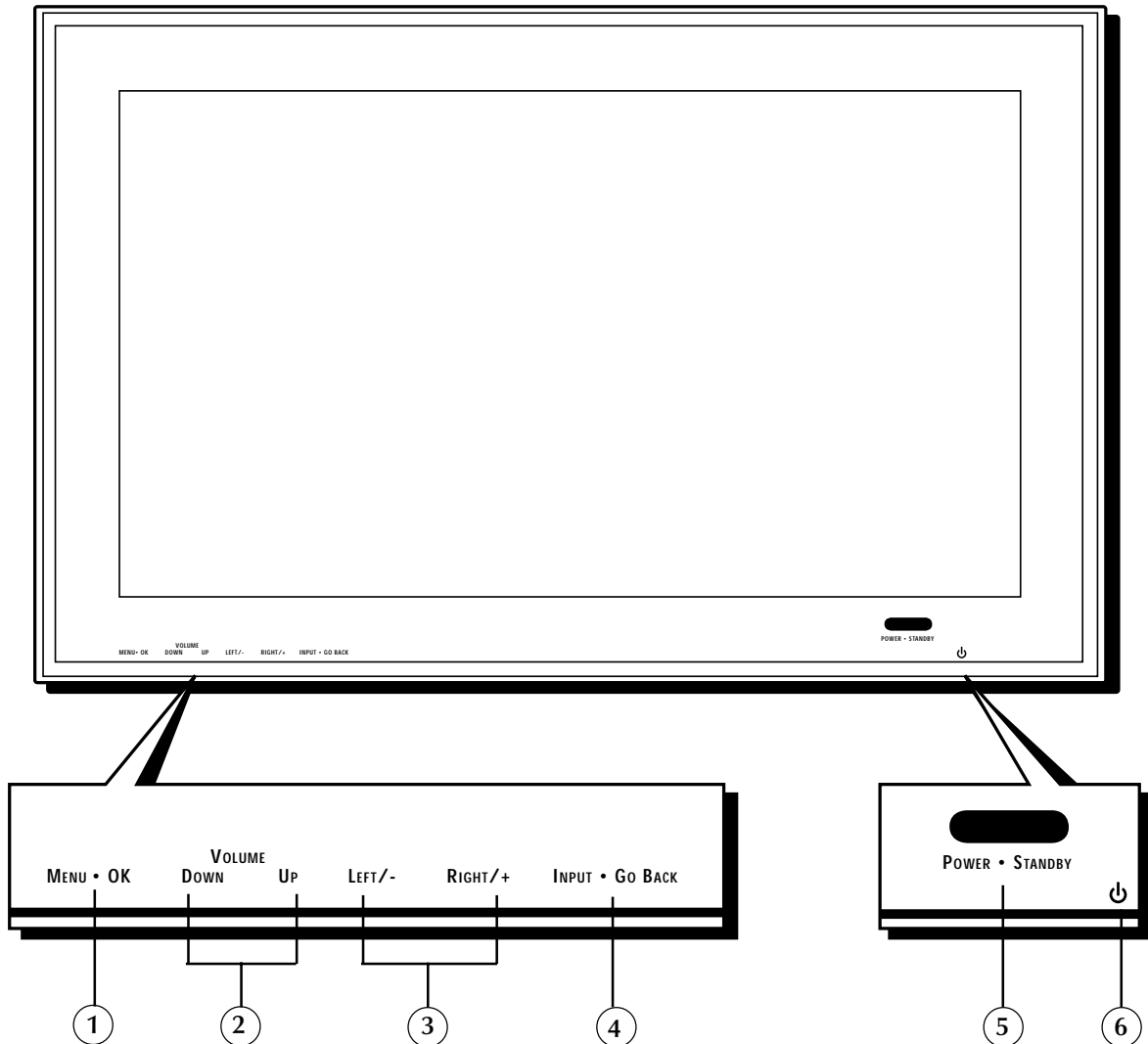

- MENU • OK** – If no menu is displayed, brings up the menu. If a menu is displayed, press to select a highlighted option.
- VOLUME** – Adjusts the volume. When an on-screen menu is being displayed, moves highlight up and down (▲ and ▼).
- LEFT/- AND RIGHT/+** – When Zoom mode is on (press OK on the remote to turn ZOOM on and bring up the zoom icon) press Right/+ to enlarge the image or Left/- to reduce the image.
When a menu is being displayed, used to navigate through menu (◀ and ▶).
- INPUT • GO BACK** – Switches the input, in the following order:

VIDEO1	→	VIDEO2	→	VIDEO3	→	CMPNT1*
RGB3	←	RGB2*	←	RGB1	←	CMPNT2

**Note: You can set up CMPNT1 or RGB2, but not both.*
When an on-screen menu is being displayed, returns you to the previous menu.
- POWER/STANDBY indicator** – When the power is on, the light is green. When the power is in Standby Mode, the light is red.
- ⏻** – Turns the monitor's power on and off.

Connections and Setup

Part Names and Functions – Back View

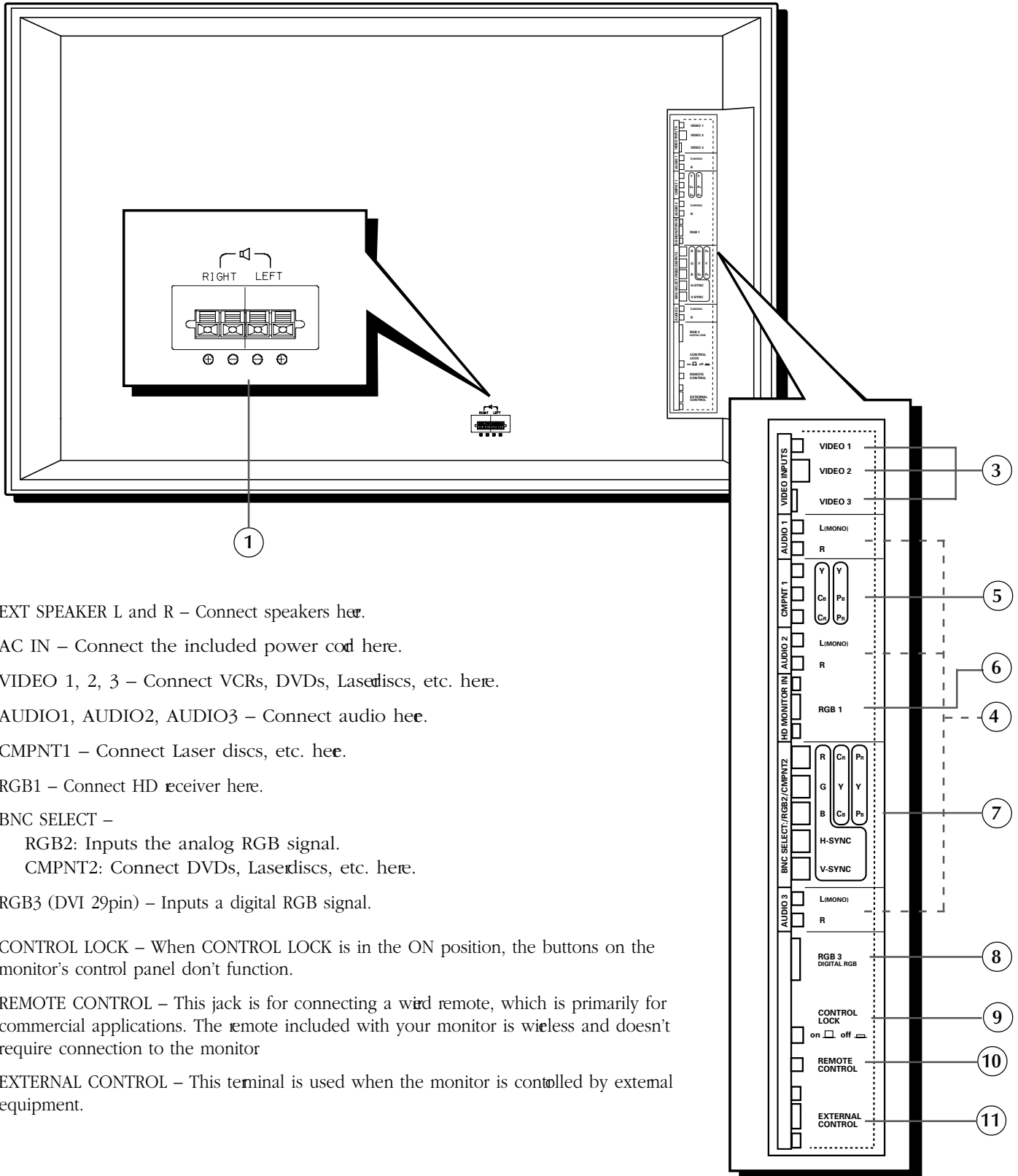

Battery Installation

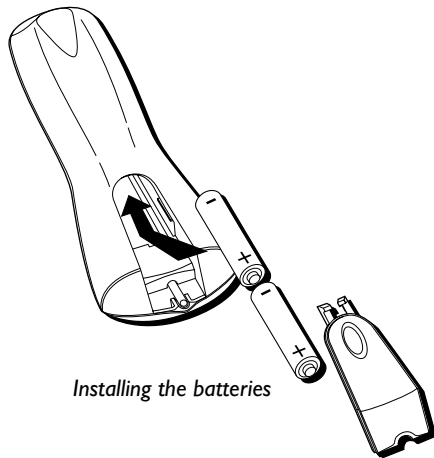

Installing the batteries

- Remove the battery compartment cover from the back of the remote control.
- Insert batteries. Make sure the polarities (+ and -) are aligned correctly.
- Replace cover.

Connecting an HD Receiver

RCA and PROSCAN HD (high definition) receivers come equipped with an RGB output jack for optimum quality. Using the RGB cable provided, connect the HD MONITOR OUT jack on the back of your HD receiver to the RGB1 (HD MONITOR IN)/AUDIO1 IN jack on the back of the monitor.

If your HD receiver does not have the type of jack pictured on the right, connect your HD receiver using the component video jacks and RCA cable.

For more information on HD receiver connections, see your HD receiver user's manual.

The Back of the HD Receiver

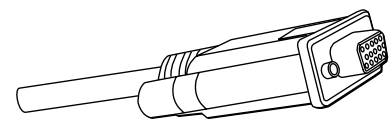
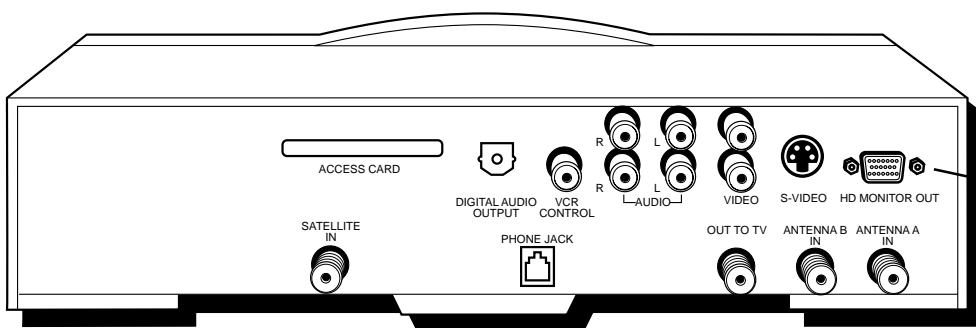

RGB cable

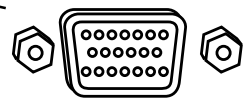

HD MONITOR OUT jack

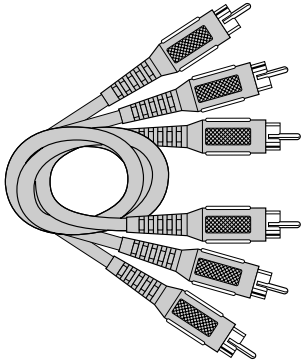

RCA cables (audio/video cables) are sold as a bundled set.

Connecting Your VCR Or Laserdisc Player

Use common RCA cables (not provided) to connect your VCR or laserdisc player to your monitor. To connect your VCR or Laserdisc player:

1. Turn off the power to the monitor and VCR or laser disc player.
2. Connect one end of your RCA cable to the video output connector on the back of your VCR or laser disc player. Connect the other end to the video input on the monitor.
3. Use standard RCA cables to connect the audio from your VCR or laser disc player to AUDIO2 input jacks on the monitor (if your VCR or laser disc player has this capability). Be careful to keep your right and left channel connections correct for stereo sound.
4. Turn on the monitor and the VCR or laser disc player.

NOTE: Refer to your VCR or laser disc player user's manual for more information about your equipment's video output requirements.

Connecting Your DVD Player

To connect your monitor to a DVD player:

1. Turn off the power to the monitor and DVD player.
2. Use a standard video cable to connect your DVD player to the CMNT1 input on the monitor or use the DVD player's S-Video output. (Use a standard S-Video cable to connect to the S-Video input on the monitor.)
3. Turn on the monitor and the DVD player.

Connecting a Personal Computer

If you have a computer with digital RGB output, connect it to the RGB3 jack on the monitor.

For IBM VGA (or compatible) or Macintosh (or compatible) connect to the RGB1 jack on the monitor.

Connecting Components to the Monitor

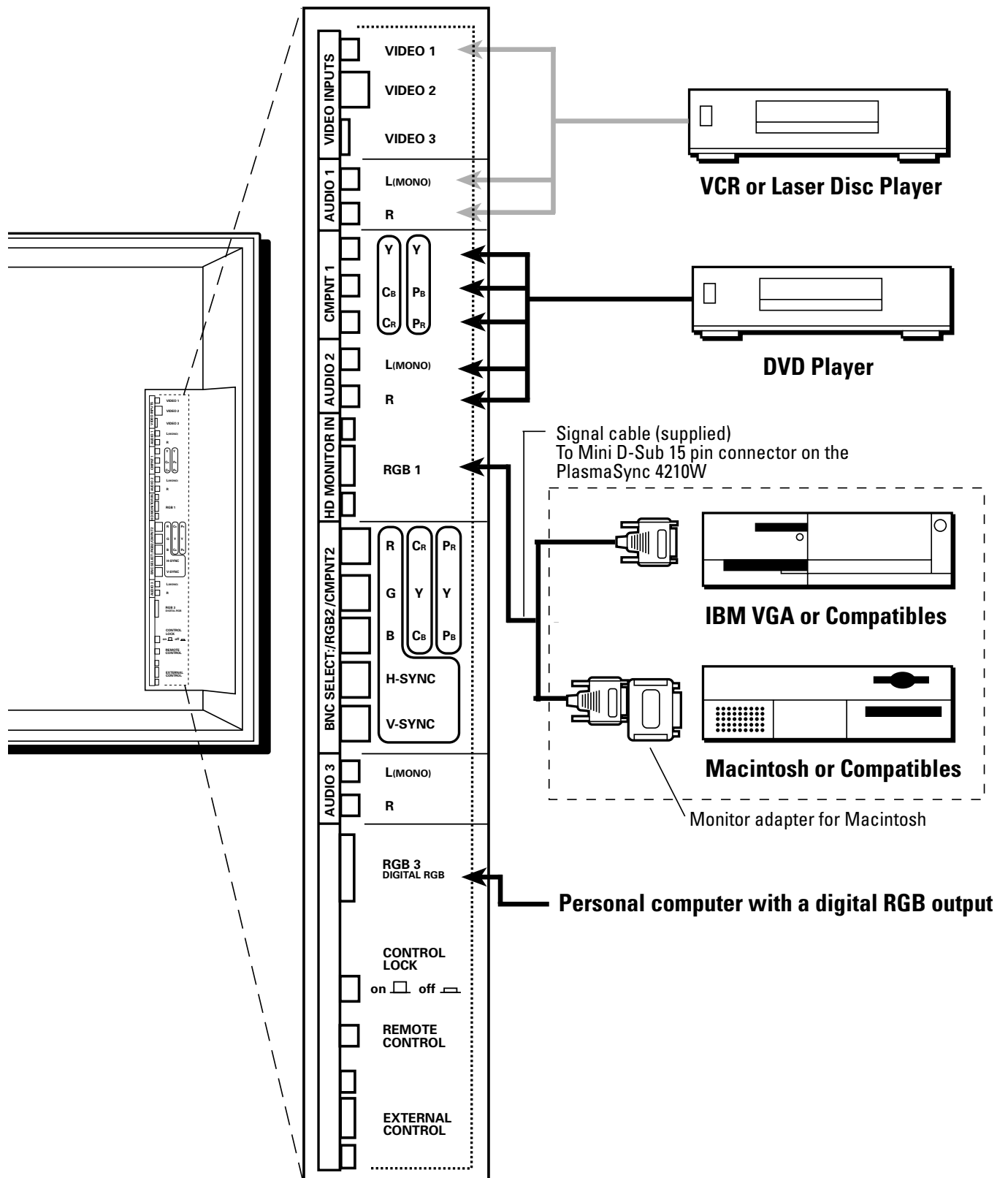

Connections and Setup

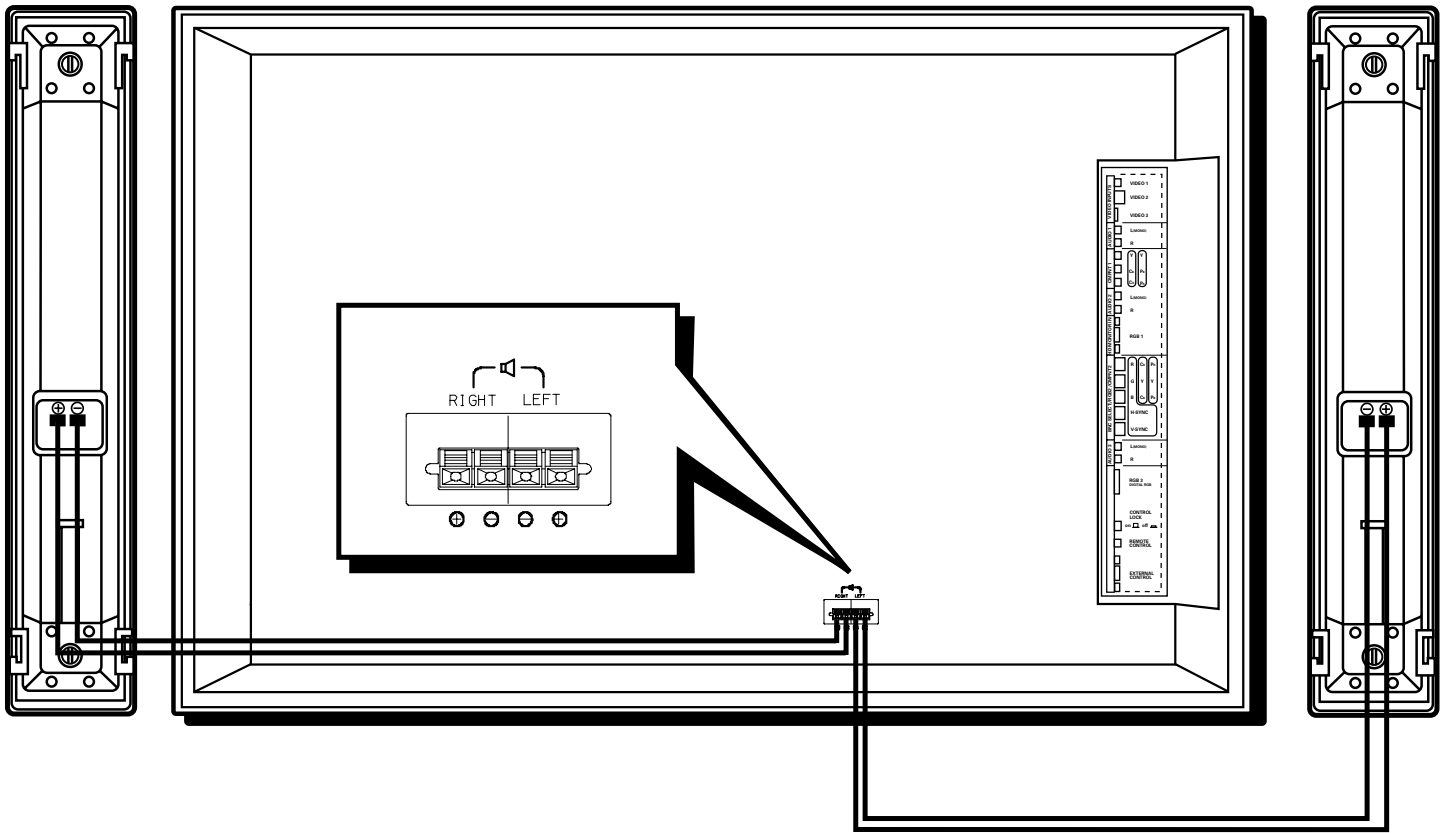

Connecting External Speakers* to the Monitor

The monitor doesn't have internal speakers, so in order to get sound you must connect external speakers. External speakers can reproduce sound from VIDEO or RGB signal sources.

External speakers may be connected directly to the SPEAKERS terminals or indirectly by connecting a stereo system amplifier to the audio outputs.

CAUTION: *Unplug the monitor and all connected components before connecting external speakers. Use only speakers with 6 to 8-ohm impedance and a power output rating of 7 watts or more.*

To connect external speakers directly to the monitor:

1. Strip the ends of the speaker wires.
 2. Press down the tabs below the speaker terminals and insert the speaker wire and release the tab to secure the speaker wire connection.
- [a] Connect the right speaker (located at right side of the monitor when viewed from the front) positive (+) wire to RIGHT +.
- [b] Connect the right speaker negative (-) wire to RIGHT -.
- [c] Connect the left speaker negative (-) wire to LEFT-.
- [d] Connect the left speaker positive wire (+) to LEFT+.

*Not included

A Quick Tour of the Remote Control

In alphabetical order

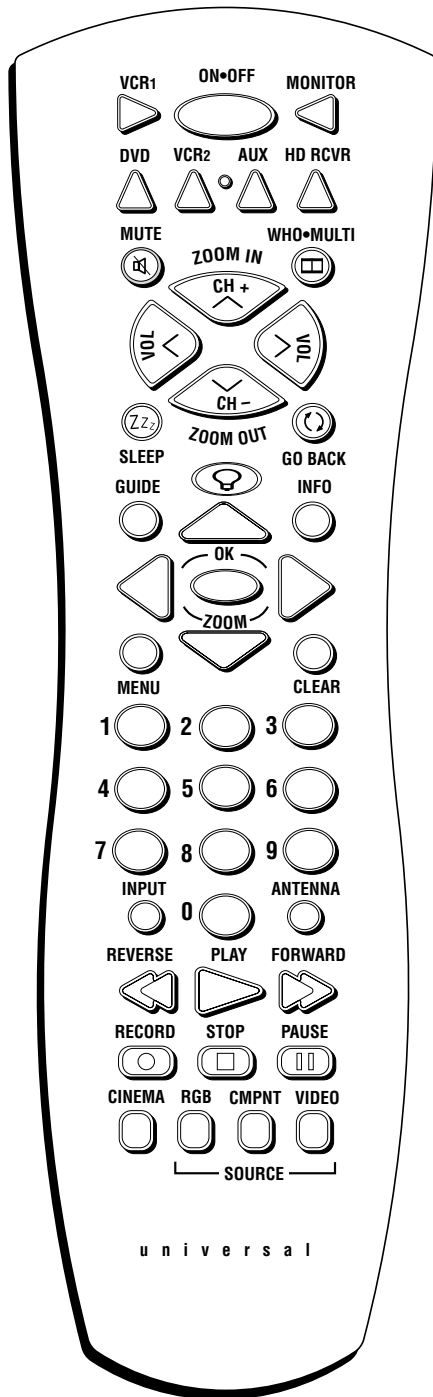

ANTENNA When the remote is in HD RCVR mode, switches the HD receiver between Antenna A and Antenna B.

Arrows Use the arrows to navigate through the menu screens and moves the Zoom pointer in Zoom mode.

AUX (auxiliary) You can program this button to control any one of the following: a cable box; most GE, RCA, and PROSCAN audio components; a laserdisc player; a VCR; or a satellite receiver. Press this button to operate the component you've programmed to work with the AUX button.

CH+/CH- Changes channels on the HD receiver when the remote is in HD receiver mode. When the Zoom mode is active, zooms in (CH+) or out (CH-).

CINEMA Press to select one of four screen sizes to suit the type of input you're watching.

NOTE: When watching the HD receiver, screen size is controlled through the HD receiver menu system.

CLEAR Clears on-screen displays and returns you to normal viewing.

CMPNT Toggles between CMPNT1 and CMPNT2 inputs.

GO BACK In HD receiver mode, returns you to the previous channel. When in the menu system, returns you to the previous menu.

GUIDE In HD receiver mode, brings up the on-screen program guide.

INFO Brings up channel information.

INPUT Changes the video input.

MENU Brings up the on-screen menu.

MONITOR Turns the power to the monitor on and puts the remote in Monitor mode so you are able to control the monitor.

MUTE Reduces sound to an inaudible level.

Numbers Use the number keys to make numerical entries.

OK/ZOOM When in Monitor mode (press the MONITOR button) and using on-screen menus, press OK to select a highlighted menu function. When there are no on-screen menus displayed, press OK to bring up the zoom pointer. Using the arrow buttons, position pointer on the part of the screen you want to zoom on, then use the CH+/- buttons to zoom in/out.

Connections and Setup

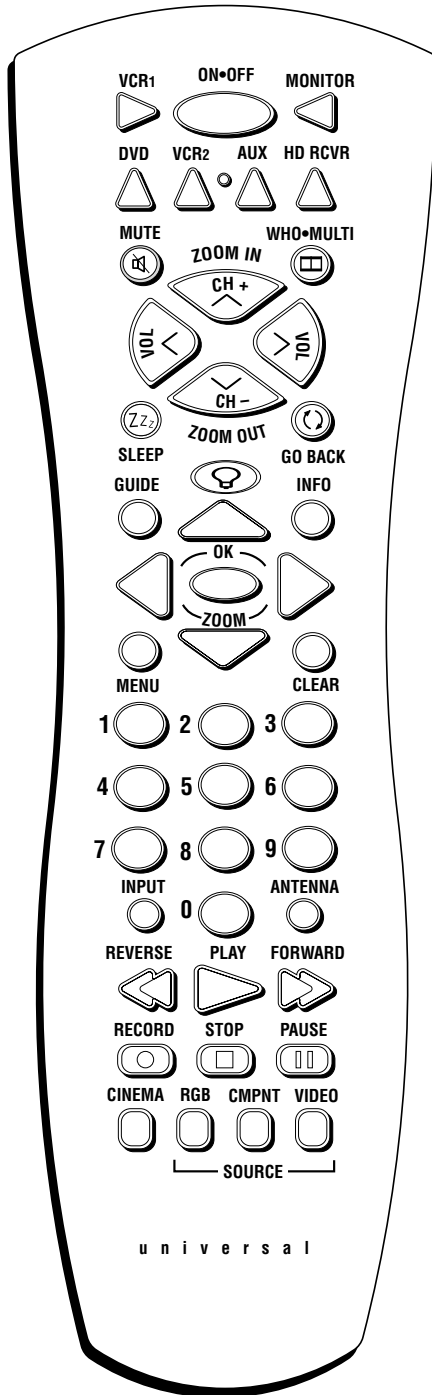

ON•OFF Toggles power on and off for the components that you have programmed. For example, if you are in VCR mode, turns VCR on and off.

REVERSE, PLAY, FORWARD, STOP, PAUSE, RECORD (transport keys)

Use with components programmed to work with your remote control (VCR, DVD player, audio components).

RGB Depending on how you set up the monitor toggles between RGB1, RGB2*, and RGB3.

**Note: You can set up CMPNT2 OR RGB2, but not both. If CMPNT2 is set up, RGB2 will not appear when you use the RGB button.*

SLEEP Brings up the sleep timer which is used to turn the monitor off automatically after a set amount of time.

VCR1, VCR2, DVD, HD RCVR, MONITOR These are the component buttons used to put the remote control into the correct mode to operate that particular component. The correct video source must first be selected (VIDEO or RGB) or Autotuning must be set up.

VOL</VOL> Adjusts the volume.

VIDEO Selects whatever component is hooked up to the video source inputs.

WHO•MULTI When in Monitor mode, activates the multi-screen feature. The Multi-screen feature allows you to select a screen mode for viewing a single picture, side-by-side pictures, or picture-in-picture (PIP). Brings up personal viewer profiles for some components.

ZOOM IN When in zoom mode (press the MONITOR button and then the OK button to access zoom mode) enlarges the picture. When in zoom mode, use the arrow buttons to pan and scan the entire picture.

ZOOM OUT When in zoom mode (press the MONITOR button and then the OK button to access zoom mode) decreases the magnification of the picture. If picture is distorted, zoom out to restore to normal.

Using Your Remote Control

Inserting Batteries

1. Remove the battery compartment cover from the remote control.
2. Insert batteries (included) as shown on the diagram inside the battery compartment.
3. Replace the battery compartment cover

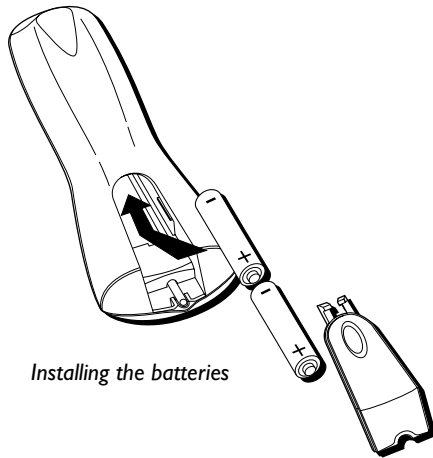

Use your remote control from a distance of about 7m/23 feet from the monitor's remote control sensor and at a horizontal angle of within 30°. The remote operates on line of sight, so if there is anything blocking the path between the remote and the remote control sensor on the front of the monitor, the remote may not work.

- Don't expose the remote control sensor on the front of the monitor to direct sunlight or strong artificial light.
- Don't get the remote control wet.
- Avoid heat and humidity.
- When not using the remote for a long period of time, remove the batteries.

Programming the Remote

The universal remote control that came with your monitor is already programmed to operate most RCA, GE, and PROSCAN VCRs, DVD players, laserdisc players, and satellite receivers. This remote is also capable of operating many other brands of remote-controllable electronic components, but you must program it to do so.

Find Out If You Need to Program the Remote

To determine whether the universal remote needs to be programmed, turn on one of your components, such as a VCR. Point the remote control at the component and press the component button (for example, the VCR button). Now press the ON•OFF button on the remote. If the component doesn't turn off, you need to program the remote control in order for it to operate that component.

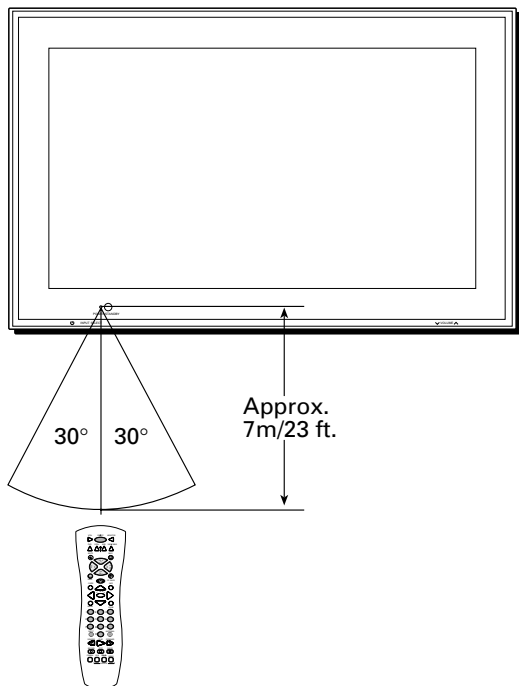

Connections and Setup

How to Program the Remote

There are two ways to program the remote control: automatic code search and direct entry.

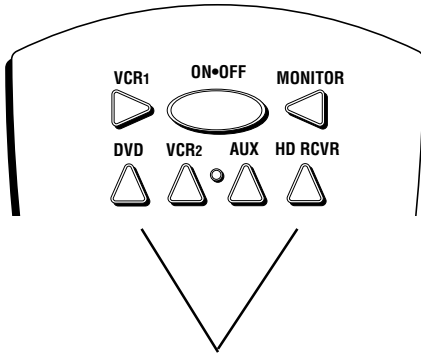

Component Buttons

These are the buttons you program to operate another component.

Using Automatic Code Search

1. Turn on the component you want the remote to operate (VCR, HD receiver, etc.)
2. Press and hold the component button that corresponds to the component you want the remote to operate (VCR, HD receiver, etc.). While you hold down the component button, press and hold ON•OFF (when the red light on the remote turns on, release both buttons).

Note: Automatic Code Search can't be used with the AUX button.

3. Press PLAY (the red light on the remote starts flashing).

The remote is searching the first set of component codes (there are several sets of codes). If the component you want to operate doesn't turn off automatically after 5 seconds, press PLAY again (the red light starts flashing again as the remote searches through the next set of codes).

Continue pressing PLAY until the component turns off.

NOTE: *If the component doesn't turn off after you've pressed the PLAY button 20 times, the component can't be programmed.*

4. Press REVERSE and wait 2 seconds. Repeat this step until the component turns back on.
5. To finish, press and hold the STOP button until the red light on the remote turns off.

Using Direct Entry

1. Turn on the component you want the remote to operate (the red light on the remote turns on).
2. Look up the brand and code number(s) for the component on the code list on the following pages.
3. Press and hold the component button that corresponds to the component you want the remote to operate (VCR, RCA DVD, etc.).
4. Enter the code from the code list. When you begin entering numbers, the red light on the remote turns off. When the last number is entered, the red light turns back on. If the incorrect code is entered, the red light will flash.
5. Release the component button. The red light on the remote turns off.
6. Press ON•OFF to see if the component responds to the remote commands. If it doesn't, try pressing the component button and then ON•OFF again.
6. If you get no response, repeat these steps using the next code listed for your brand, until the component responds to the remote commands.

How To Use the Remote Control After You've Programmed It

Once the remote control has been programmed successfully, you're ready to use it to operate other components.

1. Press one of the video source buttons to select a component (VIDEO or RGB) to operate.
2. Press the component button (MONITOR, VCR, DVD, AUX, or HD RCVR) to use the transport buttons (REVERSE, PLAY, FORWARD, STOP, PAUSE, and RECORD) to operate the component.
3. Press ON•OFF to turn the component on or off.

NOTE: *If you keep pressing buttons and nothing happens, you may have the wrong video source or wrong component selected. You must select the correct video source and the component button that matches the component you want to operate.*

Programmable Codes for the Remote Control

VCR (VCR1, VCR2 or AUX button)

Admiral	2131
Adventura	2026
Aiko	2027
Aiwa	2002, 2026
Akai 2003, 2004, 2005, 2007, 2008, 2111, 2112, 2113	
American High	2021
Asha	2013
Audio Dynamics	2009, 2010
Audiovox	2014
Bell & Howell	2011
Beaumarck	2013
Broksonic	2012, 2025
Calix	2014
Candle 2013, 2014, 2015, 2016, 2017, 2018, 2019	
Canon	2021, 2022, 2114
Capehart	2020, 2110
Carver	2062
CCE	2027, 2061
Citizen	2013, 2014, 2015, 2016, 2017, 2018, 2019, 2027
Colortyme	2009
Colt	2061
Craig	2013, 2014, 2023, 2061
Curtis-Mathes 2000, 2002, 2009, 2013, 2016, 2018, 2021, 2022, 2024, 2115	
Cybernex	2013
Daewoo 2015, 2017, 2019, 2025, 2026, 2027, 2028, 2110	
Daytron	2110
Dbx	2009, 2010
Dimensia	2000
Dynatech	2002, 2026
Electrohome	2014, 2029
Electroponic	2014
Emerson 2002, 2012, 2014, 2015, 2021, 2024, 2025, 2026, 2029, 2030, 2032, 2033, 2034, 2035, 2036, 2037, 2038, 2039, 2040, 2041, 2042, 2044, 2045, 2047, 2065, 2105, 2113, 2116, 2117, 2130	
Fisher	2011, 2023, 2048, 2049, 2050, 2051, 2052, 2118
Fuji	2021, 2119
Funai	2002, 2026
Garrard	2026
GE 2000, 2001, 2013, 2021, 2022, 2053, 2115, 2120	
Goldstar	2009, 2014, 2018, 2054, 2121
Gradiente	2026
Harley Davidson	2026
Harman Kardon	2009
Harwood	2061
Headquarter	2011
Hitachi	2002, 2055, 2056, 2057, 2107, 2111, 2120, 2122
Hi-Q	2023
Instant Replay	2021
JCL	2021
JC Penney 2009, 2010, 2011, 2013, 2014, 2021, 2022, 2055, 2056, 2058, 2059, 2060, 2107, 2118	
Jensen	2055, 2056, 2111
JVC ... 2009, 2010, 2011, 2018, 2058, 2111, 2123	
Kenwood	2009, 2010, 2011, 2016, 2018, 2058, 2111, 2123
KLH	2061
Kodak	2014, 2021
Lloyd	2002, 2026
Logik	2061
LXI	2014

Magnavox	2021, 2022, 2062, 2063, 2104, 2108, 2124
Magnin	2013
Marantz ... 2009, 2010, 2011, 2016, 2018, 2021, 2058, 2062, 2064	
Marta	2014
Masushita	2021
MEI	2021
Memorex	2002, 2011, 2013, 2014, 2021, 2023, 2026, 2104, 2131
MGA	2029, 2065, 2113
MGN Technology	2013
Midland	2053
Minolta	2055, 2056, 2107
Mitsubishi	2029, 2055, 2056, 2065, 2066, 2067, 2069, 2070, 2071, 2072, 2073, 2074, 2106, 2113, 2123
Montgomery Ward	2075, 2131
Motorola	2021, 2131
MTC	2002, 2013, 2026
Multitech ... 2002, 2013, 2016, 2026, 2053, 2061	
NEC	2009, 2010, 2011, 2016, 2018, 2058, 2064, 2076, 2078, 2079, 2111, 2123
Nikko	2014
Noblex	2013
Olympus	2021
Optimus	2014, 2131
Optonica	2096
Orion	2035
Panasonic ... 2021, 2022, 2109, 2125, 2126, 2127	
Pentax	2016, 2055, 2056, 2107, 2120
Pentex Research	2018
Philco	2021, 2022, 2062, 2063
Philips	2021, 2062, 2096, 2124
Pilot	2014
Pioneer	2010, 2055, 2080, 2081, 2123
Portland	2016, 2017, 2019, 2110
PROSCAN	2000, 2001
Protex	2061
Pulsar	2104
Quarter	2011
Quartz	2011
Quasar	2021, 2022, 2125
RCA 2000, 2001, 2003, 2013, 2021, 2055, 2056, 2082, 2083, 2084, 2085, 2086, 2087, 2088, 2089, 2090, 2091, 2107, 2115, 2120, 2125	
Radio Shack/Realistic ... 2002, 2011, 2013, 2014, 2021, 2022, 2023, 2026, 2029, 2049, 2050, 2096, 2131	
Radix	2014
Randex	2014
Ricoh	2128
Runco	2104
Samsung ... 2005, 2013, 2015, 2033, 2053, 2112	
Sanky	2131, 2104
Sansui	2010, 2092, 2111, 2123
Sanyo	2011, 2013, 2023
Scott 2012, 2015, 2025, 2032, 2035, 2038, 2065, 2093, 2116	
Sears 2011, 2014, 2021, 2023, 2048, 2049, 2050, 2051, 2055, 2056, 2107, 2118	
Sharp 2002, 2017, 2029, 2094, 2095, 2096, 2131	
Shintom	2004, 2056, 2061, 2098
Shogun	2013
Signature	2002, 2131
Singer	2021, 2061, 2128
Sony	2002, 2004, 2098, 2099, 2119, 2128
STS	2021, 2107

Sylvania ... 2002, 2021, 2022, 2026, 2062, 2063, 2065, 2124	
Symphonic	2002, 2026
Tandy	2002, 2011
Tashiko	2014
Tatung	2058, 2111
TEAC	2002, 2026, 2058, 2085, 2111
Technics	2021, 2109
Teknika	2002, 2014, 2021, 2026, 2100, 2129
TMK	2013, 2024, 2047
Toshiba 2015, 2049, 2051, 2055, 2065, 2093, 2116	
ToteVision	2013, 2014
Unitech	2013
Vector Research	2009, 2010, 2015, 2016
Victor	2010
Video Concepts ... 2009, 2010, 2015, 2016, 2113	
Videosonic	2013
Wards ... 2002, 2013, 2014, 2015, 2021, 2023, 2026, 2029, 2055, 2056, 2061, 2096, 2101, 2102, 2103, 2107, 2116, 2131	
XR-1000	2021, 2026, 2061
Yamaha ... 2009, 2010, 2011, 2018, 2058, 2111	
Zenith	2004, 2098, 2104, 2119, 2128

Cable Box (AUX or HD RCVR button)

ABC .. 5002, 5003, 5004, 5005, 5006, 5007, 5053	
Antronix	5008, 5009
Archer	5008, 5009, 5010, 5011
Cabletenna	5008
Cableview	5008
Century	5011
Citizen	5011
Colour Voice	5012, 5013
Comtronics	5014, 5015
Contec	5016
Eastern	5017
Garrard	5011
GC Electronics	5009
Gemini	5018, 5019, 5049
General Instrument	5003
Hamlin	5020, 5021, 5022, 5035, 5045
Hitachi	5003
Hytex	5002
Jasco	5011
Jerrold	5003, 5005, 5007, 5018, 5023, 5024, 5046, 5053
Magnavox	5025
Memorex	5026
Movie Time	5002, 5027, 5028
NSC	5002, 5027, 5028
Oak	5002, 5016, 5029
Panasonic	5048, 5052
Paragon	5026
Philips	5011, 5012, 5013, 5019, 5025, 5030, 5031, 5032
Pioneer	5033, 5034
Pulsar	5026
RCA	5047, 5049, 5052
Realistic	5009, 5049
Regal	5022, 5035
Regency	5017
Rembrandt	5003
Runco	5026
Samsung	5014, 5034
Scientific Atlanta	5006, 5036, 5037, 5038
Signal	5014, 5018

Signature	5003
SL Marx	5014
Sprucer	5052
Starcom	5007, 5018, 5053
Stargate	5014, 5018
Starquest	5018
Tandy	5040
Teleview	5014
Tocom	5004, 5023, 5041
Toshiba	5026
Tusa	5018
TV86	5027
Unika	5008, 5009, 5011
United Artists	5002
United Cable	5053
Universal	5008, 5009, 5010, 5011
Videoway	5044
Viewstar	5015, 5025, 5027, 5040
Zenith	5026, 5050, 5051

Satellite Receiver

(HD RCVR or AUX button)

Chapparral	5056, 5057
Drake	5058, 5059
GE	5000, 5001
General Instruments	5060, 5061, 5062
Panasonic	5075
Primestar	5076
PROSCAN	5000, 5001
RCA	5000, 5001
Realistic	5063
Sony	5072
STS1	5064
STS2	5065
STS3	5066
STS4	5067
Toshiba	5068
Toshiba	5073
Uniden	5069

Audio (AUX button only)

(For RCA and Dimensia brands only)

AM/FM	4003
Aux	4004
Phono	4005
CD	4007
Tape	4006

This page intentionally left blank.

The Menu System

Chapter Overview:

- Basic Operations
- The Picture Quality Menu
- The Audio Menu
- The Screen Menu
- The Function Menu
- The Options Menu
- The Setup Menu
- The Auto Tuning Menu
- The Sleep Timer

The Menu System

Basic Operations

Power

To turn the monitor on and off:

1. Plug the power cord into an active AC power outlet.
2. Press the ON•OFF button on the remote control or the monitor button on the unit. The monitor's POWER/STANDBY indicator turns green when the monitor is on.
3. Press the ON•OFF button on the remote control or the unit to turn it off. The monitor's POWER/STANDBY indicator turns red and the standby mode is set (only when turning off the unit with the remote control).

Volume

To adjust the volume:

1. Press and hold the VOL > button (on the remote control or the unit) to increase to the desired level.
2. Press and hold the VOL < button (on the remote control or the unit) to decrease to the desired level.

Note: External speakers are required for sound.

Mute

Press the MUTE button on the remote control to reduce the sound to an inaudible level. Press MUTE again to restore the sound.

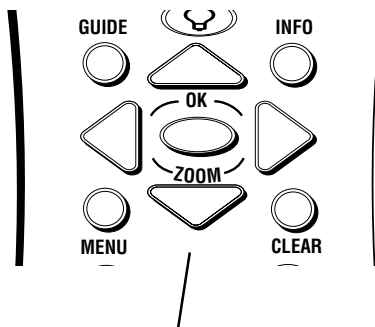

These are the buttons on the remote you use to navigate through the monitor's on-screen menu system.

Navigating the Menus

You can adjust monitor options through the monitor's menu system. To access the main menu, press the MENU button on the remote control or MENU•OK on the front of the monitor.

There are a few things you need to know to navigate through the menu system. The navigation buttons are the set of arrow-shaped buttons in the middle of the remote (See illustration on left).

Use the ▲ and ▼ buttons on the remote to move the menu highlight up and down.

Use the ◀ and ▶ buttons to move the highlight and change settings.

Press the GO BACK button on the remote to return to a previous menu.

You can return the monitor to the factory settings at any time by using the RESET option in the FUNCTION menu. Remember if you choose to reset, ALL settings will return to the factory settings.

The Multi-Screen Feature

The Multi-Screen feature is used to show either a single picture or two pictures on the screen at the same time.

SINGLE – Displays a single picture on the screen.

SIDE BY SIDE – Displays two pictures from different input signals side-by-side.

PICTURE IN PICTURE – Displays two pictures from different input signals; one fills the screen and one appears in a window on top of the other picture.

To use the Multi-Screen feature:

1. Press the WHO•MULTI button on the remote to select a mode.
2. If side-by-side mode or picture-in-picture mode has been selected, use the left/right arrow buttons to position the subscreen as shown below.

Side-By-Side

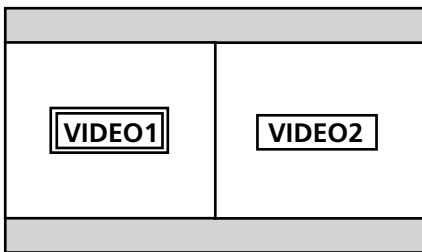

Side-by-side 1:
VIDEO1 is the active picture.

Picture-in-Picture

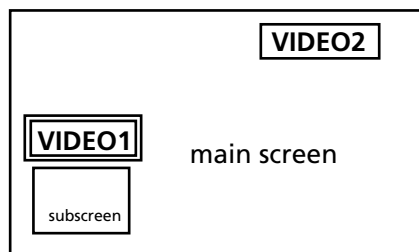

Picture-in-picture
(window on the left):
VIDEO1 is the active picture.

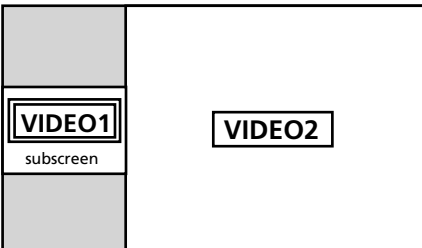

Side-by-side 2:
VIDEO1 is the active picture.

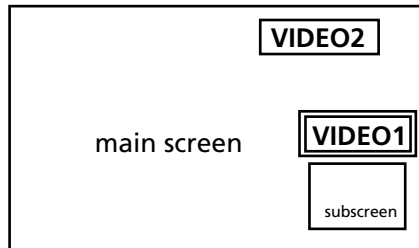

Picture-in-picture
(window on the right):
VIDEO1 is the active picture.

3. The active picture (indicated in the above illustrations by the double box) is the picture that is affected by remote actions and menu selections. To switch the active picture, press the OK button. Press the OK button again to change back to the other picture.

Note: Changing the active picture doesn't change the size or location of the pictures.

The Menu System

Selecting the Input Signals to be displayed

To change the input signals displayed in multiscreen operations:

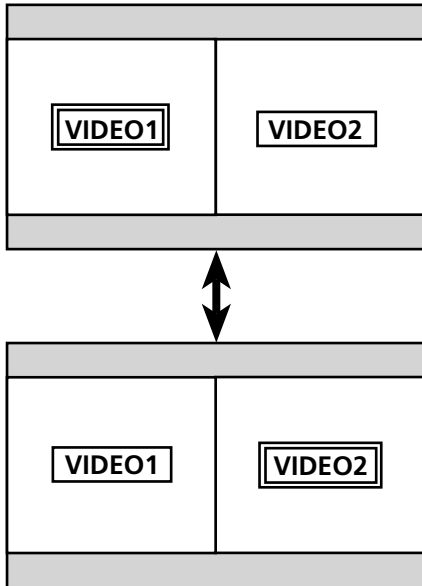

1. Press the MULTI button to activate the Multiscreen function. Press the OK button to make the desired picture active.
2. Press the RGB, VIDEO or CMPNT button to change the input signal. The INPUT•GO BACK button on the front of the monitor can also be used to change input selection.

The top screen shows VIDEO1 as the active picture. The bottom screen shows VIDEO2 as the active picture.

On-Screen Menu Operation

To access the main menu, press the MENU button on the remote. The MAIN MENU is displayed on the screen. The main menu contains a list of all the menus that control your monitor. To select a menu, use the up/down arrow buttons on the remote to highlight the desired menu. When the desired menu is highlighted, press the OK or MENU button to select.

Note: Different components use different types of input (RGB, video, etc). Some menu options apply to only one type of input, so they only appear when they apply to the currently active input. For example, the COLOR and TINT options in the PICTURE QUALITY menu only appear when you are adjusting standard video input (VIDEO1, VIDEO2, VIDEO3).

The Picture Quality Menu

Setting the Picture Mode with the PRESETS Option

The monitor has preset viewing modes that can be selected depending on your viewing environment. Each preset mode has the contrast, brightness and sharpness adjusted for a specific viewing situation.

- MEMORY – This mode allows you to set and save your own picture adjustments.
- SOFT – Use this mode when watching your Monitor in a dark room. Soft mode provides a darker, finer picture, like the screen in movie theaters. These settings are preset for you and can't be changed.
- BRIGHT – Use this mode when watching your monitor in a bright room. This mode provides a picture with distinct differences between light and dark areas. These settings are preset for you and can't be changed.
- NORMAL – The factory default.

To change the picture mode:

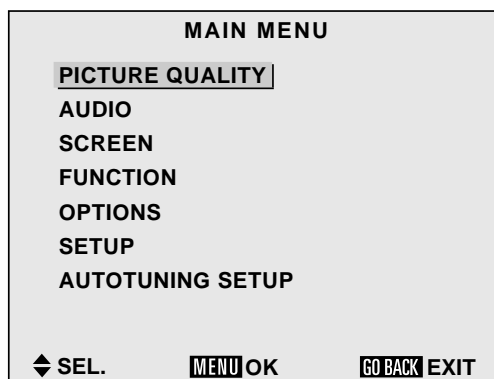

This is the main menu with the PICTURE QUALITY option highlighted. Press OK to bring up the highlighted menu.

1. From the main menu, select PICTURE QUALITY The PICTURE QUALITY Menu will appear
2. Highlight the PRESETS option and press the ► key on the remote to select it. The PRESETS window appears.
3. Use the ► button on the remote to select the desired mode. The mode switches as follows when the ► button is pressed:

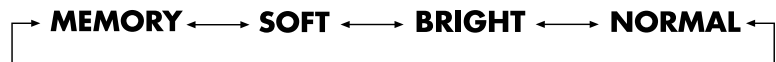

Note: If you don't push the ► button within 5 seconds, the current selection is set and the previous screen reappears.

Once you've selected the desired mode, press OK or MENU. The picture mode is now set and you are returned to the PICTURE QUALITY screen. If you are using MEMORY mode, you can manually adjust the picture settings (contrast, black level, and sharpness). You can continue adjusting settings in the PICTURE QUALITY menu, return to the main menu, or exit the menu system.

To return to the main menu, press the GO BACK button on the remote. To exit the menu system, press CLEAR.

The Menu System

Adjusting the Picture Settings in MEMORY Mode

In MEMORY mode, you can set and save the following picture adjustments:

CONTRAST – Changes the picture's contrast (between light and dark).

BLACK LEVEL – Makes the picture lighter or darker

SHARPNESS – Changes the picture's sharpness.

COLOR – Changes color density (video input only).

TINT – Changes picture tint (video input only).

COLOR TEMP – Changes the color tone.

NOISE REDUCE – (noise reduction)– Removes extraneous information from the signal to make the picture clearer.

NOTE: Only the contrast and brightness can be adjusted when a computer signal is used.

Once you have selected MEMORY mode, you can adjust the picture settings. For example, to change the contrast setting:

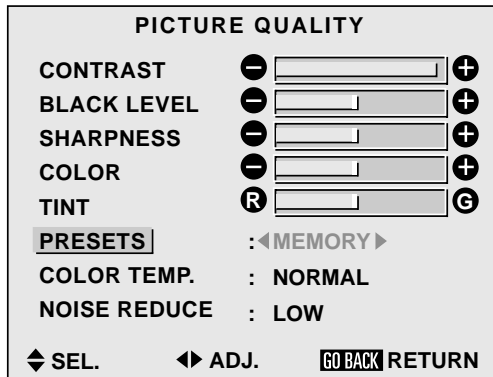

This is the PICTURE QUALITY menu with the PRESETS option highlighted.

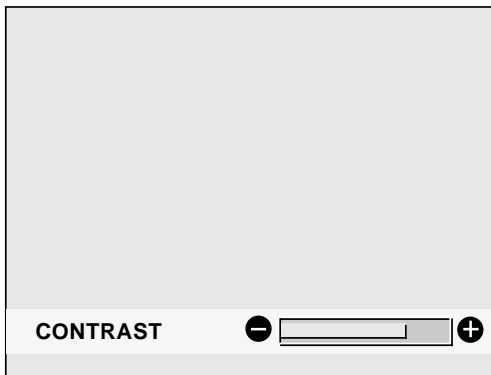

This is the CONTRAST screen.

1. Use the ▲ or ▼ button to highlight the CONTRAST option. Press the ► button to select it. The CONTRAST window appears. Use ◀ and ▶ buttons to adjust the contrast.
NOTE: If you don't push the ◀ or ▶ button within 5 seconds, the current setting is accepted and the previous screen reappears.
2. Once the contrast is adjusted, press OK or MENU. The contrast is set and you are returned to the PICTURE QUALITY menu.
3. Use the same procedure to adjust the black level and sharpness settings.
4. When you are finished adjusting the picture settings, press GO BACK to return to the main menu or press CLEAR to exit the menu system.

If the "CONTROL NOT AVAILABLE" message appears when you are trying to change the picture settings, make sure the preset mode is set to MEMORY. You can only change picture settings in MEMORY mode. The other modes are pre-set and can't be changed.

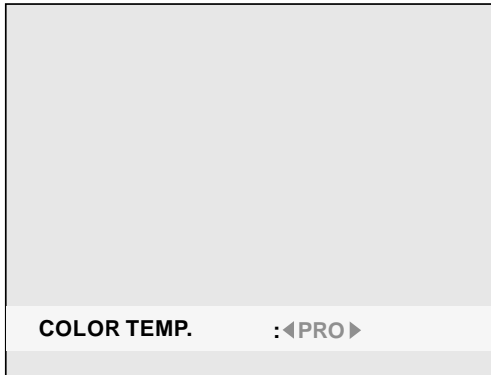

This is the COLOR TEMP. screen with PRO as the current selection.

Setting the Color Temperature

The color temperature setting controls how warm (red) or cool (blue) your picture is. The COLOR TEMP option has 4 settings:

Normal

Warm

Pro (lets you select settings individually)

Cool

For regular viewing, Normal, Warm or Cool is recommended. The PRO setting is generally used only for professional applications. To change the COLOR TEMP setting:

1. From the main menu, highlight and select the PICTURE QUALITY menu.
2. Use the arrow buttons on the remote to highlight the COLOR TEMP option. Press the ► button to select it. The COLOR TEMP screen appears.
3. Use the ◀ and ▶ buttons to select the desired COLOR TEMP setting. The settings switch as follows:

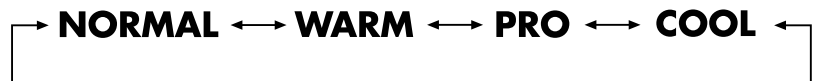

NOTE: If you don't push the ◀ or ▶ button within 5 seconds, the current setting is accepted and the previous screen reappears.

4. Once the desired color temp is selected, press OK or MENU. If you choose the PRO setting, the WHITE BALANCE screen appears. It allows individual setting of white and dark balance for each color (red, green and blue).

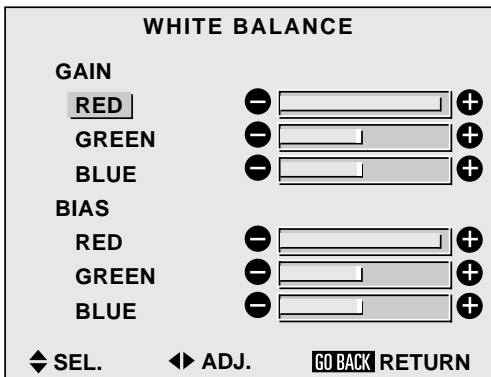

This is the WHITE BALANCE screen with the RED GAIN option highlighted.

GAIN This adjusts the color balance for light/bright colors.

BIAS This adjusts the color balance for dark colors.

To change the white balance GAIN setting:

1. Highlight the RED, GREEN or BLUE GAIN option and press the ► button. The GAIN screen for that color appears.
2. Adjust the balance using the ◀ and ▶ keys.

NOTE: If you don't push the ◀ or ▶ button within 5 seconds, the current setting is accepted and the previous screen reappears.

3. When you have the desired setting, press OK or MENU. The GAIN is adjusted and you are returned to the WHITE BALANCE screen.
4. When you completed all the desired white balance adjustments, Press the GO BACK button to return to the PICTURE menu. You can continue adjusting picture settings, return to the main menu or press CLEAR to exit the menu system.

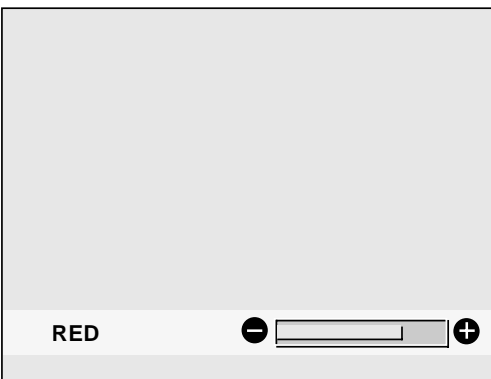

This is the R-GAIN (red gain) screen.

The Menu System

Reducing Noise in the Picture

Noise is a term used to describe extraneous bits of information in the signal that affect the clearness of the picture. You can use the Noise Reduction (NOISE REDUCE) setting if your reception is poor or when playing video tapes that have poor picture quality.

The NOISE REDUCE option has four settings, including OFF. The higher the setting, the stronger the effect. The settings switch as follows when the **▶** button is pressed:

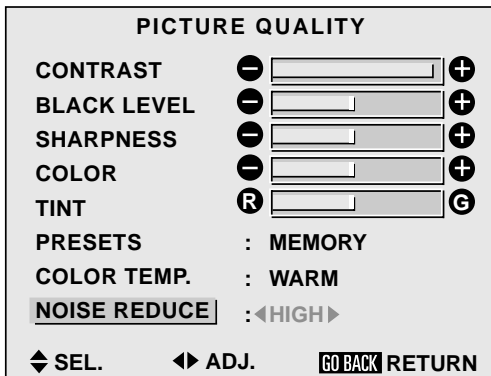
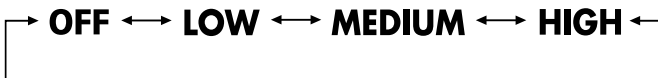

This is the PICTURE QUALITY menu with the NOISE REDUCE (noise reduction) option highlighted.



This is the NOISE REDUCE (noise reduction) screen.

To change the noise reduction setting:

1. From the PICTURE QUALITY menu, highlight the NOISE REDUCE option, and select it by pressing the **▶** button. The NOISE REDUCE SCREEN is displayed.
2. Use the **◀** and **▶** buttons to select the desired noise reduction setting.

NOTE: If you don't push the **◀** or **▶** button within 5 seconds, the current setting is accepted and the previous screen reappears.

3. When the desired setting is displayed, press OK to return to the PICTURE QUALITY menu. You can continue adjusting picture settings, return to the main menu, or press CLEAR to exit the menu system.

The Audio Menu

The AUDIO menu allows you to adjust the treble, bass and left/right balance of your external speakers.

BASS – Changes the level of low frequency sound.

TREBLE – Changes the level of high frequency sound.

BALANCE – Changes the balance of the left and right speakers.

Menu Operations

To access the AUDIO menu:

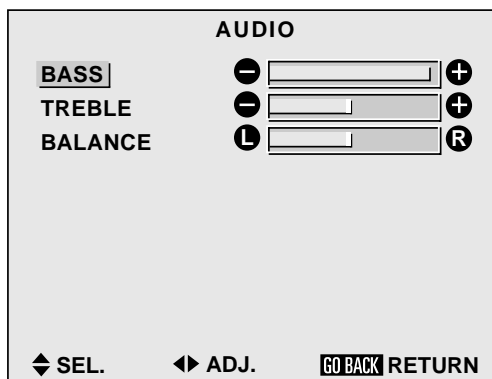

This is the AUDIO menu with the BASS option highlighted. Press the right arrow button to select it.

1. From the main menu, highlight and select the AUDIO option. The AUDIO menu is displayed.
2. Use the ▲ and ▼ arrow buttons on the remote to highlight an option (for example, BASS).
3. Use the ◀ and ▶ buttons to adjust to the desired setting.
4. You can continue adjusting audio settings, press GO BACK to return to the main menu, or press CLEAR to exit the menu system.

The Menu System

The Screen Menu

The SCREEN menu allows you to set the monitor to automatically select the correct mode for viewing a particular movie and to change the positions of on-screen menus.



Fill



Normal



Full



Stadium

Selecting a Viewing Size

When viewing with a component *other than your HD receiver**, you can set the screen mode to one of four screen sizes to suit the type of input you are watching. Select the screen mode with the CINEMA button on the remote control. The screen sizes are as follows:

FILL expands in both vertical and horizontal directions while the correct proportions are maintained. The picture is not distorted, just closer

NORMAL displays a picture with a 4:3 aspect ratio (standard video). Because this mode fills the screen vertically, but not horizontally, black bars will appear on the right and left sides of the picture.

Note: If viewing with a 4:3 aspect ratio for long periods of time, set side gray level at 3 or 4.

FULL expands the picture in the horizontal direction only. This option corrects the aspect ratio of images that have been compressed or horizontally “squeezed.”

STADIUM expands in both the horizontal and vertical directions, but varies the amount of stretch depending on the picture – the center of the picture is almost normal while the edges are considerably expanded. This mode is intended for watching video with a 4:3 aspect ratio on a wide screen.

Note: In Stadium mode, only the V-position and H-position are displayed. You can't change the height and width.

To change the viewing size:

1. Press the CINEMA button on the remote control.
2. The current viewing size will be displayed. Press the CINEMA button again to switch to the next size. The size switches as follows:

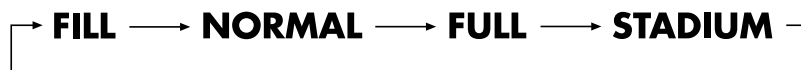

***Note: When viewing with an HD receiver, use the receiver's screen format selections to set the proper ratio.**

Adjusting the Picture Position and Size

The SCREEN menu lets you adjust the position and size of the picture.

The first two options, V-POSITION and H-POSITION, adjust the placement of the picture on the screen. For example, if the picture is too far to the left, you can use the H-POSITION to move it to the right. To adjust the position of the picture on the screen:

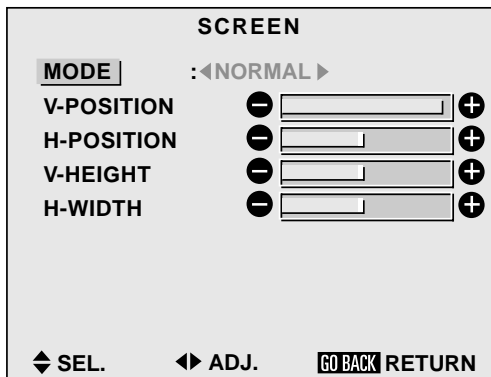

The SCREEN menu with the MODE option highlighted.

1. From the main menu, highlight and select the SCREEN option. The SCREEN menu is displayed.
2. Use the ▲ and ▼ buttons to select the mode you want to change.
3. When the desired mode is highlighted, press the ► button. The selected mode screen will be displayed.

Use the arrow buttons to adjust the position of the picture.

NOTE: If you don't push the an arrow button within 5 seconds, the current setting is accepted and the previous screen reappears.

4. When you've adjusted to the desired setting, press the GO BACK button on the remote to return to the SCREEN menu.

The V-HEIGHT and H-WIDTH options expand and contract the size of the picture to fill the screen. For example, if the picture is slightly wider than the screen, you can use the H-WIDTH option to shrink the picture horizontally.

Note: These options are not available in STADIUM mode.

To adjust the screen size:

1. Select the desired option from the screen menu and press the ► button. The selected mode window will be displayed.

2. Use the arrow buttons to adjust the size of the picture.

NOTE: If you don't push an arrow button within 5 seconds, the current setting is accepted and the previous screen reappears.

3. When you've adjusted to the desired setting, press OK to select and return to the SCREEN menu.

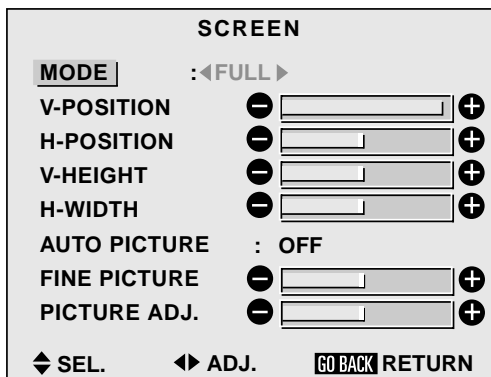

The AUTO PICTURE option only appears if you have a computer connected.

Auto Picture

The AUTO PICTURE function appears in the SCREEN menu only if you have a computer connected to the monitor. When this feature is turned on, it automatically adjusts flickering and striped patterns in a computer image. If you want to adjust these manually:

1. Select the AUTO PICTURE option from the SCREEN menu. Press the ► button to turn AUTO PICTURE off. When AUTO PICTURE is turned off, the FINE PICTURE and PICTURE ADJ. options are displayed beneath it.
2. Select an option and press the ► button. The screen for that option will be displayed. Use the ◀ and ► buttons to adjust that option. Press OK to return to the SCREEN menu.

The Menu System

The Function Menu

The FUNCTION menu contains options that control on-screen displays (other than the menu system) and how the picture is displayed.

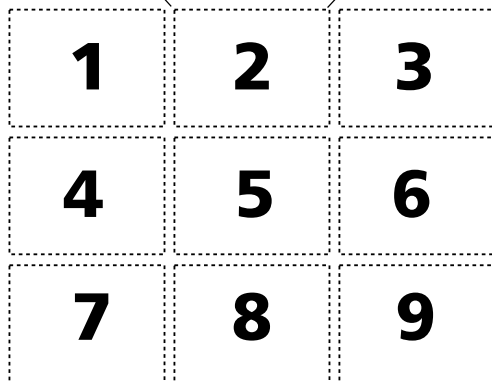
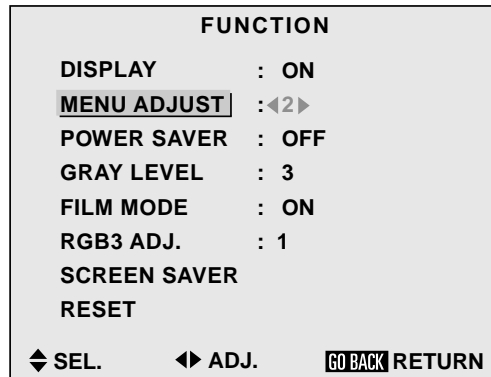
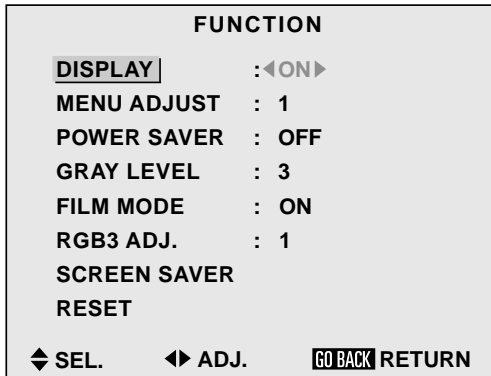

The number 2 position will display on-screen menus in the top center of your screen.

On-Screen Displays

On-screen displays (different than the menu system) appear by default to give you information about an option you have selected. For example, When you switch inputs the currently selected input name (for example, CMPNT1) is displayed on the screen. To turn on-screen displays off:

1. From the main menu, highlight and select the FUNCTION option. The FUNCTION menu is displayed.
2. Highlight and select the DISPLAY option. Use the ► button to toggle on-screen displays on or off.

Note: Turning the DISPLAY option off does not affect on-screen menus. Menus can't be turned off.

3. You can continue setting options in the FUNCTION menu, press GO BACK to return to the main menu, or press CLEAR to exit the menu system.

Adjusting the Position of the Menu Display

The on-screen menus can be displayed in different positions on the screen. There are a total of nine possible positions shown in the grid on the right.

To adjust the position of the on-screen menus:

1. From the main menu, highlight and select the FUNCTION option. The FUNCTION menu is displayed.
2. Highlight and select the MENU ADJUST option. Use the ► button to scroll through the menu positions. As you press the ► button, the menu will move around to the different positions.
3. When you have the menu in the desired position you can press the ▲ or ▼ arrow to select another option in the FUNCTION menu, press GO BACK to return to the main menu, or press CLEAR to exit the menu system.

FUNCTION	
DISPLAY	: ON
MENU ADJUST	: 1
POWER SAVER	: ON
GRAY LEVEL	: 3
FILM MODE	: ON
RGB3 ADJ.	: 1
SCREEN SAVER	
RESET	
◆ SEL.	◀ ADJ. GO BACK RETURN

This is the FUNCTION menu with the POWER SAVER option highlighted.

Setting the POWER SAVER for Computer Images

The POWER SAVER function can be used when the signal source to the monitor comes from a computer conforming to the VESA DPMS format. This function automatically reduces the monitor's power consumption if no operation is performed for a certain amount of time. POWER SAVER can be turned on or off.

If the computer's power isn't turned on or if the computer and selector tuner are not properly connected, POWER SAVER is set to OFF.

For instructions on using the computer's power management function, see your computer's operating manual.

To turn the monitor's POWER SAVER function on or off:

1. From the main menu, highlight and select FUNCTION. The FUNCTION menu is displayed.
2. Highlight the POWER SAVER option.
3. Use the ► button to toggle the setting ON or OFF.
4. You can continue making adjustments in the FUNCTION menu, return to the previous menu by pressing the GO BACK button or press CLEAR to exit the menu system.

The POWER/STANDBY indicator shows the status of the POWER SAVER function. See below for status and description.

POWER/STANDBY indicator

POWER SAVER Mode	POWER/STANDBY indicator	Power Saver Operating Status	Description	Turning the Picture Back On
On	Green	Not activated	Horizontal and vertical synchronizing signals are present from the computer.	Picture already on.
Standby	Yellow	Activated	No horizontal synchronizing signals are present from the computer.	Use the keyboard or mouse. The picture reappears immediately.
Suspend	Red	Activated	No vertical synchronizing signals are present from the computer.	Use the keyboard or mouse. The picture reappears, but more slowly than when in standby mode.
Off	Red	Activated	No horizontal and vertical synchronizing signals are present from the computer.	Use the keyboard or mouse. The picture reappears, but more slowly than when in either standby or suspend mode.

FUNCTION	
DISPLAY	: ON
MENU ADJUST	: 1
POWER SAVER	: OFF
GRAY LEVEL	:◀9▶
FILM MODE	:ON
RGB ADJ.	:1
SCREEN SAVER	
RESET	
◆ SEL.	◀ ADJ. GO BACK RETURN

This is the FUNCTION menu with the GRAY LEVEL option highlighted.

NOTE: Repeated watching with the gray level set to black may effect the quality of your picture. To reduce the effects of uneven phosphor aging, set the gray level to 3 or 4.

If viewing with a 4:3 aspect ratio for long periods of time, set side gray level at 3 or 4.

FUNCTION	
DISPLAY	: ON
MENU ADJUST	: 1
POWER SAVER	: OFF
GRAY LEVEL	: 3
FILM MODE	:◀ON▶
RGB3 ADJ.	: 1
SCREEN SAVER	
RESET	
◆ SEL.	◀ ADJ. GO BACK RETURN

This is the FUNCTION menu with the FILM MODE option highlighted.

Setting the Gray Level for the Sides of the Screen

The GRAY LEVEL function allows you to set the gray level for the sides of the screen where nothing is displayed (on the left and right sides of the screen when it is set to 4:3 size). The level can be adjusted from 0 to 15. The factory setting is 3 (dark gray).

NOTE: Repeated watching with the gray level set to black may effect the quality of your picture. To reduce the effects of uneven phosphor aging, set the gray level to 3 or 4.

To adjust the gray level for the sides of the screen:

1. From the main menu, highlight and select FUNCTION. The FUNCTION menu is displayed.
2. Highlight the GRAY LEVEL option.
3. Use the ▶ button to scroll through the levels.
4. When the desired gray level is highlighted, press the ◀ button to return to the FUNCTION menu options. You can continue making adjustments within the FUNCTION menu, press GO BACK to return to the previous menu or press CLEAR to exit the menu system.

Adjusting for Flickering with Film Mode

There is some amount of flickering that occurs in an image when it is transferred from film to video.

ON All images are displayed in film mode.

OFF Film mode is off.

To turn FILM MODE ON:

1. From the main menu, highlight and select FUNCTION. The FUNCTION menu is displayed.
2. Highlight the FILM MODE option.
3. Use the ▶ button to scroll through the three modes until ON is displayed.
4. Press the ◀ button to return to the FUNCTION menu options. You can continue making adjustments within the FUNCTION menu, return to the previous menu by pressing GO BACK or press CLEAR to exit the menu system.

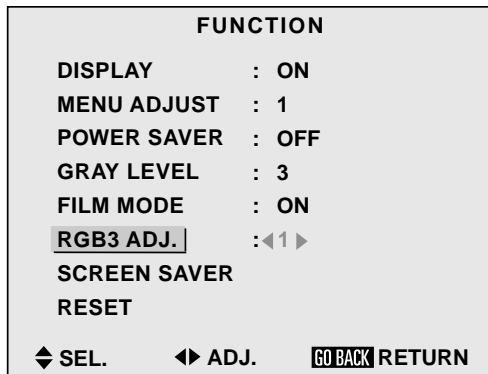

This is the FUNCTION menu with the RGB3 ADJ. option highlighted.

Adjusting the Monitor in RGB3 Input Mode

If the picture is not stable in RGB3 mode, use the RGB3 ADJUST feature to adjust it.

1. From the main menu, highlight and select OPTIONS. The OPTIONS menu is displayed.
2. Highlight the RGB3 ADJUST option.
3. Use the ▶ button to select the desired adjustment (1, 2 or 3). The choices scroll as follows:

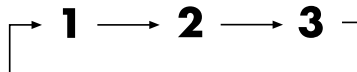

4. When the desired number is selected, press the ◀ button to return to the FUNCTION menu items. You can continue making adjustments within the FUNCTION menu, press GO BACK to return to the previous menu or press MENU or CLEAR to exit the menu system.

Note: When AUTO PICTURE is on, switch it off and back on again to return the display position to its original position.

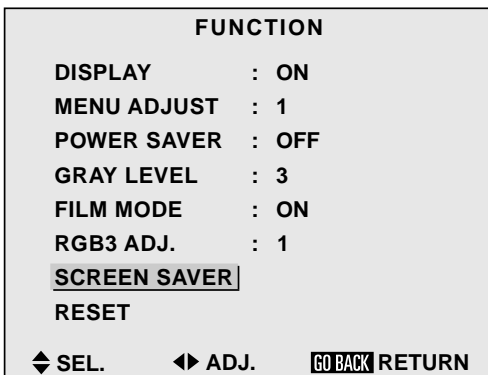

This is the FUNCTION menu with the SCREEN SAVER option highlighted.

Setting the SCREEN SAVER

The SCREEN SAVER option contains three features in one. These features are used principally for PC operation.

The PLE (Peak Luminance Enhancement) function sets the luminance level to a fixed mode to reduce the effects of phosphor aging.

The ORBITER (Peak Luminance Enhancement) moves the image around the screen intermittently to reduce the effects of phosphor aging.

The INVERSE function works in RGB mode only. INVERSE inverts the video signal, playing the image in a negative format.

Setting the PLE

PLE has two options:

AUTO – luminance level (contrast) is normal.

LOCK – dims picture to reduce phosphor aging.

The factory setting is AUTO. Setting the PLE option to LOCK dims the picture – the contrast will be lower than normal.

To set the PLE level to LOCK:

1. From the main menu, highlight and select FUNCTION. The FUNCTION menu is displayed.
2. Highlight the PLE option.
3. Use the ▶ button to select LOCK.
4. Press the ◀ button to return to the FUNCTION menu options. You can continue making adjustments within the FUNCTION menu, return to the previous menu or press MENU or CLEAR to exit the menu system.

Setting PLE to LOCK is recommended if you are displaying stationary pictures.

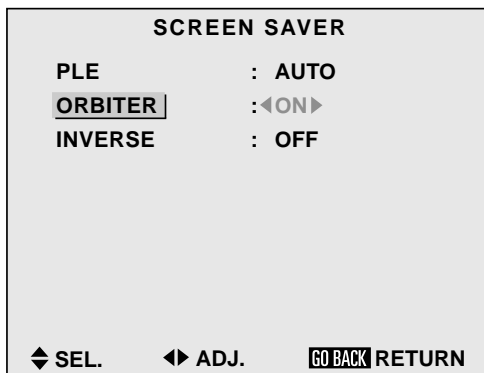

This is the SCREEN SAVER menu with the ORBITER option highlighted.

Turning ORBITER on

The factory setting for ORBITER is OFF To turn ORBITER ON:

1. From the main menu, highlight and select FUNCTION. The FUNCTION menu is displayed.
2. Highlight the SCREEN SAVER option (the SCREEN SAVER menu is displayed).
3. Highlight the ORBITER option.
4. Use the ► button to select ON.
5. Press the ◀ button to return to the FUNCTION menu options. You can continue making adjustments within the FUNCTION menu, return to the previous menu or press MENU or CLEAR to exit the menu system.

Setting the INVERSE

INVERSE has three options:

ON – The picture is alternatively displayed as a positive and negative image.

OFF – INVERSE is off.

WHITE – The screen turns white.

The factory setting is OFF To change the INVERSE mode:

1. From the main menu, highlight and select FUNCTION. The FUNCTION menu is displayed.
2. Highlight and select the SCREEN SAVER option.
3. Highlight the INVERSE option.
4. Use the ► button to select your choice.
5. Press the ◀ button to return to the FUNCTION menu options. You can continue making adjustments within the FUNCTION menu, return to the previous menu or press MENU or CLEAR to exit the menu system.

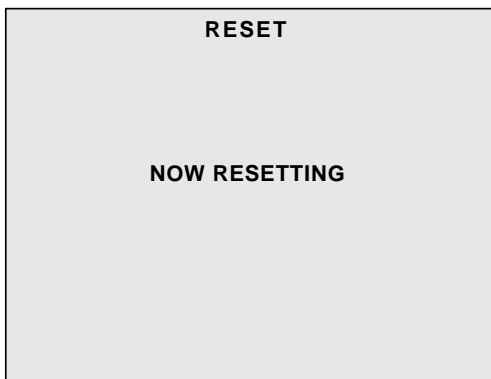
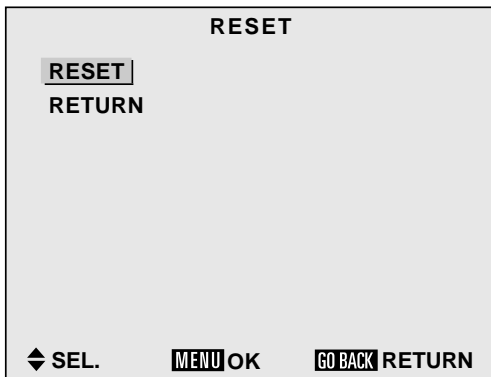

These are the RESET screens. Choose the RESET option if you want to reset ALL options in all menus back to the factory default.

Resetting to Default Values

The RESET function allows you to reset *all* adjustments to the factory default settings. **Caution: this will reset *all* adjustments you have made in *all* menus, including autotuning configuration settings.**

To reset to the factory default settings:

1. From the main menu, highlight and select FUNCTION. The FUNCTION menu is displayed.
2. Highlight the RESET function and press OK.
3. The RESET screen is displayed.
4. Use the ▲ or ▼ button to highlight the RESET option and press OK or MENU. The RESET screen will display the message NOW RESETTING. When the settings are restored to the factory default you are returned to the RESET screen.

When you are done, press GO BACK to return to the FUNCTION menu or press CLEAR to exit the menu system.

The Options menu

Setting the Audio Inputs

The monitor's audio sources are programmable to each of the monitor's video sources. For example, you can program AUDIO1 source to work with the RGB2 video source.

This feature is generally used only for commercial applications.

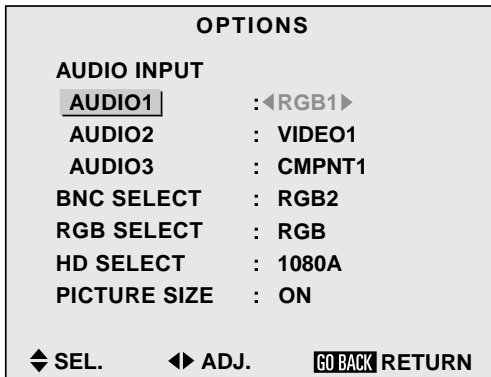

This is the OPTIONS menu with the AUDIO1 input option highlighted.

1. From the main menu, highlight and select OPTIONS. The OPTIONS menu is displayed.
2. Highlight the one of the audio input options.
3. Use the ► button to scroll through the available video sources. The modes scroll as follows:

→ VIDEO1 → VIDEO2 → VIDEO3 → CMPNT1 → RGB1 → RGB2 → RGB3 →

4. When the desired mode is selected, press the ◀ button to return to the OPTIONS menu items. You can continue making adjustments within the OPTION menu, press GO BACK to return to the previous menu or press MENU or CLEAR to exit the menu system.

The factory defaults are as follows:

- AUDIO1 – VIDEO1
- AUDIO 2 – CMPNT1
- AUDIO3 – RGB1

If you use the reset option in the FUNCTION menu, the settings will return to the factory default settings listed above.

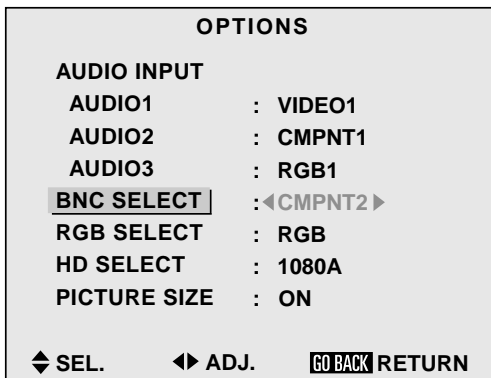

This is the OPTIONS menu with the BNC SELECT option highlighted.

Setting the BNC Connectors

If the component you are connecting to the monitor doesn't have composite video jacks, you can set the BNC inputs to act as component video inputs.

1. From the main menu, highlight and select OPTIONS. The OPTIONS menu is displayed.
2. Highlight the BNC SELECT option.
3. Use the ► button to toggle between RGB2 (composite) and CMPNT2. (component).
4. Once you've selected the desired setting, press the ◀ button to return to the OPTIONS menu items or press CLEAR to return to the main menu.

Setting a Computer Image to the Correct RGB Select Mode

The RGB SELECT function allows you to select the correct viewing mode for the type of computer image you are displaying.

The RGB SELECT function has six modes:

AUTO – Automatically selects the most suitable mode for displaying the input signal.

STILL – Use this mode to display VESA standard signals (still image from a computer).

MOTION – Use this mode for moving images from a computer. Converts the signal to RGB signal for best viewing.

WIDE1 – Prevents horizontal compression when the input signal is 852 dot X 480 line signal with a horizontal frequency of 31.7kHz.

WIDE2 – Prevents horizontal compression when the input signal is 848 dot X 480 line signal with a horizontal frequency of 31.0kHz.

DTV – This mode is primarily used to optimize picture quality if you are using a generic-brand DTV receiver which outputs signal at 480P (progressive scan) lines.

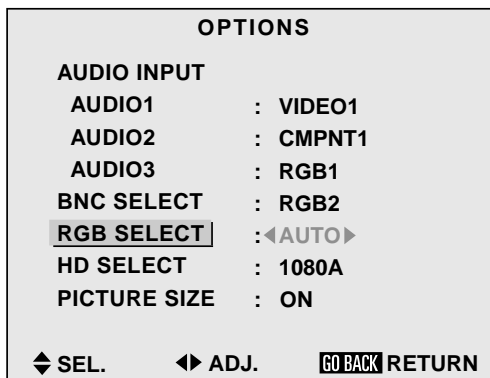

This is the OPTIONS menu with the RGB SELECT option highlighted.

To change the RGB SELECT mode:

1. From the main menu, highlight and select the OPTIONS menu. The OPTIONS menu is displayed.
2. Highlight the RGB SELECT option.
3. Use the ► button to scroll through the mode choices. The settings switch as follows:

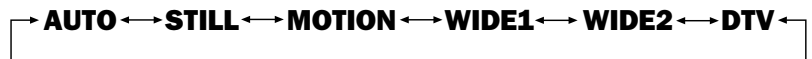

4. When the desired mode is selected, press the ◀ button to return to the OPTIONS menu items. You can continue making adjustments within the OPTIONS menu, press GO BACK to return to the previous menu or press CLEAR to exit the menu system.

The Menu System

Setting the Monitor to the correct HD Receiver Mode

The HD SELECT function allows you to select the correct mode for the monitor to work with your HD receiver. The default setting is 1080A. This is the correct setting for all RCA and PROSCAN HD receivers. If you have another brand of HD receiver, your picture may appear broken or off-center. If so, you need to switch HD SELECT modes.

1080A – Use this option for RCA or PROSCAN HD receivers.

1080B – Use this option if you have any other brand of HD receiver.

To change the receiver mode:

1. From the main menu, highlight and select OPTIONS. The OPTIONS menu is displayed.

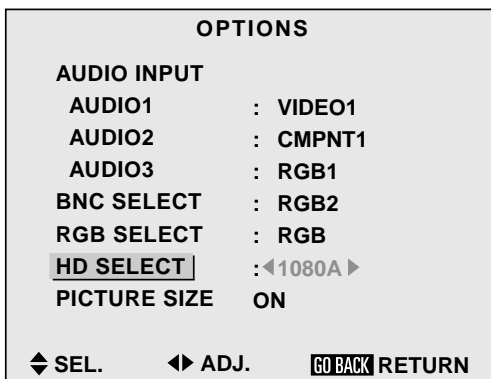

This is the OPTIONS menu with the HD SELECT option highlighted.

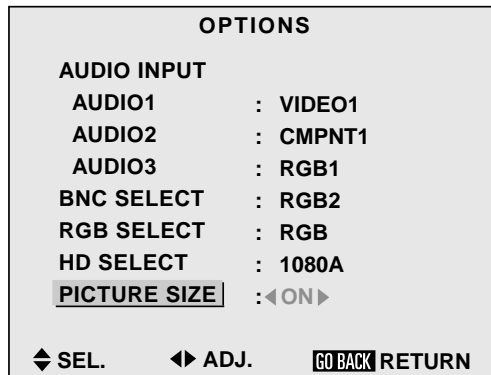

This is the OPTIONS menu with the PICTURE SIZE option highlighted.

2. Highlight the HD SELECT option.
3. Use the ► button to select the desired mode (1080 A or 1080 B).
4. When the desired number is selected, press the ◀ button to return to the OPTIONS menu items. You can continue making adjustments within the OPTIONS menu, press GO BACK to return to the previous menu or press MENU or CLEAR to exit the menu system.

Setting the Picture Size for RGB Input

The PICTURE SIZE option is used to adjust the picture size when the input signal is RGB. Use this feature for graphic arts and checking photos. In TRUE mode, there is no distortion of the picture. In NORMAL mode, the picture will be scaled vertically but will keep the correct aspect ratio.

ON – When the picture size option is on and in NORMAL mode, the picture is scaled to fill the screen vertically while horizontally keeping the correct aspect ratio. In FULL mode, the horizontal will be scaled to fit the screen.

OFF – When the picture size option is off, TRUE mode displays the picture pixel-for-pixel, exactly the size of the image. If FULL mode, the image is scaled to fit the screen.

Note: When using a DTC100 HD receiver, the only available mode is FULL. The picture will be scaled to fill the screen.

The Setup Menu

The SETUP menu controls the way your monitor communicates.

Confirming the Frequencies, Polarities, Mode and Resolution of Input Signals

The FREQUENCY function is used to confirm the frequencies, polarities, mode and resolution of the signals coming from a computer.

To confirm frequencies, polarities, mode and resolution:

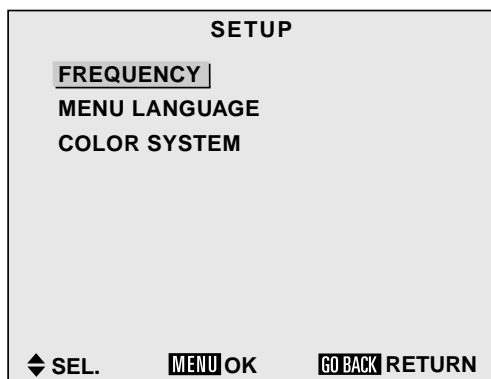

1. From the main menu, highlight and select the SETUP option. The SETUP menu is displayed.
2. Highlight the FREQUENCY option and press OK.
3. The FREQUENCY screen is displayed.

Press GO BACK to return to the SETUP menu, or press CLEAR to exit the menu system.

This is the SETUP menu with the FREQUENCY option highlighted.

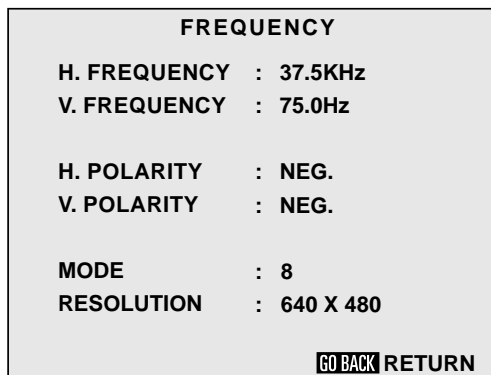

This is the FREQUENCY screen.

The Menu System

Selecting the Language for the Menus

The menu display can be set to one of the languages: English, French or Spanish. The default is English. To change the default setting:

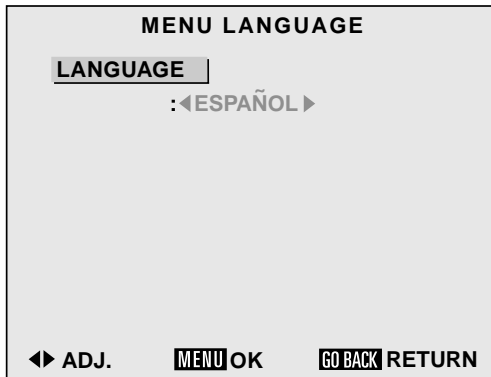

This is the MENU LANGUAGE screen with Spanish as the selected language.

1. From the main menu, highlight and select the SETUP option. The SETUP menu is displayed.
2. Highlight the MENU LANGUAGE option. The MENU LANGUAGE screen is displayed.
3. Use the ► button to scroll through the language choices. The settings switch as follows:

→ ENGLISH ↔ FRANÇAIS ↔ ESPAÑOL ←

4. When the desired language is highlighted, press GO BACK to return to the SETUP menu. You can continue making adjustments within the SETUP menu, press GO BACK to return to the main menu, or press CLEAR to exit the menu system.

Setting the Video Signal Format

The COLOR SYSTEM option is used to set the video signal format. Different countries used different formats for video signals. The AUTO option automatically detects the correct video signal and sets the correct format. This setting should not be changed.

The Autotuning Menu

Autotuning the Component buttons on the Remote Control

The AUTOTUNING feature lets you easily program the component buttons on the remote to operate the components hooked up to the monitor. To autotune your components to the buttons on the remote:



This is the AUTOTUNING SETUP menu with the DVD BUTTON option highlighted.

1. From the main menu, highlight and select the AUTOTUNING SETUP option. The AUTOTUNING SETUP menu is displayed.
2. Highlight an option which corresponds to a component which you've connected. For example, if you have a DVD player connected, highlight the DVD BUTTON option.
3. Use the ► button to scroll through the output choices. Select the choice which corresponds to the jacks you used to connect the DVD player. In the example illustration on the right, the DVD button on the remote will operate the component connected to the CMPNT1 jacks (the DVD player).
4. When the desired option is displayed, press the ◀ button to return to the AUTOTUNING menu options. You can continue making adjustments within the OPTIONS menu, press GO BACK to return to the previous menu or press CLEAR to exit the menu system.

Sleep Timer

The sleep timer is a feature that allows you to set the monitor to turn off after a prescribed amount of time. It can be set to turn the power off after 30, 60, 90 or 120 minutes.

Setting the Sleep Timer

1. Press the SLEEP button on the remote to turn on the timer. The default is 30 minutes.
2. Press the SLEEP button again to move to the next time increment. Press the SLEEP button until you get to the desired time.

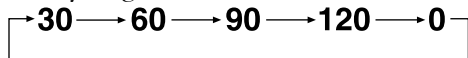

3. The timer starts when the Sleep display disappears from the screen.

To check the Remaining Time:

1. Once the sleep timer has been set and the menu has turned off, press the SLEEP button once.
2. The remaining time is displayed, then disappears after a few seconds.
3. When five minutes remain, the remaining time appears until it reaches zero.

Cancelling the Sleep Timer

1. Press the SLEEP button twice in a row.
2. The sleep timer is canceled.

NOTE: After the power is turned off with the sleep timer, a slight current is still supplied to the monitor. If you do not plan to use the system for a long period of time, turn the power off with the remote or on the unit.

Other Information

Chapter Overview:

- Installation
- Connecting Your PC or Macintosh Computer
- Specifications
- Troubleshooting
- The Menu System
- Supported Resolution
- Limited Warranty
- Accessory Information

Other Information

Installing the Cinema Screen Monitor

IMPORTANT

- This device cannot stand on its own. Be sure to use a stand or original mounting unit.
 - For correct installation and mounting it is strongly recommended to use a trained, authorized Cinema Screen dealer.
- Failure to follow correct mounting procedures could result in damage to the equipment or injury to the installer.
Product warranty does not cover damage caused by improper installation.

Attaching optional mounts or stand to the Cinema Screen monitor

The Cinema Screen monitor can be mounted on the wall using an optional wall mount or you can attach a floor stand (also optional). For more information on mounting your Cinema Screen Display, see your Cinema Screen dealer.

If you choose to use the optional wall mount, it can be attached to the Cinema Screen monitor in one of the following two ways:

- While it is upright.
- While it is laying with the screen face down. If you choose this option, lay the protective sheet that came wrapped around the monitor beneath the screen surface so it doesn't get scratched.

Ventilation requirements for enclosure mounting

To allow heat to disperse, leave space between surrounding objects as shown on the diagram below when installing.

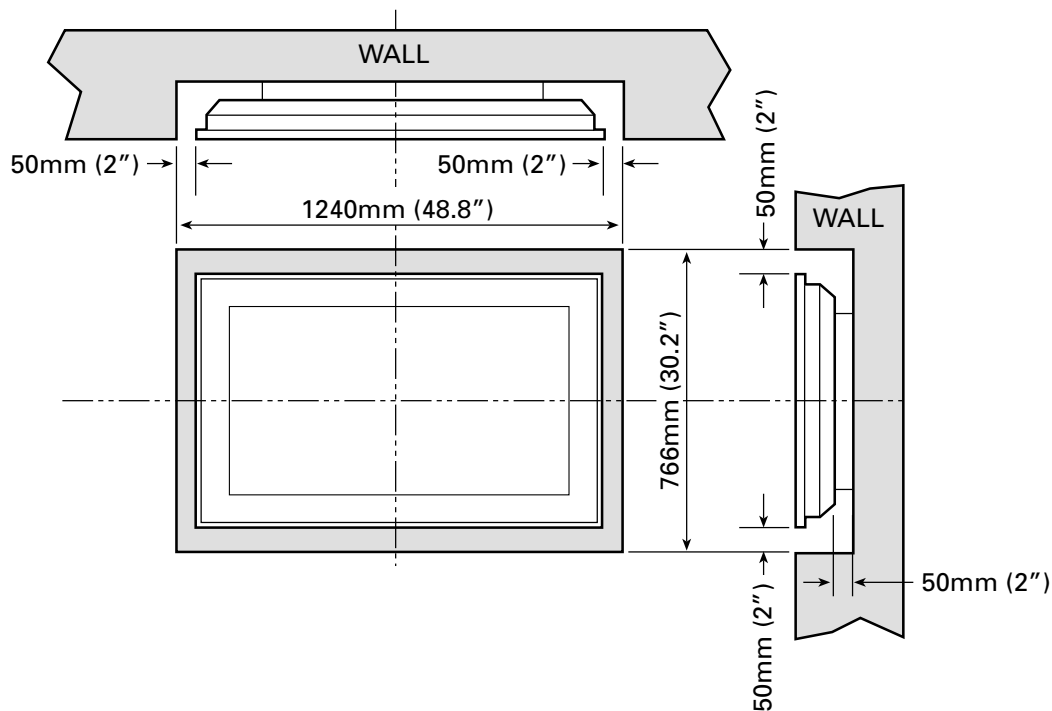

Connecting Your PC Or Macintosh Computer

Connecting your PC or Macintosh computer to your Cinema Screen monitor will enable you to display computer images on the monitor. The Cinema Screen monitor supports the signals described on page 48.

To connect to a PC, Macintosh or compatible graphics adapter:

1. Turn off the power to your monitor and computer.
2. If your PC does not support XGA/SVGA/VGA you will need to install an XGA/SVGA/VGA graphics board. Consult your computer's owner's manual for your SXGA/XGA/SVGA/VGA configuration. If you need to install a new board, see the manual that comes with your new graphics board for installation instructions.
3. The Cinema Screen monitor provides signal compatibility with VESA 1280x1024@60MHz (SXGA). However, we recommend not using this resolution due to image readability on the monitor's 853 X 480 native pixel resolution panel.
4. Use the signal cable that's supplied to connect your PC or Macintosh computer to the Cinema Screen monitor. For Macintosh, you will need a monitor adapter (not supplied) to connect to your computer's video port.
5. Turn on the monitor and the computer.
6. If the Cinema Screen monitor goes blank after a period of inactivity, it may be caused by a screen saver installed on the computer you've connected to the monitor.

When using a Macintosh with the Cinema Screen monitor, the following three display standards are supported using the included Macintosh adapter: 13" fixed mode, 16" fixed mode, and 19" fixed mode. The 13" fixed mode is recommended for the Cinema Screen monitor.

Mini D-sub 15 Pin VGA Signal Composition

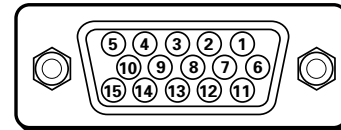

Pin No.	Signal to be connected
1	RED
2	GREEN or sync. on Green
3	BLUE
4	No connection
5	GND
6	RED (GND)
7	GREEN (GND)
8	BLUE (GND)
9	No connection
10	SYNC (GND)
11	No connection
12	SDA
13	H. Sync
14	V. sync
15	SCL

Other Information

Specifications

Product Name	PHD50300 Cinema Screen Monitor
Screen Size	43.5"(H) X 24.5"(V) inches 1106(H) X 622(V)mm diagonal 50"
Aspect Ratio	16 : 9
Resolution	1365(H) X 768(V) pixels
Color Reproduction	256 levels, 16,770,000 colors
Input Signals	RGB, NTSC (3.58 4.43), PAL (B, G, M, N), PAL60, SECAM, HD*1, DVD*1, DTV*
RGB Input terminals	
RGB 1	mini D-sub 15-pin
RGB 2	BNC (R, G, B, H/CS, V) X1
RGB 3	DVI-I 29-pin X 1*2
Video Input terminals	
Video 1	RCA-pin X 1
Video 2	BNC X 1
Video 3	S-Video: DIN 4-pin X 1
DVD/HD/DTV	RCA-pin (Y, P _r [C _r], P _r [C _r])
Audio	Stereo RCA X 3
External Control	D-sub 9-pin X1 (RS-232C)
Sound Output	7W+7W at 6 ohm
Power Supply	AC120V 50/60Hz
Current Rating	5.9A (maximum)
Power Consumption	595W (typical)
Dimensions (WxDxD)	1240 X 766 X 107mm (w/o stand) 48.8 X 30.2 X 4.2 inches (w/o stand) 1240 X 826 X 400mm (with stand)
Net Weight	46 Kg/101.3 lbs. (w/o stand)
Environmental Considerations	
Operating temperature	0°C to 35°C/32°F to 95°F
Humidity	20 to 80%
Altitude	0 to 1900m/0 to 6230 ft.
Storage temperature	-10°C to 50°C/14°F to 122°F
Humidity	10 to 90%
Front Panel User Controls	Power on/off, Input source select Volume up/down/OSD control
Other Features	Power Management, plug and play (DDCI, DDC2b, RGB3: DDC2b only)
Accessories	Remote control with two AA batteries, RGB cable (Mini D-sub 15 pin to Mini D-sub 15-pin connector), power cord, safety metal fitting, screw for safety metal fitting, User's Manual
Regulations	UL approved (UL 1950, CSA 950) DOC Canada requirements Meets FCC class B requirements for home application

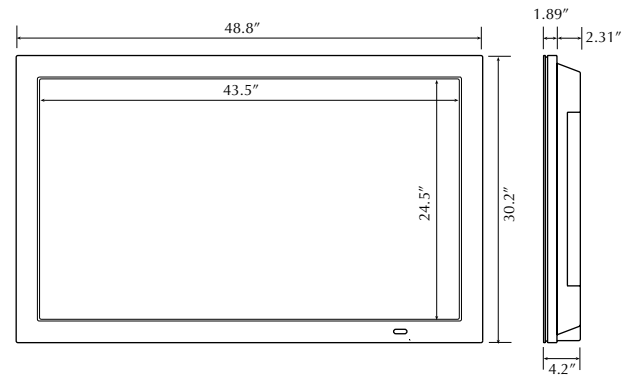

The features and specifications may be subject to change without notice.

* HD/DVD/DTV input signals supported on this system

480P (60 Hz)	480I (60 Hz)
525P (60 Hz)	525I (60 Hz)
625P (60 Hz)	625I (60 Hz)
720P (60 Hz)	720I (60 Hz)
	1080I (60 Hz)

Troubleshooting

Before requesting service, check the adjustments, operations, etc.

Symptom	Possible Problem	Solutions
Picture is disturbed. Sound is noisy. Remote control unit operates erroneously.	<ul style="list-style-type: none"> Is a connected component set directly in front or at the side of the monitor? 	<ul style="list-style-type: none"> Leave some space between the display and connected components.
The remote control does not work.	<ul style="list-style-type: none"> Remote control batteries may be dead. Remote may be in wrong mode. 	<ul style="list-style-type: none"> Replace both batteries with new ones. Press component button for desired component.
Monitor's power does not turn on when the remote control's power button is pressed.	<ul style="list-style-type: none"> Is the monitor's power cord plugged into a power outlet? 	<ul style="list-style-type: none"> Plug the monitor's power cord into a power outlet.
	<ul style="list-style-type: none"> Are all the monitor's indicators off? 	<ul style="list-style-type: none"> Press the power button on the monitor to turn on the power.
Monitor does not operate when the remote control's buttons are pressed.	<ul style="list-style-type: none"> Is the remote control pointed at the monitor, or is there an obstacle between the remote control and the monitor? 	<ul style="list-style-type: none"> Point the remote control at the monitor's remote control sensor when pressing buttons, or remove the obstacle.
	<ul style="list-style-type: none"> Is direct sunlight or strong artificial light shining on the monitor's remote control sensor? 	<ul style="list-style-type: none"> Eliminate the light by closing curtains, pointing the light in a different direction, etc.
	<ul style="list-style-type: none"> Remote control batteries may be dead. 	<ul style="list-style-type: none"> Replace both batteries with new ones.
No sound or picture is produced.	<ul style="list-style-type: none"> Is the monitor's power cord plugged into a power outlet? 	<ul style="list-style-type: none"> Plug the monitor's power cord into a power outlet.
	<ul style="list-style-type: none"> Is the source video connected and on? 	<ul style="list-style-type: none"> Make sure source video (VCR, DVD, DTC) is connected and turned on.
Picture appears but no sound is produced.	<ul style="list-style-type: none"> Is the volume set at the minimum? 	<ul style="list-style-type: none"> Increase the volume.
	<ul style="list-style-type: none"> Is the mute mode set? 	<ul style="list-style-type: none"> Press the remote control's mute button.
	<ul style="list-style-type: none"> Are the speakers properly connected? 	<ul style="list-style-type: none"> Connect the speakers properly.
Tint is poor or colors are weak.	<ul style="list-style-type: none"> Are the tint and colors properly adjusted? 	<ul style="list-style-type: none"> Adjust the tint and color (under PICTURE). Return to factory reset.
Nothing appears on screen.	<ul style="list-style-type: none"> Is the computer's power turned on? 	<ul style="list-style-type: none"> Turn on the computer's power.
	<ul style="list-style-type: none"> Is a video source connected? 	<ul style="list-style-type: none"> Connect video source to the monitor.
	<ul style="list-style-type: none"> Is the power manager function in the STANDBY or OFF mode? 	<ul style="list-style-type: none"> Operate the computer (move the mouse, etc.).
Part of picture is cut off or picture is not centered.	<ul style="list-style-type: none"> Is the picture position adjusted correctly? 	<ul style="list-style-type: none"> Adjust the picture from the SCREEN menu.
Image is too large or too small.	<ul style="list-style-type: none"> Is the screen size adjusted correctly? 	<ul style="list-style-type: none"> Press the WIDE/AUTO WIDE button on the remote control and adjust properly.
Picture is unstable.	<ul style="list-style-type: none"> Is the computer set at the correct resolution? 	<ul style="list-style-type: none"> Set to the proper resolution.
	<ul style="list-style-type: none"> Is the HD receiver set to the correct mode? 	<ul style="list-style-type: none"> Set HD receiver to the correct mode (page 29).

Other Information

The Monitor Menu System

Main menu	Sub menu	Functions
PICTURE QUALITY	CONTRAST	Adjusts the contrast.
	BLACK LEVEL	Adjusts the brightness.
	SHARPNESS	Adjusts the sharpness.
	COLOR	Adjusts the color density (video input only).
	TINT	Adjusts the picture tint (video input only).
	PRESETS	Sets the picture mode according to the video environment.
	COLOR TEMP.	Adjusts the color temperature and white balance.
	NOISE REDUCE	Reduces noise visible in image.

Main menu	Sub menu	Functions
AUDIO	BASS	Sets the bass.
	TREBLE	Sets the treble.
	BALANCE	Sets the left/right balance.

Main menu	Sub menu	Functions
SCREEN	V-POSITION	Adjusts the vertical picture position of the picture on the screen.
	H-POSITION	Adjusts the horizontal picture position of the picture on the screen.
	V-HEIGHT	Adjusts the vertical size of the picture.
	H-WIDTH	Adjusts the horizontal size of the picture.
	AUTO PICTURE	When turned on, automatically adjusts for flickering and striped patterns.
	FINE PICTURE	Adjusts for flickering in the picture.
	PICTURE ADJ.	Adjusts for striped patterns in the picture.

Main menu	Sub menu	Functions
FUNCTION	DISPLAY	Turns the on-screen display on and off.
	MENU ADJUST	Adjusts the vertical and horizontal position of the menu display.
	POWER SAVER	Sets the monitor for use as an energy-saving display when used with a computer.
	GRAY LEVEL	When viewing a picture with 4:3 aspect ratio, sets the luminance of both sides of the picture.
	FILM MODE	When turned to AUTO, selects the correct viewing format.
	RGB3 ADJUST	Adjusts the display position in RGB3 input.
	SCREEN SAVER	Used principally for PC operation. PLE sets the luminance level to a fixed mode to reduce the effects of phosphor aging. ORBITER moves the image around the screen intermittently to reduce the effects of phosphor aging. INVERSE works in RGB mode only. Inverts the video signal, playing the image in a negative format.
	RESET	Resets ALL the settings to the factory default values.

Main menu	Sub menu	Functions
OPTIONS	AUDIO INPUT	Allocates audio connectors.
	BNC SELECT	Sets BNC connectors to either composite or component video.
	RGB SELECT	Sets the appropriate mode for the computer image. RGB (VGA signals), VIDEO (Moving picture), WIDE (WIDE VGA) DTV.
	HD SELECT	Sets correct mode for your HD digital receiver (1080 A or 1080 B).
	PICTURE SIZE	Sets the picture size for RGB input.

Main menu	Sub menu	Functions
SETUP	FREQUENCY	Confirms the frequency and synchronizing polarities of the signal currently being inputted.
	MENU LANGUAGE	Sets the language of the menus (English, French, or Spanish)
	COLOR SYSTEM	Sets the VIDEO format. Keep this set to AUTO.

Main menu	Sub menu	Functions
AUTOTUNING SETUP	HD RCVR BTN	Autotunes the HD RCVR button on the remote control to the input that your HD receiver is hooked up to.
	AUX BUTTON	Autotunes the SAT2 button on the remote control to the input that your satellite receiver is hooked up to.
	VCR1 BUTTON	Autotunes the VCR button on the remote control to the input that your VCR is hooked up to.
	DVD BUTTON	Autotunes the DVD button on the remote control to the input that your DVD player is hooked up to.

Other Information

Supported Resolution

- When screen mode is NORMAL, each signal is converted to 640 dot X 480 line signal (except for *3).
- When screen mode is FULL, each signal is converted to 853 dot X 480 line signal (except for *2).

Notes:

- With Digital inputs some signals are not accepted.
- The sync may not be disturbed when non-standard signals other than the previously mentioned are input.
- When connecting a composite sync signal, use the HD terminal.

Model	Dots X lines	Vertical frequency (Hz)	Horizontal frequency (kHz)	Sync Polarity		Presence		Screen mode			RGB select*5	
				Horizontal	Vertical	Horizontal	Vertical	NORMAL (4:3)	TRUE	FULL (16:9)		
*IBM PC/AT compatible computers	640 X 400	70.1	31.5	NEG	NEG	YES	YES	YES*2	YES	YES	--	
	640 X 480	59.9	31.5	NEG	NEG	YES	YES	YES	YES	YES	STILL	
		72.8	37.9	NEG	NEG	YES	YES	YES	YES	YES	--	
		75.0	37.5	NEG	NEG	YES	YES	YES	YES	YES	STILL	
		85.0	43.3	NEG	NEG	YES	YES	YES	YES	YES	--	
		100.4	51.1	NEG	NEG	YES	YES	YES	YES	YES	--	
		120.4	61.3	NEG	NEG	YES	YES	YES	YES	YES	--	
	848 X 480	60.0	31.0	POS	POS	YES	YES	YES	YES	YES	WIDE2	
	852 X 480*1	60.0	31.7	NEG	NEG	YES	YES	YES	YES	YES	WIDE1	
	800 X 600	56.3	35.2	POS	POS	YES	YES	YES	YES	YES	STILL	
		60.3	37.9	POS	POS	YES	YES	YES	YES	YES	STILL	
		72.2	48.1	POS	POS	YES	YES	YES	YES	YES	--	
		75.0	46.9	POS	POS	YES	YES	YES	YES	YES	--	
		85.1	53.7	POS	POS	YES	YES	YES	YES	YES	--	
		99.8	63.0	POS	POS	YES	YES	YES	YES	YES	--	
	1024 X 768	120.0	75.7	POS	POS	YES	YES	YES	YES	YES	--	
		60.0	48.4	NEG	NEG	YES	YES	YES*3	--	YES	STILL	
		70.1	56.5	NEG	NEG	YES	YES	YES*3	--	YES	--	
		75.0	60.0	POS	POS	YES	YES	YES*3	--	YES	STILL	
		85.0	68.7	POS	POS	YES	YES	YES*3	--	YES	--	
	1152 X 864	100.6	80.5	NEG	NEG	YES	YES	YES*3	--	YES	--	
		75.0	67.5	POS	POS	YES	YES	YES	--	YES	STILL	
		1280 X 768	56.2	45.1	POS	POS	YES	YES	YES	--	YES	WIDE1
		1360 X 765	60.0	47.7	POS	POS	YES	YES	YES	--	YES*3	WIDE1
	1376 X 768	59.9	48.3	NEG	POS	YES	YES	YES	--	YES	WIDE2	
	1280 X 1024	60.0	64.0	POS	POS	YES	YES	YES*4	--	YES	STILL	
		75.0	80.0	POS	POS	YES	YES	YES*4	--	YES	--	
		85.0	91.1	POS	POS	YES	YES	YES*4	--	YES	--	
1600 X 1200	60.0	75.0	POS	POS	YES	YES	YES	--	YES	--		
	65.0	81.3	POS	POS	YES	YES	YES	--	YES	--		
	70.0	87.5	POS	POS	YES	YES	YES	--	YES	--		
	75.0	93.8	POS	POS	YES	YES	YES	--	YES	--		
*Apple Macintosh*6	640 X 480	66.7	35.0	Sync on G	Sync on G	--	--	YES	YES	YES	--	
	832 X 624	74.6	49.7	Sync on G	Sync on G	--	--	YES	YES	YES	--	
	1024 X 768	74.9	60.2	Sync on G	Sync on G	--	--	YES*3	--	YES	--	
	1152 X 870	75.1	68.7	Sync on G	Sync on G	--	--	YES	--	YES	--	
Work Station (EWS4800)	1280 X 1024	60.0	64.6	NEG	NEG	YES	YES	YES*4	--	YES	--	
		71.2	75.1	NEG	NEG	YES	YES	YES*4	--	YES	--	
Work Station (HP)	1280 X 1024	72.0	78.1	--	--	--	--	YES*4	--	YES	--	
				--	--	--	--	--	--	--	--	
Work Station (SUN)	1152 X 900	66.0	61.8	C Sync	C Sync	--	--	YES	--	YES	--	
		76.0	71.1	C Sync	C Sync	--	--	YES	--	YES	--	
	1280 X 1024	76.1	81.1	C Sync	C Sync	--	--	YES*4	--	YES	--	
Work Station (SGI)	1024 X 768	60.0	49.7	--	--	--	--	YES*3	--	YES	--	
	1280 X 1024	60.0	63.9	--	--	--	--	YES*4	--	YES	--	
IDC-3000G						--	--	--	--	--	--	
	PAL625P	768 X 576	50.0	31.4	NEG	NEG	YES	YES	YES*7	--	YES*7	--
	NTSC525P	640 X 480	59.9	31.5	NEG	NEG	YES	YES	YES*7	--	YES*7	MOTION

- *1 Only when using a graphic accelerator board that is capable of displaying 848 X 480.
- *2 Aspect ratio is 5:4. This signal is converted to a 600 X 480 line signal.
- *3 The picture is displayed in the original resolution.
- *4 The aspect ratio is 5:4. This signal is converted to a 900 dot X by 768 line signal.
- *5 Normally the RGB SELECT mode is set automatically. If the picture is not displayed properly, set the mode for the input signals listed in the table.
- *6 To connect the monitor to a Macintosh computer use a D-sub 15-pin monitor adaptor with your computer's video port. If your computer has a D-sub 15-pin connector, use an RGB cable.
- *7 Other Screen modes are also available.

Notes:

- When the input signals comply with the resolution listed in the table above, the position and size of the picture may need to be adjusted.
- When a 1280 X 1024 line signal or a 1600 dot X 1200 line signal is input, the picture will be compressed.
- This monitor has a resolution of 1365 dot X 768 line. It is recommended that the input signal be XGA, wide XGA, or equivalent.
- Some signals are not accepted with digital input.
- The synch may be disturbed when a nonstandard signal other than those previously mentioned is input.
- If you are connecting a composite synch signal, use the HD terminal.

* IBM is a registered trademark of International Business Machines Corporation of the United States.

* Macintosh is a registered trademark of Apple Computer, Inc. of the United States.

Other Information

RCA Plasma Monitor Limited Warranty

What your warranty covers:

- Defects in materials or workmanship.

For how long after your purchase:

- One year from date of purchase for labor
- One year from date of purchase for parts.

The warranty period for rental units begins with the first rental or 45 days from date of shipment to the rental firm, whichever comes first.

What we will do:

Pay an Authorized Service Center the labor charges to repair your unit.

Pay an Authorized Service Center for the new, or at our option, refurbished replacement parts required to repair your unit.

How you get service:

- Call 1-800-433-8974 and have your unit's date of purchase and model/serial number ready.
- A representative will troubleshoot your problem over the phone.
- If the representative determines that you should receive service, they will provide you with the name(s) of the Authorized Service Center in your area.
- Contact the Service Center and arrange for home or pick up, repair, and return service, provided that your unit is located within the geographic territory covered by an Authorized Service Center. If not, you must take your unit to the Service Center location at your own expense, or pay for the cost the Service Center may charge to transport your unit to and from your home.
- Proof of purchase in the form of a bill of sale or receipted invoice which is evidence that the product is within the warranty period must be presented to obtain warranty service. For rental firms, proof of first rental is also required.

What your warranty does not cover:

- Customer instruction. (Your Owner's Manual describes how to install, adjust, and operate your unit. Any additional information should be obtained from your dealer.)
- Installation and related adjustments.
- Damage resulting from non-approved installation methods.
- Signal reception problems not caused by your unit.
- Damage from misuse or neglect.
- Batteries.
- A television that has been modified or incorporated into other products.
- A unit purchased or serviced outside the U.S.A.
- Acts of nature, such as but not limited to lightning damage.

Product Registration:

- Please complete and mail the Product Registration Card packed with your unit. It will make it easier to contact you should it ever be necessary. The return of the card is not required for warranty coverage.

Limitation of Warranty:

- **THE WARRANTY STATED ABOVE IS THE ONLY WARRANTY APPLICABLE TO THIS PRODUCT. ALL OTHER WARRANTIES, EXPRESS OR IMPLIED (INCLUDING ALL IMPLIED WARRANTIES OF MERCHANTABILITY OR FITNESS FOR A PARTICULAR PURPOSE) ARE HEREBY DISCLAIMED. NO VERBAL OR WRITTEN INFORMATION GIVEN BY THOMSON MULTIMEDIA INC., ITS AGENTS OR EMPLOYEES SHALL CREATE A WARRANTY OR IN ANY WAY INCREASE THE SCOPE OF THIS WARRANTY.**
- **REPAIR OR REPLACEMENT AS PROVIDED UNDER THIS WARRANTY IS THE EXCLUSIVE REMEDY OF THE CONSUMER. THOMSON MULTIMEDIA INC. SHALL NOT BE LIABLE FOR INCIDENTAL OR CONSEQUENTIAL DAMAGES RESULTING FROM THE USE OF THIS PRODUCT OR ARISING OUT OF ANY BREACH OF ANY EXPRESS OR IMPLIED WARRANTY ON THIS PRODUCT. THIS DISCLAIMER OF WARRANTIES AND LIMITED WARRANTY ARE GOVERNED BY THE LAWS OF THE STATE OF INDIANA. EXCEPT TO THE EXTENT PROHIBITED BY APPLICABLE LAW, ANY IMPLIED WARRANTY OF MERCHANTABILITY OR FITNESS FOR A PARTICULAR PURPOSE ON THIS PRODUCT IS LIMITED TO THE APPLICABLE WARRANTY PERIOD SET FORTH ABOVE.**

How State Law relates to warranty:

- Some states do not allow the exclusion nor limitation of incidental or consequential damages, or limitations on how long an implied warranty lasts, so the above limitations or exclusions may not apply to you.
- This warranty gives you specific legal rights, and you also may have other rights that vary from state to state.

If you purchased your unit outside the United States:

- This warranty does not apply. Contact your dealer for warranty information.

Service calls which do not involve defective materials or workmanship are not covered by this warranty. Costs of such service calls are the sole responsibility of the purchaser.

Accessories

The accessories listed below are available from your Cinema Screen Dealer. See your dealer for prices.

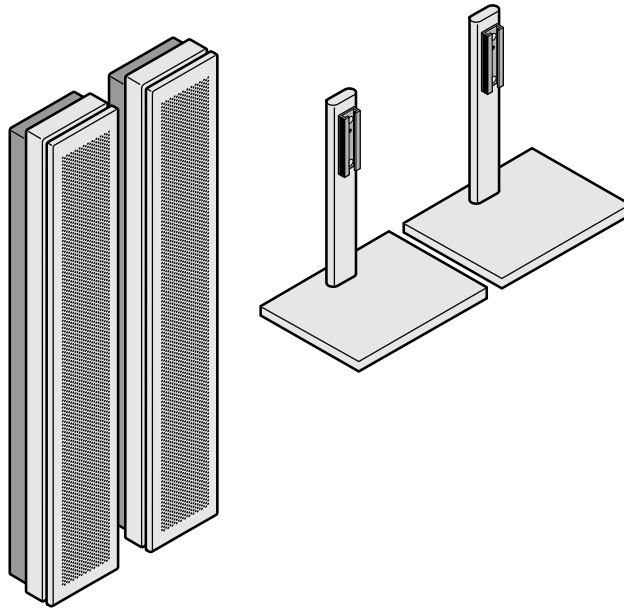

Attachable Speakers – SPK50

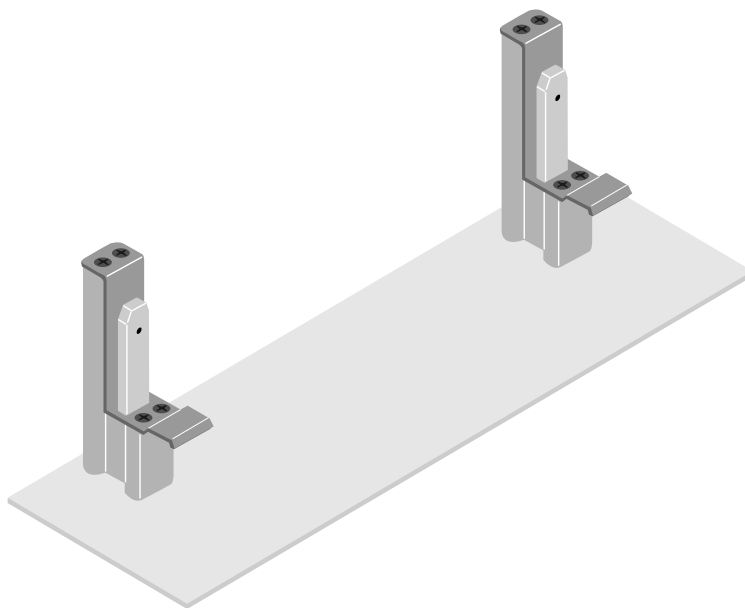

Monitor Stand – PLB50

Index

Symbols

1080A 39
1080B 39

A

Antenna button 13
Arrow buttons 13
Audio input 38
Audio menu 29, 50
Automatic Code Search 16
Auto picture 31
Autotuning 43, 51
Aux button 13

B

Balance 29
Bass 29
Batteries 9, 15
Bias 27
BNC select 38
Black level 26

C

CH+/CH- button 13
Cinema button 13
Clear button 13
CMPNT button 13
Color system 41
Components
 Connecting 11
Computers
 Connecting 11, 47
Contrast 26
Control Lock 8

D

Default values
 resetting 37, 50
DVD button 13
DVD Player 10, 11

E

External control 8
External Speakers 12, 55

F

Film mode 34
Frequencies of Input Signals 41
Function menu 32, 50

G

Gain 27
Go back button 13
Gray level 34
Guide button 13

H

HD select 40
HD RCVR button 14
HD Receiver
 Connecting 9
HD receiver 9
HD Receiver Mode 40
 1080A 40
 1080B 40

I

Info button 13
Input button 13
Input • Go Back 7
Inserting batteries in the remote 15
Installation 46
 Floor Stand 46
 Speakers 46
 Ventilation requirements 46
Inverse 36

J

Jacks 8, 11
 AC IN 8
 External Speakers 8, 55
 External Control 8
 Video in/Audio in 8

L

Language for the Menus 42
Laser Disc Player 10

M

Macintosh computer
 connecting 47
Memory Mode 25
Menu button 14
Menu • OK 7
Menu display
 position 32
Menu System 23, 50
Mini D-sub 15 Pin VGA
 Signal Composition 47
Mode of Input Signals 41
Monitor button 14
Multi-screen 23
Mute 22

N

Navigating the menus 23
Noise Reduction 28
Number buttons 14

O

OK button 14
On•Off button 14
On-screen Menus 23
 Display position 32
Options menu 38, 51
Orbiter 36

P

Personal computer
 connecting 10, 11, 47
Picture-in-picture 23
Picture Quality menu 25, 50
Picture mode
 Bright 25
 Memory 25
 Normal 25
 Preset 25
 Soft 25
Picture position 31, 32
PIP 23
PLE 34
Polarities of Input Signals 41
Power 22
Power cord 6
Power Saver 33
Power/standby indicator 33
Programming the remote 15
Presets 25

R

Reducing noise in the picture 28
Remote Control
 Automatic Code Search 16
 Buttons 13,14
 Codes 18
 inserting batteries 15
 Mute 22
 Navigating the Menus 23
 Programmable Codes 18
 Programming the Remote 16
Resetting to default values 37
Resolution of Input Signals 41
RGB Select 39

S

- Safety information 1, 2
- Safety metal fitting 6
- Screen Saver 35, 50
- Screen menu 30, 50
- Screen size
 - Fill 30
 - Full 30
 - Normal 30
 - Stadium 30
- Setting the Color Temperature 27
- Setup menu 41, 51
- Sharpness 26
- Sleep button 14
- Sleep timer
 - Cancelling 44
 - Checking 44
 - Setting 44
- Speakers 12, 55
- Specifications 48
- Stand
 - using with Cinema Screen display 55

T

- TREBLE 29
- Troubleshooting 49

V

- VCR 10
- VCR1 button 14
- VCR2 button 14
- Ventilation Requirements 46
- Video button 14
- Video 39
- Viewing size
 - selecting 30
- Volume 14, 22
- Vol+/- buttons 14, 22

W

- Warranty 54
- Wide 39

Z

- Zoom 7, 14
- Zoom in/Zoom out buttons 14

Please do not send any products to the address listed in this manual or on the carton. This will only add delays in service for your product.

Thomson multimedia Inc.

10330 N. Meridian St.
Indianapolis, IN 46290

©2001 Thomson multimedia Inc.

Trademark(s) ® Registered

Marca(s) Registrada(s)

Printed in USA

TOCOM 15739310

Free Manuals Download Website

<http://myh66.com>

<http://usermanuals.us>

<http://www.somanuals.com>

<http://www.4manuals.cc>

<http://www.manual-lib.com>

<http://www.404manual.com>

<http://www.luxmanual.com>

<http://aubethermostatmanual.com>

Golf course search by state

<http://golfingnear.com>

Email search by domain

<http://emailbydomain.com>

Auto manuals search

<http://auto.somanuals.com>

TV manuals search

<http://tv.somanuals.com>