



C • I • N • E • M • A • S • C • R • E • E • N

U S E R ' S M A N U A L

SAFETY INFORMATION

WARNING RISK OF ELECTRIC SHOCK DO NOT OPEN	TO REDUCE THE RISK OF ELECTRIC SHOCK, DO NOT REMOVE COVER (OR BACK). NO USER SERVICEABLE PARTS INSIDE. REFER SERVICING TO QUALIFIED SERVICE PERSONNEL.
 This symbol indicates "dangerous voltage" inside the product that presents a risk of electric shock or personal injury.	 This symbol indicates important instructions accompanying the product.

PRECAUTIONS

Please read this manual carefully before using your Cinema Screen Monitor and keep the manual handy for future reference.

WARNING

TO PREVENT FIRE OR SHOCK HAZARDS, DO NOT EXPOSE THIS UNIT TO RAIN OR MOISTURE. ALSO DO NOT USE THIS UNIT'S PLUG WITH AN EXTENSION CORD RECEPTACLE OR OTHER OUTLETS, UNLESS ALL PRONGS CAN BE FULLY INSERTED. REFRAIN FROM OPENING THE CABINET AS THERE ARE HIGH-VOLTAGE COMPONENTS INSIDE. REFER SERVICING TO QUALIFIED SERVICE PERSONNEL.

INDUSTRY CANADA COMPLIANCE NOTICE

This Class B digital apparatus meets all requirements of the Canadian Interference-Causing Equipment Regulations.

DECLARATION OF CONFORMITY

This device complies with Part 15 of the FCC rules. Operation is subject to the following two conditions:
(1) This device may not cause harmful interference, and
(2) this device must accept any interference received, including interference that may cause undesired operation.

Product: Cinema Screen Display

Equipment Classification: Class B Computer Peripheral

Model: PR42300

We hereby declare that the equipment specified above conforms to the technical standards as specified in the FCC rules.

Thomson Consumer Electronics, Inc.
10330 N. Meridian St.
Indianapolis, IN 46290
Phone: 1-800-433-8974

FCC Information

- FCC Regulations state that unauthorized changes or modifications to this equipment may void the user's authority to operate it.
- This equipment has been type tested and found to comply with the limits for a Class B Digital Device in accordance with the specifications in Part 15 of the FCC rules. These rules are designed to provide reasonable protection against radio and television interference in a residential installation. This equipment generates and can radiate radio frequency and, if not installed and used in accordance with the instructions, may cause harmful interference to radio communications. However, there is no guarantee that interference will not occur in a particular installation.

If this equipment does cause interference to the radio or television reception (which you can determine by turning the equipment off and on), try to correct the interference by one or more of the following measures:

- Reorient or relocate the receiving antenna (that is, the antenna for the radio or television that is "receiving" the interference).
- Change the position of the Cinema Screen display with respect to the radio or television equipment that is receiving the interference.
- Move the Cinema Screen display away from the equipment receiving the interference.
- Plug the Cinema Screen display into a different wall outlet so the receiver and the equipment are on different branch circuits.

If these measures do not eliminate interference, please consult your dealer or an experienced radio/television technician for additional suggestions. Also, the Federal Communications Commission has prepared a helpful booklet, "How to Identify and Resolve Radio/TV Interference Problems." This booklet is available from the U.S. Government Printing Office, Washington D.C., 20402. Please specify stock number 004-000-00345-4 when ordering copies.

WARNINGS AND SAFETY PRECAUTIONS

The Cinema Screen monitor is designed and manufactured to provide long, trouble-free service. No maintenance other than cleaning is required. Use a soft dry cloth to clean the panel. Never use solvents such as alcohol or thinner to clean the panel surface.

The Cinema Screen display panel consists of fine picture elements (cells). Although the Cinema Screen display panels are produced with more than 99.99 percent active cells, there may be some cells that do not produce light or remain lit.

For operating safety and to avoid damage to the unit, read carefully and observe the following instructions.

To avoid shock and fire hazards:

1. Provide adequate space for ventilation to avoid internal heat build-up. Do not cover rear vents or install in a closed cabinet or shelves.

The unit is equipped with cooling fans. If you install the unit in an enclosure, be sure there is adequate space at the top of the unit to allow hot air to rise and escape.

If the monitor becomes too hot, the overheat protector will be activated and the monitor will be turned off. If this happens, turn off the power to the monitor and unplug the power cord. If the room where the monitor is installed is particularly hot, move the monitor to a cooler location, and wait for the monitor to cool for 60 minutes.

If the problem persists, contact your Cinema Screen dealer for service.

2. Do not use the power cord plug with extension cords or outlets unless all prongs can be completely inserted.
3. Do not expose unit to water or moisture.
4. Avoid damage to the power cord, and do not attempt to modify the power cord.
5. Unplug unit during electrical storms or if unit will not be used over a long period.
6. Do not open the unit which has potentially dangerous high voltage components inside. If the unit is damaged from opening the cabinet the warranty will be void. Moreover, there is a serious risk of electric shock.
7. Do not attempt to service or repair the unit. TCE is not liable for any bodily harm or damage caused if unqualified persons attempt service or open the back cover. Refer all service to authorized Cinema Screen Service Centers.

IMPORTANT TIPS: CARING FOR YOUR CINEMA SCREEN MONITOR

TO AVOID DAMAGE AND PROLONG OPERATING LIFE:

1. Use only with 120V 50/60Hz AC power supply. Continued operation at line voltages greater than 120 Volts AC will shorten the life of the unit, and might cause a fire hazard.
2. Handle the unit carefully when installing it.
3. Locate set away from heat, excessive dust, and direct sunlight.
4. Protect the inside of the unit from liquids and small metal objects. In case of accident, unplug the unit and have it serviced by an authorized service center.
5. Do not hit or scratch the panel surface as this causes flaws on the surface of the screen.
6. For correct installation and mounting it is strongly recommended to use a trained, authorized Cinema Screen dealer.
7. Like all phosphor-based display devices, Cinema Screen monitors can be susceptible to uneven phosphor aging under certain circumstances. Certain operating conditions, such as the continuous display of a static image over a prolonged period of time, can result in uneven phosphor aging if proper precautions are not taken. To protect your investment in this Cinema Screen monitor, please adhere to the following guidelines and recommendations for minimizing the occurrence of uneven phosphor aging:
 - Always enable and use your computer's screen saver function during use with a computer input source.
 - Display a moving image whenever possible.
 - Always power down the monitor when you are finished using it.
 - If viewing with a 4/3 aspect ratio for long periods of time, set side gray level at 3 or 4.

IF THE CINEMA SCREEN MONITOR IS IN LONG TERM USE OR CONTINUOUS OPERATION TAKE THE FOLLOWING MEASURES TO REDUCE THE LIKELIHOOD OF UNEVEN PHOSPHOR AGING:

- Lower the BRIGHTNESS and CONTRAST levels as much as possible without impairing image readability.
- Display an image with many colors and color gradations (i.e. photographic or photo-realistic images).
- Create image content with minimal contrast between light and dark areas (for example, white characters on black backgrounds). Use complementary or pastel color whenever possible.
- Avoid displaying images with few colors and distinct, sharply defined borders between colors.

Contents

Safety Information	1
Warnings and Safety Precautions	2
IMPORTANT TIPS: Caring for Your Cinema Screen Monitor	2
Getting Started	5
Contents of the Package	6
Attching the Ferrite Cores	6
Part Names and Functions – Front View	7
Part Names and Functions – Back View	8
Battery Installation	9
Connecting an HD Receiver	9
The Back of the HD Receiver	9
Connecting Your VCR Or Laserdisc Player	10
Connecting Your DVD Player	10
Connecting a Personal Computer	10
Connecting Components to the Cinema Screen Monitor	11
Connecting External Speakers to the Cinema Screen Monitor ...	12
A Quick Tour of the Remote Control	13
Using Your Remote Control	15
Inserting Batteries	15
Programming the Remote	15
Find Out If You Need to Program the Remote	15
How to Program the Remote	16
Using Automatic Code Search	16
Using Direct Entry	17
How To Use the Remote Control	
After You've Programmed It	17
Programmable Codes for the Remote Control	18
The Menu System	21
Basic Operations	22
Power	22
Volume	22
Mute	22
Navigating the Menus	23
On-Screen Menu Operation	23
The PICTURE QUALITY Menu	24
Setting the Picture Mode	24
Adjusting the Picture Settings in MEMORY Mode	25
Setting the Color Temperature	26
Reducing Noise in the Picture	27
The AUDIO Menu	28
The SCREEN Menu	29
Selecting a Viewing Size	29
Adjusting the Picture Position and Size	30
Auto Picture	30

Contents

The FUNCTION Menu	31
On-Screen Displays	31
Adjusting the Position of the Menu Display	31
Setting the POWER SAVER for Computer Images	32
The POWER/STANDBY Indicator	32
Setting the Gray Level for the Sides of the Screen	33
Setting the Brightness Level with the PLE+INVERSE Feature	33
Adjusting for Flickering with Film Mode	34
Resetting to Default Values	34
The OPTIONS Menu	35
Setting the Audio Inputs	35
Setting the BNC Connectors	35
Setting a Computer Image to the Correct RGB Select Mode	36
Setting the Cinema Screen Monitor to the correct HD Receiver Mode	37
Adjusting the Display in RGB3 Input Mode	37
The SETUP Menu	38
Confirming the Frequencies and Polarities of Input Signals ..	38
Selecting the Language for the Menus	38
Setting the Video Signal Format	38
The AUTOTUNING SETUP Menu	39
Autotuning the Component Buttons on the Remote Control	39
SLEEP TIMER	39
Setting the Sleep Timer	39
Cancelling the Sleep Timer	39
Reference	41
Installing the Cinema Screen Monitor	42
Attaching optional mounts or stand to the Cinema Screen monitor	42
Connecting Your PC Or Macintosh Computer	43
Mini D-sub 15 Pin VGA Signal Composition	43
Specifications	44
Troubleshooting	45
The Cinema Screen Monitor Menu System	46
Supported Resolution	48
RCA Cinema Screen Display Limited Warranty	49
Cinema Screen Accessories	50
Index	51

SETUP AND CONNECTIONS

GETTING STARTED

Welcome to the future! The Cinema Screen monitor combines advanced technology with sophisticated design to create a sleek, elegant monitor that fits unobtrusively into any environment – while still making a lasting impression.

This first section contains all of the information you need to get your Cinema Screen monitor connected and set up. The rest of the manual gives you guidance in using the functions of your monitor, as well as technical information, troubleshooting, and warranty information.

1 SETUP AND CONNECTIONS



2 THE MENU SYSTEM



3 REFERENCE

SETUP AND CONNECTIONS

CONTENTS OF THE PACKAGE

Cinema Screen monitor
Power cord
Ferrite cores
RGB cable (Mini D-Sub 15-pin to Mini D-Sub 15-pin connector)
Remote control unit with two AA batteries
User's manual

It is highly recommended that you have your Cinema Screen monitor installed by a professional. If you are installing the monitor yourself, refer to the Reference section.

NOTE: If you are planning on attaching the floor stand to your Cinema Screen monitor (and not the optional wall mount unit) you may want to use the safety metal fittings (provided) to give your monitor extra stability.

The safety metal fittings attach to the back of the screen and can then be used to secure the monitor to the wall with strong wire. Contact your trained, authorized Cinema Screen dealer for professional installation.

In order to conform to mandatory FCC standards, you must attach the supplied ferrite cores to both ends of the power cable (see below).

If you are connecting a computer to the monitor, you must attach the ferrite cores to both ends of the DVI cable to meet FCC standards.

ATTACHING THE FERRITE CORES

Set the ferrite cores on the both ends of the DVI cable (not supplied), and one end of the power cable (supplied). Close the lid tightly until the clamps click. Use the band to secure the ferrite core (supplied).

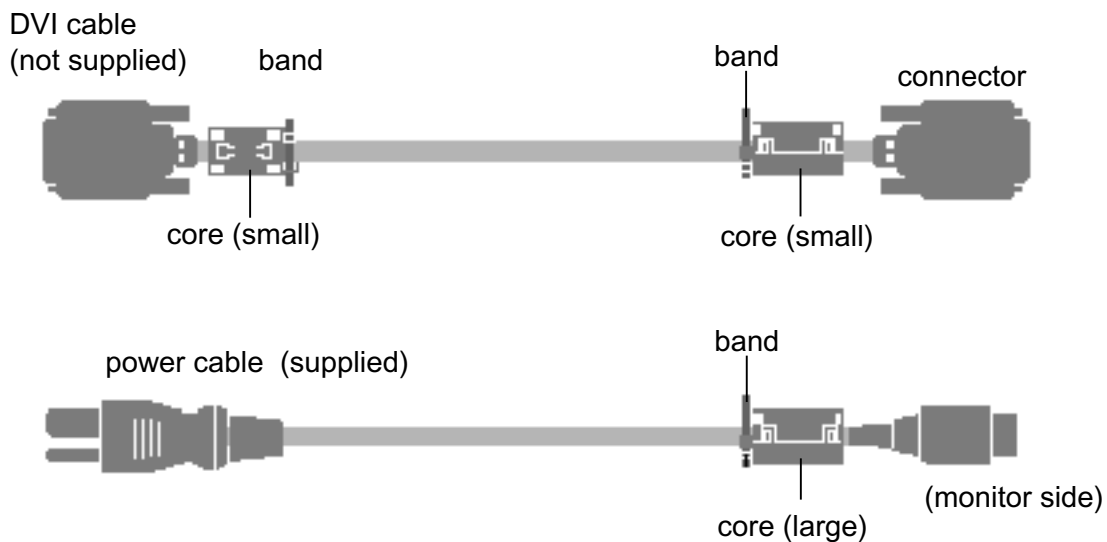

SETUP AND CONNECTIONS

PART NAMES AND FUNCTIONS – FRONT VIEW

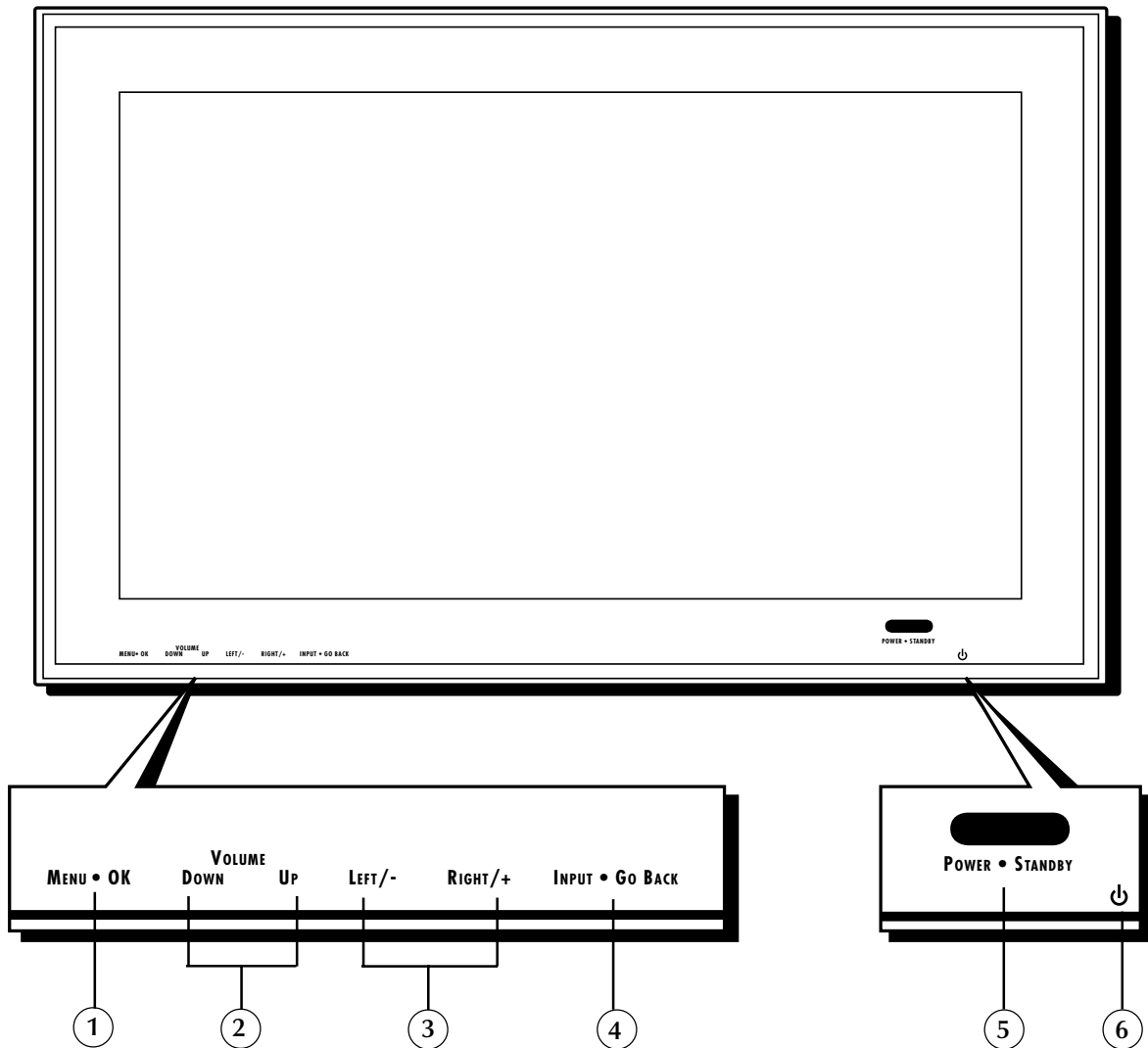

1. **MENU • OK** – If no menu is displayed, brings up the menu. If a menu is displayed, press to select a highlighted option.
2. **VOLUME** – Adjusts the volume. When an on-screen menu is being displayed, moves highlight up and down (▲ and ▼).
3. **LEFT/- AND RIGHT/+** – When Zoom mode is on (press OK on the remote to turn ZOOM on and bring up the zoom icon) press Right/+ to enlarge the image or Left/- to reduce the image.

When a menu is being displayed, used to navigate through menu (◀ and ▶).

4. **INPUT • Go BACK** – Switches the input, in the following order:



**Note: You can set up CMPNT1 or RGB2, but not both.*

When an on-screen menu is being displayed, returns you to the previous menu.

5. **POWER/STANDBY indicator** – When the power is on, the light is green. When the power is in Standby Mode, the light is red.
6. **⏻** – Turns the monitor's power on and off.

SETUP AND CONNECTIONS

PART NAMES AND FUNCTIONS – BACK VIEW

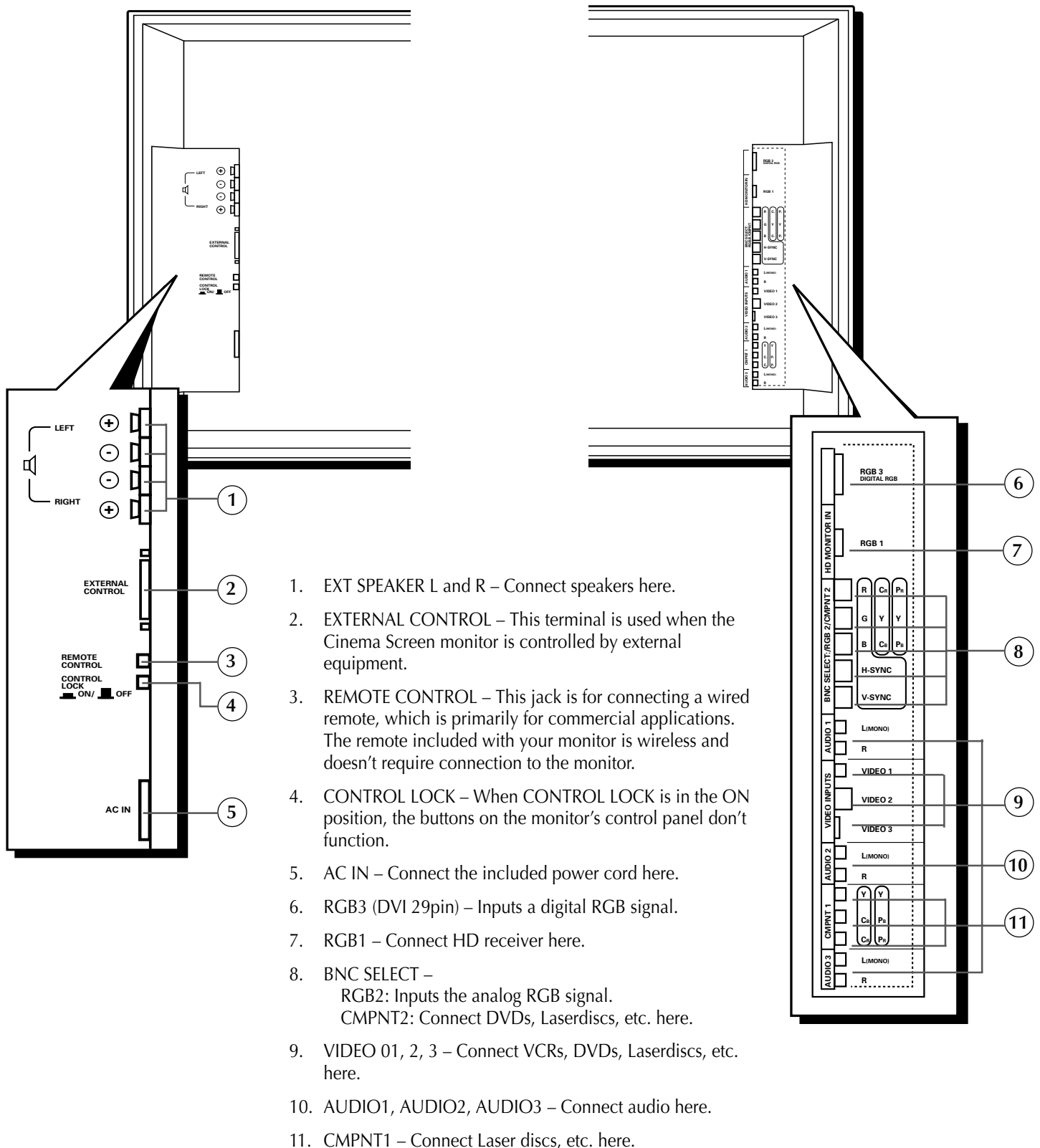

SETUP AND CONNECTIONS

BATTERY INSTALLATION

- Remove the battery compartment cover from the back of the remote control.
- Insert batteries. Make sure the polarities (+ and -) are aligned correctly.
- Replace cover.

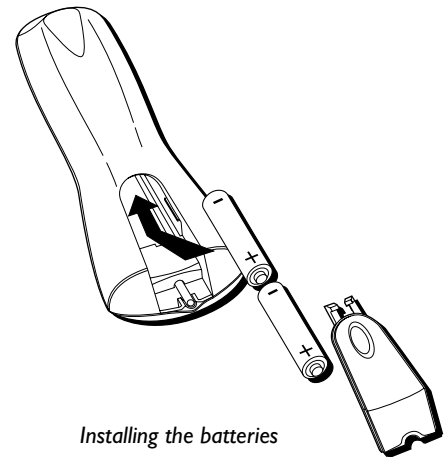

Installing the batteries

CONNECTING AN HD RECEIVER

RCA and PROSCAN HD (high definition) receivers come equipped with an RGB output jack for optimum quality. Using the RGB cable provided, connect the HD MONITOR OUT jack on the back of your HD receiver to the RGB1 (HD MONITOR IN)/AUDIO1 IN jack on the back of the Cinema Screen monitor.

If your HD receiver does not have the type of jack pictured on the right, connect your HD receiver using the component video jacks and RCA cable.

For more information on HD receiver connections, see your HD receiver user's manual.

THE BACK OF THE HD RECEIVER

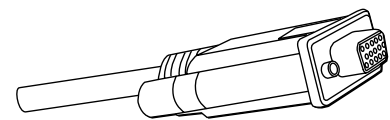
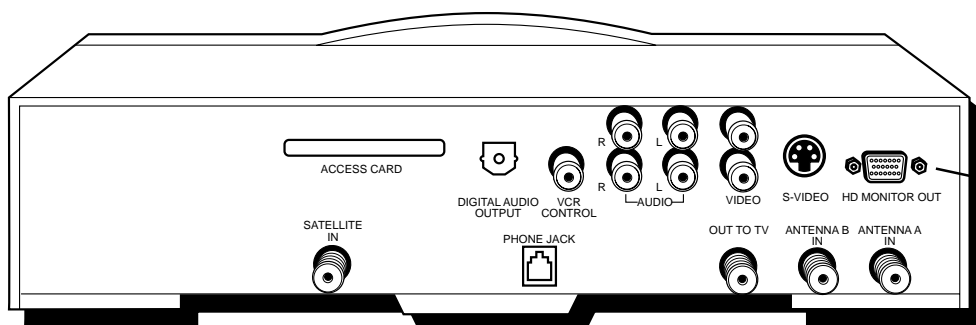

RGB cable

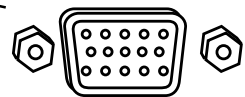

HD MONITOR OUT jack

SETUP AND CONNECTIONS

CONNECTING YOUR VCR OR LASERDISC PLAYER

Use common RCA cables (not provided) to connect your VCR or laserdisc player to your Cinema Screen monitor. To connect your VCR or Laserdisc player:

1. Turn off the power to the monitor and VCR or laser disc player.
2. Connect one end of your RCA cable to the video output connector on the back of your VCR or laser disc player. Connect the other end to the video input on the monitor.
3. Use standard RCA cables to connect the audio from your VCR or laser disc player to AUDIO2 input jacks on the monitor (if your VCR or laser disc player has this capability). Be careful to keep your right and left channel connections correct for stereo sound.
4. Turn on the Cinema Screen monitor and the VCR or laser disc player.

NOTE: Refer to your VCR or laser disc player user's manual for more information about your equipment's video output requirements.

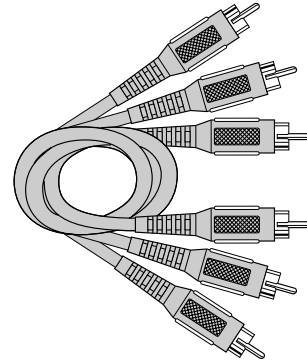

RCA cables (audio/video cables) are sold as a bundled set.

CONNECTING YOUR DVD PLAYER

To connect your Cinema Screen monitor to a DVD player:

1. Turn off the power to the monitor and DVD player.
2. Use a standard video cables to connect your DVD player to the CMNT1 input on the monitor, or use the DVD player's S-Video output. (Use a standard S-Video cable to connect to the S-Video input on the Cinema Screen monitor.)
3. Turn on the monitor and the DVD player.

CONNECTING A PERSONAL COMPUTER

If you are connecting a computer to the monitor, you must attach ferrite cores to both ends of the DVI cable to meet FCC standards (see page 6).

If you have a computer with digital RGB output, connect it to the RGB3 jack on the monitor.

For IBM VGA (or compatible) or Macintosh (or compatible) connect to the RGB1 jack on the monitor.

SETUP AND CONNECTIONS

CONNECTING COMPONENTS TO THE CINEMA SCREEN MONITOR

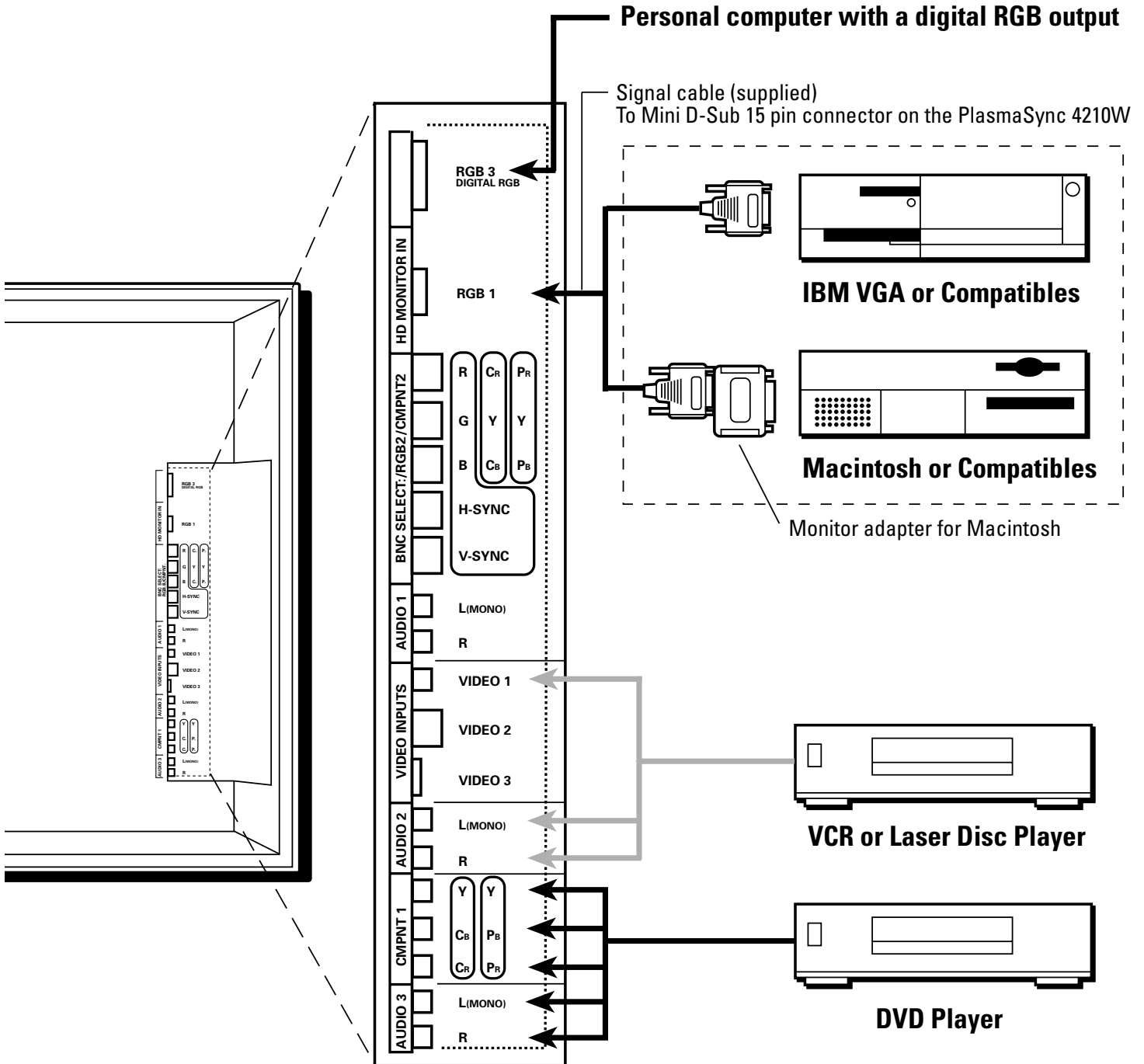

SETUP AND CONNECTIONS

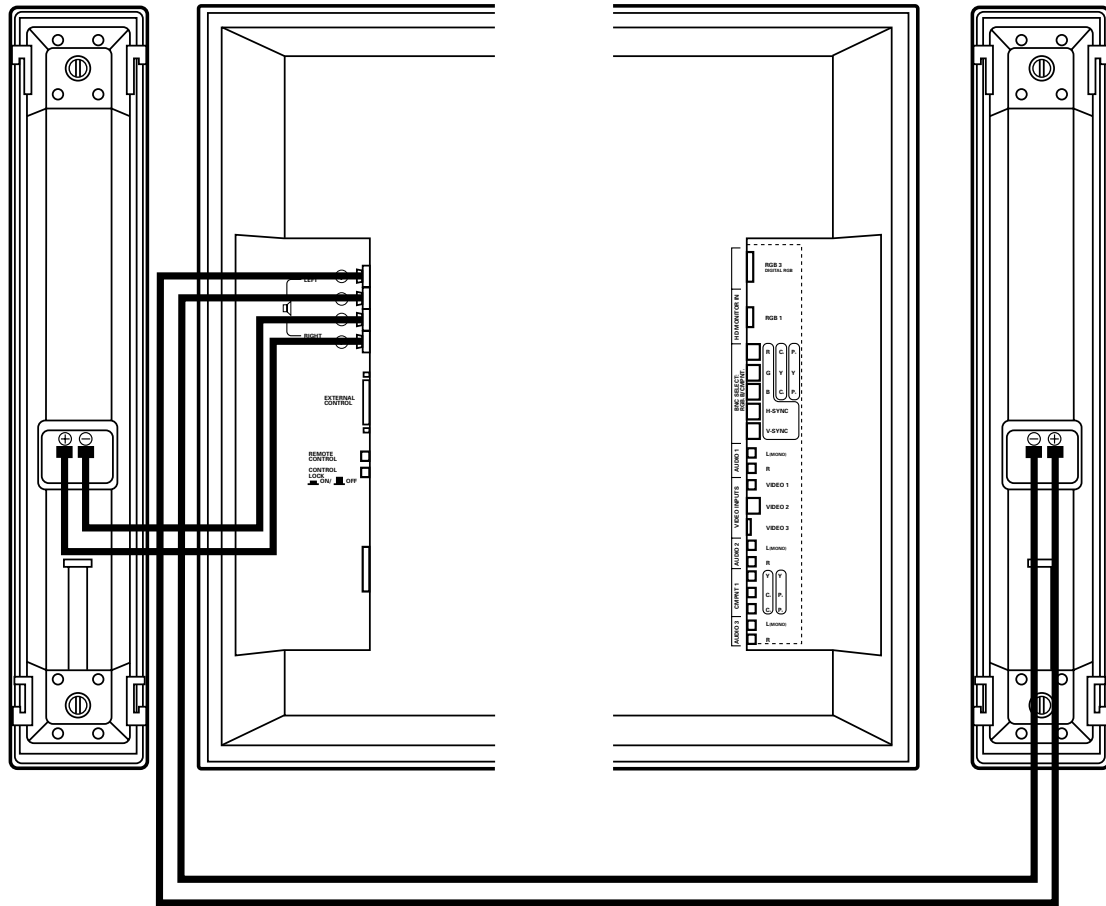

CONNECTING EXTERNAL SPEAKERS* TO THE CINEMA SCREEN MONITOR

The Cinema Screen monitor doesn't have internal speakers, so in order to get sound you must connect external speakers. External speakers can reproduce sound from VIDEO or RGB signal sources.

External speakers may be connected directly to the SPEAKERS terminals or indirectly by connecting a stereo system amplifier to the audio outputs.

CAUTION: Unplug the monitor and all connected components before connecting external speakers. Use only speakers with 6 to 8-ohm impedance and a power output rating of 7 watts or more.

To connect external speakers directly to the Cinema Screen monitor:

1. Strip the ends of the speaker wires.
2. Press down the tabs below the speaker terminals and insert the speaker wire and release the tab to secure the speaker wire connection.
 - [a] Connect the right speaker (located at right side of the monitor when viewed from the front) positive (+) wire to RIGHT +.
 - [b] Connect the right speaker negative (-) wire to RIGHT -.
 - [c] Connect the left speaker negative (-) wire to LEFT-.
 - [d] Connect the left speaker positive wire (+) to LEFT+.

*Not included

SETUP AND CONNECTIONS

A QUICK TOUR OF THE REMOTE CONTROL

In alphabetical order

ANTENNA In HD RCVR mode, switches the HD receiver between antenna A and antenna B.

Arrows Use the arrows to navigate through the menu screens.

AUX (auxiliary) You can program this button to control any one of the following: a cable box; most GE, RCA, and PROSCAN audio components; a laserdisc player; a VCR; or a satellite receiver. Press this button to operate the component you've programmed to work with the AUX button.

CH+/CH- Changes channels on the HD receiver when the remote is in HD receiver mode. When the Zoom mode is active, zooms in (CH+) or out (CH-).

CINEMA Press to select one of four screen sizes to suit the type of input you're watching.

***NOTE:** When watching the HD receiver, screen size is controlled through the HD receiver menu system.*

CLEAR Clears on-screen displays and returns you to normal viewing.

CMPNT Toggles between CMPNT1 and CMPNT2 inputs.

GO BACK In HD receiver mode, returns you to the previous channel. When in the menu system, returns you to the previous menu.

GUIDE In HD receiver mode, brings up the on-screen program guide.

INFO Brings up channel information.

INPUT Changes the video input.

MENU Brings up the on-screen menu.

MONITOR Turns the power to the monitor on and puts the remote in Monitor mode so you are able to control the Cinema Screen display.

MUTE Reduces sound to an inaudible level.

Numbers Use the number keys to make numerical entries.

OK/ZOOM When in Monitor mode (press the MONITOR button) and using on-screen menus, press OK to select a highlighted menu function. When there are no on-screen menus displayed, press OK to bring up the zoom pointer. Position pointer on the part of the screen you want to zoom on, then use the CH+/- buttons to zoom in/out.

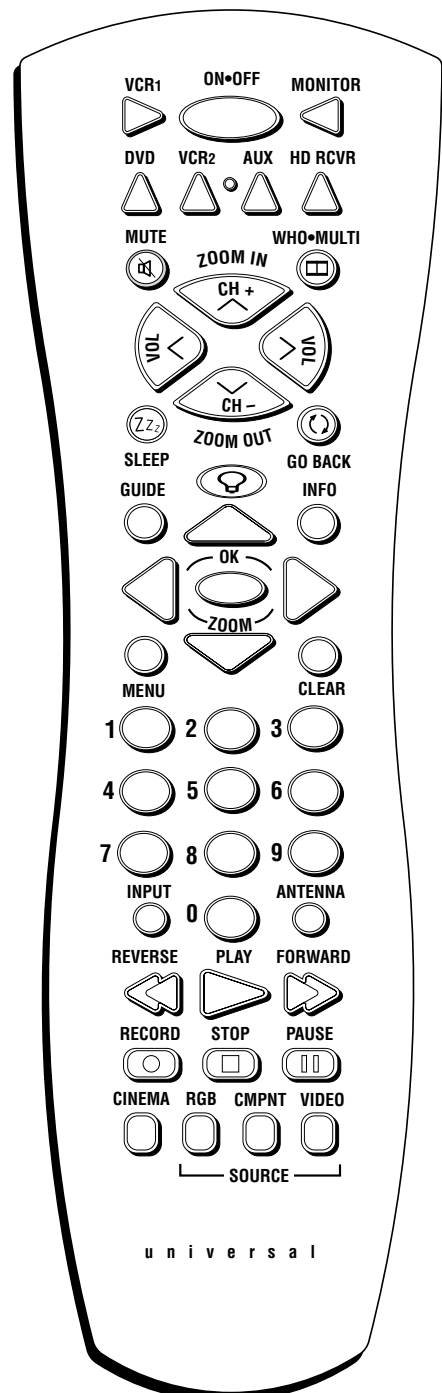

SETUP AND CONNECTIONS

ON•OFF Toggles power on and off for the components that you have programmed. For example, if you are in VCR mode, turns VCR on and off.

REVERSE, PLAY, FORWARD, STOP, PAUSE, RECORD (transport keys) Use with components programmed to work with your remote control (VCR, DVD player, audio components).

RGB Depending on how you set up the Cinema Screen monitor, toggles between RGB1, RGB2*, and RGB3.

**Note: You can set up CMPNT1 OR RGB2, but not both. If CMPNT1 is set up, RGB2 will not appear when you use the RGB button.*

SLEEP Brings up the sleep timer, which is used to turn the monitor off automatically after a set amount of time.

VCR1, VCR2, DVD, HD RCVR, MONITOR These are the component buttons used to put the remote control into the correct mode to operate that particular component. The correct video source must first be selected (VIDEO or RGB) or Autotuning must be set up.

VOL^/VOL v Adjusts the volume.

VIDEO Selects whatever component is hooked up to the video source inputs.

WHO•MULTI Brings up personal viewer profiles for some components.

ZOOM IN When in zoom mode (press the MONITOR button and then the OK button to access zoom mode) enlarges the picture. When in zoom mode, use the arrow buttons to pan and scan the entire picture.

ZOOM OUT When in zoom mode (press the MONITOR button and then the OK button to access zoom mode) decreases the size of the picture. If picture is distorted, zoom out to restore to normal.

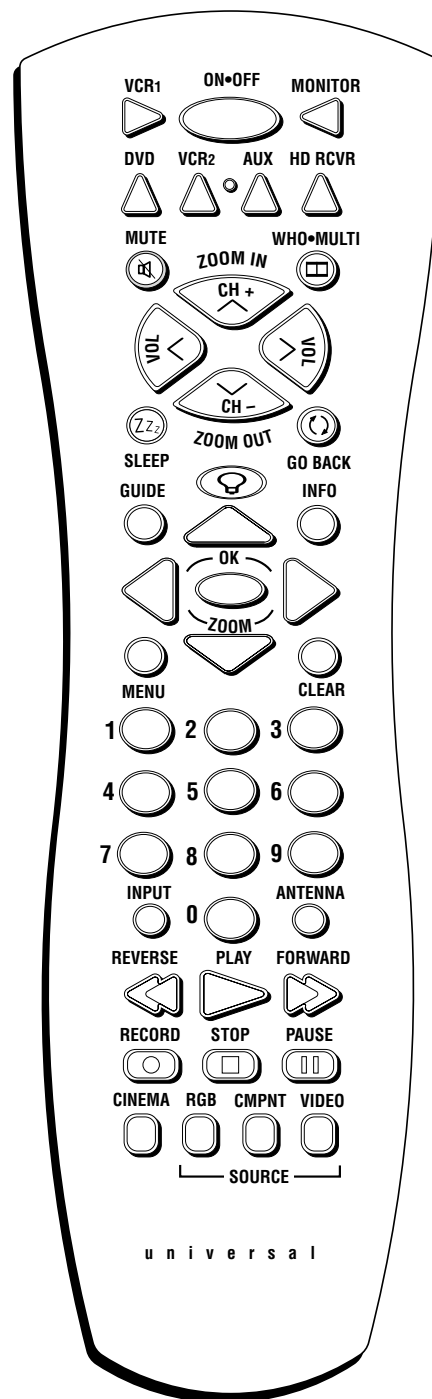

SETUP AND CONNECTIONS

USING YOUR REMOTE CONTROL

INSERTING BATTERIES

1. Remove the battery compartment cover from the remote control.
2. Insert batteries (included) as shown on the diagram inside the battery compartment.
3. Replace the battery compartment cover.

Use your remote control from a distance of about 7m/23 feet from the monitor's remote control sensor and at a horizontal angle of within 30°. The remote operates on line of sight, so if there is anything blocking the path between the remote and the remote control sensor on the front of the monitor, the remote may not work.

- Don't expose the remote control sensor on the front of the monitor to direct sunlight or strong artificial light.
- Don't get the remote control wet.
- Avoid heat and humidity.
- When not using the remote for a long period of time, remove the batteries.

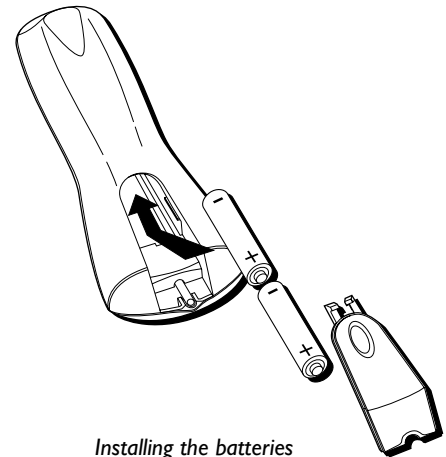

Installing the batteries

PROGRAMMING THE REMOTE

The universal remote control that came with your Cinema Screen monitor is already programmed to operate most RCA, GE, and PROSCAN VCRs, DVD players, laserdisc players, and satellite receivers. This remote is also capable of operating many other brands of remote-controllable electronic components, but you must program it to do so.

FIND OUT IF YOU NEED TO PROGRAM THE REMOTE

To determine whether the universal remote needs to be programmed, turn on one of your components, such as a VCR. Point the remote control at the component and press the component button (for example, the VCR button). Now press the ON•OFF button on the remote. If the component doesn't turn off, you need to program the remote control in order for it to operate that component.

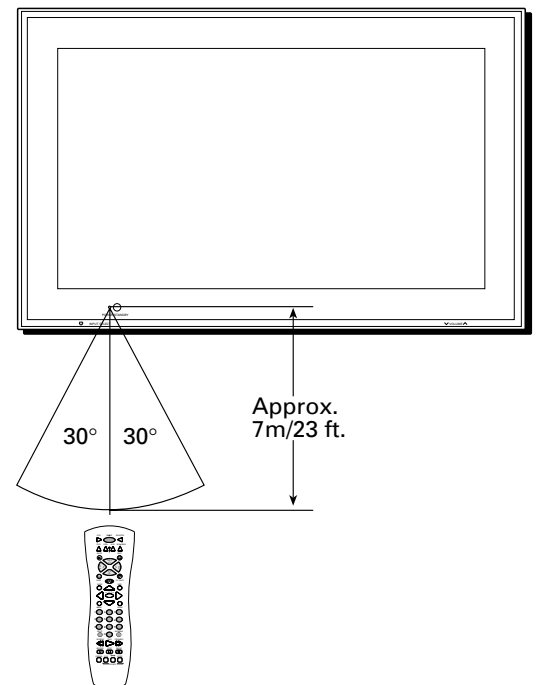

SETUP AND CONNECTIONS

HOW TO PROGRAM THE REMOTE

There are two ways to program the remote control: automatic code search and direct entry.

USING AUTOMATIC CODE SEARCH

1. Turn on the component you want the remote to operate (VCR, HD receiver, etc.)
2. Press and hold the component button that corresponds to the component you want the remote to operate (VCR, HD receiver,, etc.). While you hold down the component button, press and hold ON•OFF (when the red light on the remote turns on, release both buttons).
3. Press PLAY (the red light on the remote starts flashing).

The remote is searching the first set of component codes (there are several sets of codes). If the component you want to operate doesn't turn off automatically after 5 seconds, press PLAY again (the red light starts flashing again as the remote searches through the next set of codes).

Continue pressing PLAY until the component turns off.

NOTE: If the component doesn't turn off after you've pressed the PLAY button 20 times, the component can't be programmed.

4. Press REVERSE and wait 2 seconds. Repeat this step until the component turns back on.
5. To finish, press and hold the STOP button until the red light on the remote turns off.

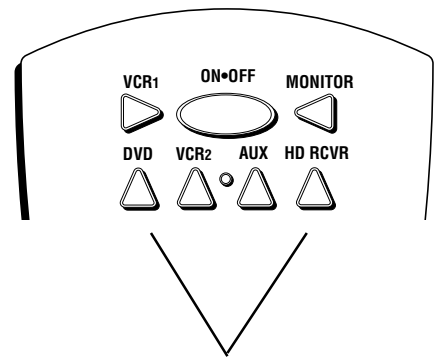

Component Buttons

These are the buttons you program to operate another component.

SETUP AND CONNECTIONS

USING DIRECT ENTRY

1. Turn on the component you want the remote to operate (the red light on the remote turns on).
2. Look up the brand and code number(s) for the component on the code list on the following pages.
3. Press and hold the component button that corresponds to the component you want the remote to operate (VCR, DVD, etc.).
4. Enter the code from the code list. When you begin entering numbers, the red light on the remote turns off. When the last number is entered, the red light turns back on. If the incorrect code is entered, the red light will flash.
5. Release the component button. The red light on the remote turns off.
6. Press ON•OFF to see if the component responds to the remote commands. If it doesn't, try pressing the component button and then ON•OFF again.
6. If you get no response, repeat these steps using the next code listed for your brand, until the component responds to the remote commands.

HOW TO USE THE REMOTE CONTROL AFTER YOU'VE PROGRAMMED IT

Once the remote control has been programmed successfully, you're ready to use it to operate other components.

1. Press one of the video source buttons to select a component (VIDEO or RGB) to operate.
2. Press the component button (MONITOR, VCR, DVD, AUX, or HD RCVR) to use the Transport buttons (REVERSE, PLAY, FORWARD, STOP, PAUSE, and RECORD) to operate the component.
3. Press ON•OFF to turn the component on or off.

NOTE: *If you keep pressing buttons and nothing happens, you may have the wrong video source or wrong component selected. You must press the correct video source and the component button that matches the component you want to operate.*

SETUP AND CONNECTIONS

PROGRAMMABLE CODES FOR THE REMOTE CONTROL

VCR

Admiral	2131	Magnavox	2021, 2022, 2062, 2063, 2104, 2108, 2124	Sylvania	2002, 2021, 2022, 2026, 2062, 2063, 2065, 2124
Adventura	2026	Magnin	2013	Symphonic	2002, 2026
Aiko	2027	Marantz	2009, 2010, 2011, 2016, 2018, 2021, 2058, 2062, 2064	Tandy	2002, 2011
Aiwa	2002, 2026	Marta	2014	Tashiko	2014
Akai 2003, 2004, 2005, 2007, 2008, 2111, 2112, 2113		Masushita	2021	Tatung	2058, 2111
American High	2021	MEI	2021	TEAC	2002, 2026, 2058, 2085, 2111
Asha	2013	Memorex	2002, 2011, 2013, 2014, 2021, 2023, 2026, 2104, 2131	Technics	2021, 2109
Audio Dynamics	2009, 2010	MGA	2029, 2065, 2113	Teknika	2002, 2014, 2021, 2026, 2100, 2129
Audiovox	2014	MGN Technology	2013	TMK	2013, 2024, 2047
Bell & Howell	2011	Midland	2053	Toshiba 2015, 2049, 2051, 2055, 2065, 2093, 2116	
Beaumarck	2013	Minolta	2055, 2056, 2107	ToteVision	2013, 2014
Broksonic	2012, 2025	Mitsubishi	2029, 2055, 2056, 2065, 2066, 2067, 2069, 2070, 2071, 2072, 2073, 2074, 2106, 2113, 2123	Unitech	2013
Calix	2014	Montgomery Ward	2075, 2131	Vector Research	2009, 2010, 2015, 2016
Candle 2013, 2014, 2015, 2016, 2017, 2018, 2019		Motorola	2021, 2131	Victor	2010
Canon	2021, 2022, 2114	MTC	2002, 2013, 2026	Video Concepts ...	2009, 2010, 2015, 2016, 2113
Capehart	2020, 2110	Multitech ...	2002, 2013, 2016, 2026, 2053, 2061	Videosonic	2013
Carver	2062	NEC	2009, 2010, 2011, 2016, 2018, 2058, 2064, 2076, 2078, 2079, 2111, 2123	Wards	2002, 2013, 2014, 2015, 2021, 2023, 2026, 2029, 2055, 2056, 2061, 2096, 2101, 2102, 2103, 2107, 2116, 2131
CCE	2027, 2061	Nikko	2014	XR-1000	2021, 2026, 2061
Citizen	2013, 2014, 2015, 2016, 2017, 2018, 2019, 2027	Noblex	2013	Yamaha	2009, 2010, 2011, 2018, 2058, 2111
Colortyme	2009	Olympus	2021	Zenith	2004, 2098, 2104, 2119, 2128
Colt	2061	Optimus	2014, 2131		
Craig	2013, 2014, 2023, 2061	Optonica	2096		
Curtis-Mathes 2000, 2002, 2009, 2013, 2016, 2018, 2021, 2022, 2024, 2115		Orion	2035		
Cybernex	2013	Panasonic ...	2021, 2022, 2109, 2125, 2126, 2127		
Daewoo 2015, 2017, 2019, 2025, 2026, 2027, 2028, 2110		Pentax	2016, 2055, 2056, 2107, 2120		
Daytron	2110	Pentax Research	2018		
Dbx	2009, 2010	Philco	2021, 2022, 2062, 2063		
Dimensia	2000	Philips	2021, 2062, 2096, 2124		
Dynatech	2002, 2026	Pilot	2014		
Electrohome	2014, 2029	Pioneer	2010, 2055, 2080, 2081, 2123		
Electroponic	2014	Portland	2016, 2017, 2019, 2110		
Emerson 2002, 2012, 2014, 2015, 2021, 2024, 2025, 2026, 2029, 2030, 2032, 2033, 2034, 2035, 2036, 2037, 2038, 2039, 2040, 2041, 2042, 2044, 2045, 2047, 2065, 2105, 2113, 2116, 2117, 2130		PROSCAN	2000, 2001		
Fisher	2011, 2023, 2048, 2049, 2050, 2051, 2052, 2118	Protec	2061		
Fuji	2021, 2119	Pulsar	2104		
Funai	2002, 2026	Quarter	2011		
Garrard	2026	Quartz	2011		
GE 2000, 2001, 2013, 2021, 2022, 2053, 2115, 2120		Quasar	2021, 2022, 2125		
Goldstar	2009, 2014, 2018, 2054, 2121	RCA 2000, 2001, 2003, 2013, 2021, 2055, 2056, 2082, 2083, 2084, 2085, 2086, 2087, 2088, 2089, 2090, 2091, 2107, 2115, 2120, 2125			
Gradiente	2026	Radio Shack/Realistic	2002, 2011, 2013, 2014, 2021, 2022, 2023, 2026, 2029, 2049, 2050, 2096, 2131		
Harley Davidson	2026	Radix	2014		
Harman Kardon	2009	Randex	2014		
Harwood	2061	Ricoh	2128		
Headquarter	2011	Runco	2104		
Hitachi	2002, 2055, 2056, 2057, 2107, 2111, 2120, 2122	Samsung ...	2005, 2013, 2015, 2033, 2053, 2112		
Hi-Q	2023	Sanky	2131, 2104		
Instant Replay	2021	Sansui	2010, 2092, 2111, 2123		
JCL	2021	Sanyo	2011, 2013, 2023		
JC Penney 2009, 2010, 2011, 2013, 2014, 2021, 2022, 2055, 2056, 2058, 2059, 2060, 2107, 2118		Scott 2012, 2015, 2025, 2032, 2035, 2038, 2065, 2093, 2116			
Jensen	2055, 2056, 2111	Sears 2011, 2014, 2021, 2023, 2048, 2049, 2050, 2051, 2055, 2056, 2107, 2118			
JVC ...	2009, 2010, 2011, 2018, 2058, 2111, 2123	Sharp 2002, 2017, 2029, 2094, 2095, 2096, 2131			
Kenwood	2009, 2010, 2011, 2016, 2018, 2058, 2111, 2123	Shintom	2004, 2056, 2061, 2098		
KLH	2061	Shogun	2013		
Kodak	2014, 2021	Signature	2002, 2131		
Lloyd	2002, 2026	Singer	2021, 2061, 2128		
Logik	2061	Sony	2002, 2004, 2098, 2099, 2119, 2128		
LXI	2014	STS	2021, 2107		

CABLE BOX

ABC ..	5002, 5003, 5004, 5005, 5006, 5007, 5053
Antronix	5008, 5009
Archer	5008, 5009, 5010, 5011
Cabletenna	5008
Cableview	5008
Century	5011
Citizen	5011
Colour Voice	5012, 5013
Comtronics	5014, 5015
Contec	5016
Eastern	5017
Garrard	5011
GC Electronics	5009
Gemini	5018, 5019, 5049
General Instrument	5003
Hamlin	5020, 5021, 5022, 5035, 5045
Hitachi	5003
Hytex	5002
Jasco	5011
Jerrold	5003, 5005, 5007, 5018, 5023, 5024, 5046, 5053
Magnavox	5025
Memorex	5026
Movie Time	5002, 5027, 5028
NSC	5002, 5027, 5028
Oak	5002, 5016, 5029
Panasonic	5048, 5052
Paragon	5026
Philips	5011, 5012, 5013, 5019, 5025, 5030, 5031, 5032
Pioneer	5033, 5034
Pulsar	5026
RCA	5047, 5049, 5052
Realistic	5009, 5049
Regal	5022, 5035
Regency	5017
Rembrandt	5003
Runco	5026
Samsung	5014, 5034
Scientific Atlanta	5006, 5036, 5037, 5038
Signal	5014, 5018

SETUP AND CONNECTIONS

Signature	5003
SL Marx	5014
Sprucer	5052
Starcom	5007, 5018, 5053
Stargate	5014, 5018
Starquest	5018
Tandy	5040
Teleview	5014
Tocom	5004, 5023, 5041
Toshiba	5026
Tusa	5018
TV86	5027
Unika	5008, 5009, 5011
United Artists	5002
United Cable	5053
Universal	5008, 5009, 5010, 5011
Videoway	5044
Viewstar	5015, 5025, 5027, 5040
Zenith	5026, 5050, 5051

SATELLITE RECEIVER

Chapparral	5056, 5057
Drake	5058, 5059
GE	5000, 5001
General Instruments	5060, 5061, 5062
Panasonic	5075
Primestar	5076
PROSCAN	5000, 5001
RCA	5000, 5001
Realistic	5063
Sony	5072
STS1	5064
STS2	5065
STS3	5066
STS4	5067
Toshiba	5068
Toshiba	5073
Uniden	5069

AUDIO

(For RCA and Dimensia brands only)

AM/FM	4003
Aux	4004
Phono	4005
CD	4007
Tape	4006

This page intentionally left blank.

THE MENU SYSTEM

GETTING AROUND THE MENU SYSTEM

There are several functions available for customizing the Cinema Screen monitor to suit your viewing environment. The Cinema Screen monitor's on-screen menu system makes controlling the functions of your monitor simple.

1 SETUP AND CONNECTIONS



2 THE MENU SYSTEM



3 REFERENCE

THE MENU SYSTEM

BASIC OPERATIONS

POWER

To turn the monitor on and off:

1. Plug the power cord into an active AC power outlet.
2. Press the ON•OFF button on the remote control or the unit. The monitor's POWER/STANDBY indicator turns green when the monitor is on.
3. Press the ON•OFF button on the remote control or the unit to turn it off. The monitor's POWER/STANDBY indicator turns red and the standby mode is set (only when turning off the unit with the remote control).

VOLUME

To adjust the volume:

1. Press and hold the VOL \wedge button (on the remote control or the unit) to increase to the desired level.
2. Press and hold the VOL \vee button (on the remote control or the unit) to decrease to the desired level.

Note: External speakers are required for sound.

MUTE

Press the MUTE button on the remote control to reduce the sound to an inaudible level. Press MUTE again to restore the sound.

THE MENU SYSTEM

NAVIGATING THE MENUS

You can adjust monitor options through the Cinema Screen monitor's menu system. To access the main menu, press the MENU button on the remote control or MENU•OK on the front of the monitor.

There are a few things you need to know to navigate through the menu system. The navigation buttons are the set of arrow-shaped buttons in the middle of the remote (See illustration on right).

Use the ▲ and ▼ buttons on the remote to move the menu highlight up and down.

Use the ◀ and ▶ buttons to move the highlight and change settings.

Press the GO BACK button on the remote to return to a previous menu.

You can return the Cinema Screen monitor to the factory settings at any time by using the RESET option in the OPTIONS menu. Remember, if you choose to reset, ALL settings will return to the factory settings.

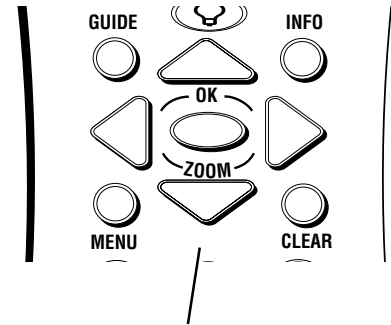

These are the buttons on the remote you use to navigate through the monitor's on-screen menu system.

ON-SCREEN MENU OPERATION

To access the main menu, press the MENU button on the remote. The MAIN MENU is displayed on the screen. The main menu contains a list of all the menus that control your monitor. To select a menu, use the up/down arrow buttons on the remote to highlight the desired menu. When the desired menu is highlighted, press the OK or MENU button to select.

Note: Different components use different types of input (RGB, video, etc). Some menu options apply to only one type of input, so they only appear when they apply to the currently active input. For example, the COLOR and TINT options in the PICTURE QUALITY menu only appear when you are adjusting standard video input (VIDEO1, VIDEO2, VIDEO3).

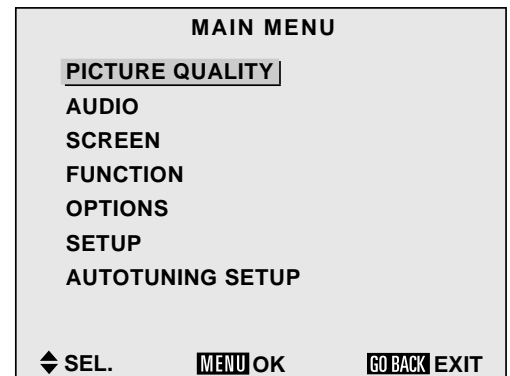

This is the main menu with the PICTURE Quality option highlighted. Press OK to bring up the highlighted menu.

THE MENU SYSTEM

THE PICTURE QUALITY MENU

SETTING THE PICTURE MODE

The Cinema Screen monitor has preset viewing modes that can be selected depending on your viewing environment. Each preset mode has the contrast, brightness and sharpness adjusted for a specific viewing situation.

- **MEMORY** – This mode allows you to set and save your own picture adjustments.
- **SOFT** – Use this mode when watching your Cinema Screen in a dark room. Soft mode provides a darker, finer picture, like the screen in movie theaters. These settings are preset for you and can't be changed.
- **BRIGHT** – Use this mode when watching your Cinema Screen monitor in a bright room. This mode provides a picture with distinct differences between light and dark areas. These settings are preset for you and can't be changed.
- **NORMAL** – The factory default.

To change the picture mode:

1. From the main menu, select **PICTURE QUALITY**. The **PICTURE QUALITY** Menu will appear.
2. Highlight the **PRESETS** option and press the **▶** key on the remote to select it. The **PRESETS** window appears.
3. Use the **▶** button on the remote to select the desired mode. The mode switches as follows when the **▶** button is pressed:

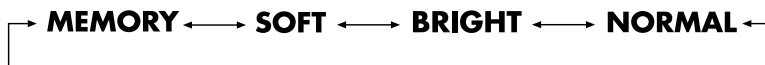

Note: If you don't push the **▶** button within 5 seconds, the current selection is set and the previous screen reappears.

Once you've selected the desired mode, press **OK** or **MENU**. The picture mode is now set and you are returned to the **PICTURE QUALITY** screen. If you are using **MEMORY** mode, you can manually adjust the picture settings (contrast, black level, and sharpness). You can continue adjusting settings in the **PICTURE QUALITY** menu, return to the main menu, or exit the menu system.

To return to the main menu, press the **GO BACK** button on the remote. To exit the menu system, press **CLEAR**.

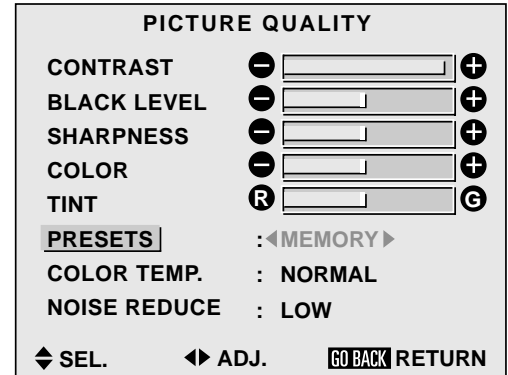

This is the **PICTURE Quality** menu with the **PRESETS** option highlighted.

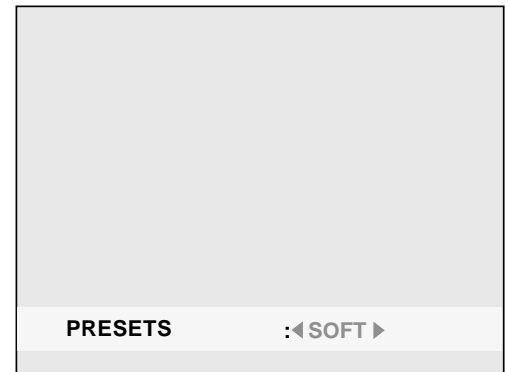

This is the **PRESETS** screen with **SOFT** as the current selection.

THE MENU SYSTEM

ADJUSTING THE PICTURE SETTINGS IN MEMORY MODE

In MEMORY mode, you can set and save the following picture adjustments:

CONTRAST – Changes the picture's contrast (between light and dark).

BLACK LEVEL – Makes the picture lighter or darker.

SHARPNESS – Changes the picture's sharpness.

COLOR – Changes color density (video input only).

TINT – Changes picture tint (video input only).

COLOR TEMP – Changes the color tone.

NOISE REDUCE – (noise reduction)– Removes extraneous information from the signal to make the picture clearer.

NOTE: Only the contrast and brightness can be adjusted when a computer signal is used.

Once you have selected MEMORY mode, you can adjust the picture settings. For example, to change the contrast setting:

1. Use the ▲ or ▼ button to highlight the CONTRAST option. Press the ► button to select it. The CONTRAST window appears. Use ◀ and ▶ buttons to adjust the contrast.

NOTE: If you don't push the ◀ or ▶ button within 5 seconds, the current setting is accepted and the previous screen reappears.

2. Once the contrast is adjusted, press OK or MENU. The contrast is set and you are returned to the PICTURE QUALITY menu.
3. Use the same procedure to adjust the black level and sharpness settings.
4. When you are finished adjusting the picture settings, press GO BACK to return to the main menu or press CLEAR to exit the menu system.

If the "CONTROL NOT AVAILABLE" message appears when you are trying to change the picture settings, make sure the preset mode is set to MEMORY. You can only change picture settings in MEMORY mode. The other modes are pre-set and can't be changed.

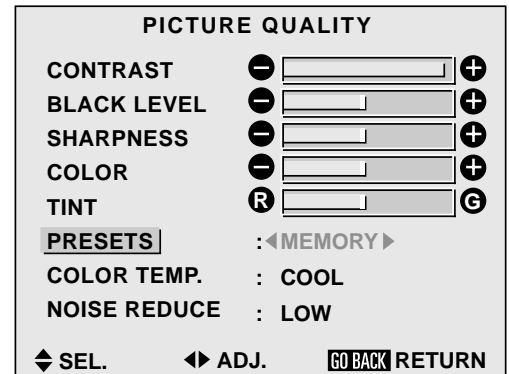

This is the PICTURE QUALITY menu with the PRESETS option highlighted.

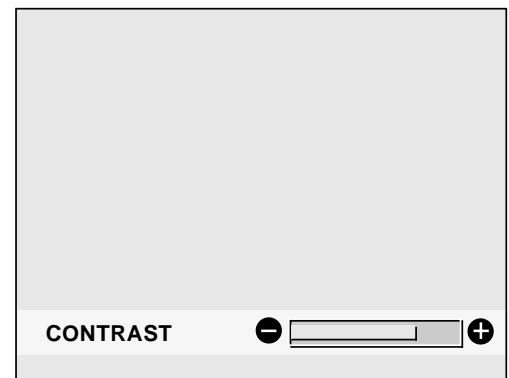

This is the CONTRAST screen.

THE MENU SYSTEM

SETTING THE COLOR TEMPERATURE

The color temperature setting controls how warm (red) or cool (blue) your picture is. The COLOR TEMP option has 4 settings:

Normal

Warm

Pro (lets you select settings individually)

Cool

For regular viewing, Normal, Warm or Cool is recommended. The PRO setting is generally used only for professional applications. To change the COLOR TEMP setting:

1. From the main menu, highlight and select the PICTURE QUALITY menu.
2. Use the arrow buttons on the remote to highlight the COLOR TEMP option. Press the ► button to select it. The COLOR TEMP screen appears.
3. Use the ◀ and ▶ buttons to select the desired COLOR TEMP setting. The settings switch as follows:

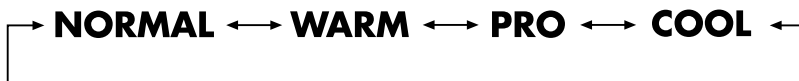

NOTE: If you don't push the ◀ or ▶ button within 5 seconds, the current setting is accepted and the previous screen reappears.

4. Once the desired color temp is selected, press OK or MENU. If you choose the PRO setting, the WHITE BALANCE screen appears. It allows individual setting of white and dark balance for each color (red, green and blue).

GAIN This adjusts the color balance for light/bright colors.

BIAS This adjusts the color balance for dark colors.

To change the white balance GAIN setting:

1. Highlight the RED, GREEN or BLUE GAIN option. and press the ► button. The GAIN screen for that color appears.
2. Adjust the balance using the ◀ and ▶ keys.

NOTE: If you don't push the ◀ or ▶ button within 5 seconds, the current setting is accepted and the previous screen reappears.

3. When you have the desired setting, press OK or MENU. The GAIN is adjusted and you are returned to the WHITE BALANCE screen.
4. When you completed all the desired white balance adjustments, Press the GO BACK button to return to the PICTURE menu. You can continue adjusting picture settings, return to the main menu or press CLEAR to exit the menu system.

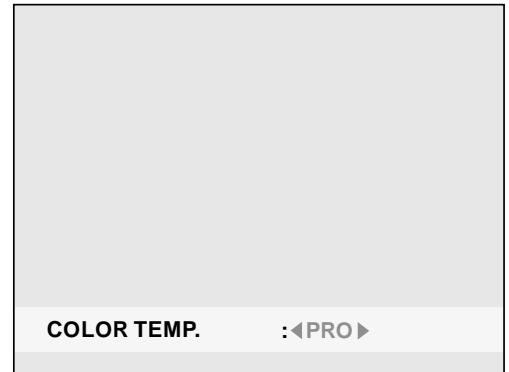

This is the COLOR TEMP. screen with PRO as the current selection.

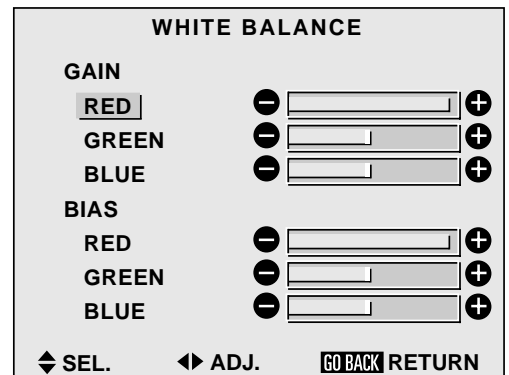

This is the WHITE BALANCE screen with the RED GAIN option highlighted.

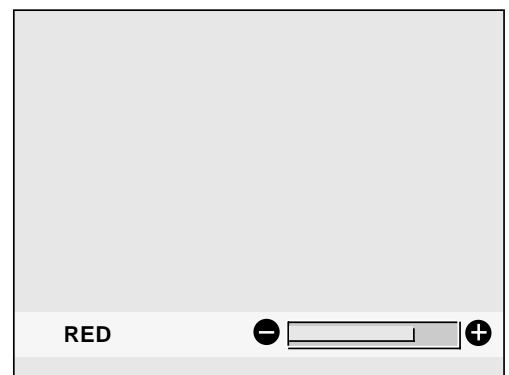

This is the R-GAIN (red gain) screen.

THE MENU SYSTEM

REDUCING NOISE IN THE PICTURE

Noise is a term used to describe extraneous bits of information in the signal that affect the clearness of the picture. You can use the Noise Reduction (NOISE REDUCE) setting if your reception is poor or when playing video tapes that have poor picture quality.

The NOISE REDUCE option has four settings, including OFF. The higher the setting, the stronger the effect. The settings switch as follows when the ► button is pressed:

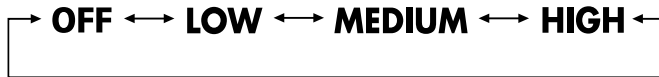

To change the noise reduction setting:

1. From the PICTURE QUALITY menu, highlight the NOISE REDUCE option, and select it by pressing the ► button. The NOISE REDUCE SCREEN is displayed.
2. Use the ◀ and ▶ buttons to select the desired noise reduction setting.
NOTE: If you don't push the ◀ or ▶ button within 5 seconds, the current setting is accepted and the previous screen reappears.
3. When the desired setting is displayed, press OK to return to the PICTURE QUALITY menu. You can continue adjusting picture settings, return to the main menu, or press CLEAR to exit the menu system.

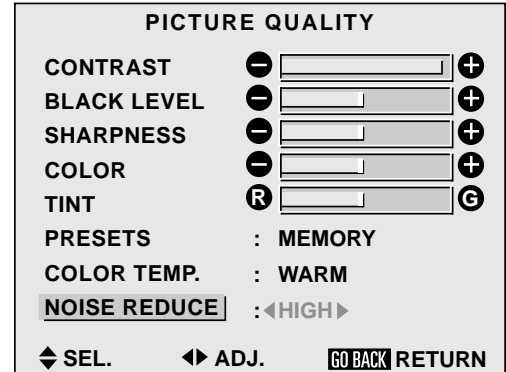

This is the PICTURE QUALITY menu with the NOISE REDUCE (noise reduction) option highlighted.

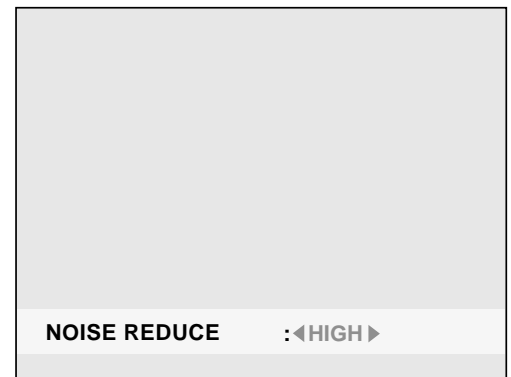

This is the NOISE REDUCE (noise reduction) screen.

THE MENU SYSTEM

THE AUDIO MENU

The AUDIO menu allows you to adjust the treble, bass and left/right balance of your external speakers.

BASS – Changes the level of low frequency sound.

TREBLE – Changes the level of high frequency sound.

BALANCE – Changes the balance of the left and right speakers.

MENU OPERATIONS

To access the AUDIO menu:

1. From the main menu, highlight and select the AUDIO option. The AUDIO menu is displayed.
2. Use the ▲ and ▼ arrow buttons on the remote to highlight an option (for example, BASS).
3. Use the ◀ and ▶ buttons to adjust to the desired setting.
4. You can continue adjusting audio settings, press GO BACK to return to the main menu, or press CLEAR to exit the menu system.

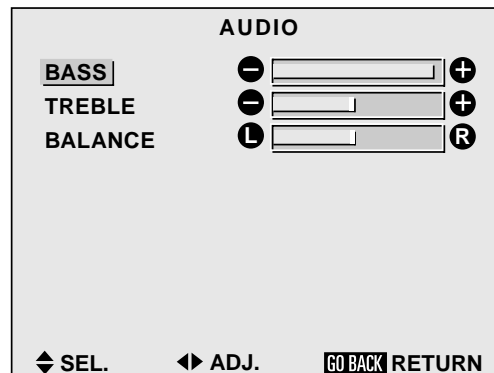

This is the AUDIO menu with the BASS option highlighted. Press the rightarrow button to select it.

THE MENU SYSTEM

THE SCREEN MENU

The SCREEN menu allows you to set the monitor to automatically select the correct mode for viewing a particular movie and to change the positions of on-screen menus.

SELECTING A VIEWING SIZE

When viewing with a component other than your HD receiver, you can set the screen mode to one of four screen sizes to suit the type of input you are watching. Select the screen mode with the CINEMA button on the remote control. The screen sizes are as follows:

FILL expands in both vertical and horizontal directions while the correct proportions are maintained. The picture is not distorted, just closer.

NORMAL displays a picture with a 4:3 aspect ratio (standard video). Because this mode fills the screen vertically, but not horizontally, black bars will appear on the right and left sides of the picture.

Note: If viewing with a 4/3 aspect ratio for long periods of time, set side gray level at 3 or 4.

FULL expands the picture in the horizontal direction only. This option corrects the aspect ratio of images that have been compressed or "squeezed."

STADIUM expands in both the horizontal and vertical directions, but varies the amount of stretch depending on the picture – the center of the picture is almost normal while the edges are considerably expanded. This mode is intended for watching video with a 4:3 aspect ratio on a wide screen.

Note: In stadium mode, only the V-position and H-position are displayed. You can't change the height and width.

To change the viewing size:

1. Press the CINEMA button on the remote control.
2. The current viewing size will be displayed. Press the CINEMA button again to switch to the next size. The size switches as follows:

→ **FILL** → **NORMAL** → **FULL** → **STADIUM**



Fill



Normal



Full



Stadium

THE MENU SYSTEM

ADJUSTING THE PICTURE POSITION AND SIZE

The SCREEN menu lets you adjust the position and size of the picture.

The first two options, V-POSITION and H-POSITION, adjust the placement of the picture on the screen. For example, if the picture is too far to the left, you can use the H-POSITION to move it to the right. To adjust the position of the picture on the screen:

1. From the main menu, highlight and select the SCREEN option. The SCREEN menu is displayed.
2. Use the ▲ and ▼ buttons to select the mode you want to change.
3. When the desired mode is highlighted, press the ► button. The selected mode screen will be displayed.

Use the ← and → arrow buttons to adjust the position of the picture.

NOTE: If you don't push the an arrow button within 5 seconds, the current setting is accepted and the previous screen reappears.

4. When you've adjusted to the desired setting, press the GO BACK button on the remote to return to the SCREEN menu.

The V-HEIGHT and H-WIDTH options expand and contract the size of the picture to fill the screen. For example, if the picture is slightly wider than the screen, you can use the H-WIDTH option to shrink the picture horizontally.

Note: These options are not available in STADIUM mode.

To adjust the screen size:

1. Select the desired option from the screen menu and press the ► button. The selected mode window will be displayed.
2. Use the ← and → arrow buttons to adjust the size of the picture.

NOTE: If you don't push an arrow button within 5 seconds, the current setting is accepted and the previous screen reappears.

3. When you've adjusted to the desired setting, press OK to select and return to the SCREEN menu.

AUTO PICTURE

The AUTO PICTURE function appears in the SCREEN menu only if you have a computer connected to the Cinema Screen display. When this feature is turned on, it automatically adjusts flickering and striped patterns in a computer image. If you want to adjust these manually:

1. Select the AUTO PICTURE option from the SCREEN menu. Press the ► button to turn AUTO PICTURE off. When AUTO PICTURE is turned off, the FINE PICTURE and PICTURE ADJ. options are displayed beneath it.
2. Select an option and press the ► button. The screen for that option will be displayed. Use the ◀ and ▶ buttons to adjust that option. Press OK to return to the SCREEN menu.

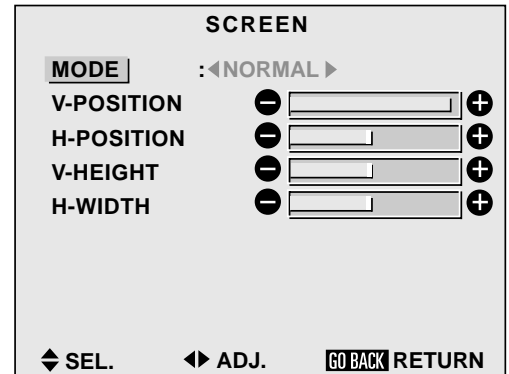

The SCREEN menu with the MODE option highlighted.

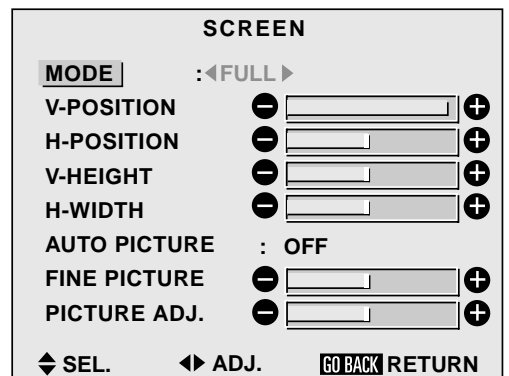

The AUTO PICTURE option only appears if you have a computer connected.

THE MENU SYSTEM

THE FUNCTION MENU

The FUNCTION menu contains options that control on-screen displays (other than the menu system) and how the picture is displayed.

ON-SCREEN DISPLAYS

On-screen displays (different than the menu system) appear by default to give you information about an option you have selected. For example, When you switch inputs the currently selected input name (for example, CMPNT1) is displayed on the screen. To turn on-screen displays off:

1. From the main menu, highlight and select the FUNCTION option. The FUNCTION menu is displayed.
2. Highlight and select the DISPLAY option. Use the ► button to toggle on-screen displays on or off.

Note: Turning the DISPLAY option off does not affect on-screen menus. Menus can't be turned off.

3. You can continue setting options in the FUNCTION menu, press GO BACK to return to the main menu, or press CLEAR to exit the menu system.

ADJUSTING THE POSITION OF THE MENU DISPLAY

The on-screen menus can be displayed in different positions on the screen. There are a total of nine possible positions shown in the grid on the right.

To adjust the position of the on-screen menus:

1. From the main menu, highlight and select the FUNCTION option. The FUNCTION menu is displayed.
2. Highlight and select the MENU ADJUST option. Use the ► button to scroll through the menu positions. As you press the ► button, the menu will move around to the different positions.
3. When you have the menu in the desired position you can press the ▲ or ▼ arrow to select another option in the FUNCTION menu, press GO BACK to return to the main menu, or press CLEAR to exit the menu system.

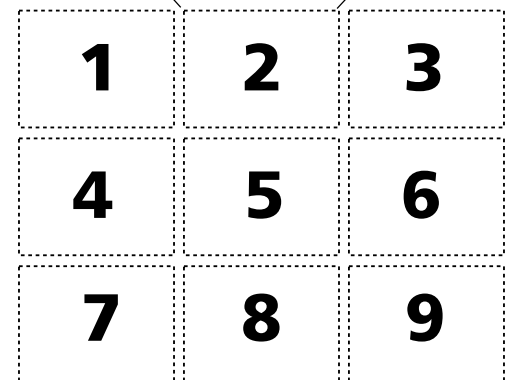
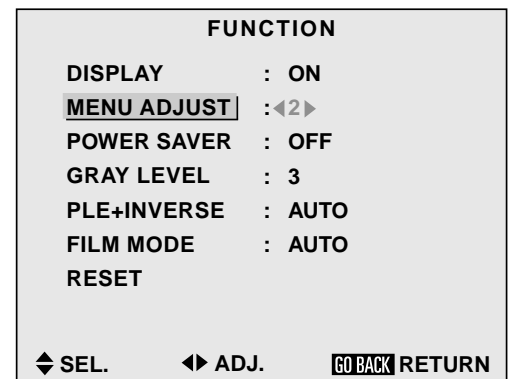
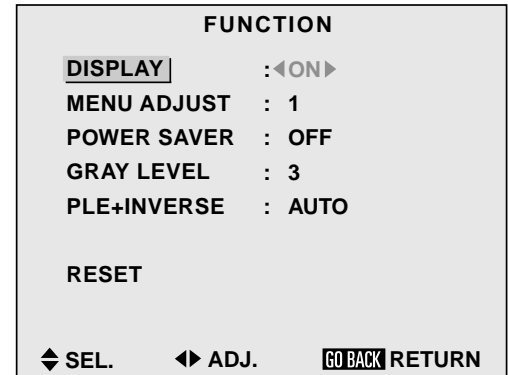

The number 2 position will display on-screen menus in the top center of your screen.

THE MENU SYSTEM

SETTING THE POWER SAVER FOR COMPUTER IMAGES

The POWER SAVER function can be used when the signal source to the monitor comes from a computer conforming to the VESA DPMS format. This function automatically reduces the monitor's power consumption if no operation is performed for a certain amount of time. POWER SAVER can be turned on or off.

If the computer's power isn't turned on or if the computer and selector tuner are not properly connected, POWER SAVER is set to OFF.

For instructions on using the computer's power management function, see your computer's operating manual.

To turn the Cinema Screen's POWER SAVER function on or off:

1. From the main menu, highlight and select FUNCTION. The FUNCTION menu is displayed.
2. Highlight the POWER SAVER option.
3. Use the ► button to toggle the setting ON or OFF.
4. You can continue making adjustments in the FUNCTION menu, return to the previous menu by pressing the GO BACK button or press CLEAR to exit the menu system.

The POWER/STANDBY indicator shows the status of the POWER SAVER function. See below for status and description.

FUNCTION	
DISPLAY	: ON
MENU ADJUST	: 1
POWER SAVER	: ◀ON▶
GRAY LEVEL	: 3
PLE+INVERSE	: AUTO
FILM MODE	: AUTO
RESET	
◆ SEL.	◀ ADJ. GO BACK RETURN

This is the FUNCTION menu with the POWER SAVER option highlighted.

POWER/STANDBY INDICATOR

POWER SAVER Mode	POWER/STANDBY indicator	Power Saver Operating Status	Description	Turning the Picture Back On
On	Green	Not activated	Horizontal and vertical synchronizing signals are present from the computer.	Picture already on.
Standby	Yellow	Activated	No horizontal synchronizing signals are present from the computer.	Use the keyboard or mouse. The picture reappears immediately.
Suspend	Red	Activated	No vertical synchronizing signals are present from the computer.	Use the keyboard or mouse. The picture reappears, but more slowly than when in standby mode.
Off	Red	Activated	No horizontal and vertical synchronizing signals are present from the computer.	Use the keyboard or mouse. The picture reappears, but more slowly than when in either standby or suspend mode.

THE MENU SYSTEM

SETTING THE GRAY LEVEL FOR THE SIDES OF THE SCREEN

The GRAY LEVEL function allows you to set the gray level for the sides of the screen where nothing is displayed (on the left and right sides of the screen when it is set to 4:3 size). The level can be adjusted from 0 to 15. The factory setting is 3 (dark gray).

NOTE: Repeated watching with the gray level set to black may effect the quality of your picture. To reduce the effects of uneven phosphor aging, set the gray level to 3 or 4.

To adjust the gray level for the sides of the screen:

1. From the main menu, highlight and select FUNCTION. The FUNCTION menu is displayed.
2. Highlight the GRAY LEVEL option.
3. Use the ► button to scroll through the levels.
4. When the desired gray level is highlighted, press the ◀ button to return to the FUNCTION menu options. You can continue making adjustments within the FUNCTION menu, press GO BACK to return to the previous menu or press CLEAR to exit the menu system.

SETTING THE BRIGHTNESS LEVEL WITH THE PLE+INVERSE

The PLE+INVERSE option contains two features in one. These features are used principally for PC operation.

The PLE (Peak Luminance Enhancement) function sets the luminance level to a fixed mode to reduce the effects of phosphor aging.

The INVERSE function works in RGB mode only. INVERSE inverts the video signal, playing the image in a negative format.

PLE+INVERSE has four options:

AUTO – luminance level (contrast) is normal.

AUTO+ON – normal contrast with inverse activated.

LOCK – dims picture to reduce phosphor aging.

LOCK+ON – dims picture to reduce phosphor aging with inverse activated.

The factory setting is AUTO. Setting the PLE+INVERSE option to LOCK dims the picture – the contrast will be lower than normal.

To set the PLE level to LOCK:

1. From the main menu, highlight and select FUNCTION. The FUNCTION menu is displayed.
2. Highlight the PLE+INVERSE option.
3. Use the ► button to select LOCK.
4. Press the ◀ button to return to the FUNCTION menu options. You can continue making adjustments within the FUNCTION menu, return to the previous menu or press MENU or CLEAR to exit the menu system.

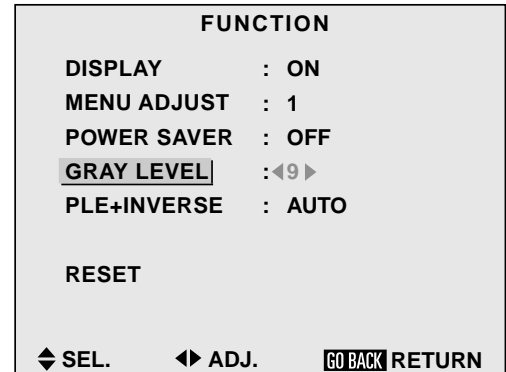

This is the FUNCTION menu with the GRAY LEVEL option highlighted.

NOTE: Repeated watching with the gray level set to black may effect the quality of your picture. To reduce the effects of uneven phosphor aging, set the gray level to 3 or 4.

If viewing with a 4/3 aspect ratio for long periods of time, set side gray level at 3 or 4.

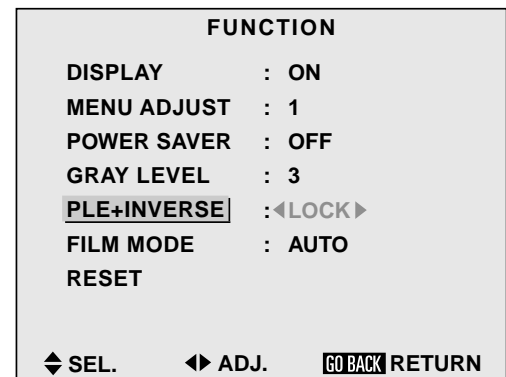

This is the FUNCTION option with the PLE+INVERSE option highlighted.

Setting PLE+INVERSE to LOCK is recommended if you are displaying stationary pictures.

THE MENU SYSTEM

ADJUSTING FOR FLICKERING WITH FILM MODE

There is some amount of flickering that occurs in an image when it is transferred from film to video. Setting the Film Mode option to Auto will reduce flickering and improve the quality of video images.

AUTO The display will recognize and correct any flickering that occurs in an image.

ON All images are displayed in film mode.

OFF Film mode is off.

To turn FILM MODE to AUTO:

1. From the main menu, highlight and select FUNCTION. The FUNCTION menu is displayed.
2. Highlight the FILM MODE option.
3. Use the ► button to scroll through the three modes until the AUTO is displayed.
4. Press the ◀ button to return to the FUNCTION menu options. You can continue making adjustments within the FUNCTION menu, return to the previous menu by pressing GO BACK or press CLEAR to exit the menu system.

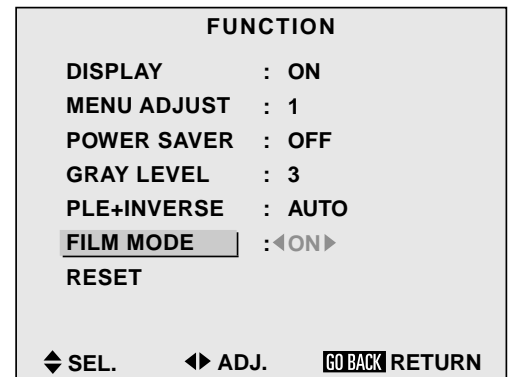

This is the FUNCTION menu with the FILM MODE option highlighted.

RESETTING TO DEFAULT VALUES

The RESET function allows you to reset all adjustments to the factory default settings. **Remember, this will reset all adjustments you have made in all menus.**

To reset to the factory default settings:

1. From the main menu, highlight and select OPTIONS. The OPTIONS menu is displayed.
2. Highlight the RESET function and press OK.
3. The RESET screen is displayed.
4. Use the ▲ or ▼ button to highlight the RESET option and press OK or MENU. The RESET screen will display the message NOW RESETTING. When the settings are restored to the factory default you are returned to the RESET screen.

When you are done, press GO BACK to return to the FUNCTION menu or press CLEAR to exit the menu system.

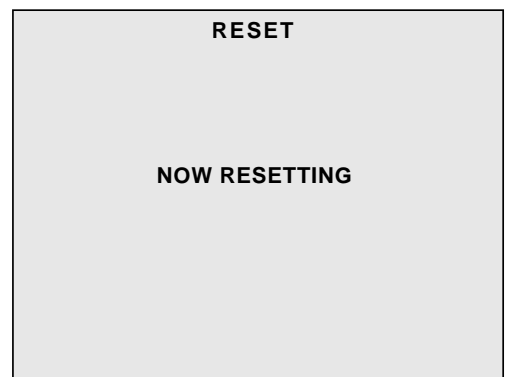
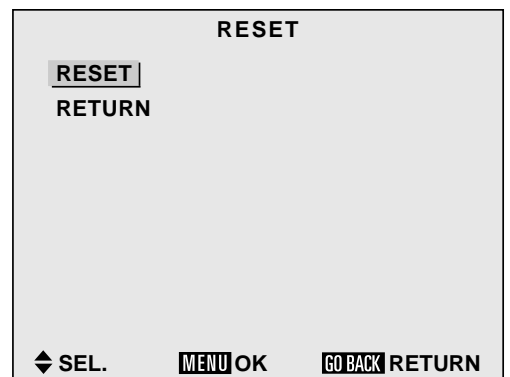

These are the RESET screens. Choose the RESET option if you want to reset ALL options in all menus back to the factory default.

THE MENU SYSTEM

THE OPTIONS MENU

SETTING THE AUDIO INPUTS

The Cinema Screen's audio sources are programmable to each of the display's video sources. For example, you can program AUDIO1 source to work with the RGB2 video source.

This feature is generally used only for commercial applications.

1. From the main menu, highlight and select OPTIONS. The OPTIONS menu is displayed.
2. Highlight the one of the audio input options.
3. Use the ► button to scroll through the available video sources. The modes scroll as follows:

VIDEO1 → VIDEO2 → VIDEO3 → HD/DVD1 → RGB1 → RGB2 → RGB3

4. When the desired mode is selected, press the ◀ button to return to the OPTIONS menu items. You can continue making adjustments within the OPTION menu, press GO BACK to return to the previous menu or press MENU or CLEAR to exit the menu system.

SETTING THE BNC CONNECTORS

By default, the BNC inputs are set to RGB1, or composite video. If the component you are connecting to the BNC jacks doesn't have composite video jacks, you can set the BNC inputs to act as component video.

1. From the main menu, highlight and select OPTIONS. The OPTIONS menu is displayed.
2. Highlight the BNC SELECT option.
3. Use the ► button to toggle between RGB2 (composite) and CMPNT2. (component).
4. Once you've selected the desired setting, press the ◀ button to return to the OPTIONS menu items or press CLEAR to return to the main menu.

The factory defaults are as follows:

- RGB1 – AUDIO1
- VIDEO INPUTS – AUDIO 2
- COMPONENT INPUTS – AUDIO3

If you use the reset option, the settings will return to the factory default settings.

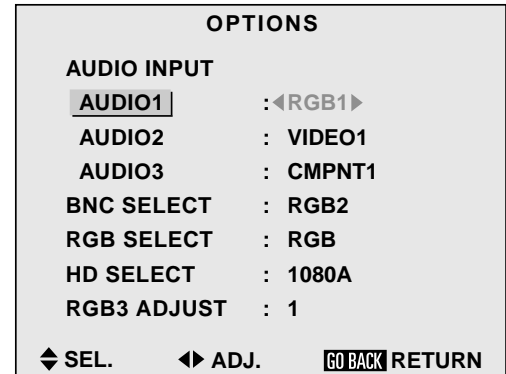

This is the OPTIONS menu with the AUDIO1 input option highlighted.

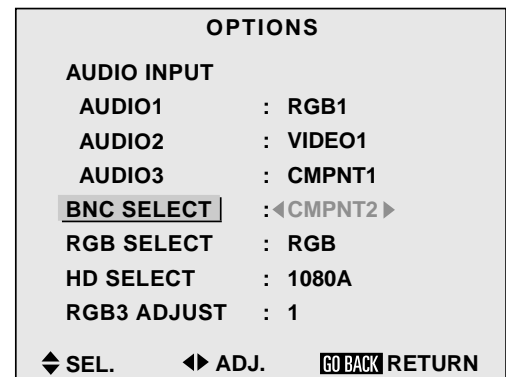

This is the OPTIONS menu with the BNC SELECT option highlighted.

THE MENU SYSTEM

SETTING A COMPUTER IMAGE TO THE CORRECT RGB SELECT MODE

The RGB function allows you to select the correct viewing mode for the type of computer image you are displaying.

The RGB SELECT function has four modes:

RGB – Use this mode for normal computer images.

VIDEO – Use this mode to display video signal that has been converted to the RGB signal.

WIDE – Use this mode to prevent an image that is inputted from 852 dot X 480 line signal with a vertical frequency of 31.72 KHz from being compressed horizontally.

DTV – This mode is primarily used to optimize picture quality if you are using a generic-brand DTV receiver which output signal at 480P (progressive scan) lines.

To change the RGB SELECT mode:

1. From the main menu, highlight and select the **OPTIONS** menu. The **OPTIONS** menu is displayed.
2. Highlight the **RGB MODE** option.
3. Use the **▶** button to scroll through the mode choices. The settings switch as follows:

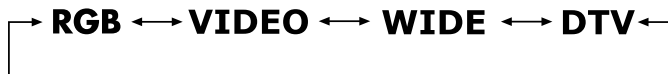

4. When the desired mode is selected, press the **◀** button to return the the **OPTIONS** menu items. You can continue making adjustments within the **OPTIONS** menu, press **GO BACK** to return to the previous menu or press **CLEAR** to exit the menu system.

OPTIONS	
AUDIO INPUT	
AUDIO1	: RGB1
AUDIO2	: VIDEO1
AUDIO3	: CMPNT1
BNC SELECT	: RGB2
RGB SELECT	: ◀ VIDEO ▶
HD SELECT	: 1080A
RGB3 ADJUST	: 1
◀ SEL.	◀ ADJ. GO BACK RETURN

*This is the **OPTIONS** menu with the **RGB SELECT** option highlighted.*

THE MENU SYSTEM

SETTING THE CINEMA SCREEN MONITOR TO THE CORRECT HD RECEIVER MODE

The HD SELECT function allows you to select the correct mode for the Cinema Screen monitor to work with your HD receiver. The default setting is 1080A. This is the correct setting for all RCA and PROSCAN HD receivers. If you have another brand of HD receiver, your picture may appear broken or off-center. If so, you need to switch HD SELECT modes.

1080A – Use this option for RCA or PROSCAN HD receivers.

1080B – Use this option if you have any other brand of HD receiver.

To change the receiver mode:

1. From the main menu, highlight and select OPTIONS. The OPTIONS menu is displayed.
2. Highlight the HD SELECT option.
3. Use the ► button to select the desired mode (1080 A or 1080 B).
4. When the desired number is selected, press the ◀ button to return the the OPTIONS menu items. You can continue making adjustments within the OPTIONS menu, press GO BACK to return to the previous menu or press MENU or CLEAR to exit the menu system.

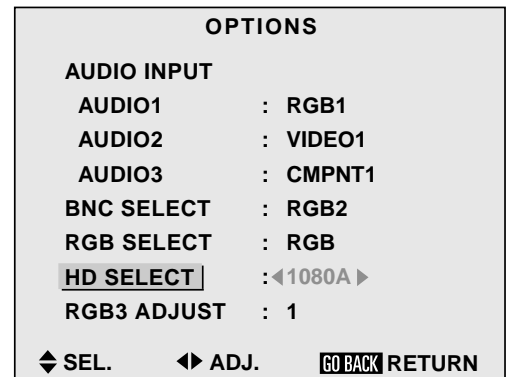

This is the OPTIONS menu with the HD SELECT option highlighted.

ADJUSTING THE DISPLAY IN RGB3 INPUT MODE

If the picture is not stable in RGB3 mode, use the RG ADJUST feature to adjust it.

1. From the main menu, highlight and select OPTIONS. The OPTIONS menu is displayed.
2. Highlight the RGB3 ADJUST option.
3. Use the ► button to select the desired adjustment (1, 2 or 3). The choices scroll as follows:

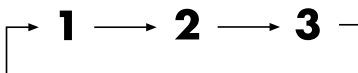

4. When the desired number is selected, press the ◀ button to return the the OPTIONS menu items. You can continue making adjustments within the OPTIONS menu, press GO BACK to return to the previous menu or press MENU or CLEAR to exit the menu system.

Note: When AUTO PICTURE is on, switch it off and back on again to return the display position to its original position.

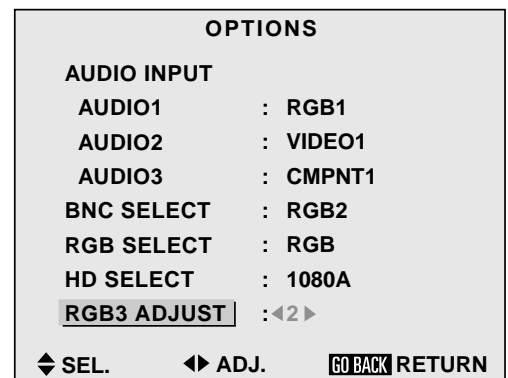

This is the OPTIONS menu with the RGB3 ADJ. option highlighted.

THE MENU SYSTEM

THE SETUP MENU

The SETUP menu controls the way your monitor communicates.

CONFIRMING THE FREQUENCIES AND POLARITIES OF INPUT SIGNALS

The FREQUENCY function is used to confirm the frequencies and polarities of the signals coming from a computer.

To confirm frequencies and polarities:

1. From the main menu, highlight and select the SETUP option. The SETUP menu is displayed.
2. Highlight the FREQUENCY option and press OK.
3. The FREQUENCY screen is displayed.

Press GO BACK to return to the INFORMATION menu, or press CLEAR to exit the menu system.

SELECTING THE LANGUAGE FOR THE MENUS

The menu display can be set to one of three languages: English, French or Spanish. The default is English. To change the default setting:

1. From the main menu, highlight and select the SETUP option. The SETUP menu is displayed.
2. Highlight the MENU LANGUAGE option. The MENU LANGUAGE screen is displayed.
3. Use the ► button to scroll through the language choices. The settings switch as follows:

→ **ENGLISH** ↔ **FRANÇAIS** ↔ **ESPAÑOL** ←

4. When the desired language is highlighted, press GO BACK to return to the SETUP menu. You can continue making adjustments within the SETUP menu, press GO BACK to return to the main menu, or press CLEAR to exit the menu system.

SETTING THE VIDEO SIGNAL FORMAT

The COLOR SYSTEM option is used to set the video signal format. Different countries used different formats for video signals. The AUTO option automatically detects the correct video signal and sets the correct format. This setting should not be changed.

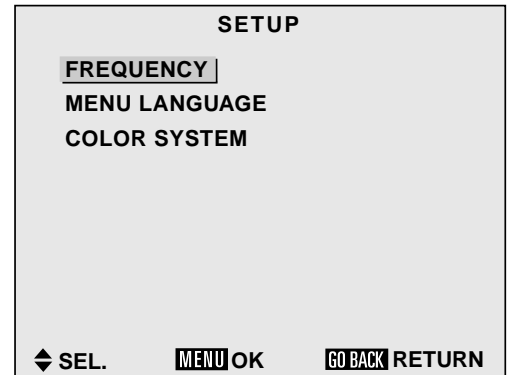

This is the SETUP menu with the FREQUENCY option highlighted.

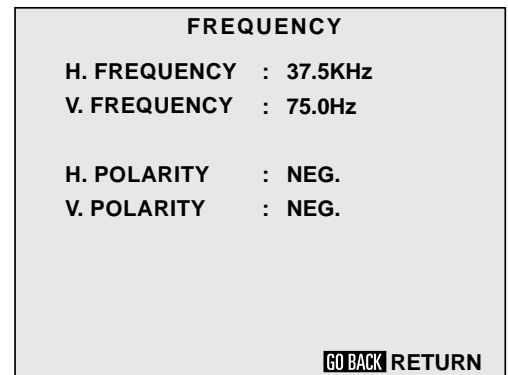

This is the FREQUENCY screen.

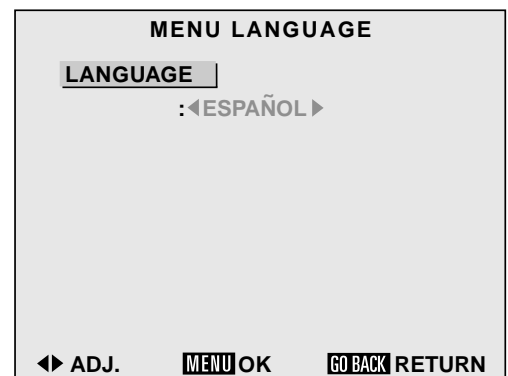

This is the MENU LANGUAGE screen with Spanish as the selected language.

THE MENU SYSTEM

THE AUTOTUNING MENU

AUTOTUNING THE COMPONENT BUTTONS ON THE REMOTE CONTROL

The AUTOTUNING feature lets you easily program the component buttons on the remote to operate the components hooked up to the Cinema Screen monitor. To autotune your components to the buttons on the remote:

1. From the main menu, highlight and select the AUTOTUNING SETUP option. The AUTOTUNING SETUP menu is displayed.
2. Highlight an option which corresponds to a component which you've connected. For example, if you have a DVD player connected, highlight the DVD BUTTON option.
3. Use the ► button to scroll through the output choices. Select the choice which corresponds to the jacks you used to connect the DVD player. In the example illustration on the right, the DVD button on the remote will operate the component connected to the CMPNT1 jacks (the DVD player).
4. When the desired option is displayed, press the ◀ button to return the the AUTOTUNING menu options. You can continue making adjustments within the OPTIONS menu, press GO BACK to return to the previous menu or press CLEAR to exit the menu system.

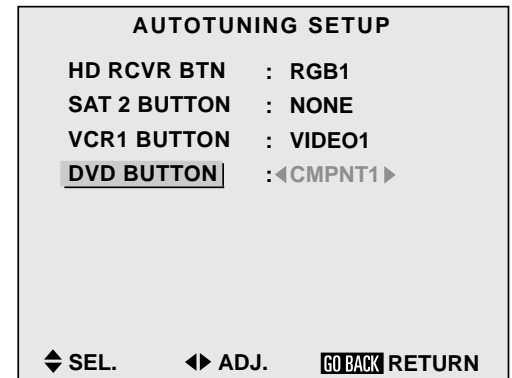

This is the AUTOTUNE menu with the DVD BUTTON option highlighted.

THE MENU SYSTEM

SLEEP TIMER

The sleep timer is a feature that allows you to set the monitor to turn off after a prescribed amount of time. It can be set to turn the power off after 30, 60, 90 or 120 minutes.

SETTING THE SLEEP TIMER

1. Press the SLEEP button on the remote to turn on the timer. The default is 30 minutes.
2. Press the SLEEP button again to move to the next time increment. Press the SLEEP button until you get to the desired time.

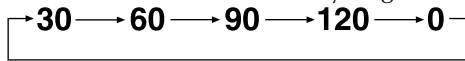

3. The timer starts when the Sleep display turns off.

TO CHECK THE REMAINING TIME:

1. Once the sleep timer has been set and the menu has turned off, press the SLEEP button once.
2. The remaining time is displayed, then disappears after a few seconds.
3. When five minutes remain, the remaining time appears until it reaches zero.

CANCELLING THE SLEEP TIMER

1. Press the SLEEP button twice in a row.
2. The sleep timer is canceled.

NOTE: After the power is turned off with the sleep timer, a slight current is still supplied to the monitor. If you do not plan to use the system for a long period of time, turn the power off with the remote or on the unit.

REFERENCE

TECHNICAL INFORMATION

This section contains technical reference information about your Cinema Screen monitor, as well accessory and warranty information.

1 SETUP AND
CONNECTIONS



2 THE MENU SYSTEM



3 REFERENCE

REFERENCE

INSTALLING THE CINEMA SCREEN MONITOR

IMPORTANT

- This device cannot stand on its own. Be sure to use a stand or original mounting unit.
- For correct installation and mounting it is strongly recommended to use a trained, authorized Cinema Screen dealer. Failure to follow correct mounting procedures could result in damage to the equipment or injury to the installer. Product warranty does not cover damage caused by improper installation.

ATTACHING OPTIONAL MOUNTS OR STAND TO THE CINEMA SCREEN MONITOR

The Cinema Screen monitor can be mounted on the wall using an optional wall mount or you can attach a floor stand (also optional). For more information on mounting your Cinema Screen Display, see your Cinema Screen dealer.

If you choose to use the optional wall mount, it can be attached to the Cinema Screen monitor in one of the following two ways:

- While it is upright.
- While it is laying with the screen face down. If you choose this option, lay the protective sheet that came wrapped around the monitor beneath the screen surface so it doesn't get scratched.

VENTILATION REQUIREMENTS FOR ENCLOSURE MOUNTING

To allow heat to disperse, leave space between surrounding objects as shown on the diagram below when installing.

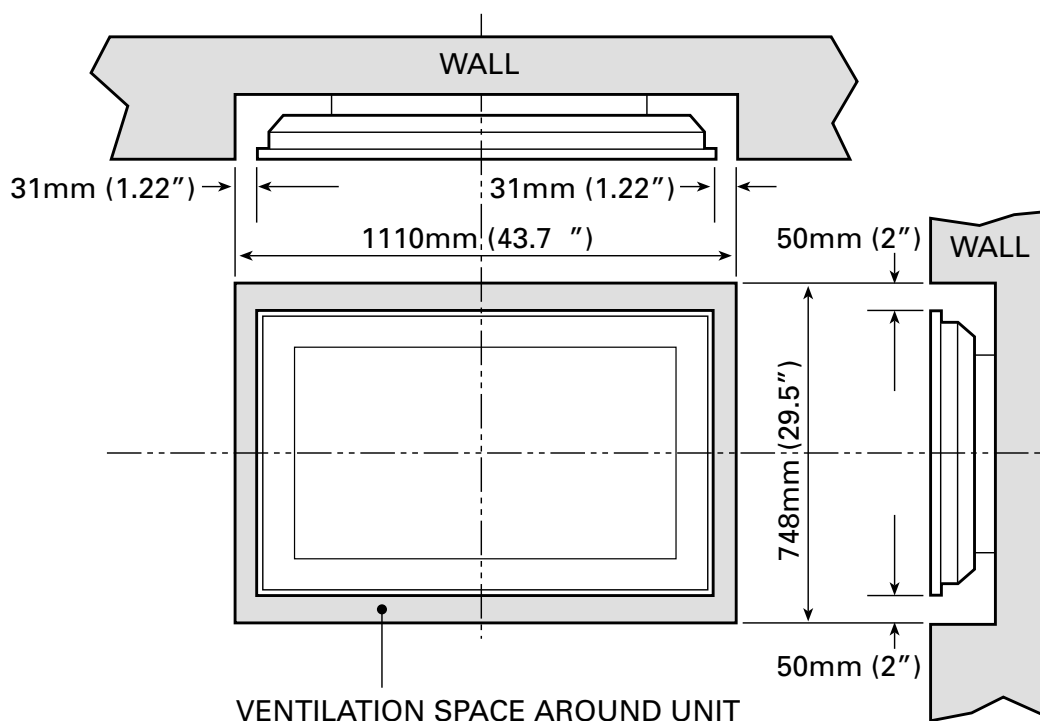

REFERENCE

CONNECTING YOUR PC OR MACINTOSH COMPUTER

Connecting your PC or Macintosh computer to your Cinema Screen monitor will enable you to display computer images on the monitor. The Cinema Screen monitor supports the signals described on page 48.

If you are connecting a computer to the monitor, you must attach the ferrite cores to both ends of the DVI cable to meet FCC standards (see page 6). To connect to a PC, Macintosh or compatible graphics adapter:

1. Turn off the power to your monitor and computer.
2. If your PC does not support XGA/SVGA/VGA you will need to install an XGA/SVGA/VGA graphics board. Consult your computer's owner's manual for your SXGA/XGA/ SVGA/VGA configuration. If you need to install a new board, see the manual that comes with your new graphics board for installation instructions.
3. The Cinema Screen monitor provides signal compatibility with VESA 1280x1024@60MHz (SXGA). However, we recommend not using this resolution due to image readability on the monitor's 853 X 480 native pixel resolution panel.
4. Use the signal cable that's supplied to connect your PC or Macintosh computer to the Cinema Screen monitor. For Macintosh, you will need a monitor adapter (not supplied) to connect to your computer's video port.
5. Turn on the monitor and the computer.
6. If the Cinema Screen monitor goes blank after a period of inactivity, it may be caused by a screen saver installed on the computer you've connected to the monitor.

When using a Macintosh with the Cinema Screen monitor, the following three display standards are supported using the included Macintosh adapter : 13" fixed mode, 16" fixed mode, and 19" fixed mode. The 13" fixed mode is recommended for the Cinema Screen monitor.

MINI D-SUB 15 PIN VGA SIGNAL COMPOSITION

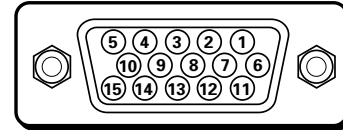

Pin No.	Signal to be connected
1	RED
2	GREEN or sync. on Green
3	BLUE
4	No connection
5	GND
6	RED (GND)
7	GREEN (GND)
8	BLUE (GND)
9	No connection
10	SYNC (GND)
11	No connection
12	SDA
13	H. Sync
14	V. sync
15	SCL

REFERENCE

SPECIFICATIONS

Product Name	PSP42300 Cinema Screen Monitor 36.3"(H) X 20.4"(V) inches
Screen Size	921(H) X 518.4(V) mm diagonal 42"
Aspect Ratio	16 : 9
Resolution	853(H) X 480(V) pixels
Color Reproduction	256 levels, 16,770,000 colors
Input Signals	RGB, NTSC (3.584.43), PAL (B, G, M, N), PAL60,
RGB Input terminals	SECAM, HD*1, DVD*1, DTV*
Visual 1	mini D-sub 15-pin
Visual 2	BNC (R, G, B, H/CS, V) X1
Visual 3	DVI-I 29-pin X 1*2
Video Input terminals	
Visual 1	RCA-pin X 1
Visual 2	BNC X 1
Visual 3	S-Video: DIN 4-pin X 1
DVD/HD/DTV	
Visual	RCA-pin (Y, P _B [C _B], PR[C _R])
Audio	Stereo RCA X 3
External Control	D-sub 9-pin X1 (RS-232C)
Sound Output	7W+7W at 6 to 8 ohm
Power Supply	AC120V 50/60Hz
Current Rating	4.2A (maximum)
Power Consumption	395W (typical)
Dimensions (WxDxD)	1048 X 648 X 89mm (w/o stand) 41.3 X 25.5 X 3.5 inches (w/o stand) 1084 X 746 X 360mm (with stand)
Net Weight	32 Kg/70.6 lbs. (w/o stand)
Environmental Considerations	0°C to 40°C/32°F to 104°F
Operating temperature	20 to 80%
Humidity	0 to 1900m/0 to 6230 ft.
Altitude	-10°C to 50°C/14°F to 122°F
Storage temperature	10 to 90%
Humidity	0 to 3000m/0 to 9840 ft.
Altitude	Power on/off, Input source select,
Front Panel User Controls	Volume up/down/OSM control
Other Features	Power Management, plug and play (DDCI, DDC2b, RGB3: DDC2b only)
Accessories	Remote control with two AA batteries, RGB cable (Mini D-sub 15 pin to Mini D-sub 15-pin connector), power cord, safety metal fitting, screw for safety metal fitting, User's Manual UL approved (UL 1950, CSA 950) DOC Canada requirements
Regulations	Meets FCC class B requirements for home application

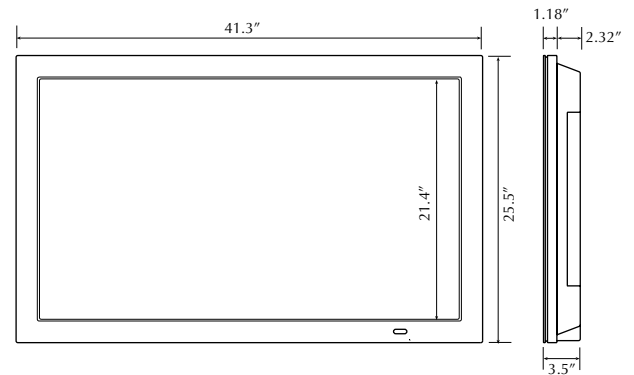

The features and specifications may be subject to change without notice.

* DTV input signals supported on this system
1080i (60 Hz)
480P (60 Hz)
480i (60 Hz)
720P (60 Hz)

REFERENCE

TROUBLESHOOTING

Before requesting service, check the adjustments, operations, etc.

Symptom	Possible Problem	Solutions
Picture is disturbed. Sound is noisy. Remote control unit operates erroneously.	<ul style="list-style-type: none"> Is a connected component set directly in front or at the side of the monitor? 	<ul style="list-style-type: none"> Leave some space between the display and connected components.
The remote control does not work.	<ul style="list-style-type: none"> Remote control batteries may be dead. Remote may be in wrong mode. 	<ul style="list-style-type: none"> Replace both batteries with new ones. Press component button for desired component.
Monitor's power does not turn on when the remote control's power button is pressed.	<ul style="list-style-type: none"> Is the monitor's power cord plugged into a power outlet? 	<ul style="list-style-type: none"> Plug the monitor's power cord into a power outlet.
	<ul style="list-style-type: none"> Are all the monitor's indicators off? 	<ul style="list-style-type: none"> Press the power button on the monitor to turn on the power.
Monitor does not operate when the remote control's buttons are pressed.	<ul style="list-style-type: none"> Is the remote control pointed at the monitor, or is there an obstacle between the remote control and the monitor? 	<ul style="list-style-type: none"> Point the remote control at the monitor's remote control sensor when pressing buttons, or remove the obstacle.
	<ul style="list-style-type: none"> Is direct sunlight or strong artificial light shining on the monitor's remote control sensor? 	<ul style="list-style-type: none"> Eliminate the light by closing curtains, pointing the light in a different direction, etc.
	<ul style="list-style-type: none"> Remote control batteries may be dead. 	<ul style="list-style-type: none"> Replace both batteries with new ones.
No sound or picture is produced.	<ul style="list-style-type: none"> Is the monitor's power cord plugged into a power outlet? 	<ul style="list-style-type: none"> Plug the monitor's power cord into a power outlet.
	<ul style="list-style-type: none"> Is the source video connected and on? 	<ul style="list-style-type: none"> Make sure source video (VCR, DVD, DTC) is connected and turned on.
Picture appears but no sound is produced.	<ul style="list-style-type: none"> Is the volume set at the minimum? 	<ul style="list-style-type: none"> Increase the volume.
	<ul style="list-style-type: none"> Is the mute mode set? 	<ul style="list-style-type: none"> Press the remote control's mute button.
	<ul style="list-style-type: none"> Are the speakers properly connected? 	<ul style="list-style-type: none"> Connect the speakers properly.
Tint is poor or colors are weak.	<ul style="list-style-type: none"> Are the tint and colors properly adjusted? 	<ul style="list-style-type: none"> Adjust the tint and color (under PICTURE). Return to factory reset.
Nothing appears on screen.	<ul style="list-style-type: none"> Is the computer's power turned on? 	<ul style="list-style-type: none"> Turn on the computer's power.
	<ul style="list-style-type: none"> Is a video source connected? 	<ul style="list-style-type: none"> Connect video source to the monitor.
	<ul style="list-style-type: none"> Is the power manager function in the STANDBY or OFF mode? 	<ul style="list-style-type: none"> Operate the computer (move the mouse, etc.).
Part of picture is cut off or picture is not centered.	<ul style="list-style-type: none"> Is the picture position adjusted correctly? 	<ul style="list-style-type: none"> Adjust the picture from the SCREEN menu.
Image is too large or too small.	<ul style="list-style-type: none"> Is the screen size adjusted correctly? 	<ul style="list-style-type: none"> Press the WIDE/AUTO WIDE button on the remote control and adjust properly.
Picture is unstable.	<ul style="list-style-type: none"> Is the computer set at the correct resolution? 	<ul style="list-style-type: none"> Set to the proper resolution.
	<ul style="list-style-type: none"> Is the HD receiver set to the correct mode? 	<ul style="list-style-type: none"> Set HD receiver to the correct mode (page 29).

REFERENCE

THE CINEMA SCREEN MONITOR MENU SYSTEM

Main menu	Sub menu	Functions
PICTURE QUALITY	CONTRAST	Adjusts the contrast.
	BLACK LEVEL	Adjusts the brightness.
	SHARPNESS	Adjusts the sharpness.
	COLOR	Adjusts the color density (video input only).
	TINT	Adjusts the picture tint (video input only).
	PRESETS	Sets the picture mode according to the video environment.
	COLOR TEMP.	Adjusts the color temperature and white balance.
	NOISE REDUCE	Reduces noise visible in image.

Main menu	Sub menu	Functions
AUDIO	BASS	Sets the bass.
	TREBLE	Sets the treble.
	BALANCE	Sets the left/right balance.

Main menu	Sub menu	Functions
SCREEN	V-POSITION	Adjusts the vertical picture position of the picture on the screen.
	H-POSITION	Adjusts the horizontal picture position of the picture on the screen.
	V-HEIGHT	Adjusts the vertical size of the picture.
	H-WIDTH	Adjusts the horizontal size of the picture.
	AUTO PICTURE	When turned on, automatically adjusts for flickering and striped patterns.
	FINE PICTURE	Adjusts for flickering in the picture.
	PICTURE ADJ.	Adjusts for striped patterns in the picture.

Main menu	Sub menu	Functions
FUNCTION	DISPLAY	Turns the on-screen display on and off.
	MENU ADJUST	Adjusts the vertical and horizontal position of the menu display.
	POWER SAVER	Sets the monitor for use as an energy-saving display when used with a computer.
	GRAY LEVEL	When viewing a picture with 4:3 aspect ratio, sets the luminance of both sides of the picture.
	PLE+INVERSE	Sets the brightness level to the minimum in VGA mode. Normally set to AUTO.
	FILM MODE	When turned to AUTO, selects the correct viewing format.
	RESET	Resets ALL the settings to the factory default values.

REFERENCE

Main menu	Sub menu	Functions
OPTION	AUDIO INPUT	Allocates audio connectors.
	BNC SELECT	Sets BNC connectors to either composite or component video.
	RGB SELECT	Sets the appropriate mode for the computer image. RGB (VGA signals), VIDEO (Moving picture), WIDE (WIDE VGA) DTV.
	HD SELECT	Sets correct mode for your HD digital receiver (1080 A or 1080 B).
	RGB3 ADJUST	Adjusts the display position in RGB3 input.
Main menu	Sub menu	Functions
SETUP	FREQUENCY	Confirms the frequency and synchronizing polarities of the signal currently being inputted.
	MENU LANGUAGE	Sets the language of the menus (English, French, or Spanish)
	COLOR SYSTEM	Sets the VIDEO format. Keep this set to AUTO.
Main menu	Sub menu	Functions
AUTOTUNING SETUP	HD RCVR BTN	Autotunes the HD RCVR button on the remote control to the input that your HD receiver is hooked up to.
	SAT2 BUTTON	Autotunes the SAT2 button on the remote control to the input that your satellite receiver is hooked up to.
	VCR1 BUTTON	Autotunes the VCR button on the remote control to the input that your VCR is hooked up to.
	DVD BUTTON	Autotunes the DVD button on the remote control to the input that your DVD player is hooked up to.

REFERENCE

SUPPORTED RESOLUTION

- When screen mode is NORMAL, each signal is converted to 640 dot X 480 line signal (except for *3).
- When screen mode is FULL, each signal is converted to 853 dot X 480 line signal (except for *2).

Notes:

- With Digital inputs some signals are not accepted.
- The sync may not be disturbed when non-standard signals other than the previously mentioned are input.
- When connecting a composite sync signal, use the HD terminal.

Model	Dots X lines	Vertical frequency (Hz)	Vertical frequency (kHz)	Screen mode	
				NORMAL	FULL
*IBM PC/AT compatible computers	640 X 400	70.1	31.5	YES ^{*1}	YES ^{*1}
	640 X 480	59.9	31.5	YES	YES
		72.8	37.9	YES	YES
		75.0	37.5	YES	YES
		85.0	43.3	YES	YES
		100.0	51.1	YES	YES
		120.0	61.3	--	YES
	848 X 480 ^{*2}	60.0	31.0	YES	YES
	800 X 600	56.3	35.2	YES	YES
		60.3	37.9	YES	YES
		72.2	48.1	YES	YES
		75.0	46.9	YES	YES
		85.0	53.7	YES	YES
		100.0	63.0	YES	YES
	1024 X 768	120.0	75.7	YES	YES
		60.0	48.4	YES	YES
		70.0	56.5	YES	YES
75.0		60.0	YES	YES	
85.0		80.5	YES	NO	
100.0	68.7	YES	NO		
1280 X 1024	60.0	64.0	YES ^{*3}	YES	
*Apple Macintosh	640 X 480	66.6	48.4	YES	YES
	832 X 624	74.6	56.5	YES	YES
	1024 X 768	74.9	60.0	YES	NO
	1152 X 870	75.1	68.7	YES	NO

*1 Displays only 400 lines with screen center of the vertical orientation located at the center.

*2 Only when using a graphic accelerator board that is capable of displaying 848 X 480.

*3 Aspect ratio is 5:4. This signal is converted to a 600 X 480 line signal.

* IBM is a registered trademark of International Business Machines Corporation of the United States.

* Macintosh is a registered trademark of Apple Computer, Inc. of the United States.

REFERENCE

RCA CINEMA SCREEN DISPLAY LIMITED WARRANTY

WHAT YOUR WARRANTY COVERS:

Any defect in materials or workmanship.

FOR HOW LONG AFTER YOUR PURCHASE:

- One year for labor charges.
- One year for parts.

The warranty period for rental units begins with the first rental or 45 days from date of shipment to the rental firm, whichever comes first.

WHAT WE WILL DO:

Exchange your unit with a new or, at our option, refurbished unit.

HOW YOU GET YOUR UNIT REPAIRED:

- Call 1-800-433-8974 and have your unit's date of purchase and model/serial number ready.
- A representative will troubleshoot your problem over the phone.
- If the representative determines that you should receive service, they will provide you with the name(s) of the Authorized Cinema Screen Display Service Center in your area.
- Contact the Service Center and arrange for home service.
- Show the Authorized Service Center Representative your sales receipt or other evidence of purchase or first rental.
- The Authorized Service Center will repair your unit or make arrangements to deliver a new or refurbished unit and pick up your defective display all in one trip at no cost to you.

WHAT YOUR WARRANTY DOES NOT COVER:

- Customer instruction. (Your Owner's Manual clearly describes how to install, adjust, and operate your display. Any additional information should be obtained from your dealer.)
- Signal reception problems not caused by your Cinema Screen display.
- Damage from misuse or neglect.
- Batteries.
- A display purchased or serviced outside the U.S.A.
- Acts of Nature, such as but not limited to lightning damage.

PRODUCT REGISTRATION:

Please complete and mail the Product Registration Card packed with your unit. It will make it easier to contact you should it ever be necessary. The return of the card is not required for warranty coverage.

HOW STATE LAW RELATES TO WARRANTY:

This warranty gives you specific legal rights and you also may have other rights that vary from state to state.

IF YOU PURCHASED YOUR DISPLAY UNIT OUTSIDE THE UNITED STATES:

This warranty does not apply. Contact your dealer for warranty information.

Service calls which do not involve defective materials or workmanship are not covered by this warranty. Costs of such service calls are the sole responsibility of the purchaser.

CINEMA SCREEN DISPLAY ACCESSORIES

The Cinema Screen accessories listed below are available from your Cinema Screen Dealer. See your dealer for prices.

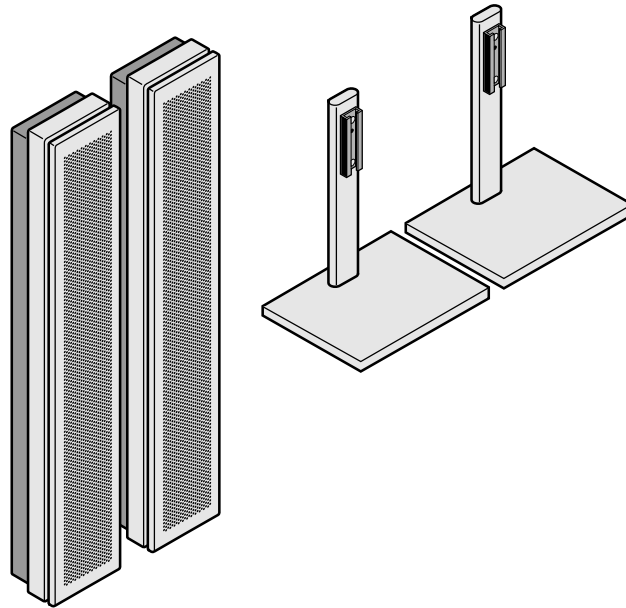

CINEMA SCREEN ATTACHABLE SPEAKERS – SPK42

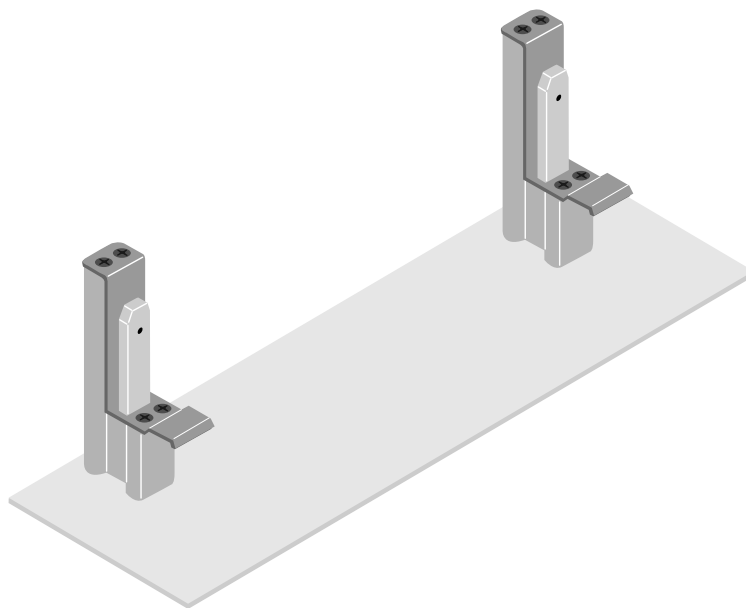

CINEMA SCREEN DISPLAY STAND – PLBI

Index

Symbols

1080A 37
1080B 37

A

Antenna button 13
Arrow buttons 13
Audio input 35
Audio menu 28, 46
Automatic Code Search 16
Auto picture 30
Autotuning 39, 47
Aux button 13

B

Balance 28
Bass 28
Batteries 9, 15
Bias 26
BNC select 35
Black level 25

C

CH+/CH- button 13
Cinema button 13
Clear button 13
CMPNT button 13
Color system 38
Components
 Connecting 11
Computers
 Connecting 11, 43
Contrast 25
Control Lock 8

D

Default values
 resetting 34, 46
DTV 36
DVD button 13
DVD Player 10, 11

E

External control 8
External Speakers 12, 50

F

Ferrite cores 6
Film mode 34
Frequencies and Polarities of Input
 Signals 38
Function menu 31, 46

G

Gain 26
Go back button 13
Gray level 33
Guide button 13

H

HD select 37
HD RCVR button 14
HD Receiver
 Connecting 9
HD receiver 9
HD Receiver Mode 37
 1080A 37
 1080B 37

I

Info button 13
Input button 13
Input • Go Back 7
Inserting batteries in the remote 15
Installation 42
 Floor Stand 42
 Speakers 42
 Ventilation requirements 42

J

Jacks 8, 11
 AC IN 8
 External Speakers 8, 50
 External Control 8
 Video in/Audio in 8

L

Language for the Menus 38
Laser Disc Player 10

M

Macintosh computer
 connecting 43
Memory Mode 24
Menu button 14
Menu • OK 7
Menu display
 position 31
Menu System 23, 46
Mini D-sub 15 Pin VGA Signal Compo-
 sition 43
Monitor button 14
Mute 22

N

Navigating the menus 23
Noise Reduction 27
Number buttons 14

O

OK button 14
On•Off button 14
On-screen Menus 23
 Display position 31
Options menu 35, 47

P

Personal computer
 connecting 10, 11, 43
Picture Quality menu 24, 46
Picture mode
 Bright 24
 Memory 24
 Normal 24
 Preset 24
 Soft 24
Picture position 30, 31
PLE+INVERSE 33
Power 22
Power cord 6
Power Saver 32
Power/standby indicator 32
Programming the remote 15
Presets 24

R

Reducing noise in the picture 27
Remote Control
 Automatic Code Search 16
 Buttons 13,14
 Codes 18
 inserting batteries 15
 Mute 22
 Navigating the Menus 23
 Programmable Codes 18
 Programming the Remote 16
Resetting to default values 34
RGB Select 36

S

Safety information 1, 2
Safety metal fitting 6
Screen menu 29, 46

- Screen size
 - Fill 29
 - Full 29
 - Normal 29
 - Stadium 29
- Setting the Color Temperature 26
- Setup menu 38, 47
- Sharpness 25
- Sleep button 14
- Sleep timer
 - Cancelling 40
 - Checking 40
 - Setting 40
- Speakers 12, 50
- Specifications 44
- Stand
 - using with Cinema Screen display 42, 50
- T**
- TREBLE 28
- Troubleshooting 45
- V**
- VCR 10
- VCR1 button 14
- VCR2 button 14
- Ventilation Requirements 42
- Video button 14
- Video 36
- Viewing size
 - selecting 29
- Volume 14, 22
- Vol+/- buttons 14, 22
- W**
- Warranty 49
- Wide 36
- Z**
- Zoom 7, 14
- Zoom in/Zoom out buttons 14

Please do not send any products to the address listed in this manual or on the carton. This will only add delays in service for your product.

 **THOMSON CONSUMER ELECTRONICS**

**10330 N. Meridian St.
Indianapolis, IN 46290**

©2001 Thomson Consumer Electronics, Inc.

Trademark(s) ® Registered

Marca(s) Registrada(s)

Printed in USA

TOCOM 15730280

Free Manuals Download Website

<http://myh66.com>

<http://usermanuals.us>

<http://www.somanuals.com>

<http://www.4manuals.cc>

<http://www.manual-lib.com>

<http://www.404manual.com>

<http://www.luxmanual.com>

<http://aubethermostatmanual.com>

Golf course search by state

<http://golfingnear.com>

Email search by domain

<http://emailbydomain.com>

Auto manuals search

<http://auto.somanuals.com>

TV manuals search

<http://tv.somanuals.com>