

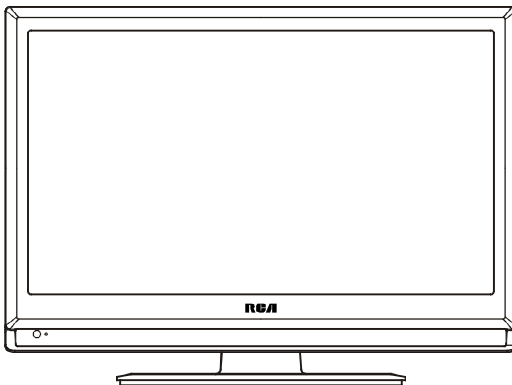

LCD Television

RLC2226

Operating instructions



Keep this manual for future reference.

"RCA", "NIPPER & CHIPPER" ARE TRADEMARKS OF
RCA TRADEMARK MANAGEMENT
USED UNDER LICENSE TO CURTIS INTERNATIONAL LTD.

Important Safety Instructions and Maintenance

Important Safety Instructions

CAUTION

Risk of electronic shock, do not open.
Do not attempt to service this product yourself as opening or removing covers may expose you to dangerous voltage or other hazards.
Refer all servicing to qualified service personnel.

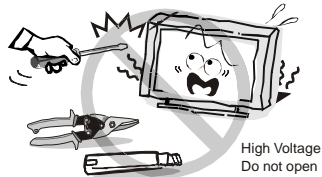

To reduce the risk of fire or electric shock, do not expose this product to rain or moisture.
The apparatus shall not be exposed to dripping or splashing and no objects filled with liquids, such as vases, shall be placed on the apparatus.



In case of smoke, strange noise or strange smell from the unit:

Turn off the power switch immediately;
Disconnect the power plug from the power outlet;
Contact your dealer or service centre. Never attempt to make repairs yourself because this could be dangerous.

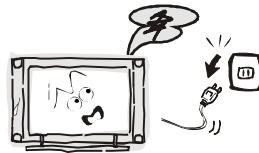

Never push objects of any kind into the set through the cabinet slots as they may touch dangerous voltage points or short-circuit parts that could result in a fire or electric shock. Never spill liquid of any kind on the set. Use special caution in households where children are present. The apparatus is not suitable for children under 3-year to operate.



This product is equipped with a polarized plug (a plug having one blade wider than the other).

This plug will fit into the power outlet only one way, this is a Safety feature. If you are unable to insert the plug fully into the outlet, try to reverse the plug and if the plug should still fail to fit, contact your electrical technician to replace your obsolete outlet.

Do not defeat the safety purpose of the polarized plug. Power supply cords should be routed safely to prevent life and property from dangerous with damaged cord.

Mains plug is used as the disconnect device. It shall remain readily operable and should not be obstructed during intended use. To be completely disconnected the apparatus from supply mains, the mains plug of the apparatus shall be disconnected.

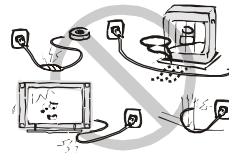

Important Safety Instructions and Maintenance

Important Safety Instructions



To avoid the fire, no naked flame source, such as lighted candles, should be placed on the apparatus.

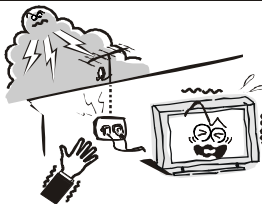

An outside antenna system should not be located in the vicinity of overhead power lines or other electric light or power circuits, or where it can fall into such power lines or circuits. When installing an outside antenna system, extreme care should be taken to keep from touching such power lines or circuits as contact with them might be fatal.



Always turn the set off when it is not being used. Unplug the apparatus from the AC outlet when it will not be used for a long period of time. And when there is a lightning, unplug the unit from the AC outlet immediately. Never touch the antenna wire during lightning.

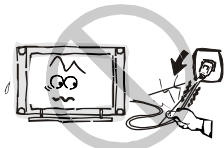

Do not pull the plug out by the wire; Never touch the plug with wet hands.



Excessive sound pressure from earphones and headphones can cause hearing loss.

Installation

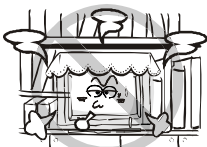

The ventilation should not be impeded by covering the ventilation opening with items, such as newspapers, tablecloths, curtains, etc.

At least 10 cm space should be left around the apparatus for sufficient ventilation.

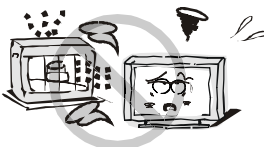

The product should be situated away from heat sources such as radiators, heat registers, stoves, or other products (including amplifiers) that produce heat. Place the apparatus in such a position that the screen is not exposed to direct sunlight. It is best to have soft indirect lighting while watching and avoid complete dark environment and reflection from the screen as these may cause eye fatigue.

Keep the product away from high magnetic field (i.e. power-amplified power speaker) to avoid affecting the tint;

Important Safety Instructions and Maintenance

Installation



Do not place the set on an unstable cart, stand, table or shelf. The set may fall, causing serious personal injury as well as damage to the product. Use only with the cart, stand, tripod, bracket, or table specified by the manufacturer, or sold with the apparatus. An appliance and cart combination should be moved with care. Quick stops, excessive force, and uneven surfaces may cause the appliance and cart combination to overturn.



Do not place this apparatus near water, for example, near a bath tub, wash bowl, kitchen sink, or laundry tub; in a wet basement; or a swimming pool; and the like;

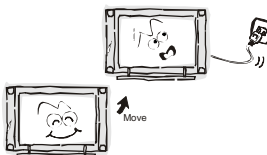

When the TV being moved in from cold place, it needs some right time for dew inside unit evaporating fully before turn on the unit;

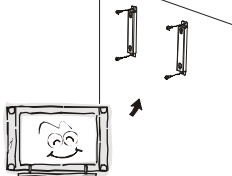

To prevent injury, this apparatus must be securely attached to the floor/wall in accordance with the installation instructions.

Cleaning

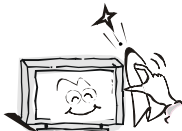

Unplug this apparatus from the AC outlet before cleaning. Do not use liquid cleaners or aerosol cleaners. Use a damp cloth for cleaning;

For your protection, please read this instruction completely, and keep this manual for future reference.

Contents

General description	5
Specifications and accessories	6
Overview	7
Basic operation	10
External connection	12
Basic operation	14
Trouble shooting	23
Picture defects and countermeasures	24

General description

Feature:

- | Zero X radiation complies to green environment protection requirement
- | Auto tuning and fine tuning
- | One composite video input sockets (back)
- | One S-Video input socket
- | One PC VGA input socket
- | One YPbPr input socket
- | One HDMI input socket (HDMI 1.3)
- | One AV output socket
- | Headphone
- | Multi-language OSD
- | Programmable TV sleep timer
- | No-signal automatic power off function
- | PC VGA mode: VGA, SVGA, XGA
- | YPbPr mode:480i, 480P, 576P, 720P, 1080i, 1080P
- | HDMI mode:480P, 576P, 720P, 1080i, 1080P

Note:

1. In case of any design change, a notice will not be released.
2. The composite video output function only support TV and AV input.

Specifications and accessories

Specifications:

Description	RLC2226	
Display Screen Type	Color active matrix LCD display	
Display size	22" Diagonal (max.)	
The maximum resolution	1366X768	
Image control	Fine digital control	
Power supply	AC ~120V 60Hz	
TV receive system	NTSC M, PAL M, PAL N	
Frequency range	Antenna 2- 69, CATV 1-125	
Video in	NTSC3.58/NTSC4.43, PAL M, PAL N	
Antenna input impedance	75Ω (Unbalance)	
Sound output	2WX2	
Power supply for remote controller	DC 3V (Two size AAA batteries)	
Power consumption	50W	
Dimensions (LXWXH)	TV with stand	530X209X393mm
	TV without stand	530X77X359mm
Weight (Net weight)	TV with stand	5.0 Kg
	TV without stand	4.6 Kg
Operation environment temperature	0°C-40°C	

Accessories:

- I User's manual I Remote control
- I Wall-mounted accessories: Two wall-mounted brackets, four fixed screws and four fixed sleeves.(Optional)

Note:

1. Due to TV may be used with different display screen, weight marked in this user's manual or in packaging box are subject to change without notice.
2. The illustrations and on-screen displays in this user's manual are for explanation purposes and may vary slightly from actual operations. In case of any design change, a notice will not be released.

Overview

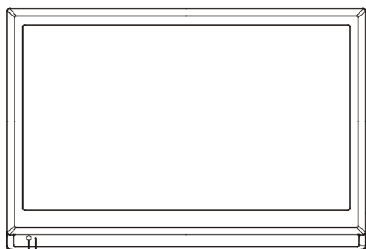

- 1. Power indicator
- 2. IR remote sensor



- 3. Input select
- 4. Menu
- 5. Program up/down
- 6. Volume up/down
- 7. Standby

1. Power indicator
Green: Normal playing status.
Red: Standby status.
2. IR remote sensor
Point remote control at this sensor to conduct remote control.
3. INPUT
Press this button to display the selectable signal source for main source.
4. MENU
Press this button to display OSD menu.
5. PROG Δ / ∇
Press these two buttons to select channel or operate menu.
6. VOL Δ / ∇
Press these two buttons to increase or decrease the volume or operate menu.
7. ψ
Press this button to enter standby mode under normal play, and press this button to enter normal play mode under standby mode.

Overview

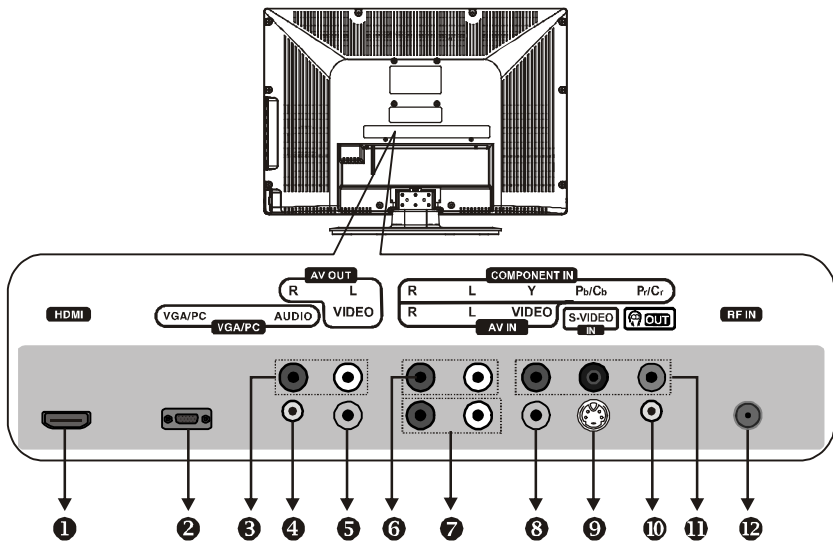

1 HDMI

Connect to the HDMI jack of a device with an HDMI output.

2 VGA/PC IN

Connect to the video output jack on your PC.

3 AV AUDIO OUT

Audio out for external devices.

4 PC AUDIO IN

Audio input for external devices.

5 AV VIDEO OUT

Video out for external devices.

6 COMPONENT AUDIO IN

Connect Component audio.

7 COMPOSITE & S-VIDEO AUDIO

Audio inputs for external devices.

8 COMPOSITE VIDEO

Video input for external devices, such as a camcorder or VCR.

9 S-VIDEO

Connect an S-VIDEO signal from a camcorder or VCR.

10 HEADPHONE

Connect a set of external headphones for private listening.

11 YPb/CbPr/Cr

Connect to YPbPr/YCbCr video.

12 RF IN

Connect to an antenna or cable TV system.

Overview

Remote control

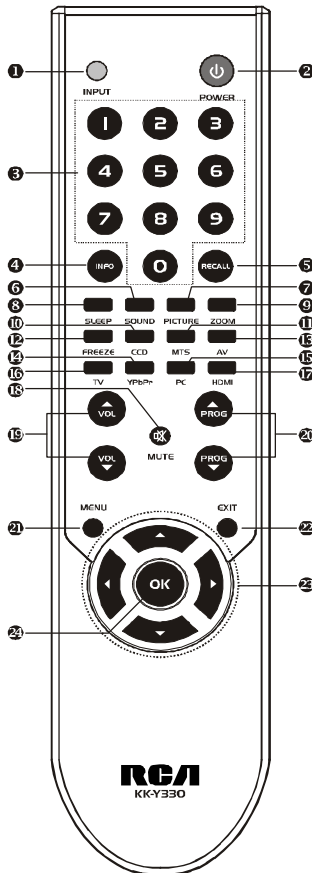

Loading batteries:

- 1) Remove the lid of the battery compartment.
- 2) Insert 2 size AAA batteries with polarities as indicated inside the compartment.
- 3) Replace the lid.

Note:

- 1) One loading of batteries will last 1 year under normal use.
- 2) If you don't intend to use the remote control for a long period of time, remove them to avoid damage due to leakage.
- 3) Do not mix old and new batteries, or different types.
- 4) Don't throw the batteries into fire or water.
- 5) The batteries (battery pack or batteries installed) shall not be exposed to excessive heat such as sunshine, fire or the like.

Basic operation

Remote control introduction

1.INPUT

Select input source.

2.POWER

Turn your TV on and off.

3.0~9

Use these keys to input digit, letters and special characters.

4.INFO

Displays the program information.

5.RECALL

To swap to the previous program you wanted from current program.

6.SOUND

Select audio mode. Press the key repeatedly to choose one of the modes among Normal, News, Music, Preference.

7.PICTURE

Select picture mode. Press the key repeatedly to choose one of the modes among Normal, Sports, Mild, Preference.

8.SLEEP

TV will be switched off automatically at preset sleep time if you have set sleep timer. Use your remote control to set the sleep timer. Press SLEEP button on the remote control, then press this button again to set sleep timer: Off, 15Min, 30Min, 45Min, 60Min, 90Min, 120Min.

Note: The sleep timer you have set will be canceled when the TV turns off or if a power failure occurs. When SLEEP TIMER is 60 seconds only, left tunime will be displayed on the screen, and any operation will cancel SLEEP TIMER function by pressing any button on the remote control or on the unit.

9.ZOOM

Change the display mode press the key repeatedly to choose one of the modes among Full, 4:3.

10.CCD

Select closed caption mode. Press the key repeatedly to choose one of the modes among Off, CC1, CC2, CC3, CC4, Text1, Text2, Text3, Text4.

11.MTS

Select MTS sound system. Press the key repeatedly to choose one of the modes among Mono, Stereo, Sap.

Basic operation (to be continued)

12.FREEZE

No available for this model.

13.AV

Switch to AV mode directly.

14.YPbPr

Switch to YPbPr mode directly.

15.PC

Switch to PC mode directly.

16.TV

Switch to TV mode directly.

17.HDMI

Switch to HDMI mode directly.

18.

Press this button to shut off sound of the TV temporarily, press again to restore TV sound.

19.VOL_{q/p}

Press these buttons to adjust TV volume.

20.PROG_{q/p}

Press these buttons to change program upward or downward.

21.MENU

Display the main menu.

22.EXIT

Exit the menu.

23.Arrow buttons(_{q/p/t/u})

Press these buttons to move cursor up/down/left/right for menu.

24.OK

Validation key.

External connection

Antenna connection

Antenna input impedance of this unit is 75ohm. VHF/UHF 75ohm coaxial cable can be connected to the antenna jack directly, if the antenna cable is a 300ohm flat feeder cable, you need to use the 300ohm/75ohm converter (not included) to connect the antenna cable to the antenna jack.

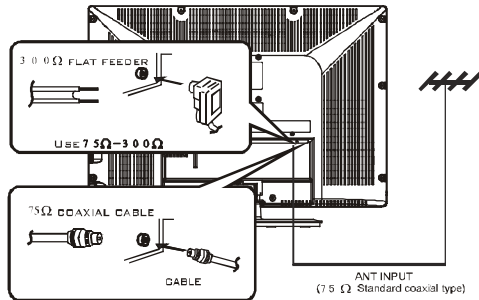

- I 75 Ω coaxial cable is recommended to eliminate interference and double image due to the unmatched input impedance of the antenna.
- I The antenna cable and power line should not be bundled together.

Stand and Wall-mounted (Optional)

1. How to mount the LCD TV ?

- (1) Take out the bracket hole cover from groove with screw driver and place on the bracket hole;
- (2) Fasten 4 screws into four nuts on the rear cover;
- (3) Fasten 2 brackets with 4 M8 screws on the wall as figure 2 shown;
- (4) Carefully check for the strength before releasing the LCD TV.

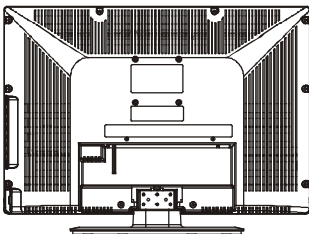

Figure 1

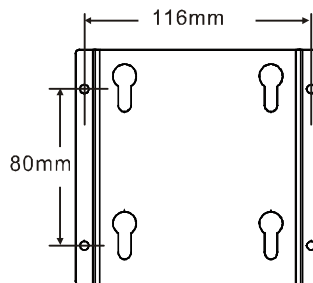

Figure 2

External connection

2. How to assemble the stand?

Before attaching/detaching the stand, make sure to turn off the TV.

Before performing work spread cushioning over the base area to lay the LCD TV on. This will prevent it from being damaged.

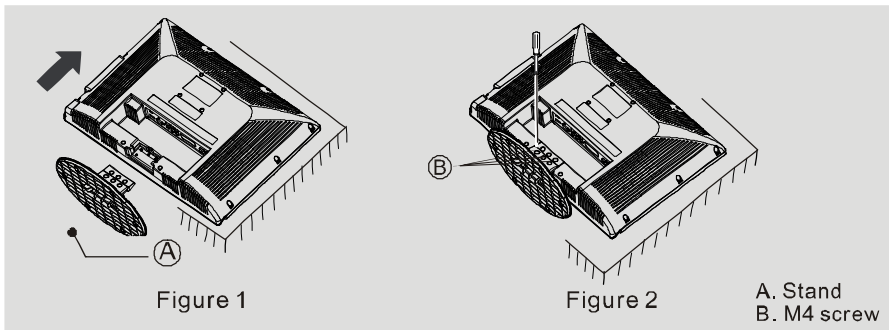

Assembling instruction:

1. Fix the stand and the Cabinet together with six screws (M4). (Figure 1)

2. Fasten the six screws used to secure the stand in place.(Figure 2)

- To disconnect the stand from the TV, perform the above steps in reverse order.

Basic operation (to be continued)

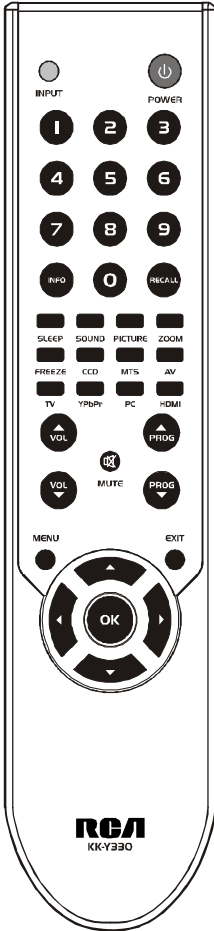

Turning the TV On and Off

1. Insert the power cord plug into a AC outlet, the TV will enter standby mode. Press POWER button on the remote control to turn it on . The indicator will switch from red to green.
2. If you want to stop watching TV or go out for a while, you can press POWER button on the remote control. If you want to watch TV again, you can press this button again.
3. Unplug the power cord when the TV will not be used for a long period time.

Auto power-off

The TV will enter standby mode in 15 seconds in PC mode, and in other modes it will enter standby mode in 5 minutes when no signal sleep is on.

Memorizing the Channels

Your TV can memorize all of the available channels. After the available channels are memorized, use PROGR /s button to browse channels.

Language select

Before using TV, you can set the language:

- 1) Press MENU button on the remote control, then press t /u Arrow button to select "Setting" menu as following:



Basic operation (to be continued)

- 2) Press **p/q** Arrow button to enter the submenu and press **t/u** Arrow button to select the language you desire.

Selecting input source

Press **INPUT** button on the remote control, then you can select input sources as following:



Setting color system

In order to meet the color system in your country, you can set the color system as following: Press **q/p** Arrow button to select “COLOR SYSTEM” under “CHANNEL” menu, and then press **t/u** Arrow button to change video format as following:

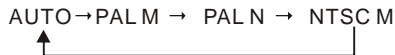

Tuner setup

Press **MENU** button on the remote control, then press **t/u** Arrow button to select “CHANNEL”:



- 1) **SOURCE**
Press **q/p** Arrow button to select “SOURCE”, and press **t/u** Arrow button to select “Air” or “cable”.
- 2) **CHANNEL**
Press **q/p** Arrow button to select “CHANNEL” and press **t/u** Arrow button to select the channel number.
- 3) **COLOR SYSTEM**
Press **q/p** Arrow button to select “COLOR SYSTEM” and press **t/u** Arrow button to select the right color system.

Basic operation (to be continued)

4) SKIP

Press **q/p** Arrow button to select "SKIP", then press **t/u** Arrow button to select "On" or "Off". On: skip the channel; Off: not skip.

5) AFT

Press **q/p** Arrow button to select "AFT", then press **t/u** Arrow button to select "On" or "Off".

6) FINE TUNE

In case of bad image or sound of TV program, you can use Fine Tune function to obtain satisfied image or sound with operating steps as follows:

Press **q/p** Arrow button to select "FINE TUNE" and press **t/u** Arrow button to conduct fine tuning from high frequency to low frequency or from low frequency to high frequency till best picture or sound effect is obtained.

Note: Only if "AFT" is set to "OFF", you can adjust the "FINE TUNE".

7) AUTO SEARCH

Press **q/p** Arrow button to select "AUTO SEARCH", then press **u** Arrow button to start Auto Search:



TV will tune automatically and all programs found will be saved. Please don't interrupt it.

Note:

- i) If you use the TV for the first time, you must use "AUTO SEARCH" to search and memorize all channels.
- ii) If your TV is not in TV input state, you must switch it to TV state at first.
- iii) If you want to stop the process of "AUTO SEARCH", just press MENU button to exit.

Basic operation (to be continued)

Adjusting the Picture

Press MENU button on the remote control, then press \uparrow / \downarrow Arrowbutton to select "PICTURE" menu.

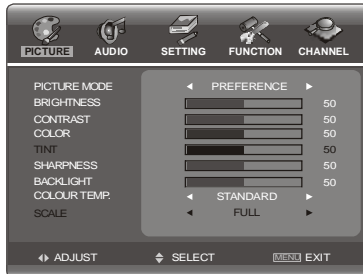

- 1) **Adjusting Picture Mode**
Press q/p Arrow button to select "PICTURE MODE" , and press \uparrow / \downarrow Arrow button to adjust picture mode to your desire.
Note: "BRIGHTNESS" , "CONTRAST" , "COLOR" adjusting are only available in preference mode.
- 2) **Adjusting the Brightness of picture**
Press q/p Arrow button to select "BRIGHTNESS" , and press \uparrow / \downarrow Arrow button to adjust brightness to your desire.
- 3) **Adjusting the Contrast of picture**
Press q/p Arrow button to select the "CONTRAST", then press \uparrow / \downarrow Arrow button to set contrast to your desire.
- 4) **Adjusting the Tint of picture**
Press q/p Arrow button to select the "TINT", then press \uparrow / \downarrow Arrow button to set tint to your desire.
Note: Only available in NTSC.
- 5) **Adjusting the Color of picture**
Press q/p Arrow button to select the "COLOR", then press \uparrow / \downarrow Arrow button to set saturation to your desire.
- 6) **Adjusting the Sharpness of picture**
Press q/p Arrow button to select the "SHARPNESS", then press \uparrow / \downarrow Arrow button to set sharpness to your desire.
- 7) **Adjusting the Backlight of picture**
Press q/p Arrow button to select the "BACKLIGHT", then press \uparrow / \downarrow Arrow button to set backlight to your desire.
Note: Backlight function is only available for models with this function.
- 8) **Adjusting the Color Temp of picture**
Press q/p Arrow button to select the "COLOUR TEMP.", then press \uparrow / \downarrow Arrow button to set colour temperature to your desire.
- 9) **Adjusting the Scale Mode of picture**
Press q/p Arrow button to select the "SCALE", then press \uparrow / \downarrow Arrow button to set scale mode to your desire.

Basic operation (to be continued)

Note: It is useless under no signal mode.

Adjusting the Sound

Press MENU button on the remote control, then press \uparrow/\downarrow Arrow button to select "AUDIO" menu.

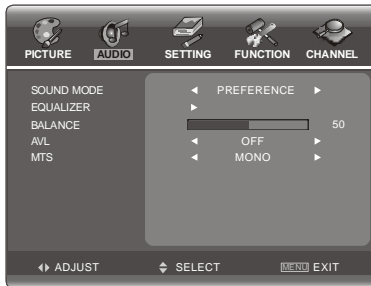

- 1) Adjusting Sound Mode
Press \uparrow/\downarrow Arrow button to select "SOUND MODE", use \uparrow/\downarrow Arrow button to adjust sound mode.
- 2) Adjusting the Equalizer
Press \uparrow/\downarrow Arrow button to select "EQUALIZER", use \uparrow/\downarrow Arrow button to adjust the frequency.
- 3) Adjusting Balance of sound
Press \uparrow/\downarrow Arrow button to select "BALANCE", use \uparrow/\downarrow Arrow button to adjust sound balance.
- 4) Adjusting AVL
Press \uparrow/\downarrow Arrow button to select "AVL" and press \uparrow/\downarrow Arrow button to set it "ON" or "OFF".
- 5) Adjust MTS
Press \uparrow/\downarrow Arrow button to select "MTS", use \uparrow/\downarrow Arrow button to adjust to your desired.
Note: Only available in TV.

OSD Setup

Press MENU button on the remote control and press \uparrow/\downarrow Arrow button to select "SETTING" menu.



Basic operation (to be continued)

- 1) **OSD Language**
Press **q/p** Arrow button to select “LANGUAGE” and press **t/u** Arrow button to select language you desire.
- 2) **Adjusting SCREEN SAVER**
Press **q/p** Arrow button to select “SCREEN SAVER” and press **t/u** Arrow button to set screen saver.
- 3) **Adjusting OSD Position**
Press **q/p** Arrow button to select “OSD Position” and press **t/u** Arrow button to set position of OSD.
- 4) **Adjusting OSD Timer**
Press **q/p** Arrow button to select “DURATION”, Press **t/u** Arrow button to select one time from the following times:5s,10s,15s and always.

Function setup

Press **MENU** button on the remote control or TV side panel, press **t/u** Arrow button to select “FUNCTION” menu.

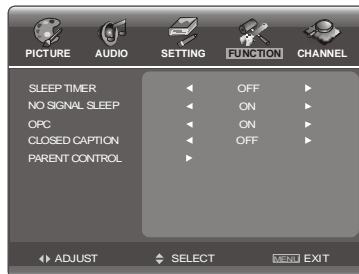

- 1) **SLEEP TIMER**
Please refer to page 10.
- 2) **NO SIGNAL SLEEP**
Refer to page 14 “Auto power-off”.
- 3) **OPC**
Press **q/p** Arrow button to select “OPC” in “Function” menu. press **t/u** Arrow button to set it “ON” or “OFF” or “DEMO”.
Note: Not available in VGA.
- 4) **CLOSED CAPTION**
Press **q/p** Arrow button to select “CLOSED CAPTION” in “Function” menu. Press the key repeatedly to choose one of the modes among Off, CC1, CC2, CC3, CC4, Text1, Text2, Text3, Text4.

Basic operation (to be continued)

5) Parent Control

In "Function" menu, press **q/p** Arrow button to select "Parent Control",press **t/u** Arrow to enter the input password menu. Input the password to enter the submenu(the default password is 0000 and omnipotent password is 1980).

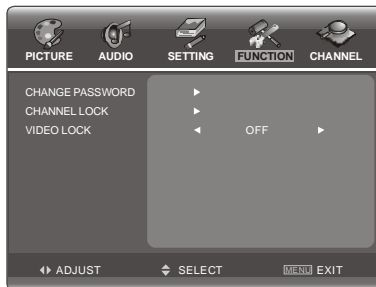

(1) Change Password

- 1.Press **q/p** Arrow button to select "CHANGE PASSWORD" option.
- 2.Press **t/u** Arrow button and input a new password twice to change the password.

(2) Channel Lock

- 1.Press **q/p** Arrow button to select "CHANNEL LOCK" option.
- 2.Press **t/u** Arrow button to enter the submenu.

I Source

- 1.Display the current channel source.

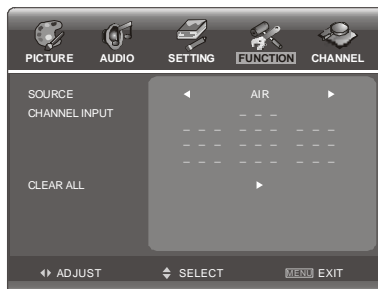

Basic operation (to be continued)

Channel Input

1. Press **q/p** Arrow button to select "CHANNEL INPUT" function.
2. Input the channel number you want to lock and press OK key to confirm, the channel number will be add to the list below.
3. If you want to unlock a channel, press **q/p** Arrow button to select the channel number in the list and press OK key to delete it.

Note: You can lock 9 channels in "AIR" or "CABLE" source.

Clear All

1. Select a source you want to clear in "SOURCE" function.
2. Press **q/p** Arrow button to select "CLEAR ALL" function.
3. Press **t/u** Arrow button to clear the channel list in the source you select.

(3) Video Lock

1. Press **q/p** Arrow button to select "VIDEO LOCK" option.
2. Press **t/u** Arrow button to select "VIDEO", "VIDEO+" or "OFF".

! Video: Lock all sources except TV.

! Video+: Lock Channel 3 and channel 4 of TV and all other sources.

! Off: Close "VIDEO LOCK" function and all sources are available.

Note: If the sources have locked, the key in Remote is not available in AV, TV, COMPONENT, PC, HDMI input.

PC Adjust

1. Picture

When the TV is in PC mode, press MENU button on the remote control panel. Press **t/u** Arrow button to select "PICTURE".

The method to adjust Brightness, contrast, Backlight, color Temp, and scale, please refer to "Adjusting the Picture".

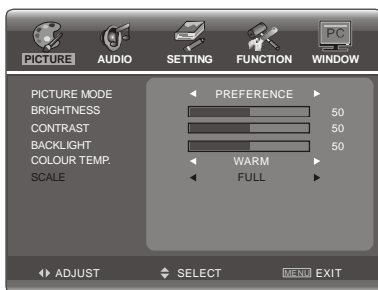

Basic operation (to be continued)

2.Window

This TV supports no higher than 60Hz under PC mode, so please set the refresh rate of PC to 60Hz. If the frequency is higher than 60Hz, the screen may flicker. When the TV is in PC mode, press MENU button on the remote control. Press \uparrow/\downarrow Arrow button to select "WINDOW".



- 1) Adjusting picture H-Position
Press \uparrow/\downarrow Arrow button to select "H-POSITION" and press \uparrow/\downarrow Arrow button to set horizontal position of picture.
- 2) Adjusting picture V-Position
Press \uparrow/\downarrow Arrow button to select "V-POSITION" and press \uparrow/\downarrow Arrow button to set vertical position of picture.
- 3) Adjusting Clock
When PC is connected to TV set because of the difference of PC parameter, you should adjust the "CLOCK" item in "WINDOW" menu until you get a good picture.
- 4) Adjusting Phase
When PC is connected to TV set because of the difference of PC parameter, you should adjust the "PHASE" item in "WINDOW" menu until you get a good picture.
- 5) Auto Adjust
If there are unexpected problems happened when you adjust the items, you can select the "AUTO ADJUST" and press \uparrow Arrow button, the TV set will resume the original settings.
Note: Only "H-Position" and "V-Position" are available for YPBPR mode.

Trouble shooting

If you have any problem, check the countermeasure for each symptom listed below. The following symptoms may have caused by inappropriate adjustment rather than actual malfunction of the unit. If the trouble persists, contact the service center.

Problem	Possible Solution
Poor picture and sound quality	Try another channel. Adjust the antenna. Check all wire connections.
No picture or sound under TV status	Try another channel. Press the TV/AV button. Make sure the TV is plugged in. Check the antenna connections.
No sound or sound is too low at maximum volume	First, check the volume of units connected to your TV. Adjust the TV volume accordingly. Check sound adjustment(Volume and Mute)
No color, wrong colors or tints.	Make sure the program is broadcast in color. Select the picture menu, then adjust the color or tint submenu to the proper value.
Picture rolls vertically.	Check all wire connections.
Blurred or snowy picture, distorted sound	Check the direction, location and connections of your antenna. This interference is often due to the use of an indoor antenna.
Remote control malfunctions	Replace the remote control batteries. Check the battery terminals. Remote is out of range, move close to TV Confirm there is no obstructions between remote and TV Make sure power cord is plugged in
Image is not centered on the screen.	Adjust the horizontal and vertical position
Clean TV set	When cleaning the LCD screen, please pull out the power plug, use dry and soft and clean cloth to clean the dust on the screen and shell. In case of further cleaning for the screen, please use clean wet cloth. Do not use naphtha, thinner or similar liquids for cleaning.
Colored point	This product adopts a high-resolution LCD TV, and the colored point of some pixels may occur due to the special feature of the product. For a few of colored points, this shall not be related with terrible product performance or product reliability, and in case of this situation, the service of the product will not be influenced. For the criterion of colored points, our company has similar products with others. The colored point in conformity with the product criterion is not covered by the return scope of the product due to quality problems. We hope our respected customers will forgive us.

Picture defects and countermeasures

The most common types of television interference are as following:

SNOWY PICTURE

Snowy picture is usually caused due to weak signal. Adjust antenna or install an antenna amplifier.



DOUBLE IMAGES OR "GHOSTS"

Double images are usually caused by reflections from tall buildings. Adjust the direction of the antenna or raise it.



RADIO WAVE INTERFERENCE

Wave pattern are moving on the screen, which are usually caused by nearby radio transmitter or shot-wave receiving equipment.



HIGH TEMPERATURE ELECTROTHERMAL INTERFERENCE

Diagonal, or herring-bone, patterns appear on the screen or part of picture is missing. This is probably caused by high temperature electrothermal equipment in the nearby hospital.





LCD Television

RLC2226

Operating instructions

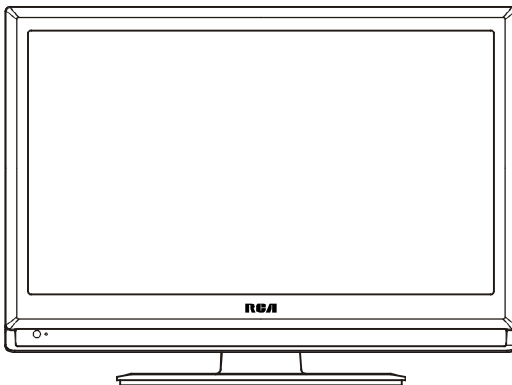

Keep this manual for future reference.

"RCA", "NIPPER & CHIPPER" ARE TRADEMARKS OF
RCA TRADEMARK MANAGEMENT
USED UNDER LICENSE TO CURTIS INTERNATIONAL LTD.

Free Manuals Download Website

<http://myh66.com>

<http://usermanuals.us>

<http://www.somanuals.com>

<http://www.4manuals.cc>

<http://www.manual-lib.com>

<http://www.404manual.com>

<http://www.luxmanual.com>

<http://aubethermostatmanual.com>

Golf course search by state

<http://golfingnear.com>

Email search by domain

<http://emailbydomain.com>

Auto manuals search

<http://auto.somanuals.com>

TV manuals search

<http://tv.somanuals.com>