

# RCA SCENIUM



## HDTV Monitor User's Guide

# Important Information

## WARNING

To reduce the risk of fire or electric shock, do not expose this product to rain or moisture.

## CAUTION

RISK OF ELECTRIC SHOCK DO NOT OPEN

Caution: To reduce the risk of electric shock, do not remove cover (or back). No user serviceable parts inside. Refer servicing to qualified service personnel.



This symbol indicates "dangerous voltage" inside the product that presents a risk of electric shock or personal injury.



This symbol indicates important instructions accompanying the product.

The apparatus shall not be exposed to dripping or splashing and that no objects filled with liquids, such as vases, shall be placed on the apparatus.

Refer to the identification/rating label located on the back panel of your product for its proper operating voltage.

FCC Regulations state that unauthorized changes or modifications to this equipment may void the user's authority to operate it.

**Caution:** Using video games or any external accessory with fixed images for extended periods of time can cause them to be permanently imprinted on the picture tube (or projection TV picture tubes). ALSO, some network/program logos, phone numbers, black borders (sides, top and bottom), etc. may cause similar damage. This damage is not covered by your warranty.

**Cable TV Installer:** This reminder is provided to call your attention to Article 820-40 of the National Electrical Code (Section 54 of the Canadian Electrical Code, Part 1) which provides guidelines for proper grounding and, in particular, specifies that the cable ground shall be connected to the grounding system of the building as close to the point of cable entry as practical.

**Warning:** Do not use the Freeze feature for an extended period of time. This can cause the image to be permanently imprinted on the picture tube. Such damage is not covered by your warranty. Press any button to unfreeze the picture at any time.

## Product Registration

Please fill out the product registration card (packed separately) and return it immediately. Returning the card allows us to contact you if needed.

## Product Information

Keep your sales receipt to obtain warranty parts and service and for proof of purchase. Attach it here and record the serial and model numbers in case you need them. These numbers are located on the product.

Model No. \_\_\_\_\_

Serial No. \_\_\_\_\_

Purchase Date: \_\_\_\_\_

Dealer/Address/Phone: \_\_\_\_\_

## IMPORTANT SAFETY INSTRUCTIONS

1. Read these instructions.
2. Keep these instructions.
3. Heed all warnings.
4. Follow all instructions.
5. Do not use this apparatus near water.
6. Clean only with dry cloth.
7. Do not block any ventilation openings. Install in accordance with the manufacturer's instructions.
8. Do not install near any heat sources such as radiators, heat registers, stoves, or other apparatus (including amplifiers) that produce heat.
9. Do not defeat the safety purpose of the polarized or grounding-type plug. A polarized plug has two blades with one wider than the other. A grounding type plug has two blades and a third grounding prong. The wide blade or the third prong is provided for your safety. If the provided plug does not fit into your outlet, consult an electrician for replacement of the obsolete outlet.
10. Protect the power cord from being walked on or pinched particularly at plugs, convenience receptacles, and the point where they exit from the apparatus.
11. Only use attachments/accessories specified by the manufacturer.
12. Use only with the cart, stand, tripod, bracket, or table specified by the manufacturer, or sold with the apparatus. When a cart is used, use caution when moving the cart/apparatus combination to avoid injury from tip-over.
13. Unplug this apparatus during lightning storms or when unused for long periods of time.
14. Refer all servicing to qualified service personnel. Servicing is required when the apparatus has been damaged in any way, such as power-supply cord or plug is damaged, liquid has been spilled or objects have fallen into the apparatus, the apparatus has been exposed to rain or moisture, does not operate normally, or has been dropped.



If an outside antenna is connected to the TV receiver, be sure the antenna system is grounded so as to provide some protection against voltage surges and built up static charges. In the U.S. Section 810-21 of the National Electrical Code and in Canada, Part 1 of the Canadian Electrical Code provides information with respect to proper grounding of the antenna system. See the figure on the right for details.

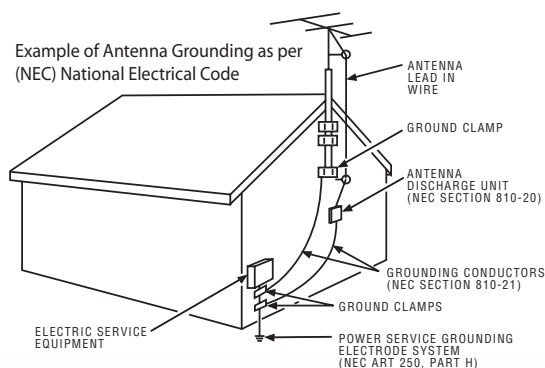

To assure adequate ventilation for this product, maintain a spacing of 4 inches from the top and sides of the TV receiver and 2 inches from the rear of the TV receiver and other surfaces.

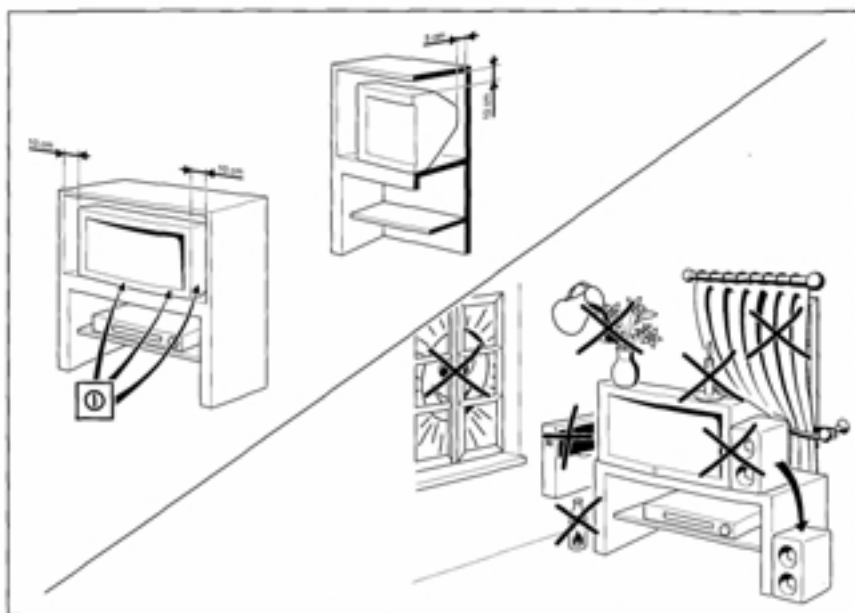

# Introduction

## Key Features Overview

Your TV is equipped with features that will add to your TV viewing experience. The following information summarizes a few of these features. Chapter 3 provides more information about the rest of the TV's features and how to use them.

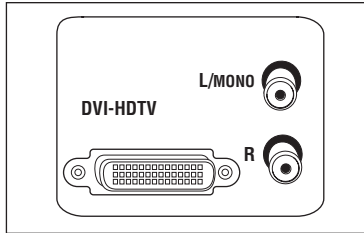

### DVI-HDTV Input

Lets you connect an HD receiver with a DVI output.

- **DVI (Digital Visual Interface)** Provides an uncompressed, digital video interface developed for high-bandwidth digital connection. It supports the overlay of high-resolution graphics needed by some electronic program guide navigation and other interactive services. DVI, when combined with HDCP (High bandwidth Digital Content Protection) technology, creates a protected digital connection. The signal speed of the DVI connection is 1080i for HDTV at a rate of 1.78 Gigabits per second.

### Dolby\* Virtual

Available only for stereo signals. Creates a virtualized surround sound experience from two speakers using the Dolby Pro Logic decoding. It provides the sensation of being surrounded by additional speakers.



PIP example



POP example

### PIP (Picture-In-Picture) and POP (Picture-Outside-Picture)

**Description:** PIP lets you watch two channels at one time — one channel on the main screen and the other in a smaller window. POP also lets you watch two channels at one time- one channel on the left side of the screen (the main picture) and the other on the right.

**Requirements:** Press the PIP button to bring up the PIP window. Press again to bring up POP. Chapter 3 has detailed instructions on how to use the PIP and POP features.

### Auto Tuning

**Description:** Allows you to set up the TV to automatically tune to a specific channel when you press a certain component (VCR, DVD player, etc.) button on the remote.

**Requirements:** Set up *Auto Tuning* in the TV's menu system. (Chapter 3 has details).

### V-Chip: Parental Controls

**Description:** You can block programs and movies by content, age-based ratings, and/or movie ratings.

**Requirements:**

- Set up the *Parental Control* menu in the TV's main menu (Chapter 3 has details).
- The broadcasters must use the rating system when they send the program to your TV in order for your TV to block the program.
- Parental controls must be locked for these settings to take affect.



\* Dolby is a trademark of Dolby Laboratories

<b>IMPORTANT SAFETY INSTRUCTIONS</b> .....	1
<b>Introduction</b>	
<b>Key Features Overview</b> .....	2
DVI-HDTV Input .....	2
Dolby* Virtual .....	2
PIP (Picture-In-Picture) and POP (Picture-Outside-Picture) .....	2
Auto Tuning .....	2
V-Chip: Parental Controls .....	2
<b>Chapter 1: Connections and Setup</b>	
<b>Things to Consider Before You Connect</b> .....	4
Protect Against Power Surges .....	4
Protect Components from Overheating .....	4
Position Cables Properly to Avoid Audio Interference .....	4
Important Stand and Base Safety Information .....	4
Use Indirect Light .....	4
Cables Needed to Connect Components to Your TV .....	4
<b>Choose Your Connection</b> .....	5
<b>TV + HD Receiver + VCR + DVD Player</b> .....	6
<b>TV + Satellite Receiver + VCR</b> .....	7
<b>TV + DVD + VCR</b> .....	8
<b>TV+ A/V Receiver or Speakers</b> .....	9
<b>Explanation of Jacks</b> .....	10
<b>The Front of Your TV</b> .....	11
Front Inputs .....	11
Front Panel Buttons .....	11
<b>Plug in the TV</b> .....	11
<b>Put batteries in the remote</b> .....	11
<b>How to Use the Remote Control to Complete the Initial Setup</b> .....	11
<b>Turn on the TV</b> .....	11
<b>Complete the Initial Setup</b> .....	11
Set the Menu Language .....	12
Complete Auto Channel Search .....	12
Changing Lists and Labels .....	12
Auto Convergence .....	12
<b>Chapter 2: Using the Remote Control</b>	
<b>The Buttons on the Remote Control</b> .....	13
Using the INPUT Button .....	14
<b>Programming the Remote to Operate Other Components</b> .....	14
Find Out If You Need to Program the Remote .....	14
Programming the Remote .....	14
How to Use the Remote After You've Programmed It .....	15
<b>Remote Control Codes</b> .....	15
<b>Chapter 3: Using the TV's Features</b>	
<b>Channel Banner</b> .....	17
<b>Why You Should Use the Autotuning Feature</b> .....	17
How to Set Up the Autotuning Feature .....	17
<b>Parental Controls and V-Chip</b> .....	18
How V-Chip Works .....	18
V-Chip TV Rating .....	19
Blocking Specific Content Themes .....	20
Viewing Specific Content Themes .....	20
V-Chip Movie Rating Limit .....	20
V-Chip Unrated Program Block .....	21
Lock/Unlock Parental Controls .....	21
Front Panel Block .....	21
<b>PIP (Picture-in-Picture) and POP (Picture-outside-Picture) Operation</b> .....	21
PIP and POP Buttons .....	21
<b>Chapter 4: Using the TV's Menu System</b>	
<b>Sound Menu</b> .....	22
<b>Picture Menu</b> .....	23
<b>Channel Guide Menu</b> .....	23
<b>Time Menu</b> .....	24
<b>Parental Control Menu</b> .....	24
<b>PIP Menu</b> .....	24
<b>Setup Menu</b> .....	24
<b>Chapter 5: Other Information</b>	
<b>Troubleshooting</b> .....	26
<b>Care and Cleaning</b> .....	27
<b>Limited Warranty</b> .....	28
<b>Accessories</b> .....	29

# Connections & Setup

---

## Things to Consider Before You Connect

### Protect Against Power Surges

- Connect all components before you plug any of their power cords into the wall outlet.
- Turn off the TV and/or component before you connect or disconnect any cables.
- Make sure all antennas and cables are properly grounded. Refer to the Important Safety Instructions on page 1.

### Protect Components from Overheating

- Don't block ventilation holes on any of the components. Arrange the components so that air can circulate freely.
- Don't stack components.
- When you place components in a stand, make sure you allow adequate ventilation.
- If you connect an audio receiver or amplifier, place it on the top shelf so the heated air from it won't flow around other components.

### Position Cables Properly to Avoid Audio Interference

- Insert each cable firmly into the designated jack.
- If you place components above the TV, route all cables down the side of the back of the TV instead of straight down the middle of the TV.
- If your antenna uses 300-ohm twin lead cables, do not coil the cables. Also, keep the twin lead cables away from audio/video cables.

### Important Stand and Base Safety Information

Choose the location for your TV carefully. Place the TV on a stand or base that is of adequate size and strength to prevent the TV from being accidentally tipped over, pushed off, or pulled off. This could cause personal injury and/or damage the TV. Refer to the Important Safety Instructions on page 1.

### Use Indirect Light

Don't place the TV where sunlight or room lighting will be directed toward the screen. Use soft or indirect lighting.

### Cables Needed to Connect Components to Your TV

The pictures below show the cables needed for the connections represented in this book.

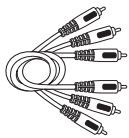

Audio/Video cables

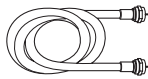

Coaxial cable

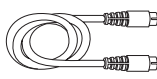

S-Video cable

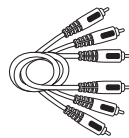



Component Video (Y•Pb•Pr) cables

## Choose Your Connection

There are several ways to connect your TV. Please use the following chart to determine which connection is best for you. Proceed to the appropriate page and connect your TV.

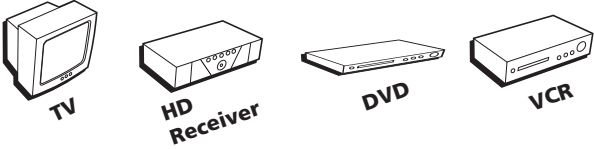
*Note: If you prefer, we can provide you with the name of an Authorized Service Representative who will visit your home for a fee to install your electronic entertainment system and to instruct you in its operation. For details about this service, call 1-888-206-3359.*

Components	Cables Needed	Connection Title	Go to...
 <p>TV HD Receiver DVD VCR</p>	<p>Coaxial Audio/video Component video</p>	<p>TV + HD Receiver + DVD + VCR</p>	<p>page 6</p>
 <p>TV Satellite VCR</p>	<p>Coaxial Audio/video S-Video</p>	<p>TV + Satellite Receiver + VCR</p>	<p>page 7</p>
 <p>TV DVD VCR</p>	<p>Coaxial Audio/video Component video</p>	<p>TV + DVD + VCR</p>	<p>page 8</p>

For general information on connecting an A/V receiver or speakers to your TV, go to page 9.

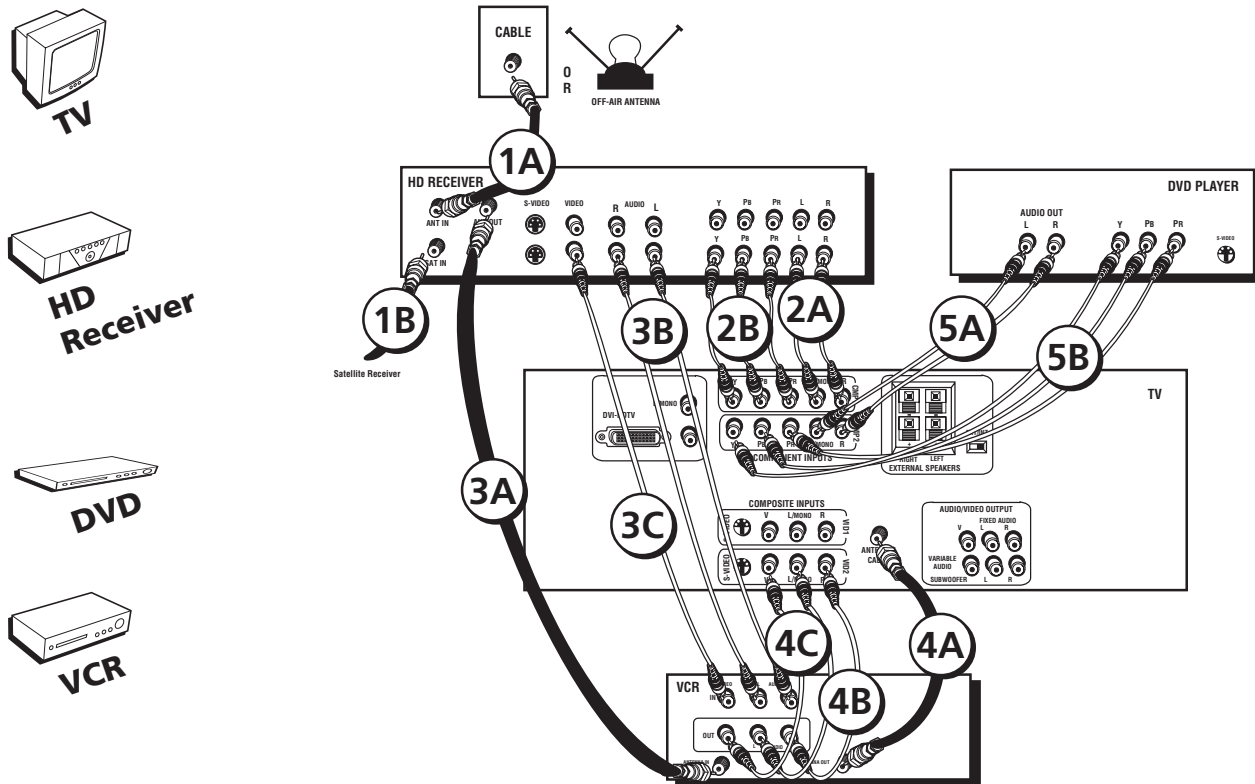

## TV + HD Receiver + VCR + DVD Player

1. Make sure cable or antenna and/or satellite is connected to your VCR.
  - A. Connect the coaxial cable from your cable outlet or antenna to the antenna input on the HD Receiver.
  - B. Connect the satellite dish antenna to the satellite input on the HD Receiver.
2. Connect your HD Receiver to your TV.
  - A. Connect the audio (white and red) cables to the CMP1 L/MONO and R audio jacks on the back of the TV and to the Audio Output jacks on the HD Receiver.
  - B. Connect three video grade cables to the CMP1 Y, P<sub>B</sub>, P<sub>R</sub> jacks on the back of the TV and to the Y, P<sub>B</sub>, P<sub>R</sub> jacks on the HD Receiver.
- Notes: The Y, P<sub>B</sub>, P<sub>R</sub> jacks are sending the digital cable signal to the TV.
- If your HD Receiver has a DVI output, connect the HD Receiver to your TV using a DVI cable. Make sure to connect the left and right audio cables to the DVI L/MONO and R jacks on the TV.
3. Connect your HD Receiver to your VCR.
  - A. Connect a coaxial cable to the HD Receiver's antenna output and to VCR's antenna input.
  - B. Connect the audio (white and red) cables to the Audio Output jacks on the HD Receiver and to the Audio Input jacks on the VCR.
  - C. Connect the video cable to the Video Output jack on the HD Receiver and to the Video Input jack on the VCR.
4. Connect your VCR to your TV.
  - A. Connect a coaxial cable to the VCR's antenna output and to the ANTENNA/CABLE Input jack on the TV.
  - B. Connect the audio (white and red) cables to the VID2 L/MONO and R audio jacks on the back of the TV and to the Audio Output jacks on the VCR.
  - C. Connect the video cable to the VID2 V (video) jack on the back of the TV and to the Video Output jack on the VCR.
5. Connect your DVD player to your TV.
  - A. Connect the audio (white and red) cables to the CMP2 L/MONO and R audio jacks on the back of the TV and to the Audio Output jacks on the DVD player.
  - B. Connect three video grade cables to the CMP2 Y, P<sub>B</sub>, P<sub>R</sub> jacks on the back of the TV and to the Y, P<sub>B</sub>, P<sub>R</sub> jacks on the DVD player.

Notes: If your DVD player doesn't have Y, P<sub>B</sub>, P<sub>R</sub> jacks, but does have an S-Video jack, connect the player to the TV's VID1 S-VIDEO jack using an S-Video cable.

If your DVD player doesn't have an S-Video jack, connect the player to the TV's VID1 V (video) jack using a video cable.

Important: If you use the TV's VID1 S-VIDEO or V (video) jack to connect the DVD player, you must connect the audio cables to the TV's VID1 L/MONO and R jacks.

Go to page 12



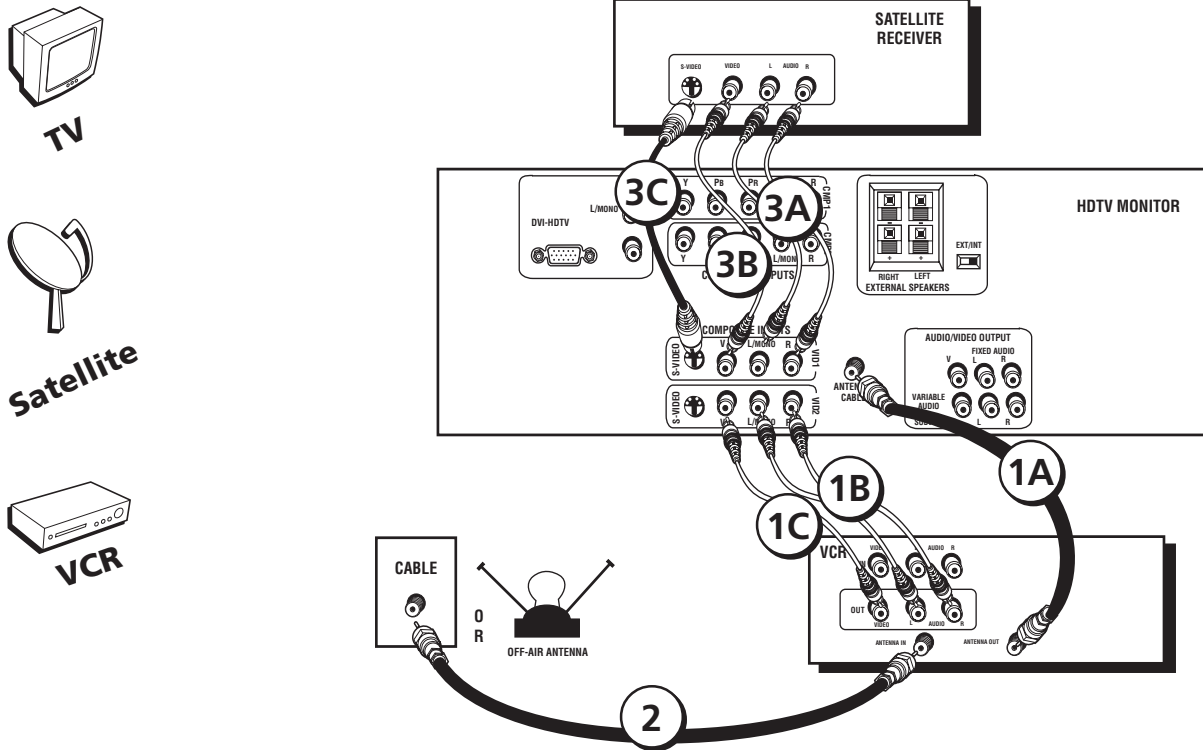

## TV + Satellite Receiver + VCR

1. Connect your VCR to your TV.
  - A. Connect a coaxial cable to the VCR's antenna output and to the ANTENNA/CABLE Input jack on the TV.
  - B. Connect the audio (white and red) cables to the VID2 L/MONO and R Audio jacks on the back of the TV and to the Audio Output jacks on the VCR.
  - C. Connect the video cable to the VID2 V (Video) jack on the back of the TV and to the Video Output jack on the VCR.
2. Make sure cable or antenna is connected to your VCR.
 

Connect the coaxial cable from your cable outlet or antenna to the antenna input on the VCR.
3. Connect your Satellite Receiver to your TV.
  - A. Connect the audio (white and red) cables to the VID1 L/MONO and R Audio jacks on the back of the TV and to the Audio Output jacks on the Satellite Receiver.
  - B. Connect the video cable to the VID1 V (Video) jack on the back of the TV and to the Video Output jack on the Satellite Receiver.
  - C. If your Satellite Receiver has an S-Video jack, connect an S-Video cable (instead of the video cable in step B) to the S-VIDEO jack on the TV and to the S-VIDEO jack on the satellite receiver.

Go to page 12

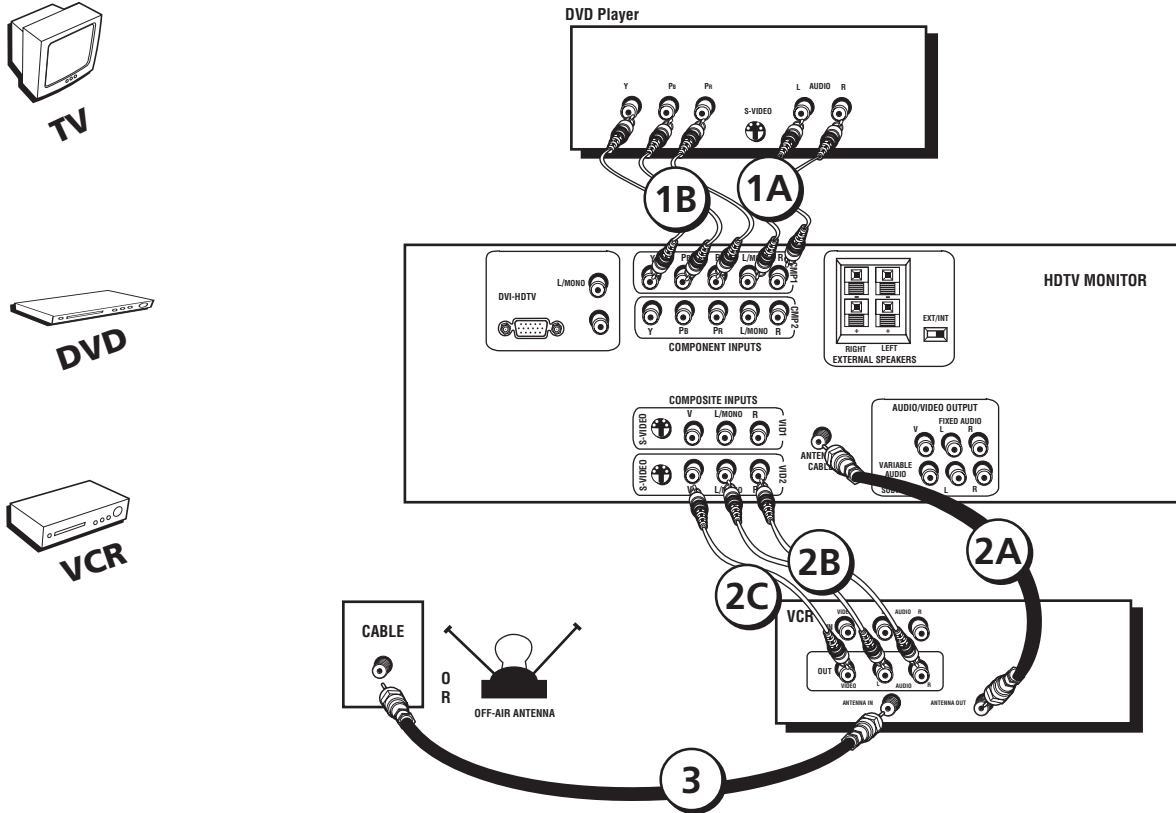

## TV + DVD + VCR

### 1. Connect your DVD Player to your TV.

- A. Connect the audio (white and red) cables to the CMP1 L/MONO and R Audio jacks on the back of the TV and to the Audio Output jacks on the DVD player.
- B. Connect three video grade cables to the CMP1 Y, P<sub>B</sub>, P<sub>R</sub> jacks on the back of the TV and to the Y, P<sub>B</sub>, P<sub>R</sub> jacks on the DVD player.

#### Notes:

If your DVD player does not have Y, P<sub>B</sub>, P<sub>R</sub> jacks, but does have an S-Video jack, connect the player to the VID1 S-VIDEO jack on the TV using an S-Video cable.

If your DVD player does not have an S-Video jack, connect the player to the VID1 V (Video) jack on the back of the TV using a video cable.

Important: If you use the VID1 S-VIDEO or V (Video) jack to connect your TV to the DVD player, you must connect the audio cables to the VID1 L/MONO and R jacks on the TV.

### 2. Connect your VCR to your TV.

- A. Connect a coaxial cable to the VCR's antenna output and to the ANTENNA/CABLE Input jack on the TV.
- B. Connect the audio (white and red) cables to the VID2 L/MONO and R Audio jacks on the back of the TV and to the Audio Output jacks on the VCR.
- C. Connect the video cable to the VID2 V (Video) jack on the back of the TV and to the Video Output jack on the VCR.

### 3. Make sure cable or antenna is connected to your VCR.

Connect the coaxial cable from your cable outlet or antenna to the antenna input on the VCR.

Go to page 12

## TV+ A/V Receiver or Speakers

These are two different ways your TV uses a component to hear audio.

1. Connect audio cables to either the FIXED or VARIABLE AUDIO L and R OUTPUT jacks and to the Audio Inputs on the A/V receiver.
  - FIXED provides fixed-level audio output from the TV. This audio output is ideal for connecting to an A/V receiver that has its own volume control.
  - VARIABLE provides variable-level audio output. Volume levels can be controlled by the volume controls on the TV and TV remote control.

-OR-

2. Use speaker wire to connect the TV to external speakers.
  - The EXT/INT switch beside the jacks let you turn the TV's internal speakers on or off. If you connect external speakers, slide the switch to EXT so the audio is sent to the external speakers only. Choosing INT sends the audio to the TV's speakers only.

*Note: The external speaker rating is 8 ohms with 15 watts power handling capabilities.*

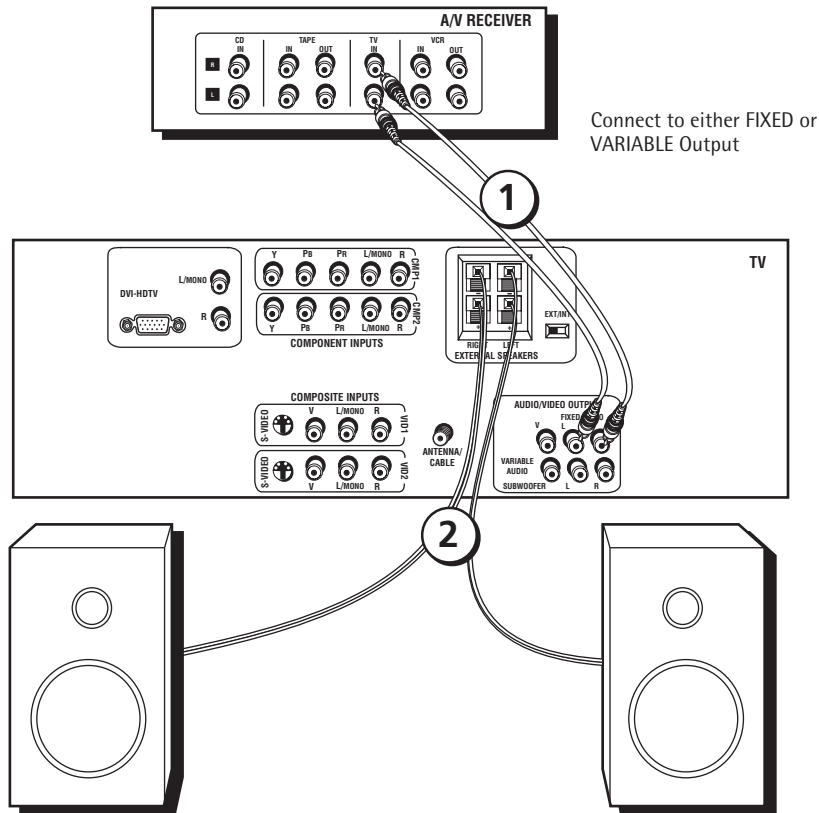

## Explanation of Jacks

This section describes the jacks you can use to make connections. There are several ways to connect components to your TV.

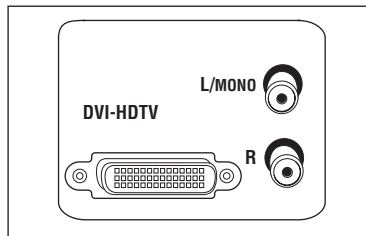

**DVI-HDTV Input** Lets you connect an HD receiver with a DVI output.

- **DVI (Digital Visual Interface)** Provides an uncompressed, digital video interface developed for high-bandwidth digital connection. It supports the overlay of high-resolution graphics needed by some electronic program guide navigation and other interactive services. DVI, when combined with HDCP (High bandwidth Digital Content Protection) technology, creates a protected digital connection. The signal speed of the DVI connection is 1080i for HDTV at a rate of 1.78 Gigabits per second.
- **L/MONO (Audio)** Provides left audio connection when using the DVI jack. The left audio connector is usually white.
- **R (Audio)** Provides right audio connection when using the DVI jack. The right audio connector is usually red.

*Note: Remember to connect the left and right audio cables because the DVI cable carries only the picture signal, not the sound.*

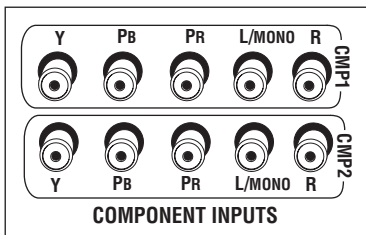

**COMPONENT INPUTS** Lets you connect a component video source, such as a DVD player.

- **CMP1 Y, P<sub>B</sub>, P<sub>R</sub> (Component Video)** Provides optimum picture quality because the video is separated into three signals. Use three video-grade cables for the connection. When using CMP1 Y, P<sub>B</sub>, P<sub>R</sub>, make sure to connect left and right audio cables to the CMP1 L/MONO and R Audio Input jacks.
- **CMP1 L/MONO (Audio)** Provides left audio connection. The left audio connector is usually white.
- **CMP1 R (Audio)** Provides right audio connection. The right audio connector is usually red.
- **CMP2 Y, P<sub>B</sub>, P<sub>R</sub>, and L/MONO and R Audio** Allows you to connect a second component video source. Their description is the same as CMP1 above. When using CMP2 Y, P<sub>B</sub>, P<sub>R</sub>, make sure you connect the left and right audio cables to the CMP2 Audio jacks.

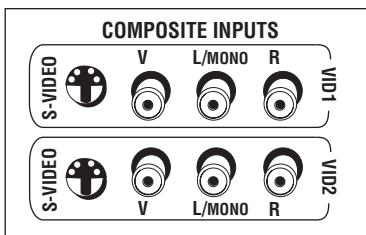

**COMPOSITE INPUTS** Lets you connect another component such as a VCR, DVD player, or laserdisc player. Its AUDIO jacks are the same as described for CMP1 above.

- **VID1 S-VIDEO** Provides better picture quality than the video jacks (VID1 and 2 Video) because the color part of the signal is separated from the black and white part of the picture. When using VID1 S-VIDEO, make sure to connect left and right audio cables to the VID1 L/MONO and R Audio Input jacks.
- **VID1 V (Video)** Provides composite video connection. The video connector is usually yellow.
- **VID2 S-VIDEO, V and L/MONO and R Audio** Allows you to connect a component such as a VCR, DVD player, or laserdisc player. Their description is the same as VID1 above.

*Note: Do not connect an S-Video and Video cable at the same time in either VID1 or VID2 jacks.*

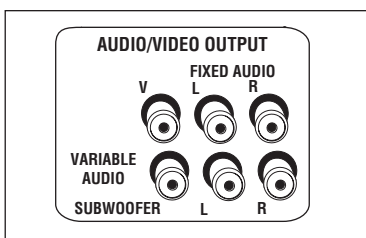

**AUDIO/VIDEO OUTPUTS** Lets you connect an amplifier or audio receiver for improved sound quality or an external video monitor.

- **FIXED AUDIO L/R** Provides fixed-level audio output from the TV. This audio output is ideal for connecting to an A/V receiver when you want to control the volume through the A/V receiver.
- **VARIABLE AUDIO** Provides variable-level audio output. Volume levels are controlled by the volume controls on the TV and remote control.
- **SUBWOOFER** Provides lower bass audio frequencies out from the TV and to a subwoofer.

*Note: If you've connected a subwoofer, make sure you set the External Subwoofer option in the Sound menu. Go to page 22 for instructions.*

**EXTERNAL SPEAKERS**

- **Right and Left Speaker Terminals** Let you connect external left and right speakers to the TV to receive left and right sound.
- **EXT/INT (switch)** Lets you turn the TV's internal speakers on or off. EXT sends audio to external speakers only. INT sends audio to the TV's internal speakers only.

**ANTENNA/CABLE** Lets you connect a coaxial cable to receive the signal from the antenna, cable, cable box, or if using the examples on pages 6-8, a VCR.

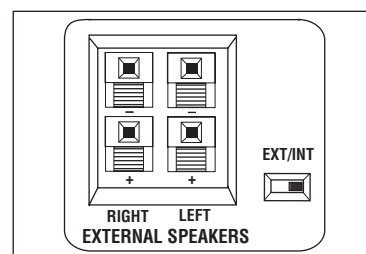

## The Front of Your TV

### Front Inputs

The TV has front inputs for convenience: one set of audio/video inputs, an S-Video and a headphone jack. Locate the jacks either on the front of the TV or on one of the sides. You can access the component you connected to the front of the TV by pressing the INPUT button on your remote until FRNT appears on the screen. The jacks are ideal for using a video game console or a camcorder.

*Note: When connecting a device that uses a monaural cable, such as some camcorders, use the Left (mono) input jack to get sound from both speakers.*

**PHONES** Allows you to connect headphones to listen to the sound coming from the TV. To adjust volume control of the headphones, press the VOL > or VOL < button (the volume display appears). Press the arrow up or down button (the headphone volume display appears), then press the right or left arrow button to adjust the headphone volume.

**VIDEO (in)** Receives video from another component such as a VCR, camcorder or video game console.

**L/MONO and R AUDIO** Receives audio from another component such as a VCR, camcorder or video game console.

**S-VIDEO (in)** Allows you to connect an S-Video cable from another component. Make sure you also connect audio cables from the component to the TV.

### Front Panel Buttons

If you cannot locate your remote, you can use the front panel buttons of your TV to operate many of the TV's features.

**MENU/OK** Brings up the Main menu. In the menu system, it selects highlighted items.

**CH v** Scans down through the current channel list. In the menu system, acts like down arrow button on the remote control and adjusts menu controls.

**CH ^** Scans up through the channel list. In the menu system, acts like up arrow button on the remote control and adjusts menu controls.

**VOL <** Decreases the volume. In the menu system, acts like left arrow button on the remote control and adjusts menu controls.

**VOL >** Increases the volume. In the menu system, acts like right arrow button on the remote control and adjusts menu controls.

**POWER** Turns the TV on and off.

## Plug in the TV

Plug the end of the power cord into a grounded wall outlet. Insert the plug completely into the outlet.

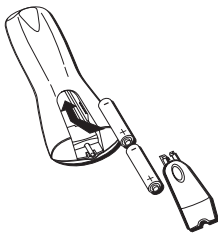

### Put batteries in the remote

- Remove the battery compartment cover from the back of the remote by pushing down on and sliding off the cover.
- Insert 2 "AA" fresh batteries. Make sure the polarities (+ and -) are aligned correctly.
- Replace the cover.

### How to Use the Remote Control to Complete the Initial Setup

The technical term is "Navigation" – how you move through the on-screen menus. The theory is the same throughout the menu screens: highlight your choice and select it.

To highlight a menu item, press the arrow buttons on the remote to highlight one of the items listed on the screen. Use the up or down arrow button to move up or down. Use the right or left arrow button to move right or left.

To select the item that you've highlighted, press OK.

*Note: Highlighted means that the menu item stands out from other menu items on the list (appears darker, brighter, or a different color).*

### Turn on the TV

Press TV on the remote, or press POWER on the TV's front panel.

*Note: Pressing the TV button not only turns on the TV, but puts the remote into TV mode. "TV mode" means that the buttons on the remote control operate the TV's functions.*

### Complete the Initial Setup

The menu system in your TV allows the TV's features to work properly. The first time you turn on your TV, the setup screens appear.

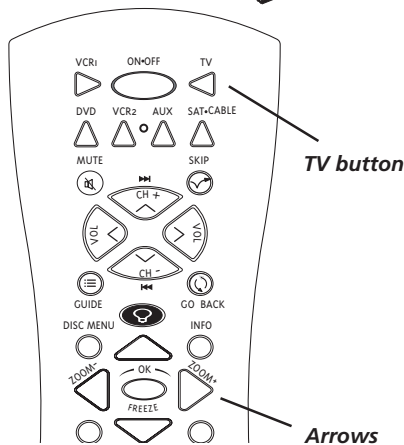

### Tip

To access the setup menus manually, press MENU and choose SETUP.



## Set the Menu Language

The first part of the setup allows you to select your preferred language for the menu system.

1. Highlight your preferred language for the menu system using the arrow buttons.
2. Press OK to select that language (the Channel Setup screen appears with *Auto channel search* highlighted).

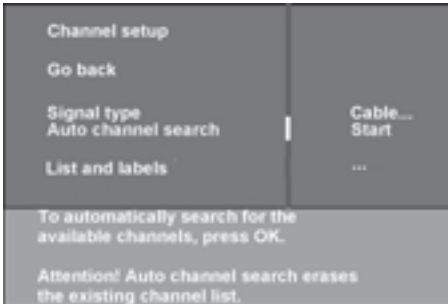

## Complete Auto Channel Search

This part of the setup allows the TV to search for all channels viewable through your antenna or cable TV system. This is sometimes called *auto programming*. Press OK to begin auto channel search. When the channel search is complete, press OK to access the *List & Labels* screen.



## Changing Lists and Labels

The List & Labels part of the setup lets you edit your channel list and choose or create a personal six-character label for each channel.

*Note: Changing List and Labels can be time consuming. You can change these at a later time by accessing the Setup menu.*

1. Press the left or right arrow to scroll through the available channels and choose the channel you want to edit.
2. Press the down arrow to highlight the *In channel list* option. Press the left or right arrow button to add (the box is checked) or remove (the box is unchecked) the channel from the list.
3. Press the down arrow to highlight the *Channel label* option. Press the left or right arrow button to scroll through the available list of 25 most common labels. The last option in the list allows you to create your own six-character label for the channel (the first letter of the label is highlighted).
4. Press the 1 or 2 number button to change the first letter of the label.
5. Press the right arrow to highlight the second letter, then press the 1 or 2 number button to change the second letter, etc...
6. When you are finished creating your label, highlight *Go Back* (the *Auto Convergence* menu appears).

## Auto Convergence

Your TV's picture tubes might have been disturbed during delivery or after you moved the TV, causing the color in your TV to be out of alignment. The colors adjust by starting auto convergence.

1. Press OK to begin auto convergence.
2. When the auto convergence is complete, the *Red center convergence* menu appears. The cross in the middle of the screen should be yellow. If it is not, use the arrow buttons to move the red cross to overlap the green cross. Press OK when adjustments are complete.
3. The *Blue center convergence* menu appears with a cyan cross in the middle of the screen. If it is not, use the arrow buttons to move the blue cross to overlap the green cross. Press OK (the TV tunes to the last available channel in the channel list).

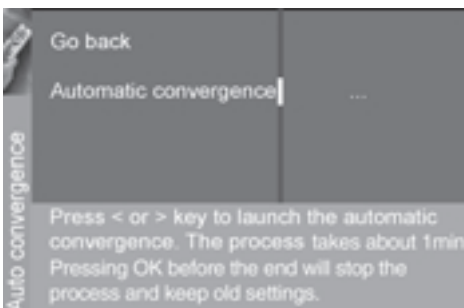

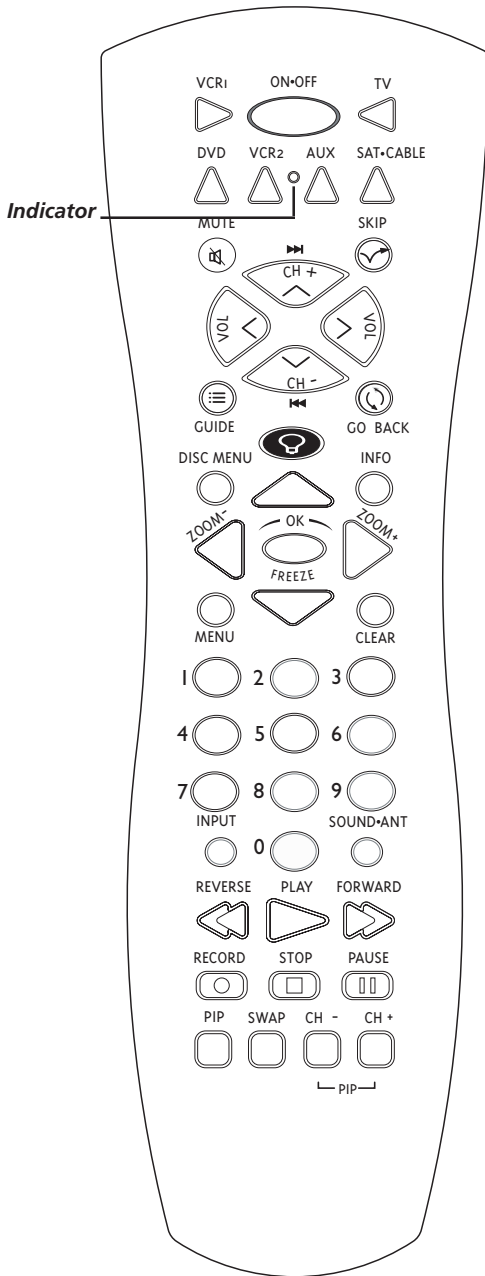

Note: The VCR1, DVD, VCR2, and SAT•CABLE buttons also turn on most RCA, GE, and Proscan products.

## Tip

To turn off all the RCA, GE, and Proscan components that are connected to the TV, press ON•OFF twice within two seconds.

This feature only works with most RCA, GE, and Proscan products.

## The Buttons on the Remote Control

**(0-9) Number Buttons** Enter channel numbers and time settings directly through the remote control.

To enter a one-digit channel, enter a zero first. To enter a two-digit channel, press the two digits. To enter a three-digit channel, press and hold the "1" button until "1" and two dashes (--) appear, then add the second two digits. Example: to tune to channel 123, press and hold 1 until "1--" appears, release the 1 button and then press 2 and 3.

**Arrows** Used to point to different items in the TV menu and to adjust the menu controls. Moves the PIP window when no menus are on the screen. Also switches the two POP windows when no menus are on the screen. For Zoom use, go to next page.

**AUX** Puts the remote in AUX mode. Can also be programmed to operate most brands of an additional remote-controllable component.

**Backlight** Lights up some of the buttons in the dark.

**CH + or CH -** Scans up or down through the current channel list. Press once to change the channel up or down; press and hold to continue changing channels.

**CH+ or CH- PIP** When using PIP or POP, changes the channel in the picture window.

**CLEAR** Removes any menu or display from the screen and returns you to normal viewing.

**DISC MENU** No function available in TV mode. If operating an RCA, a GE or Proscan DVD player, for example, brings up the Disc menu.

**DVD** Puts the remote in DVD mode and, if Autotuning is enabled, will turn on the TV and tune to the correct input channel.

**FREEZE** When watching TV, freezes the picture until you press another button to resume normal TV viewing.

*Note: Do not use the Freeze feature for an extended period of time. This can cause the image to be permanently imprinted on the picture tube. Such damage is not covered by your warranty. Press any button to unfreeze the picture at any time.*

**GO BACK** Returns you to the previous channel.

**GUIDE** Brings up the *Channel Guide* menu.

**INDICATOR** Indicates the programming mode when programming the remote to control components.

**INFO** Brings up status display; press again to clear the screen.

**INPUT** Press to toggle through the available input sources (VID1, VID2, FRNT, CMP1, CMP2 and DVI. Press the CH+ or CH- button to resume TV viewing).

**MENU** Brings up the Main menu.

**MUTE** Reduces the TV's volume to its minimum level. Press again to restore the volume.

**OK/FREEZE** When in the menu system, selects highlighted items. When watching TV, freezes the picture until you press another button to resume normal TV viewing.

**ON•OFF** When in TV mode, turns the TV on and off. If in another device mode (VCR, DVD, SAT•CABLE, etc.) and programmed, will turn the device on and off.

**PIP** Press once to bring up the small picture-in-picture window. Press again to bring up the picture-outside-picture (POP) windows. Press to remove POP. (See Chapter 3 for more information about using PIP.)

**REVERSE, PLAY, FORWARD, RECORD, STOP, PAUSE** If programmed, provides transport control for some remote-controllable VCRs, DVD players, laserdisc players, tape decks, and CD players.

**SAT•CABLE** Puts the remote in SAT•CABLE mode and, if Autotuning is enabled, will turn on the TV and tune to the correct input channel.

**SKIP** Press once before changing channels and the TV will wait 30 seconds before returning you to the original channel. Press repeatedly to add more time.

**SOUND•ANT** Displays the Picture and Sound preset settings at the bottom of the TV.

**SWAP** When using PIP, swaps the main picture with the PIP window. When using POP, swaps the left and right pictures.

**TV** Turns on the TV and puts the remote in TV mode. Also displays current status.

# Using the Remote Control

**VCR1** Puts the remote in VCR1 mode and, if Autotuning is enabled, will turn on the TV and tune to the correct input channel.

**VCR2** Puts the remote in VCR2 mode and, if Autotuning is enabled, will turn on the TV and tune to the correct input channel.

**VOL -** or **VOL +** Decreases or increases the TV's volume.

**ZOOM+** or **ZOOM-** When watching TV, changes the current format of the screen (4x3, Zoom 14/9, Zoom 16/9, Zoom 16/9 ^/v, Cinerama, regular mode 16/9).

## Using the INPUT Button

Use the INPUT button to scroll through the available input channels and view components you have connected to the TV.

1. Press TV to place the remote in TV mode. Make sure the component you want to view is turned ON.
2. Press INPUT to tune to an available input channel.
3. To return to the channel you were previously watching on TV, press CH+ or CH- button.

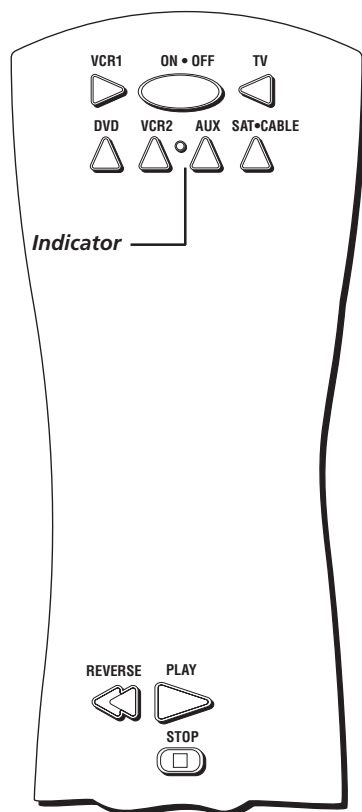

You'll use these buttons when you program the remote.

*Important: The remote may not be compatible with all models of all brands of components. It also may not operate all functions of the remote that came with your component.*

## Tip

To stop the automatic code search without programming any components, press and hold CLEAR until the indicator on the remote turns off.

## Programming the Remote to Operate Other Components

The universal remote can be programmed to operate most brands of remote controllable components. The remote is already programmed to operate most RCA, GE, and Proscan components.

Also, the AUX button can be programmed to operate most brands of an additional remote-controllable component.

*Note: The TV button can't be programmed on this remote.*

## Find Out If You Need to Program the Remote

To determine whether the universal remote needs to be programmed for your component, turn the component ON. For example, to program the remote for a VCR, turn on the VCR. Point the remote at the VCR, and press the VCR1 button. Then press ON•OFF or CH + (channel up) or CH - (channel down) to see if the VCR responds to the remote commands. If the component does not respond, the remote needs to be programmed.

## Programming the Remote

There are two ways to program the remote control:

- automatic code search
- direct entry

### Using Automatic Code Search

The following instructions can be used to program the remote to operate each of your components. If you want to stop the automatic code search without programming any of your components, press CLEAR until the indicator on the remote turns off.

1. Turn on the component you want to operate (VCR, DVD player, etc.)
2. Press and hold the component button you want to program (VCR1, DVD, etc.). While holding the component button, press and hold ON•OFF until the indicator on the remote turns on, then release both buttons.
3. Point the remote at the component. Press and release PLAY, then wait 5 seconds or until the indicator on the remote stops flashing.

At this point the remote is searching for the correct code to program. If, after 5 seconds, the component you want to operate does not turn off, press PLAY again to tell the remote to search the next set of codes.

Continue pressing PLAY until the component turns off or you have searched through all of the codes. There are 20 total sets of codes. If the component does not turn off after pressing PLAY 20 times, then the remote can't be programmed to operate that component.

If the component you want to control *does* turn off:

1. Press and release REVERSE, then wait 2 seconds. Repeat this step until the device turns back ON.
2. To finish, press and hold STOP until the indicator on the remote turns off.



## Important

You must continue pressing the component button while you enter the code.

Let's say you have a Zenith VCR. To program the universal remote to operate the VCR, you would:

Press and hold the VCR1 button while you enter the first code listed for Zenith in the VCR Codes column.

Release the VCR1 button. Press ON•OFF to see if the VCR responds. If it doesn't, follow the same steps, but enter the second code for Zenith VCRs instead of the first.

## Note

Some of the remote's buttons might operate differently for other components, especially when you're using another component's menu system.

## Using Direct Entry

1. Turn on the component to be programmed.
2. Look up the brand and code number(s) for the component on the code list in this section.
3. Point the remote at the component.
4. Press and hold the component button you want to program on the remote.
5. Enter the 4-digit code from the remote control code list on the following pages. If the indicator flashes, you have either entered an invalid code or the button isn't programmable.
6. Release the component button, and then press ON•OFF to see if the component responds to the command. If it doesn't, try pressing the component button and then ON•OFF again.
  - If you get no response, repeat these steps using the next code listed for your brand, until the component responds to the remote commands.
  - If you try all the codes for your component brand and none work, try the automatic code search method. If automatic code search doesn't find the code, the remote is not compatible with your component.

## How to Use the Remote After You've Programmed It

Because this universal remote can control several different components (TV, DVD, VCR, satellite receiver, etc.) it uses operational modes triggered by the component buttons. For example, if you want the remote to control the TV, you would press the TV button to put the remote into TV mode before you could control the TV.

1. Press the appropriate component button (DVD, TV, VCR1, VCR2, SAT•CABLE, AUX) to set the remote to control the component.
2. Press ON•OFF to turn the component ON or OFF.
3. Use the remote buttons that apply to that component.

### Notes:

- The remote may not be compatible with all brands and models of components. It also may not operate all functions of the remote that came with your component.
- If you keep pressing buttons and nothing happens, the remote is probably in the wrong mode. You must press the component button that matches the component you want to operate (i.e., if you want to operate the VCR, press VCR1 on the remote control to put the remote in VCR mode.)

## Remote Control Codes

### VCR Codes

Programmable for VCR1, VCR2, and AUX buttons.

Admiral .....	2132
Adventura .....	2026
Aiko .....	2027
Aiwa .....	2026
Akai .....	2003, 2004, 2005, 2007, 2008, 2111, 2112, 2113
American High .....	2021
Asha .....	2013
Audio Dynamics .....	2009, 2010
Audiovox .....	2014
Bell & Howell .....	2011
Beaumarck .....	2013
Broksonic .....	2012, 2025
Calix .....	2014
Candle .....	2013, 2014, 2015, 2016, 2017, 2018, 2019
Canon .....	2021, 2022, 2114
Capehart .....	2020, 2110
Carver .....	2062
CCE .....	2027, 2061
Citizen .....	2013, 2014, 2015, 2016, 2017, 2018, 2019, 2027
Colortyme .....	2009
Colt .....	2061
Craig .....	2013, 2014, 2023, 2061
Curtis-Mathes .....	2000, 2009, 2013, 2016, 2018, 2021, 2022, 2024, 2115, 2131
Cybernex .....	2013

Daewoo .....	2015, 2017, 2019, 2025, 2026, 2027, 2028, 2110
Daytron .....	2110
DBX .....	2009, 2010
Dimensia .....	2000, 2131
Dynatech .....	2026
Electrohome .....	2014, 2029
Electroponic .....	2014
Emerson .....	2012, 2014, 2015, 2021, 2024, 2025, 2026, 2029, 2030, 2031, 2032, 2033, 2034, 2035, 2036, 2037, 2038, 2039, 2040, 2041, 2042, 2044, 2045, 2046, 2047, 2065, 2113, 2116, 2117, 2130
Fisher .....	2011, 2023, 2048, 2049, 2050, 2051, 2052, 2118
Fuji .....	2021, 2119
Funai .....	2026
Garrard .....	2026
GE .....	2000, 2001, 2013, 2021, 2022, 2053, 2115, 2120, 2131
Goldstar .....	2009, 2014, 2018, 2054
Gradiente .....	2026
Harley Davidson .....	2026
Harman Kardon .....	2009
Harwood .....	2061
Headquarter .....	2011
Hitachi .....	2055, 2056, 2057, 2107, 2111, 2120, 2122
Hi-Q .....	2023
Instant Replay .....	2021
JCL .....	2021
JC Penney .....	2009, 2010, 2011, 2013, 2014, 2021, 2022, 2055, 2056, 2058, 2059, 2060, 2107, 2118
Jensen .....	2055, 2056, 2111
JVC .....	2009, 2010, 2011, 2018, 2111, 2123
Kenwood .....	2009, 2010, 2011, 2016, 2018, 2111, 2123
KLH .....	2061

Kodak .....	2014, 2021
Lloyd .....	2026
Logik .....	2061
LXI .....	2014
Magnavox .....	2021, 2022, 2062, 2063, 2104, 2105, 2108, 2124
Magnin .....	2013
Marantz .....	2009, 2010, 2011, 2016, 2018, 2021, 2062, 2064
Marta .....	2021
Masushita .....	2021
Mei .....	2021
Memorex .....	2011, 2013, 2014, 2021, 2023, 2026, 2104, 2132
MGA .....	2029, 2065, 2113
MGN Technology .....	2013
Midland .....	2053
Minolta .....	2055, 2056, 2107
Mitsubishi ..	2029, 2055, 2056, 2065, 2066, 2067, 2068, 2068, 2070, 2071, 2072, 2073, 2074, 2106, 2113, 2123
Montgomery Ward .....	2075, 2132
Motorola .....	2021, 2132
MTC .....	2013, 2126
Multitech .....	2013, 2016, 2026, 2053, 2061
NEC .....	2009, 2010, 2011, 2016, 2018, 2064, 2076, 2078, 2079, 2111, 2123
Nikko .....	2014
Noblex .....	2013
Olympus .....	2021
Optimus .....	2014, 2132
Optonica .....	2096
Panasonic .....	2021, 2022, 2109, 2125, 2126, 2127
Pentax .....	2016, 2055, 2056, 2107, 2120
Pentex Research .....	2018
Philco .....	2021, 2022, 2062, 2063
Philips .....	2021, 2062, 2096, 2124

## VCR Codes continued

Pilot	2014
Pioneer	2010, 2055, 2080, 2081, 2123
Portland	2016, 2017, 2019, 2110
Proscan	2000, 2001, 2131
Protec	2061
Pulsar	2104
Quarter	2011
Quartz	2011
Quasar	2021, 2022, 2125
RCA	2000, 2001, 2003, 2013, 2021, 2055, 2056, 2082, 2083, 2084, 2085, 2086, 2087, 2088, 2089, 2090, 2091, 2107, 2115, 2120, 2125, 2131, 2133
Radioshack/Realistic	2011, 2013, 2014, 2021, 2022, 2023, 2026, 2029, 2049, 2050, 2096, 2132
Radix	2014
Randex	2014
Ricoh	2128
Runco	2104
Samsung	2005, 2013, 2015, 2033, 2053, 2112
Sansui	2104, 2132
Sansui	2010, 2092, 2111, 2123
Sanyo	2011, 2013, 2023
Scott	2012, 2015, 2025, 2032, 2038, 2065, 2093, 2116
Sears	2011, 2014, 2021, 2023, 2048, 2049, 2050, 2051, 2055, 2056, 2107, 2118
Sharp	2017, 2029, 2094, 2095, 2096, 2097, 2132
Shintom	2004, 2056, 2061, 2098
Shogun	2013
Signature	2132
Singer	2021, 2061, 2128
Sony	2004, 2098, 2099, 2119
STS	2021, 2107
Sylvania	2021, 2022, 2026, 2062, 2063, 2065, 2124
Symphonic	2026
Tandy	2011
Tashiko	2014
Tatung	2111
TEAC	2026, 2085, 2111
Technics	2021, 2109
Teknika	2014, 2021, 2026, 2100, 2129
TMK	2013, 2024, 2047
Toshiba	2015, 2049, 2051, 2055, 2065, 2093, 2116
Totevision	2013, 2014
Unitech	2013
Vector Research	2009, 2010, 2015, 2016
Victor	2010
Video Concepts	2009, 2010, 2015, 2016, 2113
Videosonic	2013
Wards	2013, 2014, 2015, 2021, 2023, 2026, 2029, 2055, 2056, 2061, 2096, 2101, 2102, 2103, 2107, 2116, 2132
XR-1000	2021, 2026, 2061
Yamaha	2009, 2010, 2011, 2018, 2111
Zenith	2004, 2098, 2104, 2119, 2128

## Satellite Receiver Codes

Programmable for SAT•CABLE and AUX buttons.

Alphastar	5079
Chapparral	5056, 5057
Dishnet	5078
Drake	5058, 5059
Echostar	5089
GE	5000, 5001
General Instruments	5060, 5061, 5062
Hitachi	5083, 5084
Hughes	5077, 5090
JVC	5082
Panasonic	5075
Philips	5085
Primestar	5076
Proscan	5000, 5001
RCA	5000, 5001, 5071, 5080, 5081
Realistic	5063
Sony	5072
STS1	5064
STS2	5065
STS3	5066
STS4	5067
Toshiba	5068, 5073
Uniden	5069, 5086

## Cable Box Codes

Programmable for SAT•CABLE and AUX buttons.

ABC	5002, 5003, 5004, 5006, 5053
Antronix	5008, 5009
Archer	5008, 5009, 5010
Cabletenna	5008
Cableview	5008
Colour Voice	5012, 5013
Comtronics	5014
Contec	5016
Eastern	5017
GC Electronics	5009
GE	5000, 5001
Gemini	5018, 5019
General Instrument	5003
Hamlin	5020, 5021, 5022, 5028, 5035, 5045
Hitachi	5003
Jerrold	5003, 5018, 5023, 5024, 5046, 5053
Magnavox	5025
Memorex	5026
Movie Time	5027
NEC	5005
NSC	5027
Oak	5016, 5029
Panasonic	5048, 5052
Philips	5011, 5012, 5013, 5015, 5019, 5025, 5030, 5031, 5032
Pioneer	5033, 5034
Proscan	5000, 5001
RCA	5007, 5047, 5049, 5052
Realistic	5009
Regal	5022, 5035
Regency	5017
Rembrandt	5003
Samsung	5034
Scientific Atlanta	5006, 5036, 5037, 5038
Signal	5018
Signature	5003
Sprucer	5052
Standard Components	5039, 5044
Starcom	5018, 5053
Stargate	5018
Starquest	5018
Tocom	5004, 5023
Tusa	5018
TV86	5027
Unika	5008, 5009
United Cable	5053
Universal	5008, 5009, 5010
Viewstar	5025, 5027
Zenith	5050, 5051

## DVD codes

Programmable for DVD and AUX buttons.

Aiwa	3009
GE	3000
Hitachi	3008
JVC	3002, 3010
Konka	3011, 3012
Magnavox	3003
Mitsubishi	3004
Panasonic	3013
Philips	3003, 3019, 3021, 3022
Pioneer	3005
Proscan	3000
RCA	3000, 3001
Sanyo	3014
Sony	3006, 3015, 3016
Toshiba	3007, 3017, 3020
Zenith	3018

## Audio Codes

Programmable for the AUX button only.

### RCA and Dimensia

AM/FM	4003, 4270
AUX	4004
Phono	4005
Tape	4006
CD	4007, 4190, 4211

### Receivers

Aiwa	4261, 4262, 4263, 4264, 4265, 4266, 4267, 4277
Denon	4283
Harman Kardon	4276
JVC	4268
JVL	4276
Kenwood	4269
Onkyo	4278
Optimus	4284
Panasonic	4279, 4280
Pioneer	4275
RCA	4270
Sherwood	4282
Sony	4271, 4272, 4281
Technics	4279, 4280
Wards	4275
Yamaha	4274, 4275

### CD Players



ADC	4200, 4201, 4220
Aiwa	4175, 4203
Akai	4205
Denon	4208
Dynatech	4177
Emerson	4178
Fisher	4179, 4212, 4213
GE	4216
Hitachi	4180
JVC	4181, 4221
Kenwood	4183, 4222, 4224
Luxman	4225
Marantz	4185, 4226
Mitsubishi	4229, 4230
MCS	4228
Nakamichi	4232, 4233
NEC	4184
Onkyo	4186, 4234, 4235
Optimus	4237, 4238, 4239
Panasonic	4188
Pioneer	4189, 4240
RCA	4190, 4211
Sanyo	4250
Sears	4207
Sherwood	4243
Sony	4195, 4209, 4244
Teac	4245, 4246, 4247
Technics	4197
Toshiba	4231
Yamaha	4198, 4199, 4248



Sample displays on a Channel Banner.

## Channel Banner

There are several indicators that might appear when you press the TV or INFO buttons on the remote. This display is called the Channel Banner. The following list describes the items on the Channel Banner screen (left to right and top to bottom).

	Displays the current screen format.
<i>Mono</i> (or <i>Stereo</i> )	Mono displayed when the current channel is broadcasting in mono. Stereo displayed when the current channel is broadcasting in stereo.
<i>SAP</i>	Displayed when the current channel is broadcasting SAP (Second Audio Program) information.
	Displayed when the Parental Controls are locked.
<i>CC</i>	Displayed when Closed Captioning is available on the current channel.
<i>03:45 pm</i>	Displays the current time.
<i>15 NBC</i>	Displays the current channel and label assigned to the channel.
<i>Commercial</i> <i>skip 0:30</i>	Displayed to count time remaining on the commercial skip (SKIP) timer.
	Displayed when you mute the sound.

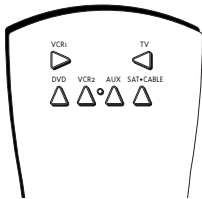

With the autotuning feature, you can set up the TV to tune to the channel you need to watch by pressing that component's button.

## Why You Should Use the Autotuning Feature

The autotuning feature automatically tunes the TV to the correct channel for different components you have connected to your TV (like a VCR, DVD Player, etc.) When you set up autotuning in the menu system you don't have to remember to change your TV to channel 3, for example, when you want to watch the tape in your VCR.

## How to Set Up the Autotuning Feature

The way you set up the autotuning feature in the TV's menu corresponds to the component buttons on the remote and the way you have each component connected to your TV. When you set up autotuning, you're telling the TV what channel to tune to when you press the VCR1, VCR2, DVD, or SAT•CABLE button on the remote control.

1. Press MENU (the *MAIN MENU* appears).
2. Highlight *Setup* and press OK on your remote control.
3. Highlight *Autotuning* and press OK.
4. Choose which channel you would like to set:
  - Set VCR 1 Channel* Lets you set up the channel the TV tunes to when you press the VCR1 button.
  - Set VCR 2 Channel* Lets you set up the channel the TV tunes to when you press the VCR2 button.
  - Set DVD Channel* Lets you set up the channel the TV tunes to when you press the DVD button.
  - Set SAT/Cable Channel* Lets you set up the channel the TV tunes to when you press the SAT•CABLE button on an RCA satellite receiver remote. (The RCA DTC100 HD receiver is considered a satellite device and can be set up for autotuning using this channel.)
5. Press the right arrow button to select the choice that matches the way you have the component connected to this TV, and press OK.

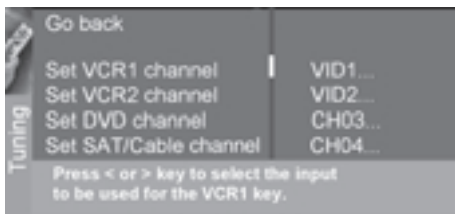

The choices and a brief explanation follow:

*N/A* Choose this if you don't have this particular component connected to the TV, or if you don't want the TV to automatically tune to the correct channel when you're using this component.

*Channel 3 or 4* Component is connected to the CABLE/ANTENNA jack on the back of the TV, and you want the TV to tune to channel 3 when you press the corresponding button on the remote. Reminder: make sure the component's Channel 3/4 switch is set to channel 3.

*VID1 or VID2 (Video Input)* Component is connected to a VIDEO or S-Video jack on the back of the TV and you want the TV to tune to a VID input channel when you press the corresponding button.

*FRNT (Front Video Input)* Component is connected to the VIDEO jack on the front of the TV and you want the TV to tune to the front VID input channel (FRNT) when you press the corresponding button.

# Using the TV's Features

**CMP1 or CMP2 (Component Video Input)** Compatible component video source, such as a DVD player or digital TV converter box, is connected to the three COMPONENT VIDEO INPUT jacks (Y,PB,PR) on the back of the TV and you want the TV to tune to the component video input channel (CMP) when you press the corresponding button.

**DVI** Component is connected to the DVI-HDCP jack on the back of the TV and you want the TV to tune to the DVI input channel when you press the corresponding button.

## Parental Controls and V-Chip

The first three choices in the *Parental Controls* menu involve software inside your TV (referred to as V-Chip) which allows you to block TV programs and movies based on violence, sex, or other content you may believe children should not view.

Once you block programs, you can unblock programs by entering a password.

By default, the software inside your TV is turned "off."

*Note: Parental Control settings are not available for DVI, CMP1 or CMP2 inputs.*

## How V-Chip Works

V-Chip reads the program's age-based rating (TV-MA, TV-14, etc.) and content themes [(Violence (V), Adult Language (L), etc.)]. If you have blocked the rating and/or content themes that the program contains, you will receive the message *This channel is not approved for viewing.*

Broadcasters are not required to provide content themes, so programs received with no content themes will only be blocked if you block their age-based rating. You can also block out programs that have been given a rating of "Not Rated," and programs that are considered "unrated." The TV age-based ratings and content themes you can block are listed in the following table.

Age-Based Rating	Description and Content Themes for Age-Based Ratings
TV-MA	<b>Mature Audience Only.</b> Specifically designed to be viewed by adults and may be unsuitable for children under 17. It contains one or more of the following content themes: crude indecent language (L), explicit sexual activity (S), or graphic violence (V).
TV-14	<b>Parents Strongly Cautioned.</b> Contains some material that many parents would find unsuitable for children under 14. Parents are strongly urged to exercise greater care in monitoring this program and are cautioned against letting children under the age of 14 watch unattended. This program contains one or more of the following content themes: intensely suggestive dialogue (D), strong coarse language (L), intense sexual situations (S), or intense violence (V).
TV-PG	<b>Parental Guidance Suggested.</b> Contains material that parents may find unsuitable for younger children. Many parents may want to watch it with their younger children. The program contains one or more of the following content themes: some suggestive dialogue (D), infrequent coarse language (L), some sexual situations (S), or moderate violence (V).
TV-G	<b>General Audience.</b> Most parents would find this program suitable for all ages. It contains little or no sexual dialogue (D) or situations (S), no strong language (L), and little or no violence (V).
TV-Y7	<b>Directed to Children 7 years and older.</b> Designed for children ages 7 and above. It may be more appropriate for children who have acquired the developmental skills needed to distinguish between make-believe and reality. Themes and elements in this program may include mild fantasy violence (FV) or comedic violence, or may frighten children under the age of 7.
TV-Y	<b>All Children.</b> Themes and elements in this program are designed for a young audience, including children from ages 2-6. It is not expected to frighten younger children.



## V-Chip TV Rating

The *V-Chip TV Rating* lets you decide which TV programs can and cannot be viewed. To set TV programming limits:

1. Choose *Parental Control* from the Main menu. If Parental Controls have previously been locked, you must enter your password.
2. Press OK to continue.
3. Highlight and select V-Chip TV rating.
4. Once you get to the *V-Chip TV rating limit* screen, use the arrow buttons and OK on your remote to change the status of a TV program rating or content theme from *View* to *Block*.
5. For TV rating limits to take effect, lock Parental Controls by accessing the *Lock parental controls* menu.

The following sections give you more details about how to change the status of TV program limits.

### The V-Chip Rating Screen

The following is an example of where items are located within the Rating Limit screen.

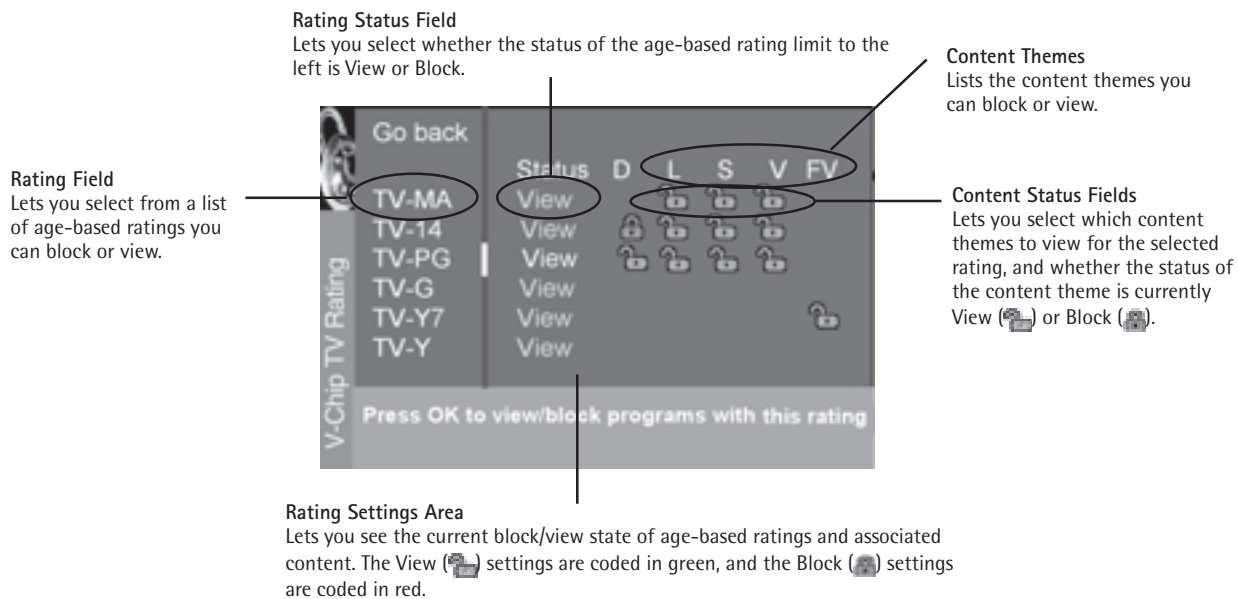

# Using the TV's Features

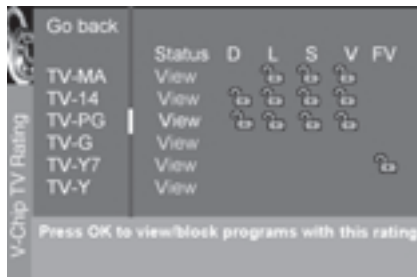

## Blocking Age-Based Ratings

You can automatically block all program ratings above a specified age-based rating level.

To block programs with higher ratings:

1. Press the up or down arrow button to scroll to the rating corresponding with the lowest rating you do not want the child to watch.
2. Press the OK button to toggle between *View* and *Block*. The status for the rating listed to the left and all higher ratings automatically changes to *Block* (and ).
3. Press the up or down arrow button to highlight Go back and press OK.
4. Select *Lock Parental Controls* from the *Parental Control* menu for rating limits to take effect.

Hierarchy of Age-Based Ratings	
TV-MA	Mature Audience Only
TV-14	Parents Strongly Cautioned
TV-PG	Parental Guidance Suggested
TV-G	General Audience
TV-Y7	Directed to Children 7 years and older
TV-Y	All Children

## Viewing Age-Based Ratings

After you block age-based ratings, you can change some of the ratings back to *View*.

1. Press the up or down arrow button to select the rating with a status of *Block*.
2. Press OK to select *View*.

Content Themes	
D	Sexually explicit dialogue
L	Adult language
S	Sexual situations
V	Violence
FV	Fantasy Violence

## Blocking Specific Content Themes

You can block programs based on their content. (Content is represented by the D, L, S, V and FV on your screen.) When you block a content theme for a particular rating, you automatically block that content theme for higher rated programs as well.

To block program content:

1. Determine the content themes you want to block.
2. Press the down arrow button to scroll to the rating whose content theme you want to change.
3. Press the right arrow button to move the yellow highlight to a particular content theme status.
4. Press the OK button to change its status to . (In the example to the left, you block the language (L) corresponding with TV-14. The language for TV-MA is blocked as well.)

*Notes: Broadcasters are not required to provide content themes or age-based ratings.*

*You must remember to lock Parental Controls for rating limits to take effect.*

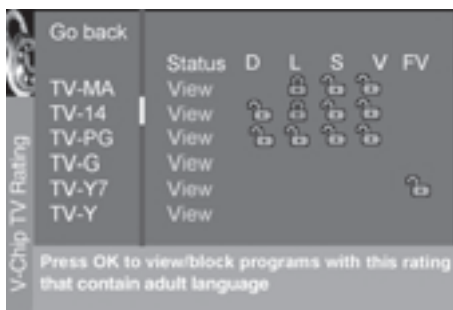

## Viewing Specific Content Themes

If you block specific content themes, you have the option of going back and changing some of the content themes back to *View*:

1. Determine the content themes you want to change to *View*.
2. Press the down arrow button to scroll to the rating whose content theme you want to change, such as under language (L) corresponding with TV-14.
3. Press the right arrow button to move the yellow highlight to a particular content theme status.
4. Press the OK button to change the status back to . Your child would then be able to watch programs with the TV-14 adult language content, but not programs with TV-MA language content.

*Note: Only the content theme status corresponding to TV-14 (L) language changes to (V) View. Higher rated content themes, such as that for TV-MA language, do not change.*

## V-Chip Movie Rating Limit

Set movie rating limits by blocking movies rated above a specified level.

To change menu:

1. Press MENU on the remote control (the *TV MAIN MENU* appears).
2. Select *Parental Control*.
3. Select *V-Chip movie rating*.

## Tip

To change all V-Chip movie or TV ratings to *View*, press the 0 number button.

## Blocking Movie Ratings

Once you are in the Movie Ratings menu, follow the same steps described for blocking TV ratings.

## V-Chip Unrated Program Block

This option lets you decide if programs that the V-Chip recognizes as "unrated" can be viewed. "Unrated" TV programs may include news, sports, political, religious, local and weather programs, emergency bulletins, public announcements, and programs without ratings.

*View* All unrated programs are available.

*Block* All unrated programs are not available.

*Note: You must remember to lock Parental Controls for rating limits to take effect.*

Press the down arrow to highlight V-Chip unrated. Then press the right arrow to switch between Block and View.

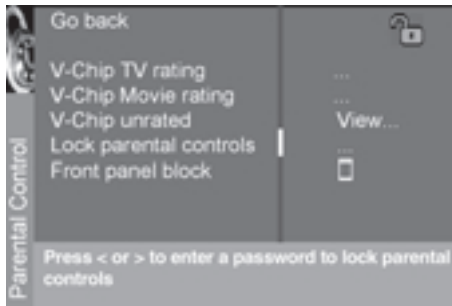

## Lock/Unlock Parental Controls

Selecting this option lets you lock and unlock parental controls settings using a password.

If you do not lock parental controls, none of the settings for V-Chip, Channel Block, or Front Panel Block will take effect.

If you forget your password, press the MENU button, then select *Parental Control* (the password entry screen appears). Simultaneously press and hold CH+ and VOL+ on the television for 3 seconds. Parental Controls unlock and the *Parental Control* menu appears so you can enter a new password.

## Front Panel Block

Selecting this option lets you block (disable) or unblock (enable) the TV's front panel. The remote still tunes to any channel. When using this as a Parental Control method, remove access to any remote that is capable of operating the television while you have the front panel blocked.

Don't forget to lock parental controls after you change the status. If you don't, the front panel block will not take effect.

## PIP (Picture-in-Picture) and POP (Picture-outside-Picture) Operation

The PIP (picture-in-picture) feature lets you display a second, smaller picture on top of the main picture. POP (picture-outside-picture) lets you display two windows side by side.

*Note: PIP and POP are not available for DVI or component video sources (CMP1 or CMP2).*



PIP example



POP example

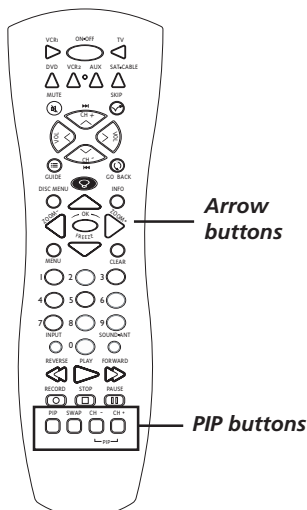

## PIP and POP Buttons

There are several remote buttons that control the way the PIP window works:

**PIP** Brings up the PIP window. Press again to bring up POP. Press again to remove the window.

**Up and down arrow buttons** Let you move the PIP window to different corners of the screen. Up arrow moves PIP counterclockwise; down arrow moves PIP clockwise.

**Left and right arrow buttons** Switches the left POP window to the right side, and the right POP window to the left.

**SWAP** Switches, or "swaps," the video from the PIP window with the main picture. Switches the main POP window, where the sound is coming from, with the other window.

**PIP CH+ and CH-** Lets you change channels in the PIP and right POP picture.

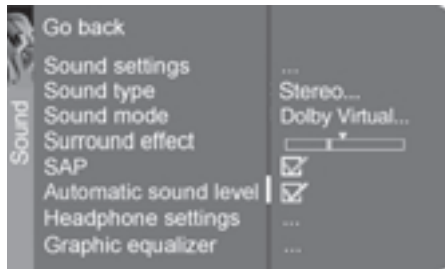

## Sound Menu

**Sound settings** Displays a choice list that lets you adjust the TV's speakers and subwoofer.

**Left & Right balance** Use the left or right arrow to center the bar under the arrow to balance the left and right speakers.

**Left & Right speakers** Use the left or right arrow to select *External* (if your TV is using external amplifier) or *Internal* (if your TV is using the speakers in the TV).

**Subwoofer** Set the TV's subwoofer to *External*, if the TV is using an external subwoofer; or *None*.

**Sound type** Press the right arrow to scroll through the available audio types, which control the way the sound comes through your speakers.

**Mono** Plays the sound in mono only. Use this setting when receiving broadcasts with weak stereo signals.

**Stereo** Splits the incoming stereo audio signal into left and right channels. Most TV programs and recorded materials have stereo audio. The word *Stereo* appears on the TV when you tune to a program that is broadcast in stereo.

**Automatic** Chooses the sound type according to the current signal.

**Sound Mode** Press the right arrow to scroll through the available audio modes, which provides special processing through your speakers and depends on how you set the sound type.

**Normal** Does not give any special processing, simply provides mono or stereo sound.

**Wide** Available only for mono signals. "Widens" sound from mono broadcasts and mono components connected to your TV for a fuller, more spacious sound.

**Magic** Available only for stereo signals. Gives a surround effect with more bass.

**Dolby Virtual** Available only for stereo signals. Creates a virtualized surround sound experience from two speakers using the Dolby Pro Logic decoding. It provides the sensation of being surrounded by additional speakers.

**Surround effect** Controls the amount of surround sound in Dolby Virtual sound mode.

**Second Audio Program (SAP)** Plays the program's audio in a second language, if one is available. The TV displays the word *SAP* when you tune to a program that is broadcast with *SAP* information. *SAP* audio is broadcast in mono. *SAP* is also used to broadcast a program's audio with descriptions of the video for the visually impaired.

**Automatic sound level** Reduces the annoying blasts in volume during commercial breaks, and also amplifies softer sounds in program material. Eliminates the need to constantly adjust volume control.

**Headphone settings** Displays a choice list of available settings you can adjust: *Volume*, *Bass* and *Treble*. The *Headphone sound option* allows you to choose stereo, mono or automatic. These descriptions are same as sound type above.

**Graphic equalizer** Allows you to choose a specific sound through the *Sound Preset* option. Press the right arrow to cycle through the options: *Standard*, *Movie*, *Voice*, *Music*, *Flat*, *Videogame*, *Video camera* and *Personal*.

The *Frequency range* displays the different treble and bass bands set for each *Sound Preset* option. You can choose a band and make adjustments. When you make adjustments, the *Sound Preset* option automatically changes to *Personal*. Press the left or right arrow button to select the frequency (Bass 100Hz, Mid Bass 500Hz, Medium 1.5kHz, Mid Treble 5kHz, Treble 10kHz) you want to adjust. Then use the up or down arrow button to adjust the decibel.

To view the frequency range of another *Sound Preset* option, press the right arrow until no band is selected and *Frequency range* is highlighted. Then press the up arrow to highlight *Sound Preset*.

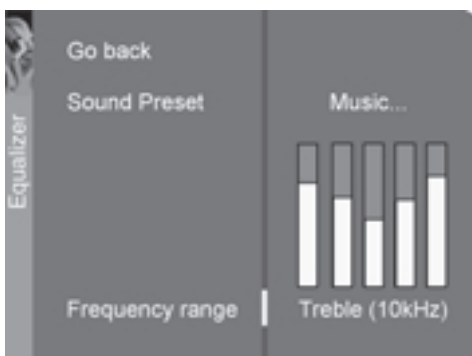



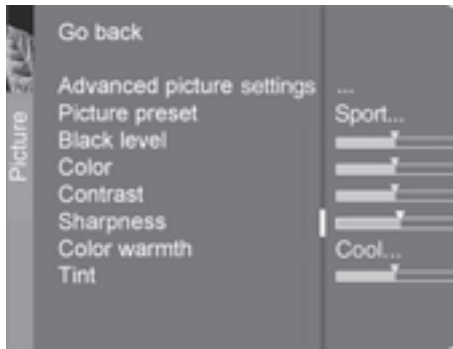

## Picture Menu

The Picture menu options apply to the video for the main TV and video input selections.

### Advanced picture settings

**Contrast expand** Adjusts the contrast of the picture according to the light of the room. Press the right arrow to choose between *Low*, *Medium* or *High*.

**SVM (Scan Velocity Modulation)** Improves the sharpness of the picture by changing the speed of the cathode-ray tube's electron beam when it transitions between dark and light areas of the screen. Choose to have it on (box checked) or off (box unchecked), depending on your preference.

**Autoformat** When enabled (box checked) the TV automatically detects the screen format the signal is sending for each channel, as well as input channels.

**Video noise reduction** Allows you to choose a setting to reduce picture "static" or any type of interference. It is especially useful for providing a clearer picture in weak analog signal conditions. Press the right arrow to choose between: *Off* for no noise reduction; *Minimum* for a softer, smoother picture and retains picture sharpness and detail; *Medium* for a slightly softer picture than the Minimum setting; *Maximum* for an even softer, smoother picture than the other settings. However, the picture detail is somewhat decreased.

*Note: Autoformat and Video noise reduction are available for DVI, CMP1 and CMP2 inputs if the signal is 480i.*

**Picture Presets** Displays a choice list that lets you select one of the preset picture settings: *Movie*, *Videogame*, *Personal*, *Sports*, *Ideal*, *Showroom* or *Video Camera*. Choose the setting that is best for your viewing environment.

**Black Level** Adjusts the brightness of the picture.

**Color** Adjusts the richness of the color.

**Contrast** Adjusts the difference between the light and dark areas of the picture.

**Sharpness** Adjusts the crispness of the edges in the picture.

*Note: You can adjust sharpness for each channel. This is useful if channels appear fuzzy.*

**Color Warmth** Displays a choice list that lets you set one of three automatic color adjustments: *Cool* for a more blue palette of picture colors; *Normal*; and *Warm* for a more red palette of picture colors. The warm setting corresponds to the NTSC standard of 6500 K.

**Tint** Adjusts the balance between the red and green levels.

*Note: Tint not available for DVI, CMP1 and CMP2 inputs.*

When you change any of these picture settings, the Picture Preset changes to personal. Use the left or right arrow button to make adjustments. To return to the Picture menu, press the up or down arrow button.

## Channel Guide Menu

Allows you to view and select from the entire channel list and their labels. Press the GUIDE button to bring up the Channel Guide menu. Use the up or down arrow to scroll through the list. Press OK to select and tune to the chosen channel.

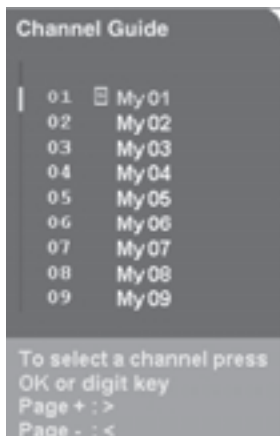

# Using the TV's Menu System

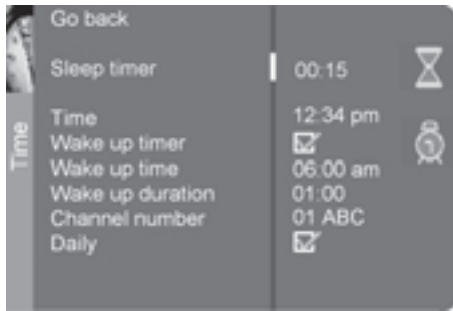

## Time Menu

**Sleep Timer** Lets you set the TV to turn off after a given time.

**Time** Lets you enter the current time. If it is eight o'clock, for example, you must first enter the number zero, then number eight. Use the OK button to choose between AM and PM.

**Wake up timer** Lets you set the TV to turn itself on. When you turn on *Wake up timer*, the following options appear:

**Wake up time** Lets you set the time you want the TV to turn itself on.

**Wake up duration** Lets you set how long you want the TV to stay on when it turns on.

**Channel number** Lets you select a specific channel the TV tunes to when the wake up timer is set.

**Daily** Lets you choose if you want the wake up timer to turn on daily.

## Parental Control Menu

The Parental Control Menu was explained in Chapter 3. Go to page 18 for more information.



## PIP Menu

**Display Mode**

**Off** No window is displayed.

**PIP** PIP (single) window is displayed.

**POP** POP (double) window is displayed.

**PIP channel** Allows you to choose the channel displayed in the PIP or main POP window. Scroll through channel list as well as the VID1, VID2 and FRNT input channels.

**PIP size** Allows you to choose having a *Small*, *Medium* or *Large* PIP window.

**PIP position** Allows you to choose having the PIP window in the *Top right*, *Top left*, *Bottom right* or *Bottom left* part of TV.

*Note: Pip size and position are not available for POP.*

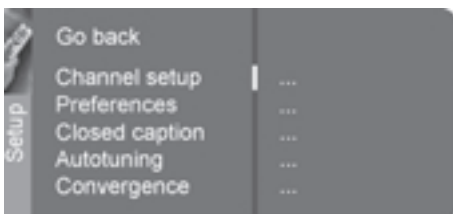

## Setup Menu

**Channel setup**

**Signal Type** TV chooses signal type during initial setup. If you change cable after setup, choose Cable if you are using cable or a cable box for TV signals. Choose UHF/VHF Antenna if you are using an off-air antenna for TV signals.

**Auto channel search** Searches for channels the signal is receiving. Go to page 12 for more information.

**Auto channel update** Searches for any new channels that are not in your channel list and adds them to the list.

**List and labels** Edit the channels in the list or choose labels for each channel. Go to page 12 for more information.

**Preferences**

**Language** Displays a choice list that lets you select your preferred language for the menus: *English*, *Spanish* or *French*.

**Maximum volume** Allows you to set how high volume turns up when you press the VOL+ button. Highlight *Maximum volume*, then press and hold OK to hear is the maximum volume. Make sure the volume has not been muted or turned all the way down.

**Curtain effect** Reveals or hides the picture by giving it a "stage curtain" effect when the TV is switched on or off.

**Special features** *Auto on* switches your TV on after a power outage; *Auto channel* tunes the TV to the channel you specify as the *Initial channel* when Auto on is enabled; *Auto volume* tunes the TV to the volume you set in *Initial volume* when Auto on is enabled.



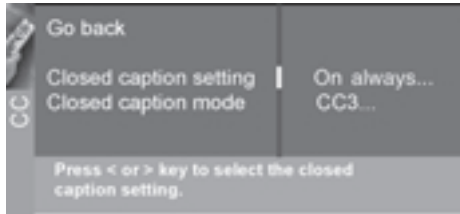

**Closed Caption** Many programs are encoded with closed-captioning information, which lets you display the audio portion of a program as text on the TV screen.

Closed captioning is not available on all channels at all times. Only specific programs encoded with closed-captioning information are applicable. When a program is closed captioned, CC is displayed in the channel banner. See Chapter 3 for more information about the channel banner. The closed caption options are:

**Closed caption setting** Displays a choice list that lets you choose the way closed captioning information is shown on the screen. Closed-captioning is not available with the high resolution input.

*Off* No captioning information displayed.

*On always* Captioning information shown always, when available.

*On when mute* Displays captioning information, when available, whenever the TV's sound is muted by pressing the MUTE button. The captioning information is not displayed when the sound is not muted.

**Closed-Caption Mode** Displays a choice list that lets you choose which captioning mode is used for displaying captioning information. If you are unsure of the differences among the modes, you may prefer to leave the closed captioned mode set to CC1, which displays complete text of the program in the primary language in your area.

**Autotuning** Displays a choice list that lets you set up the TV to automatically tune to the correct input channel when you press a component button (VCR1, DVD, VCR2, SAT•CABLE, etc.) on the remote. Go to Chapter 3 for details about the Autotuning feature.

**Convergence** *Auto convergence* automatically adjusts the TV's tubes; *Red convergence* displays the Red convergence screen, allowing you to use the arrow buttons to align the red and green images; *Blue convergence* displays the Blue convergence screen, allowing you to use the arrow buttons to align the blue and green images.

# Other Information

---

## Troubleshooting

Most problems you encounter with your TV can be corrected by consulting the following troubleshooting list.

*Note: If you prefer, we can provide you with the name of an Authorized Service Representative who will visit your home for a fee to install your electronic entertainment system and to instruct you in its operation. For details about this service, call 1-888-206-3359.*

## TV Problems

---

### TV won't turn on

- Press the TV button.
- Make sure the TV is plugged in.
- Check the wall receptacle (or extension cord) to make sure it is "live" by plugging in something else.
- Something might be wrong with your remote control. Press the POWER button on the front of the TV. If the TV turns on, check the remote control solutions on page 27.
- The front panel controls may be locked (disabled). Use the remote control to unlock the front panel controls by selecting the *Front Panel Block* in the *Parental Control* menu and press OK to uncheck the box.

### Buttons don't work

- If you're using the remote control, press the TV button first to make sure the remote is in TV mode.
- The front panel controls may be locked (disabled). Use the remote control to unlock the front panel controls by selecting the *Front Panel Block* in the *Parental Control* menu and press OK to uncheck the box.
- Unplug the TV for two minutes and then plug it back in. Turn the TV on and try again.

### TV turns off while playing

- Sleep timer may have been activated. Go to page 24 for instructions.
- Electronic protection circuit may have been activated because of a power surge. Wait 30 seconds and then turn on again. If this happens frequently, the voltage in your house may be abnormally high or low.
- Unplug. Wait five minutes. Plug in again.

### TV turns on unexpectedly

- Wake up timer might have been activated. Go to page 24 for instructions.
- Auto on might have been activated. Go to page 24 for instructions.
- You might have pressed CH+, CH- or INPUT on the remote accidentally.

### Blank screen

- Make sure the component connected to the TV is turned on.
- Try another channel.

### No sound, picture okay

- Maybe the sound is muted. Try pressing the volume up button to restore sound.
- If using S-Video or Y, P<sub>B</sub>, P<sub>R</sub>, remember to also connect the component's left and right audio output jacks to the TV's L/MONO and R Audio Input jacks.
- Make sure the INT/EXT switch on the back of the TV is put on "INT".
- The sound settings may not be set correctly. Go to page 22 for more information.

### Can't select certain channel

- Channel may be blocked or not approved in the *Parental Controls* menu.
- If using a VCR, check to make sure the TV/VCR button on the VCR is in the correct mode (press the TV/VCR button on your VCR).

### Noisy stereo reception

- May be a weak station. Use Sound menu to choose *mono* sound.

### No picture/blue screen, no sound but TV is on

- Maybe the cable/air function is set to the wrong position. Go to page 24 for detailed instructions.
- The channel might be blank — change channels.
- If you're watching your VCR and it's connected with coaxial cable to the CABLE/ANTENNA jack, tune the TV to channel 3 or 4 (whichever channel is selected on the 3/4 switch on the back of your VCR). Also check to make sure the TV/VCR button on the VCR is in the correct mode (press the TV/VCR button on your VCR).

### Sound okay, picture poor

- Check antenna connections. Make sure all of the cables are firmly connected to the jacks.
- Try adjusting sharpness function to improve weak signals. Go to page 23 for more instructions.

### Volume buttons not adjusting volume louder

- Check to make sure volume isn't limited by the maximum volume feature. Go to page 24 for more instructions.

### Picture not moving

- You have activated the Freeze feature by pressing OK on the remote. Press any button to "unfreeze" the picture.

### Black box appears on the screen

- Closed-captioning might be on. Check *Closed Caption* in the *Setup* menu. Go to page 25 for more instructions.

### Freeze not working

- The freeze feature is not available for Component video (CMP1 or CMP2) or DVI inputs.

### Low battery warning appears on screen

- Place new batteries in remote.

### The Remote Control Doesn't Work

---

- Something might be between the remote and the remote sensor on the component. Make sure there is a clear path.
- Maybe the remote isn't aimed directly at the component (TV or VCR) that you're trying to operate.
- Maybe remote is not in TV Mode. Press the TV button so remote will control TV.
- Maybe batteries in remote are weak, dead, or installed incorrectly. Put new batteries in the remote. (Note, if you remove the batteries, you may have to reprogram the remote to operate other components.)
- You might need to drain the remote's microprocessor: remove batteries and press the number 1 button for at least 60 seconds. Release the 1 button, replace the batteries, and (if necessary) program the remote again.

### Problems with V-Chip/Parental Controls

---

#### The rating limits don't work

- You must lock the settings. Go to the *MAIN MENU* (press MENU on your remote), select *Parental Control*, select *Lock Parental Controls*.

#### I don't remember my password and I want to unlock the TV

- If you forget your password, press MENU, then select *Parental Control* (the password entry screen appears). Simultaneously press and hold CH+ and VOL+ on the TV's front panel for 3 seconds. The Parental control menu appears on the screen, and you can re-enter a password via *Lock Parental Controls*.

#### The V-Chip won't let me watch a program even though it's not rated as violent.

- Maybe the movie was given an NR (Not Rated) status. After you block movie ratings, you must set *NR* to *View* separately in order to view movies with an NR rating.

### Care and Cleaning

CAUTION: Turn OFF your TV before cleaning.

You can clean the TV as required, using a soft lint-free cloth. Be sure to occasionally dust the ventilation slots in the cabinet to help assure adequate ventilation.

The TV's screen may be cleaned with a soft, lint-free cloth as well. Take care not to scratch or mar the screen. If necessary, you may use a cloth dampened with warm water. Never use strong cleaning agents, such as ammonia-based cleaners, or abrasive powder. These types of cleaners will damage the TV.

While cleaning do not spray liquid directly on the screen, or allow liquid to run down the screen and inside the TV. Also, never place drinks or vases with water on top of the TV. This could increase the risk of fire or shock hazard or damage to the TV.

**Caution:** Using video games or any external accessory with fixed images for extended periods of time can cause them to be permanently imprinted on the picture tube (or projection TV picture tubes). ALSO, some network/program logos, phone numbers, etc. may cause similar damage. This damage is not covered by your warranty.

# Other Information

---

## **Limited Warranty**

### **What your warranty covers:**

- Defects in materials or workmanship.

### **For how long after your purchase:**

- One year from date of purchase for labor.
- One year from date of purchase for parts.
- Two years from date of purchase for the picture tube.

The warranty period for rental units begins with the first rental or 45 days from date of shipment to the rental firm, whichever comes first.

### **What we will do:**

- Pay an Authorized Service Center the labor charges to repair your unit.
- Pay an Authorized Service Center for the new, or at our option, refurbished replacement parts and picture tube required to repair your unit.

### **How you get service:**

- Call 1-866-SCENIUM and have your unit's date of purchase and model number ready.
- A representative will troubleshoot your problem over the phone.
- If the representative determines that you should receive service, they will provide you with the name(s) of the Authorized Service Center in your area.
- Contact the Service Center and arrange for home or pick up, repair, and return service, provided that your unit is located within the geographic territory covered by an Authorized Service Center. If not, you must take your unit to the Service Center location at your own expense, or pay for the cost the Service Center may charge to transport your unit to and from your home.
- Proof of purchase in the form of a bill of sale or receipted invoice which is evidence that the product is within the warranty period must be presented to obtain warranty service. For rental firms, proof of first rental is also required.

### **What your warranty does not cover:**

- Customer instruction. (Your Owner's Manual describes how to install, adjust, and operate your unit. Any additional information should be obtained from your dealer.)
- Installation and related adjustments.
- Signal reception problems not caused by your unit.
- Damage from misuse or neglect.
- Batteries.
- Damage from images burnt onto the screen.
- A unit that has been modified or incorporated into other products.
- A unit purchased or serviced outside the U.S.A.
- Acts of nature, such as but not limited to lightning damage.

### **Product registration:**

- Please complete and mail the Product Registration Card packed with your unit. It will make it easier to contact you should it ever be necessary. The return of the card is not required for warranty coverage.

### **Limitation of Warranty:**

- THE WARRANTY STATED ABOVE IS THE ONLY WARRANTY APPLICABLE TO THIS PRODUCT. ALL OTHER WARRANTIES, EXPRESS OR IMPLIED (INCLUDING ALL IMPLIED WARRANTIES OF MERCHANTABILITY OR FITNESS FOR A PARTICULAR PURPOSE) ARE HEREBY DISCLAIMED. NO VERBAL OR WRITTEN INFORMATION GIVEN BY THOMSON MULTIMEDIA INC., ITS AGENTS OR EMPLOYEES SHALL CREATE A WARRANTY OR IN ANY WAY INCREASE THE SCOPE OF THIS WARRANTY.
- REPAIR OR REPLACEMENT AS PROVIDED UNDER THIS WARRANTY IS THE EXCLUSIVE REMEDY OF THE CONSUMER. THOMSON MULTIMEDIA INC. SHALL NOT BE LIABLE FOR INCIDENTAL OR CONSEQUENTIAL DAMAGES RESULTING FROM THE USE OF THIS PRODUCT OR ARISING OUT OF ANY BREACH OF ANY EXPRESS OR IMPLIED WARRANTY ON THIS PRODUCT. THIS DISCLAIMER OF WARRANTIES AND LIMITED WARRANTY ARE GOVERNED BY THE LAWS OF THE STATE OF INDIANA. EXCEPT TO THE EXTENT PROHIBITED BY APPLICABLE LAW, ANY IMPLIED WARRANTY OF MERCHANTABILITY OR FITNESS FOR A PARTICULAR PURPOSE ON THIS PRODUCT IS LIMITED TO THE APPLICABLE WARRANTY PERIOD SET FORTH ABOVE.

### **How State Law relates to this warranty:**

- Some states do not allow the exclusion nor limitation of incidental or consequential damages, or limitations on how long an implied warranty lasts, so the above limitations or exclusions may not apply to you.
- This warranty gives you specific legal rights, and you also may have other rights that vary from state to state.

### **If you purchased your television outside the United States:**

- This warranty does not apply. Contact your dealer for warranty information.

Service calls which do not involve defective materials or workmanship are not covered by this warranty. Costs of such service calls are the sole responsibility of the purchaser.

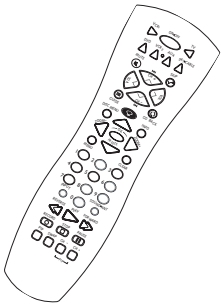

RCR160TALM1

**Remote Control** This is the remote control that came packed with your TV. Replacements or spares can be ordered as needed.

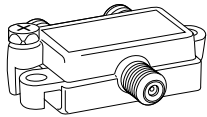

Splitter  
VH47

**2-way Signal Splitter** helps you connect to a second TV or VCR.

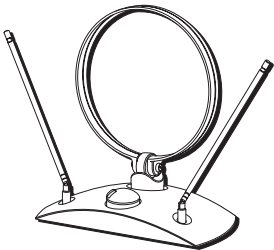

ANT200

**Amplified VHF/UHF/FM Antenna** allows you to easily switch from the antenna signal to cable or satellite easily without disconnecting antenna.

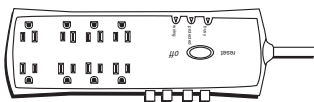

SCTV 160

**Surge Protector** provides eight outlets, coaxial and telephone line protection. Audible alarm for surge failure.

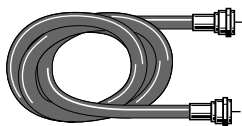

VH81 (3-ft)  
VH82 (6-ft)

**Screw-on Cable** attaches to the round antenna connectors (called 75-ohm F-type) on the back of your VCR or TV. The ends screw onto the connectors for a secure connection.

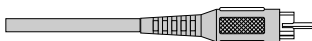

VH83

**Standard Audio/Video cable** with RCA-type phono plugs.



VH913

**S-Video Cable** has multi-pin connectors on each end for connecting S-Video components to your TV.

## Accessory Order Form

Description	Part No.	Price	Qty	Total
Screw-on antenna cable (3-ft)	VH81	\$3.95		
Screw-on antenna cable (6-ft)	VH82	\$4.95		
Push-on antenna cable (6-ft)	VH89	\$5.95		
Monaural VCR Dubbing Cable (6-ft)	VH83	\$5.95		
Stereo VCR Dubbing Cable (6-ft)	VH84	\$9.95		
S-Video Cable (6-ft)	VH976	\$7.95		
S-Video Cable (12-ft)	VH913	\$14.95		
2-way Signal Splitter	VH47	\$3.95		
Amplified Antenna	ANT200	\$49.95		
Remote Control (RCR160TALM1)	257003	\$35.00		
Audio•Video Adapter	228449	\$4.45		
Surge Protector	SCTV160	\$49.95		
Component Video Cables (6-ft)	DT6DC	\$24.95		
Component Video Cables (12-ft)	DT12DC	\$34.95		

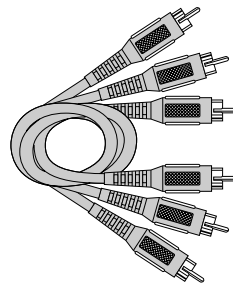

### Component Video Cables

Triple cable used to connect a video source with Y, P<sub>R</sub>, P<sub>B</sub> jacks to the TV.

Gold-Tipped cable

DT6DC (6-ft)

DT12DC (12-ft)

## HOW TO ORDER

**BY PHONE:** To place your order by phone, have your Visa, MasterCard or Discover Card ready and call  
**1-800-338-0376**

Use this number only to place an order for accessory items listed on this order form.

**BY MAIL:** mail money order or check in US currency (made payable to Thomson Consumer Electronics, Inc.) to the following address:

Video Accessories  
PO Box 8419  
Ronks, PA 17573

Visit the RCA website at [www.rca.com](http://www.rca.com)

---

Please do not send any products to the Indianapolis address listed in this manual or on the carton. This will only add delays in service for your product.

**Thomson multimedia Inc.**  
**10330 North Meridian Street**  
**Indianapolis, IN 46290**

©2002 Thomson multimedia Inc.  
Trademark(s)® Registered  
Marca(s) Registrada(s)  
Printed in USA  
**TOCOM 15903560**





## Free Manuals Download Website

<http://myh66.com>

<http://usermanuals.us>

<http://www.somanuals.com>

<http://www.4manuals.cc>

<http://www.manual-lib.com>

<http://www.404manual.com>

<http://www.luxmanual.com>

<http://aubethermostatmanual.com>

Golf course search by state

<http://golfingnear.com>

Email search by domain

<http://emailbydomain.com>

Auto manuals search

<http://auto.somanuals.com>

TV manuals search

<http://tv.somanuals.com>