

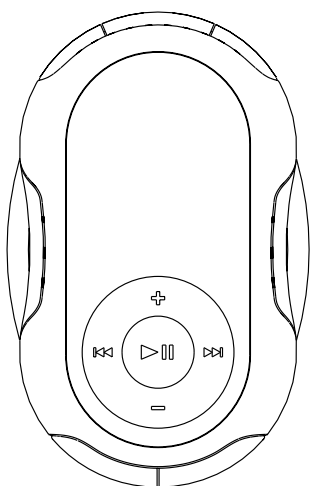

user **manual**

---

S2001  
S2002  
SC2001  
SC2002



It is important to read this instruction book prior to using your new product for the first time.

Download from [Www.Somanuals.com](http://www.Somanuals.com). All Manuals Search And Download.

# Table of contents

<b>Safety information</b> .....	<b>3</b>
FCC information .....	3
Product registration .....	4
For your records .....	4
Service information .....	4
Technical specification .....	4
Electrical consumption .....	4
<b>End user license agreement</b> .....	<b>6</b>
<b>Before your begin</b> .....	<b>8</b>
Unpacking your player .....	8
Computer system requirements .....	8
Warning .....	8
Back up your data .....	8
Precautions for the player .....	9
Caution while driving .....	9
Headset safety .....	9
Using clip earphones .....	9
Using armband/wristband .....	9
<b>Software setup</b> .....	<b>10</b>
<b>Computer connection</b> .....	<b>10</b>
Connecting the player to the computer .....	10
Charging the battery .....	11
Important battery information .....	11
Caution .....	11
<b>Transferring files to the player</b> .....	<b>12</b>
Transferring files via Yahoo! Music Jukebox (Windows XP or higher only) .....	12
Transferring files via Windows Explorer (Drag-and-drop) (Windows XP only) ... ..	13
Transferring files via Windows Explorer (Drag-and-drop) (Windows 2000) .....	13
Disconnecting your player from the computer .....	14
<b>General controls</b> .....	<b>15</b>
Overview .....	15
Turning on or off the player .....	15
Locking the keys .....	15
<b>File menu</b> .....	<b>16</b>
How files are organized? .....	16
File menu navigation .....	16
<b>Player menu</b> .....	<b>18</b>
Player menu navigation .....	18
<b>Music playback</b> .....	<b>20</b>
Music playback controls .....	20
Music playback display .....	20
My Selections .....	21
Other playback features .....	21
<b>Audible playback</b> .....	<b>22</b>
Audible playback controls .....	22
Audible playback display .....	22
<b>Radio</b> .....	<b>23</b>
Radio (switching on) .....	23
Radio (switching off) .....	23
Radio display .....	23
Manual and preset mode .....	23
Selecting radio frequency .....	23
Saving preset stations .....	24
Selecting preset stations .....	24
Clearing preset stations .....	24
Suppressing stereo signal .....	24
<b>Radio recording</b> .....	<b>25</b>
Start recording .....	25
Record duration .....	25
Listening to radio recording .....	25
Deleting radio recording .....	25
<b>Stopwatch</b> .....	<b>26</b>
Using stopwatch .....	26
Multiple lap timing .....	26
<b>BMI (Body Mass Index)</b> .....	<b>27</b>
Personal information .....	27
Changing unit .....	27
Checking BMI .....	27
<b>More information</b> .....	<b>28</b>
Troubleshooting Tips .....	28
Check for updates .....	29
Frequently asked questions .....	29
<b>Limited Warranty</b> .....	<b>30</b>
For U.S. .....	30
For Canada .....	31

# Safety information

## FCC information

This device complies with Part 15 of the FCC Rules. Operation is subject to the following two conditions: (1) This device may not cause harmful interference, and (2) this device must accept any interference received, including interference that may cause undesired operation. In accordance with FCC requirements, changes or modifications not expressly approved by Thomson Inc. could void the user's authority to operate this product. This equipment has been tested and found to comply with the limits for a Class B digital device, pursuant to Part 15 of FCC Rules. These limits are designed to provide reasonable protection against harmful interference in a residential installation. This equipment generates, uses, and can radiate radio frequency energy and, if not installed and used in accordance with the instructions, may cause harmful interference to radio communications. However, there is no guarantee that interference will not occur in a particular installation. If this equipment does cause harmful interference to radio or television reception, which can be determined by turning the equipment off and on, the user is encouraged to try to correct the interference by one or more of the following measures

- Reorient or relocate the receiving antenna.
- Increase the separation between the equipment and receiver.
- Connect the equipment into an outlet on a circuit different from that to which the receiver is connected.
- Consult the dealer or an experienced radio/TV technician for help.

Also, the Federal Communications Commission has prepared a helpful booklet, "How To Identify and Resolve Radio TV Interference Problems." This booklet is available from the U.S. Government Printing Office, Washington, DC 20402. Please specify stock number 004-000-00345-4 when ordering copies.

This Class B digital apparatus complies with Canadian ICES-003.  
Cet appareil numérique de la class B est conforme à la norme du NMB-003 du Canada.

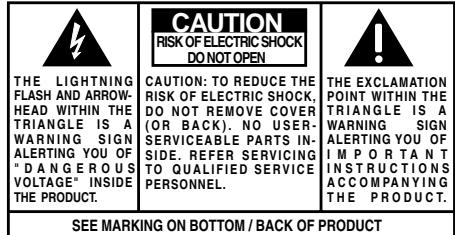

**WARNING: TO PREVENT FIRE OR ELECTRICAL SHOCK HAZARD, DO NOT EXPOSE THIS PRODUCT TO RAIN OR MOISTURE.**

The descriptions and characteristics in this owner's manual are for the purpose of general reference only and not a guarantee. In order to provide you with the highest quality product, we may make changes or modifications without prior notice. The English version serves as the final reference on all product and operational details should any discrepancies arise in other languages.

# Safety information



Equipment tested for compliance as a complete unit



Equipment tested for compliance as a complete unit



Equipment tested for compliance as a complete unit



Equipment tested for compliance as a complete unit

## Product Registration

Please fill out the product registration card and return it immediately. Returning this card allows us to contact you if needed.

## For Your Records

Keep your sales receipt for proof of purchase to obtain warranty parts and service.

In the event that service should be required, you may need both the model number and the serial number. In the space below, record the date and place of purchase, and the serial number:

Date of Purchase :  
Place of Purchase :  
Serial No. :

## Service Information

This product should be serviced only by those specially trained in appropriate servicing techniques. For instructions on how to obtain service, refer to the warranty included in this Guide.

## Technical Specification

Product: RCA Player  
Brand: RCA  
Model: S2001, S2002, SC2001, SC2002

## Electrical Consumption

DC : 3.7 V Lithium battery (built -in)

### IMPORTER

Comercializadora Thomson de México, S.A. de C.V.

Álvaro Obregón No. 151. Piso 13.  
Col. Roma. Delegación Cuauhtémoc  
C.P. 06700. México, D.F.

Telefono: 52-55-11-020360

RFC: CTM-980723-K55

# Safety information

## PLEASE READ AND SAVE FOR FUTURE REFERENCE

Some of the following information may not apply to your particular product; however, as with any electronic product, precautions should be observed during handling and use.

- Read these instructions.
  - Keep these instructions.
  - Heed all warnings.
  - Follow all instructions.
  - Do not use this apparatus near water.
  - Clean only with dry cloth.
  - Do not block any ventilation openings. Install in accordance with the manufacturer's instructions.
  - Do not install near any heat sources such as radiators, heat registers, stoves, or other apparatus (including amplifiers) that produce heat.
  - Do not defeat the safety purpose of the polarized or grounding-type plug. A polarized plug has two blades with one wider than the other. A grounding type plug has two blades and a third grounding prong. The wide blade or the third prong is provided for your safety. If the provided plug does not fit into your outlet, consult an electrician for replacement of the obsolete outlet.
  - Protect the power cord from being walked on or pinched particularly at plugs, convenience receptacles, and the point where they exit from the apparatus.
  - Only use attachments/accessories specified by the manufacturer.
  - Use only with the cart, stand, tripod, bracket, or table specified by the manufacturer, or sold with the apparatus. When a cart is used, use caution when moving the cart/apparatus combination to avoid injury from tip-over.
- Unplug this apparatus during lightning storms or when unused for long periods of time.
  - Refer all servicing to qualified service personnel. Servicing is required when the apparatus has been damaged in any way, such as power-supply cord or plug is damaged, liquid has been spilled or objects have fallen into the apparatus, the apparatus has been exposed to rain or moisture, does not operate normally, or has been dropped.

### • **ADDITIONAL SAFETY INFORMATION**

- Apparatus shall not be exposed to dripping or splashing and no objects filled with liquids, such as vases, shall be placed on the apparatus.
- Always leave sufficient space around the product for ventilation. Do not place product in or on a bed, rug, in a bookcase or cabinet that may prevent air flow through vent openings.
- Do not place lighted candles, cigarettes, cigars, etc. on the product.
- Connect power cord only to AC power source as marked on the product.
- Care should be taken so that objects do not fall into the product.
- Do not attempt to disassemble the cabinet. This product does not contain customer serviceable components.

### • **IF YOUR PRODUCT OPERATES ON BATTERIES, adhere to the following precautions:**

- A. Any battery may leak electrolyte if mixed with a different battery type, if inserted incorrectly, or if all batteries are not replaced at the same time.
- B. Any battery may leak electrolyte or explode if disposed of in fire or an attempt is made to charge a battery not intended to be recharged.
- C. Discard leaky batteries immediately. Leaking batteries can cause skin burns or other personal injury. When discarding batteries, be sure to dispose of them in the proper manner, according to your state/provincial and local regulations.



**Portable Cart Warning**

# End user license agreement

## **IMPORTANT: READ CAREFULLY BEFORE DOWNLOADING OR INSTALLING THIS SOFTWARE!**

THIS END USER LICENSE AGREEMENT (THIS "EULA") IS A LEGAL AGREEMENT BETWEEN YOU AND THOMSON INC., OR ANY THOMSON GROUP ENTITY, AS DEFINED BELOW (COLLECTIVELY "THOMSON ENTITY"), FOR THE RCA OR THOMSON BRANDED PORTABLE DIGITAL AUDIO/VIDEO DEVICE APPLICATION/DRIVER SOFTWARE PROGRAM AND ASSOCIATED DOCUMENTATION, IF ANY (COLLECTIVELY, THE "PROGRAM"). THIS EULA CONTAINS IMPORTANT LEGAL LIMITATIONS, RESTRICTIONS AND DISCLAIMERS, AND ALSO SPECIFIES THE DURATION OF YOUR LICENSE. BY INSTALLING THE PROGRAM OR CLICKING ON THE ACCEPTANCE BUTTON OF THE PROGRAM, COPYING OR OTHERWISE USING THE PROGRAM, YOU ACKNOWLEDGE AND AGREE THAT YOU HAVE READ THIS EULA, UNDERSTAND IT, AND AGREE TO BE BOUND BY ITS TERMS AND CONDITIONS. YOU MAY USE THE PROGRAM ONLY IN ACCORDANCE WITH THIS EULA, AND ANY SUCH USE IS HEREBY UNDERSTOOD TO BE CONDITIONAL UPON YOUR SPECIFIC AGREEMENT TO THE UNMODIFIED TERMS SET FORTH HEREIN. IF YOU DO NOT AGREE WITH ALL OF THE TERMS OF THIS EULA, CLICK ON THE REJECTION BUTTON AND/OR DO NOT INSTALL THE PROGRAM AND/OR DO NOT USE THE PROGRAM.

### 1. LICENSE

(a) Under this EULA, you are granted a license (i) to use the Program on a single workstation, and (ii) to make one (1) copy of the Program into any machine-readable form for backup of the Program, provided the copy contains all of the original Program's proprietary notices.

(b) You may transfer the Program and license to another party only as a part of the Thomson/RCA branded Portable Digital Audio/Video Device ("AV Device"), and only if the other party agrees to accept the terms and conditions of this EULA. If you transfer the Program, you must at the same time either transfer all copies to the same party or destroy any copies not transferred.

(c) The terms of this EULA will govern any software upgrades or updates provided by THOMSON Entity that replace and/or supplement the original Program, unless such upgrade or update is accompanied by separate license terms and conditions in which case the terms of that separate license will govern. You acknowledge and agree that THOMSON Entity may automatically download upgrades or updates to the Program software to your computer in order to update, enhance, and/or further develop the Program.

### 2. LICENSE RESTRICTIONS

(a) Except for the licenses expressly granted to you in this EULA, no other licenses or rights are granted or implied.

(b) You may not (i) make the Program available over a network where it could be used by multiple computers at the same time; (ii) modify, translate, reverse engineer, decompile, disassemble (except to the extent that this restriction is expressly prohibited by law), or create derivative works based upon the Program; or (iii) copy the Program, except as expressly permitted herein. You agree that you shall only use the Program in a manner that complies with all applicable laws in the jurisdictions in which you use the Program, including, but not limited to, applicable restrictions concerning copyright and other intellectual property rights.

(c) The Program may contain pre-release code that does not perform at the level of a final code release. In such case, the Program may not operate properly. Updated versions of the Program may be downloaded from [www.rcaudiovideo.com/digitalaudiosupport](http://www.rcaudiovideo.com/digitalaudiosupport) (if purchased in the United States) and [www.thomsonlink.com](http://www.thomsonlink.com) (if purchased in Europe).

(d) THOMSON Entity is not obligated to provide support services for the Program.

(e) The Program is provided with "RESTRICTED RIGHTS". Use, duplication, or disclosure by the U.S. Government is subject to restrictions as set forth in subparagraph (c)(1)(ii) of DFARS 252.227-7013, or FAR 52.227-19, or in FAR 52.227-14 Alt. III, as applicable.

### 3. TERM AND TERMINATION

(a) Your license is effective on the date you accept this EULA and remains in effect until this EULA is terminated by either party.

(b) You may terminate this EULA and the associated license, without any notice or delay, by destroying or permanently erasing the Program and all copies thereof.

(c) If you fail to comply with any of the terms of this EULA, in whole or part, your license will automatically terminate without notice from THOMSON Entity.

(d) Upon termination of this EULA and your associated license, you shall cease all use of the Program and destroy or permanently erase the Program and all full or partial copies thereof.

### 4. WARRANTY DISCLAIMER

THE PROGRAM IS PROVIDED "AS IS" WITHOUT WARRANTY OF ANY KIND, EITHER EXPRESSED OR IMPLIED, INCLUDING, BUT NOT LIMITED TO THE IMPLIED WARRANTIES OF MERCHANTABILITY, FITNESS FOR A PARTICULAR PURPOSE, TITLE OR NON-INFRINGEMENT. THE ENTIRE RISK AS TO THE QUALITY AND PERFORMANCE OF THE PROGRAM IS WITH YOU. SHOULD THE PROGRAM PROVE DEFECTIVE, YOU (AND NOT THOMSON ENTITY, ITS SUPPLIERS, OR ITS DEALERS) ASSUME THE ENTIRE COST FOR ALL NECESSARY REPAIR OR CORRECTION.

This exclusion of warranty may not be allowed under some applicable laws. As a result, the above exclusion may not apply to you, and you may have other rights depending on the law that applies to you.

### 5. OWNERSHIP RIGHTS

All title and intellectual property rights in and to the Program and any copies thereof are owned by THOMSON Entity or its suppliers. All title and intellectual property rights in and to the content which may be accessed through use of the Program is the property of the respective content owner and may be protected by applicable copyright or other intellectual property laws and treaties. This license grants you no rights to use such content.

### 6. LIMITATION OF LIABILITY

(a) TO THE MAXIMUM EXTENT PERMITTED BY APPLICABLE LAW, IN NO EVENT SHALL THOMSON ENTITY, OR ITS DEALERS BE LIABLE FOR ANY SPECIAL, INCIDENTAL, INDIRECT, OR CONSEQUENTIAL DAMAGES WHATSOEVER (INCLUDING, WITHOUT LIMITATION, DAMAGES FOR LOSS OF PROFITS, BUSINESS INTERRUPTION, CORRUPTION OF FILES, LOSS OF BUSINESS INFORMATION, OR ANY OTHER PECUNIARY LOSS) REGARDLESS OF CAUSE OR FORM OF ACTION, INCLUDING CONTRACT, TORT, OR NEGLIGENCE, ARISING OUT OF YOUR USE OF OR INABILITY TO USE THE PROGRAM, EVEN IF THOMSON ENTITY HAS BEEN ADVISED OF THE POSSIBILITY OF SUCH DAMAGES. BECAUSE SOME STATES AND JURISDICTIONS DO NOT ALLOW THE EXCLUSION OR LIMITATION OF LIABILITY OF CONSEQUENTIAL OR INCIDENTAL DAMAGES, THE ABOVE LIMITATION MAY NOT APPLY TO YOU.

(b) YOU ASSUME RESPONSIBILITY FOR THE SELECTION OF THE APPROPRIATE PROGRAM TO ACHIEVE YOUR INTENDED RESULTS, AND FOR THE INSTALLATION, USE, AND RESULTS OBTAINED.

# End user license agreement

## 7. WINDOWS MEDIA

The software embedded within your A/V Device (the "Device Firmware") contains software licensed from Microsoft that enables you to play Windows Media Audio (WMA) files ("WMA Software"). The WMA Software is licensed to you for use with your A/V Device under the following conditions. By installing and using this version of the Device Firmware, you are agreeing to these conditions. IF YOU DO NOT AGREE TO THE END USER CONDITIONS OF THIS SECTION 7, DO NOT INSTALL OR USE THIS VERSION OF THE DEVICE FIRMWARE.

The WMA Software is protected by copyright and other intellectual property laws. This protection also extends to documentation for the WMA Software, whether in written or electronic form.

**GRANT OF LICENSE.** The WMA Software is only licensed to you as follows:

You may use this version of the Device Firmware containing the WMA Software only as such use relates to your A/V Device.

You may not reverse engineer, decompile, or disassemble the WMA Software, except and only to the extent that such activity is expressly permitted by applicable law.

You may transfer your right to use the Device Firmware only as part of a sale or transfer of your A/V Device, on the condition that the recipient agrees to the conditions set forth herein. If the version of the Device Firmware that you are transferring is an upgrade, you must also transfer all prior versions of the Device Firmware that you have which include the WMA Software.

**MICROSOFT IS NOT PROVIDING ANY WARRANTY OF ANY KIND TO YOU FOR THE WMA SOFTWARE, AND MICROSOFT MAKES NO REPRESENTATION CONCERNING THE OPERABILITY OF THE WMA SOFTWARE.**

The WMA Software is of U.S. origin. Any export of this version of the Device Firmware must comply with all applicable international and national laws, including the U.S. Export Administration Regulations, that apply to the WMA Software incorporated in the Device Firmware.

Content providers are using the digital rights management technology for Windows Media contained in your A/V Device ("WM-DRM") to protect the integrity of their content ("Secure Content") so that their intellectual property, including copyrights, in such content is not misappropriated. Your A/V Device uses WM-DRM software to play Secure Content ("WM-DRM Software"). If the security of the WM-DRM Software in your A/V Device has been compromised, owners of Secure Content ("Secure Content Owners") may request that Microsoft revoke the WM-DRM Software's right to acquire new licenses to copy, display, and/or play Secure Content. Revocation does not alter the WM-DRM Software's ability to play unprotected content. A list of revoked WM-DRM Software is sent to your A/V Device whenever you download a license for Secure Content from the Internet or from a computer. Microsoft may, in conjunction with such license, also download revocation lists onto your A/V Device on behalf of Secure Content Owners.

## 8. THIRD PARTY SOFTWARE

ANY THIRD PARTY SOFTWARE THAT MAY BE PROVIDED WITH THE PROGRAM IS INCLUDED FOR USE AT YOUR OPTION. IF YOU CHOOSE TO USE SUCH THIRD PARTY SOFTWARE, THEN SUCH USE SHALL BE GOVERNED BY SUCH THIRD PARTY'S LICENSE AGREEMENT, AN ELECTRONIC COPY OF WHICH WILL BE INSTALLED IN THE APPROPRIATE FOLDER ON YOUR COMPUTER UPON INSTALLATION OF THE SOFTWARE. THOMSON ENTITY IS NOT RESPONSIBLE FOR ANY THIRD PARTY'S SOFTWARE AND SHALL HAVE NO LIABILITY FOR YOUR USE OF THIRD PARTY SOFTWARE.

## 9. GOVERNING LAW

If you acquired this A/V Device in the United States, this EULA shall be governed and construed in accordance with the laws of the State of Indiana, U.S.A. without regard to its conflict of laws principles. If you acquired this A/V Device within the European Union, this EULA shall be governed and construed in accordance with the laws of France, without regard to its conflict of laws principles. If you acquired this A/V Device outside the United States or the European Union, then local law may apply.

## 10. GENERAL TERMS

This EULA can only be modified by a written agreement signed by you and THOMSON Entity, and changes from the terms and conditions of this EULA made in any other manner will be of no effect. If any portion of this EULA shall be held invalid, illegal, or unenforceable, the validity, legality, and enforceability of the remainder of the Agreement shall not in any way be affected or impaired thereby. This EULA is the complete and exclusive statement of the agreement between you and THOMSON Entity, which supersedes all proposals or prior agreements, oral or written, and all other communications between you and THOMSON Entity, relating to the subject matter of this hereof. "THOMSON Group Entity" when used in this EULA shall mean any person, corporation, or other organization, domestic or foreign, including but not limited to subsidiaries, that is directly or indirectly controlled by Thomson, French company. For purposes of this definition only, the term "control" means the possession of the power to direct or cause the direction of the management and policies of an entity, whether by ownership of voting stock or partnership interest, by contract, or otherwise, including direct or indirect ownership of more than fifty percent (50%) of the voting interest in the entity in question.

# Before you begin

Dear RCA Customer,

Thank you for purchasing the RCA Player. This player will play open mp3 and Windows Media™ audio (WMA) content as well as content purchased from most online music download services.

After purchasing and downloading music to your PC, you are now ready to move content to your player. To transfer the music, you must use Windows Media Player or the application recommended by the online music download service.

(Note: Services and applications must be Windows Media audio-compliant and support Digital Rights Management.)

## Unpacking your player

When you unpack your new player, be sure you have removed all the accessories and documentation. The items below should have been packed in the box with your player.

- RCA player
- Quick start guide
- Music Management CD
- USB connection cable
- Earphones
- Wristband
- Armband

Explore a world of accessories! Jump on the Internet and go to [www.rcaaudiovideo.com](http://www.rcaaudiovideo.com) to discover the additional accessories that are available for your player.

Illustrations contained within this publication are for representation only and subject to change.

## Computer system requirements

- Pentium III 500MHz or higher recommended
- Windows 2000 (service pack 3) or XP (service pack 1 or higher)
- Internet Explorer 6.0 or higher
- Internet access
- 250MB or more free hard disk space for the software
- 128MB RAM (256MB recommended)
- CD drive capable of digital audio extraction
- USB port (2.0 recommended)
- Sound card
- 16-bit color video card

## Warning

Use of this product is for your personal use only. Unauthorized recording or duplication of copyrighted material may infringe upon the rights of third parties and may be contrary to copyright laws.

## Back up your data

As with any portable device that has a hard drive, you must back up the drive regularly. RCA and Thomson are not responsible for lost data.



# Before you begin

## Precautions for the player

- Do not use the unit immediately after transportation from a cold place to a warm place; condensation problem may result.
- Avoid shock to the unit.
- Do not store the unit near fire, places with high temperature or in direct sunlight.
- Do not operate or store unit in places with frequent static electricity or electrical noise (e.g. speaker, TV set).
- Clean the unit with a soft cloth or a damp chamois leather. Never use solvents.
- The unit must only be opened by qualified personnel.
- Keep product out of direct sunlight. Exposure to direct sunlight or extreme heat (such as inside a parked car) may cause damage or malfunction.

## Caution while driving

- Use of headphones while operating an automobile or moving vehicle is not recommended and is unlawful in some states and areas. Be careful and attentive on the road. Stop operation of the unit if you find it disruptive or distracting while driving.

## Headset safety

- Have a Blast – Just Not in Your Eardrums
- Make sure you turn down the volume on the unit before you put on headphones. Increase the volume to the desired level only after headphones are in place.
- Do not play your headset at a high volume. Hearing experts warn against extended high-volume play.
- If you experience a ringing in your ears, reduce volume or discontinue use.
- You should use extreme caution or temporarily discontinue use in potentially hazardous situations. Even if your headset is an open-air type designed to let you hear outside sounds, don't turn up the volume so high that you are unable to hear what is around you.



## Using clip earphones

The right ear clip phone is labeled R while the left ear clip phone is labeled L.

1. Slide the ear hook behind the ear with the ear pad on the front of the ear.
2. For best sound quality, make sure the ear pad fits closely with your ear.



## Using armband/wristband

Slide the small ends of the armband or wristband through the player's rings and secure with the buttons as shown below. Adjust the length of the armband if necessary. The length of the wristband is not adjustable.

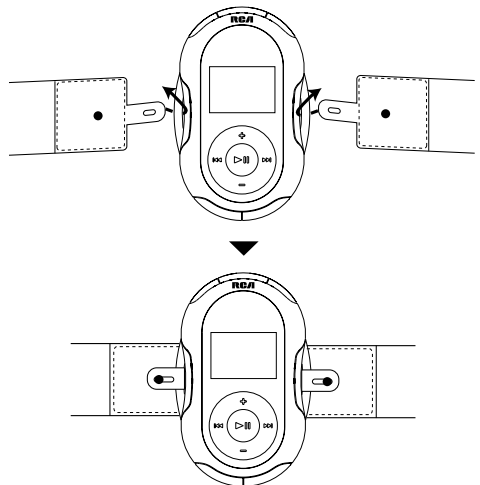

# Software setup

The Music Management CD that comes with your player contains all of the necessary software components you need to make your player work properly.

These components enable you to transfer files from your computer to the player.

Inserting the included CD into CD Drive

1. Turn on your computer and place the Music Management CD that came with your player into your computer.  
**IMPORTANT:** Do not connect the USB cable to the PC or the player before or during the CD installation.
2. If the setup screen does not appear, double-click "My Computer", double click your CD drive icon, and double click "Install" to run the installer.



The Music Management CD also contains a software package Yahoo! Music Jukebox that can help transfer music content to your player. Please refer to the section on your installed software for detailed operations.

Yahoo! Music Jukebox is supported in Windows XP or higher.

# Computer connection

## Connecting the player to the computer

Connect the player to your computer with the mini USB cable provided. The player will turn on automatically. It will appear as a Windows portable device (Windows XP, with Windows Media Player 10 installed) using the Media Transfer Protocol (MTP) or a drive letter if you are using Windows 2000.

It might take several seconds for the player to be detected. Click "Refresh" in My Computer or Explorer to make sure the player has been detected.

The player is capable of transferring files at USB 2.0. If USB 2.0 port is available on your computer, use it to connect to your player. The player is still backward compatible with the older USB 1.1 ports. However, you will not be able to take full advantage of the potential speed increase.

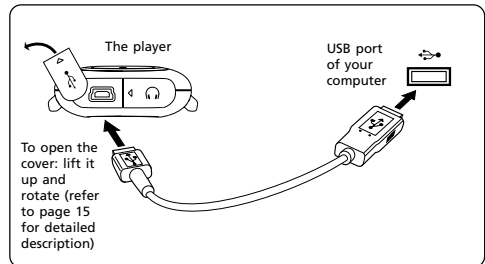

# Computer connection

## Charging the battery

Your player will charge through the USB connection when it is connected to your computer. The display below shows where the animated battery icon is displayed when charging. To fully charge the player, make sure your computer is on and the device is connected for at least 3 hours.



- You can still transfer files to the player while in battery charging mode.
- When the battery is full, the display shows "Battery full".

## Important battery information

- Charge the player for at least 3 hours before first use.
- Charge the player for at least 2 hours after putting the player away for a long time.
- **Battery replacement should only be made by trained technicians. Refer to Limited Warranty for details.**
- Do not attempt to open the player. No user serviceable parts inside.
- To reduce risk of injury, charge only rechargeable batteries recommended by the manufacturer for this player. Other types of batteries may burst causing damage and personal injury.

## Caution

- Do not separately recharge, disassemble, or incinerate or expose to high temperatures over 45°C (113°F). Examples of high temperatures that may damage your product include leaving it in a locked car in the summer, the dashboard of a car or putting it on top of other heat generating electronics devices (such as power amplifiers and computer monitors).
- Dispose of used battery properly. Keep away from children. Do not disassemble and do not dispose of in fire.



### Caution

- **Risk of explosion if battery is replaced by an incorrect type.**
- **Dispose of used batteries according to the instructions.**

# Transferring files to the player



You may select one of the following methods to transfer music contents to your player: 1)

Yahoo! Music Jukebox, 2) drag-and-drop via Windows Explorer. For method 1, you first need to have successfully installed the software packages included in the Music Management CD.

Transferring files via Yahoo! Music Jukebox - refer to page 12.

Transferring files via Windows Explorer (drag-and-drop) - refer to page 13.

Yahoo! Music Jukebox is supported only by Windows XP or higher operating system.

Secure music download files must be transferred to your player through the Yahoo Music Jukebox or the application recommended by your online music download service (Note: Services and applications must be Windows Media audio-compliant and support Digital Rights Management.) (Apple iTunes™ music content is not supported).

## Transferring files via Yahoo! Music Jukebox (Windows XP or higher only)

Yahoo! Music Jukebox lets you manage your music easily and organize like a pro. Create your own playlists: music for work, the gym, or even dinner. You can also buy download music and transfer to your player in seconds. Just drag and drop and you're done. For more information on the installation and operations, please visit: <http://music.yahoo.com>

Do not disconnect the USB cable during music download. Doing so may corrupt system files or the files being downloaded.

3. In the Yahoo! Music Jukebox, click *My Music* or click on a playlist on the left navigation pane.
  4. Simply drag the playlist you want to the name of your player in the left navigation pane (you can also drag tracks, artists and albums directly from My Music).
  5. The Yahoo! Music Jukebox will check to see if there is sufficient storage space on the player to copy the songs. If not, you will have to reduce the number of songs you are transferring.
- Yahoo! Music Jukebox is supported only in Windows XP or higher operating system and Internet Explorer 6 or above for installation.
  - Required updates to Yahoo! Music Jukebox may be available from Yahoo! after installation. Please refer to the Yahoo! Music Jukebox Help for more information about these updates.

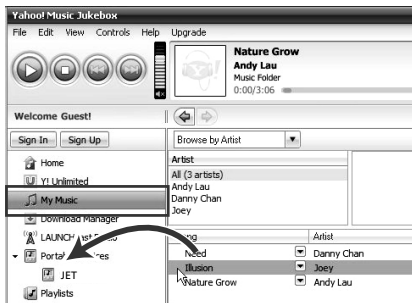

1. Launch the *Yahoo! Music Jukebox*.
2. Attach the player to your computer. The player's name should appear after a few seconds in the left navigation pane.

# Transferring files to the player

## Transferring files via Windows Explorer (Drag-and-drop) (Windows XP only)

In Windows Explorer, when the RCA player is opened in MTP mode, and Windows Media Player 10 is installed, the "Data" and "Media" views will be displayed for the player. The Data folder is used to manage data content on the player, such as text files. The Media folder is used to manage media content supported by the player for playback, such as mp3 and wma.

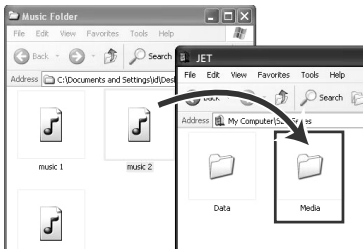

If your computer has installed Windows Media Player 11, "Internal Storage" shows instead of the folders mentioned above. Copy files inside "Internal Storage".

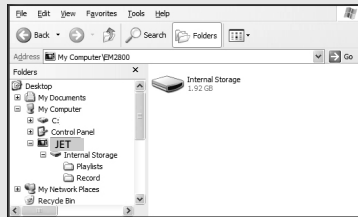

Secure music download files must be transferred to your player through one of the provided Jukebox software packages or any applications recommended by the online music download service. Please visit the online music download service's website where you purchased your content from for more details on transferring secure music to your player.

You can copy files to / delete files from the player through Windows Explorer, but you cannot open or edit the files directly from the player. If you want to edit the files, you will need to copy the files from the player to another location (drive) in the system.

## Transferring files via Windows Explorer (Drag-and-drop) (Windows 2000)

From Windows Explorer, highlight all the files/folders you want to transfer to your player and drag them to the drive letter that is associated with it.

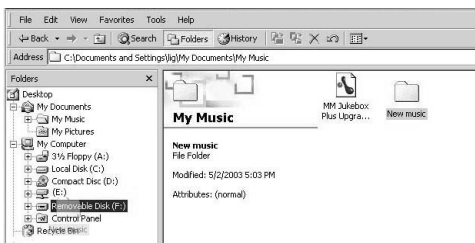

# Transferring files to the player

## Disconnecting your player from the computer

For Windows XP users, your player is connected in MTP (Media Transfer Protocol) mode to your computer by default, you may disconnect the USB cable directly when file download is completed. Do not disconnect the USB connection during file download. Doing so may corrupt system files or the files being downloaded.

If you are using Windows 2000, you can disconnect the player by left clicking on the  icon from the system tray and selecting the drive corresponding to your player. Before disconnecting the USB connection from the computer or the player, be sure the "Safe to Remove Hardware" message is displayed.



# General controls

## Overview

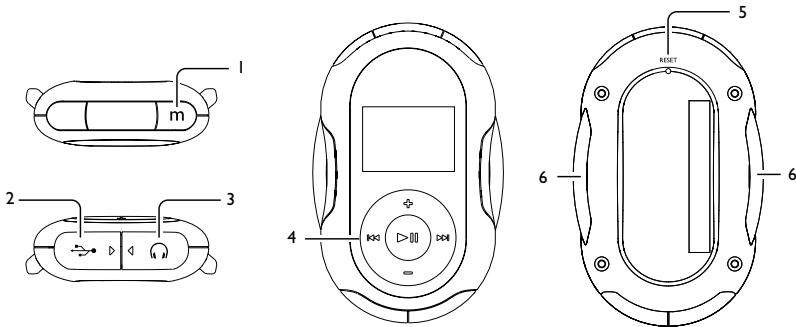

### 1. **m**

- To access the file or player menu.
- Press and hold to lock or unlock the player's keys.
- To stop the radio recording.

2.  USB jack - Attach the small end (Type mini-B) of the mini-USB cable here. Attach the large end (Type A) to your computer's USB port. The player will enter USB mode automatically, and you can transfer files to and from the computer. The player's battery will also be charging when connected to the computer.

3.  Earphone jack



Follow the diagram to open the USB jack or earphone jack cover.

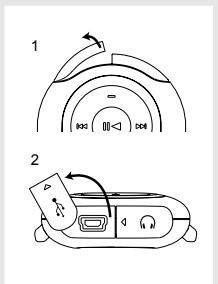

### 4. **▶||**

- Press once to turn on the player. Press and hold to turn off the player.
- To start and pause playback.
- To start and stop the stopwatch.
- To make selections in menus.



- To skip to a previous file or scan a file backwards.
- To go back a level in the menus.



- To skip to the next file or scan a file forwards.
- To advance or make selections in menus.



- To increase the volume during playback.
- To scroll up in the menus.



- To decrease the volume during playback.
- To scroll down in the menus.

5. Reset button

6. Armband/Wristband rings

## Turning on or off the player

- Press **▶||** to turn on the player.
- Press and hold **▶||** to turn off the player.

## Locking the keys

Press and hold **m** to lock (or unlock) keys to prevent accidental key activation. To unlock the keys after the player has turned off automatically, press **▶||** and then press and hold **m** while the message "Press and hold m to unlock" is displayed.

# File menu

## How files are organized?

Files transferred to the player are sorted automatically according to their file types. Music files are further sorted according to several parameters for quickly searching your favorite music. Once your player is switched on, you will see the file menu as below:



### File menu

Now Playing	
Music	Artists
Audiobooks	Albums
Radio Recs	Titles
My Selections	Genres
	Years

- Now Playing (only available when the playback is in progress or paused. Select it to show the currently playing file)
- Music (contains music files which are further sorted)
- Audiobooks (contains audible files)
- Radio Recs (contains radio recording)
- My Selections (contains a playlist of your preferred music files)

The file menu is displayed when **m** is pressed during playback.

## File menu navigation

- Press **▶▶** to go to the next menu level.
- Press **+** or **-** to move along menu items at the same level.
- Press **◀◀** to go to the previous menu level.
- If the selected item is a music, audible or recorded file, press **▶▶** or **▶▶** to start playback.

The following example illustrates the steps to select and play a music file in the "Artists" category.

1. Highlight "Music" by pressing **+** or **-**, then press **▶▶** to advance.

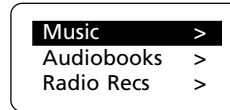

2. Highlight "Artists" by pressing **+** or **-**, then press **▶▶** to advance.

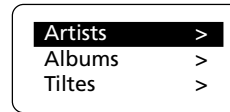

3. The artist menu appears with the artists listed in alphabetical order. Highlight a desired artist by pressing **+** or **-**, then press **▶▶** to advance.

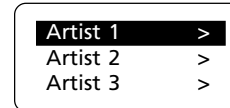



# File menu

- The albums of the selected artist appear.  
Highlight a desired album by pressing + or -, then press ► to advance.



- The songs of the selected album appear.  
Highlight a desired song by pressing + or -, then press ► or ►► to start playback.

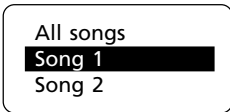

- The song's information will show on the display during playback. The information available depends upon the ID3 tags that have been set up for the song.

# Player menu

The player menu lets you access more features of the player.

Depending on the mode you are in (e.g. music playback, radio recording etc.), the items available in the player menu may vary.

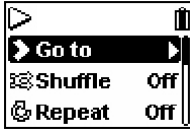

**Player menu**

Follow the steps below to access the player menu:

- If you are at the file menu navigation screen, press **m** once to access the player menu.



**File menu**

- If you are at the playback screen, press **m** twice to access the player menu.



**Playback screen**

- If you are in the radio mode, press **m** once to access the player menu.

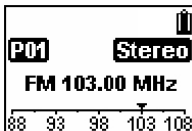

**Radio mode**

## Player menu navigation

- Press **▶▶** to go to the next menu level.
- Press **+** or **-** to move along menu items at the same level.
- Press **◀◀** to go to the previous menu level.
- Press **▶▶** or **▶▶▶** repeatedly to select options.

More menu items available, press **▶▶** to advance

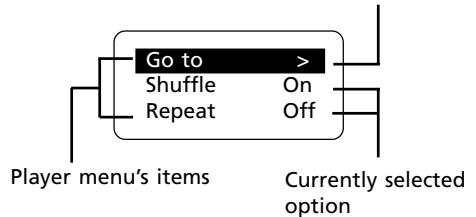

In general, the player menu consists of the following items. Some items may not be available or extra items may appear in specific modes such as radio and audible playback. Refer to the relevant sections in the user manual for details.

### Player menu

Go to	Library / Radio
Shuffle	Stopwatch
Repeat	BMI
DSP	
Clear MySel	
Settings	Brightness
System Info	Screensaver
	Powersave
	FreqStep
	Language
	Unit
	Personal Info
	Flip Display
	Restore Defaults

# Player menu

## Go to



- Press ►| or ►► to switch among the library (to access the file menu), radio, stopwatch and BMI modes.

## Shuffle

- Press ►| or ►► repeatedly to select shuffle on or off. Files will be played randomly when shuffle mode is activated. Shuffle mode is not available when you are listening to an audible file.

## Repeat

- Press ►| or ►► repeatedly to select a repeat mode. Repeat mode is not available when you are listening to an audible file.

One  - repeat the current item,  
All  - repeat all items,  
Off - repeat mode is off.



Repeat and shuffle modes will work differently if you have highlighted a song or a set (albums, genres etc.). You can select your desired combination of shuffle and repeat mode to suit you.

## DSP (Digital Signal Processor)

- Press ►| or ►► repeatedly to select a DSP mode. Options available: Flat, Rock, Jazz, Bass and Pop. DSP is not available when you are listening to an audible file.

## Clear MySel (Clear My Selections)

- To clear the playlists. Refer to page 21 for details.

## Settings

- Press ►| or ►► to enter the settings menu and then press + or - to highlight an item. Refer to the player for options available within each item. Press ►| or ►► repeatedly to select options.

**Brightness:** to adjust the display light brightness.

**Screensaver:** to adjust the duration before the screensaver activates.

**Powersave:** to adjust the duration for automatic shut down when the player is in idle.

**FreqStep (Frequency Step):** to select between the US and Europe frequency mode.

**Language:** to select the menu's language.

**Unit:** to select between the English and metric unit system in weight and height for BMI calculation. Refer to page 27 for details.

**Personal Info:** to input sex, weight and height for BMI calculation. Refer to page 27 for details.

**Flip Display:** to rotate the display by 180°

**Restore Defaults:** to restore all menus to factory defaults.

## System Info

- Press ►| or ►► to show the amount of free space available and the firmware version.

# Music playback

## Music playback controls

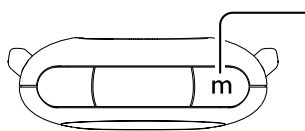

Press to go to the file or player menu (refer to page 16-19). Press and hold to lock or unlock the keys.

Press once to skip to the previous file\*, or press and hold to fast reverse.

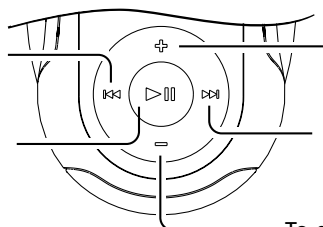

To increase the volume

Press once to skip to the next file, or press and hold to fast forward.

To decrease the volume

Press once to start the playback. Press during playback to pause and again to resume.

\* Press **⏮** within the beginning 4 seconds of the current file to skip to the previous file. Otherwise, you will return to the beginning of the current file.

## Music playback display

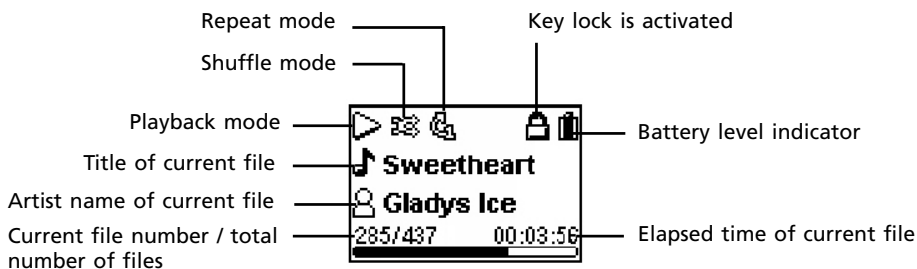

The information provided in the playback screen depends upon the metadata fields that have been set up for the song.

# Music playback

## My Selections

My Selections is a playlist of your preferred music files (audible and radio recorded files are not selectable).

To select a music file as My Selections:

1. While listening to a favorite music file, press **m** twice. The player menu is shown.
2. Highlight "Add to MySel" by pressing **+** or **-** and then press **▶|** or **▶▶** to confirm. "Added to MySel" shows on the display briefly.



To listen to My Selections:

1. Press **+** or **-** to highlight "My Selections" folder from the file menu.



2. Press **▶▶** to begin playback.

To clear My Selections:

1. Press **m** once or twice to access to player menu (refer to "Player menu" on page 18 for details).
2. Press **+** or **-** to highlight "Clear MySel" and then press **▶|** or **▶▶** to confirm clearing.

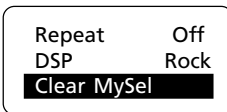

## Other playback features

You may play your music files randomly and / or repeatedly as well as select the DSP effect to best suit your music. To do so, you need to access the player menu during music playback. Refer to page 18-19 for details.

# Audible playback

## Audible playback controls

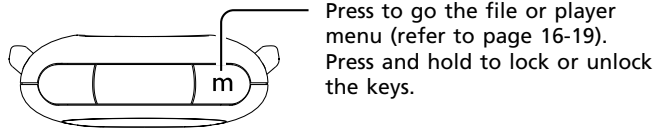

Press once to skip to the previous file\*, or press and hold to fast reverse.

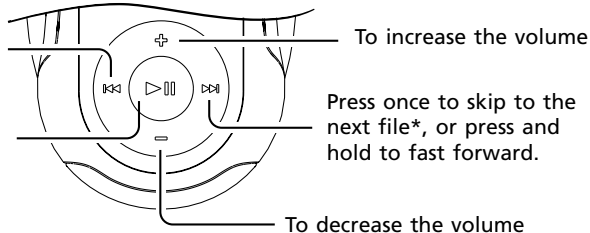

Press once to start the playback. Press during playback to pause and again to resume.

\* For sectioned audible files only: during playback or pause of a sectioned audible file, press **m** twice to access the player menu. Highlight "Skipping" by pressing **+** or **-**. Press **▶** or **▶▶** to select between "File" or "Section".

If "Section" is selected, skipping will be by section only when **◀◀** or **▶▶** is pressed. Press **◀◀** within the beginning 4 seconds of the current section to skip to the previous section. Otherwise, it will return to the beginning of the current section.

The section mode will automatically switch back to the file mode every time a new audible file is skipped to or played or when the player is turned off.

## Audible playback display

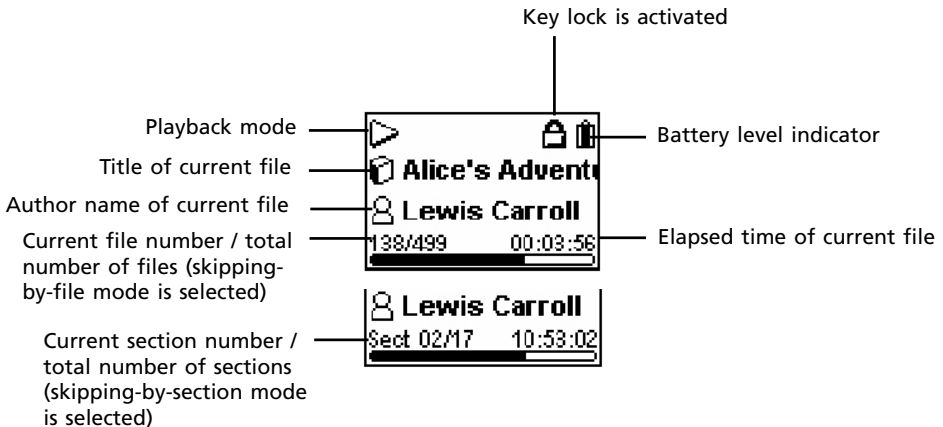

# Radio

## Radio (switching on)

1. Press **m** in any mode to access the player menu (during music playback, **m** has to be pressed twice).
2. While "Go to" is highlighted, press **▶|** or **▶▶**.

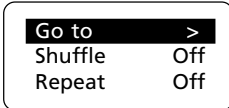

3. While "Radio" is highlighted, press **▶|** or **▶▶** to switch on the radio.

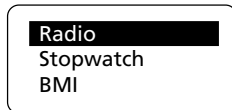

## Radio (switching off)

1. Press **m** in the radio mode to access the player menu.
2. While "Go to" is highlighted, press **▶|** or **▶▶**.

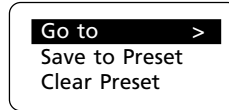

3. Select one of the modes to switch to and then press **▶|** or **▶▶**.

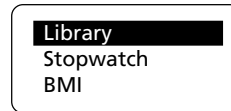

- Alternatively, press and hold **▶|** until the player powers off to switch off the radio.

## Radio display

Preset mode with preset station number (in manual mode, this icon is off)

Current frequency

Frequency scale

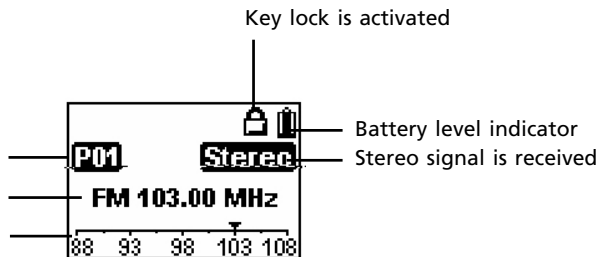

## Manual and preset modes

Press **▶|** to select between the two modes while listening to the radio. In manual mode, press **◀◀** or **▶▶** to select frequency manually. In preset mode (refer to the display above), press **◀◀** or **▶▶** to select stations saved in preset memory.

## Selecting radio frequency

In manual mode, press **◀◀** or **▶▶** to select frequency. Press and hold the button to start automatically search for the next available channel.

# Radio

## Saving preset stations

You can save up to 20 channels as preset stations.

1. Select a radio frequency. Refer to "Selecting radio frequency" on the previous page.
2. Press **m** to access the player menu and then press **+** or **-** to highlight "Save to Preset".

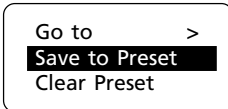

3. Press **▶|** or **▶▶** to advance.
4. The next available preset station number shows, press **◀◀** or **◀|** to select another number if so desired.
5. Press **▶|** to save the selected frequency as the assigned preset station number.

## Selecting preset stations

In preset mode, press **◀◀** or **▶▶** to select a preset station.

## Clearing preset stations

1. In preset mode, press **◀◀** or **▶▶** to select an unwanted preset station.
2. Press **m** to access the player menu and then press **+** or **-** to highlight "Clear Preset".

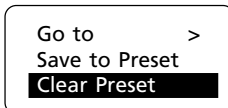

3. Press **▶|** or **▶▶** to delete the unwanted preset station.

## Suppressing stereo signal

If FM stereo signal is weak, selecting mono sound may reduce the noise.

1. While listening to the radio, press **m** to access the player menu and then press **+** or **-** to highlight "Mode".

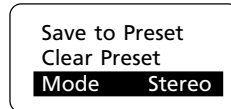

2. Press **▶|** or **▶▶** to select between "Mono" or "Stereo" sound.
3. Press **m** to exit the player menu.



# Radio recording

## Start recording

Radio program can be recorded as .wav format.

1. While listening to the radio, press **m** to access the player menu and then press **+** or **-** to highlight "Start Recording".



Clear Preset  
Mode  
**Start Recording**

2. Press **▶▶** to start recording.
3. Press **▶▶** to pause recording, press again to resume.
4. Press **m** to stop recording.

## Record duration

You may select the maximum record duration.

1. While listening to the radio, press **m** to access the player menu and then press **+** or **-** to highlight "RecDur".
2. Press **▶▶** or **▶▶▶** to select among 5m, 30m, 1h and max (5 min, 30 min, 1 hour and maximum).
3. Press **m** to exit the player menu.

## Listening to radio recording

1. In the file menu, press **+** or **-** to highlight "Radio Recs" and then press **▶▶** to show the archive of radio recordings.



Music >  
Audiobooks >  
**Radio Recs >**

2. Press **+** or **-** to highlight one of the recorded files and then press **▶▶** or **▶▶▶** to listen to the selected file.

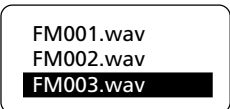

FM001.wav  
FM002.wav  
**FM003.wav**

## Deleting radio recording

1. In the file menu, press **+** or **-** to highlight "Radio Recs" and then press **▶▶** to show the archive of radio recordings.



Music >  
Audiobooks >  
**Radio Recs >**

2. Press **+** or **-** to highlight an unwanted recorded file.
3. Press **m** to access the player menu. Press **+** or **-** to highlight "Delete File".

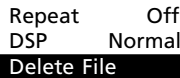

Repeat Off  
DSP Normal  
**Delete File**

4. Press **▶▶** or **▶▶▶** to delete the unwanted file.

# Stopwatch

## Using stopwatch

1. To access the stopwatch, press **m** once or twice to access the player menu (refer to page 18 for details).
2. While "Go to" is highlighted in the menu, press **▶||** or **▶▶** to advance.

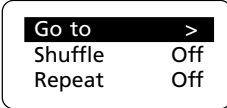

3. Press **+** or **-** to highlight "Stopwatch" and then press **▶||** or **▶▶**.



4. Press **▶||** to start the stopwatch. Press again to stop the stopwatch.



5. While the stopwatch is stopped, press **-** to reset the stopwatch.

## Multiple lap timing

1. In stopwatch mode, press **▶||** to start timing of the first lap.
2. Press **+** at the start of the second, third lap and so on (maximum 30 laps).
  - The unit will display the lap difference briefly after the second lap is finished and then the average time on the display.

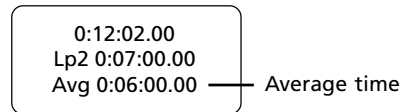
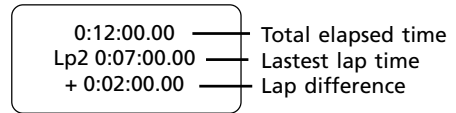

3. Press **▶||** to stop the stopwatch when all laps are finished.
4. Press **◀◀** or **▶▶** to review all the lap times.
5. Press **-** to clear all lap times and reset the stopwatch.

# BMI (Body Mass Index)

BMI is a measure which takes into account a person's weight and height to estimate total body fat in adults. It may vary depending on your body type and composition. BMI is calculated by the following formula:

$$\text{BMI} = \frac{\text{Body weight (kg)}}{[\text{Body height (m)}]^2}$$
$$= 703 \times \frac{\text{Body weight (lb)}}{[\text{Body height (inch)}]^2}$$

You should have entered your personal information before checking this index (refer to Personal Information).

## Personal information

For accurate use of BMI, you should have entered your personal information first.

1. Press **m** once or twice to access the player menu (refer to page 18 for details).
2. Press **+** or **-** to highlight "Settings" and press **▶|** or **▶▶** to enter its sub-menu.
3. Press **+** or **-** to highlight "Personal Info" and press **▶|** or **▶▶** to enter its sub-menu.
4. Press **+** or **-** to highlight among Sex, Weight and Height. Press **▶|** or **▶▶** to select one of them and then press **+** or **-** to adjust values.
5. Press **▶|** to confirm when finished.

## Changing unit

You may change between the English and metric unit system when inputting your personal information.

1. Press **m** once or twice to access the player menu (refer to page 18 for details).
2. Press **+** or **-** to highlight "Settings" and press **▶|** or **▶▶** to enter its sub-menu.
3. Press **+** or **-** to highlight "Unit".
4. Press **▶|** or **▶▶** to select between the English and metric unit system.

## Checking BMI

1. Press **m** once or twice to access the player menu (refer to page 18 for details).
2. While "Go to" is highlighted in the menu, press **▶|** or **▶▶** to advance.

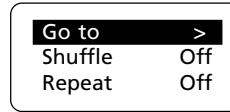

3. Press **+** or **-** to highlight "BMI" and then press **▶|** or **▶▶** to check your BMI.

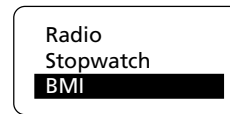

Different BMI ranges correspond to different health condition.

Health Condition	Males	Females
Underweight	Less than 20 (<20)	Less than 18 (<18)
Ideal	greater than or equal to 20 but less than 25 (>=20 but <25)	greater than or equal to 18 but less than 23 (>=18 but <23)
Overweight	greater than or equal to 25 but less than 30 (>=25 but <30)	greater than or equal to 23 but less than 30 (>=23 but <30)
Obese	greater than or equal to 30 (>=30)	greater than or equal to 30 (>=30)



BMI is a general indicator of your health. The information above is a rough estimation only. To have a full understanding of your health condition, consult with your doctor.

# More information

## Troubleshooting Tips

The player does not turn on when the PLAY button is pressed?

- Battery may be empty.

Skipping tracks or bad sound quality?

- Repeat, random or program function may be activated.
- There may be strong magnetic fields (e.g. too close to TV) near the player.
- Low Battery level.

Cannot perform playback?

- LOCK function may be activated.
- There may be no mp3/WMA tracks in the internal memory.

USB display does not appear when connected to computer?

- Check connection between your player and the computer.

Cannot playback tracks on the player.

- Make sure audio tracks are encoded in the mp3 or Windows Media formats at supported bitrates. Bitrates supported by the player:  
mp3 – 32 to 320 kbps  
wma – 48 to 192 kbps
- WMA files may be DRM protected and you do not have the proper rights (license) to play the files.
- Check the website and/or application help system of the music download service provider from where the content was purchased for license acquisition details. For more information on how license acquisition works, go to [www.microsoft.com/windowsmedia/drm](http://www.microsoft.com/windowsmedia/drm).
- Play the original or downloaded song on your computer to ensure that there was nothing wrong with the encoding of the mp3 or WMA.
- The player's clock is inaccurate. This may cause DRM files to work incorrectly. To fix the problems, connect the player to the computer using the USB cable. Then connect to the secure service where DRM encoded files came from. The clock should reset and DRM files should now work properly.

The player does not work after reformat.

- In case you need to reformat the player, it must be in FAT or FAT32 format. The player does not work in NTFS format.

The player cannot be recognized by Audible Manager

- Your previously installed Audible Manager may not work with this player. You have to reinstall Audible Manager completely by following the instruction from your CD which comes with the player.

Why can't my portable player playback songs downloaded from my paid Music Service Provider subscription service?

- The internal clock in your portable player may not be up to date. Downloading a new subscription song from your Music Service Provider should update your player's clock and allow it to playback all your songs again.
- The license for your subscription songs may have expired. Synchronize your device with your PC again to obtain an update to your license. If the problem persists, please contact your Music Service Provider for additional support.

Cannot access the player via Windows 2000.

- Install the Service Pack 3 for Windows 2000. Visit [www.windowsupdate.microsoft.com](http://www.windowsupdate.microsoft.com) for details.

# More information

## Check for updates

Visit <http://www.rcaudiovideo.com/digitalaudiosupport> for the latest news and firmware upgrades for your player. You must update your system after new downloads have been made in order for the new applications to be executed.

## Frequently asked questions

You can get FAQ information at <http://www.rcaudiovideo.com/faq>



This player may temporarily cease to function if subjected to electrostatic disturbance. To resume normal operation, it may be necessary to cycle the power off and back on or reset the player by pressing the RESET button on the back of the player with a non-metal pointed object (e.g. toothpick).

# Limited Warranty

## For U.S.

What your warranty covers:

- Defects in materials or workmanship.

For how long after your purchase:

- One year from date of purchase.  
The warranty period for rental units begins with the first rental or 45 days from date of shipment to the rental firm, whichever comes first.

What we will do:

- Provide you with a new, or at our option, a refurbished unit. The exchange unit is under warranty for the remainder of the original product's warranty period.
- Proof of purchase in the form of a bill of sale or receipted invoice which is evidence that the product is within the warranty period must be presented to obtain warranty service. For rental firms, proof of first rental is also required.

How to make a warranty claim:

- Properly pack your unit. Include any cables, etc., which were originally provided with the product. We recommend using the original carton and packing materials.
- Include evidence of purchase date such as the bill of sale. Also print your name and address and a description of the defect. Send via standard UPS or its equivalent to:

Thomson Inc.  
Product Exchange Center  
11721 B Alameda Avenue  
Socorro, Texas 79927

- Insure your shipment for loss or damage. Thomson accepts no liability in case of damage or loss en route to Thomson.
- Pay any charges billed to you by the Exchange Center for service not covered by the warranty.
- A new or refurbished unit will be shipped to you freight prepaid.

What your warranty does not cover:

- Customer instruction. (Your Owner's Manual provides information regarding operating Instructions and user controls. For additional information, ask your dealer.)
- Installation and set-up service adjustments.
- Batteries.
- Damage from misuse or neglect.
- Products which have been modified or incorporated into other products.

- Products purchased or serviced outside the USA.
- Acts of nature, such as but not limited to lightning damage.

Product Registration:

- Please complete and mail the Product registration Card packed with your unit. It will make it easier to contact you should it ever be necessary. The return of the card is not required for warranty coverage.

Limitation of Warranty:

- THE WARRANTY STATED ABOVE IS THE ONLY WARRANTY APPLICABLE TO THIS PRODUCT. ALL OTHER WARRANTIES, EXPRESS OR IMPLIED (INCLUDING ALL IMPLIED WARRANTIES OF MERCHANTABILITY OR FITNESS FOR A PARTICULAR PURPOSE) ARE HEREBY DISCLAIMED. NO VERBAL OR WRITTEN INFORMATION GIVEN BY THOMSON INC., ITS AGENTS OR EMPLOYEES SHALL CREATE A WARRANTY OR IN ANY WAY INCREASE THE SCOPE OF THIS WARRANTY.
- REPAIR OR REPLACEMENT AS PROVIDED UNDER THIS WARRANTY IS THE EXCLUSIVE REMEDY OF THE CONSUMER. THOMSON INC. SHALL NOT BE LIABLE FOR INCIDENTAL OR CONSEQUENTIAL DAMAGES RESULTING FROM THE USE OF THIS PRODUCT OR ARISING OUT OF ANY BREACH OF ANY EXPRESS OR IMPLIED WARRANTY ON THIS PRODUCT. THIS DISCLAIMER OF WARRANTIES AND LIMITED WARRANTY ARE GOVERNED BY THE LAWS OF THE STATE OF INDIANA. EXCEPT TO THE EXTENT PROHIBITED BY APPLICABLE LAW, ANY IMPLIED WARRANTY OF MERCHANTABILITY OR FITNESS FOR A PARTICULAR PURPOSE ON THIS PRODUCT IS LIMITED TO THE APPLICABLE WARRANTY PERIOD SET FORTH ABOVE.

How state law relates to this warranty:

- Some states do not allow the exclusion nor limitation of incidental or consequential damages, or limitations on how long an implied warranty lasts, so the above limitations or exclusions may not apply to you.
- This warranty gives you specific legal rights, and you also may have other rights that vary from state to state.

If you purchased your product outside the USA:

- This warranty does not apply. Contact your dealer for warranty information.

# Limited Warranty

## For Canada

Thomson multimedia Ltd. warrants to the purchaser or gift recipient that if any manufacturing defect becomes apparent in this product within 1 year from the original date of purchase, it will be replaced free of charge, including return transportation.

This warranty does not include damage to the product resulting from accidents, misuse or leaking batteries.

Should your product not perform properly during the warranty period, either:

1. Return it to the selling dealer with proof of purchase for replacement,

OR

2. Remove the batteries (where applicable), and pack product complete with accessories in the original carton (or equivalent).

Mail prepaid (with proof of purchase) and insured to:

Thomson multimedia Ltd.  
6200 Edwards Blvd.,  
Mississauga, Ontario L5T 2V7  
Canada

The provisions of this written warranty are in addition to and not a modification of or subtraction from the statutory warranties and other rights and remedies contained in any applicable legislation, and to the extent that any such provisions purport to disclaim, exclude or limit any such statutory warranties and other rights and remedies, such provisions shall be deemed to be amended to the extent necessary to comply therewith.

If you are unable to find a qualified servicer for out of warranty service, you may write to:

Thomson Inc.  
P.O. Box 0944  
Indianapolis, Indiana, U.S.A., 46206-0944

Attach your sales receipt to this booklet for future reference. This information is required if service is needed during the warranty period.

PURCHASE DATE

NAME OF STORE

**IMPORTADOR**

Comercializadora Thomson de México, S.A. de C.V.

Álvaro Obregón No. 151. Piso 13.

Col. Roma. Delegación Cuauhtémoc

C.P. 06700. México, D.F.

Telefono: 52-55-11-020360

RFC: CTM-980723-KS5

Thomson Inc.

P.O. Box 1976

Indianapolis, IN 46206-1976

© 2007 Thomson Inc.

Trademark(s) ® Registered

Marca(s) ® Registrada(s)

Marque(s) ® Déposée(s)

[www.rcaudiovideo.com](http://www.rcaudiovideo.com)

Printed In China / Impreso en China

v6.0



## Free Manuals Download Website

<http://myh66.com>

<http://usermanuals.us>

<http://www.somanuals.com>

<http://www.4manuals.cc>

<http://www.manual-lib.com>

<http://www.404manual.com>

<http://www.luxmanual.com>

<http://aubethermostatmanual.com>

Golf course search by state

<http://golfingnear.com>

Email search by domain

<http://emailbydomain.com>

Auto manuals search

<http://auto.somanuals.com>

TV manuals search

<http://tv.somanuals.com>