

RCA

u s e r
m a n u a l

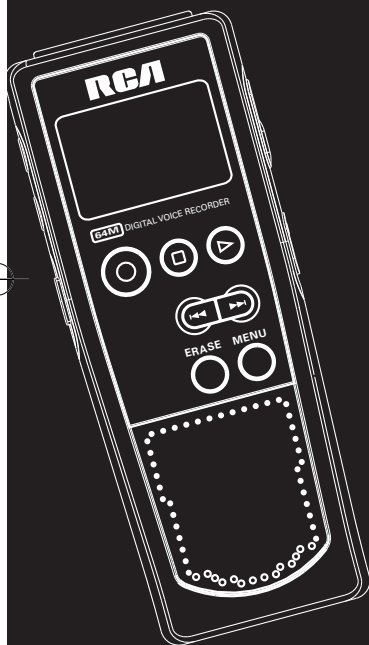

RP5030
RP5035

It is important to read this instruction book prior to using your new product for the first time.
Es importante leer este manual antes de usar por vez primera su equipo.

FCC Information

EN

FCC Information

This device complies with Part 15 of the FCC Rules. Operation is subject to the following two conditions: (1) This device may not cause harmful interference, and (2) this device must accept any interference received, including interference that may cause undesired operation.

In accordance with FCC requirements, changes or modifications not expressly approved by Thomson Inc. could void the user's authority to operate this product.

This device generates and uses radio frequency (RF) energy, and if not installed and used properly, this equipment may cause interference to radio and television reception.

If this equipment does cause interference to radio or television reception (which you can determine by unplugging the unit), try to correct the interference by one or more of the following measures:

- Re-orient the receiving antenna (that is, the antenna for the radio or television that is "receiving" the interference).
- Move the unit away from the equipment that is receiving interference.
- Plug the unit into a different wall outlet so that the unit and the equipment receiving interference are on different branch circuits.

If these measures do not eliminate the interference, please consult your dealer or an experienced radio/television technician for additional suggestions. Also, the Federal Communications Commission has prepared a helpful booklet, "How To Identify and Resolve Radio TV Interference Problems." This booklet is available from the U.S. Government Printing Office, Washington, DC 20402. Please specify stock number 004-000-00345-4 when ordering copies.

For Your Records

In the event that service should be required, you may need both the model number. In the space below, record the date and place of purchase:

Date of Purchase:
Place of Purchase:

Service Information

This product should be serviced only by those specially trained in appropriate servicing techniques. For instructions on how to obtain service, refer to the warranty included in this Guide.

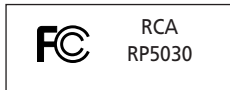

Equipment tested for compliance as a complete unit

	CAUTION RISK OF ELECTRIC SHOCK DO NOT OPEN	
THE LIGHTNING FLASH AND ARROW-HEAD WITHIN THE TRIANGLE IS A WARNING SIGN ALERTING YOU OF "DANGEROUS VOLTAGE" INSIDE THE PRODUCT.	CAUTION: TO REDUCE THE RISK OF ELECTRIC SHOCK, DO NOT REMOVE COVER (OR BACK). NO USER-SERVICEABLE PARTS INSIDE. REFER SERVICING TO QUALIFIED SERVICE PERSONNEL.	THE EXCLAMATION POINT WITHIN THE TRIANGLE IS A WARNING SIGN ALERTING YOU OF IMPORTANT INSTRUCTIONS ACCOMPANYING THE PRODUCT.
SEE MARKING ON BOTTOM / BACK OF PRODUCT		

WARNING: TO PREVENT FIRE OR ELECTRICAL SHOCK HAZARD, DO NOT EXPOSE THIS PRODUCT TO RAIN OR MOISTURE.

FCC Information



Ecology

Help protect the environment - we recommend that you dispose of used batteries by putting them into specially designed receptacles.



Maintenance

Clean the unit with a soft cloth, or a damp chamois leather. Never use solvents.

Precautions for the Unit

- Do not use the unit immediately after transportation from a cold place to a warm place; condensation problem may be resulted.
- Avoid shock to the unit especially during recording. Recorded data can be damaged.
- Do not store the unit near fire, places with high temperature or places with direct sunlight.
- Do not operate or store unit in places with frequent static electricity or electrical noise (e.g. speaker, TV set).
- Clean the unit with a soft cloth or a damp chamois leather. Never use solvents.
- The unit must only be opened by

ESD Remark:

In case of misfunction due to electrostatic discharge just reset the product (disconnect and reconnect of the power source may be required) to resume normal operation.

qualified personnel.

- Do not expose this appliance to rain or moisture.

Precautions for Batteries

- If you do not use the unit for more than one month, be sure to remove the batteries to avoid leakage.
- When installing batteries, be sure that the polarities are correct. Reversing polarity may cause personal injury and damage to the batteries.
- Never mix new batteries with old ones. Do not mix battery types.
- Discard leaking batteries immediately. Leaking batteries can cause skin burns or other personal injury.
- Do not dispose of in fire.
- Do not charge batteries which are not intended to be recharged.

Power Supply

- (battery power) 2 x "AAA"

EN

Contents

EN

FCC Information	Recording quality/condition	10
General Controls	Other Functions	11
The Display	IntroScan	11
Display messages	Play one/play all	11
Before you begin	Erasing file/folder	12
Power supply	Erasing selected file	12
Installing Batteries (not included)	Erasing all files in a folder	12
Auto power shut down	Advanced operation	13
Using headphones and external microphone	Speed	13
Starting up/shutting down the unit	Insert	13
Keys Lock	Append	13
Tones	Cut	14
	Format	14
Setting the time	Connecting to the Computer	15
Year/Date/12/24/Time Setting	Plugged into the computer	15
	Disconnecting from the computer	15
Basic operation	Using your unit as a file storage device	15
Select folder	Transfer files via Windows Explorer (Drag and Drop)	15
Select file	Troubleshooting tips	16
Normal Playback	Warranty	17
Bookmark		
Creating a bookmark		
Skipping to a bookmark		
Deleting a bookmark		
Recording mode		
Setting Recording mode		
Manual Recording		
AVR (Automatic Voice Recording)		

General Controls

EN

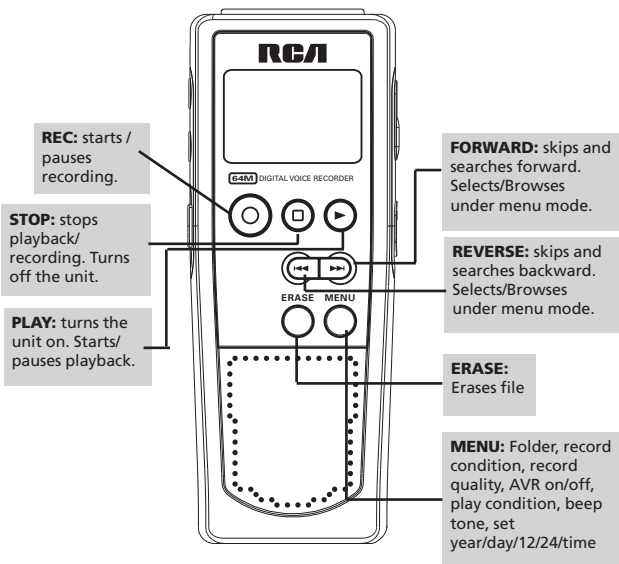
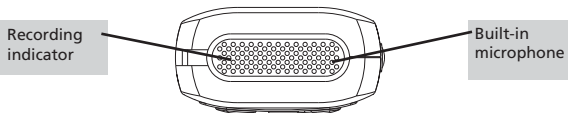

General Controls

EN

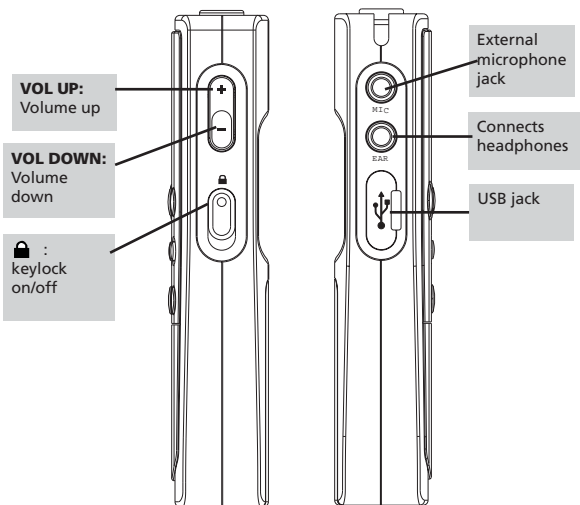

The Display

EN

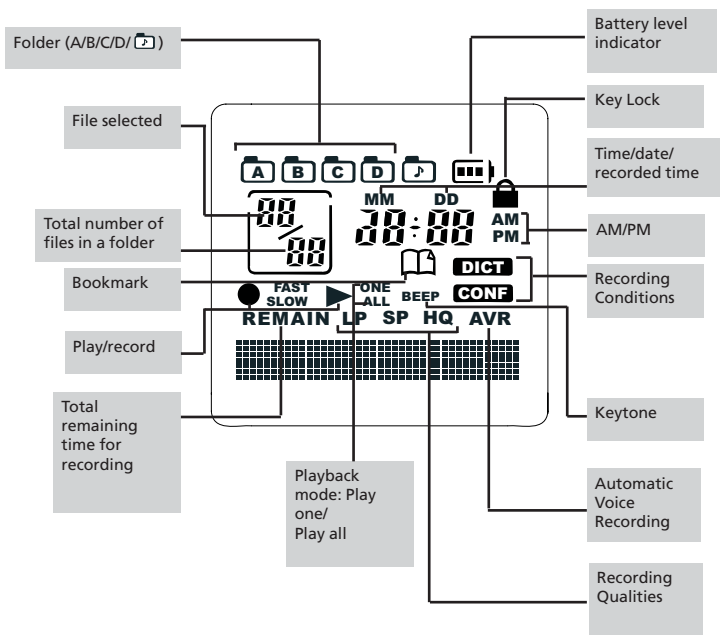

Display Messages

EN

ALL	Select all (Introductory Play back & Erasing All Files)
APPEND	Appendix (Adding Appendix)
CUT-E	Cut End (Cutting)
CUT-S	Cut Start (Cutting)
DELETE	Delete (Erasing Selected File)
FULL	Memory full
MM/DD	Month / day entry mode.
12 HOUR	12 hour time display mode.
24 HOUR	24 hour time display mode.
TIME	Time entry mode
INSERT	Insertion (Inserting New Segments)
INTRO	Introduction (Introductory Playback)
OFF	Off (Automatic Voice Recording)
ON	On (Automatic Voice Recording)
SEN 07	Sensitivity Level (AVR)
TONE	Beeping sound on (Setting Beep Sound)
NO TONE	No beeping sound (Setting Beep Sound)
VOL 15	Volume (Setting Volume)
YEAR	Year (Setting Year)
LOCKED	Key locked
FORMAT	Format the memory
SPEED	Speed of playback
WAIT...	Unit is busy
001%	Formatting is in process
PAUSE	Playback paused

Before You Begin

EN

Power supply

This unit can be operated by 2 "AAA" batteries.

Installing Batteries (not included)

1. Slide the battery compartment door to the bottom and lift up the door to open.
2. Insert 2 "AAA" batteries with polarities matching indications.
3. Replace the battery compartment door.

Refer to the battery level indicator on display for batteries level. Replace with new batteries when the indicator is empty.



Auto power shut down

The unit will be automatically turned off if left idle for 3 minutes.

Using headphones and external microphone

- When headphones are connected, sound output from speaker will be muted.
- When external microphone is connected, no record can be made from built-in microphone.

Starting up the unit



Press **PLAY** to turn on the unit to start playback or recording.

Shutting down the unit

Press **STOP** to turn off the unit.

Keys lock

This feature avoids accidental key activation during recording or playback.

1. Slide the  button upward, **LOCKED** will be flashed on display. (**LOCK** icon  will be shown)
2. Slide the  button downward to unlock the keys.

Tones

You can activate this feature so that beep sound can be heard whenever you press on any button except during playback and recording.



1. Press **MENU** button repeatedly until **TONE** shows on display.
2. Press **REVERSE** or **FORWARD** to set beep sound ON/ OFF.
3. Press **MENU** to confirm selection.

Setting the Time

EN

Year/Date/12/24/Time Setting

With this function, you can always read on the display the recording date and time of your recorded messages. Follow the steps below for time setting.

You can still use this unit for normal recording without setting the time. However, no correct recording date and time can be referred for your recorded messages.

- Turn on the unit.
- Press **MENU** repeatedly to enter Time setting mode.
- When "YEAR" flashes, the digits of the year blinks (default is 2006). Press **REVERSE** or **FORWARD** to increase/decrease the number, press **MENU** to confirm.
- Once the year is entered, the digits in the month field will blink (default is 1). Press **REVERSE** or **FORWARD** to increase/decrease the number, press **MENU** to confirm.
- Once the month is entered, the

digits in the day will blink (while the digits in the month field stop blinking). Press **REVERSE** or **FORWARD** to increase/decrease the number, press **MENU** to confirm.

- Once the date is entered, you can choose between 12/24 hour clock display by pressing **REVERSE /FORWARD**, then press **MENU** to confirm.



- Once the time format is entered, the digits in the hour field will blink (default setting is 12 (12 hour mode) & 0 (24 hour mode). Press **REVERSE** or **FORWARD** to increase/decrease the number, press **MENU** to confirm.
- Once the hour field is entered, the digits in the minute field will blink. Press **REVERSE** or **FORWARD** to increase/decrease the number, press **MENU** to confirm.



Tip:

Press **STOP** to exit to Stop mode.

6

Basic Operation

EN

Select folder

You can select a specific folder (A, B, C, D or ) for browsing. Default is folder A.

1. Press **MENU** in stop mode.
2. Folder A, B, C, D or  icon will blink on display.
3. Press **REVERSE** or **FORWARD** to select a folder.
4. Press **STOP** to exit to stop mode in the desired folder.

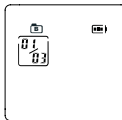
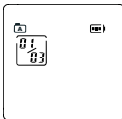

Note:

You can record up to 99 files in one folder, not exceeding 396 files in total. When the maximum limit is reached, "FULL" will show on the display.



Note:

You can find the files transferred from computer in the  folder. See page 15 for details of file transfer.

Select file

You can select a specific file for playback.

1. Select the folder you need.
2. Press **REVERSE** or **FORWARD** to select the file you want. If the file you want is in the current folder, you can press **REVERSE** or **FORWARD** to select it directly in stop and play mode.



Normal Playback

1. In Stop mode, select a folder (A, B, C, D or ).
2. Select file by pressing **REVERSE** or **FORWARD**.
3. Press **PLAY** to start playback.
4. Press **PLAY** to pause playback, press again to resume.
5. You can press **VOL UP (+)** or **VOL DOWN (-)** to adjust listening volume.
6. Press and hold **REVERSE** or **FORWARD** to make quick search within a file.
7. Press **REVERSE** or **FORWARD** once to skip one file forward or backward.
8. Press **STOP** to stop playback.

Bookmark

EN

Creating a bookmark

This feature allows you to create an interception point in the recorded message for quick reference.

1. During playback, press **REC** once to set a bookmark, the bookmark icon  flashes on the display.
2. You can create multiple bookmarks until the memory is full.



Tip:

When the memory is full, "FULL" will show on the display.

Deleting a bookmark

1. Select folder (A, B, C, D or )
2. Select file.
3. Press **ERASE** once and **DELETE** will blink on the screen.
4. Press and hold **PLAY** for 3 seconds to confirm deleting. (or press **STOP** to cancel erasing file)



Tip:

If the file have multiple bookmarks, steps 1-4 will delete ALL bookmarks.

Skipping to a bookmark

You can skip to a bookmark anytime during playback.

1. During playback, press **FORWARD** to go to the bookmark (if available).
2. Press **FORWARD** or **BACKWARD** to search different bookmarks of the file.

Recording Mode

Setting Recording Mode

You can select between two recording modes - manual recording and AVR (automatic voice recording).

1. Manual Recording

1. In **STOP** mode, select folder (A, B, C, D or ).
2. Press **RECORD** to start recording.
3. To pause recording, you can press **RECORD** once, press again to resume recording.
4. To stop recording, press **STOP**.



Tip:

To view the remaining time and other recording information, you may press

PLAY during recording.

2. AVR (Automatic Voice Recording)

This feature allows the unit to sense sound and to record only when you are speaking into the microphone. When dictation stops for about 3 seconds, recording will stop and then start again automatically when you resume dictation.

1. Select destination folder (A, B, C, D or ).
2. Press **MENU** four times.
3. Press **REVERSE** or **FORWARD** to toggle between AVR on and AVR off.

4. Press **STOP** to exit to STOP mode.
5. Press **RECORD** to enter AVR mode.
6. During AVR on recording, adjust the sensitivity of the microphone by pressing **VOL UP** and **VOL DOWN**, **SEN** with sensitivity value shows on display (e.g. increase sensitivity value when recording source is far from the unit or the recording environment is quiet.).
7. Start dictation. Recording starts automatically.
8. Press **STOP** to end AVR recording.
9. Repeat step 2 and select AVR OFF for de-selection.

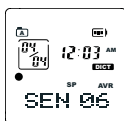
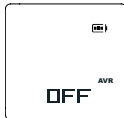

Tip:

The first syllable or two may be lost when you start recording because this

'sound' is used to turn on the AVR feature. It is a good practice to make some 'sounds' or say a short word to activate the AVR before you begin actual dictation.

EN

Recording Quality / Condition

EN

Setting Recording Quality

You can select between three recording qualities. Default is SP.

Definition

- **SP** (Standard Play) - Model RP5030 allows about 520 minutes recording while model RP5020 allows about 1040 recording
- **LP** (Long Play) - Model RP5030 allows about 1040 minutes recording while model RP5035 allows about 2080 minutes recording
- **HQ** (High Quality) - Model RP5030 allows about 260 minutes recording while model RP5035 allows 520 minutes recording

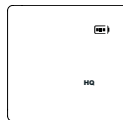
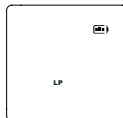
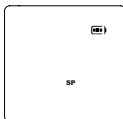

1. Press **MENU** button three times, (**SP**, **LP** or **HQ** show on display.)
2. Toggle between SP and HQ by pressing REVERSE or FORWARD.
3. Confirm selection by pressing MENU or STOP button.

Setting Recording Condition

You can select between two recording conditions. Default is DICT.

Definition

- **CONF** (Conference) - in a more open area and recording source is far from the unit.
- **DICT** (Dictation) - in a more enclosed area and recording source is close to the unit.

1. Press **MENU** two times until DICT or CONF show on display.
2. Select recording condition by pressing **REVERSE** or **FORWARD**.
3. Confirm selection by pressing **MENU** button. (You may press **STOP** to exit from further selection.)



Tip:

For conferences, to obtain optimum recording quality, place the recorder with the microphone freely exposed to the sound source as close as convenient. A built-in automatic recording level control will set the optimum record level during manual recording. Avoid recording near unwanted noise sources, such as air conditioners or fans.

Other Functions

EN

IntroScan

This feature allows playback of the beginning 3 seconds of each file in a folder.

1. Select folder (A, B, C, D or ) and file.
2. Press **REVERSE** or **FORWARD** until ALL shows on display.
3. Press **PLAY** to start introductory playback, INTRO shows on display.
4. Press **PLAY** to start playing desired file.
5. Press **STOP** to exit Intro Scan sooner.



Play one / play all

You can choose to play a specific file or all files in a folder.

1. In STOP mode, press **MENU** button repeatedly until ONE appears on display.
2. Press **REVERSE** or **FORWARD** to toggle between ONE and ALL.



Erasing File / Folder

EN

Erasing selected file

You can delete a file by the following steps:

1. Select folder (A, B, C, D or )
2. Select file.
3. Press **ERASE** once and DELETE will blink on the screen.
4. Press and hold **ERASE** for 3 seconds to confirm deleting. (or press **STOP** to cancel erasing file)



Tip:

File numbers that come after erased one will be moved forward by one automatically.

Erasing all files in a folder

You can delete all files in a specific folder by the following steps:

1. Turn on the unit.
2. Select a folder (A, B, C, D or )
3. In Stop mode, press **FORWARD** continuously until "ALL" appears on the display.
4. Press **ERASE** and "DELETE" will blink on the display.
5. Press and hold **ERASE** for about 3 seconds, all files in the selected folder will be erased completely (or press **STOP** to cancel erasing all files).

Advanced Operation

EN

CAUTION

- The edit function does not operate when battery power is too low or the Introduction Mode is in used.
- After editing a message, "WAIT" will be displayed. Do not power off the device until "WAIT" disappears.

Speed

You can adjust the playback speed.

1. Select folder.
2. Select file for adjusting playback speed.
3. Start playback.
4. Press **PLAY** to start playback.
5. During playback, press **MENU** once, "SPEED" will be shown on display.
6. Press **REVERSE** or **FORWARD** to toggle between FAST and SLOW.
7. Press **PLAY** to confirm and exit.



Insert

You can insert new segments into a file without erasing previously recorded content.

1. Select folder.
2. Select file for inserting new segment.
3. Start playback.
4. Press **MENU** twice to start recording new segment, "INSERT" will be shown on display. Press **RECORD** within three seconds.
5. Press **STOP** to stop recording.
6. "WAIT" will show on the display.
7. After the memory rearrangement completed, the unit will go to STOP mode.



Append

You can add appendix (e.g. reminder, supplementary information) to the end of the file.

1. Select folder.
2. Select file for adding appendix.
3. Start playback.
4. Press **PLAY** to start playback.
5. During playback, press **MENU** three times, "APPEND" will be shown on display.
6. Press **RECORD** within 3 seconds to start recording appendix.
7. Press **STOP** to stop recording.



Advanced Operation

EN

Cut

You can erase unwanted parts from your recording.

1. Select folder.
2. Select file.
3. Start playback of the file with the unwanted part.
4. Press **ERASE** to mark the start of the unwanted part, "CUT-S" shows on display.
5. Press **ERASE** to mark the end of the unwanted part, "CUT-E" shows on display.
6. Press **ERASE** again to confirm cutting (or press **STOP** to cancel)
7. "WAIT" will show on the display.
8. After the memory rearrangement completed, the unit will go to STOP mode.

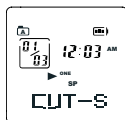

Tip:

Cutting, inserting new segments and adding appendix will only update the recorded time length, without changing recording time and date.

Format (Caution! All data inside the memory will be erased)

You can format the internal memory when needed. (e.g. compatibility problem, etc.)

The procedures are as follow:

1. Turn on the unit.
2. Press **ERASE**, "DELETE" will flash on the display.
3. Press and hold **REC** for 3 seconds, "FORMAT" will flash on the display.
4. Press and hold **ERASE**, the completed percentage will show on the display, formatting is in process.
5. After the formatting is completed, the remain time of the selected memory will show on the display.

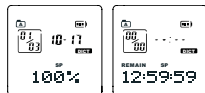

Connecting to the Computer

Plugged into the computer

You can transfer files with computer via USB connection.

1. Use the USB cable supplied to connect the unit to the computer.
2. "PC-LINK" will show on the display.
3. The unit may appear to be a removable drive in your computer.



Tip:

Data transfer is possible even if no batteries are installed in the unit.



Tip:

On some operating system, a message

warning about "Removing a USB device without stopping it..." might appear, you can press OK to safely ignore it.

Transfer Files via Windows Explorer (Drag and Drop)

Your player is associated with a drive letter. From Windows Explorer, highlight all the files/folders you want to transfer to your Player and drag them to the folder named "MUSIC" in the drive. Your files can be found in this folder in the Player once it is disconnected from the computer.

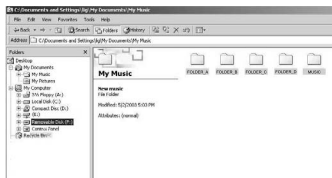

Disconnecting from the computer

Unplug the USB cable after you have copied files to or from the unit.

Using your unit as a file storage device

The unit can function as a detachable data storage. You can take along your favorite images and documents wherever you go. Simple cut-and-paste or drag-and-drop files to or from it via USB connection, the unit will appear as a removable disk in Windows Explorer.

Troubleshooting Tips

EN

Unit doesn't turn on

- Check that batteries are properly inserted and not exhausted.
- Make sure battery compartment door is properly closed.
- Make sure LOCK function is not activated.

Display keeps flashing when unit is off

- You may not have set the time. Refer to section on Time Setting.

Cannot record

- Make sure LOCK function is not activated.
- Make sure memory is not full.
- You have recorded 99 files in one folder. Try record in a new folder.

Cannot show recording date and time during playback

- You may have not set the date and time before recording. Refer to section 'Time Setting'.

No sound from speaker during playback

- Make sure volume is not set to 0.
- Headphones should not be connected.

Cannot edit

- Make sure LOCK function is not activated.

Cannot activate the unit after pressing on keys

- There may be software problems. Remove the batteries to reset the unit.

Recordable time becomes shorter

- You may have set the recording quality to 'High Quality', refer to section 'Setting Recording Quality'.

Cannot perform playback

- Make sure you have selected folder with recorded messages.
- Make sure LOCK function is not activated.

Cannot erase recorded file(s)

- Make sure you follow each step under section "Erasing Selected File" carefully.

Cannot stop recording when AVR ON

- If AVR ON sensitivity is too high (e.g. 8 - 10), recording may not be stopped in noisy environment.

Cannot keep the saved setting

- If the batteries are removed, saved settings may be removed.

U.S. limited warranty

EN

What your warranty covers:

- Defects in materials or workmanship.

For how long after your purchase:

- One year from date of purchase.

The warranty period for rental units begins with the first rental or 45 days from date of shipment to the rental firm, whichever comes first.

What we will do:

- Provide you with a new, or at our option, a refurbished unit. The exchange unit is under warranty for the remainder of the original product's warranty period.
- Proof of purchase in the form of a bill of sale or receipted invoice which is evidence that the product is within the warranty period must be presented to obtain warranty service. For rental firms, proof of first rental is also required.

How to make a warranty claim:

- Properly pack your unit. Include any cables, etc., which were originally provided with the product. We recommend using the original carton and packing materials.
- Include evidence of purchase date such as the bill of sale. Also print your name and address and a description of the defect. Send via standard UPS or its equivalent to:

Thomson Inc.
Product Exchange Center
11721 B Alameda Avenue
Socorro, Texas 79927

- Insure your shipment for loss or damage. Thomson accepts no liability in case of damage or loss en route to Thomson.
- Pay any charges billed to you by the Exchange Center for service not covered by the warranty.
- A new or refurbished unit will be shipped to you freight prepaid.

What your warranty does not cover:

- Customer instruction. (Your Owner's Manual provides information regarding operating Instructions and user controls. For additional information, ask your dealer.)
- Installation and set-up service adjustments.
- Batteries.
- Damage from misuse or neglect.
- Products which have been modified or incorporated into other products.
- Products purchased or serviced outside the USA.
- Acts of nature, such as but not limited to lightning damage.

U.S. limited warranty

EN

Limitation of Warranty:

- **THE WARRANTY STATED ABOVE IS THE ONLY WARRANTY APPLICABLE TO THIS PRODUCT. ALL OTHER WARRANTIES, EXPRESS OR IMPLIED (INCLUDING ALL IMPLIED WARRANTIES OF MERCHANTABILITY OR FITNESS FOR A PARTICULAR PURPOSE) ARE HEREBY DISCLAIMED. NO VERBAL OR WRITTEN INFORMATION GIVEN BY THOMSON INC., ITS AGENTS OR EMPLOYEES SHALL CREATE A GUARANTY OR IN ANY WAY INCREASE THE SCOPE OF THIS WARRANTY.**
- **REPAIR OR REPLACEMENT AS PROVIDED UNDER THIS WARRANTY IS THE EXCLUSIVE REMEDY OF THE CONSUMER. THOMSON INC. SHALL NOT BE LIABLE FOR INCIDENTAL OR CONSEQUENTIAL DAMAGES RESULTING FROM THE USE OF THIS PRODUCT OR ARISING OUT OF ANY BREACH OF ANY EXPRESS OR IMPLIED WARRANTY ON THIS PRODUCT. THIS DISCLAIMER OF WARRANTIES AND LIMITED WARRANTY ARE GOVERNED BY THE LAWS OF THE STATE OF INDIANA. EXCEPT TO THE EXTENT PROHIBITED BY APPLICABLE LAW, ANY IMPLIED WARRANTY OF MERCHANTABILITY OR FITNESS FOR A PARTICULAR PURPOSE ON THIS PRODUCT IS LIMITED TO THE APPLICABLE WARRANTY PERIOD SET FORTH ABOVE.**

How state law relates to this warranty:

- Some states do not allow the exclusion nor limitation of incidental or consequential damages, or limitations on how long an implied warranty lasts, so the above limitations or exclusions may not apply to you.
- This warranty gives you specific legal rights, and you also may have other rights that vary from state to state.

If you purchased your product outside the USA:

This warranty does not apply. Contact your dealer for warranty information.

Canadian limited warranty

EN

Thomson multimedia Ltd. warrants to the purchaser or gift recipient that if any manufacturing defect becomes apparent in this product within 1 year from the original date of purchase, it will be replaced free of charge, including return transportation.

This warranty does not include damage to the product resulting from accidents, misuse or leaking batteries.

Should your product not perform properly during the warranty period, either:

1. Return it to the selling dealer with proof of purchase for replacement,
OR
2. Remove the batteries (where applicable), and pack product complete with accessories in the original carton (or equivalent). Mail prepaid (with proof of purchase) and insured to:

**Thomson multimedia Ltd.
6200 Edwards Blvd.,
Mississauga, Ontario L5T 2V7
Canada**

The provisions of this written warranty are in addition to and not a modification of or subtraction from the statutory warranties and other rights and remedies contained in any applicable legislation, and to the extent that any such provisions purport to disclaim, exclude or limit any such statutory warranties and other rights and remedies, such provisions shall be deemed to be amended to the extent necessary to comply therewith.

If you are unable to find a qualified servicer for out of warranty service, you may write to:
Thomson Inc.
P.O. Box 0944
Indianapolis, Indiana, U.S.A., 46206-0944

Attach your sales receipt to this booklet for future reference. This information is required if service is needed during the warranty period.

PURCHASE DATE

NAME OF STORE

Comercializadora Thomson de México, S.A. de C.V.
Álvaro Obregón No. 151. Piso 13.
Col. Roma. Delegación Cuauhtémoc
C.P. 06700. México, D.F.
Telefono: 52-55-11-020360
RFC: CTM-980723-KS5

Thomson Inc.
P.O. Box 1976, Indianapolis, IN 46206-1976
©2006 Thomson Inc.
Trademark(s) © Registered
Marca(s) © Registrada(s)
Marque(s) © Déposé(s)
www.rca.com
Printed in China/Impreso en China

5629403A

Free Manuals Download Website

<http://myh66.com>

<http://usermanuals.us>

<http://www.somanuals.com>

<http://www.4manuals.cc>

<http://www.manual-lib.com>

<http://www.404manual.com>

<http://www.luxmanual.com>

<http://aubethermostatmanual.com>

Golf course search by state

<http://golfingnear.com>

Email search by domain

<http://emailbydomain.com>

Auto manuals search

<http://auto.somanuals.com>

TV manuals search

<http://tv.somanuals.com>