

## TROUBLESHOOTING

Your ANT2050X antenna comes with a switchable amplifier which is designed to operate over a wide range of signal strengths. The default setting is the DX (distance setting) which is set at the factory and allows maximum amplifier gain. Normally there will be no need to change this setting to the LOC (Local) position, however if the television picture is snowy, or has diagonal lines that appear to move, or has poor reception on some UHF channels, even though the signal is known to be adequate in the area for the affected station.

These conditions can sometimes be the result of too much signal at the amplifier input and can often be remedied by switching to the LOC setting.

In cases where there is a desire to experiment with the picture quality, the switch should be changed from the preset DX setting to the LOC setting.

To change the switch setting, remove the rubber plug and move the switch with your finger to the desired setting (see diagram K).

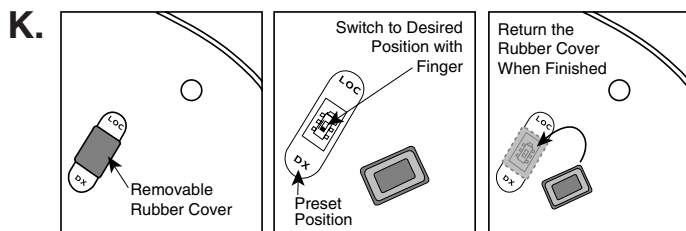

**Some or Most Channels Are Poorly Received:** Loosen the 2 bolts on the "L" shaped pipe where it meets the straight pipe. Next, slightly rotate the antenna's upper assembly, then check TV picture. Repeat process until the best picture is achieved, then retighten the 2 bolts on the "L" pipe. In extreme cases, the upper assembly of the antenna can be removed from the "L" pipe and rotated 180 degrees before replacing assembly in "L" pipe. Then the above rotating procedure is repeated as described above. Another option is to move the ANT2050X to a different place, such as another side of the house or to a higher location. Obstructions such as trees, other houses and mountain sides between the antenna and TV transmitters normally impair reception. Generally, best results occur when the antenna is mounted at the highest available point.

**Picture Has Ghosting (Shadows or Double-images):** Check to make sure that none of the coaxial cables have any sharp bends or kinks in them (a common cause of ghosting). If ghosting persists, check entire system connections for tightness. Also, make sure antenna is not positioned near the house's electric supply lines on the roof or in the attic. It is recommended that the antenna be repositioned in cases where the problem persists. When ghosting cannot be eliminated, consult with a TV or electronics repair shop.

## SPECIFICATIONS

Dish Diameter: 11.6"  
 Dipole Length: 35.9"  
 Height: Adjustable  
 Included Accessories: 2 - 7 ft. RG-6 weather resistant cables,  
 2 - Diplexers

Frequency Range: 54-800 MHz  
 Current: Less than 50mA  
 Voltage: 10-21 VDC  
 Gain: 12 dB  
 IP3: +28 dBm  
 Loss DBS: Max: 1.1 dB at 975 MHz Typical: 0.7 dB  
 DBS Attenuation: Max: 62 dB at 975 MHz Typical: 38 dB  
 Noise Figure: Typical 3.0 dB  
 Other: Integral High Pass Interference Filter

Box Dimensions: 23 7/8" x 15 7/8" x 3 1/8"  
 Unit Weight: 6.5 lbs.

## ONE YEAR LIMITED WARRANTY

Thomson Consumer Electronics will replace this antenna if found to be defective in materials or workmanship. Return it postage prepaid to the address below for prompt, no charge replacement with a current equivalent antenna.

This replacement is TCE's sole obligation under this warranty. TCE will not be responsible for any incidental or consequential damages, or for any loss arising in connection with the use or inability to use this product.

This warranty gives you specific legal rights, and you may also have other rights which vary from State to State.

© 1999 Thomson Consumer Electronics, Inc.  
 Product Exchange Center  
 11721 Alameda Ave.  
 Socorro, Texas, 79927

# RCA

## Omni-Directional DBS Off-Air Antenna



### WARNING!

USE EXTREME CAUTION WHEN INSTALLING AN OUTDOOR ANTENNA CLOSE TO OVERHEAD WIRES. IF THE ANTENNA STARTS TO FALL, LET IT GO! IF ANY PART OF THE ANTENNA MAKES CONTACT WITH OVERHEAD POWER LINES, TOUCHING THE ANTENNA, MAST, CABLE OR GUY WIRES CAN CAUSE ELECTROCUTION AND DEATH. CALL THE POWER COMPANY TO REMOVE THE ANTENNA. DO NOT ATTEMPT TO REMOVE IT YOURSELF.

### IMPORTANT SAFETY PRECAUTIONS:

Please read and follow these important safety precautions:

- Be sure to select an antenna site well away from any overhead wires.
- Do not try to guess which overhead wires carry high voltage.
- Always check with the power company whenever overhead wires are involved.

- If you notice anything making contact with the overhead wires, call the power company to have the item removed properly.
- Do not run the download cable over power wires.
- If there is any doubt of clearing overhead wires, only a qualified professional should remove an old antenna.
- Never install the antenna outdoors in windy conditions.
- Make sure the antenna download cable is connected to suitable lightning arresters if antenna is not mounted on the DBS Antenna.
- Make sure the antenna installation is secure.

### LIGHTNING PROTECTION:

When ANT2050X is not mounted on the pole of the DBS antenna, a copper ground wire (not included) should be installed from the "To TV" F connector on antenna to a grounding block (not included). This grounding block should be as close as possible to where the down lead enters the house.



ANT2050X

## TROUBLESHOOTING

Your ANT2050X antenna comes with a switchable amplifier which is designed to operate over a wide range of signal strengths. The default setting is the DX (distance setting) which is set at the factory and allows maximum amplifier gain. Normally there will be no need to change this setting to the LOC (Local) position, however if the television picture is snowy, or has diagonal lines that appear to move, or has poor reception on some UHF channels, even though the signal is known to be adequate in the area for the affected station.

These conditions can sometimes be the result of too much signal at the amplifier input and can often be remedied by switching to the LOC setting.

In cases where there is a desire to experiment with the picture quality, the switch should be changed from the preset DX setting to the LOC setting.

To change the switch setting, remove the rubber plug and move the switch with your finger to the desired setting (see diagram K).

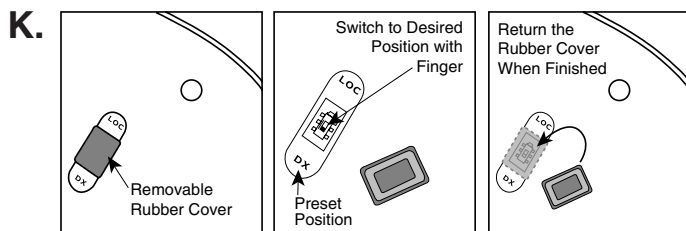

**Some or Most Channels Are Poorly Received:** Loosen the 2 bolts on the "L" shaped pipe where it meets the straight pipe. Next, slightly rotate the antenna's upper assembly, then check TV picture. Repeat process until the best picture is achieved, then retighten the 2 bolts on the "L" pipe. In extreme cases, the upper assembly of the antenna can be removed from the "L" pipe and rotated 180 degrees before replacing assembly in "L" pipe. Then the above rotating procedure is repeated as described above. Another option is to move the ANT2050X to a different place, such as another side of the house or to a higher location. Obstructions such as trees, other houses and mountain sides between the antenna and TV transmitters normally impair reception. Generally, best results occur when the antenna is mounted at the highest available point.

**Picture Has Ghosting (Shadows or Double-images):** Check to make sure that none of the coaxial cables have any sharp bends or kinks in them (a common cause of ghosting). If ghosting persists, check entire system connections for tightness. Also, make sure antenna is not positioned near the house's electric supply lines on the roof or in the attic. It is recommended that the antenna be repositioned in cases where the problem persists. When ghosting cannot be eliminated, consult with a TV or electronics repair shop.

## SPECIFICATIONS

Dish Diameter: 11.6"  
 Dipole Length: 35.9"  
 Height: Adjustable  
 Included Accessories: 2 - 7 ft. RG-6 weather resistant cables,  
 2 - Diplexers

Frequency Range: 54-800 MHz  
 Current: Less than 50mA  
 Voltage: 10-21 VDC  
 Gain: 12 dB  
 IP3: +28 dBm  
 Loss DBS: Max: 1.1 dB at 975 MHz Typical: 0.7 dB  
 DBS Attenuation: Max: 62 dB at 975 MHz Typical: 38 dB  
 Noise Figure: Typical 3.0 dB  
 Other: Integral High Pass Interference Filter

Box Dimensions: 23 7/8" x 15 7/8" x 3 1/8"  
 Unit Weight: 6.5 lbs.

## ONE YEAR LIMITED WARRANTY

Thomson Consumer Electronics will replace this antenna if found to be defective in materials or workmanship. Return it postage prepaid to the address below for prompt, no charge replacement with a current equivalent antenna.

This replacement is TCE's sole obligation under this warranty. TCE will not be responsible for any incidental or consequential damages, or for any loss arising in connection with the use or inability to use this product.

This warranty gives you specific legal rights, and you may also have other rights which vary from State to State.

© 1999 Thomson Consumer Electronics, Inc.  
 Product Exchange Center  
 11721 Alameda Ave.  
 Socorro, Texas, 79927

## INSTALLATION CONTINUED

the straight pipe with 5 holes (as shown in diagram B). Now place assembled pipes into small end of double mounting clamp and loosely secure clamp with wrench (as shown in diagram C).

- Mount pipe and mounting clamp assembly on "Support Column" of DBS system antenna (as shown in diagram D).
- Mount dish, antenna, and spreader bracket assembly on pipe and mounting clamp assembly (as shown in diagram E). Note that antenna assembly can be rotated to clear any obstruction or for fine tuning. The ANT2050X overall height can be adjusted by resetting the 5 hole pipe using its other pre-drilled hole (as shown in diagram F).

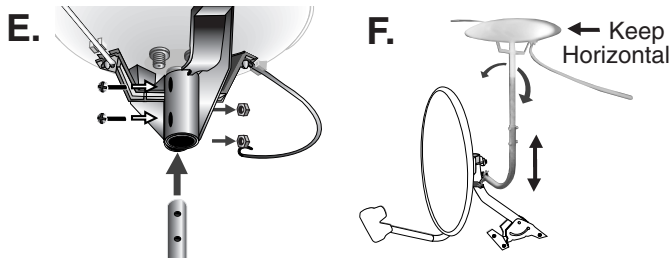

- IMPORTANT:** Make sure that dish assembly is fully horizontal and that no part of the dish itself covers the front surface of the DBS antenna (as shown in diagram G).
- Connect 7-foot coaxial cable(s) from LNB of DBS antenna to "from DBS dish" connector(s) of the antenna. Next, connect the cable(s) going into house to "to TV" connector(s) of the antenna

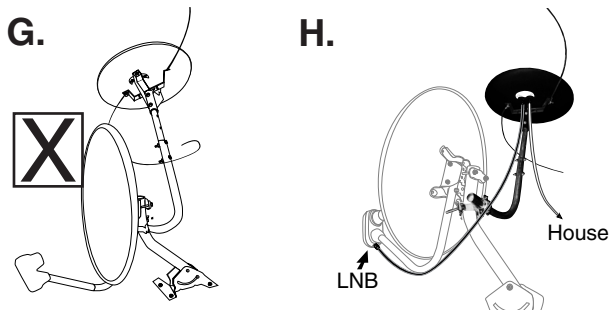

(as shown in diagram H).

- An external "separating" diplexer is used to separate the antenna's VHF/UHF signal from the satellite signal before the coaxial cable is connected to the DBS receiver (as shown in diagram I). Connect the VHF/UHF cable from the external "separating" diplexer DIRECTLY to the TV's 75 ohm "F" jack for best results! (It is NOT recommended to connect the VHF/UHF cable DIRECTLY to the DBS receiver since it will likely degrade VHF/UHF picture quality.) The satellite signal cable from the external "separating" diplexer should be connected DIRECTLY to the DBS receiver 75 ohm "F" jack. The DBS connection to the TV can be done with RCA type patch cords, which connect the DBS receiver's Video/Audio Output to the TV's Video/Audio Input. The best connection, however, is made using the DBS receiver's S-Video

## INSTALLATION CONTINUED

Output to the TV's S-Video Input (as shown in diagram I). RCA patch cords and S-Video cables are supplied in most DBS installation kits.

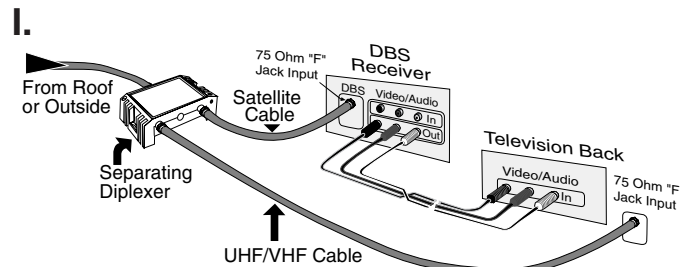

## FOR OPTIMAL PERFORMANCE

- Mount the antenna a minimum of 8 feet high (the higher, the better).
- The ANT2050X is an omnidirectional antenna; however as with any antenna, it performs best in locations where there is a clear path, or a "line of sight", to the approximate location of the TV transmitters in your area.

### In the attic

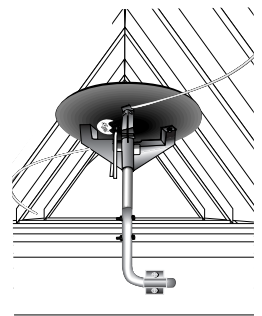

**Note:** Even with the advanced design of this antenna, large obstructions such as canyon walls, mountain sides, and other man-made or natural geographic objects can impair performance. Therefore, it is best to minimize any obstructions that block the "line of sight" by mounting the DBS antenna on the roof or on the highest possible point.

- When the DBS antenna is mounted less than 8 feet high, the antenna can be mounted on the side of the house, chimney, or in the attic to achieve the required height. Wood screws or the included mortar "anchors" can be used with the antenna dish mounting clamp (as shown in diagram J) to mount the antenna on the side of the house, the chimney, or in the attic.

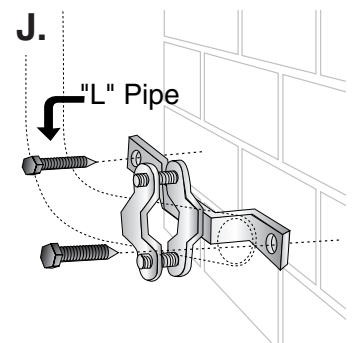

## Free Manuals Download Website

<http://myh66.com>

<http://usermanuals.us>

<http://www.somanuals.com>

<http://www.4manuals.cc>

<http://www.manual-lib.com>

<http://www.404manual.com>

<http://www.luxmanual.com>

<http://aubethermostatmanual.com>

Golf course search by state

<http://golfingnear.com>

Email search by domain

<http://emailbydomain.com>

Auto manuals search

<http://auto.somanuals.com>

TV manuals search

<http://tv.somanuals.com>