



**IMPORTADOR**  
Comercializadora Thomson de México, S.A. de C.V.  
Miguel de Cervantes Saavedra 57  
Col. Ampliación Granada  
C.P. 11529 Mexico D.F.  
Telefono: (55)25 81 53 20  
RFC: CTM-980723-KS5

0151

**EXPORTER**  
Thomson multimedia Inc.  
P.O. Box 1976  
Indianapolis, IN 46206-1976  
© 2002 Thomson multimedia Inc.  
Trademark(s) ® Registered  
Marca(s) ® Registrada(s)  
Marque(s) ® Déposé(e)s  
55392950 (EN/F/E)  
[www.rca.com](http://www.rca.com)  
[www.rca.com/LatinAmerica](http://www.rca.com/LatinAmerica)  
Printed In China / Impreso en China

# RCA

u  
s  
e  
r  
m  
a

n  
u  
a  
l

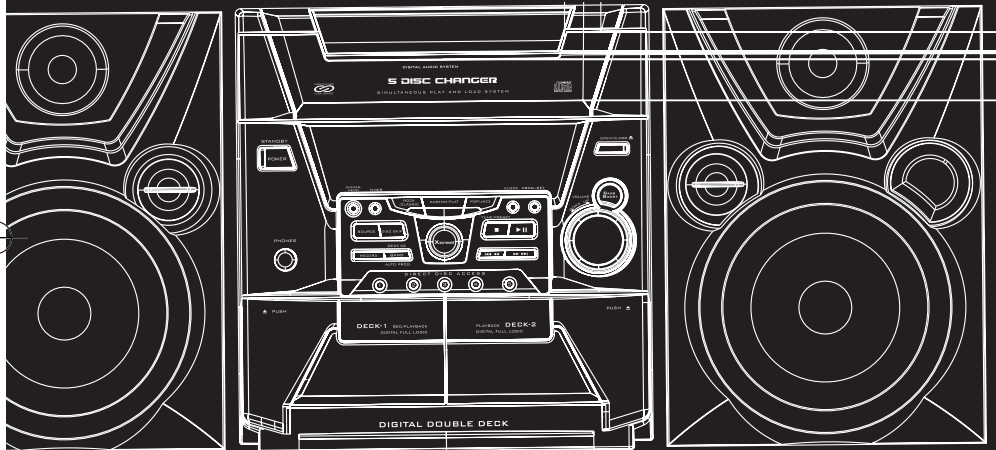

## RS2610

It is important to read this instruction book prior to using your new product for the first time.  
Es importante leer este manual antes de usar por vez primera su equipo.

# FCC Information

EN

## FCC Information

This device complies with Part 15 of the FCC Rules. Operation is subject to the following two conditions: (1) This device may not cause harmful interference, and (2) this device must accept any interference received, including interference that may cause undesired operation.

In accordance with FCC requirements, changes or modifications not expressly approved by Thomson multimedia Inc. could void the user's authority to operate this product.

This device generates and uses radio frequency (RF) energy, and if not installed and used properly, this equipment may cause interference to radio and television reception.

If this equipment does cause interference to radio or television reception (which you can determine by unplugging the unit), try to correct the interference by one or more of the following measures:

- Re-orient the receiving antenna (that is, the antenna for the radio or television that is "receiving" the interference).
- Move the unit away from the equipment that is receiving interference.
- Plug the unit into a different wall outlet so that the unit and the equipment receiving interference are on different branch circuits.

If these measures do not eliminate the interference, please consult your dealer or an experienced radio/television technician for additional suggestions. Also, the Federal Communications Commission has prepared a helpful booklet, "How To Identify and Resolve Radio TV Interference Problems." This booklet is available from the U.S. Government Printing Office, Washington, DC 20402. Please specify stock number 004-000-00345-4 when ordering copies.

This product complies with DHHS Rules 21 CFR Subchapter J. Applicable at the date of manufacture.

Have a Blast- Just Not in Your Eardrums  
Make sure you turn down the volume on the unit before you put on headphones. Increase the volume to the desired level only after headphones are in place.



## Technical specification

Product: 5CD Audio System  
Brand: RCA  
Model: RS2610

### Electrical Consumption:

Power Supply: 120V / 240V  
60 Hz / 50Hz  
Power consumption: 500 Watts

### IMPORTER

Comercializadora Thomson de México, S.A. de C.V.  
Miguel de Cervantes Saavedra 57  
Col. Ampliación Granada  
C.P. 11529 Mexico D.F.  
Telefono: (55)25 81 53 20  
RFC: CTM-980723-KS5

## For Your Safety

The AC power plug is polarized (one blade is wider than the other) and only fits into AC power outlets one way. If the plug won't go into the outlet completely, turn the plug over and try to insert it the other way. If it still won't fit, contact a qualified electrician to change the outlet, or use a different one. Do not attempt to bypass this safety feature.

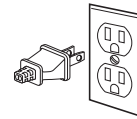

**CAUTION: TO PREVENT ELECTRIC SHOCK, MATCH WIDE BLADE OF PLUG TO WIDE SLOT, FULLY INSERT.**

	<p><b>CAUTION</b> RISK OF ELECTRIC SHOCK DO NOT OPEN</p>	
<p>THE LIGHTNING FLASH AND ARROWHEAD WITHIN THE TRIANGLE IS A WARNING SIGN ALERTING YOU OF "DANGEROUS VOLTAGE" INSIDE THE PRODUCT.</p>	<p>CAUTION: TO REDUCE THE RISK OF ELECTRIC SHOCK, DO NOT REMOVE COVER (OR BACK). NO USER-SERVICEABLE PARTS INSIDE. REFER SERVICING TO QUALIFIED SERVICE PERSONNEL.</p>	<p>THE EXCLAMATION POINT WITHIN THE TRIANGLE IS A WARNING SIGN ALERTING YOU OF IMPORTANT INSTRUCTIONS ACCOMPANYING THE PRODUCT.</p>
<p>SEE MARKING ON BOTTOM / BACK OF PRODUCT</p>		

**WARNING: TO PREVENT FIRE OR ELECTRICAL SHOCK HAZARD, DO NOT EXPOSE THIS PRODUCT TO RAIN OR MOISTURE.**

# Safety Information

## For Your Records

In the event that service should be required, you may need both the model number and the serial number. In the space below, record the date and place of purchase, and the serial number:

Model No.  
Remote Control No.  
Date of Purchase  
Place of Purchase  
Serial No.

## Service Information

This product should be serviced only by those specially trained in appropriate servicing techniques. For instructions on how to obtain service, refer to the warranty included in this Guide.

EN

# Contents

## FCC Information Safety Information

### Getting Started

- Unpacking the System .....2
- Back View .....2
- Using the FM and AM
- Antennas .....2
- Connecting the Speakers ...2
- Installation .....2

### Controls & Indicators

- Main Unit .....3
- Remote Control .....4
- Installing Batteries .....4

### Display Settings

- Showing the Demonstration  
.....5
- Display Clock/Timer .....5
- Setting the Clock .....5
- Setting the Timer .....5
- Activating the Timer .....5
- Adjusting the Display
- Brightness .....5
- Sleep Mode .....5

## Sound Features

- Using Preset Equalizer Curves  
.....6
- Creating a Custom Curve .6
- Bass Boost .....6
- Muting Audio .....6
- X-Surround .....6

## CD Player

- Notes on CD-R/CD-RW Disc .6
- Loading Discs .....6
- Playing Discs .....6
- Skipping a Disc .....7
- Searching through a CD .7
- Shuffling the Play Order .7
- Sampling Tracks .....7
- Repeat .....7
- Setting Up a CD program .7
- Playing a Program List ...7
- Displaying the Program list  
.....7
- Deleting a Program List .7

## Tuner

- Selecting Tuner .....8
- Tuning to a Station .....8
- Using Presets .....8
- Auto Preset Program  
(for FM only) .....8
- Setting Presets .....8
- Suppressing Stereo Signal .8

## Tape Player

- Playing a Tape .....9
- Continuous Play .....9
- Recording .....9
- From Tuner .....9
- From CD .....9
- Tape to Tape .....9
- From an Auxiliary Input .9

## Troubleshooting Tips

.....10

## Maintenance

- Cleaning .....11
- CD Player .....11
- Tape Player .....11
- Handling CDs .....11
- Cleaning CDs .....11
- CD Lens Care .....11

## More Information ...12

- Safety Precautions .....12
- Important Battery  
Information .....12
- Headset Safety .....12
- Don't Infringe .....12
- Technical Specification ...12

## Limited Warranty

**(U.S.) .....13**

## Limited Warranty

**(Canada) .....15**

# Getting Started

EN

## Unpacking the system:

You should have the following:

- one main unit (with 2 main speakers);
- one remote control;
- one FM antenna wire;
- one AM loop antenna;
- one user's guide;
- one safety leaflet;
- Owner and registration Card

## Back View

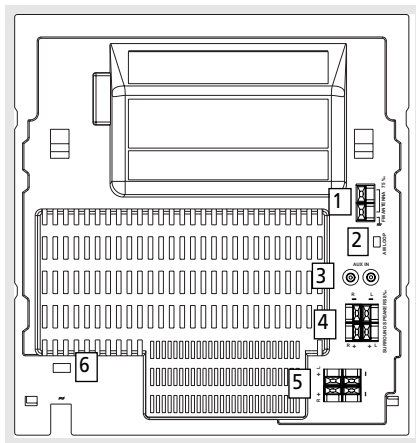

1. FM Antenna
2. AM Loop Antenna Jack
3. AUX IN Connector
4. Surround Speaker Jacks
5. Main Speaker Jacks
6. Voltage Selector

## Using the FM and AM Antennas

Before you use your audio system, you'll want to make sure the FM antenna is positioned properly. Connect the FM antenna to the FM connector on the back of the unit. Uncoil it, making sure it is fully extended (you may even want to tape it to the wall behind the unit, if possible. The higher, the better.)

You'll also need to connect the AM antenna loop to the back of the unit if you listen to AM stations. Rotate the AM loop antenna for better reception.

## Connecting the Speakers

Match the red wire (on the left speaker) to red terminal for the left speaker (L) on the back of the unit and the black wire (on the left speaker) to the black terminal for left speaker (L). Follow the same procedure to connect the right (R) speaker.

### Antenna and Speaker Wire Connection

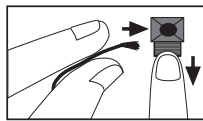

Push terminal tab down to insert wire.

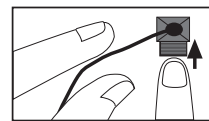

Release tab to lock wire in the terminal.

**NOTE:** Make sure the insulation is completely removed from the ends of the Antenna and speaker wires at all connection points.

## Installation

To ensure sufficient ventilation, keep the spacings shown below free from other surfaces:

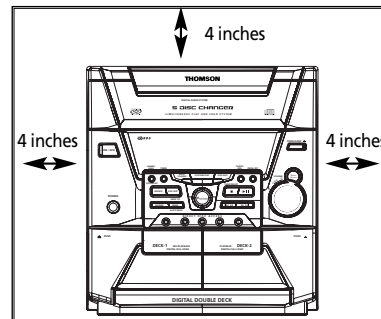

Front View

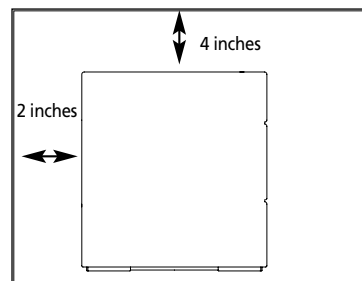

Side View

# Controls and Indicators

## Main Unit

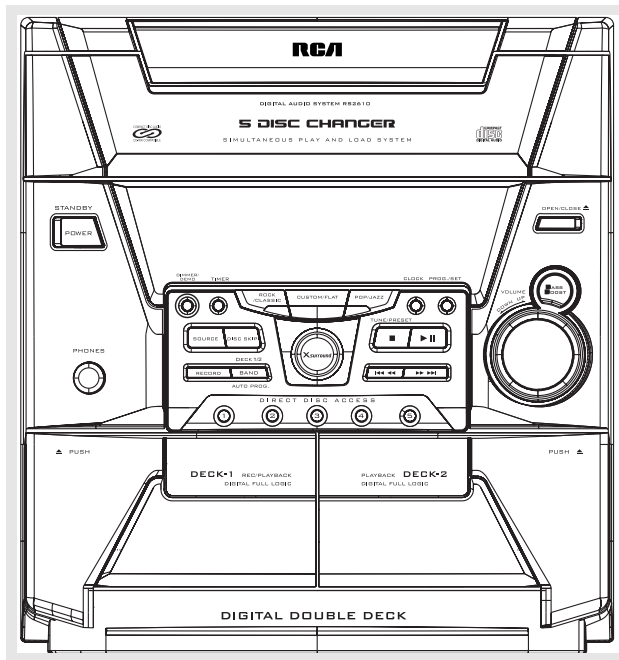

**STANDBY / POWER** — Turns power on or off (Standby mode).

**Tip:** In **STANDBY** mode (press **STANDBY/POWER** off), the system displays the time. Press **STANDBY/POWER** to turn the system on in the previously used mode. Press **CD**, **TAPE**, **TUNER**, or **AUX** (Remote only) to select the corresponding mode. Look at the display icons to identify the current mode.

**PHONES** — Jack for connecting headphones.

**SOURCE** — Selects the CD player/ tuner/ tape player/ external source.

**DIMMER / DEMO** — Turns the feature demonstration on or off; adjusts display contrast.

**TIMER** — Enters timer setting mode; turns timer on/off.

**CLOCK** — Shows clock time and enters clock setting mode.

**PROG./SET** - Enters program or setting mode for CD & tuner mode.

**DISC SKIP** — Skips to the next CD in the tray.

**RECORD** - Starts tape recording.

**BAND / DECK 1/2 /AUTO PROG.** — Changes among tuner bands; enters auto-preset program in FM mode; switches between deck 1 and 2 on cassette player.

**DISC 1 - DISC 5** — Selects disc 1, 2, 3, 4, or 5 and start playback automatically.

**OPEN/CLOSE** — Opens or closes the disc tray.

■ **STOP/TUNE/PRESET** — Stops CD track and tape operations; selects tune or presets mode.

▶▶▶▶ **SKIP FORWARD** — Increments radio frequency, preset up, CD tracks or fast forward tape.

◀◀◀◀ **SKIP BACKWARD** — Decrements radio frequency, preset down, CD tracks or rewind tape.

▶|| **PLAY/PAUSE** — Plays or pauses CD and tape.

**BASS BOOST** — Turns bass boost on or off.

**EQ CONTROLS (ROCK / CLASSIC, CUSTOM/FLAT, POP / JAZZ)** - selects among the different preset EQ options.

**X-SURROUND** — Turns X-Surround on or off.

**VOLUME** — Increases/ decreases volume.

EN

# Controls and Indicators

EN

## Remote Control

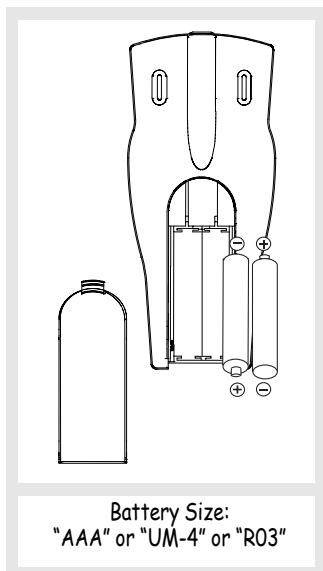
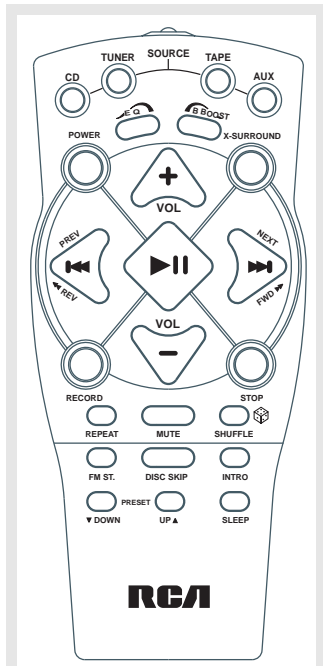

**POWER** — Turns the power on and off from Standby mode.

**CD** — Selects CD player.

**TUNER** — Selects radio tuner.

**TAPE** — Selects tape player.

**AUX** — Selects external input.

**EQ** — Selects equalizer presets.

**B.BOOST** — Turns on or off Bass Boost.

**X-SURROUND** — Activates SURROUND.

**VOL+ or VOL-** — Increases/ decreases volume.

**▶▶ PLAY/PAUSE** — Plays and Pauses the CD or tape.

**▶▶ NEXT/FWD** — *In CD mode* - Increments CD track and setting

options; searches forward through CD;

*In Tuner mode* - Tunes up radio frequency;

*In Tape mode* - Fast forwards tape.

**◀◀ PREV/REV** — *In CD mode* - Decrements CD track and setting

options; searches backward through CD;

*In Tuner mode* - Tunes down radio frequency

*In Tape mode* - Rewinds tape.

**RECORD** — Starts tape recording.

**STOP** — Stops CD playback, tape playback and tape recording.

**REPEAT** — Repeats a track, CD, or all CDs.

**MUTE** — Mutes volume.

**SHUFFLE** — Turns on/off random listening;

**FM ST.** — Toggles between FM stereo and mono.

**DISC SKIP** — Skips to next CD.

**INTRO** — Turns INTRO mode on or off to play the first 10 seconds of each track.

**PRESET UP/DOWN** — Selects next/ previous preset station.

**SLEEP** — Press to select the time interval in minutes before the unit turns off.

## Installing Batteries

The remote control must be inserted with 2 "AAA" or "R3" or "UM 4" batteries prior to use. Follow the steps below to ensure correct installation.

1. Open the battery compartment door (located at the back of the remote control) by sliding the cover out.
2. Before inserting the batteries, observe the polarities (that is, + and -) of the battery then relate the polarities to the engraved diagram inside the battery compartment. Now insert the batteries.
3. After installation of the batteries, place the lid to cover the batteries. Lightly push it closed with a snap.

# Display Settings

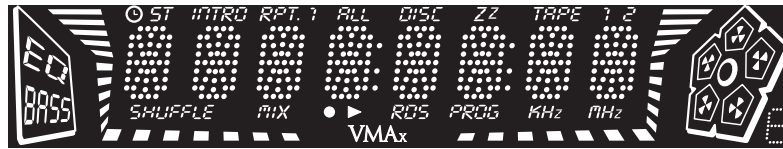

EN

## Showing the Demonstration

Not operational in CD mode. Press **DEMO/DIMMER** to turn on/off demonstration mode. The demonstration scrolls through all display operations.

## Display Clock / Timer

### Setting the Clock

1. Press and hold **CLOCK** until the hour flashes on the display.
2. Press **SKIP FORWARD** **>>>>** / **SKIP BACKWARD** **<<<<** to set the hour and then press **CLOCK** to shift to minute digits.
3. Press **SKIP FORWARD** **>>>>** / **SKIP BACKWARD** **<<<<** to set the minute.
4. Press **PROG./SET** to save settings and **STOP** **■** to quit setting.

#### Note:

- When system is ON, you can press **CLOCK** to display the current time for about 2 seconds.
- Clock cannot be set in FM Mode.

### Setting the Timer

1. Press and hold **TIMER** until the **ON** and the hour flash on the display ( **ON** - timer on time ).
2. For setting time, press **SKIP FORWARD** **>>>>** / **SKIP BACKWARD** **<<<<** to set the hour and then press **TIMER** to shift to minute digits.
3. Press **SKIP FORWARD** **>>>>** / **SKIP BACKWARD** **<<<<** to set the minute.
4. Press **TIMER** to change to **OF** (timer off time) with hour flashing. Repeat steps 2 & 3 for timer off time setting.
5. Press **TIMER** for source selection.
6. Press **SKIP FORWARD** **>>>>** / **SKIP BACKWARD** **<<<<** to select between CD / TUNER / TAPE / TUNER REC.
7. If Tuner or Tuner Rec is selected, press **SKIP FORWARD** **>>>>** or **SKIP BACKWARD** **<<<<** to select the preset station to turn on to.

8. Press **TIMER** to set volume.

9. Turn the **VOLUME** knob to set desired volume level.

10. Press **PROG./SET** to save settings or **STOP** **■** to quit setting.

### Activating the Timer

Press and release **TIMER** to turn on/off the alarm. The alarm is active when the clock icon indicator is lit.



### Adjusting the Display Brightness

1. Press and hold **DEMO/DIMMER** for more than 2 seconds.

2. While the dimmer is displayed, press and release **DEMO /DIMMER** to select the desired level (**DIMM 0 - 3**).

### Sleep Mode

You can select the time interval in minutes before the unit turn off automatically. Press **SLEEP** on the remote to select among OFF, 120, 90, 60, 45, 30, 15 and 5 minutes. (Remote only)



# Sound Features

EN

## Using Preset Equalizer Curves

Press **ROCK/CLASSIC, CUSTOM/FLAT, POP/JAZZ** on the main unit or **EQ** on the remote to toggle among **FLAT, ROCK, POP, JAZZ, CLASSIC & CUSTOM**. The display shows briefly the selection.

## Creating a Custom Curve

1. Press **CUSTOM/FLAT** on the main unit or **EQ** on the remote to select **CUSTOM** mode.
2. While "**CUSTOM**" is displayed, press **SKIP FORWARD** **▶▶▶** / **SKIP BACKWARD** **◀◀◀** or **PREV/REV / NEXT/FWD** on the remote to cycle among bass and treble range levels.
3. While **BAS** or **TRE** is displayed, turn the **VOLUME** knob to set the associated gain between -10 - +10.



## BASS BOOST

Press **BASS BOOST** to turn on/off boosting the bass frequency.

## Muting Audio

Press **MUTE** on the remote to cut the sound. (Remote Only)



## X- Surround

Press **X-SURROUND** to enjoy enriched sound quality. This feature gives you:

1. Better width and depth for vocal and instrumental sound.
2. More powerful presence for studio recording.
3. Enhanced surround effects with greater flexibility in positioning speakers.

# CD PLAYER



CD-R / RW

This unit is compatible with CD-RW/ CD-R discs for playback.

## Notes on CD-R/RW Disc:

- Do not affix any type of labels to either side (recordable or labeled side) of a CD-R/RW disc as this may result in the unit malfunctioning.
- To avoid damages to the CD-R/RW disc, do not open the disc compartment door while the disc is being read.
- Do not load an unrecorded CD-R/RW disc into the unit. This may take a longer time to read the disc.
- **Playback capability for CD-RW discs may vary due to variations in the quality of the CD-RW disc and the recorder used to create the disc.**

## Loading Discs

1. Press **SOURCE** repeatedly to select **CD** mode.
  2. Press **OPEN/CLOSE** **▲** to open the drawer.
  3. Insert up to five discs with label face up. (Press **DISC SKIP** to rotate the disc carrier.)
  4. Press **OPEN/CLOSE** **▲** to close the drawer.
- Loaded disc position icon lights.

## Playing Discs

- Press **PLAY/PAUSE** **▶||** to begin or pause play, and **STOP** **■** to stop play.
- Select a specific disc by pressing **DISC 1 - DISC 5**.
- Press **SKIP FORWARD** **▶▶▶** / **SKIP BACKWARD** **◀◀◀** to select a specific track.

## Play and load simultaneously by:

1. Press **OPEN/CLOSE** **▲** to open the tray while a CD is playing
2. Load/change discs for available trays by pressing **DISC SKIP**.
3. Press **OPEN/CLOSE** **▲** to close the tray.

# CD Player

EN

## Skipping a Disc

Press **DISC SKIP**.

## Searching Through a CD

Press and hold **SKIP FORWARD** **▶▶▶▶** / **SKIP BACKWARD** **◀◀◀◀** to search through a CD while it is playing.

**Tip:** While playing a CD, press and hold **SKIP-FORWARD** or **BACKWARD** for more than 2 seconds to search through the CD.

## Shuffling the Play Order

Press **SHUFFLE** to turn on/off the playing of tracks in random order. (Remote Only)

## Sampling Tracks

Press **INTRO** to play the first 10 seconds of each track on the current disc, all discs in the tray, or turn **INTRO** mode off. (Remote Only)

## Repeat

Press **REPEAT** to repeat the current track, current disc, all discs, or turn **REPEAT** mode off. (Remote Only)

**Note:** You may also press **REPEAT** to select 1 disc or all discs before activating **INTRO** & **SHUFFLE** functions

## Setting Up a CD Program

You can program the CD player to play up to any 32 tracks on the CDs in the tray.

1. While the CD player is stopped, press **PROG./SET** to enter program mode.

The system displays the next available program number: "-- P:01," with "--" flashing, prompts you for the first track in the program list.

2. Press **SKIP FORWARD** **▶▶▶▶** / **SKIP BACKWARD** **◀◀◀◀** to select a track (press **DISC SKIP** or **DISC 1 - DISC 5** to select a track from a different disc).



3. Immediately press **PROG./SET** to assign the selected track to the program number. After 3 seconds, you are prompted for the next track in the program list. (In CD program mode, **PROG** icon will be lit.)

## Playing a Program List

While in **PROGRAM** mode, press **PLAY▶II** to begin program playback.

## Displaying the Program List

1. While the CD player is stopped, press **PROG./SET** to enter **PROGRAM** mode.  
2. Press **PROG./SET** repeatedly to list each track assignment in the program list.

## Deleting Program List

While in program mode, press and hold **STOP** **■** for 5 seconds. The system displays the message CLEAR.

### Tips:

- You can create a program of up to 32 tracks.
- Press **CD DISPLAY** repeatedly to view elapsed track time, track number, track remain time and disc remain time.

**Caution:** Do not push to force closing of the tray during CD playback or tray opening.

# Tuner

## EN Selecting Tuner

1. Press **SOURCE** to select **TUNER**.
2. Press **BAND** to select between FM/AMradio band.

Tip: Your audio system has 32 preset stations.

## Tuning to a Station

Press **SKIP FORWARD** **>>>** / **SKIP BACKWARD** **<<<** to select frequencies.

87.50 MHz

## Using Presets

The tuner can be either TUNE or PRESET mode. When in PRESET mode, the PROG light is on.

- Press **TUNE/PRESET** **■** to toggle between Preset and Tune mode.
- Press **SKIP FORWARD** **>>>** / **SKIP BACKWARD** **<<<** on the main unit or **PRESET UP / DOWN** on the remote control to access the previous or next preset station. The display first shows the preset program number and after a few seconds, the frequency will be displayed. (FMPR:01 is FM preset 1)

PR:01

## Auto Preset Programming (for FM only)

Press and hold **BAND/DECK1/2/AUTO PROG.** button for 2 second to scan stations in the selected band. The stations will then be stored as preset channels. A maximum of 32 stations can be stored. Beware of your preset channels being erased accidentally because the scanning and storing process is automatic upon pressing the button.

You can stop the automatic scan by pressing any button, but the erased stations cannot be recovered.

## Manually Setting Presets

1. Press **TUNE/PRESET** **■** to enter TUNE mode.
2. Press **SKIP FORWARD** **>>>** / **SKIP BACKWARD** **<<<** to access the desired frequency.
3. Press the **PROG. SET** button once.
4. The most recently accessed program location will be displayed.
5. If a different program location is preferred, press **SKIP FORWARD** **>>>** / **SKIP BACKWARD** **<<<** to move to the desired preset number (1-32).
6. Press **PROG. SET** to store the selected frequency at that preset.

## Suppressing Stereo Signal

Press **FM ST** to toggle between FM mono and stereo for stereo FM stations. (Remote Only)

# Tape Player

EN

## Playing a Tape

Tip: You can play a tape from either deck.

1. Press **SOURCE** repeatedly to select **TAPE**.
2. Press the cassette door to open it.
3. Insert a tape into the door and push the door closed.
4. Press **BAND/DECK 1/2** to select deck 1 or 2.
5. Press **SKIP FORWARD** **▶▶▶▶** / **SKIP BACKWARD** **◀◀◀◀** to position the tape to the desired starting position.
6. Press **PLAY ▶▶** to begin playback.

## Continuous Play

1. Press **PRESET UP ▲** on the remote control to enable continuous play. "C" will appear before the counter.
2. Insert cassette tapes into deck 1 and 2.
3. Press **BAND/DECK 1/2** to select the deck to play first.
4. Press **PLAY ▶▶** to begin continuous playback.
5. Press **PRESET DOWN ▼** to disable continuous play.

## Tape Counter

You can keep track of tape position with the tape counter. Press **PROG.** to reset.

## Recording

### From Tuner

1. Insert a tape into deck 1.
2. Press **SOURCE** repeatedly to select **TUNER** and to access the desired radio band.
3. Tune to the station to be recorded.
4. Press **RECORD** to begin recording.
5. Press **STOP ■** to end recording.

### From CD

1. Insert a tape into deck 1.
2. Press **SOURCE** repeatedly to select **CD**.
3. Insert the disc(s) to be recorded.
4. Select the track, CD, or program to be recorded and start playback.
5. Press **RECORD** to begin recording.
6. Press **STOP ■** to end recording.

### Tape to Tape

#### Synchronize Recording

1. Press **BAND/DECK 1/2** to select tape 2.
2. Insert the destination tape in deck 1.
3. Insert the source tape into deck 2.
4. Press **RECORD**. The playback and recording start simultaneously.

#### Normal Recording

1. Press **BAND/DECK 1/2** to select tape 2.
2. Insert the destination tape in deck 1.
3. Insert the source tape into deck 2 and press **PLAY ▶▶** to start playback.
4. Press **RECORD** when ready to record.

### From an Auxiliary Input

1. Insert the cassette in deck 1.
2. Check that the auxiliary device has been connected correctly to the **AUX** connector on the back of the audio system.
3. Start playback on the auxiliary device.
4. Press **RECORD** to begin recording.
5. Press **STOP ■** to end recording.

# Troubleshooting Tips

<b>Problem</b>	<b>Solution</b>	<b>Problem</b>	<b>Solution</b>
<i>System will not turn on</i>	<ul style="list-style-type: none"> <li>• Check power cord for a secure connection.</li> <li>• Unplug the unit for a moment, and then plug into power source again.</li> <li>• Check the outlet by plugging in another device.</li> </ul>	<i>CD button will not respond, or does not change discs when you press DISC SKIP</i>	<ul style="list-style-type: none"> <li>• Switch to another function (TAPE, Tuner) and then back to CD.</li> </ul>
<i>No sound</i>	<ul style="list-style-type: none"> <li>• Increase the volume setting.</li> <li>• Check connection to speakers.</li> <li>• Check that you have selected the appropriate function: CD, TAPE, Tuner.</li> <li>• Make sure mute is off.</li> </ul>	<i>Distorted or noisy tape recordings</i>	<ul style="list-style-type: none"> <li>• Inspect the tape head, clean it if necessary.</li> </ul>
<i>Poor radio reception</i>	<ul style="list-style-type: none"> <li>• Check antenna connection.</li> <li>• Move antenna.</li> <li>• Turn off nearby electrical appliances, such as hair dryer, vacuum cleaner, microwave, fluorescent lights.</li> </ul>	<i>Remote control does not work</i>	<ul style="list-style-type: none"> <li>• Check that the batteries are properly installed.</li> <li>• Replace weak batteries.</li> <li>• Check the system is plugged into power source.</li> <li>• Point the remote directly at the system's front panel.</li> <li>• Move closer to the system.</li> <li>• Remove any obstacles between the remote and the system.</li> </ul>
<i>CD does not play</i>	<ul style="list-style-type: none"> <li>• Check that CD is in the tray.</li> <li>• Check that CD label is facing up.</li> <li>• Check that PAUSE mode is not on.</li> <li>• Check that CD function is selected.</li> <li>• Use CD lens cleaner.</li> <li>• Clean the disc.</li> </ul>		
<i>CD sound skips</i>	<ul style="list-style-type: none"> <li>• Clean the disc.</li> <li>• Check disc for warping, scratches, or other damage.</li> <li>• Check if something is causing the system to vibrate. If so, move the system.</li> <li>• Make sure the speakers are at least 3 feet away or on a different surface from the main unit.</li> </ul>		

# Maintenance

EN

Disconnect the audio system from the power source before performing any maintenance.

## Cleaning

Clean the exterior of the system using a soft dust cloth.

## CD Player

**CAUTION!** This system operates with a laser. It must be opened by only a qualified technician.

## Tape Player

To prevent deterioration of sound quality, periodically open the door of each deck and clean the magnetic heads, pinch roller, and capstan with a cotton bud dipped in alcohol. Also, demagnetize the head by playing a demagnetizing cassette (available through an audio equipment store).

To protect recordings on one or both sides of a tape, remove the corresponding tab. If you later want to record on the tape, affix a piece of adhesive tape over the hole.

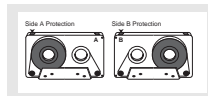

Quit Slacking - A little bit of slack in your tapes can cause scratches on the tape, or worse yet, the tape could break. If you notice some slack in the tape, use a pencil to tighten it up before you insert it.

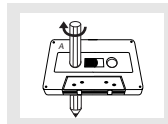

## Handling CDs

- Do not touch the signal surfaces. Hold CDs by the edges, or by one edge and the hole. Do not affix labels or adhesive tapes to the label surfaces. Do not scratch or damage the label. CDs rotate at high speeds inside the player. Do not use damaged (cracked or warped) CDs

## Cleaning CDs

- Dirty CDs can cause poor sound quality. Always keep CDs clean by wiping them gently with a soft cloth from the inner edge toward the outer perimeter.
- If a CD becomes dirty, wet a soft cloth in water, wring it out well, wipe the dirt away gently, and then remove any water drops with a dry cloth.
- Do not use record cleaning sprays or antistatic agents on CDs. Also, never clean CDs with benzene, thinner, or other volatile solvents which may cause damage to disc surface

## CD Lens Care

When your CD lens gets dirty it can also cause the system to output poor sound quality. To clean the lens you will need to purchase a CD lens cleaner which can maintain the output sound quality of your system. For instructions on cleaning the CD lens, refer to the ones accompanying the lens cleaner.

# Important Information

## Safety Precautions

- Never open the cabinet under any circumstances. Any repairs or internal adjustments should be made only by a trained technician.
- Never operate this product with the cabinet removed.
- Do not use your System immediately after transporting it from a cold place to a warm place, as condensation may cause the system to malfunction.
- Keep your unit away from humid areas and abnormally hot places.
- Do not touch the player with wet hands. If any liquid enters the player cabinet, take the player to a trained technician for inspection.
- This compact disc player uses a laser to read the music on the disc. The laser mechanism corresponds to the cartridge and stylus of a record player. Although this product incorporates a laser pick-up lens, it is completely safe when operated according to directions.
- Discs rotate at high speed inside the player. Do not use damaged, warped, or cracked discs.
- Do not touch the pick-up lens which is located inside the disc compartment. To keep dust from collecting on the pick-up lens, do not leave the compartment door open for an extended period of time. If the lens becomes dirty, clean it with a soft brush, or use an air blower brush designed for camera lenses.
- To prevent damage to this product, set switch for proper voltage.
- The apparatus shall not be exposed to dripping and splashing.

## Important Battery Information

- Remove the batteries to avoid leakage if you do not use your remote control for more than one month.
- Discard leaky batteries immediately as leaking batteries may cause skin burns or other personal injuries. Dispose of batteries in the proper manner, according to provincial and local regulations.
- Any battery may leak electrolyte under the following circumstances:
  - if mixed with a different battery type,
  - if inserted incorrectly,
  - if all batteries are not replaced at the same time,
  - if disposed of in fire, or
  - if an attempt is made to charge a battery not intended to be recharged.

## Headset Safety

- Do not play your headset at high volume. Hearing experts warn against extended high-volume play.
- If you experience ringing in your ears, reduce volume or discontinue use.
- You should use with extreme caution or temporarily discontinue use in potentially hazardous situations.

Even if your headset is an open-air designed to let you to hear outside sounds, do not turn up the volume so high that you are unable to hear what is around you.

## Don't Infringe

This product should only be used for the purposes for which it is sold, that is, entertainment, violating no copyright law. Any attempts to use this product for which it is not intended is unlawful and therefore not condoned by Thomson multimedia.

## Technical Specification

Power supply: 120V / 240V ~ 60 Hz / 50Hz

Dimensions ( H x W x D inches):

Unit size - 13 x 12 x 15.3

Speaker - 13 x 9.5 x 11

Tape deck: Response curve: 125Hz-8kHz (-5dB)

CD player: Response curve (+/- 2dB): 60Hz to 20 kHz

Rating Plate: Look for it at the back of the set.

The descriptions and characteristics given in this document are given as a general indication and not as a guarantee. In order to provide the highest quality product possible, we reserve the right to make any improvement or modification without prior notice. The English version serves as the final reference on all products and operational details should any discrepancies arise in other languages.

# Limited Warranty (U.S.)

EN

**What your warranty covers:**

- Defects in materials or workmanship.

**For how long after your purchase:**

- One year from date of purchase for labor and parts
- Warranty period for rental units begins with the first rental or 45 days from date of shipment to the rental firm, whichever comes first.

**What we will do:**

- Pay any Authorized RCA Audio Service Center the labor charges to repair your unit.
- Pay any Authorized RCA Audio Service Center for the new or, at our option, refurbished replacement parts required to repair your unit.

**How you get service:**

- Take your unit to any Authorized RCA Audio Service Center. To identify your nearest Authorized RCA Audio Service Center, ask your dealer, look in the Yellow Pages, or call 1-800-336-1900.
- Show the Authorized Service Center Representative your evidence of purchase date or first rental.
- Pick up your unit when repairs are completed.
- Proof of purchase in the form of a bill of sale or receipted invoice which is evidence that the product is within the warranty period must be presented to obtain warranty service. For rental firms, proof of first rental is also required.

**What your warranty does not cover:**

- Customer instruction. (Your Owner's Manual describes how to install, adjust, and operate your unit. Any additional information should be obtained from your dealer.)
- Installation and related adjustments.
- Signal reception problems not caused by your unit.
- Damage from misuse or neglect.
- Cleaning of audio heads.
- Batteries.
- A unit that has been modified or incorporated into other products or is used for institutional or other commercial purposes.
- A unit purchased or serviced outside the U.S.A.
- Acts of nature, such as but not limited to lightning damage.

**Product Registration:**

- Please complete and mail the Product Registration Card packed with your product. It will make it easier to contact you should it ever be necessary. The return of the card is not required for warranty coverage.



## Limited Warranty (U.S.)

### Limitation of Warranty:

- **THE WARRANTY STATED ABOVE IS THE ONLY WARRANTY APPLICABLE TO THIS PRODUCT. ALL OTHER WARRANTIES, EXPRESS OR IMPLIED (INCLUDING ALL IMPLIED WARRANTIES OF MERCHANTABILITY OR FITNESS FOR A PARTICULAR PURPOSE) ARE HEREBY DISCLAIMED. NO VERBAL OR WRITTEN INFORMATION GIVEN BY THOMSON MULTIMEDIA INC., ITS AGENTS OR EMPLOYEES SHALL CREATE A WARRANTY OR IN ANY WAY INCREASE THE SCOPE OF THIS WARRANTY.**
- **REPAIR OR REPLACEMENT AS PROVIDED UNDER THIS WARRANTY IS THE EXCLUSIVE REMEDY OF THE CONSUMER. THOMSON MULTIMEDIA INC. SHALL NOT BE LIABLE FOR INCIDENTAL OR CONSEQUENTIAL DAMAGES RESULTING FROM THE USE OF THIS PRODUCT OR ARISING OUT OF ANY BREACH OF ANY EXPRESS OR IMPLIED WARRANTY ON THIS PRODUCT. THIS DISCLAIMER OF WARRANTIES AND LIMITED WARRANTY ARE GOVERNED BY THE LAWS OF THE STATE OF INDIANA. EXCEPT TO THE EXTENT PROHIBITED BY APPLICABLE LAW, ANY IMPLIED WARRANTY OF MERCHANTABILITY OR FITNESS FOR A PARTICULAR PURPOSE ON THIS PRODUCT IS LIMITED TO THE APPLICABLE WARRANTY PERIOD SET FORTH ABOVE.**

### How State Law relates to warranty:

- Some states do not allow the exclusion nor limitation of incidental or consequential damages, or limitations on how long an implied warranty lasts, so the above limitations or exclusions may not apply to you.
- This warranty gives you specific legal rights, and you also may have other rights that vary from state to state.

### If you purchased your unit outside the United States:

- This warranty does not apply. Contact your dealer for warranty information.

**Service calls which do not involve defective materials or workmanship are not covered by this warranty. Costs of such service calls are the sole responsibility of the purchaser.**

# Limited Warranty (Canada)

EN

**What your warranty covers:**

- Defects in materials or workmanship.

**For how long after your purchase:**

- One year from date of purchase for labor and parts
- The warranty period for rental units begins with the first rental or 45 days from date of shipment to the rental firm, whichever comes first.

**What we will do:**

- Pay any Authorized RCA Audio Service Center the labor charges to repair your unit.
- Pay any Authorized RCA Audio Service Center for the new or, at our option, refurbished replacement parts required to repair your unit.

**How you get service:**

- Take your unit to any Authorized RCA Audio Service Center. To identify your nearest Authorized RCA Audio Service Center, ask your dealer, look in the Yellow Pages, or call 1-800-336-1900.
- Show the Authorized Service Center Representative your evidence of purchase date or first rental.
- Pick up your unit when repairs are completed.
- Proof of purchase in the form of a bill of sale or receipted invoice which is evidence that the product is within the warranty period must be presented to obtain warranty service. For rental firms, proof of first rental is also required.

**What your warranty does not cover:**

- Customer instruction. (Your Owner's Manual describes how to install, adjust, and operate your unit. Any additional information should be obtained from your dealer.)
- Installation and related adjustments.
- Signal reception problems not caused by your unit.
- Damage from misuse or neglect.
- Cleaning of audio heads.
- Batteries.
- A unit that has been modified or incorporated into other products or is used for institutional or other commercial purposes.
- A unit purchased or serviced outside Canada.
- Acts of nature, such as but not limited to lightning damage.

**Product Registration:**

- Please complete and mail the Product Registration Card packed with your product. It will make it easier to contact you should it ever be necessary. The return of the card is not required for warranty coverage.

## Limited Warranty (Canada)

### Limitation of Warranty:

- **THE WARRANTY STATED ABOVE IS THE ONLY WARRANTY APPLICABLE TO THIS PRODUCT. NO VERBAL OR WRITTEN INFORMATION GIVEN BY THOMSON MULTIMEDIA LTD., ITS AGENTS OR EMPLOYEES SHALL CREATE A GUARANTY OR IN ANY WAY INCREASE THE SCOPE OF THIS WARRANTY.**
- **REPAIR OR REPLACEMENT AS PROVIDED UNDER THIS WARRANTY IS THE EXCLUSIVE REMEDY OF THE CONSUMER. THOMSON MULTIMEDIA LTD. SHALL NOT BE LIABLE FOR INCIDENTAL OR CONSEQUENTIAL DAMAGES RESULTING FROM THE USE OF THIS PRODUCT. EXCEPT TO THE EXTENT PROHIBITED BY APPLICABLE PROVINCIAL LAW, ANY IMPLIED WARRANTY OF MERCHANTABILITY OR FITNESS FOR A PARTICULAR PURPOSE ON THIS PRODUCT IS LIMITED TO THE APPLICABLE WARRANTY PERIOD SET FORTH ABOVE.**

### How Provincial Laws relates to warranty:

- This warranty gives you specific legal rights which are in addition to statutory warranties that may vary from Province to Province.

### If you purchased your unit outside Canada:

- This warranty does not apply. Contact your dealer for warranty information.

**Service calls which do not involve defective materials or workmanship are not covered by this warranty. Costs of such service calls are the sole responsibility of the purchaser.**

## Free Manuals Download Website

<http://myh66.com>

<http://usermanuals.us>

<http://www.somanuals.com>

<http://www.4manuals.cc>

<http://www.manual-lib.com>

<http://www.404manual.com>

<http://www.luxmanual.com>

<http://aubethermostatmanual.com>

Golf course search by state

<http://golfingnear.com>

Email search by domain

<http://emailbydomain.com>

Auto manuals search

<http://auto.somanuals.com>

TV manuals search

<http://tv.somanuals.com>