

Thank you for choosing the RCA MAF85BKR Universal Flat Panel TV Wall Mount. This mount can be used for all major brands of 37" - 60" flat panel TVs, 165 lbs (75 kg) or under. This wall mount features a 0-15-degree tilt for easy viewing. Before attempting to mount your television set, please remove all parts from this package and read the installation instructions carefully.

WARNING: Use of this mount with a TV weighing over 165 lbs. or with a screen larger than 60" could cause the mount to fail causing property damage and/or personal injury.

CAUTION:

This wall mount is intended for use only with the maximum weight of 75 kg/165 lbs. Use with heavier than the maximum weights indicated may result in instability causing possible injury. Follow the installation and operation instructions carefully.

Safety precautions

Follow these precautions to ensure safe installation and mounting of your flat panel TV.

1. Read these instructions carefully before you begin. If you are unsure of any part of the process, contact a professional contractor or installer for assistance. Improper installation can result in injury or damage.
2. The wall or mounting surface must be capable of supporting the combined weight of the mount and the display; if not, the structure must be reinforced.
3. Safety gear and proper tools must be used. Failure to do so can result in injury and/or damage. A minimum of two people are required for installation. Do not attempt to install this mount alone under any circumstances.
4. Follow all instructions and recommendations regarding adequate ventilation and suitable locations for mounting your display. Consult the owner's manual for your particular display for more information.
5. **For drywall installation, it is essential for the wall mount plate to be attached to wall studs.** (Use a stud finder.)
6. Use the included hardware for mounting purposes. This hardware has been provided to ensure a safe and secure mount.
7. Hire a licensed electrician to relocate an electrical outlet, if needed.
8. Be sure to purchase wires long enough to connect the TV to the audio and video components in your installation.

Keep your sales receipt to obtain warranty parts and service and for proof of purchase. Attach it here and record the model number. This number is located on the product.

Model No. _____

Purchase Date _____

Dealer/Address/Phone _____

Preparing to install

Before beginning the installation process, verify that you have all the necessary tools on hand. The following tools are required for proper installation:

Tools

- Phillips Head Screwdriver
- Ratchet or Driver with 13 mm (1/2") Socket
- Electric or Portable Drill
- 3/16" (4.8mm) Drill Bit and Stud Finder for Drywall Installation
- 3/8" (10mm) Masonry Bit for Concrete Installation

Package Contents

- Wall Plate (x1)
- Mount Arm (x2)
- Tilt Adjustment Rod (x1)
- Safety Bar (x1)
- Instruction Manual (x1)
- Hardware Kit (x1)

Pour des instructions en français, se reporter à la page 6.

Para obtener instrucciones en español, consulte la página 11.

Continues on next page...

Hardware Kit

(A) M8 x 63 Lag Bolt (x6)



(B) Lag Bolt Washer (x6)



(C) Concrete Anchor (x6)



(D) M6 x 12 Bolt (x4)



(E) M6 x 30 Bolt (x4)



(F) M8 x 12 Bolt (x4)



(G) M8 x 30 Bolt (x4)



(H) M6 Washer (x4)



(I) Spacer (x8)



(J) 3/16" Drill bit

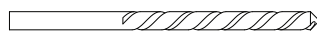

Mounting the wall plate

Drywall Installation

Important! For safety reasons, this mount must be secured to at least two wood studs no less than 16" apart. For displays heavier than 50 kg (110 lbs), three studs are recommended. The studs must be capable of supporting the combined weight of the mount and display.

1. Use a high quality stud finder to locate two or more adjacent studs where you wish to install your mount. Mark both edges of each stud to help identify the exact center.

NOTE: You must use the center of each stud to avoid cracking or splitting the wood during installation.

2. Place the wall plate against the wall and level it using the integrated bubble level.

3. While another person holds the wall plate in position, mark four or six locations (two per stud) for securing the mount to the wall (see Fig.1).

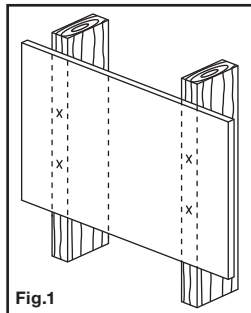

Fig.1

4. Set the wall plate aside and drill a 3/16" pilot hole at each marked location.
5. Place the wall plate back against the wall and attach it using the lag bolts (A) and lag bolt washers (B) (see Fig. 2). **Do not over-tighten these bolts and do not release the wall plate until all bolts are in place.** Ensure that the wall plate remains level after all bolts are secured.

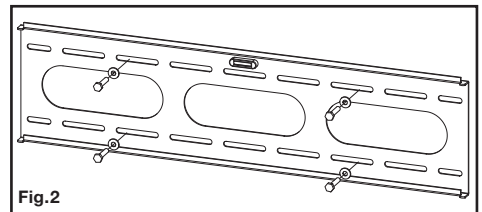

Fig.2

Concrete/Brick Installation

IMPORTANT! For safety reasons, the concrete wall must be capable of supporting the combined weight of the mount and the display. The manufacturer takes no responsibility for failure caused by walls of insufficient strength.

1. Place the wall plate against the wall in the desired location and level it using the integrated bubble level.
2. While another person holds the wall plate in place, mark six evenly spaced locations on the wall for securing the mount (see Fig. 3).
3. Set the wall plate aside and drill a 10 mm (3/8") hole at each marked location. Remove any excess dust from the holes.

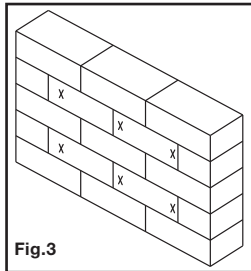

Fig.3

4. Insert a Concrete Anchor (C) into each hole so that it is flush with the concrete surface (see Fig. 4). A hammer can be used to lightly tap the anchors into place if necessary.

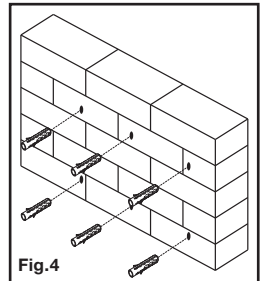

Fig.4

5. Place the wall plate back against the wall and attach it using the lag bolts (A) and lag bolt washers (B) (see Fig. 2). Do not over-tighten these bolts and do not release the wall plate until all bolts are in place. Ensure that the wall plate remains level after all bolts are secured.

Attaching the Arms to the TV

IMPORTANT! Use extra care during this part of the installation. If possible, avoid placing your display facedown as it may damage the viewing surface.

NOTE: This mount comes with a selection of different screw diameters and lengths to accommodate a wide variety of display models. Not all of the hardware in the kit will be used.

1. Determine the correct **length** of screw to use by examining the back of your display:
 - A. If the back of your display is flat and the mounting holes are flush with the surface, you will use the shorter screws (D or F) from the hardware kit.
 - B. If the back of your display is curved, has a protrusion, or if the mounting holes are recessed, you will need to use the longer screws (E or G) and spacers (I).
2. Determine the correct **diameter** of screw to use by carefully trying one of each size (M6 and M8) from the hardware kit. **Do not force any of the screws – if you feel resistance stop immediately and try a smaller diameter screw.**
3. Find the tilt adjustment rod and remove one the tilt adjustment knobs using a screwdriver (see Fig.5). Place the knob and screw in a safe location.
4. Pass the tilt adjustment rod through both arms as shown in Fig.6. Make sure the long part of the tilt adjustment knob faces downwards, exactly as shown. Replace the missing tilt adjustment knob using a screwdriver. The final assembly should match Fig.7.



Fig.5

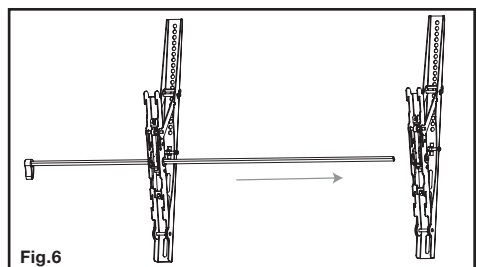
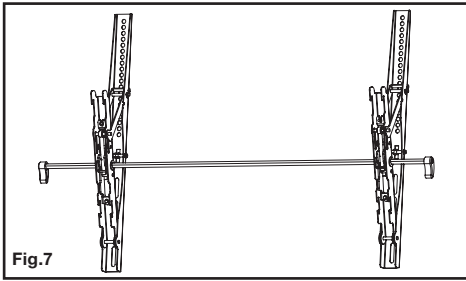

Fig.6

Continues on next page...



7. Attach the mount arms to the back of your display using the screws identified in Steps 1 and 2 (see Fig.11):

- A. If you are using the M6 screws you will also need to use the M6 washers (H). M8 screws do not require washers.
- B. If you are using the longer screws on a display with a curved or recessed back, you will also need to use the spacers (I). Use one spacer or two spacers stacked as needed. **You should only use a spacer if necessary.**

5. Remove the clips located towards the top of each arm and take out the pins (see Fig.8). Then push down and hold both tilt adjustment rod knobs simultaneously. Lift both sides of the rod together and open both arms completely as shown in Fig.9.

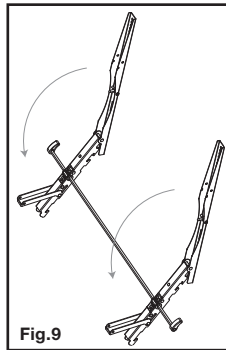
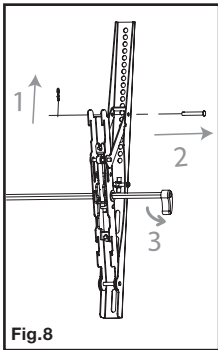
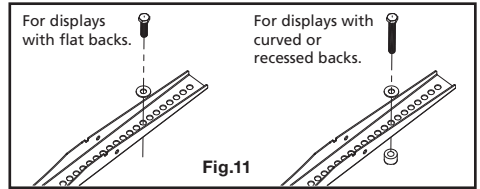

8. Close the mount arms by returning them to the original position. Insert the pin and replace the clip on both arms (see Fig.12). Make sure the tilt adjustment rod is turned to the locked position by rotating the knobs away from the display. **The mount arms must be fully closed and locked before moving on to the next part.**

6. Place the opened arms over the back of your display. Adjust the arms along the length of the tilt adjustment rod so that they line up with the mounting holes on back of your display. The hinges on the arms should be located towards the bottom of the display (see Fig.10).

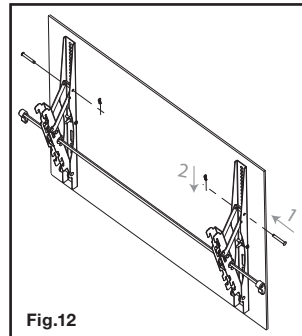
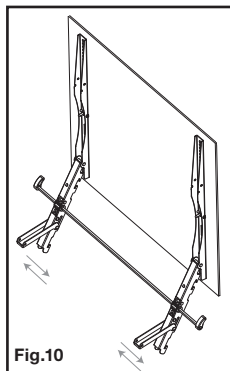

Final Installation

1. With the help of another person, carefully lift your display and place it on the wall plate. Do not release the display until the mount arms have securely hooked onto the wall plate.
2. Insert the safety bar at the bottom of the mount to prevent the display from being lifted from the wall plate. A padlock can be inserted into the end of the bar to help prevent theft of your display (see Fig.13).

IMPORTANT! The safety bar must be used at all times to prevent the display from being accidentally knocked from the mount.

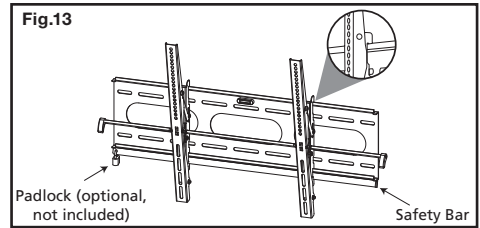

Operation and Adjustment

To change the tilt angle of your display: Hold the display firmly with one hand and rotate one of the tilt adjustment knobs towards the display to unlock the tilt. Carefully move the display to the desired position and return the knob to its original position to lock it in place. **Do not release the display until the tilt is locked in place.**

Periodically clean your mount with a dry cloth. Inspect all screws and hardware at regular intervals to ensure that no connections have become loose over time. Re-tighten as necessary.

Specifications

Display Size:	37" to 60"
Maximum Load:	75 kg (165 lbs)
Universal VESA Mounting Pattern:	800 mm x 500 mm (31.5" x 19.7") max
Tilt Range:	15° down
Profile:	4.5 cm (1.8")

Limited Lifetime Warranty

Audiovox Electronics Corporation (the "Company") warrants to you the original retail purchaser of this product that should it, under normal use and conditions, be proven defective in material or workmanship during its lifetime while you own it, such defect(s) will be repaired or replaced (at the Company's option) without charge for parts and repair labor.

To obtain repair or replacement within the terms of this Warranty, the product is to be delivered with proof of warranty coverage (e.g. dated bill of sale), specification of defect(s), transportation prepaid, to the Company at the address shown below. Do not return this product to the Retailer.

This Warranty does not cover product purchased, serviced or used outside the United States or Canada.

This Warranty is not transferable and does not extend to costs incurred for installation, removal or reinstallation of the product. This Warranty does not apply if in the Company's opinion, the product has been damaged through alteration, improper installation, mishandling, misuse, neglect, or accident.

THE EXTENT OF THE COMPANY'S LIABILITY UNDER THIS WARRANTY IS LIMITED TO THE REPAIR OR REPLACEMENT PROVIDED ABOVE AND, IN NO EVENT, SHALL THE COMPANY'S LIABILITY EXCEED THE PURCHASE PRICE PAID BY PURCHASER FOR THE PRODUCT.

This Warranty is in lieu of all other express warranties or liabilities. ANY IMPLIED WARRANTIES, INCLUDING ANY IMPLIED WARRANTY OF MERCHANTABILITY OR FITNESS FOR A PARTICULAR PURPOSE SHALL BE LIMITED TO DURATION OF THIS WARRANTY. IN NO CASE SHALL THE COMPANY BE LIABLE FOR ANY CONSEQUENTIAL OR INCIDENTAL DAMAGES WHATSOEVER. No person or representative is authorized to assume for the Company any liability other than expressed herein in connection with the sale of this product.

Some states/provinces do not allow limitations on how long an implied warranty lasts or the exclusion or limitation of incidental or consequential damage so the above limitations or exclusions may not apply to you. This Warranty gives you specific legal rights and you may also have other rights which vary from state/province to state/province.

U.S.A.: Audiovox Electronics Corporation, 150 Marcus Blvd., Hauppauge, New York 11788

CANADA: Audiovox Return Center, c/o Genco, 6685 Kennedy Road, Unit 3, Door 16, Mississauga, Ontario L5T 3A5

Garantie à vie limitée

Audiovox Electronics Corporation (l'« Entreprise ») vous garantit en tant qu'acheteur de détail d'origine du présent produit que, s'il présente des défauts de matière ou de fabrication dans des conditions d'utilisation normales pendant sa durée de vie alors que vous en êtes propriétaire, ce/ces défaut(s) feront l'objet d'une réparation ou d'un remplacement (à la discrétion de l'Entreprise) sans frais pour les pièces et pour les heures de main-d'œuvre.

Pour obtenir une réparation ou un remplacement en vertu des termes de la présente garantie, le produit doit être livré à l'Entreprise avec preuve de couverture de garantie (c'est-à-dire une preuve d'achat datée), une description du ou des défauts, et les frais de transport payés d'avance, à l'adresse indiquée ci-dessous. Ne pas retourner ce produit chez le détaillant.

La présente garantie ne couvre pas de produit acheté, réparé ou utilisé à l'extérieur des États-Unis ou du Canada.

La présente garantie ne peut pas être transférée et ne couvre pas les frais encourus pour l'installation, l'enlèvement ou la réinstallation du produit. La présente garantie ne s'applique pas si, selon l'avis de l'Entreprise, le produit a été endommagé suite à une modification, une installation incorrecte, une manipulation incorrecte, une mauvaise utilisation, une négligence ou un accident.

L'ÉTENDUE DE LA RESPONSABILITÉ DE L'ENTREPRISE EN VERTU DE LA PRÉSENTE GARANTIE EST LIMITÉE À LA RÉPARATION OU AU REMPLACEMENT INDIQUÉS CI-DESSUS ET, EN AUCUN CAS, LA RESPONSABILITÉ DE L'ENTREPRISE NE PEUT DÉPASSER LE PRIX D'ACHAT PAYÉ PAR L'ACHETEUR POUR LE PRODUIT.

Cette garantie remplace toute autre garantie ou responsabilité expresse. TOUTE GARANTIE IMPLICITE, INCLUANT TOUTE GARANTIE IMPLICITE DE QUALITÉ MARCHANDE OU D'ADAPTATION À UN USAGE PARTICULIER EST LIMITÉE À LA DURÉE DE LA PRÉSENTE GARANTIE. EN AUCUN CAS L'ENTREPRISE NE PEUT ÊTRE RESPONSABLE POUR UN QUELCONQUE DOMMAGE CONSÉCUTIF OU INDIRECT. Aucune personne ou aucun représentant n'est autorisé à assumer pour l'entreprise une quelconque responsabilité autre que celle exprimée dans les présentes en relation avec la vente de ce produit.

Certaines juridictions n'autorisent pas de limites quant à la durée d'une garantie implicite ou quant à l'exclusion ou la limitation de dommages indirects ou consécutifs; les limitations et exclusions indiquées dans les présentes pourraient donc ne pas s'appliquer à votre cas. Cette garantie vous donne des droits légaux spécifiques et vous pourriez également jouir d'autres droits qui varient d'une juridiction à l'autre.

E-U : Audiovox Electronics Corporation, 150 Marcus Blvd., Hauppauge, New York 11788

CANADA : Audiovox Return Center, c/o Genco, 6685 Kennedy Road, Unit 3, Door 16, Mississauga, Ontario L5T 3A5

Garantía Limitada Durante la Vida Útil del Producto

Audiovox Electronics Corporation (la "Compañía") le garantiza a usted, el comprador original de este producto que si, bajo condiciones y uso normales, se encontrara que presenta defectos materiales o de mano de obra durante su vida útil mientras sea de su propiedad, tales defectos serán reparados o reemplazados (a opción de la Compañía) sin cargo alguno por las piezas y labores de reparación.

Para obtener los servicios de reparación o reemplazo dentro de los términos de esta Garantía, el producto se entregará con prueba de cubierta de garantía (por ejemplo, factura fechada de venta), especificación de los defectos, transporte prepago, a la Compañía a la dirección indicada abajo. No devuelva este producto al Distribuidor.

Esta Garantía no cubre un producto adquirido, mantenido o utilizado fuera de los Estados Unidos o Canadá.

Esta Garantía no es transferible y no incluye los costos incurridos en la instalación, remoción o reinstalación de este producto. Esta Garantía no aplica si, es opinión de la Compañía que, este producto ha sufrido daños debido a alteraciones, instalación inadecuada, abuso, uso indebido, negligencia o accidente.

EL ALCANCE DE LA RESPONSABILIDAD DE LA COMPAÑÍA BAJO ESTA GARANTÍA ESTÁ LIMITADO A LA REPARACIÓN O EL REEMPLAZO PREVISTO ARRIBA Y, EN NINGÚN CASO, DEBERÁ LA RESPONSABILIDAD DE LA COMPAÑÍA EXCEDER EL PRECIO DE COMPRA PAGADO POR EL COMPRADOR DE ESTE PRODUCTO.

Esta Garantía reemplaza cualesquiera otras responsabilidades o garantías expresas. CUALESQUIERA GARANTÍAS IMPLÍCITAS, INCLUYENDO CUALQUIER GARANTÍA IMPLÍCITA DE COMERCIABILIDAD O ADAPTABILIDAD PARA UN PROPÓSITO EN PARTICULAR ESTARÁN LIMITADAS A LA DURACIÓN DE ESTA GARANTÍA. EN NINGÚN CASO LA COMPAÑÍA SERÁ RESPONSABLE POR DAÑOS EMERGENTES O INCIDENTALES. Ninguna persona ni representante está autorizado a asumir, a nombre de la Compañía, ninguna responsabilidad salvo la expresada aquí en conexión con la venta de este producto.

Algunos estados/provincias no permiten limitaciones sobre la duración de una garantía implícita o la exclusión o la limitación de daños incidentales o emergentes, de modo que es posible que las limitaciones o exclusiones anteriores no apliquen en su caso. Esta Garantía le confiere derechos legales específicos; según el estado/provincia, puede disfrutar además de otros derechos.

EE.UU.: Audiovox Electronics Corporation, 150 Marcus Blvd., Hauppauge, New York 11788

CANADÁ:: Audiovox Return Center, c/o Genco, 6685 Kennedy Road, Unit 3, Door 16, Mississauga, Ontario L5T 3A5

© 2010 Audiovox Accessories Corporation

Trademark(s) Registered, Marques Déposées, Marcas Registradas.

All other brands and product names are trademarks or registered trademarks of their respective owners. / Toutes les autres marques et tous les autres noms de produits sont des marques de commerce ou des marques de commerce déposées de leurs propriétaires respectifs. / Todas las demás marcas y nombres de productos son marcas comerciales o marcas comerciales registradas de sus respectivos dueños.

www.rcaaccessories.com

MAF85BKR_US_IB_02

Download from www.Somanuals.com. All Manuals Search And Download.

Free Manuals Download Website

<http://myh66.com>

<http://usermanuals.us>

<http://www.somanuals.com>

<http://www.4manuals.cc>

<http://www.manual-lib.com>

<http://www.404manual.com>

<http://www.luxmanual.com>

<http://aubethermostatmanual.com>

Golf course search by state

<http://golfingnear.com>

Email search by domain

<http://emailbydomain.com>

Auto manuals search

<http://auto.somanuals.com>

TV manuals search

<http://tv.somanuals.com>