

RBA27500, RCA27000

USER'S GUIDE

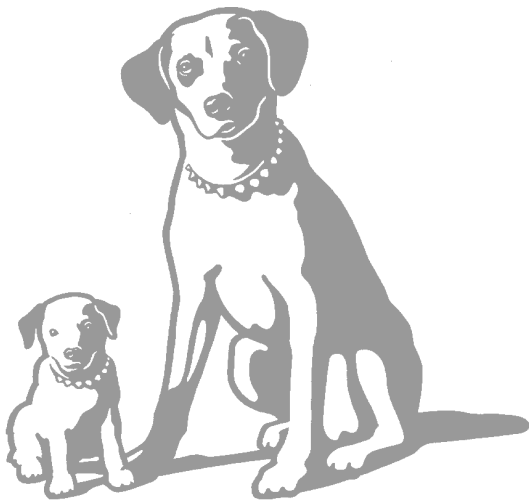

It is important to read this manual before
operating this unit for the first time.

TOCOM 1512890A

TRISTAR

COLOR TV

Important Information

WARNING

To reduce the risk of fire or shock hazard, do not expose this product to rain or moisture.

WARNING

RISK OF ELECTRIC SHOCK
DO NOT OPEN

TO REDUCE THE RISK OF ELECTRIC SHOCK, DO NOT REMOVE COVER (OR BACK). NO USER SERVICEABLE PARTS INSIDE. REFER SERVICING TO QUALIFIED SERVICE PERSONNEL.



This symbol indicates “dangerous voltage” inside the product that presents a risk of electric shock or personal injury.



This symbol indicates important instructions accompanying the product.

Refer to the identification/rating label located on the back panel of your product for its proper operating voltage.

Cautions

Caution: To reduce the risk of electric shock, fully insert plug into socket. Insure that the main supply in your house complies with that indicated on the identification label located on the back of the TV Receiver.

Caution: If fixed (non-moving) images are left on the screen for long periods, they maybe permanently imprinted on the screen. Such images include network logos, phone numbers, and video games. Extended viewing of channels displaying these images should be avoided.

Table of Contents

Important Information	Warning, Product Registration _____	i
Quick Guide to Your TV	Startup _____	2-3
	Hook up your TV, Plug in the TV, Put Batteries in the Remote, Turn on the TV, Place Channels in Memory, Set the Time	
	Basic Tour of the Remote _____	4
	Power, Volume, Channel, Components buttons	
	Menu Basics _____	5
	Colors, Menu Buttons, Moving through the Menu	
Using Your Remote	With Remote Buttons _____	6-7
	With VCRs _____	8-10
	Programming, setting the VCR 1 Channel, Basic Operation	
	With a Satellite Receiver _____	11
	With a Cable Box _____	12-13
	With a Laserdisc Player _____	14
	With Audio Equipment _____	15
Adjusting Your TV	Overall Picture _____	16
	Picture Settings _____	17
	Color, Tint, Brightness, Sharpness, Autocolor, Picture Reset	
	Sound Settings _____	18
	Stereo, Tone	
Using Advanced Features	Placing Channels in Memory/Autoprogram _____	19
	Naming the Channels _____	20
	Setting the Sleep Timer _____	21
	Setting the Alarm Clock _____	22
	Selecting a Language _____	23
	Watching Closed Captioning _____	23
	Setting Your TV for Antenna or Cable _____	24
References	Front Panel Buttons _____	25
	Displays on the Screen _____	26
	Trouble Checks _____	27-28
	Index _____	29

Quick Guide to Your TV

Startup

The steps below will get your TV connected and ready for watching.
For more details, see the page numbers listed.

1. Hook up your TV

Details are in the
Connections Guide.

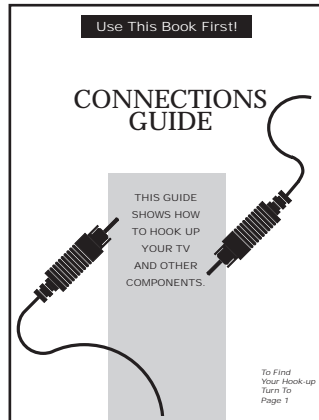

Hook up any antennas, cables or other equipment to your TV before you follow the steps below. This is where to find the instructions for SVHS, a super VHS recording format that improves the picture quality. It is found on some VCRs and camcorders.

CAUTION: If you choose not to use the stand recommended for your TV, take precautions that the stand or furniture the TV is placed on is properly located and of adequate size and strength to prevent the TV from accidentally being tipped over, pulled off, or pushed off. This could cause damage to the TV and/or personal injury.

2. Plug in the TV

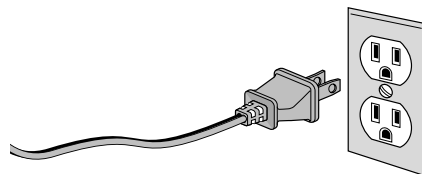

Plug the cord into the outlet, matching the wide and the small end of the plug with the outlet.

2a. Use this adaptor for models RBA27550 and RCA27000

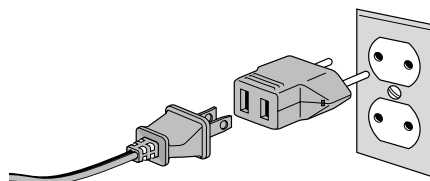

- Plug the cord into the adapter that was packed with your TV as shown at the left.
- Plug the adapter into the outlet, matching the prongs with the outlet.

3. Put batteries in the remote

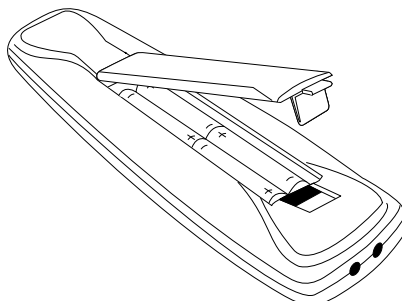

- Pull off the cover of the battery compartment.
- Place the four AAA batteries as shown, matching the + and - end of each battery in the compartment.
- Replace the cover.

Quick Guide to Your TV

Startup

4. Turn on the TV

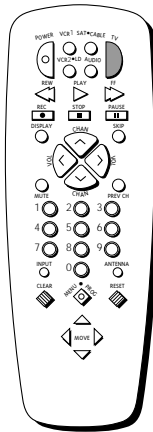

Press POWER on the remote.

OR

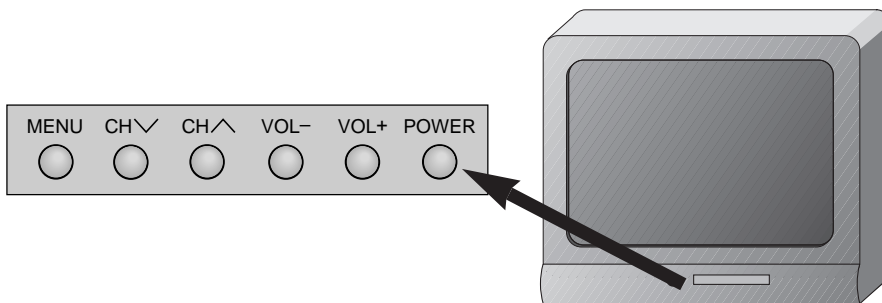

Press POWER on the TV.

5. Place all available channels in memory (Autoprogram)

Details for adding and deleting channels are on page 19.



- A. Press MENU•PROG until the Setup menu is selected. This menu is white.
- B. Press MOVE ▼ to highlight Autoprogram.
- C. Press MOVE ► to start placing channels in the TV's memory.
- D. Wait until TV has cycled through all the channels and returns to original channel.

6. Set the time

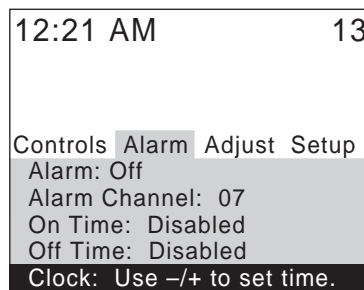

- A. Press MENU•PROG until the Alarm menu is selected. This menu is green.
- B. The Clock is automatically highlighted the first time you set it. If it is not, press MOVE ▼ to highlight it.
- C. Press MOVE ◀ to set the hour.
- D. Press MOVE ▶ to set the minutes.

Quick Guide to Your TV

Basic Tour of the Remote

Basic information about your remote is shown below. This will give you a general idea of how your remote works. *For more details, see pages 6–15.*

TV Power Button

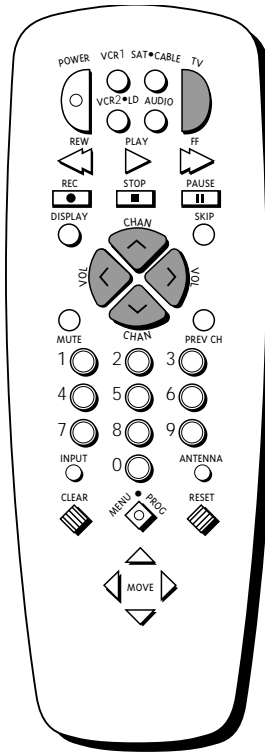

Turns the TV on.

Sets the remote to control the TV.

Volume and Channel Controls

Details are on page 6.

Operates TV when remote is set to control the TV.

Operates the TV and advanced features.

Component Buttons

Details are on pages 8–15.

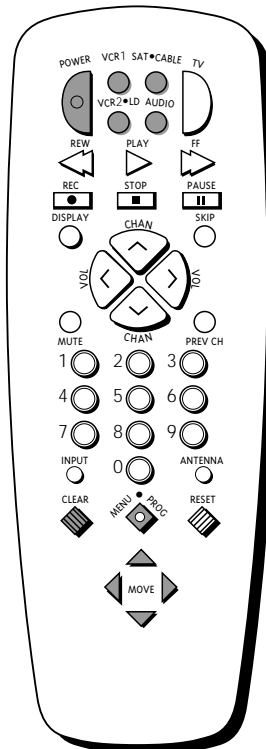

Controls components such as a VCR, laserdisc player, audio equipment, satellite receiver and a cable box.

Menu Buttons

See next page for details.

Changes the menus and features on the screen.

Quick Guide to Your TV

Menu Basics

General information about using the on-screen menu system is shown below. *Details on using the remote buttons are on pages 6-7. Many menu items are explained in detail in Using the Advanced Features starting on page 19.*

Colors

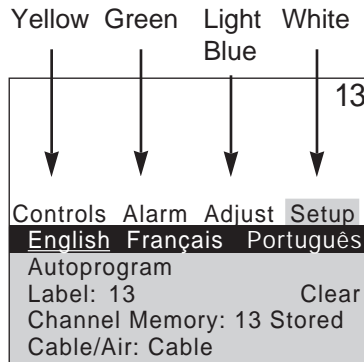

Press MENU•PROG repeatedly to see each of the four menu colors.

Each menu has a different color background as shown at the left.

Menu Buttons

The menu buttons are used to adjust the features in the TV's menus. Both the menu buttons on the remote or the front of the TV will move through the menus. See "Moving through the Menus" below.

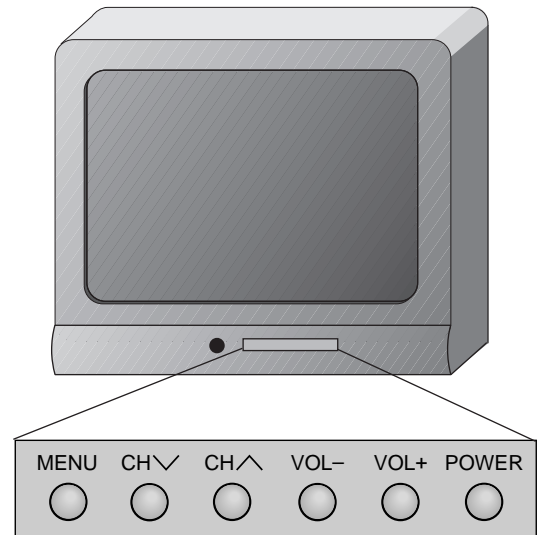
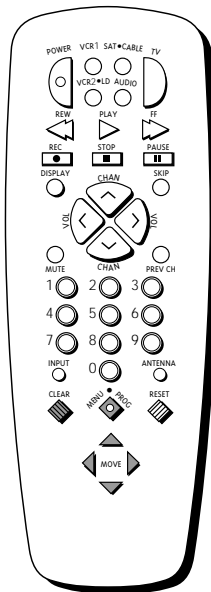

Moving through the Menus



1. Press MENU•PROG on the remote or MENU on the front panel to move from menu to menu.
2. Press MOVE ▲ and ▼ on the remote or CHANNEL up or down on the front panel to move up and down through the features in the menu.
3. Press MOVE ◀ and ▶ on the remote or VOLUME + or - on the front panel to move left and right on the menu lines.

Using Your TV and Remote

With Remote Buttons

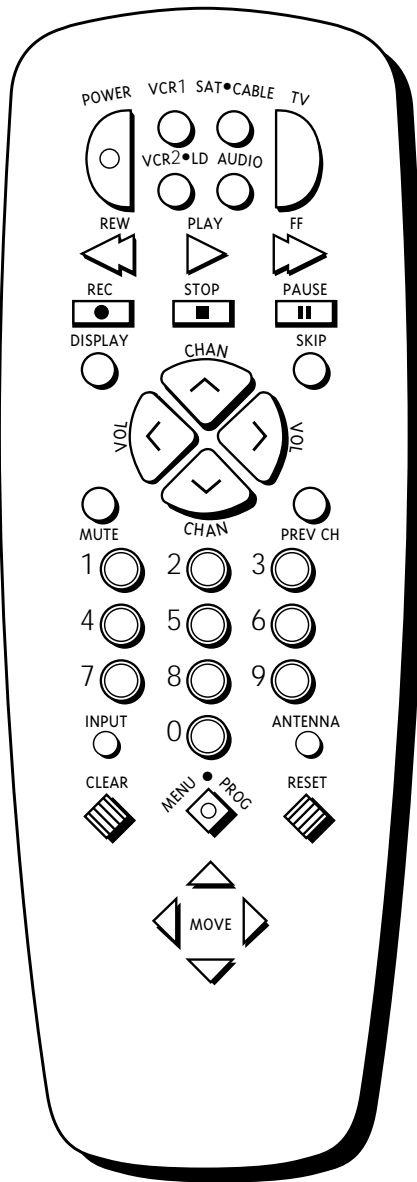

POWER

Turns off the TV.

Turns off compatible components.

Turns on a component after a component button is pressed.

AUDIO, VCR1, VCR2•LD, SAT•CABLE, TV

Sets the remote to control the component. VCR2•LD can only be programmed for one component: either a VCR or a Laserdisc Player.

See Using the Remote with a VCR, Satellite Receiver, Cable Box, Laserdisc Player and Audio equipment on pages 8–15.

TV

Turns on the TV.

Shows the displays on the screen.

Sets the remote to control the TV.

See Using the Remote with a VCR, Satellite Receiver, Cable Box, Laserdisc Player and Audio equipment on pages 8–15.

REW (Rewind)

Rewinds a tape or laserdisc.

Searches backward while tape or laserdisc is playing.

PLAY

Plays tape or laserdisc.

FF (Fast Forward)

Fast forwards a tape or laserdisc.

Searches forward while tape or laserdisc is playing.

REC (Record)

Starts recording onto tape.

STOP

Stops tape or laserdisc.

PAUSE

Pauses tape or laserdisc.

DISPLAY

Shows displays on the screen.

Clears menus from the screen.

SKIP (Commercial Skip)

Allows you to scan other channels during commercials.

Each press adds 30 seconds. TV switches back to original channel when time runs out. Press CLEAR to cancel SKIP.

CHAN ^ and v

(Channel up and down)

Scans up and down through channels in the TV's memory.

Moves through channels in VCR's memory.

VOL > and <

(Volume up and down)

Raises and lowers sound.

MUTE

Switches the TV sound on or off.

PREV CH (Previous Channel)

Changes back and forth between two channels.

Select a channel and then select another. Press PREV CH to switch between the two channels.

Using Your TV and Remote

With Remote Buttons

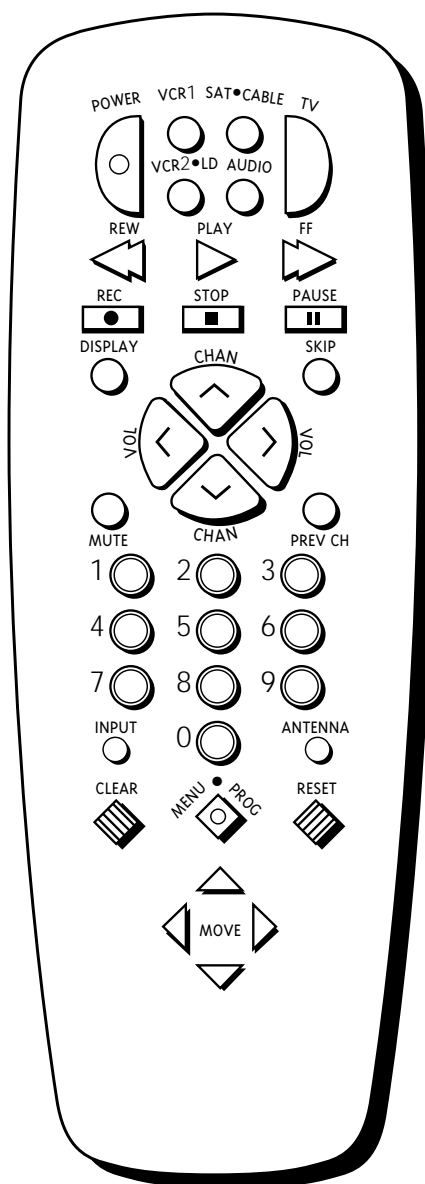

Number Buttons (0-9)

Selects any channel number.

Two numbers must be pressed for each channel. Press 0 and 6 for channel 6. For three digit channels, press and hold 1 until 1-- appears on the screen. Then press the other two numbers.

INPUT

Switches between the TV channels and Video 00.

ANTENNA

Used as TV/VCR button when remote is set to control the VCR.

CLEAR

Clears menus and displays from the screen.

Clears items from VCR timer programs and VCR's clock.

MENU•PROG (Program)

Shows menus on the screen and moves from menu to menu.

Sets VCR clock and programs timer on VCR.

RESET

Returns the picture adjustments to the original settings.

MOVE ◀ and ▶ (left and right)

Moves left and right on a menu line. See *Menu Basics on page 5*.

Changes a feature setting.

MOVE ▲ and ▼ (up and down)

Moves up and down menus. See *Menu Basics on page 5*.

Using Your TV and Remote

With VCRs: Programming the Remote

Refer to the Connection Book or the VCR's owners manual to hook up your VCRs.

The remote may need to be programmed for your VCR, but may not operate all models of the brands listed below. Use the codes below or on the sheet packed in with your remote.

1. Test the remote

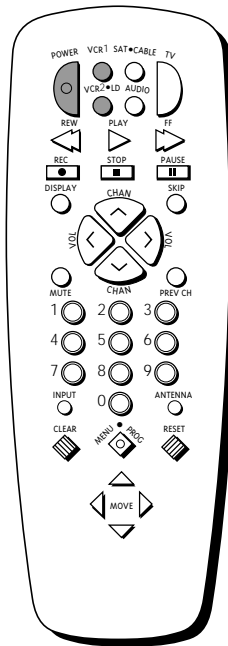

2. Program the remote for your VCRs

- A. Press VCR1 or VCR2•LD to turn the VCR on.
- B. Press the VCR buttons shown at the left. If your VCR does not work, program VCR1 or VCR2•LD with a VCR code from the list below.
- A. Point the remote at the VCR and hold VCR1 or VCR2•LD.
- B. Enter the code for your brand from the code list below.
- C. Release VCR1 or VCR2•LD.
- D. Press POWER. If nothing happens, try pressing VCR1 and then POWER.
- E. Repeat A–D with another code if the first one does not work or if a second VCR is connected.

VCR Codes

Aiwa	15	Kenwood.....	02,14,16,30,46,47	27,43,53
Akai	03,17,22,23,63,66	KLH	73	Samsung.....	07,13,22,32,42,48
Audio Dynamics.....	14,16	Lloyd's.....	15	Sansui	16,71
Broksonic	10	Logik.....	31	Sanyo	02,12
Candle	07,09,13,44,45,52	Magnavox.....	08,29,53,56	Scott	04,13,41,49,68
Canon	08,53	Marantz....	02,08,14,16,29,30,44,46,61	Sears.....	02,05,09,12,18,19,35,43
Capehart.....	01	Marta	09	Sharp.....	06,24,27,39,45
Citizen	07,09,13,44,45,46,52	MEI	08	Shintom	17,26,31,55
Colortyme.....	14	Memorex.....	08,09,12,15	Sony	17,26,38
Craig	07,12	MGA	04,27	Sylvania.....	08,15,29,53,56
Curtis Mathes.....	00,07,08,14,15, 44,45,53,64,67	Midland.....	32	Symphonic.....	15
Daewoo	13,45,52,76	Minolta.....	05,35	Tandy	02,15
dbx	14,16	Mitsubishi	04,05,27,35,40	Tashiko.....	09
Dynatech.....	15	Montgomery Ward.....	06	Tatung	30
Electrohome.....	27	MTC	07,15	Teac.....	15,30
Emerson	08,09,10,13,15,20,23, 27,34,41,42,47	Multitech.....	07,15,31,32	Technics.....	08
Fisher.....	02,12,18,19,43,48,58	NEC	02,14,16,30,44,46,59,61,64	Teknika.....	08,09,15,21
Funai.....	15	Panasonic.....	08,53,75	Toshiba.....	05,13,19,48,49
GE	00,07,08,32,37	Pentax.....	05,35,44	Totevision	07,09
Goldstar.....	09,14,46,60	Pentax Resear	46	TMK.....	67
Harman Kardon.....	14	Philco.....	08,29,35,56	Unitech.....	07
Hitachi.....	05,15,35,36	Philips.....	08,29	Vector Research	14,16,44
Instant Replay	08	Pioneer	05,16,33	Victor	16
JCL	08	Portland.....	44,45,52	Video Concepts.....	14,16,44
JCPenney.....	02,05,07,08,14,16, 30,35,51,53	ProScan.....	00	Videosonic	07
JVC.....	02,14,16,30,46,74	Quartz.....	02	Wards	05,06,07,08,09,12,13,15, 25,31,35
		Quasar	08,53	Yamaha.....	02,14,16,30,46
		RCA	00,05,07,08,28,35,37,54,69	Zenith.....	11,17,26,72
		Radio Shack.....	02,06,08,09,12,15,19		

Using Your TV and Remote

With VCRs: Setting the VCR 1 Channel

The VCR 1 Channel works with VCR1 button on the remote. If the VCR 1 Channel is set, pressing VCR1 selects the channel to see the VCR picture. The VCR 1 Channel setting depends on which diagram you have used from the Connection Guide. If you want to turn this feature off, set the VCR 1 Channel to Disable. Refer to the chart below for your setting.

1. Select the Setup Menu

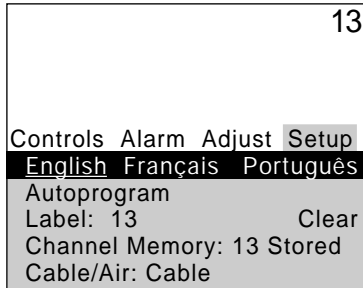

- A. Press TV to set the remote to control the TV.
- B. Press MENU•PROG to select the Setup menu. This menu is white.

2. Highlight VCR1 Channel

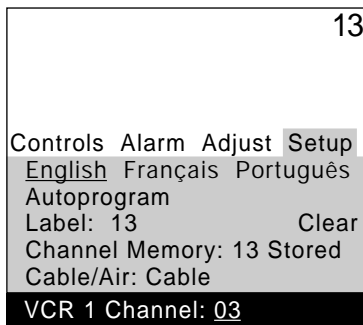

- A. Press MOVE ▼ to highlight the VCR 1 Channel.
- B. Press MOVE ► to highlight the channel.

3. Enter channel number

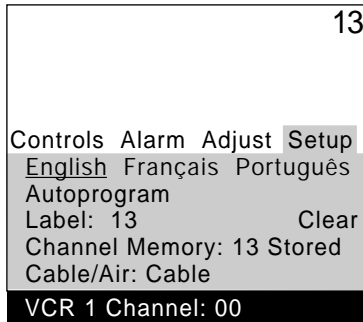

- A. Enter channel 00, 03, or 04. Choose your setting from the chart below. Press CHANNEL down until “Disabled” is displayed to turn the feature off.

Diagram used from the Connection Guide:	Set VCR 1 Channel to:
1B, 1C, 2B, 2C, 3B, 3C, 4C, 5C	00
4B, 5B	3 or 4 (same as 3/4 switch)

Using Your TV and Remote

With VCRs: Basic Operation

If the remote operates your VCR, this page will show you how to use it for basic functions. See pages 6-7 for more details on buttons used with your VCR.

Turn on the VCR

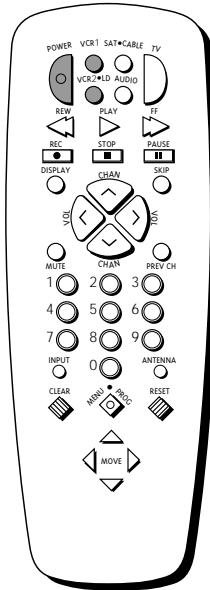

- A. Press channel 00, 03, or 04 on the TV to see what the VCR is doing.
- B. Press VCR1 or VCR2•LD to set the remote to control the VCR.
- C. Press POWER to turn on the VCR if it did not turn on when you pressed VCR1 or VCR2•LD.

Turn off the VCR

- A. Press VCR1 or VCR2•LD to set the remote to control the VCR.
- B. Press POWER.

Record one TV program and watch another

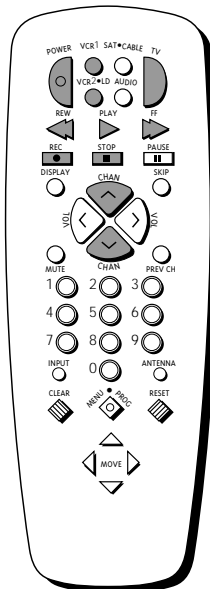

- A. Press VCR1 or VCR2•LD to set the remote to control the VCR.
- B. Tune the VCR to the channel you want to record using CHANNEL up or down or pressing two number buttons.
- C. Press RECORD to start recording.
- D. Press TV/VCR on the VCR.
- E. Press TV to set the remote to control the TV.
- F. Press CHANNEL up or down to change channels on the TV.
- G. To see the channel you are recording, tune the TV back to channel 00, 03, or 04.

Watch a tape in your VCR

- A. Turn on VCR.
- B. Insert a tape in the VCR.
- C. Press PLAY to start the tape playing.
- D. Press STOP when you are finished.
- E. Press REW to rewind the tape.

Using Your TV and Remote

With a Satellite Receiver: Basic Operation

You may also be able to use the TV's remote with your satellite receiver. Refer to your *Satellite Receiver owner's manual to hook up your Satellite Receiver*. The remote may need to be programmed for other brands of satellite receivers, but may not operate all models of the brands listed below. Use the codes below or on the sheet packed in with your remote.

Follow the instructions below for basic operation of your receiver. You may also want to experiment with other buttons on the remote to see if they work with your receiver.

Program the remote for your Satellite Receiver

Turn on the Satellite Receiver

Turn off the Satellite Receiver

Satellite Receiver Codes

Chaparral	80,81
Cheyenne	81
Drake	82,83
DSS.....	00
GE.....	00
General Instruments...92,93,94	
ProScan.....	00
RCA.....	00
Realistic	84
Sierra I,II,III.....	81
STS1.....	85
STS2.....	86
STS3.....	87
STS4.....	88
Toshiba	89
Uniden.....	90
Video Cipher II.....	91

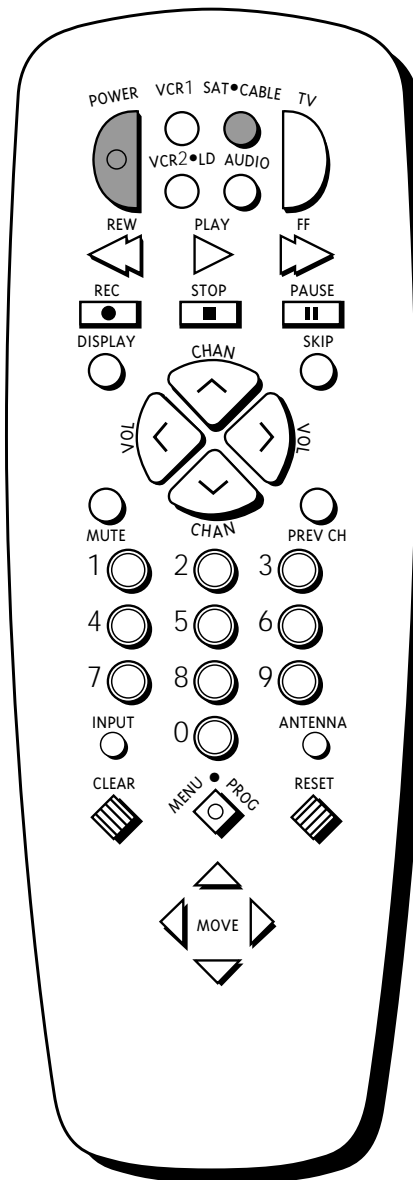

- A. Point the remote at the satellite receiver and hold SAT•CABLE.
- B. Enter the code for your brand from the code list below.
- C. Release SAT•CABLE.
- D. Press POWER. If nothing happens, try pressing SAT•CABLE and then POWER.

- A. Press SAT•CABLE to set the remote to control the satellite receiver.
- B. Press POWER to turn on the receiver if it did not turn on when you pressed SAT•CABLE.

- A. Press SAT•CABLE to set the remote to control the satellite receiver.
- B. Press POWER to turn off the receiver.

Using Your TV and Remote

With a Cable Box: Programming and Basic Operation

Refer to the Connection Book or contact your cable company to hook up your cable box. If you have a cable box with its own remote, then you may also be able to use the TV's remote with your cable box. This remote may not operate all models of the brands listed below. Use the codes below or on the sheet packed in with your remote.

Program the remote for your cable box

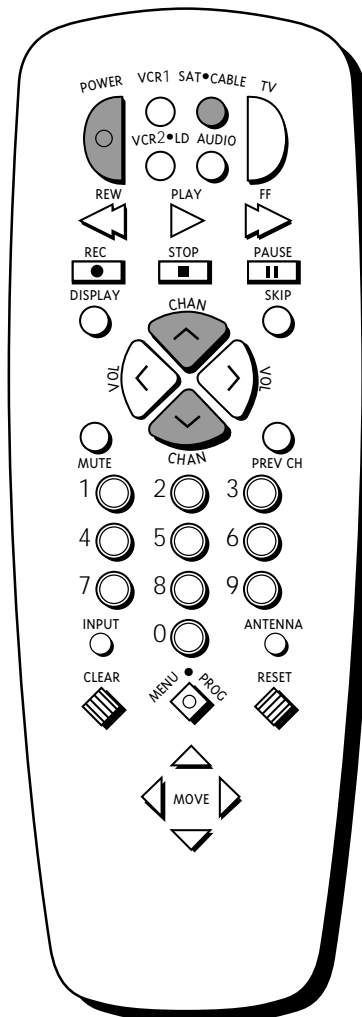

- A. Point the remote at the cable box and hold SAT•CABLE.
- B. Enter the code numbers for your brand from the list below.
- C. Release SAT•CABLE.
- D. Press POWER to turn it on. If nothing happens, try pressing SAT•CABLE and then POWER.
- E. Repeat A-D with another code if the first one does not work.

Basic Operation: Turn on the Cable Box

- A. Tune TV to channel 02, 03, 04, 05, or 06--the cable box channel.
- B. Point remote at the cable box and press SAT•CABLE.
- C. Press POWER to turn it on.
- D. Press CHANNEL up or down to change channels on the cable box.

Turn off the Cable Box

- A. Press SAT•CABLE.
- B. Press POWER to turn it off.

Cable Box Codes

ABC	22,46,53,54	NSC	09	Sprucer	27
Anvision.....	07,08	Oak	01,16,38	Starcom	46
Cablestar	07,08	Oak Sigma	16	Stargate 2000	58
Diamond	56	Panasonic.....	03,27,39,61	Sylvania.....	11,59
Eagle.....	07,08	Philips	07,08,19,21,26,28,29, 32,33,40,41	Teknika	06
Eastern International.....	02	Pioneer	18,20,44	Texscan.....	10,11,59
General Instrument.....	46	Randtek.....	07,08	Tocom.....	17,21,49,50,55
GI 400	04,05,15,23,24,25,30,36	RCA.....	00,27	Unika.....	31,32,41
Hamlin	03,12,13,34,48	Regal.....	03,12,13	Universal.....	51,52,60
Hitachi.....	37,43,46	Regency.....	02,33	Viewstar	07,08,19,21,26,28,29, 32,33,40,41
Jerrold.....	04,05,15,23,24,25, 30,36,45,46,47,62,65	Samsung	44	Warner Amex.....	44
Macom	37,43	Scientific Atlanta.....	03,22,35,63,64	Zenith.....	14,42,57,61
Magnavox.....	07,08,19,21,26,28,29, 32,33,40,41	Signature.....	46		

Using Your TV and Remote

With a Cable Box: Setting the Cable Channel

The Cable Channel works with SAT•CABLE button on the remote. If the Cable Channel is set, pressing SAT•CABLE selects the channel to see cable channels. The Cable Channel setting depends on which channel your cable box must be on to see cable channels. The channels usually used are 02, 03, 04, 05 or 06. *Consult your cable company for more information.*

1. Select the Setup menu

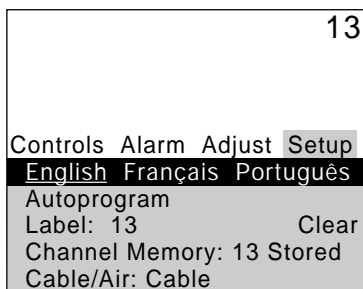

- A. Press TV to set the remote to control the TV.
- B. Press MENU•PROG to select the Setup menu. This menu is white.

2. Highlight Cable Channel



- A. Press MOVE ▼ to move down the menu until Cable Channel is highlighted.
- B. Press MOVE ► to underline the item.

3. Enter channel number

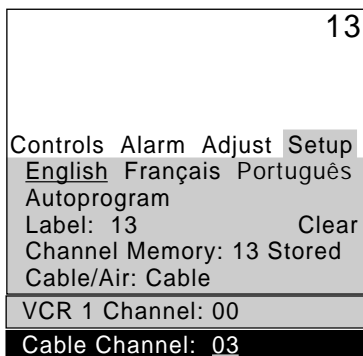

Enter the number for your cable box, either 02, 03, 04, 05, or 06. Press MOVE ▲ or ▼ until "Disabled" is displayed to turn this feature off.

Using Your TV and Remote

With a Laserdisc Player: Programming and Basic Operation

Refer to your Laserdisc Player owner's manual to hook up your Laserdisc Player. The remote may need to be programmed for your laserdisc player, but may not operate all models of the brands listed below. Use the codes below or on the sheet packed in with your remote.

Program the remote for your Laserdisc Player

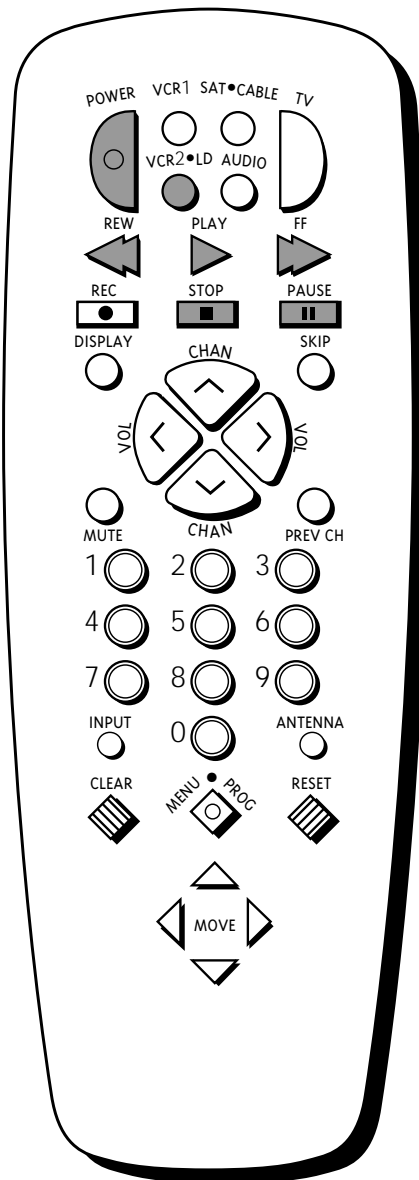

- A. Point the remote at the laserdisc player and hold VCR2•LD.
- B. Enter the code for your brand from the code list below.
- C. Release VCR2•LD.
- D. Press POWER. If nothing happens, try pressing VCR2•LD and then POWER.

Basic Operation

- A. Tune TV to channel 00, 03, or 04.
- B. Point the remote at the laserdisc player and press VCR2•LD.
- C. Press POWER to turn it on.
- D. Use the buttons on the remote that relate to laserdisc player functions. Not all buttons highlighted may work with your laserdisc player.
- E. Press POWER to turn it off.

Laserdisc Player Codes

Pioneer.....	33
ProScan.....	33
RCA.....	33

Using Your TV and Remote

With Audio Equipment: Programming and Basic Operation

Refer to the Connection Book or your Audio equipment owner's manual to hook up your audio equipment. Your remote controls some audio equipment such as a radio, CD player, tape player, turntable, or amplifier. The remote may need to be programmed for your equipment, but may not operate all models of the brands listed below. Use the codes below or on the sheet packed in with your remote.

Program the remote for audio equipment

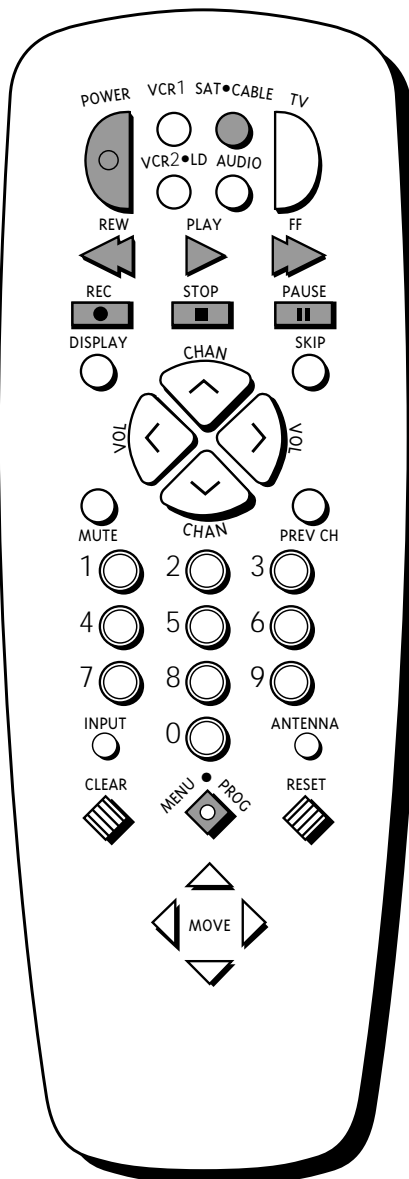

- A. Point the remote at the audio equipment and hold AUDIO.
- B. Enter the code from the code list.
- C. Release AUDIO.
- D. Press POWER to turn it on. If nothing happens, try pressing AUDIO and then POWER.
- E. Repeat A–D with another code if the first one does not work.

Basic Operation

- A. Point the remote at the audio equipment and press AUDIO.
- B. Press POWER to turn it on.
- C. Use the buttons on the remote that relate to audio functions. Not all buttons highlighted may work with your equipment.
- D. Turn the audio equipment off using the audio component's power off button.

Audio Codes

RCA/ Dimensia	
AM/FM.....	03
CD.....	07
Tape.....	06
Phono.....	05
Aux.....	04

Adjusting Your TV

Overall Picture

Follow the steps below to lighten or darken the overall picture without changing the color levels.

1. Select the Controls Menu

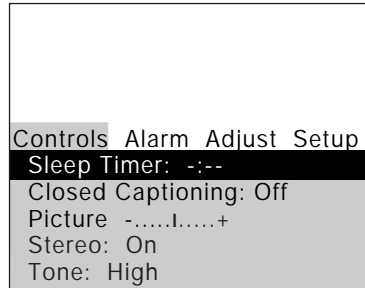

Press MENU•PROG to select the Controls menu. This menu is yellow.

2. Highlight Picture

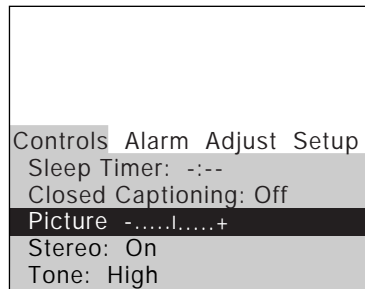

Press MOVE ▼ to highlight Picture.

3. Use MOVE ► and ◀ to adjust the Picture

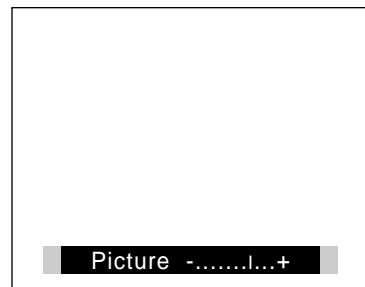

Press MOVE ► to lighten the picture.

OR

Press MOVE ◀ to darken the picture.

Adjusting Your TV

Picture Settings

Follow the steps below to change the picture on the screen to your personal setting. The chart at the bottom of the page explains your options.

1. Select the Adjust Menu

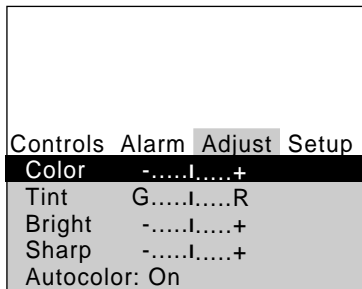

Press MENU•PROG repeatedly to select the Adjust menu. This menu is light blue.

2. Highlight item to change

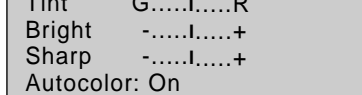

Press MOVE ▼ to highlight the picture item you want to adjust.

3. Use MOVE ► or ◀ to adjust each item

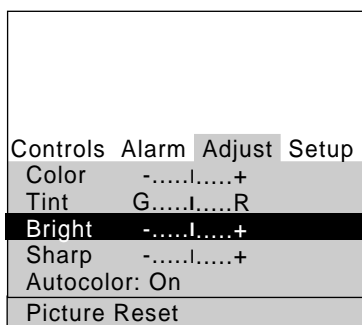

Press MOVE ► or ◀ to adjust each item.

	Press MOVE ► to:	Press MOVE ◀ to:
Color	Increase color richness	Decrease color to black and white
Tint	Give red tint to skin color	Give green tint to skin color
Bright (Brightness)	Add more light to dark parts of the picture	Add more dark to light parts of the picture
Sharp (Sharpness)	Show cleaner, clearer images	Make picture more smooth
Autocolor	Turn on to keep Color and Tint in proper balance each time you change channels	Turn off for manual adjustment of Color and Tint
Picture Reset	Reset the picture back to the original settings	Reset the picture back to the original settings

Adjusting Your TV

Sound Settings: Stereo and Tone

Follow these steps to adjust the Stereo or Tone of your TV. The chart below explains your options.

XS® Stereo
 An Innovative Method for Providing Stereo Sound Effect
 The sound delivered by your television is XS® Stereo. This patented process suppresses noise, restores the dynamic range and electronically expands the stereo signal to create a more spacious sound effect.

1. Select the Controls Menu

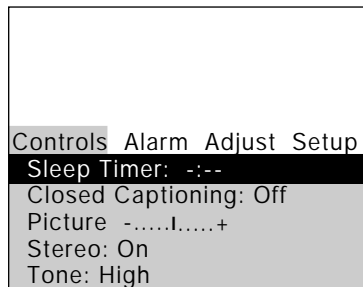

Press MENU•PROG to select the Controls menu. This menu is yellow.

2. Highlight item to change

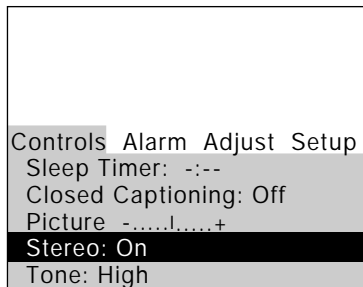

Press MOVE ▼ to highlight the sound item you want to adjust.

3. Use MOVE ► or ◀ to adjust each item

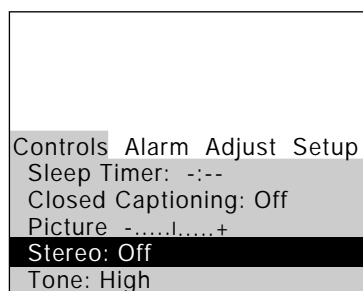

Press MOVE ► or ◀ to adjust each item.

Stereo	On Sound is automatically reproduced in stereo or mono, whichever the TV station is broadcasting.	Off Sound is reproduced in mono.
Tone	High High pitched sounds are louder.	Low Low pitched sounds are louder.

Using Advanced Features

Placing Channels in Memory (Autoprogramming)

Only channels 2–13 appear in the TV's memory when you first turn it on. The channels available in your area must be programmed into the TV's memory when you hook up your TV. Using CHANNEL up and down allows you to scan through these channels.

You may want to add or delete a few channels if some stations have weak signals or were off the air when the TV was programmed. *Refer to the Add or Delete Channels section below.*

1. Place channels in memory (Autoprogram)



- Hook up an antenna, cable or components before you begin these steps or you will not be able to add channels into memory.
- Press MENU•PROG repeatedly to select the Setup Menu and highlight Autoprogram. This menu is white.
- Press MOVE ▼ to highlight Autoprogram.
- Press MOVE ► to start the TV adding all active channels into memory.
- Wait until the TV has cycled through all the channels and returns to the original channel.

2. Add or delete channels

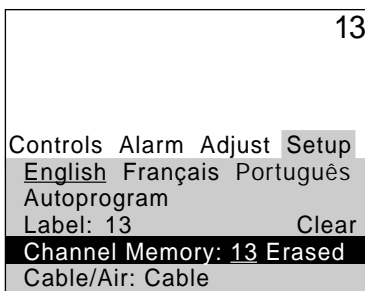

- Press MENU•PROG repeatedly to select the Setup menu. This menu is white.
- Press MOVE ▼ to highlight Channel Memory.
- Press MOVE ► to underline the channel number.
- Select the channel number you want to add or delete with the number buttons.
- Press MOVE ► to add or delete a channel (you will see Stored on the screen when added and Erased when deleted).
- Repeat D and E for more channels.

Using Advanced Features

Naming the Channels

You can name at least 20 channels with four characters in each name. **Full** appears beside Label when the memory is used up. **Fixed** appears when a channel number cannot be named. Below are the characters that can be used in a name.

1. Name a channel

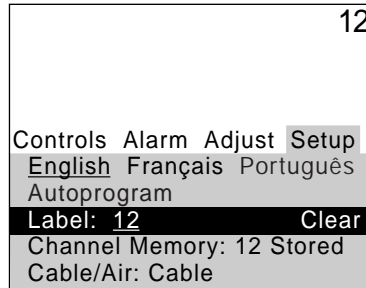

- Press MENU•PROG repeatedly to select the Setup menu. This menu is white.
- Press MOVE ▼ to highlight Label.
- Press MOVE ► to underline the channel number.
- Select the channel number with the number buttons.
- Press MOVE ► to underline the first character of the name.
- Choose the character using MOVE ▲ or ▼.
- Repeat E-F to complete the name.
- Press MOVE ◀ to move backward if you want to change an item.

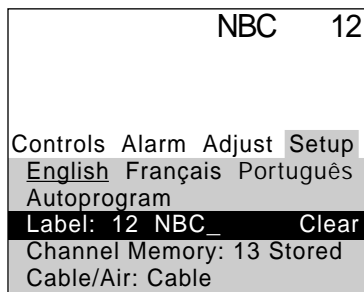

2. Erase a name

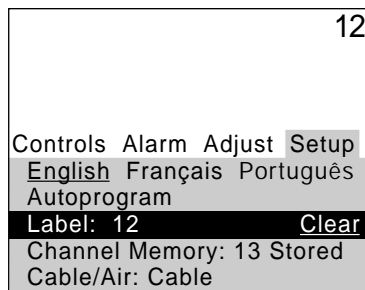

- Follow A and B above.
- Press MOVE ► until clear is underlined.
- Press MOVE ▲ or ▼ to clear the name.

Character List

A B C D E F G H I J K L M N O P Q R S T U V W X Y Z &
' () á + , - . / 0 1 2 3 4 5 6 7 8 9 : ; < = > ? @ blank space

Using Advanced Features

Setting the Sleep Timer

You can set your TV to turn itself off. If you're watching TV at night and fall asleep, the TV will turn off for you.

1. Set Sleep Timer

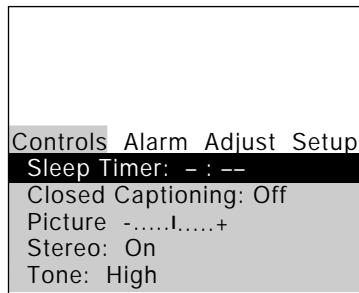

- A. Press MENU to select the Controls menu and highlight Sleep Timer. This menu is yellow.
- B. Press VOLUME + to enter the amount of time you want to watch TV before it shuts off. Each press equals 15 minutes.
- C. Press VOLUME - to subtract time from the sleep timer.

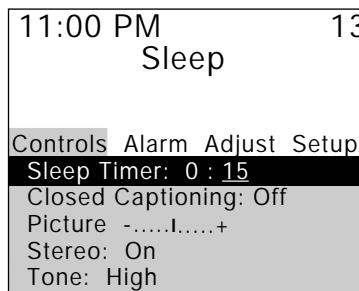

2. Add more time



When 0:01 appears on the screen, the TV will shut off in one minute. Press VOLUME + to add more time.

3. Cancel the Timer

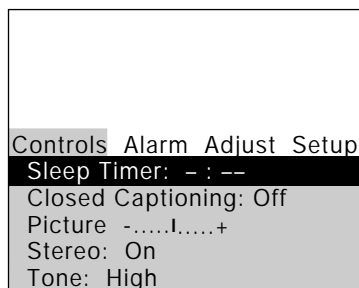

- A. Press MENU to select the Controls menu and highlight Sleep Timer.
- B. Press VOLUME - until the time reaches - : --.

Using Advanced Features

Setting the Alarm Clock

The TV can be set to turn on each day like your alarm clock. You can set it to turn on to your favorite channel at a certain time. You can also set it to turn itself off again. The Alarm cannot be used until the clock is set.

1. Turn on the Alarm

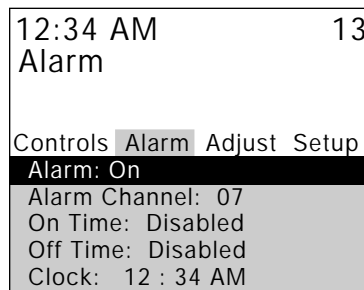

- A. Press MENU to select the Alarm menu and highlight Alarm. This menu is green.
- B. Press VOLUME + or - to select On or Off.

2. Set the Alarm Channel

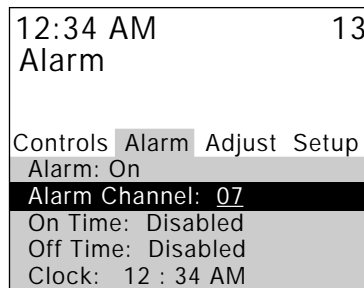

- A. Press CHANNEL down to highlight the Alarm Channel.
- B. Press VOLUME + to highlight the channel number.
- C. Enter the channel that you want the TV to turn on to with the number buttons.

3. Set On and Off Times

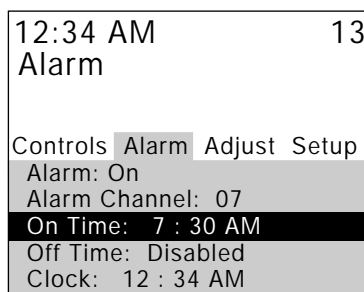

- A. Press CHANNEL down to highlight the On or Off Time.
- B. Press VOLUME - to set the hour.
- C. Press VOLUME + to set the minutes.
- D. Press and hold VOLUME - to choose Disabled. This turns the TV only on or only off at a certain time each day.

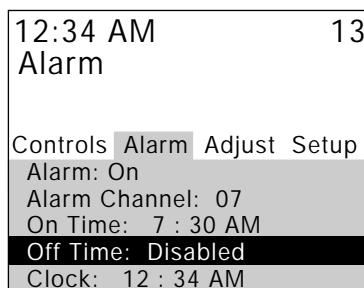

Using Advanced Features

Selecting a Language

The on-screen displays in this TV can be displayed in three languages: English, Spanish, and Portuguese. When you select a language, most of the displays will be shown on the screen in your preferred language.

1. Select the Setup menu



Press MENU•PROG repeatedly to select the Setup menu. This menu is white.

2. Select Language

Press MOVE ◀ or ▶ to select English, Español (Spanish), or Português (Portuguese).

Watching Closed Captioning

Closed captioning displays the audio portion of a program as words on the TV screen. It is useful for the deaf, hearing impaired, or anyone who wants to watch a program without sound. If you have turned Closed Captioning on and it does not appear on the screen, it is not available on the channel you are watching. This TV does not support the text mode. Text information typically consists of program information, weather bulletins, local activities, etc.

1. Select the Controls Menu

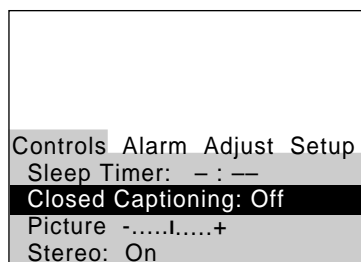

Press MENU•PROG to select the Controls menu. This menu is yellow.

2. Highlight Closed Captioning

Press MOVE ▼ to highlight Closed Captioning.

3. Select Setting

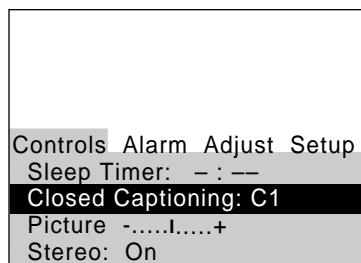

Press MOVE ◀ or ▶ to select Off, C1, or C2. Select C1 for full translation of the primary language in your area. Select C2 for secondary language translation, simplified English, or whatever is being broadcast in your area.

Using Advanced Features

Setting Your TV for Antenna or Cable

Your TV automatically adjusts this feature when the TV places channels in memory (Autoprogram). Follow the steps below to change the setting as needed.

1. Select the Setup menu



Press MENU•PROG repeatedly to select the Setup menu. This menu is white.

2. Highlight Cable/Air



Press MOVE ▼ to highlight Cable/Air.

3. Select Cable or Air



Press MOVE ◀ or ▶ to select Cable or Air. Select Cable if you have cable. Select Air if you have a home antenna connected to your TV.

References

Front Panel Buttons

The CHANNEL up and down and VOL + and - buttons, not only change the channels and volume of the TV, but work like the MOVE buttons when you are in the TV Menu. *For details on using buttons with menus, see Menu Basics on page 5.*

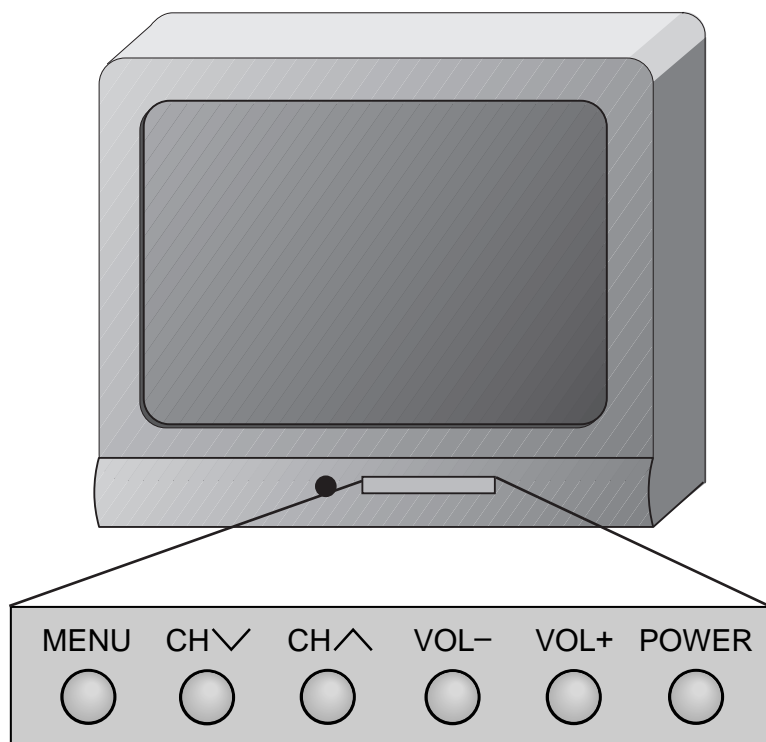

MENU	Shows menus on screen. Moves from menu to menu.
CH ^ and v	Channel up and down. Scans up and down through channels in the TV's memory. Moves up and down menus.
VOL + and -	Volume up and down Raises and lowers sound. Moves left and right on a menu line. Changes a feature setting.
POWER	Turns the TV on or off.

References

Displays on the Screen

Your TV shows the settings of several features on the screen. To see what features have been set on your TV, press DISPLAY on the remote.

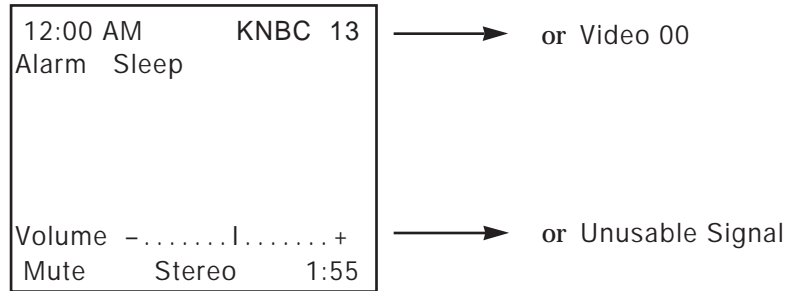

Screen Display

Description

12:00 AM

Time of the clock. *Details are on page 3.*

KNBC

Name you chose to describe the channel. *Details are on page 20.*

13

Channel number you are watching.

Video 00

Indicates that a component is connected to the VIDEO jack on the back of the TV, it is turned on, and channel 00 is selected.

Alarm

Alarm clock is set to turn on or off. *Details are on page 22.*

Sleep

Sleep Timer is set to turn off the TV. *Details are on page 21.*

Volume

Sound level of the TV.

Unusable Signal

No signal is coming in on video input channel 00.

Mute

There is no sound. *See MUTE button on page 6.*

Stereo

The sound is being broadcast in stereo. *Details are on page 18.*

1:55

The time remaining for commercial skip. *Details are on page 6.*

References

Trouble Checks

You may have problems that can be fixed with a few minor adjustments. Look for the type of problem you are having below and then try the suggestions to get your TV going again.

Trouble	Checks and Adjustments
<u>Power</u>	
TV will not turn on	Plug TV in. Plug something else into the outlet to make sure it is working. Make sure batteries in the remote are not dead. Aim the remote at the TV and press POWER. Make sure batteries are placed in the remote the right way. <i>See batteries on page 2.</i> Unplug TV for a few minutes and then turn it on again.
No picture, no sound but TV has power	Check antenna connections. Check position of Cable/Air feature. <i>See page 24.</i> Try another channel. Inactive channel may be tuned. Make sure component connected to the VIDEO INPUT jacks is turned on if you choose channel 00. Make sure TV is tuned to the same channel as the switch on back of VCR if watching a VCR. Make sure TV/VCR button on VCR is in correct position when using VCR.
<u>Picture</u>	
Blank screen or Unusable Signal appears on screen	Try another channel. Inactive channel may be tuned. Scan the channels.
Picture poor, sound okay	Check antenna connections. Adjust TV picture. <i>See pages 16-17.</i>
<u>Sound</u>	
Noisy stereo reception	Turn Stereo off. The stereo broadcast may not be clear. <i>See page 18.</i>
Picture okay, no sound	Press VOLUME + or MUTE to restore sound.
Picture okay, sound poor	Try another channel. Try adjusting the Stereo or Tone. <i>See page 18.</i> Change Stereo to off. The stereo broadcast may not be clear. <i>See page 18.</i>
No stereo on stereo station	Make sure Stereo is turned on. <i>See page 18.</i>

References

Trouble Checks

Trouble	Checks and Adjustments
<u>Remote</u>	
Buttons don't work when you press them	Press TV to set the remote to control the TV. <i>See buttons on page 6.</i>
Remote lockup	Remove batteries and hold down one or more buttons for several seconds to drain the microprocessor inside the remote and reset it. Re-install the batteries and try remote again.
Works part or none of the time	Clear the path between the remote and TV of any objects. Aim the remote at the component you are trying to control. Make sure batteries in the remote are not dead. See if batteries are placed in remote correctly. <i>See batteries, page 2.</i>
Can't select certain channel	Press number buttons. Channel may not be in memory. <i>See Autoprogram on page 19.</i> Make sure TV/VCR switch on VCR is in the TV position if using VCR. For numbers over 100, press and hold 1 until 1-- appears, then press the other two numbers. Set Cable/Air feature to Cable for channels higher than 69. <i>See page 24.</i>
<u>TV Turns on or off</u>	
Turns off by itself	Check Sleep Timer. <i>See sleep timer on page 21.</i> Wait 30 seconds and turn on again, a power surge may have occurred. Check Alarm Off time. <i>See alarm clock on page 22.</i>
Turns on by itself	Check Alarm On Time. <i>See alarm clock on page 22.</i> Check clock time. <i>See clock on page 3.</i>
Does not turn off at Alarm Time	Make sure alarm is turned on or off. <i>See alarm clock on page 22.</i> Check clock time. <i>See clock on page 3.</i> Make sure Clock time is set correctly, including AM and PM. Check Alarm Off time.

Printed in the U.S.A.
TOCOM 1512890A

COUNTRY OF ORIGIN:
USA



Free Manuals Download Website

<http://myh66.com>

<http://usermanuals.us>

<http://www.somanuals.com>

<http://www.4manuals.cc>

<http://www.manual-lib.com>

<http://www.404manual.com>

<http://www.luxmanual.com>

<http://aubethermostatmanual.com>

Golf course search by state

<http://golfingnear.com>

Email search by domain

<http://emailbydomain.com>

Auto manuals search

<http://auto.somanuals.com>

TV manuals search

<http://tv.somanuals.com>