

RCA

VideoCassette
Recorder

Owner's Manual



Warranty Registration

No other RCA Video Cassette Recorder has the same serial number as yours. It is important that you record the number and other vital information here, in case your VCR is stolen or in case you need a complete description for any other reason. You will find the model and serial numbers on the back of the VCR. You will also find both numbers recorded on your registration form.

Purchase Date _____

Dealer _____

Model: VR270 Serial Number _____

VCR registration is very important so that you can be contacted should there be a safety inspection, modification, or product recall under applicable laws or regulations or otherwise. The dealer who sold you the VCR should have registered it and given you a copy of the registration form.

If your dealer did not give you a copy of the registration, contact him promptly and ask for it. You must be able to show your registration or evidence of purchase date to any RCA Authorized VCR Servicenter to receive warranty parts and service. We suggest you attach your sales slip and warranty registration to this booklet and keep them in a safe place for future reference.

Safety Precautions

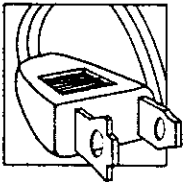

Your VCR operates on 120 volts, 60 Hz (normal household current) and has a polarized plug. Because one blade of the plug is wider than the other, the plug fits in the wall socket only one way. Do not defeat the safety feature of this plug. If you need an extension, use a polarized cord.

Caution: To prevent electric shock do not use the polarized plug on this Video Cassette Recorder with an extension cord, receptacle, or other outlet unless the blades can be fully inserted to prevent blade exposure.

Mise en garde: Pour prévenir les chocs électriques, ne pas utiliser la fiche polarisée de cet appareil avec une rallonge, une prise de courant ou une autre sortie, à moins que les lames puissent être insérées à fond sans qu'aucune partie soit laissée à découvert.

WARNING: To prevent fire or shock hazard, do not expose this VCR to rain or moisture.

Illustrated below is the label on the back of your Video Cassette Recorder.



 The symbol of a lightning flash within a triangle is intended to alert the user to the presence of uninsulated "dangerous voltage" within the product's enclosure that may be of sufficient magnitude to constitute a risk of electric shock.

 An exclamation point within a triangle is intended to alert the user to the presence of important operating and maintenance (service) instructions in the literature accompanying the product.

CAUTION: To reduce the risk of electric shock, do not remove the cover or back. No user-serviceable parts are inside. If you spill liquid on the VCR, disconnect the power cord to prevent possible fire or shock hazard and consult authorized service personnel. Moisture can damage internal parts. Refer all service to RCA VCR Authorized Servicenter personnel only.

Caution: Maintain electrical safety. Powerline-operated equipment or accessories connected to this unit should bear the UL listing mark or CSA certification mark on the accessory itself and should not have been modified so as to defeat the safety features. This will help avoid any potential hazard from electric shock or fire. If in doubt, contact qualified service personnel.

Note to Cable TV Installer:

This reminder is provided to call your attention to Article 820-22 of the National Electrical Code (Section 54 of Canadian Electrical Code, Part I), that provides guidelines for proper grounding and, in particular, specifies that the cable ground shall be connected to the grounding system of the building as close to the point of cable entry as practical.

Caution: The unauthorized recording of television programs and other materials may infringe the rights of others.

Using This Manual

Congratulations on your choice of an RCA VCR. You have selected a high-quality, precision-engineered instrument designed to give you years of video and audio enjoyment.

To get the best performance from your new VCR, it is important that you carefully read and follow the operating instructions in this manual in the sequence in which they are presented.

This manual is divided into two sections.

- Section I explains how to install the VCR and basic operation.
- Section II contains Quick Reference Guides, illustrates how to connect components, and includes general information.

Should you experience a problem, please follow the "Trouble Checks" on page 34. The warranty on the back cover describes what will be done for you should your new VCR need service during the warranty period. It also tells you how and from whom you should request service.

CAUTION: Avoid operating your VCR right after you have moved it from a cold location directly to a warm location. Let it warm up for about 1-1/2 to 2 hours before inserting a video cassette tape. When moved from a cold spot to a warm spot, moisture may condense on the head drum inside the machine. The moisture may cause the tape to stick and damage the head wheel or tape.

Contents

Warranty Registration	Inside Front Cover
Safety Precautions	Inside Front Cover
What Your VCR Will Do	2
SECTION I—Basic Installation and Operating Instructions	
Basic Installation Instructions	
• Unpacking, Choosing Location	4
• General Installation Information	4
• Basic Antenna and Cable-TV Connections	5
• Antenna Connections	6-7
• Cable-TV Connections	8-9
• TV Monitor/Receiver Connections	10
Basic Operation	
• Basic Operating Controls and Displays	11
• Inserting/Removing Cassettes	11
• Turning on Your VCR for the First Time	12
• Programming Active Channels into VCR's Tuner	12
• Erasing Channels from the Scan List	12
• Adding Channels to the Scan List	12
• Setting TV to VCR Channel	13
• Using the TV VCR Button on the Remote ...	13
• Simplified Installation Checklist	13
Remote Control	14-15
• Battery Installation	14
Setting the Clock	16
First Recording and Playback	17
Operating Controls (Detailed)	18-19
Special Effects and Features	
• Pause During Recording	20
• Pause for Stop-Action Playback	20
• Picture Search	20
• Tracking Control	20
• Tape Counter	21
• On-Screen Display	21
• Memory Stop	21
Programming the Timer	22-23
Timer Recording	24
Express Recording	25
Video Cassettes	26
SECTION II—Quick Reference Guides, Component Recording and General Information	
Quick Reference Operating Guides	
• Normal TV Viewing	28
• Recording With TV Off	28
• Recording and Viewing the Same Program ...	28
• Recording and Viewing Different Programs...	29
• Basic Playback	29
Component Recording	
• Recording from Another VCR	30
• Camera Recording	31
Alternate Remote Control Units	32-33
Cabinet Cleaning	34
Trouble Checks	34
Optional Accessories	35
Index (Alphabetical)	36-37
Specifications	Back Cover
Warranty	Back Cover

What Your VCR Will Do

New Compact Design—State-of-the-art miniaturization now allows RCA to dramatically reduce the size of its VCR's without sacrificing features or performance. This new compact size takes up less space on top of a console TV or in a component rack system. Use the extra room for cable-TV decoders, headphones, or other peripheral equipment.

Infrared Remote Control—Puts complete control of your VCR's most popular features in the palm of your hand. Wireless remote control uses reliable infrared signals to activate all primary functions, including timer programming. VCR can be operated with an RCA Digital Command remote control and integrated into a unified RCA audio/video system.

FS Tuner—111-channel Frequency Synthesis (FS) tuning provides accurate selection of all VHF/UHF or up to 41 unscrambled cable channels.*

Quartz-controlled electronics automatically lock the system onto the signal, eliminating the need for fine tuning. Most cable systems can be connected directly through the VCR without the need for a converter box. Bright, easy-to-read display indicates channel selected.

*Local systems may vary; check your cable company's compatibility requirements.

Auto Programming—Preset available channels into VCR's electronic scan memory at the touch of a single button. No more elaborate programming steps. After automatic programming, channels can be selected by remote control scanning—either up or down. *ADD* and *ERASE* buttons are also included for customizing the memory scan list.

8-Hour Recording Time—Enjoy up to 8 hours of uninterrupted recording or playback in SLP mode with T-160 cassette. Standard Play (SP) and Long Play (LP) are also included to ensure compatibility with all VHS tapes. VCR automatically selects correct playback speed.

On-Screen Remote Timer Programming—With RCA's advanced remote control, all timer programming can be done from across the room. At the touch of a button, easy-to-follow instructions appear on the TV screen and guide the viewer through each programming sequence. The timer memory can be preset up to a year in advance to record up to 4 events automatically.

Express Recording (XPR)—Use this feature to record without numerous programming steps. Just enter the length of desired program (up to 4 hours) while recording. VCR will record for the proper length of time and shut off automatically.

Fluorescent Displays—Vivid amber, easy-to-read displays include channel number, current time and day, and tape speed selected. Indicators include status displays, cassette-in display, timer programmed display, Express Record (XPR) display, and many more that aid in easy operation of this VCR.

Tape Counter with Memory—When the tape counter is displayed on the TV screen, fast forward and rewind will stop when the counter reads "0000." By resetting the counter to "0000" at the desired point on the tape, you can stop at this point for repeated viewing of a certain scene.

Search/Stop Action—Visually scan forward or reverse through taped material. Examine details easily missed in a moving picture by stopping the action at any point in the tape. SLP mode provides best performance.

Auto Power-On—Simply inserting a cassette in the VCR turns it on. A *POWER* button is also provided for manual control.

Auto Play—When a prerecorded cassette (with record protect tab removed) is inserted in the VCR, it automatically starts playing. When the end of the tape is reached, Auto Rewind automatically rewinds the tape.

Auto Rewind with Shutoff—When VCR reaches the end of the tape in Playback or Record, it automatically rewinds the tape. This ends the trouble of remembering to rewind tapes (which is recommended for proper care of cassettes). To prevent accidental tape erasures, however, the tape does not Auto Rewind after timer recording.

HQ Picture—Advanced electronics sharpen image definition for improved picture quality. HQ circuitry provides superior recording quality while allowing complete playback compatibility with recordings made on non-HQ VHS machines.

Optional Accessories—Optional Accessories are available for use with your new VCR to expand your home video system. Some accessories are shown on page 35.

SECTION I

Basic Installation and Operating Instructions

Installation

Unpacking

When you unpack your new VCR, be sure you have removed all the accessories and information sheets. We recommend that you save the packing materials and box in case you ever need to ship or store your VCR.

The accessories supplied for connecting your antenna, VCR, and TV set are shown here. The remote control unit and its batteries are also packed in with the VCR.

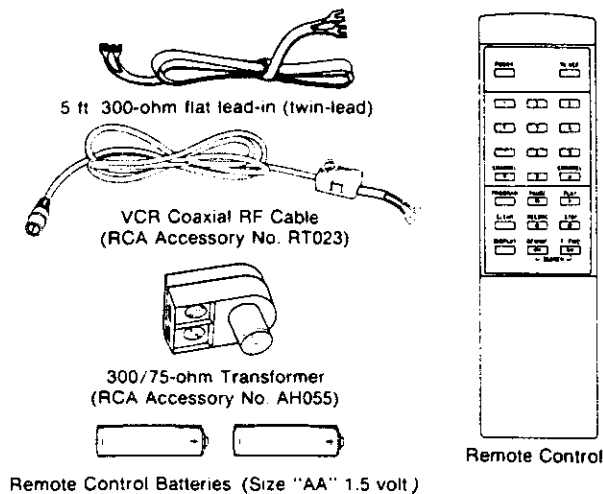

Location

- Choose a location that is convenient, but away from sources of heat such as direct sunlight and heating units.
- If the VCR is to be installed in an equipment rack or

cabinet with other devices, be sure that there is adequate ventilation at the back and around the sides of the components. The VCR should not be placed on or directly above a stereo amplifier because of the heat that rises from the amplifier.

- Choose a flat surface at least as large as the VCR so that it rests on its mounting feet. It is important that air can pass through the ventilation holes in the bottom of the unit to prevent it from overheating. Do not operate the VCR on a rug or carpet because the pile will obstruct these holes.

Some TV sets may cause interference in home VCR's. To avoid interference and get the best performance from your VCR, follow these guidelines:

- When placing the VCR under a TV, keep at least 18 inches between the bottom of the TV and the top of the VCR.
- If interference is present when the VCR is used on top of the TV or at the 18-inch distance below the set, move the VCR to a position beside the TV.
- If moving the VCR does not solve the interference problem, try plugging the VCR into a different wall socket.
- If interference continues after all the above, call your dealer or service representative.

You may find the following booklet prepared by the Federal Communications Commission helpful:

Interference Handbook

This booklet is available from the Superintendent of Documents, U.S. Government Printing Office, Washington, DC 20402

General Installation Information

IMPORTANT

There are two basic steps for connecting your new VCR to your present TV and antenna(s) or cable-TV. The first step is to disconnect the antenna(s) or cable-TV from the TV and reconnect it to the VCR. The second step is to connect the VCR to the TV. Be sure you do both steps.

Since there are many different types of antennas and TV's, there are several ways to make the above connections. Therefore, the instructions have been divided into sections. Basic antenna/cable-TV connections are explained on page 5. More detailed instructions for connecting your home antenna system are on pages 6 and 7. Detailed directions for connecting more complicated cable-TV systems are on pages 8 and 9. If you have a TV monitor/receiver, you may want to make the additional connections described on page 10.

The antenna is the "signal receiver" that picks up TV broadcasts. Some modern antennas receive both VHF (Very High Frequency) channels 2 through 13, and UHF (Ultra High Frequency) channels 4 through 83.

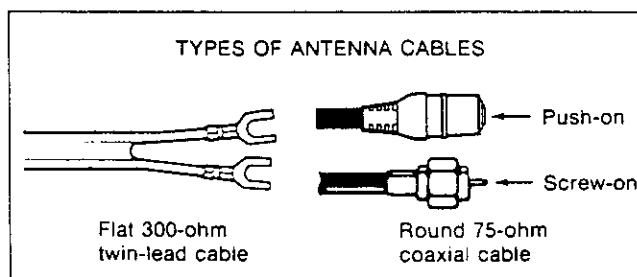
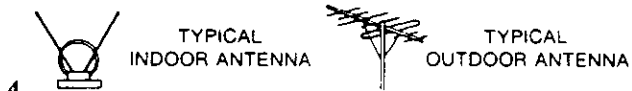

Some antennas are designed only for VHF reception and others are designed only for UHF reception.

Signals from your antenna are conducted through flat "twin-lead" cable, or through round "coaxial" cable.

Cable-TV (CATV) supplies television signals directly by round cable without the need for a home antenna. Cable-TV delivers both VHF and UHF channels and programs not available from a home antenna.

In most situations you will get better picture quality if you use an outdoor antenna or connect your TV and VCR to a cable-TV system. If this is not possible, use a good quality indoor antenna. Your indoor antenna should have separate leads for VHF and UHF if you are in an area with both VHF and UHF stations—or you may use separate VHF and UHF indoor antennas.

Basic Antenna and Cable-TV Connections

Basic Antenna Connections

Your VCR is quite easy to install. To connect an antenna, you will first be attaching the antenna to the VCR, and then connecting the VCR to the TV as shown below.

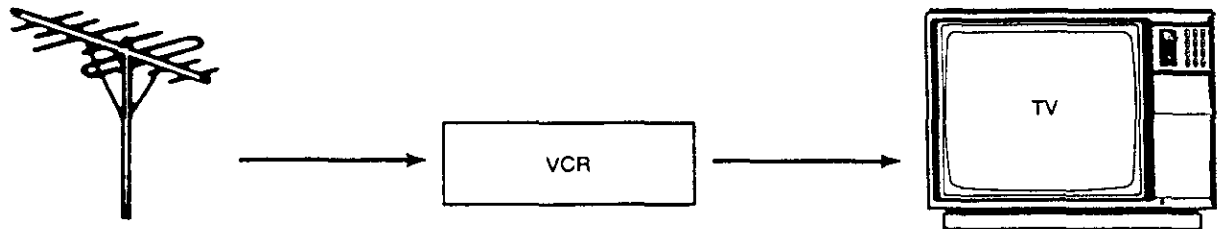

1. Connect antenna to VCR.

2. Connect VCR to TV.

Detailed instructions for connecting an antenna are on the next two pages.

Note: Set the *NORM/CATV* Switch on the back of your VCR to *NORM* when you connect a home antenna system.

Basic Cable-TV Connections

Your VCR is quite easy to install. To connect a cable-TV system, you will first be attaching the cable-TV cable to the VCR, and then connecting the VCR to the TV as shown below.

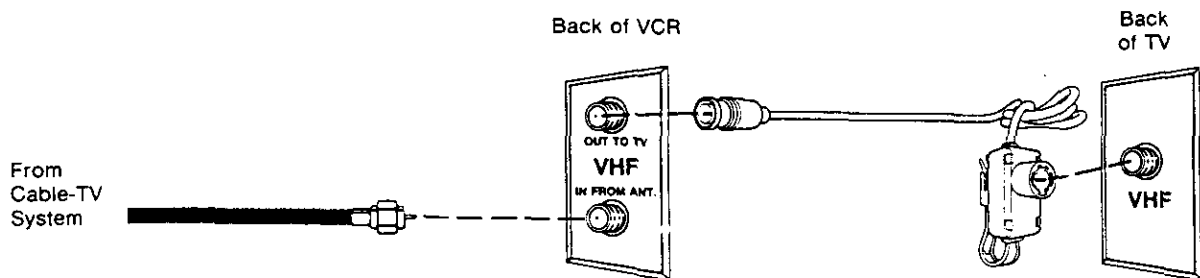

1. Connect cable-TV system to VCR.

2. Connect VCR to VHF jack on TV.

This connection diagram can be used to connect most types of cable-TV systems. Detailed instructions for connecting more complicated cable-TV systems are on pages 8 and 9.

Note: Set the *NORM/CATV* Switch to *CATV* when you connect a cable-TV system.

Antenna Connections

- 1. Disconnect Existing Antenna from TV and Connect it to VCR.**
 (Your antenna connections will probably resemble those in one of the diagrams on this page.)

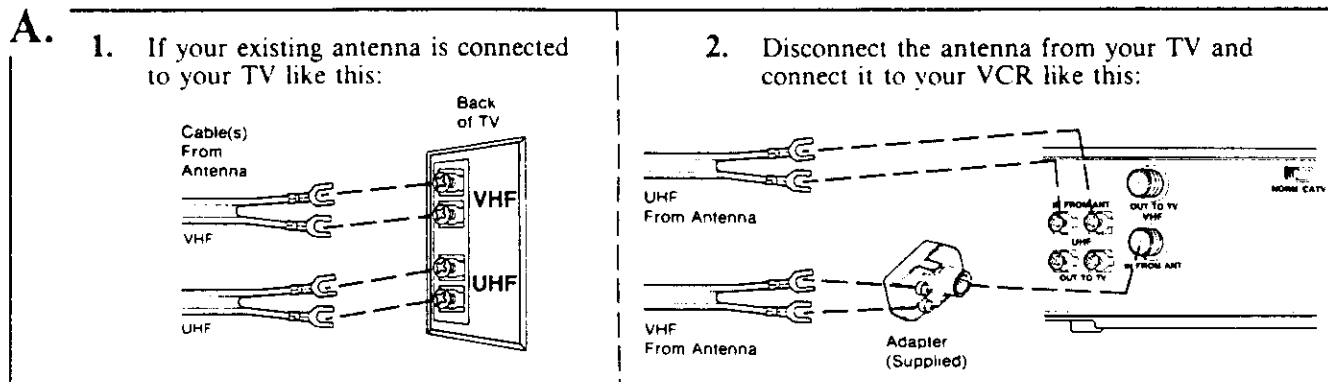

—OI—

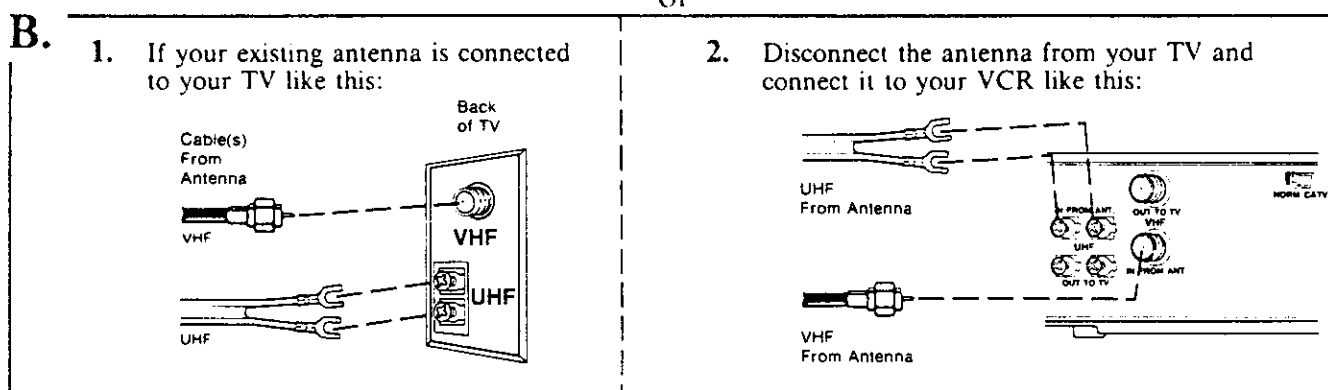

—OI—

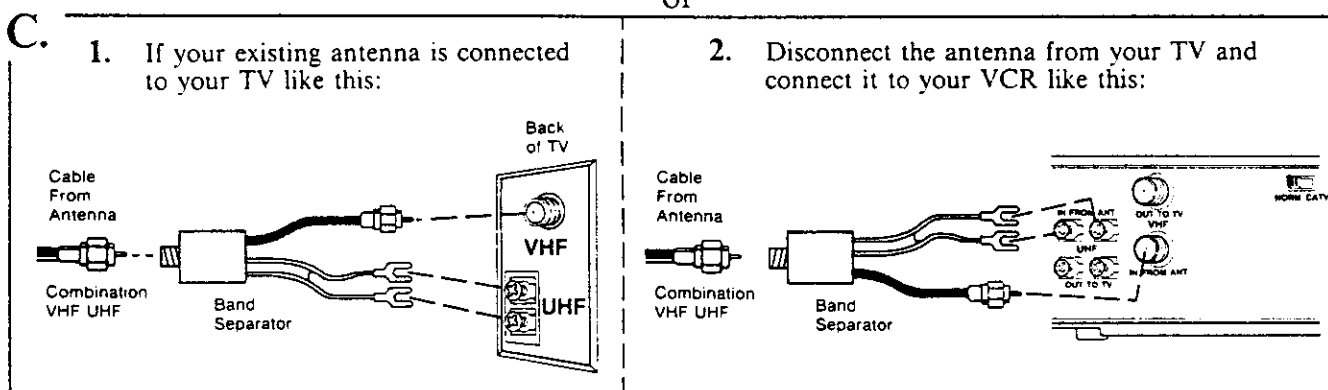

—OI—

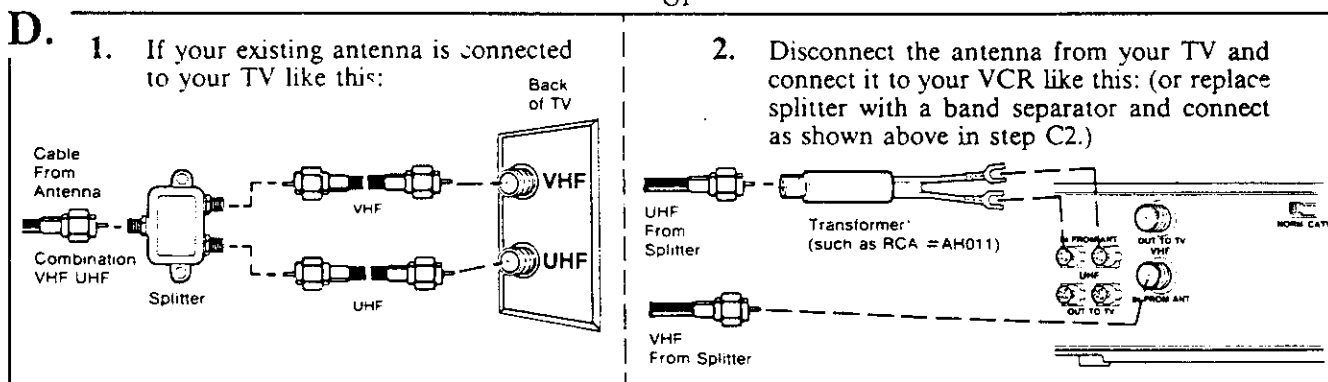

*Optional accessory available from your RCA dealer or electronic supply store.

2. Connect VCR to back of TV.

(The antenna connections on the back of your TV will probably resemble those in one of the diagrams below.)

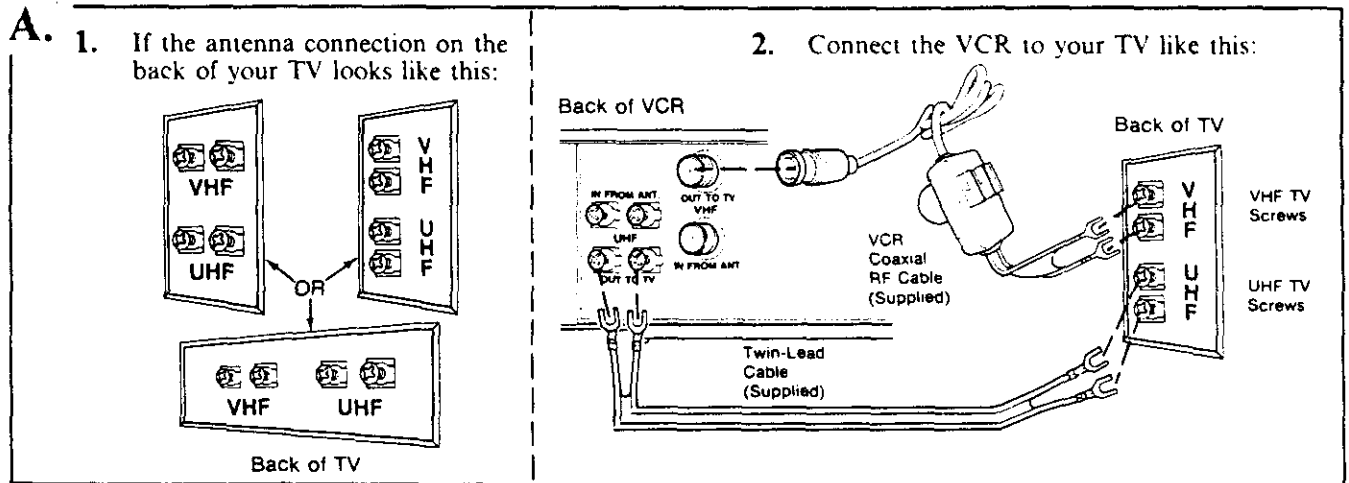

—OR—

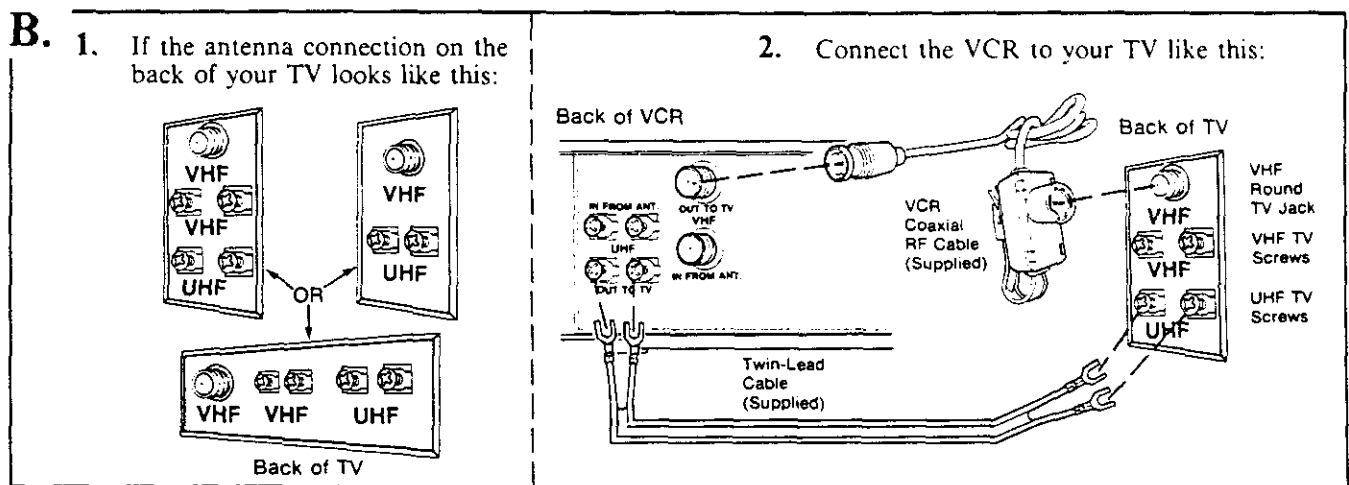

—OR—

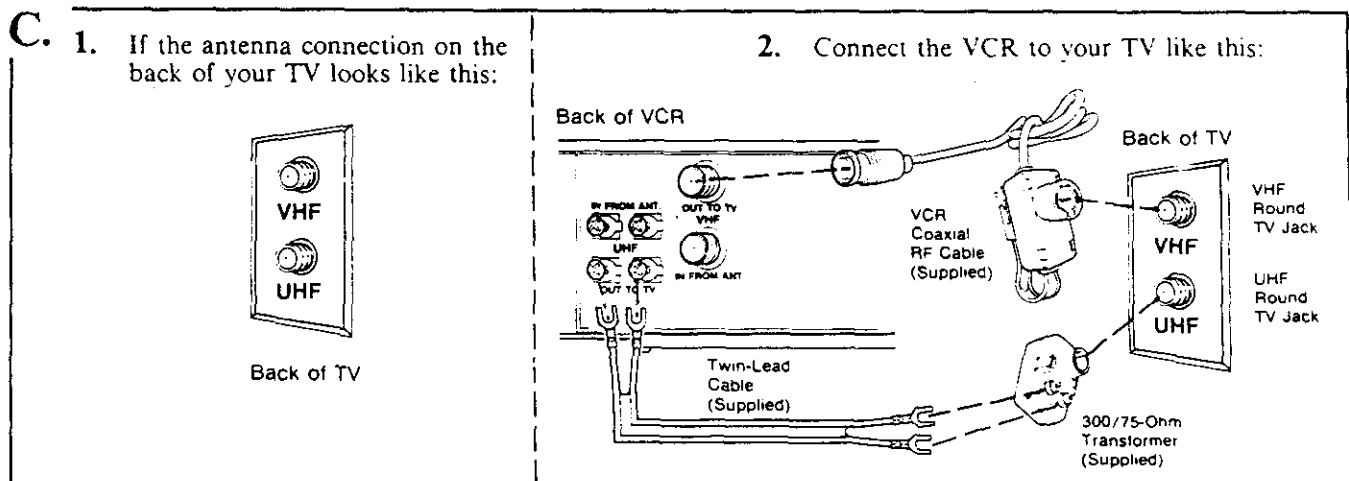

Note: Set the *NORM/CATI* switch on the back of your VCR to the *NORM* position if you connect a home antenna to your VCR.

Cable-TV Connections

Your VCR is designed to receive unscrambled cable channels as shown in the chart below.

CHANNEL NUMBER	CABLE REFERENCE
01	A-8
2-13	2-13
14-36	A-W
95-99	A-5 to A-1

The manner in which you interconnect your VCR and TV with a cable-TV system is dependent primarily on (a) whether your TV is cable-compatible and (b) whether any channels on your cable-TV system are scrambled. Use the Selection Chart at the right to determine which one of the following four Cable-TV connection diagrams (A-D) you should use.

IF YOUR TV IS:	AND YOUR CABLE-TV SYSTEM HAS:	THEN USE DIAGRAM(S):
cable-compatible	no scrambled channels	A
	some or all channels scrambled	B or C or D
not cable-compatible	no scrambled channels	B or C
	some or all channels scrambled	C or D

Note: If you wish to also record one or more local UHF channels that your Cable-TV system does not offer, first follow the appropriate cable-TV connection instructions described below, then connect your UHF antenna to your VCR as described in the section titled "Antenna Connections".

Note: Set the *NORM/CATV* Switch on the back of your VCR to *CATV* if you connect a cable-TV system to your VCR.

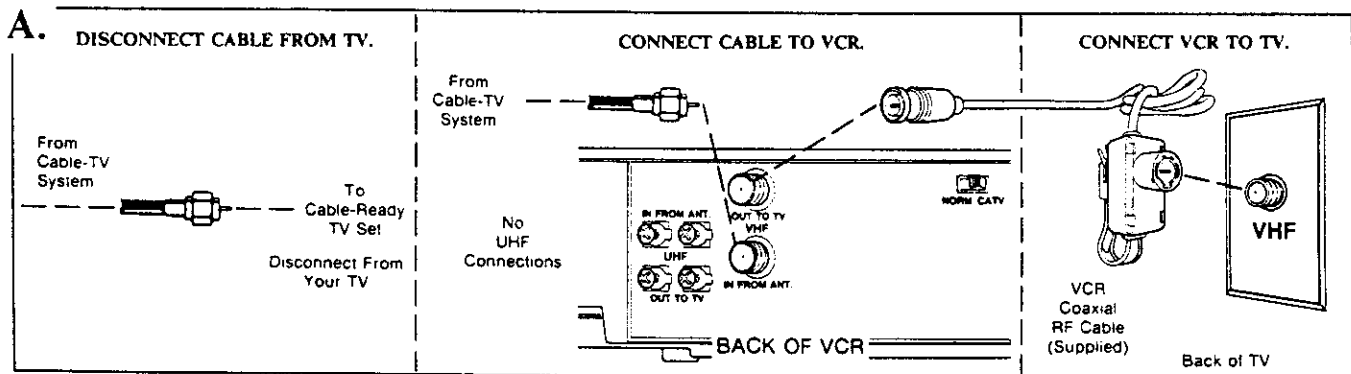

—OR—

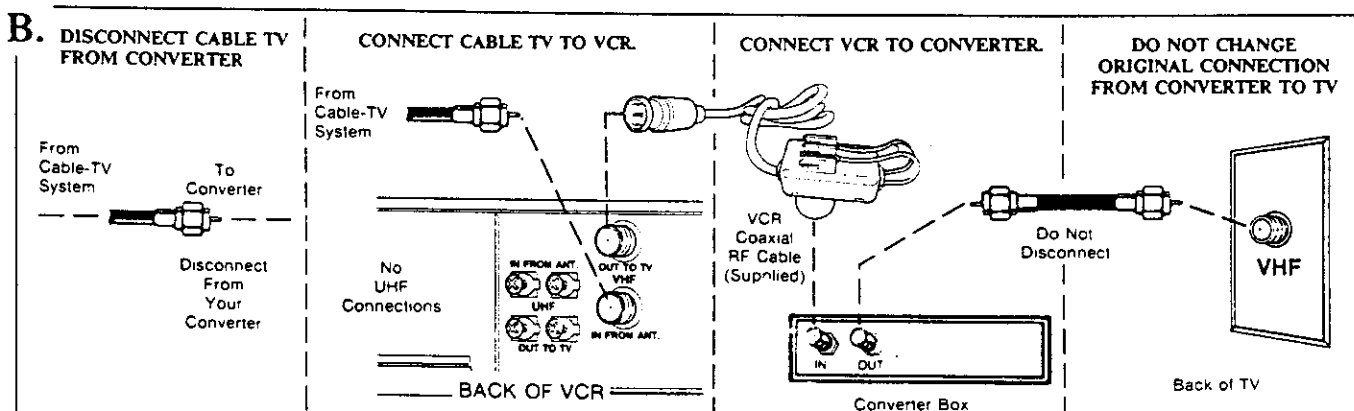

When you use this set of connections, keep your TV tuned to the channel you have been using (usually channel 3 or 4) and use the converter box as you always have for normal TV viewing and for viewing some other channel while you are recording.

When you want to view the channel you are recording, or when you play the VCR, tune the "converter box" to the same channel that you have set the channel switch on the back of the VCR, either channel 3 or 4. (This is called the "VCR channel" throughout the operating instructions in this manual.)

Note: The VCR will not be able to record scrambled channels with this hookup. To record scrambled channels, use hookup D.

C. When you use these connections the A-B switch is used to select either the converter output or the VCR output. This arrangement will let you use your VCR as a "remote-controlled converter box" when you are

not recording, as explained below the diagram.

Note: The VCR will not be able to record scrambled channels with this hookup. To record scrambled channels, use hookup D.

- | | | |
|--|------------------------------------|------------------------------|
| ① Disconnect Cable-TV from converter. | ④ Connect splitter to converter. | ⑦ Connect VCR to A-B switch. |
| ② Disconnect TV from converter cable. | ⑤ Connect splitter to VCR. | ⑧ Connect A-B switch to TV. |
| ③ Connect Cable-TV to input of splitter. | ⑥ Connect converter to A-B switch. | |

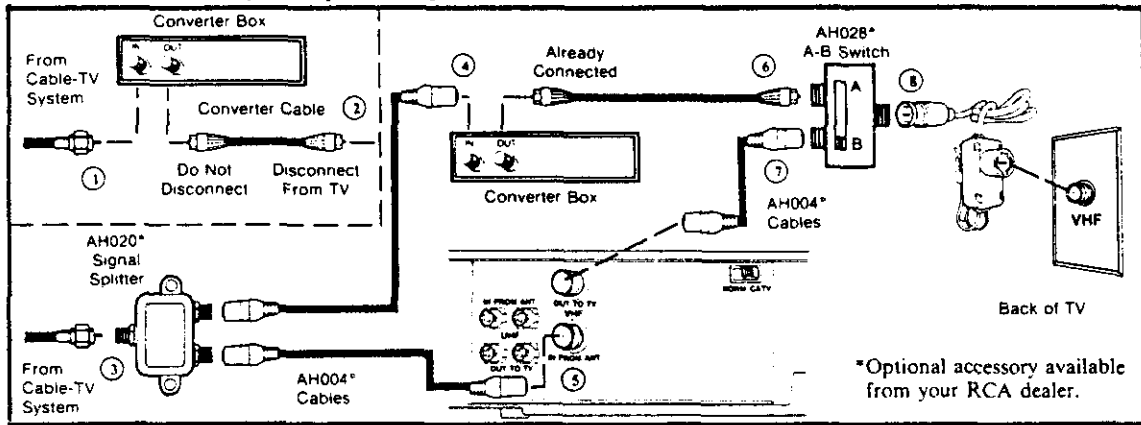

Use "A" Position of A-B Switch For:

- Viewing any cable-TV channel while you record some other channel with the VCR.
- Viewing all scrambled channels.
- Viewing cable channels when the VCR is turned off. (Cable channels 2 through 13 can also be viewed with the VCR turned off and the A-B switch set to position "B.")

Use "B" Position of A-B Switch For:

- Playing a recording.
- Viewing a nonscrambled channel at the same time you are recording it (channel selected with the VCR tuner).

Note: When you set the A-B switch to "B," tune your TV to the same channel that you have selected on the back of your VCR (3 or 4). This is called the "VCR channel" throughout this manual.

—OT—

D. This system requires two "converter boxes" from your cable-TV company, and there may be an additional charge. All channels must be selected with

the converter boxes, both for recording and normal TV viewing.

- | | | |
|--|---|------------------------------|
| ① Disconnect Cable-TV from converter. | ④ Connect splitter to each of the converters. | ⑦ Connect VCR to A-B switch. |
| ② Disconnect TV from converter cable. | ⑤ Connect one converter to A-B switch. | ⑧ Connect A-B switch to TV. |
| ③ Connect Cable-TV to input of splitter. | ⑥ Connect other converter to VCR. | |

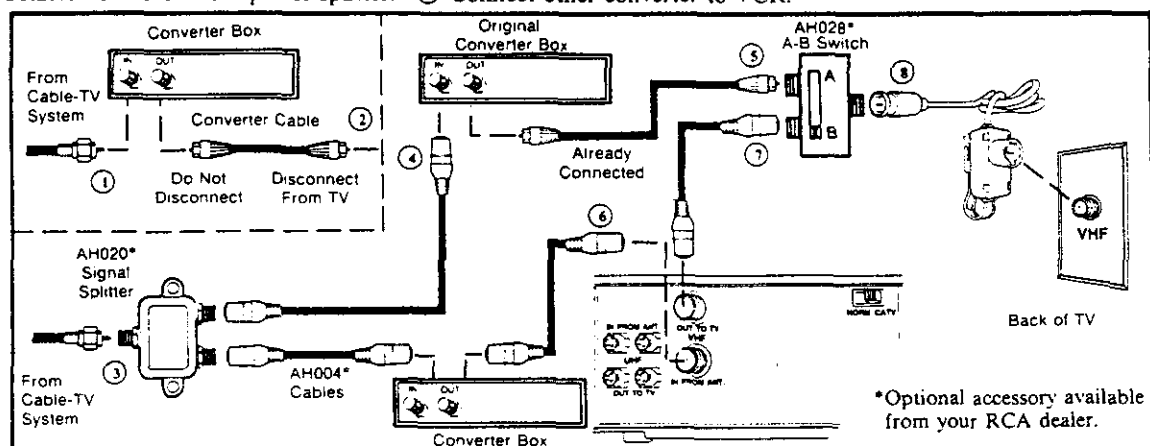

Use "A" Position of A-B Switch For:

- Viewing any cable-TV channel while you record some other channel with the VCR.
- Viewing any cable-TV channel when your VCR is turned off.

Use "B" Position of A-B Switch For:

- Playing a recording.
- Viewing any channel at the same time you are recording it. Select the channel with the converter that is connected to the VCR, and tune the VCR to the output channel of the converter (usually 3 or 4).

Note: When you set the A-B switch to "B," tune your TV to the same channel that you have selected on the back of your VCR (3 or 4). This is called the "VCR channel" throughout this manual.

TV Monitor/Receiver Connections

Direct Video and Audio Connections

Connecting the video output and audio output jacks of your VCR to the corresponding video and audio input jacks of your TV monitor/receiver may produce a slightly better picture during playback. This "direct" signal connection bypasses the TV tuner during playback.

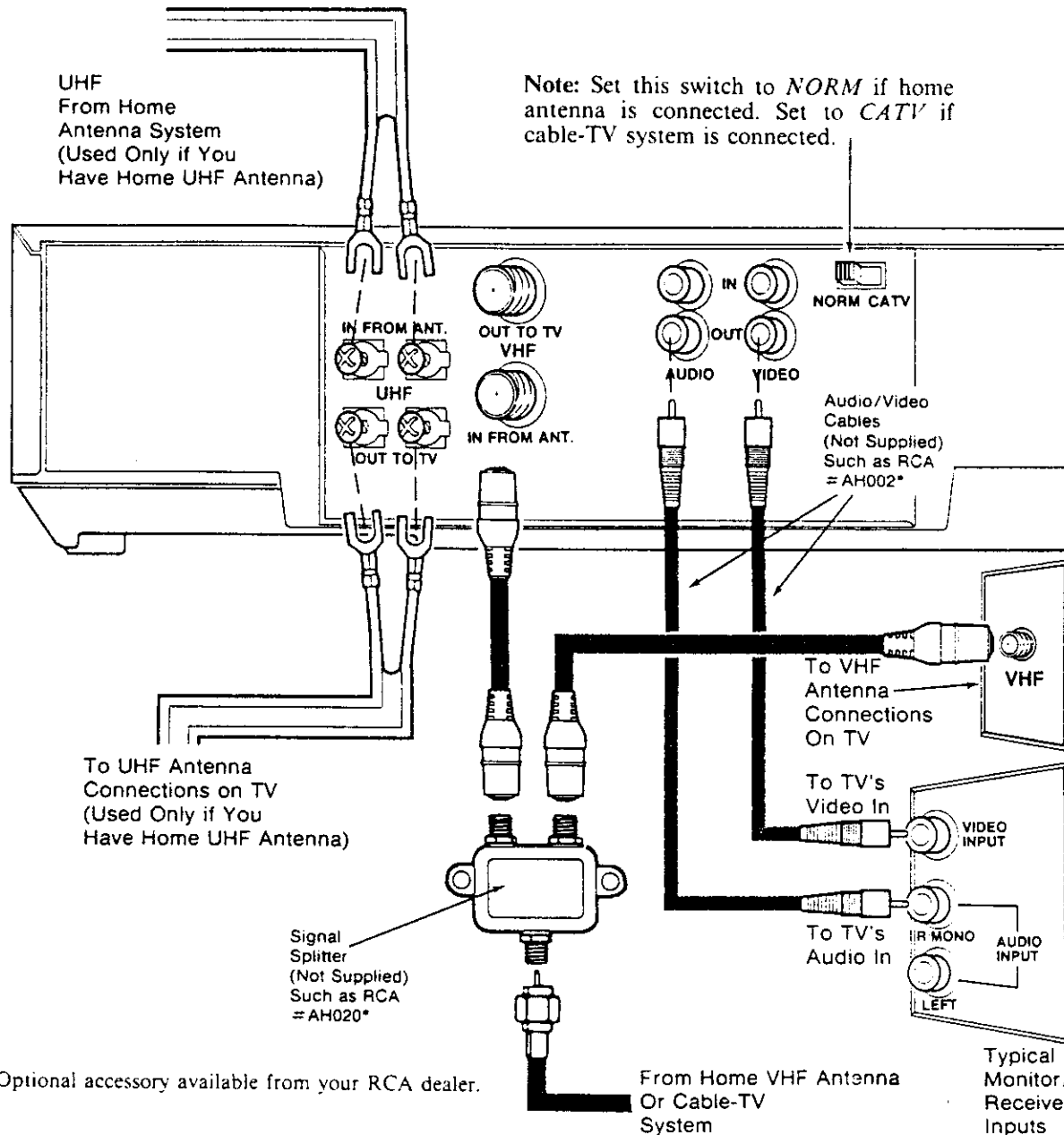

*Optional accessory available from your RCA dealer.

Operating Instructions:

- For normal VHF or cable-TV viewing independent of VCR, place TV Monitor/Receiver in *TUNER* mode and select channels with TV Monitor/Receiver tuner.
- For viewing of channel being recorded, place TV Monitor/Receiver in *VIDEO INPUT* mode. Use VCR tuner to select channel.
- For recording one channel while viewing another, place TV Monitor/Receiver in *TUNER* mode. Use VCR tuner to select channel to be recorded. Use TV Monitor/Receiver tuner to select channel to be viewed.
- For playback of recorded program, place TV Monitor/Receiver in *VIDEO INPUT* mode.

Basic Operation

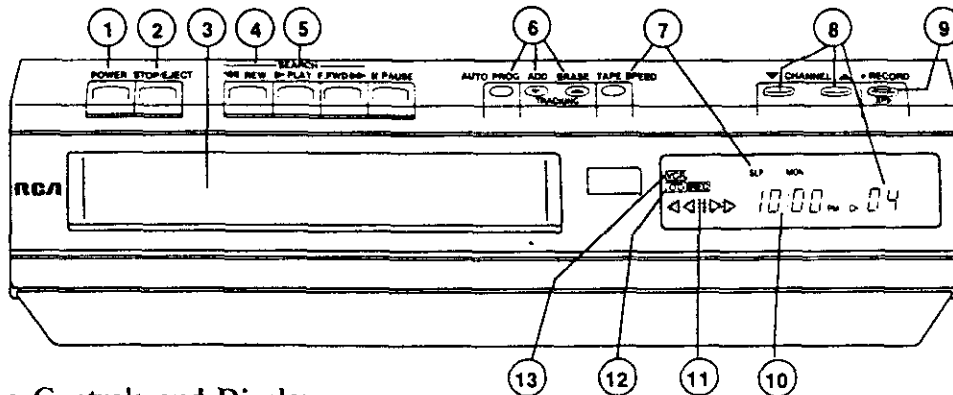

Basic Operating Controls and Displays

Now that you have connected your VCR to your TV and antenna or cable-TV system, you are ready to turn it on. You don't need to know all the details about the controls and displays before you begin using your new VCR, so only those you will use for basic recording and playback are discussed here. (Additional information about the controls is on pages 18 and 19.)

After you have read about the basic control functions on this page, turn on your VCR and check the installation by following the instructions on the next two pages.

- ① **POWER Button:** Turns the VCR on and off. (If the VCR is already off, inserting a cassette will automatically turn it on).
- ② **STOP/EJECT Button:**
 - Stops whatever the VCR is doing (record, playback, rewind, or fast forward).
 - When VCR is stopped, press this button to eject the cassette.
- ③ **Cassette Compartment:** Push the cassette through the door as shown below to load it. Cassette-In indicator ⑫ turns on.
- ④ **REW Button:** Rewinds the tape when the VCR is stopped.
- ⑤ **PLAY Button:** Starts playback. If you insert a cassette with the tab removed, the tape will automatically play.
- ⑥ **AUTO PROG/ADD/ERASE Buttons:** These buttons are used to auto program channels into the VCR and to add and erase channels from the channel memory. Details are on page 12.

- ⑦ **TAPE SPEED Button and Indicators:** Press this button to change recording speed. The lighted indicator tells the tape speed. (Use "SLP" for normal recording.)
- ⑧ **CHANNEL ▼/▲ Buttons and Display:** After channels are programmed, ▼ selects the next lower channel and ▲ selects the next higher channel. The channel number appears in the display.
- ⑨ **RECORD/XPR Button:** Press to begin normal recording. Press twice to enter Express Recording mode.
- ⑩ **Time Display:** The time is normally shown here. If the clock has stopped you will see "—:—" in this area.
- ⑪ **Status Displays:** Tell what the VCR is doing (▷ for playback, **REC** for record, ◀◀ for rewind, ▷▷ for fast forward, 00 for pause). This area is blank when the VCR is turned off.
- ⑫ **Cassette-In Indicator:** Lights when a cassette is in the compartment.
- ⑬ **VCR Indicator:** This indicator is controlled by the TV VCR button on the remote control. It indicates the picture source that is being fed to your TV.
 - VCR Indicator is off when TV receives picture from VHF antenna or cable-TV system as it did before you connected your VCR.
 - VCR Indicator is on when TV receives picture from VCR tuner or tape cassette that is playing. TV must be tuned to VCR Channel (3 or 4) when VCR indicator is on.

Inserting and Removing Cassettes

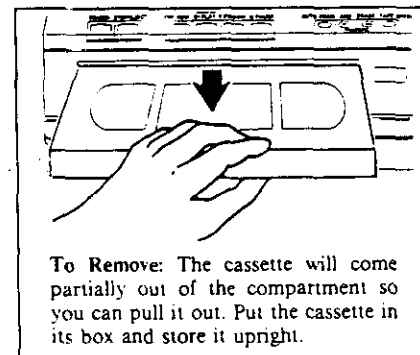
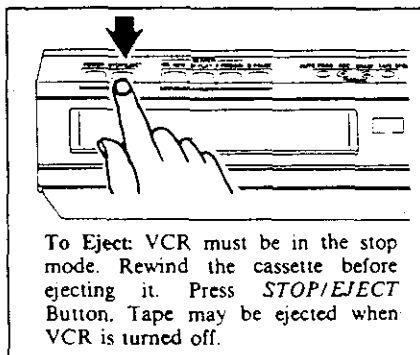
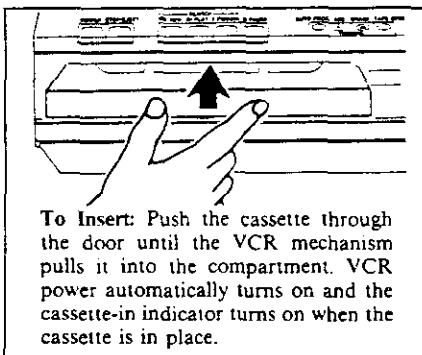

Basic Operation (continued)

Turning on Your VCR for the First Time

When you have finished connecting the cables to your antenna and TV, plug in the VCR's power cord and press *POWER*.

Programming Active Channels into VCR's Tuner

The *AUTO PROG* (Automatic Programming) button makes it easy and convenient to program TV stations into the VCR's scan list. The scan list is the list of channels that your VCR tuner stops on when you press the *CHANNEL ▲* or *CHANNEL ▼* button. The scan list is empty, however, until you program active channels as described below.

Note: You must program the tuner as described below before you can use *CHANNEL ▲/▼* buttons. Automatic programming is usually a "one-time" procedure, but you will need to repeat it if you move to a location that has different channels, or if power is interrupted.

To program active channels:

1. Turn on VCR by pressing the *POWER* button.
2. Set the *NORM/CATV* switch on the back of the VCR.



- Set to *NORM* position if your VCR is connected to a home antenna system.
- Set to *CATV* position if your VCR is connected to a cable-TV system.

3. Press and release the *AUTO PROG* button.

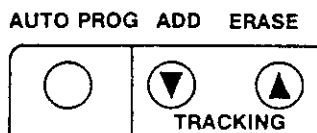

- The tuner will automatically cycle through all available channels in the area and place them in the scan list. This takes about a minute. The channel numbers will stop changing when the tuner is finished cycling. Programming is now complete and you can use the *CHANNEL ▲/▼* buttons to select channels.
4. If you want to erase or add individual channels from the scan list, refer to the instructions at the right.

Erasing Channels from the Scan List

You may want to have only a few favorite channels in the scan list so you can select them more quickly with the *CHANNEL ▲* and *▼* buttons. (Use the numbered buttons on the remote control to select channels you erased from the scan list.)

Occasionally Automatic Programming may include a vacant channel in the scan list if there happened to be some sort of "noise" or "stray signal" on the channel when the tuner was programmed. This procedure explains how to erase any unwanted channels from the scan list.

1. Use the *CHANNEL ▲* or *▼* button to select the channel that you want to remove from the scan list.
2. Press *ERASE*.
3. Repeat the procedure for each channel you want to erase from the scan list.

Adding Channels to the Scan List

You may have erased a channel from the scan list and want to put it back. Occasionally Automatic Programming may "miss" an active channel because the signal is very weak or because the channel happened to be "off the air" when the tuner was programmed. Use this procedure to put any channel in the scan list.

1. Use the numbered buttons on the remote control to select the channel you want to add to the scan list.
2. Press *ADD*.
3. Repeat the procedure for each channel you want to add to the scan list.

Note: Channel 91 is used to access other devices you may have connected to the *AUDIO/VIDEO IN* jacks on the back of your VCR. You can add Channel 91 to the channel scan list.

1. Press "9" then "1" on the remote control.
2. Press the *ADD* button on the VCR.

The *LINE* indicator will appear in the VCR display when Channel 91 is used to access a device you have connected to the *AUDIO/VIDEO IN* jacks; such as a satellite receiver, camera, or another VCR.

Setting Your TV to the VCR Channel

The "VCR Channel" is the TV channel you use for viewing what the VCR is recording or playing, and for viewing the signal from the VCR tuner when it is stopped. Your TV must be set to this channel, and the **VCR** indicator in the display must be on.

Selecting the VCR channel is normally a one-time procedure, since there is little reason ever to change it. Proceed as follows:

1. Decide whether you want to view your VCR on Channel 3 or Channel 4 of the TV. If one of these channels is vacant in your area, you should use it. Otherwise, pick the channel you view less.
2. Set the channel switch (*CH3/CH4*) on the back of the VCR to whichever channel you have chosen, and then turn on your TV and tune it to the same channel. This is the "VCR channel."

Using the TV VCR Button

1. Push the *TV VCR* button on the remote control so the **VCR** indicator is on. When the indicator is on, the VCR is in the "VCR mode" and your TV must be tuned to the VCR Channel (channel 3 or 4). Your TV will then display whatever tape the VCR is playing or whatever channel the VCR is tuned to.
2. Push the *TV VCR* button on the remote control again so that the **VCR** indicator is out. When the indicator is out, the VCR is in the "TV mode" and your TV will work like it did before you connected the VCR.

The *TV VCR* button on the remote control allows you to record one program with the VCR while you watch another program on your TV. To do this, first put the VCR in the "VCR mode" (**VCR** indicator on) and start recording the program. Then press the *TV VCR* button to switch to the "TV mode" (**VCR** indicator out) and tune your TV to the other channel you want to watch.

Note: Your VCR automatically switches to the "VCR mode" (**VCR** indicator on) when you turn it on with the *POWER* button, and when you start playing a tape.

Simplified Installation Checklist

This simplified checklist will help you quickly determine if you have completed all the basic installation steps.

- [] Make sure your VCR is connected properly as explained on pages 4-10.
- [] Press *POWER* to turn on VCR.
- [] Set *NORM/CATV* switch on the back of the VCR to the *NORM* position if you have connected a home antenna system. Set the switch to the *CATV* position if you have connected cable-TV system.
- [] Program active channels into VCR's scan list (press *AUTO PROG* and wait about one minute).
- [] *ERASE* or *ADD* individual channels into scan list as desired. (Detailed instructions on page 12.)
- [] Select "VCR Channel".
First set the *CH3/CH4* switch on the back of the VCR to either channel 3 or 4 and then tune your TV to the same channel. This is called the "VCR Channel".
- [] Learn how to use the *TV VCR* button on the remote control.
 - When you press the *TV VCR* button and the **VCR** indicator in the display turns on, the VCR is in the "VCR mode" and your TV must be tuned to the VCR Channel (channel 3 or 4). Then your TV will display whatever tape the VCR is playing or whatever channel the VCR is tuned to.
 - When the **VCR** indicator in the display is out, the VCR is in the "TV mode" and your TV will work like it did before you connected the VCR.

Remote Control

Before you use the remote control unit supplied with your VCR, install the batteries (instructions below). Several of the remote's buttons do the same things as buttons with the same names on the top of your VCR, and you can use whichever one is more convenient at the moment.

The remote control has additional buttons for controlling some of the VCR's special features, and it is also used for setting the clock and programming the timer.

Since the remote control operates the VCR by infrared light, it is immune to electrical and sound interference. However, you must aim the remote control directly at the VCR. There cannot be any obstructions between them.

Battery Installation

The batteries supplied with your remote control are packed separately. Here's how to install them:

1. Turn the remote control over and remove the cover of the battery compartment.
2. Insert the batteries so that their positive (+) ends contact the positive terminals in the battery compartment. These are marked (+) in the bottom of the compartment.
3. Replace the cover.

Remote Control
(Back View)

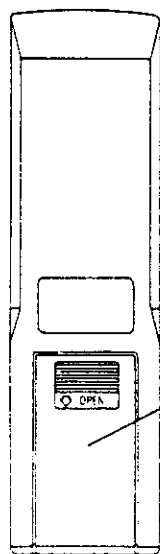

Battery
Compartment
Cover

Notes:

- Never place anything heavy on top of the remote control or lay it upside-down. This may accidentally depress the buttons for a long time and discharge the batteries.
- Replace the batteries when the VCR fails to respond to the remote control.
- Remove the batteries from the remote control if it will not be used for a month or more. This will prevent possible damage from battery leakage.

Location and Function of Remote Control Buttons

- ① **POWER Button:** Turns the VCR on and off. (If the VCR is off, inserting a cassette will automatically turn it on.)
- ② **Number Buttons (0 through 9):** Select any channel (whether or not it is in the Tuner Scan List) by pressing two buttons. (Press 0 and then 8 for Channel 8.) The numbered buttons are also used for setting the clock and programming the timer.
- ③ **Channel ▲ and ▼ Buttons:** Use these buttons to select the next channel up or down programmed in the scan list.
The VCR tuner must be programmed for the Channel ▲ and ▼ buttons to work. Details are on page 12.
- ④ **PROGRAM Button:** Used to set the clock and program the timer with use of the on-screen display on your TV.
- ⑤ **PAUSE Button:** Pressing the *PAUSE* button during recording stops the tape so that nothing will be recorded. When you press the *PAUSE* button again, recording resumes immediately.
Pressing *PAUSE* during playback produces a stop-action picture, and pressing it again resumes normal playback. Details are on page 20.
- ⑥ **CLEAR Button:** Used to clear incorrect information when programming the timer. Also used to clear a timer program or to reset the Tape Counter to "0000".
- ⑦ **DISPLAY Button:** Controls on-screen displays.
 - Press once to bring normal displays to TV screen.
 - Press twice to display Tape Counter and turn on counter memory.
 - Press three times to remove all displays from TV screen.

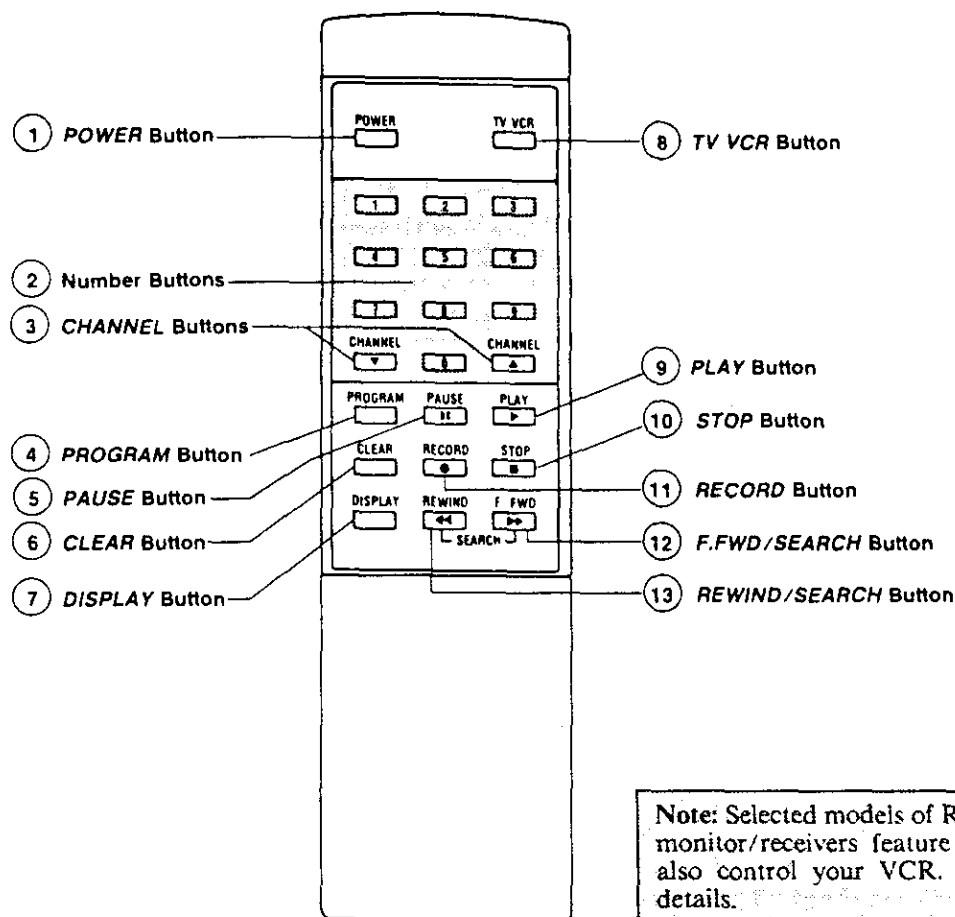

Note: Selected models of RCA color TV receivers and monitor/receivers feature remote controls that will also control your VCR. See pages 32 and 33 for details.

- ⑧ **TV VCR Button:**
- Turns the **VCR** indicator in the display panel on and off.
 - When the **VCR** indicator is displayed, your TV must be tuned to the VCR channel (3 or 4). Signals come thru the VCR tuner and you select channels with the VCR **CHANNEL** buttons.
 - When the **VCR** indicator is off, signals are bypassing the VCR and going right to the TV. So, you can select channels with the **CHANNEL** buttons on the TV.
 - This button lets you record one channel while you're watching another channel. Details are on page 13.
- ⑨ **PLAY Button:** This button is used to begin playback when the VCR is stopped. The **PLAY** button is inactive when the VCR is recording.
- ⑩ **STOP Button:** Stops whatever the VCR is doing (record, playback, fast forward, or rewind).
- ⑪ **RECORD Button:** Press the **RECORD** button to start recording when the VCR is stopped.
- ⑫ **F.FWD/SEARCH ►► Button:** This is the fast forward button when the VCR is stopped. Once you have pressed it, the tape will continue to "fast forward" until you press the **STOP** button (or to a counter reading of "0000" if the tape counter is displayed). If you do not press the **STOP** button, the VCR will fast forward to the end of the tape and then automatically rewind to the beginning of the tape and stop.
- During playback, press this button to search forward at a faster speed. Press it again (or press **PLAY**) to return to normal playback. Details are on page 20.
- The **F.FWD/SEARCH** Button is inactive during recording.
- ⑬ **REWIND/SEARCH ◀◀ Button:** When the VCR is stopped, this button rewinds the tape to the beginning (or to a counter reading of "0000" if the tape counter is displayed).
- During playback, press this button to search backwards. Press it again (or press **PLAY**) to return to normal playback.
- The **REWIND/SEARCH** button is inactive during recording.

Setting the Clock

Here are some things you should know before you set the clock:

- When you first plug in your VCR, the clock will read “—:—”.
- The buttons for setting the clock are on the remote hand unit.
- While you are setting the clock, the display on the TV screen will prompt you through the procedure.
- If you press a wrong digit, press *PROGRAM* and then start at beginning.
- The clock must be set to the correct time before you can program the timer for unattended recordings or use Express Recording (XPR).
- If power is interrupted, you may have to reset the clock and re-enter your programs in the timer.

[1] Turn on your VCR and TV. Tune your TV to the VCR Channel (channel 3 or 4). The VCR Channel is explained on page 13.

Press *PROGRAM* on the remote control.

This “menu” will appear on the TV.

```

TO SELECT MODE
PUSH NUMBER SHOWN

1 CLOCK SET
2 NORMAL PROGRAM
3 DAILY (M-F) PROGRAM
4 WEEKLY PROGRAM
5 PROGRAM REVIEW

TO END PUSH PROGRAM
    
```

Press “1” to set the clock

[2] The display prompts you to set the time.

```

CLOCK SET
TIME 02:15
MONTH/DAY/YEAR
DATE 07/02/89
TO END PUSH PROGRAM
    
```

Set the time by pressing two digit buttons on the remote for the current hour and two more for the minute.

(For example, press 0 2 1 5 for 2:15.)

Note: The *CLEAR* button does not operate in clock set. If you make a mistake, press *PROGRAM* and start again.

[3] The display prompts you to select AM or PM.

```

CLOCK SET
TIME 02:15
--AM-1 PM-2-
MONTH/DAY/YEAR
DATE 07/02/89
TO END PUSH PROGRAM
    
```

Press “1” for AM or press “2” for PM.

Remember: Noon is 12:00 PM
Midnight is 12:00 AM

[4] The display prompts you to set the date.

```

CLOCK SET
TIME 02:15 PM
MONTH/DAY/YEAR
DATE 07/02/89
TO END PUSH PROGRAM
    
```

Set the date by pressing six digits in order for the month, day, and year. (For example, press 0 7 0 2 8 9 for July 2, 1989.)

Always press “0” before single-digit months and days.

[5] The day of the week will appear when you have entered all six digits for the date.

```

CLOCK SET
TIME 02:15 PM
MONTH/DAY/YEAR
DATE 07/02/89
SUN
TO END PUSH PROGRAM
    
```

Press *PROGRAM* to start the clock. (Note that the display on the VCR will show the correct time after you press *PROGRAM*.)

Press *PROGRAM* again to return to the program you were watching.

First Recording and Playback

This page gives the basic steps for recording and playback. You should practice them until you can do them without referring to the manual. To save time, we suggest you record for only two or three minutes.

The first drawing shows how to make a recording and the second one shows how to play it back and turn off the VCR. The operating notes at the bottom of the page are keyed to the step numbers for quick reference if you have a problem or need more information.

Making a Recording

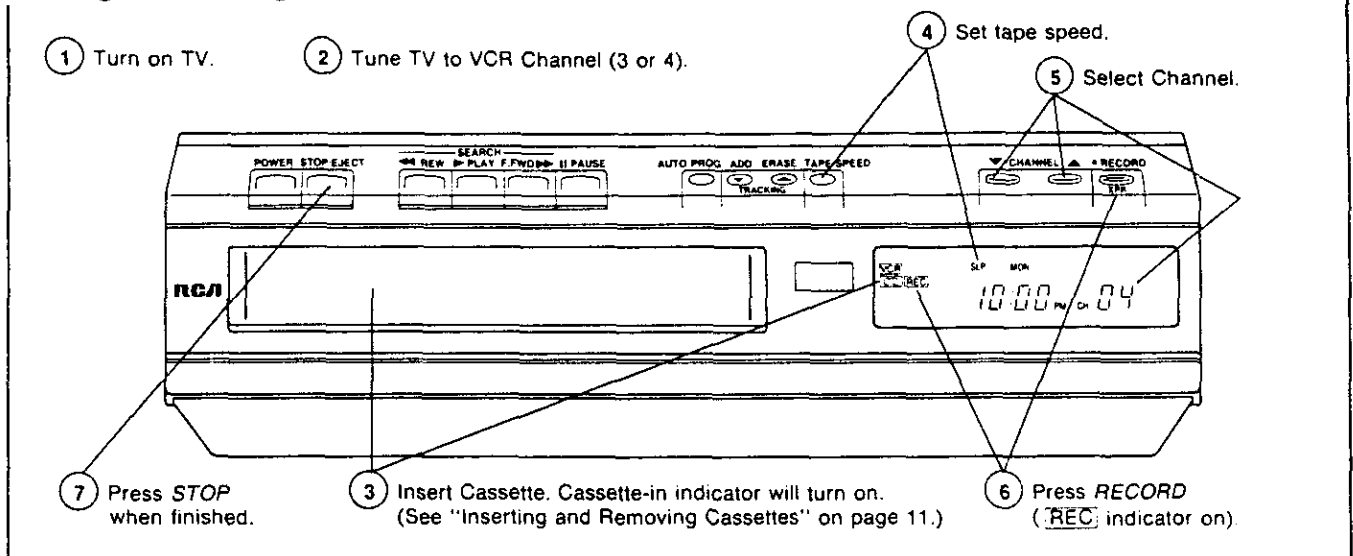

Playing It Back

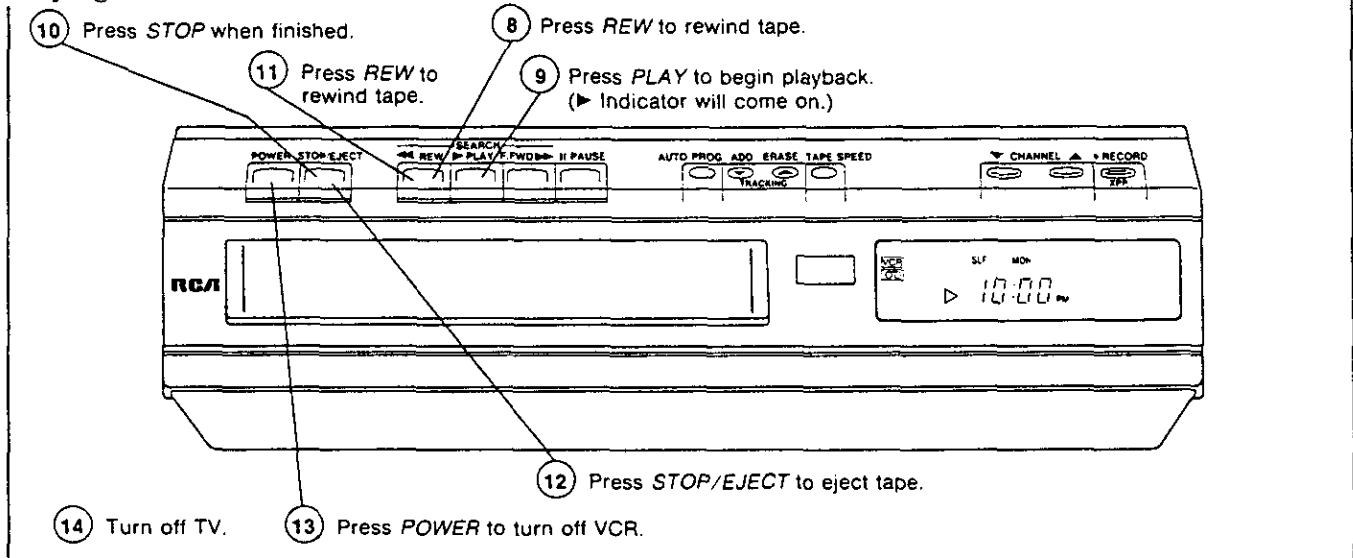

Operating Notes

- 2 The CH3/CH4 channel switch on the back of the VCR and the channel selector on your TV must be set to the same channel in order to see the picture from the VCR. Details are on page 13.
- 3 The VCR automatically turns on when a cassette is inserted.

The VCR automatically enters playback mode when a cassette without a record-protect tab is inserted. The VCR will eject a cassette without a record-protect tab when the RECORD button is pressed. Details are on page 26.

- 8 ◀◀ appears in the display during rewind.

Operating Controls (Detailed Descriptions)

Basic operation of the controls is given on page 11. Now that you are familiar with the basic procedure for recording a TV program and playing it back, you are ready to learn the rest of the control functions.

The controls of your VCR are designed so that:

- Accidentally pressing a wrong button will not damage the VCR or the cassette.
- Non-essential buttons are disabled during recording to help you avoid accidental interruptions.

- Operation of the VCR is automatic whenever possible.
- Automatic recording functions (Timer and XPR) will not disturb normal TV viewing.
- If you run out of tape during playback or normal recording, the VCR rewinds the tape and stops automatically. If tape runs out during Timer or Express Recording, the VCR stops without rewinding.
- Because of these features, the functions of some control buttons depend on the operational mode of the VCR at the time they are used.

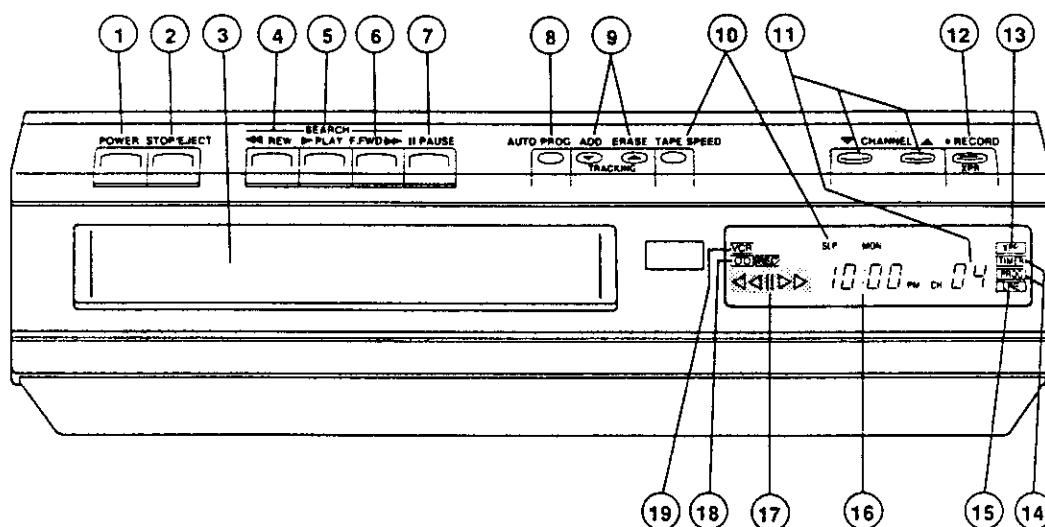

- ① **POWER Button:** When the VCR is turned off, the timer is automatically turned on if it has been programmed. When the VCR is turned on, the timer is automatically turned off. Your VCR will not make a timer recording if it is already turned on at the time the recording is to start.

The *POWER* button operates differently during Timer and Express recording. Press *POWER* and then *STOP* to stop the VCR when a timer recording is in progress.

The VCR will stop and turn off if you press the *POWER* button during non-timer recording, playback, or fast forward.

- ② **STOP/EJECT Button:** This button stops normal functions of the VCR or ejects the tape when the VCR is in the Stop mode.

- Press to stop the normal functions of record, play, rewind, fast forward, recording pause, and stop-action pause.
- When the VCR is in the Stop mode, press this button to eject the cassette.

- ③ **Cassette Compartment:** Push the cassette through the door to load it. Always insert the cassette with the window up. The Cassette-in indicator ⑱ will light when a cassette is inserted properly.

- ④ **REW/SEARCH ◀◀ Button:** This is the *REWIND* button when the VCR is stopped. Once you have pressed it, the VCR will rewind to the beginning of the tape (or to a counter reading of "0000" if the counter is displayed) unless you press the *STOP* button. The ◀◀ indicator ⑰ will appear in the display during rewind.

This same button becomes *Reverse SEARCH* ◀◀ when the VCR is playing. Press to start searching in reverse. Press it again (or press *PLAY*) to return to normal playback. Picture Search is explained on page 20.

The *REW/SEARCH* button is inactive during recording.

- ⑤ **PLAY Button:** The *PLAY* button is used to begin playback when the VCR is stopped. The *PLAY* button is inactive when the VCR is recording.

Press *PLAY* during forward or reverse search to return to normal playback.

- ⑥ **F.FWD/SEARCH ►► Button:** This is the *FAST FORWARD* button when the VCR is stopped. Once you have pressed it, the tape will continue to "fast forward" until you press the *STOP* button (or to a counter reading of "0000" if the counter is displayed). If you do not press the *STOP* button, the VCR will "fast forward" to the end of the tape and then automatically rewind to the beginning of the tape and stop. Refer to "Memory Stop" on page 21 for more information. The ►► indicator ⑬ will appear in the display during fast forward. This same button becomes the *FORWARD SEARCH ►►* button when the VCR is playing. Press to begin searching forward. Press it again (or press *PLAY*) to return to normal playback. Picture Search is explained on page 20. The *F.FWD/SEARCH* button is inactive during recording.
- ⑦ **PAUSE Button:** Pausing during a recording stops the tape so that nothing will be recorded. When you press the *PAUSE* button a second time, recording resumes immediately. Pausing during playback produces a Stop-Action picture, and pressing it again resumes normal playback. Details are on page 20.
- ⑧ **AUTO PROG (Program) Button:** This button is used to automatically program active channels into the VCR channel memory so channels can be selected with the *CHANNEL ▼/▲* buttons ⑪. Details are on page 12.
- ⑨ **ADD/ERASE or TRACKING Buttons:**
- The *ADD/ERASE* buttons are used to add or erase channels from channel memory after the tuner has been auto programmed. Details are on page 12.
 - During *PLAY*, these buttons become the *TRACKING* buttons. When you play a tape that has not been recorded on the same VCR, streaks may appear. Push the *TRACKING* button ▼ or ▲ to move the streaks up or down and out of the picture. The *TRACKING* buttons have no effect during recording.
- ⑩ **TAPE SPEED Button and Indicator:** Push to change the tape speed for recording. Tape speed for playback is automatically selected by the VCR. The tape speed is displayed in the front panel display. We suggest using SLP for most recording. **SLP:** Super Long Play gives you the longest recording time. SLP has slightly more "picture noise" than SP in normal playback (which may not be noticeable). *Your VCR's special effects (search and stop action) are designed for optimum performance at the SLP speed.* See page 26 for more information on choosing a tape speed.
- ⑪ **CHANNEL ▼/▲ Buttons:** After channels are programmed as described on page 12, pressing ▼ selects the next lower channel and pressing ▲

selects the next higher channel. The channel number appears in the display.

- ⑫ **RECORD/XPR Button:** This button is the *RECORD* button when the VCR is stopped, and the *XPR* (Express Recording) button when the VCR is in the *RECORD* mode.
- Press the *RECORD/XPR* button when the VCR is stopped to begin recording.
 - Press the *RECORD/XPR* button when the VCR is recording to activate the express recording feature. Set and increase the amount of express recording time by pressing this button additional times (30 minutes to 4 hours). Details are on page 25.
- ⑬ **XPR Indicator:** The **XPR** Indicator turns on when the express timer ⑫ has been activated.
- ⑭ **TIMER and PROG (Program) Indicators:**
- The **PROG** Indicator will appear when the timer has been programmed.
 - The **TIMER** indicator will appear when the timer has been programmed, and the power has been turned off.
 - The **TIMER** Indicator will flash if you have forgotten to insert a cassette.
 - Details are on pages 22-24.
- ⑮ **LINE Indicator:**
- This indicator turns on when channel 91 has been selected with the *CHANNEL ▼/▲* buttons or by pressing "9" then "1" on the remote control.
 - Channel 91 and the **LINE** indicator are used whenever you want to view or record signals from a device connected to the *AUDIO* and *VIDEO IN* jacks on the back of the VCR.
- ⑯ **Time Display**
- The time is normally shown here. If the clock is not set, you will see "—:—" in this area. The clock must be set for Express and Timer Recording. Details for setting the clock are on page 16.
- ⑰ **Status Display:** This display indicates what the VCR is doing: ► for playback; **REC** for record; ◀◀ for rewind or search; ►► for fast forward or search; || for pause. This area is blank when the VCR is turned off.
- ⑱ **Cassette-In Indicator **OO**:** This indicator lights when a cassette is properly inserted in the VCR.
- ⑲ **VCR Indicator:** This indicator lights when the TV is fed signals from the VCR. Press the *TV VCR* button on the remote control to turn the **VCR** indicator on and off. Details are on page 13.

Special Effects and Features

Pause During Recording

- Press the *PAUSE* button when you are recording to prevent recording short passages of unwanted material.
- Press the *PAUSE* button again when you are ready to resume recording.

Caution: Avoid pausing for more than three or four minutes, because the spinning heads that do the recording are still in contact with the tape and will eventually wear off the active material. This can cause streaks or spots in the picture when you play the worn part of the tape (called dropouts).

For this reason the VCR will automatically switch from Pause to Stop after about five minutes.

Pause for Stop-Action Playback

Press the *PAUSE* button during playback to stop the action. This lets you examine all the details of the scene—similar to looking at a single frame of a movie film. When you are ready to resume normal playback, press the *PAUSE* button again.

The following suggestions will help you get the most out of this feature:

- Stop Action is designed to work best at the SLP speed. For the best special effects performance and the longest recording time, SLP speed is recommended.
- The stop-action picture may tend to jump up and down slightly. Adjust the control marked *V.LOCK* on the back of the VCR to reduce this jitter. Once you have made this adjustment, you probably won't have to do it again unless you use stop-action on a tape that was recorded on a different VCR. (A small amount of vertical jitter is normal.)
- Using stop-action on a single frame of the picture for a long time can wear the tape, as explained in "Pause During Recording". For this reason you should use *STOP* instead of *PAUSE* to interrupt playback for an extended time. The VCR will automatically switch from Pause to Stop after about five minutes.

Picture Search

- The buttons for rewind (*REW*) and fast forward (*F.FWD*) become the picture-search buttons when you are playing a tape.
- When you press *F.FWD/SEARCH* while playing a tape, the VCR plays at a higher speed than normal play. To return to normal playback, press *F.FWD/SEARCH* again or press the *PLAY* button.
- When you press *REW/SEARCH*, the VCR reverses from the normal direction and plays the tape backward at high speed. Press *REW/SEARCH* again or press the *PLAY* button to return to normal playback.
- The sound is turned off during picture search because it would not be understandable at the high speed.
- Expect to see some horizontal lines or bars in the picture when you are searching. The picture will be best for tapes recorded at SLP speed, although it can be viewed from tapes recorded at the other speeds.

Note: During picture search noise bars may interfere with the tape counter display, press the *TRACKING* ▼ or ▲ button to move the noise bar up or down.

Be sure to reset the *TRACKING* for the best picture when you go back to play.

Tracking Control

- When you play tapes that were not recorded on the same VCR, streaks may appear in the picture. Adjust the *TRACKING* ▼ or ▲ button to move the bars up or down and out of the picture.
- The *TRACKING* buttons only affect tape playback. They have no effect during recordings.

Tape Counter

If you always reset the tape counter when you insert a tape, you can note the counter reading at the beginning of each program you record for future reference. The label kit provided with RCA tapes can be used to list programs and counter readings.

1. Turn on your TV and tune it to the VCR channel (3 or 4).
2. Press *DISPLAY* button twice on the remote control to display the tape counter on the TV screen.
3. Press *CLEAR* button on the remote control to set the counter to "0000".

On-Screen Display

Whenever you turn on your VCR or change its status—stop to play, play to stop, change channels, etc.—the new status of the VCR is displayed on the TV screen automatically.

You can manually call up the VCR status display to the screen when desired by pressing *DISPLAY* on the remote control. The display will disappear from the screen in a few seconds.

- Press the *DISPLAY* button once to call up the normal display.
- Press the *DISPLAY* button twice, to call up the tape counter display. This display will remain on the TV screen.
- Press the *DISPLAY* button three times to remove all displays from the screen.

Memory Stop

- When you press the *DISPLAY* button on the remote control twice to turn on the counter display, you automatically turn on the "Memory Stop" feature. When the counter is displayed on the TV screen and in the VCR's display, the VCR will stop automatically at "0000" whenever you use the *REW* or *F.FWD* button. If you are rewinding, simply press the *REW* button again to continue to the end of the tape.
- If you press the *F.FWD* button and the counter never reaches "0000" between that point and the end of the tape, the VCR will continue to the end of the tape, switch to rewind, and then stop when the counter reaches "0000".
- Since you can reset the counter to "0000" at any point on the tape, memory stop is convenient for finding the beginning of a recording or the beginning of a particular segment you want to repeat.
- This is the procedure to use when you are going to start recording somewhere beyond the start of the tape.
 1. Turn on the VCR and press the *DISPLAY* button on the remote control twice to obtain the counter reading.
 2. Use the *F.FWD* and *STOP* buttons to locate the point where you will begin recording. Press the *CLEAR* button on the remote control before you begin recording.
 3. Press *STOP* when you are finished recording, and then press the *REW* button. The cassette will rewind to counter reading "0000" and stop.
 4. Press *PLAY* to view the segment you have selected, or press *REW* to rewind the cassette completely.
- Use this procedure during playback to mark a point to be repeated.
 1. Press the *DISPLAY* button on the remote control twice to display the counter.
 2. When you see the beginning of the part you wish to view several times, use *SEARCH* ◀◀ to locate a point slightly before the desired scene.
 3. Press the *PLAY* button to resume normal playback, and then press *CLEAR* on the remote control just before the desired scene appears.
 4. When you have played to the end of the scene in question, press *STOP* and then *REW*. The tape will rewind to the beginning of the scene and stop.
 5. Press *PLAY* to view the scene again.
 6. Repeat Steps 4 and 5 as many times as you like.

Programming the Timer

The programmable clock/timer permits unattended recording of up to four different TV programs. The timer is actually a small computer which will turn on the VCR at the time you select, record for a selected length of time, and then turn off the VCR... all automatically without you being there.

You can program the timer to do the following:

- Record a program on a single day up to one year away. [NORMAL PROGRAM]
- Record a program at the same time Monday through Friday. [DAILY PROGRAM]
- Record a program on one certain day of every week. [WEEKLY PROGRAM]

Things to know before you start:

- You can program the timer up to one year before the TV program is to be recorded.
- You can correct an error in the program any time before the last step by pressing the *CLEAR* button on the remote control repeatedly until the digit to be corrected is flashing. Then enter the correct digit and continue the programming sequence.

Simplified Programming Instructions

1. Turn on VCR.
2. Turn on TV and tune it to the VCR channel (channel 3 or 4).
3. Press *PROGRAM* on remote hand unit.
4. Watch the display on the TV screen—it will prompt you through the rest of the programming exercise.
5. Insert a cassette tape with its safety tab intact. (Rewind the tape if necessary.)
6. Turn off the VCR.

[1] Turn on your VCR and TV. Tune the TV to the VCR channel (channel 3 or 4) so you'll be able to see the programming display on the TV screen.

Make sure the VCR's clock is set to the correct time. The timer cannot record at the right time if the clock is set incorrectly. Reset the clock if necessary.

Press *PROGRAM* on the remote hand unit.

The programming "menu" appears on the TV screen.

```

TO SELECT MODE
PUSH NUMBER SHOWN
1 CLOCK SET
2 NORMAL PROGRAM
3 DAILY (M-F) PROGRAM
4 WEEKLY PROGRAM
5 PROGRAM REVIEW
TO END PUSH PROGRAM
    
```

Press "2" to enter a Normal Program, "3" to enter a Daily Program, or "4" to enter a Weekly Program.

The display will prompt you to select a Program Number.

[2] Four program numbers are available and you can enter different programming instructions in each one. All four program numbers will be flashing because none of them have been used. If the timer has been programmed, the number that was used will stay on instead of flash. You must clear a program number before the same number can be used again. See "Clearing a Timer Program" on the next page.

```

NORMAL PROGRAM 1234
SELECT PROG NUMBER
TO END PUSH PROGRAM
    
```

Press a digit from 1 to 4 on the remote to select the program number you want to program.

[3] The display will prompt you to select a channel number.

```

NORMAL PROGRAM
CH 04
TIME ON -- --
TIME OFF -- --
START DATE ---/---/---
TO END PUSH PROGRAM
    
```

Press two digits for the channel to be recorded (for example, press 0 then 4 for channel 4).

[4] The display will prompt you to enter the recording start time.

```

NORMAL PROGRAM 1
CH 04
TIME ON 06 --
TIME OFF --- --
START DATE ---/---/---
TO END PUSH PROGRAM
    
```

Press four digits, two for the hour and two more for the minute. For example, press 0 6 0 0 for 6:00. (Always press "0" before a single-digit hour or minute.)

- [5] The display will prompt you to select either AM or PM.

```
NORMAL PROGRAM 1
CH 04
TIME ON 06:00
TIME OFF 06:05
START DATE ----
TO END PUSH PROGRAM
```

Press "1" for AM or "2" for PM.

Remember: 12 AM is midnight
12 PM is noon

- [6] The display will prompt you to select the stopping time.

```
NORMAL PROGRAM 1
CH 04
TIME ON 06:00 PM
TIME OFF 06:05
START DATE ----
TO END PUSH PROGRAM
```

Press four digits, two for the hour and two more for the minute. For example, press 0 8 0 5 for 8:05. (Always press "0" before a single-digit hour or minute.)

- [7] The display will prompt you to select either AM or PM.

```
NORMAL PROGRAM 1
CH 04
TIME ON 06:00 PM
TIME OFF 06:05
START DATE ----
TO END PUSH PROGRAM
```

Press "1" for AM or "2" for PM.

Remember: 12 AM is midnight
12 PM is noon

- [8] The display will show "START DATE" followed by the current or next date and day.

```
NORMAL PROGRAM 1
CH 04
TIME ON 06:00 PM
TIME OFF 08:05 PM
START DATE 08/03/88
TO END PUSH PROGRAM
```

If you want to start recording on a future date, press four digits (two for the month and two for the day). Press "0" first for a single-digit month or day. For example, press 0 8 0 4 to begin recording on August 4.

If you want to start recording on that day, skip to Step 9.

The year and day of the week are displayed automatically when you finish.

- [9] Press *PROGRAM* to enter your program and return to the original display. Additional programs may be entered by repeating steps 2-9.

```
TO SELECT MODE
PUSH NUMBER SHOWN
1 CLOCK SET
2 NORMAL PROGRAM
3 DAILY(M-F) PROGRAM
4 WEEKLY PROGRAM
5 PROGRAM REVIEW
TO END PUSH PROGRAM
```

If you have no other programs to enter, press *PROGRAM* again.

- [10] Turn off the VCR.

Checking the Timer Programs

Programs can be checked whenever the VCR is turned on.

1. Press *PROGRAM* on the remote control to display the programming menu.
2. Press 5 (Program Review).
The TV screen will display for ten seconds the information you entered for the lowest program number. Then the display changes to the next higher program number, and so on, until all program information has been displayed.
3. Press 5 again if you want to view the next program information without waiting ten seconds.
4. When you are finished, press *PROGRAM* to remove the on-screen display.

Clearing a Timer Program

1. Press *PROGRAM* on the remote control to display the programming menu.
2. Press 5 (Program Review).
The TV screen will display for ten seconds the information you entered for the lowest program number. Then the display changes to the next higher program number, and so on, until all program information has been displayed.
3. Press 5 again if you want to view the next program information without waiting ten seconds.
4. Press *CLEAR* when the program information you want to clear is displayed.
5. Press *PROGRAM* to remove the on-screen display.

Notes:

- Normal timer programs clear automatically when the recording is finished, but daily and weekly programs remain in the timer indefinitely.
- All programs are erased if power is interrupted.
- More information about Timer Recording is on the next page.

Timer Recording

The information on this page tells you how to set up your VCR for Timer Recording *after you have programmed the timer.* (The programming instructions are on pages 22-23.) When you have finished programming the timer, follow the steps in the drawing to prepare for timer recording. We suggest that you

make one or more short timer recordings for practice.

If you have a Daily or Weekly program in the VCR timer, you should check the steps in the drawing sometime before the recording time to be sure that your VCR is ready to record.

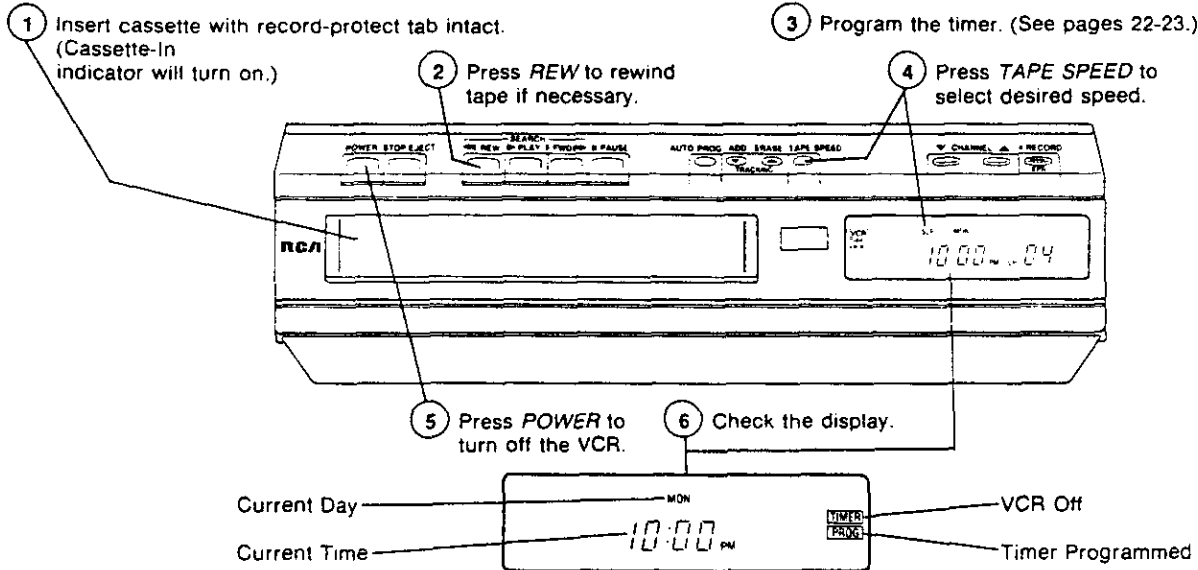

Timer Recording Checklist

Before your VCR timer can record a TV broadcast, all the conditions listed below must be fulfilled. They are presented as a checklist you can use until you are familiar with your VCR.

- Cassette inserted in the VCR. (**TIMER** flashes if not.)
- Cassette has its safety tab in place. (If not, the cassette is ejected.) (See "Erase Protection" on page 26.)
- Cassette length and recording speed are adequate for program(s) to be recorded.
- Cassette rewound to beginning or to place desired on tape.
- Clock set to correct time and date.
- Timer has been programmed. (**PROG** will be displayed.)
- POWER** has been turned off. **TIMER** appears only if the timer is programmed and the VCR is off.

Programming Reminders

- The **TIMER** indicator will flash when you turn off the VCR if you have programmed the timer but forgotten to insert a cassette.
- If the cassette in the VCR has its safety tab removed, the VCR will eject the cassette after you have programmed the timer and turned off the VCR. This is to remind you to insert a new cassette or cover the safety tab. Details are on page 26.

XPR and Timer

The timer cannot begin recording if the VCR is already recording with XPR, and vice versa. You can use XPR along with Timer Recording, but be careful that the XPR recording will end before the first timer recording begins.

TV Viewing During a Timer Recording

When the VCR turns on automatically to make a timer recording, it does not disturb whatever program you may be watching at the time. Press the **TV VCR** button on the remote control to turn on the **VCR** indicator if you want to monitor the recording.

Stopping a Timer Recording in Progress

Press **POWER** and then press **STOP** within 10 seconds. (Press **POWER** once more to turn off the VCR). This erases a Normal program from the timer's memory, but a Daily or Weekly program will record on the next scheduled day.

Timer Recording From the Line Input

It is also possible to timer record from the VCR's line input (audio/video inputs). Just enter "91" for the channel. This is convenient if you have a satellite receiver or similar device attached to the **AUDIO/VIDEO IN** jacks on the back of the VCR. The **LINE** indicator will light in the VCR's display panel and "VIDEO" will appear instead of the channel number in the TV's on-screen display.

Express Recording

Express Recording (XPR) lets you record up to four hours without programming the timer.

When the recording is finished, the VCR will turn off automatically.

Note: Although you do not have to program the timer, the clock must be set before you can Express Record.

Only one button is used for Express Recording.

• RECORD



1st Press	Record (continuously)
2nd Press	30 minutes XPR
3rd Press	1 hour XPR
4th Press	1-1/2 hour XPR
5th Press	2 hours XPR
6th Press	3 hours XPR
7th Press	4 hours XPR
8th Press	Return to Normal Recording

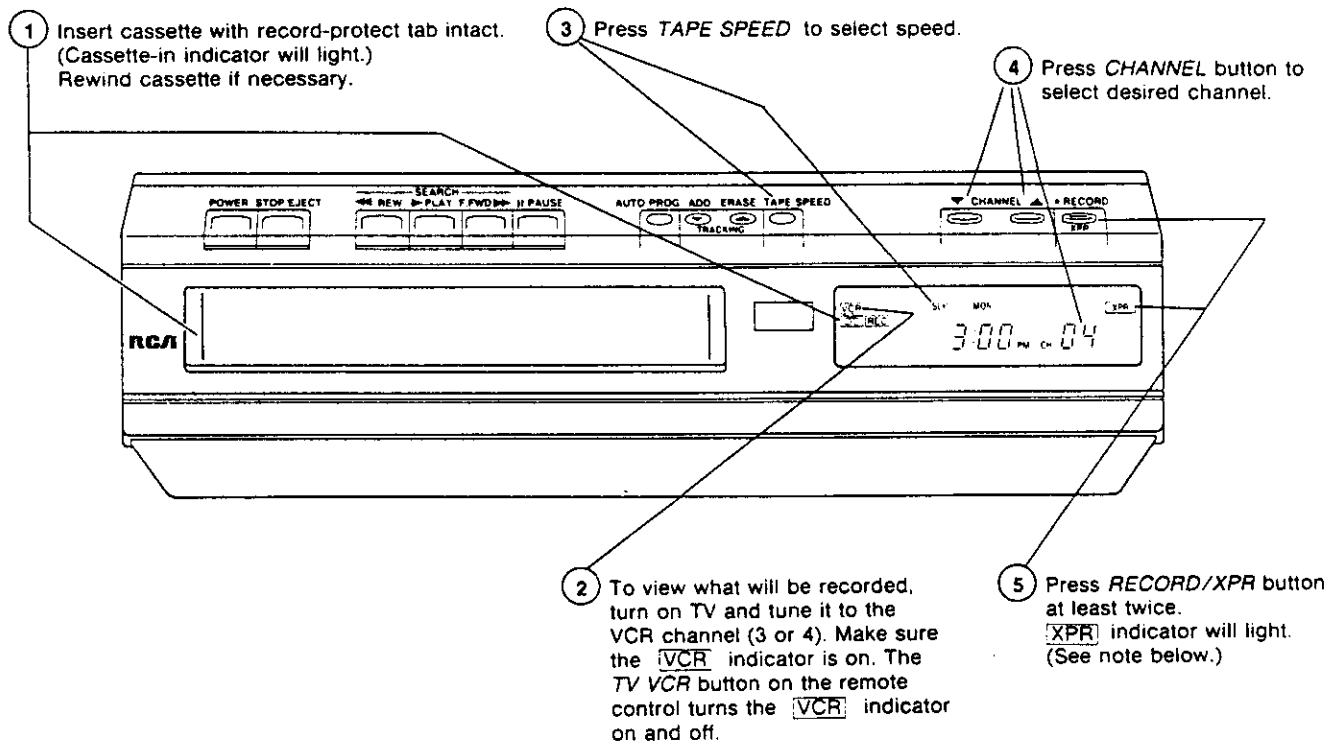

Notes for Step 5

- Press the **RECORD/XPR** button twice to activate the express recording feature. The first keypress only starts normal recording.
- Increase the XPR recording time by pressing the **RECORD/XPR** button additional times. The clock display shows the amount of recording time you have set. [from 0:30 (30 minutes) to 4:00 (4 hours)]
- Pressing the **RECORD/XPR** button again when 4:00 (4 hours) is displayed returns the VCR to normal recording. (The **XPR** indicator will turn off.)
- The time remaining is constantly displayed during XPR. You can extend the time up to four hours whenever you want by pressing the **RECORD/XPR** button.
- When the recording time has expired, the VCR will turn off and the clock display will return to the current time. (The **XPR** indicator will turn off.)

To Stop XPR

- Press **POWER** and then **STOP** within ten seconds.

Video Cassettes

RCA recommends that RCA cassettes be used with this unit. The tape in RCA cassettes is of high-quality formulation, intended for use with multi-speed VHS video cassette recorders. It has been manufactured to RCA's critical specifications for excellent performance with RCA VCR's. Use of tape not meeting these specifications could considerably reduce the performance of your VCR.

Use of poor quality tapes or tapes that have been damaged or mishandled can contaminate the VCR heads. This can cause a snowy picture or a missing picture during playback. Because RCA has no control over the type of tape purchased or rented by consumers, **head cleaning is not covered by RCA's warranty.** It is considered normal maintenance.

Playing a new RCA tape for approximately 30 minutes often will clean the VCR heads and improve your picture. If a snowy picture or missing picture condition persists, consider the use of a chemical non-abrasive head cleaning tape (RCA Stock No. AV009W). It is available from your dealer and many electronic supply stores. Be sure to follow the directions with the head cleaning kit carefully. Improper use of a head cleaner may damage your VCR.

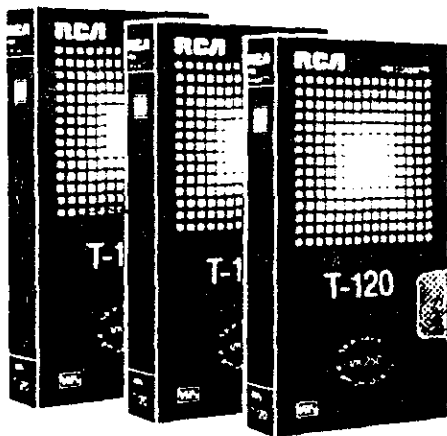

Erase Protection

To prevent erasing a recording you want to keep, remove the record-protect tab from the back of the cassette as shown below. Recording is impossible when this tab is removed. To record again on a cassette that has the tab removed, simply cover the hole with vinyl tape.

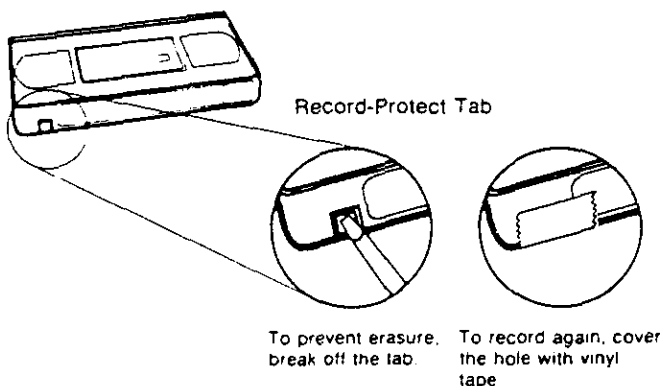

Cassette Playing Times and Speeds

The playing times and counter readings below are approximate. Also, it is assumed the counter is set to 0000 at the start of the tape.

SPEED Time	T-60 CASSETTE (VK125)		
	SP Counter Reading	LP Counter Reading	SLP Counter Reading
1 hour	2080 (end)	1120	760
2 hours		2080 (end)	1460
3 hours			2080 (end)

SPEED Time	T-120 CASSETTE (VK250)		
	SP Counter Reading	LP Counter Reading	SLP Counter Reading
1 hour	3520	2100	1520
2 hours	5680 (end)	3520	2600
3 hours		4660	3520
4 hours		5680 (end)	4300
5 hours			5000
6 hours			5680 (end)

SPEED Time	T-160 CASSETTE (VK330)		
	SP Counter Reading	LP Counter Reading	SLP Counter Reading
1 hour	3740	2160	1560
2 hours	6120	3740	2740
3 hours		5020	3740
4 hours		6120	4640
5 hours			5400
6 hours			6120
7 hours			6760
8 hours			7420 (end)

Recording Speed

This information will help you decide which tape speed to use when recording.

- **SP:** Standard Play provides the best picture but the shortest recording time (2 hours with a T-120 tape). Video recorded at this speed has the least "picture noise" (snow) in normal playback. Pre-recorded tapes use SP for this reason and also because all VHS recorders have this speed.
- **LP:** Long Play provides twice the recording time as SP (4 hours with a T-120 tape). This speed is provided primarily for playing tapes recorded on older machines that do not have SLP.
- **SLP:** Super Long Play provides three times the recording time as SP (6 hours with a T-120 tape). SLP has slightly more "picture noise" than SP in normal playback (which may not be noticeable). *Your VCR's special effects (search and stop action) are designed for optimum performance at the SLP speed.*

Cassette Care and Storage

Follow these directions for continued high-quality performance from your cassettes.

- When you are finished with a cassette, rewind it and remove it from the VCR.
- Never attempt to force open the cassette door.
- Store cassettes vertically in their protective boxes at normal room temperatures. Avoid extreme heat and humidity. Extreme heat can warp the cassette or cause the tape to stretch excessively.
- Be especially careful to keep dust from entering the cassette and the VCR mechanism. All dust is abrasive and it will cause excessive wear of both the tape and the VCR's recording/playback heads.

SECTION II

*Quick Reference Guides,
Component Recording,
and General Information*

Quick Reference Guides

Normal TV Viewing

- 1 Turn **POWER** off or turn **VCR** Indicator off by pressing **TV VCR** button on remote control.
- 2 Operate TV as usual. Select channels with TV channel buttons.

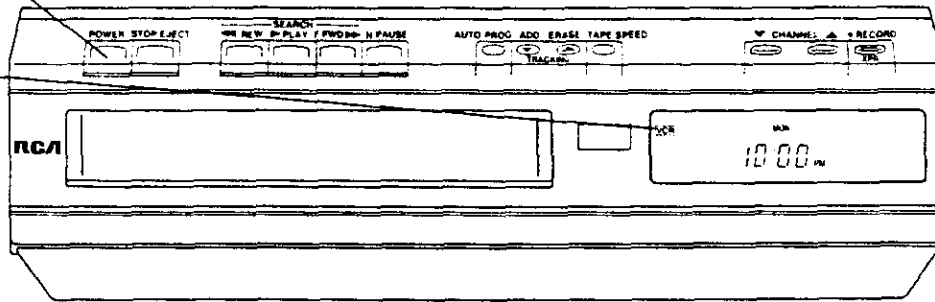

Recording With TV Off

It is not necessary to have your TV turned on when you record.

- 1 Insert cassette with record-protect tab intact. (The cassette-in indicator will light.)
- 2 Press **TAPE SPEED** to select desired tape speed.
- 3 Press **CHANNEL** button to select desired channel.
- 4 Press **RECORD**. (The **REC** indicator will turn on.)
- 5 Press **STOP** when finished.

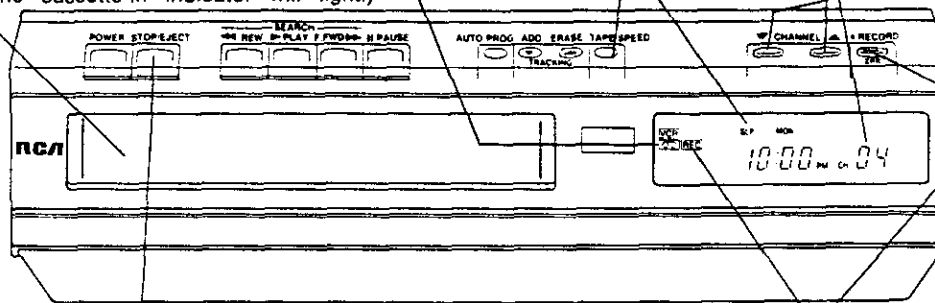

Recording and Viewing the Same Program

- 1 Turn on TV.
- 2 Tune TV to VCR Channel (3 or 4).
- 3 Insert cassette with record-protect tab intact. (The cassette-in indicator will light.)
- 4 Make sure **VCR** indicator is on. Press **TV VCR** button on remote if **VCR** indicator is off.
- 5 Press **TAPE SPEED** to select desired tape speed.
- 6 Press **CHANNEL** button to select desired channel.
- 7 Press **RECORD**. (The **REC** indicator will turn on.)
- 8 Press **PAUSE** to interrupt recording if desired. Press **PAUSE** again to resume.
- 9 Press **STOP** when finished.

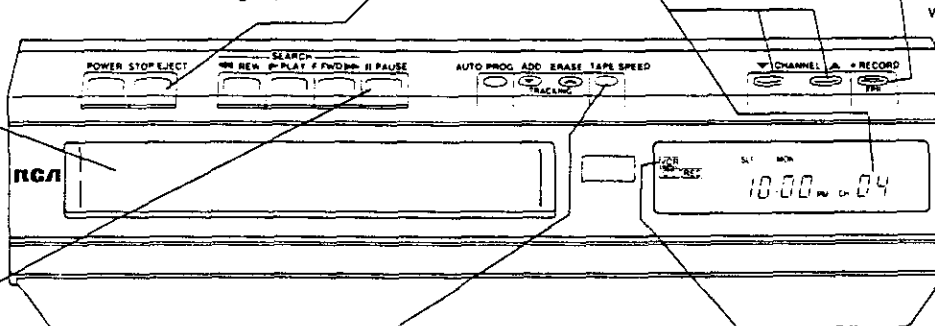

Note: If you want to view another VHF or Cable-TV channel after you start recording, press the **TV VCR** button on the remote control so the **VCR** indicator in the display goes off. Then select the other channel

you want to watch with the TV's channel buttons. If you want to view a UHF channel after you start recording, simply tune the TV to the channel. The recording will not be affected.

Recording and Viewing Different Programs

- 1 Turn on TV and tune it to the VCR Channel (3 or 4).
- 2 Insert cassette with record-protect tab intact. (The cassette-in indicator will light.)
- 3 Press **TAPE SPEED** to select desired tape speed.
- 4 Press **CHANNEL** buttons to select channel you want to record.
- 5 Press **RECORD**. (**[REC]** indicator will light.)
- 6 Press **TV VCR** button on remote to turn off **[VCR]** indicator.
- 7 Select other channel you want to watch with TV's channel buttons.

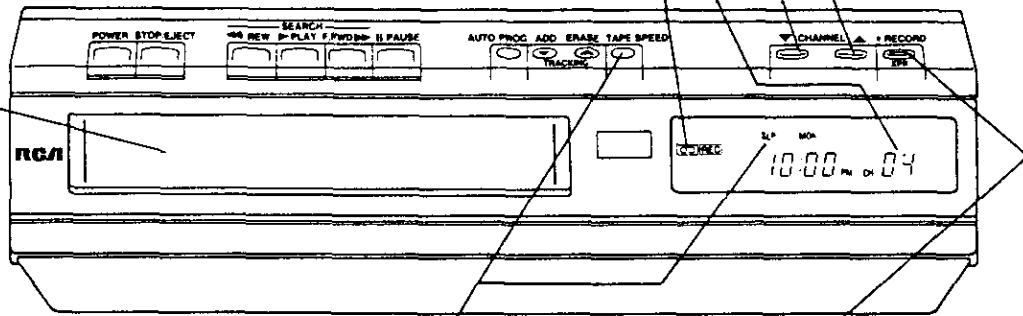

Note: If you want to view what is being recorded, press the **TV VCR** button on the remote control to turn on the **[VCR]** indicator. Then tune your TV to the VCR channel (3 or 4).

Basic Playback

- 1 Turn on TV and tune it to the VCR Channel (3 or 4).
- 2 Insert cassette.* (The cassette-in indicator will light.)
- 3 Press **REW** to rewind tape if necessary.
- 4 Make sure **[VCR]** indicator is on. Pressing the **TV VCR** button on the remote turns the **[VCR]** indicator on and off.
- 5 Press **PLAY**.* (The ► indicator will light.)
- 6 If the tape was recorded on a different VCR, streaks may appear. To remove the streaks, press the **TRACKING ▲** or **▼** button.

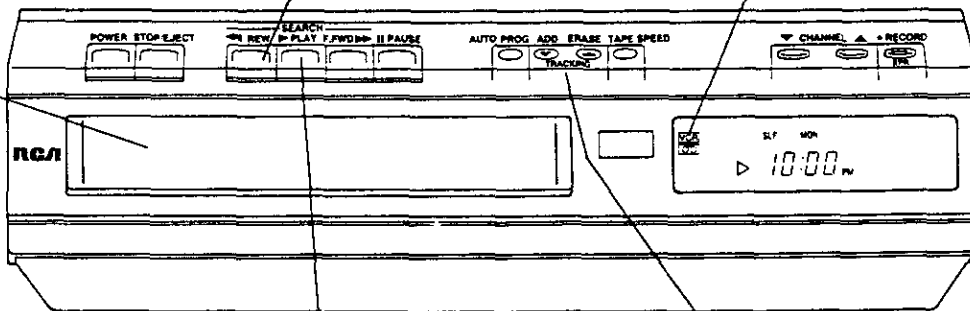

*If the tape has the record protect tab removed, it will automatically go into play. It is not necessary to press the **PLAY** button.

Recording from Another VCR

To copy (dub) tapes, connect the two VCR's as shown below. Use shielded audio/video cables (such as RCA #AH002, #AH005, or #AH036).

The connections from the recording VCR to your TV are the ones you normally use. It's best to play the original tape on the same machine that was used to record it (so you don't have to adjust the *TRACKING* buttons.)

CAUTION: The unauthorized recording of television programs and other materials may infringe the rights of others.

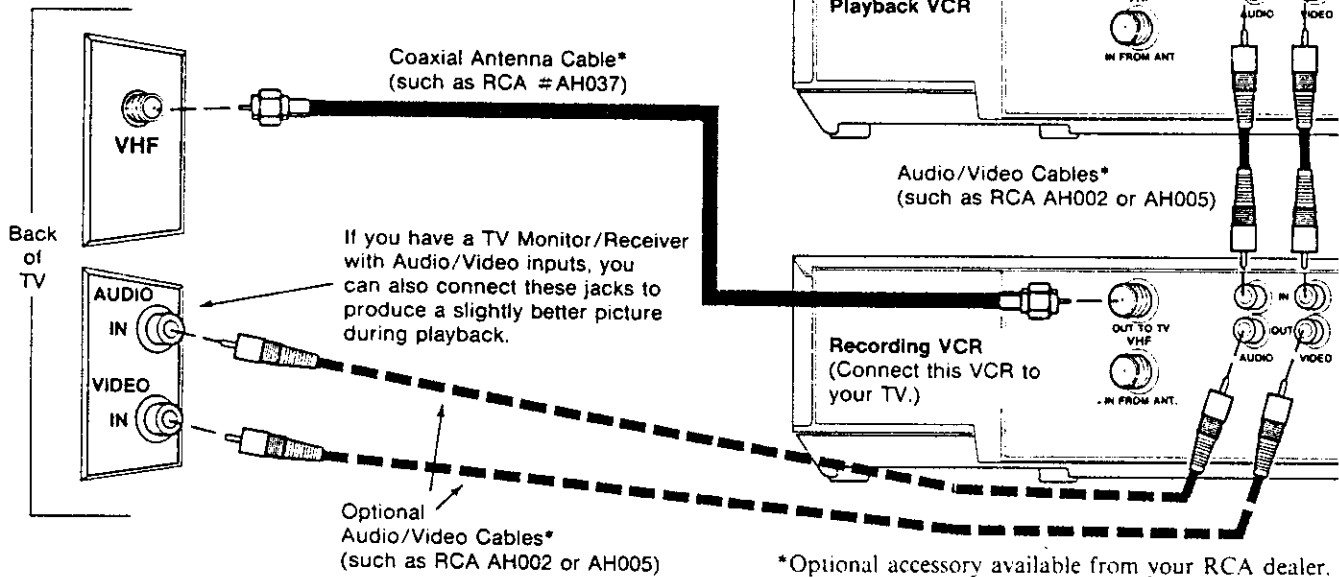

Simplified Operating Instructions to Dub Tapes

1. Connect the two VCR's as shown above. (Use shielded audio/video cables such as RCA #AH002, #AH005, or #AH036.)
2. Turn on TV.
3. Tune TV to VCR Channel (channel 3 or 4).
4. Turn on both VCR's.
5. Insert recorded cassette into *Playback VCR*.
6. Insert blank cassette into *Recording VCR*.
7. Press *TV VCR* button on remote control of *Recording VCR* so **VCR** indicator is on. (This allows you to watch the recording while it's in progress.)

Note: If you want to watch another TV channel on the TV while you're dubbing the tape, first press the *TV VCR* button on remote control so the **VCR** indicator is out and then use the TV's channel selector to select the channel you want to watch on the TV.
8. Select channel 91 on the Recording VCR. The **LINE** indicator will appear in the display. (Press *CHANNEL* ∇ or \blacktriangle button if channel 91 is programmed in the VCR's Channel Memory or press "9" then "1" on the remote control.)

Note: If the Recording VCR has a *TUNER/LINE* switch, place it in the *LINE* position.
9. Select the desired tape speed on the *Recording VCR* (SP, LP or SLP).
10. Rewind cassettes to the beginning if necessary.
11. Place the *Recording VCR* into the record mode.
12. Press *PLAY* on the *Playback VCR* to start playing the prerecorded cassette.
13. Adjust *TRACKING* buttons on *Playback VCR* if necessary.

Note: If the prerecorded cassette is not being played on the same VCR that originally recorded it, streaks may appear in the TV picture. Simply press the *TRACKING* \blacktriangle or \blacktriangledown button on the *Playback VCR* to eliminate the streaks.
14. If you want to edit out unwanted material, press *PAUSE* on the *Recording VCR* while it is recording. Press *PAUSE* again to resume recording.

Note: Use the *PAUSE* button only for brief pauses. If you want to pause for more than three or four minutes, stop the VCR by pressing *STOP*. When you are ready to resume, place the VCR back into the record mode.
15. The TV does not have to be turned on to dub a tape. You may turn off the TV if desired after the recording has started.
16. Stop both VCR's when the recording is finished.

Camera Recording

In addition to the camera itself, you will need a **Camera AC Power Supply** (such as RCA Model CPS03 for use with RCA cameras). Plug the camera cable into the power supply and then connect the cables from the power supply to the VCR as shown below. The connections from the VCR to your TV are the same ones you normally use.

- To start recording press *RECORD* on the VCR.
- Use the *PAUSE* button on the VCR to start and stop recording. If you want to pause for more than three or four minutes, stop the VCR by pressing *STOP*. When you are ready to resume, press *RECORD*.

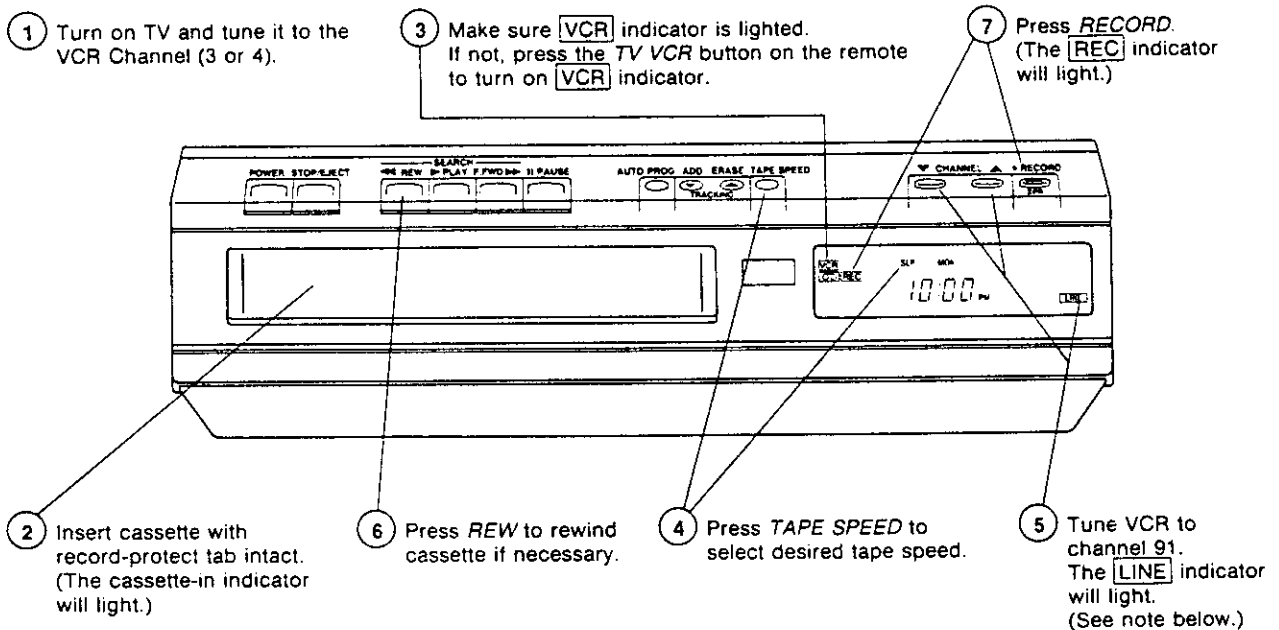
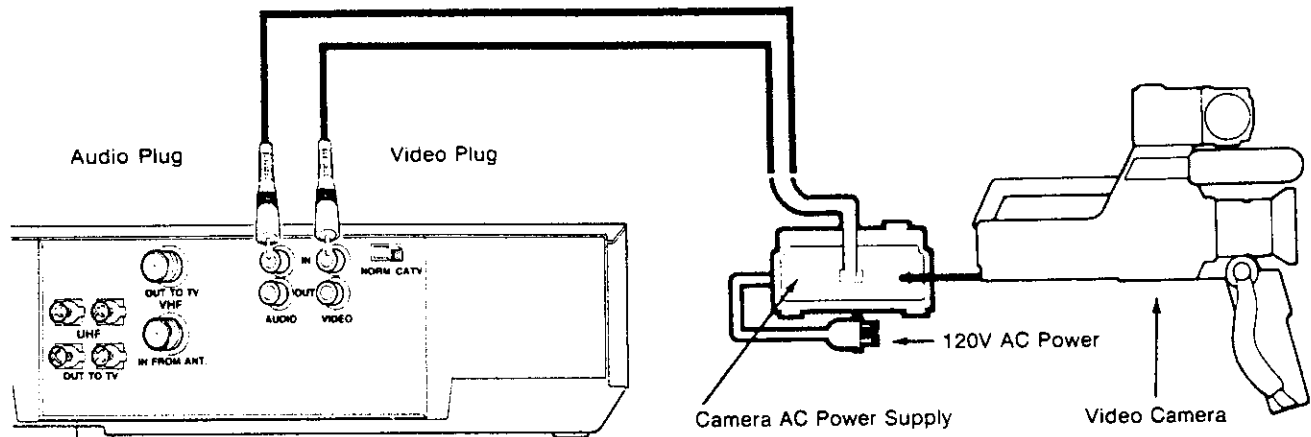

Note: Select Channel 91 on the VCR whenever you want to view or record signals from a device connected to the *AUDIO/VIDEO IN* jacks on the back of the VCR. Press *CHANNEL* ▼ or ▲ if Channel 91 has been added to the Channel Memory, or press "9" then "1" on the remote control. The **LINE** indicator will appear in the display to let you know the VCR will record from its *AUDIO* and *VIDEO* input jacks.

Alternate Remote Control Units

Selected models of RCA color TV receivers and monitor/receivers feature remote controls that will also control your VCR. Only the buttons that are used for controlling your VCR are described here. These buttons have generally the same functions as the ones with the same names on the front panel of the VCR, but there are some differences.

- Any VCR tuner channel may be selected by pressing two of the Digit buttons on the hand unit. Press 0 first to select tuner channels 1 through 9.
- Separate buttons turn the VCR on and off.
- Simply press the *RECORD* button to record. It is not necessary to press the *PLAY* button at the same time.

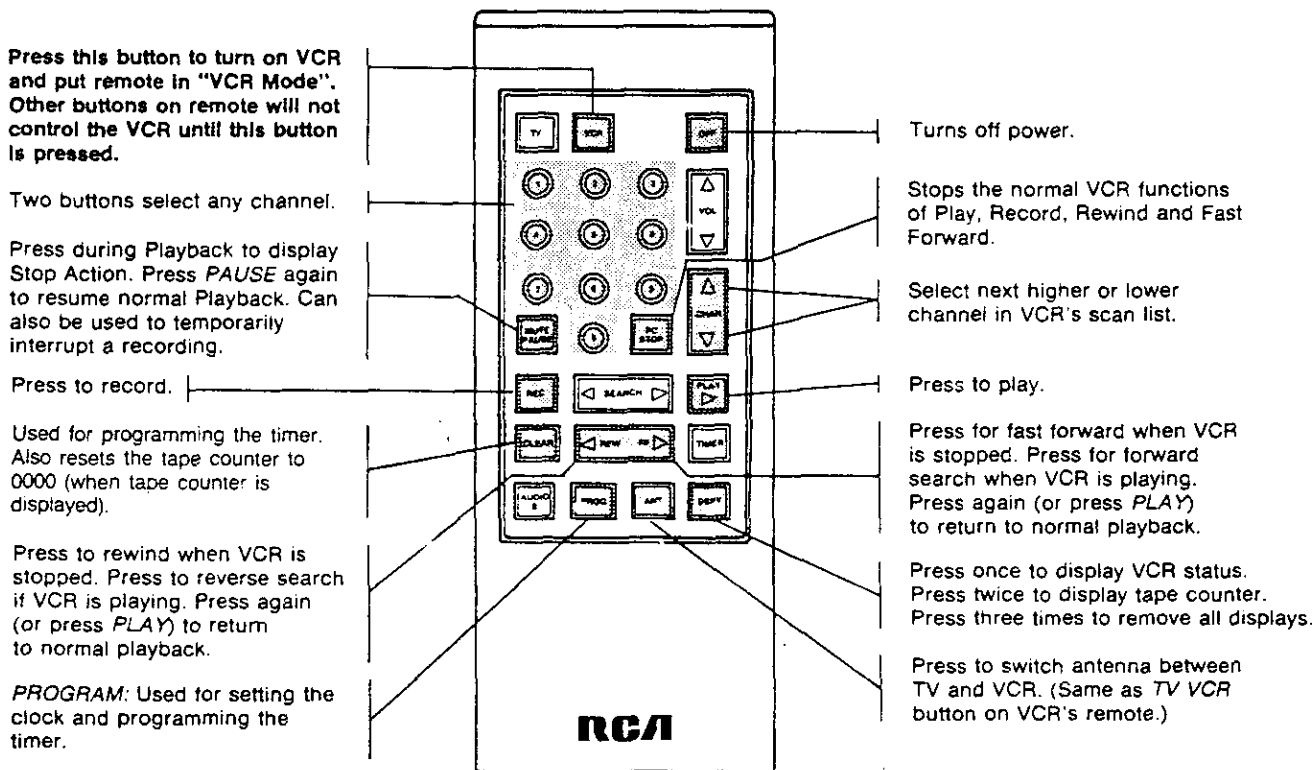
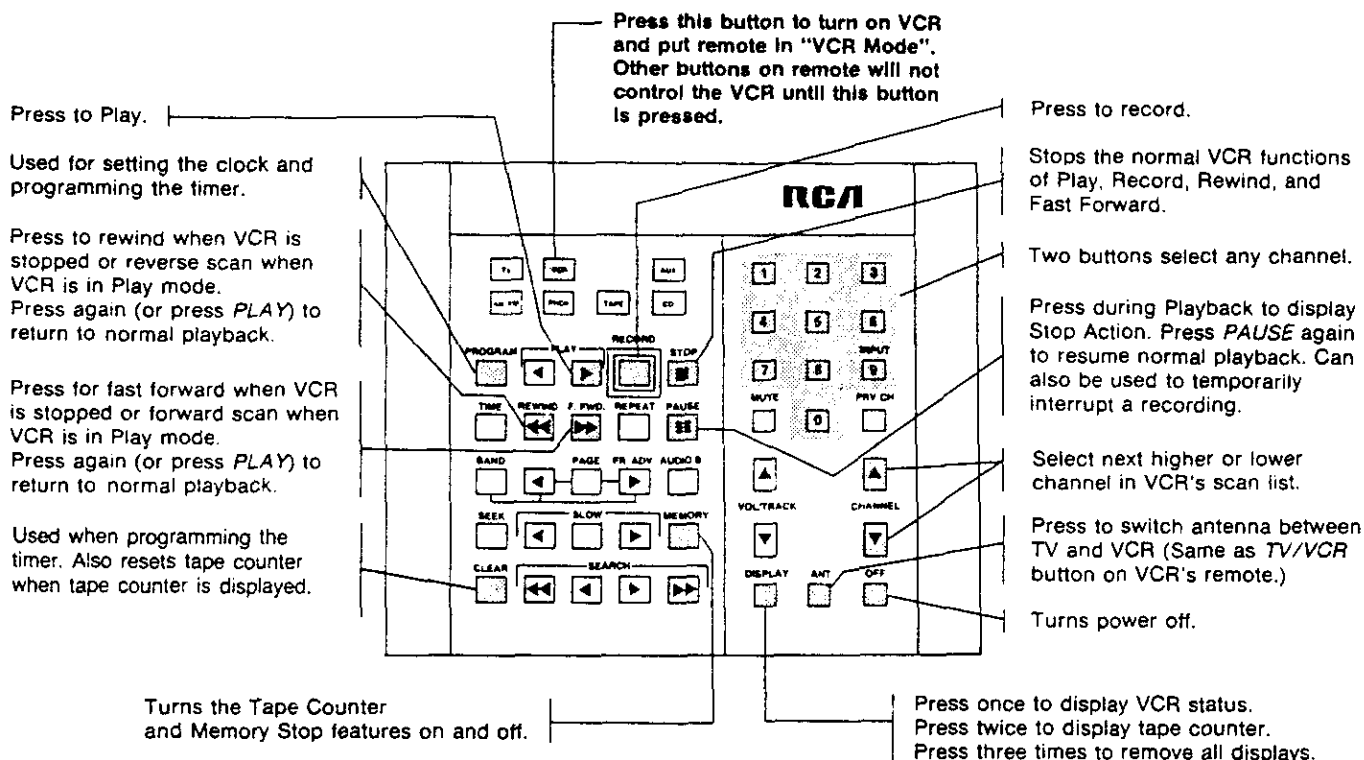

Press to pause play or record mode.
Press again to release pause.

Press to turn off VCR.

Press to start tape playing.

Press while VCR is stopped to rewind tape.

Press while VCR is playing to search backward. Press again (or press *PLAY*) to return to normal playback.

Used when setting the clock and programming the timer.

Press to switch antenna between TV and VCR.

Press two numbers to select channel.
Press a "0" before a single-digit channel number.

Press to turn on VCR and put remote in "VCR Mode" so other buttons will control only the VCR.
Press the *TV* button to put remote back into "TV Mode".

Press once to display VCR status.
Press twice to display tape counter.
Press three times to remove all displays.

Stops the normal VCR functions of Play, Record, Rewind or Fast Forward.

Press to record.

Used when programming the timer. Also resets tape counter when tape counter is displayed.

Press to select next higher or lower channel in VCR channel scan list.

Press while VCR is stopped to fast forward tape.
Press while VCR is playing to search forward. Press again (or press *PLAY*) to return to normal play.

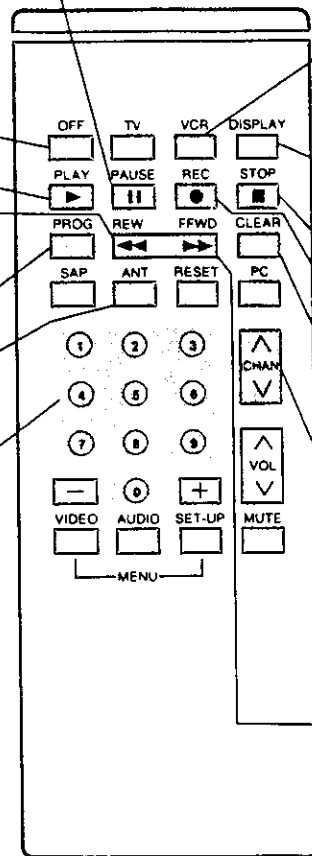

Places VCR in Pause mode when in Play or Record.

Press to turn on VCR and put remote in "VCR Mode" so other buttons will control only the VCR. Press the *TV* button to put remote back into "TV mode".

Press to Play.

Places VCR in Rewind when stopped or in Reverse Search when playing. Press again (or press *PLAY*) to return to normal playback.

Places VCR in Fast Forward when stopped or in Forward Search when playing. Press again (or press *PLAY*) to return to normal playback.

Used for setting the clock and programming the timer.

Press to move noise bars out of picture during play.

Press to start recording.

Press to stop.

Press two numbers to select channel.
Press a "0" before a single-digit channel number.

Press to turn off VCR.

Press to select next higher or lower channel in VCR channel scan list.

Press to switch antenna between TV and VCR.

Press once to display VCR status.
Press twice to display tape counter.
Press three times to remove all displays.

Turns the Tape Counter and Memory Stop features on and off.

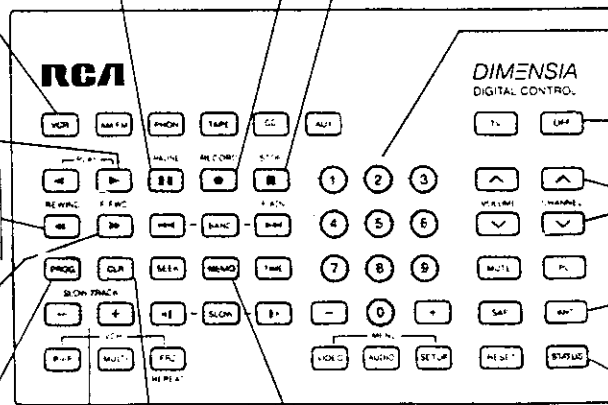

Used when programming the timer. Also resets the tape counter when the tape counter is displayed.

Cabinet Cleaning

Cleaning

Dust exposed surfaces as required, using a soft cloth or the dusting attachment of your vacuum cleaner. Occasionally use the vacuum cleaner to remove dust from the ventilation holes on the top, back, sides, and bottom of the cabinet.

Some of the plastic surfaces are easily scratched, and they can be marred by alcohol and various solvents. Avoid excessive use of oil-based furniture polishes since the materials used in the cabinet are non-porous and the residue will accumulate more dust.

Trouble Checks

Sometimes problems can be easily solved by checking a few basic things. Check below before you call for help or take your unit to an RCA Authorized VCR Servicenter.

It could save you time and money. If service should be necessary, RCA Authorized VCR Servicenters are trained and equipped to furnish it.

No Power	<ul style="list-style-type: none">• Check to see if the VCR is plugged into an operating outlet.
Does Not Respond to Remote Control	<ul style="list-style-type: none">• Weak battery in remote control.• Remote control not aimed at the VCR or there is an obstruction between them.
Poor/No Picture for Normal TV Viewing	<ul style="list-style-type: none">• VCR indicator is on. Press <i>TV VCR</i> button on remote to turn it off.• TV monitor/receiver set to "Video Input." Switch to an active channel.• Carefully check antenna connections.
Snowy/No Picture During Playback	<ul style="list-style-type: none">• Adjust <i>TRACKING</i> buttons.• VCR indicator not on. Press <i>TV VCR</i> button on remote to turn on.• Make sure the TV channel selector matches the channel you have selected on the back of the VCR (3 or 4).• Make sure the TV is fine tuned.• Check the video cable connections between the VCR and a TV monitor/receiver.• Make sure the TV monitor/receiver is set for "Video In."• Try another tape.• Very dirty tape has left deposits on VCR heads. See page 26 for head cleaning.• Some snow and streaks are normal during Search and Stop-Action play.
Streaks in Picture During Normal Playback	<ul style="list-style-type: none">• Press the <i>TRACKING</i> ▼ or ▲ buttons to move streaks up or down and out of picture.• Tape stretched (poor quality or worn out).
Will Not Record or Play	<ul style="list-style-type: none">• No cassette in VCR.• Eject and reinsert cassette.• Broken tape – try another cassette.
Will Not Record	<ul style="list-style-type: none">• VCR is in the pause mode.• Record-protect tab removed from cassette.
Timer Recording Not Made	<ul style="list-style-type: none">• Program entered incorrectly (wrong channel or times).• Power interruption. (Clock on the VCR's front panel will show "—:—".)• Clock was not set accurately (including AM/PM).• Program exceeded cassette length or tape was not rewound beforehand.• VCR was not turned off at the time recording was to start.• No tape in VCR or cassette's record-protect tab broken off.
Tape Stops Before Complete Rewind	<ul style="list-style-type: none">• Press <i>DISPLAY</i> on remote to turn off tape counter or press <i>REWIND</i> again. Tape rewinds only to "0000" when the counter is on.
Rewind does not operate	<ul style="list-style-type: none">• Tape already rewound. Check counter reading.
Clock Shows Incorrect Time or Date	<ul style="list-style-type: none">• Power interruption. (Clock on the front panel will show "—:—".)• Clock was not set accurately (especially AM and PM).• Clock display shows recording time remaining during XPR recording.

Optional Accessories

Several accessories are available that will enable you to expand your home video system. You may also find some of these items helpful when installing your VCR. A few accessories are pictured here to briefly familiarize you with the different types that are available. Although RCA Part Numbers are listed for your convenience, other accessory brands are also compatible with your RCA video system. Accessories are available through most electronic supply stores and RCA video dealers.

Video Cameras and Camcorders

See your RCA dealer for complete details on the wide selection of Color Video Cameras and Camcorders (combination camera/recorder) that is available for use with your new VCR.

Cables



Cable designed for use with VCR's, Video Cameras, or any other equipment requiring 75-ohm "F"-type interconnecting cables.

AH037 - 3-ft; AH008 - 9-ft;
AH007 - 6-ft; AH009 - 16-ft

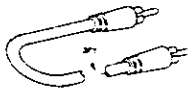

AH036

3' general-purpose coaxial cable for use in audio and video applications. It is fitted with RCA phono-type connectors and is used with VCR's, Monitors, and other related audio and video equipment.

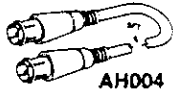

AH004

Provides quick-connect application of 75-ohm "F"-type cable. Used with VCR's, Video Cameras, TV receivers, and other electronic devices.



AH002

A 5' shielded audio/video cable specifically designed for video and audio use with video cameras and VCR equipment.

Adapters



AH030

Screw-on to push-on adapter, attaches to end of coaxial cable with standard "F" connector so you can simply push the connector onto your TV or VCR antenna connector. Useful if you change connections frequently.

Connectors



AH044

Used to interconnect two audio cables equipped with phono-type male plugs.



AH023

"Splicer" lets you connect one coaxial cable to another. Used for extending an antenna lead-in or for operating your VCR at a greater distance from the TV.

Cleaner/Polisher



AH035

Anti-static cleaner/polisher that can be used on any hard, shiny, non-absorbent surface such as plastics, glass, mirrors, and chromed parts. Cleans and polishes TV screens and plastic cabinets. Returns brilliance, repels dust, and resists fingerprints.

Switches



AH028

This is an economy two-position 75-ohm coaxial switch which performs the same functions outlined for the AH041 switch, shown below.



AH041

This is a 2-position 75-ohm coaxial switch (sometimes referred to as an A-B switch) used for switching a single signal source to two separate output devices, such as a cable-TV input to a TV set or VCR.

Band Separators



AH050

Used to connect a single 75-ohm input antenna line to separate 75-ohm VHF, 300-ohm UHF and/or 300-ohm FM receiver inputs.



AH051

Used to connect a single 300-ohm input antenna line to separate 75-ohm VHF, 300-ohm UHF and/or 300-ohm FM receiver inputs.



AH015

Used to connect a single 75-ohm antenna input line to separate 300-ohm inputs of TV.

Transformers



AH011

Used to match a 75-ohm signal source to a 300-ohm device, or a 300-ohm signal source to a 75-ohm device. (Such as antenna leads to TV receivers).



AH018

This transformer is specifically designed to match a 300-ohm line to a 75-ohm "F"-type input. It provides quick push-on connection to an "F"-type input jack.

Splitters/Combiners

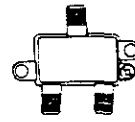

AH047

Used as a splitter to divide a signal from a single 75-ohm source so that it may be fed to two separate devices. For example, a single 75-ohm antenna lead-in signal split to feed two TV receivers. When used as a combiner, signals from two sources are fed through two inputs to a single output.



AH048

The same as AH047 above except AH048 provides four outputs from a single input. As a combiner, four signal inputs feed to a single output.

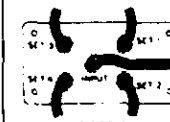

AH014

4-set coupler lets you operate up to four TV's and VCR's from one lead-in. (Use AH025 terminators on unused outlets.) In fringe areas use the AH046 distribution amplifier.

Terminator

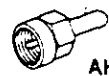

AH025

AH025 terminator should be attached to unused terminals of signal splitters to prevent smearing the picture.

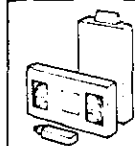

AH009W

RCA non-abrasive wet system VHS VCR head cleaner. Be sure to follow directions carefully.

Index

Accessories (Optional)	35	Features	2
<i>ADD</i> Button	11,12,13,19	Features (Special)	20,21
Alternate Remote Controls	32,33	<i>F.FWD/SEARCH</i> Button	19,21
Antenna Cables (Types)	4	<i>F.FWD/SEARCH</i> Button (Remote)	15
Antenna Connections	4,5,8,9	First Recording/Playback	17
Antenna Information (General)	4,5,6,7	Forward Search	15,19,20
Audio/Video Connections to Monitor	10	FS Tuner	2
<i>AUDIO/VIDEO IN</i> Jacks	12,24,30,31	General Installation Information	4
Auto Power-On/Auto Play	2	Handbook (Interference)	4
<i>AUTO PROG</i> Button	11,12,13,19	HQ Picture	2
Auto Rewind with Shutoff	2	Indoor Antenna	4,5,6,7
Basic Operation	11	Inserting Tapes	11
Basic Playback	29	Installation	4
Basic Recording/Playback	17	Interference	4
Battery Installation (Remote)	14	<i>LINE</i> Indicator	12,19,24,30,31
Cabinet Cleaning	34	Location (Choosing)	4
Cable Channels (List)	8.Back Cover	LP (Long Play)	26
Cable-TV Connections	4,5,8,9	Memory Stop	21
Cables (Types of Antenna Cables)	4	Moisture (Caution)	1
Camera Recording	31	Monitor/Receiver Connections	10
Care (Cassettes)	26	<i>NORM/CATV</i> Switch	12,13
Cassette Care & Storage	26	Normal TV Viewing	28
Cassette Compartment	11,18	Number Buttons (Remote)	14
Cassette Door	26	On-Screen Display	21
Cassette-In Indicator	11,19	Operating Controls (Detailed)	18,19
Cassettes	26	Operation (Basic)	11
CATV (Cable-TV)	4,5,8,9	Optional Accessories	35
<i>CATV/NORM</i> Switch	12,13	<i>PAUSE</i> Button	19,20
Caution (Cold to Warm)	1	<i>PAUSE</i> Button (Remote)	14
<i>CH3/CH4</i> Switch	13,17	Pause During Recording	20
Channel 91	12	Pause for Stop-Action	20
<i>CHANNEL</i> Buttons	11,12,19	Picture Search	20
<i>CHANNEL</i> Buttons (Remote)	14	<i>PLAY</i> Button	11,18
Checking Timer Programs	23	<i>PLAY</i> Button (Remote)	15
Checklist (Installation)	13	Playback (Basic)	29
Checklist (Timer)	24	<i>POWER</i> Button	11,12,13,18
Choosing Location	4	<i>POWER</i> Button (Remote)	14
Cleaning Cabinet	34	<i>POWER</i> Button (Timer)	18
<i>CLEAR</i> Button (Remote)	14,16,21,22	Precautions (Safety)	Inside Front Cover
Clearing Timer Programs	23	<i>PROG</i> Indicator	19,24
Clock (Setting)	16	<i>PROGRAM</i> Button (Remote)	14,16,22,23
Compatible Remote Controls	32,33	Programming Channels	12
Connections		Programming Timer	22,23,24
• Antenna (Indoor/Outdoor)	4,5,6,7	Quick Reference Guides	28,29
• Cable-TV	4,5,8,9	<i>RECORD</i> Button	11,19,25
• TV Monitor/Receiver	10	<i>RECORD</i> Button (Remote)	15
• Another VCR	30	Record-Protect Tab	24,26
• Video Camera	31	Recording & Viewing Different Programs	29
Controls (Basic)	11	Recording & Viewing Same Program	28
Copying Tapes	30	Recording (First Time)	17
Counter Readings	26	Recording From Another VCR	30
Deleting Channels	12	Recording Speeds	26

Detailed Controls	18,19	Recording With TV Off	28
Display (On-Screen)	21	Registration	Inside Front Cover
<i>DISPLAY</i> Button (Remote)	14,21	Remote Control (Supplied)	14
Dropouts	20	Remote Controls (Compatible)	32,33
Dubbing Tapes	30	Removing Tapes	11
<i>EJECT/STOP</i> Button	11,18	Reverse Search	18,20
Effects (Special)	20,21	<i>REW/SEARCH</i> Button	11,18,21
Ejecting Tapes	11	<i>REWIND/SEARCH</i> Button (Remote)	15
Equipment Rack	4	Safety Precautions	Inside Front Cover
<i>ERASE</i> Button	11,12,13,19	Safety Tab	26
Erase Protection	26	Scan List	12
Erasing Channels	12	<i>SEARCH/F.FWD</i> Button	19,21
Erasing Timer Programs	23	<i>SEARCH/F.FWD</i> Button (Remote)	15
Express Recording (XPR)	25	<i>SEARCH/REW</i> Button	11,18,21
FCC Booklet	4	<i>SEARCH/REWIND</i> Button (Remote)	15
Setting Clock	16	Trouble Checks	34
Setting TV to VCR Channel	13	Tuner (FS)	2
Simplified Installation Checklist	13	Turning on VCR (1st Time)	12
SLP (Super Long Play)	26	TV Mode	13
SP (Standard Play)	26	TV Monitor/Receiver Connections	10
Special Effects & Features	20,21	<i>TV VCR</i> Button (Remote)	13
Specifications	Back Cover	TV Viewing (Normal)	28
Speeds (Tapes)	26	TV Viewing During Timer Recording	24
Stacking Arrangements	4	<i>TV/VCR</i> Button (Remote)	15
Status Displays	11,19	UHF/VHF Channels	4
Stop-Action	20	Unpacking	4
<i>STOP</i> Button	20	<i>V.LOCK</i> Control	20
<i>STOP</i> Button (Remote)	15	VCR Channel	13
<i>STOP/EJECT</i> Button	11,18	VCR Indicator	11,13,15,19,28,29,30
Stopping Timer Recording	24	VCR Mode	13
Stopping XPR	25	<i>VCR/TV</i> Button (Remote)	15
Storage (Cassettes)	26	Ventilation	4
Tab (Record-Protect)	26	VHF/UHF Channels	4
Tape Counter	21	Video/Audio Connections to Monitor	10
<i>TAPE SPEED</i> Button	11,19	<i>VIDEO/AUDIO IN</i> Jacks	12,24,30,31
Tapes	26	Video Cassette Compartment	11,18
Tapes (Inserting/Removing)	11	Video Cassettes	26
Time (Clock)	16	<i>VIDEO</i> Display	24
Time Display	11,19	Video Tapes	26
Timer (Programming)	22,23,24	Warranty	Back Cover
<i>TIMER</i> Indicator	19,24	Warranty Registration	Inside Front Cover
Timer Programs (Checking)	23	What Your VCR Will Do	2
Timer Programs (Clearing)	23	XPR (Express Recording)	25
Timer Recording from Line Input	24	<i>XPR</i> Button	11,19,25
Times & Speeds (Tapes)	26	<i>XPR</i> Indicator	19,25
<i>TRACKING</i> Buttons	19,20,30	<i>XPR</i> & Timer	24

Specifications

Format	VHS
Record/Playback System:	2 video record/playback heads
Video Signal:	EIA standard: NTSC color
Antenna	75-ohm external VHF antenna terminal 300-ohm external UHF antenna
Tuner	111 channel
Type	Frequency synthesis, Auto Programming
Broadcast Channels:	VHF 2 - 13, UHF 14 - 83

Cable-TV Channels:	Midband A-5 through A-1 (95-99); A-8 (01) Midband A through I (14-22) Superband J through W (23-36)
Power Requirements	120V AC, 60Hz
Power Consumption	22 watts
Weight	11 lbs.
Dimensions	3-15/16" High 14-9/16" Wide 10-3/8" Deep

Note: Specifications and features are subject to change without notice.

RCA Limited Warranty Video Cassette Recorder

What does your warranty cover:

- Any defect in material or workmanship.

For how long after purchase:

- Ninety days for labor charges.
- One year for parts.

The warranty period for rental VCR's begins with the first rental.

What will we do:

- Pay any RCA Authorized VCR Servicenter the labor charges to repair your VCR.
- Provide new or, at our option, rebuilt replacement parts for the RCA Authorized VCR Servicenter to make the repairs.

How do you get service:

- Take your VCR to any RCA Authorized VCR Servicenter. For their names and locations, ask your dealer or RCA Distributor, or look in the Yellow Pages.
- Show the service technician your evidence of purchase date.
- Pick up your VCR when repairs are completed.

What does your warranty *not* cover:

- Customer instruction. Your Owner's Manual provides information regarding operating instructions and user controls. For additional information ask your dealer.
- Installation and set-up service adjustments.
- Signal reception problems caused by external antenna or cable systems.
- Damage from misuse or neglect.
- Cleaning of video/audio heads, which is normal maintenance.
- Remote control batteries.
- VCR's which have been modified or incorporated into other products.
- VCR's purchased or serviced outside the USA.

How does state law relate to this warranty:

- This warranty gives you specific legal rights, and you may also have other rights which vary from state to state.

What if you purchased your VCR in Canada:

- Refer to the Canadian Warranty.

Si un livret d'instructions en français n'est pas inclus avec votre appareil, vous pouvez en obtenir un (INDIQUER LE NUMÉRO DE MODÈLE, VOTRE NOM, ET VOTRE ADRESSE) en vous adressant à:

Service des données techniques
2900 de Miniac
St Laurent, Quebec, Canada
H4S 1N5

RCA

©1988 Thomson Consumer Electronics, Inc.
Trademark(s)® Registered
Marca(s) Registrada(s)
Printed in Japan
Job A-58530
E72118
4630361
Part Number 2826 830-1

Thomson Consumer Electronics, Inc.
600 N Sherman Dr, PO Box 1976
Indianapolis, IN 46206-1976

Free Manuals Download Website

<http://myh66.com>

<http://usermanuals.us>

<http://www.somanuals.com>

<http://www.4manuals.cc>

<http://www.manual-lib.com>

<http://www.404manual.com>

<http://www.luxmanual.com>

<http://aubethermostatmanual.com>

Golf course search by state

<http://golfingnear.com>

Email search by domain

<http://emailbydomain.com>

Auto manuals search

<http://auto.somanuals.com>

TV manuals search

<http://tv.somanuals.com>