

VR539

USER'S GUIDE

Important Information	i
Table of Contents	1
Hooking Up the VCR.....	2
Setting Up the VCR.....	7
Using the Remote Control.....	12
Playing a Tape.....	18
Recording a Program	25
References.....	35
Index	42

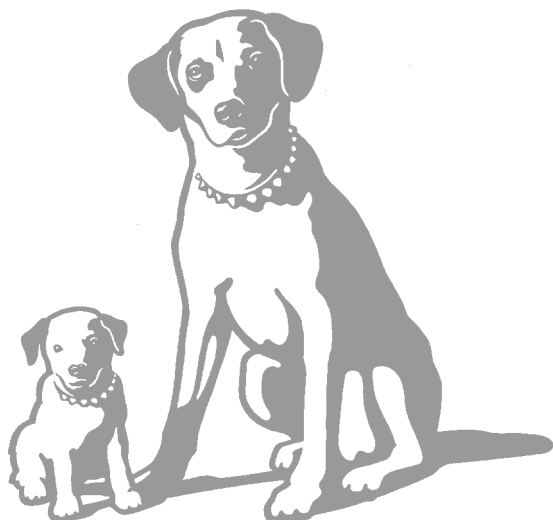

VIDEO CASSETTE RECORDER

RECORDER

Important Information

WARNING

To reduce the risk of fire or shock hazard, do not expose this VCR to rain or moisture.

WARNING

RISK OF ELECTRIC SHOCK
DO NOT OPEN

TO REDUCE THE RISK OF ELECTRIC SHOCK, DO NOT REMOVE COVER (OR BACK). NO USER SERVICEABLE PARTS INSIDE. REFER SERVICING TO QUALIFIED SERVICE PERSONNEL.

 This symbol indicates "dangerous voltage" inside the product that presents a risk of electric shock or personal injury.

 This symbol indicates important instructions accompanying the product.

Cautions

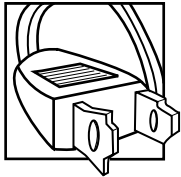

To prevent electric shock, match wide blade of plug to wide slot, fully insert.

ATTENTION: Pour éviter les chocs électriques, introduire la lame la plus large de la fiche dans la borne correspondante de la prise et pousser jusqu'au fond.

Do not defeat the safety feature of the plug. The wide blade fits into the wall socket only one way. If you need an extension cord, make sure it matches the plug of the VCR.

For U.S.A. — Operate VCR only on 120 volts, 60Hz AC power (normal house power).

For safety reasons, make sure any equipment or accessories connected to this product bears the UL listing mark, or if purchased and used in Canada, the CSA certification mark. If in doubt, contact qualified service personnel.

FCC Regulations state that unauthorized changes or modifications to this equipment may void the user's authority to operate it.

Note To Cable TV Installer

This reminder is provided to call your attention to Article 820-40 of the National Electrical Code (Section 54 of the Canadian Electrical Code, Part 1) which provides guidelines for proper grounding and, in particular, specifies that the cable ground shall be connected to the grounding system of the building as close to the point of cable entry as practical.

Product Registration

Please fill out the product registration card and return it immediately. Returning this card allows us to contact you if needed.

Keep your sales receipt to obtain warranty parts and service and for proof of purchase. Attach it here and record the serial and model numbers in case you need them. The numbers are located on the back of the VCR.

Model No. VR539

Serial No. _____

Purchase Date: _____

Dealer/Address/Phone: _____

Table of Contents

Important Information

Warnings _____	i
Cautions _____	i
Note to Cable TV Installer _____	i
Product Registration _____	i

Hooking Up the VCR

Choosing a Hookup _____	2
Antenna or Cable System Without a Cable Box _____	3
Cable System With Cable Box to Unscramble All Channels _____	4
Cable System With Cable Box to Unscramble Pay Channels _____	5
Connecting Two VCRs for Copying Tapes_	6

Setting Up the VCR

Startup	
Check Accessories With VCR _____	7
Insert Batteries in Remote _____	7
Turn on TV and VCR _____	7
Use the On-screen Menu System _____	8
Place Channels in VCR's Memory _____	9
Add or Remove Channels from VCR's Memory _____	9
Use TV+VCR Button _____	10
Set the Auto TV/VCR Feature _____	10
Set the Time and Date _____	11

Using the Remote Control

Component, VCR, TV, and Cable Box or RCA Satellite Receiver Buttons __	12-13
Controlling a VCR _____	14
Controlling a TV _____	15
Controlling a Cable Box or RCA DSS™ Satellite Receiver _____	16
Controlling an RCA Auxiliary Component_	17

Playing a Tape

Operating Instructions _____	18
Using the Playback Features	
Auto Play Feature _____	19
Pause for Stop-Action _____	19
Slow Motion _____	19
Picture Search _____	19
DISPLAY Button _____	20
Frame Advance _____	20

Automatic Tracking _____	20
Manual Tracking _____	20
Time Counter _____	21
Index Search _____	21
Time Search _____	22
Go-To Search _____	22
Blank Search _____	23
Commercial Scan _____	23
Pro-Tect Plus™ Locking Feature ____	23
Auto Repeat _____	24

Recording a Program

Types of Recordings _____	25
Basic Recording -	
Operating Instructions _____	25
Watch a TV Channel While VCR is Recording a Different Channel ____	25
Recording Features	
Recording Speeds _____	26
Recording Pause _____	26
Express Recording (XPR) _____	27
Recording While You're Away	
Setting Up the Cable Box or Satellite Receiver _____	28
VCR Plus+ Recording _____	29-30
Timer Recording With TV On _____	31
Timer Recording With TV Off _____	32
Checking or Clearing a VCR Plus+ or Timer Recording _____	32
Editing a VCR Plus+ or Timer Recording _____	32
Timer Recording From the VCR's Line Input _____	33
Using Two VCRs for Copying and Editing Tapes _____	34

References

Location of Controls	
Front Panel _____	35
Display Panel _____	36
Back Panel _____	37
Trouble Checks _____	38-39
Limited Warranty _____	40
Specifications _____	41
Cleaning the VCR _____	41
Index _____	42-43

Choosing a Hookup

The hookups on pages 3 through 5 are divided into two hookup types: Basic (A) and Advanced (B).

The basic hookup shows the backs of TVs that have only an antenna/cable connection. It is the easier of the two and additional accessories may not be needed.

The advanced hookup shows the VCR hooked up to a monitor/receiver (TV with audio and video jacks) using a signal splitter. This connection may improve the picture quality as well as convenience of operation.

Answer the questions to choose the hookup for your VCR.

1. How do you receive your TV signals?

Choose one answer from below.

- A. Outside antenna – Turn to page 3.
- B. Rabbit ears (set-top) and/or bow tie antenna – Turn to page 3.
- C. Cable System – Go to question 2.

2. What type of Cable-TV system* do you have?

Choose one answer from below.

- A. Cable without a box – Turn to page 3.
- B. Cable box to unscramble all the channels – Turn to page 4.
- C. Cable box to unscramble only pay channels, such as HBO, Showtime, Cinemax, etc. – Turn to page 5.

*You may need to contact your local cable company for assistance.

Optional Hookups

How to hook up two VCRs for copying tapes?

- A. Select a hookup by answering questions 1 and 2 above.
- B. Then modify the connections as shown on page 6.

Antenna or Cable System Without a Cable Box

A. Basic hookup.

Use this hookup for a simple connection which requires fewer accessories.

1. **Set the CH3 CH4 switch on back of VCR to either channel 3 or 4.**
You will tune the TV to this channel and use the TV•VCR button to watch the VCR.
2. **Connect as shown.**
This connection may require additional accessories not provided.
3. **Plug in power cords of VCR and TV.**
4. **Continue to page 7.**

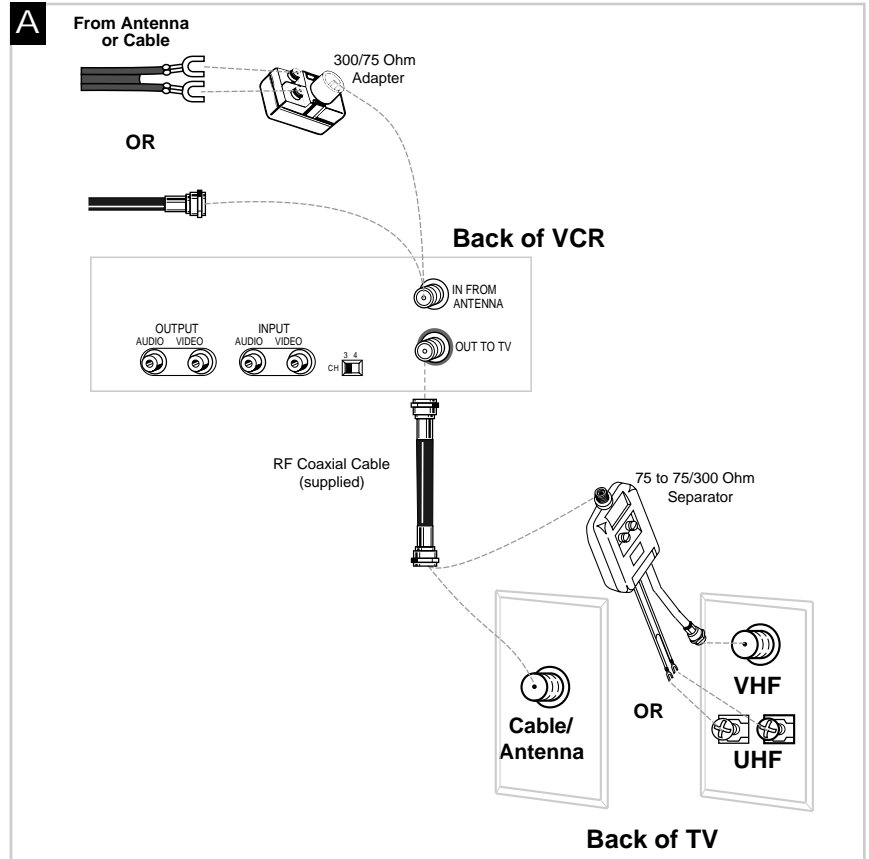

B. Advanced hookup.

Use this hookup for slightly improved picture quality and more convenient operation — use of TV•VCR button not required.

1. **Connect as shown.**
This connection requires additional accessories not provided.
2. **Plug in power cords of VCR and TV.**
3. **Continue to page 7.**

You will tune the TV to its video input to watch the VCR.

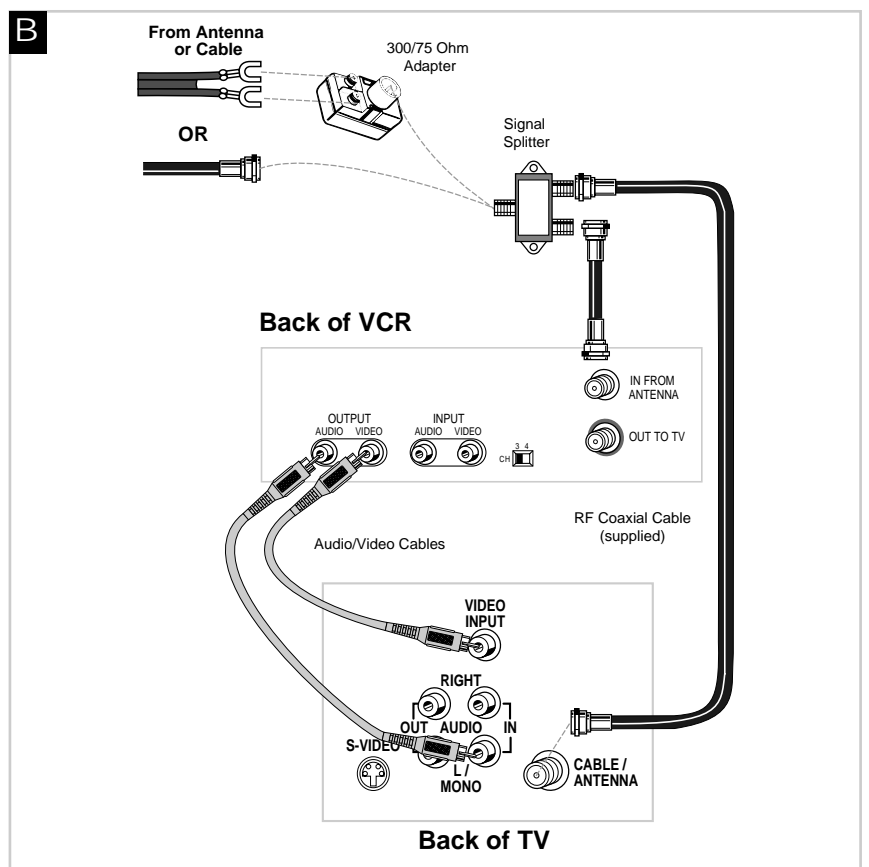

Cable System With Cable Box to Unscramble All Channels

Position Cable Box

Position a remote-controllable cable box on top of the VCR as shown. Be sure not to block any of the VCR's ventilation holes.

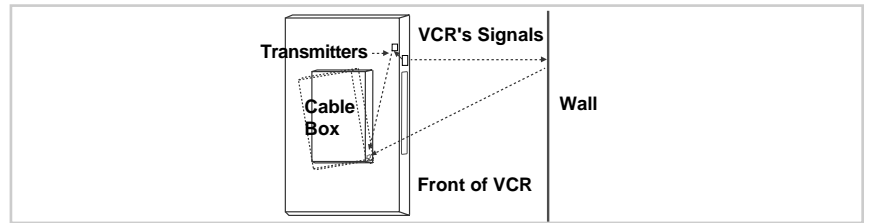

A. Basic hookup.

Use this hookup for a simple connection which requires fewer accessories.

1. **Set the CH3 CH4 switch on back of VCR to either channel 3 or 4.**

You will tune the TV to this channel and use the TV•VCR button to watch the VCR.

2. **Connect as shown.**

This connection may require additional accessories not provided.

3. **Plug in power cords of VCR, TV, and cable box.**

4. **Continue to page 7.**

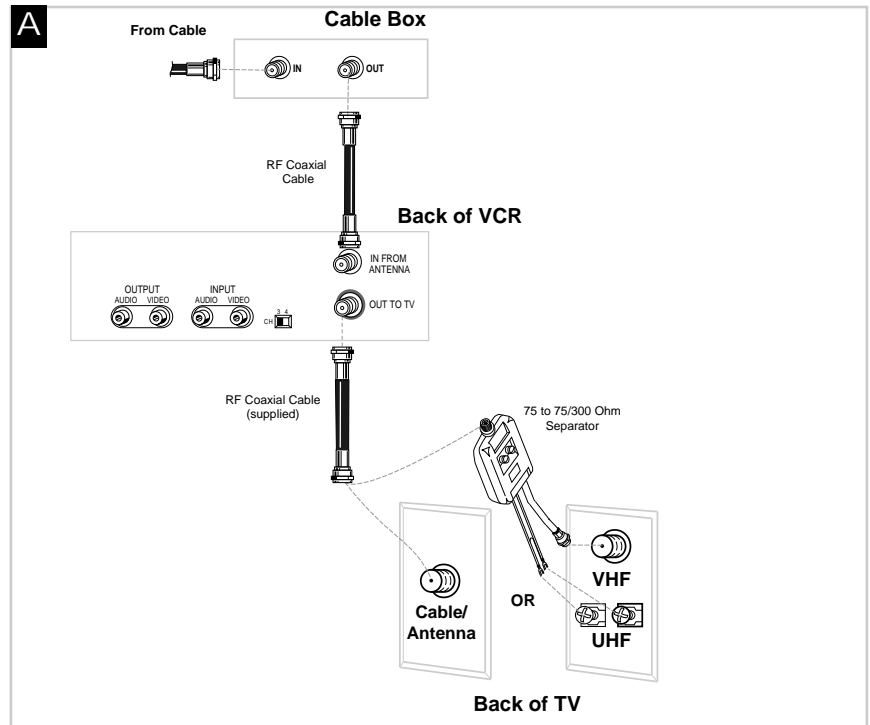

B. Advanced hookup.

Use this hookup for slightly improved picture quality and more convenient operation — use of TV•VCR button not required.

1. **Connect as shown.**

This connection requires additional accessories not provided.

2. **Plug in power cords of VCR, TV, and cable box.**

3. **Continue to page 7.**

You will tune the TV to its video input to watch the VCR.

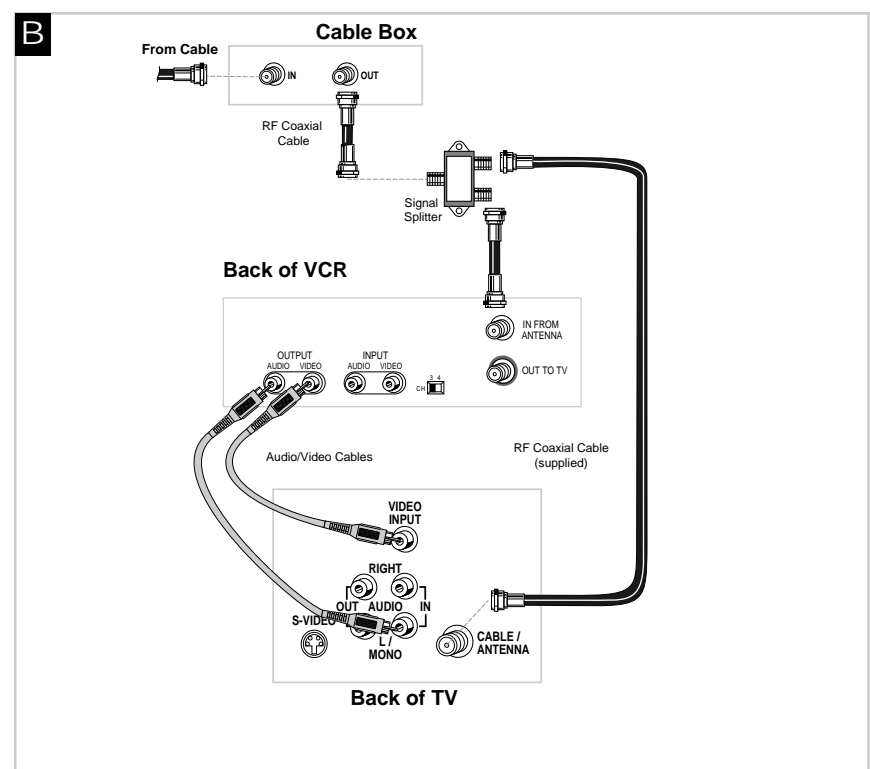

Cable System With Cable Box to Unscramble Pay Channels

(such as HBO, Showtime, Pay-Per-View, etc.)

Position Cable Box

Position a remote-controllable cable box on top of the VCR as shown. Be sure not to block any of the VCR's ventilation holes.

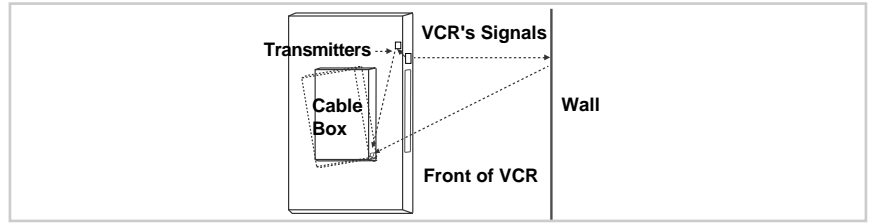

A. Basic hookup.

Use this hookup for a simple connection which requires fewer accessories.

1. **Set the CH3 CH4 switch on back of VCR to either channel 3 or 4.**
You will tune the TV to this channel and use the TV•VCR button to watch the VCR.
2. **Connect as shown.**
This connection may require additional accessories not provided.
3. **Plug in power cords of VCR, TV, and cable box.**
4. **Continue to page 7.**

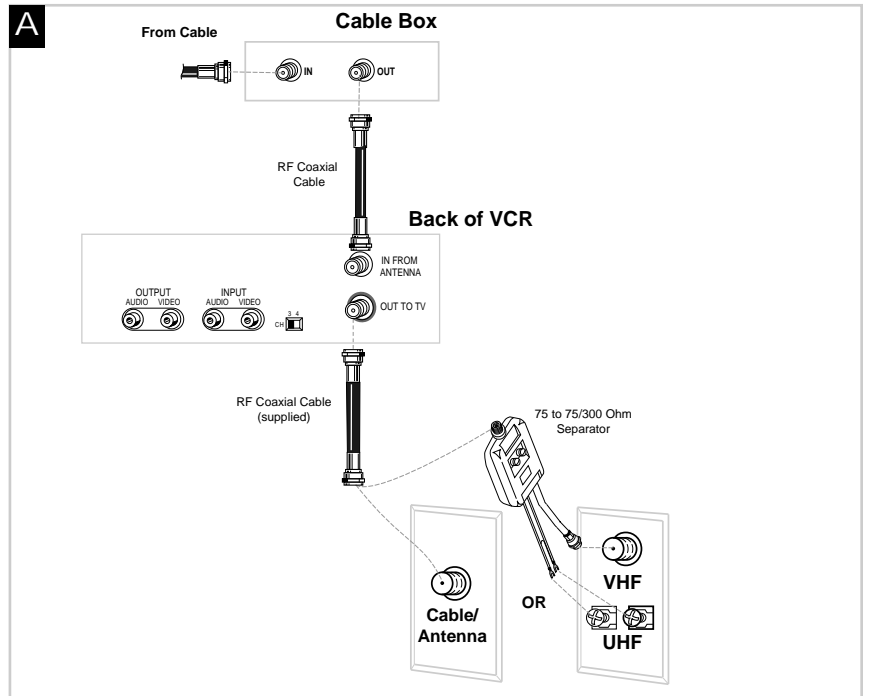

B. Advanced hookup.

Use this hookup for slightly improved picture quality and more convenient operation — use of TV•VCR button not required.

1. **Connect as shown.**
This connection requires additional accessories not provided.
2. **Plug in power cords of VCR, TV, and cable box.**
3. **Continue to page 7.**
You will tune the TV to its video input to watch the VCR. All pay channels are viewed through the VCR.

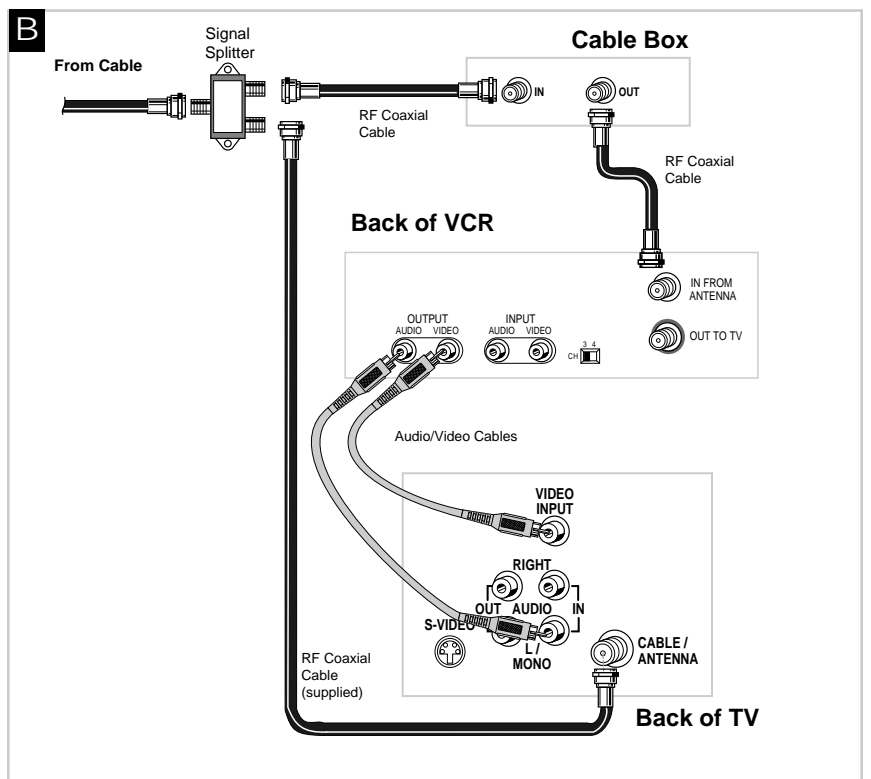

Connecting Two VCRs for Copying Tapes

Option A hookup.

Use this hookup for a simple connection which requires fewer accessories.

1. **Select a hookup from pages 2 through 5 and then modify with this connection.**
2. **Set the CH3 CH4 switch on the playback VCR to either channel 3 or 4.**
You will tune the recording VCR to this channel to receive the signal from the playback VCR.
3. **Connect as shown.**
This connection may require additional accessories not provided.
4. **Plug in power cords of VCRs and TV.**
5. **Continue to page 7.**

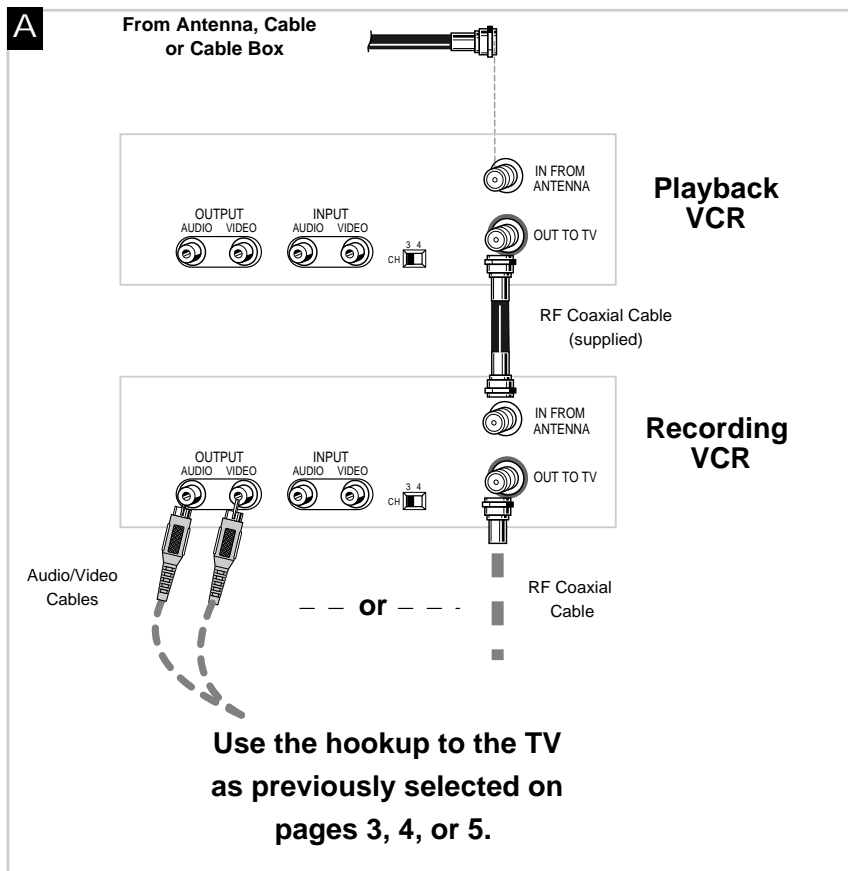

Option B hookup.

Use this hookup for slightly improved copy quality and more convenient operation — use of TV•VCR button not required.

1. **Select a hookup from pages 2 through 5 and then modify with this connection.**
2. **Connect as shown.**
This connection requires additional accessories not provided.
3. **Plug in power cords of VCRs and TV.**
4. **Continue to page 7.**

You will select the audio/video input L1 or on the recording VCR to receive the signal from the playback VCR.

Caution: The unauthorized recording of television programs and other materials may infringe the rights of others.

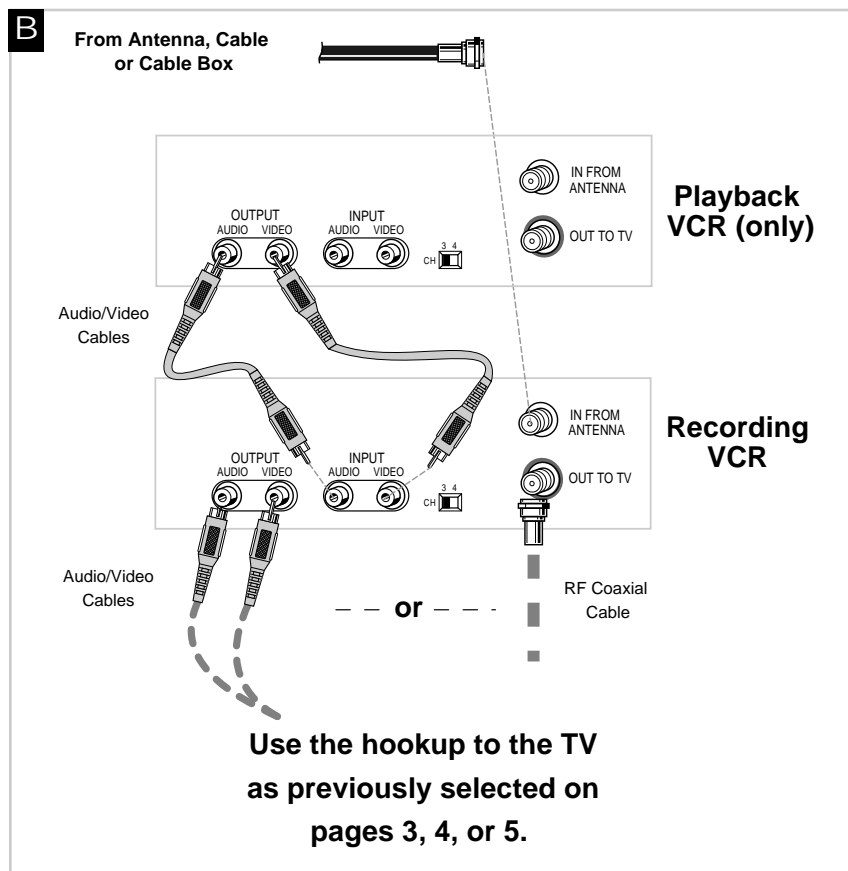

Startup

1. Check accessories with VCR.

Contact your dealer if any items are missing.

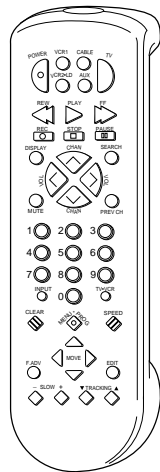

Remote (Stock No. 221318)

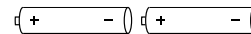

2 "AAA" Batteries



RF Coaxial Cable
(Stock No. 207417)

2. Insert batteries in remote.

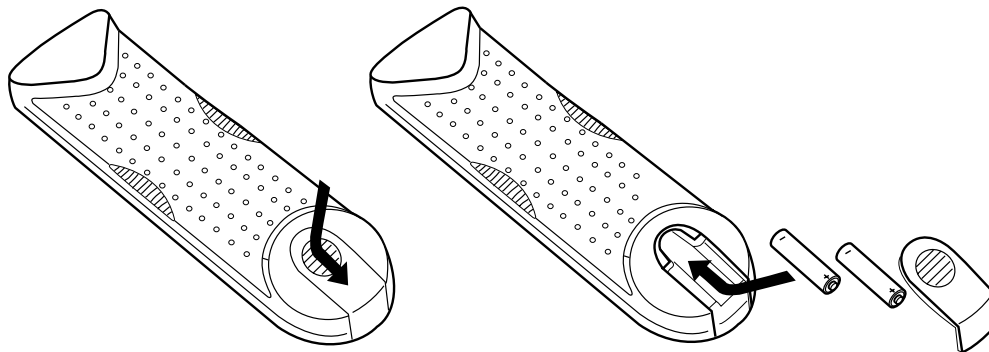

3. Turn on the TV.

- A. Turn on the TV.
- B. If you used one of the basic hookups, tune the TV to the channel selected with the CH3 CH4 switch on back of VCR.
If you used one of the advanced hookups, tune the TV to the TV's video input. (See TV owner's manual for details.)

4. Turn on the VCR.

- A. Press VCR1 on the remote.

The Interactive Guide appears the first time the VCR is turned on after connecting it. It is a step-by-step question-and-answer procedure that helps you select the feature options to set up the VCR quickly.

- B. Select 1 to Begin setup and answer the on-screen questions or select 2 to Cancel.

If you choose not to use the Interactive Guide feature, then follow the remaining steps in this section to set up the VCR to work properly.

```
      SETUP
The setup procedure
will help you configure
your VCR. Would you
like to begin the
setup procedure now?

1 Begin setup
2 Cancel
```

Startup

5. Use the on-screen menu system.

Point and Select is the method you use to move through the menu system. There are two ways to accomplish this method. One is using the **MENU•PROG** and **number buttons** on the remote that correspond to the numbered menu items. The second way is using **MENU•PROG** or **MENU** and **arrow** buttons on the remote or front of the VCR to **point and select** an item in the menu. Although there are two ways to access the menu system, only the number buttons are referenced throughout this manual to explain the VCR features and operations.

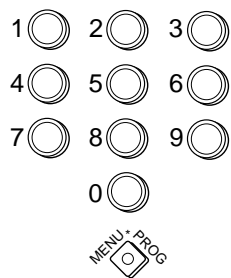

Using the number buttons

The number buttons allow you to point and select a menu item at the same time. They are also used to enter data and change settings of selected features.

An example of setting the time using the number buttons follows:

- Press MENU•PROG to bring up the VCR MAIN MENU on the TV screen.
- Press 6 to point and select SET VCR CLOCK.
- Enter the time and date with the number buttons on the remote. See page 11 for the details on how to enter the data.
- Follow the directions at the bottom of the screen when you finish entering the data.

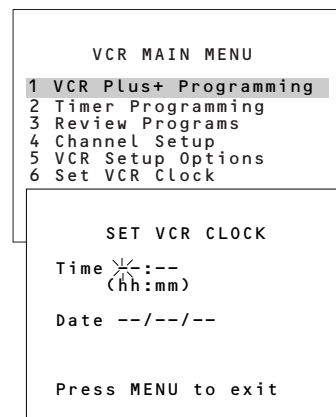

Using the arrow buttons

The on-screen menus can be accessed with either the arrow buttons on the remote or the front panel. Using the arrow buttons on the VCR front panel is especially helpful if the remote becomes inoperable. The up/down arrow buttons move the highlight bar up and down to point to a menu item, and the MENU•PROG button selects the item. They are also used to enter data and change settings of selected features. The left and right arrows move from one location to another with the right arrow moving forward and the left arrow moving backward.

An example of setting the time using the arrow buttons follows:

- Press MENU•PROG or MENU to bring up the VCR MAIN MENU on the TV screen.
- Press the down arrow button to highlight SET VCR CLOCK.
- Press MENU•PROG or MENU to select.
- Enter the time and date with the up and down arrow buttons. Press the up or down arrow button to move through the numbers to enter the first digit.
- Press the right arrow button to move one space to the right.
- Repeats steps D and E until the time and date are entered.
- Follow the directions at the bottom of the screen when you finish entering the data.

Note: Use the left arrow if you need to move backward.

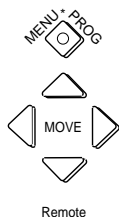
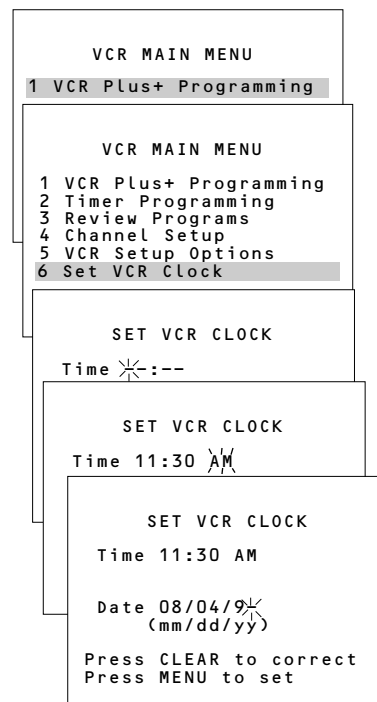

Remote

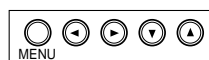

Front of VCR

Startup

6. Place channels in the VCR's memory.

Channels 2 through 13 including line input (L1/L2) are in the VCR's memory when you first turn it on. Pressing CHANNEL up or down stops on these channels. To get additional channels available on your antenna or cable system, you must use the Auto-Search Channels feature of the VCR. If you ever change cable or antenna signals, you may need to Auto-Search Channels again.

- A. Press VCR1 to set remote to control VCR.
- B. Press MENU•PROG on the remote to see the VCR MAIN MENU on the TV screen. If the menu does not appear on the TV screen:
 - Make sure TV is tuned to same channel as CH3 CH4 switch on VCR or the TV's video input (refer to TV's manual).
 - Press VCR1 and then press MENU•PROG.
 - If you use a basic hookup, check VCR indicator in display panel — it should be on. Press TV•VCR to turn it on.
 - Check the connections.
- C. Press 4 to select CHANNEL SETUP.
- D. Press 1 to begin Auto-Search Channels.

Wait until the channel numbers stop changing. This takes about one to two minutes. The TV will then tune to the lowest channel found. Pressing CHANNEL up or down will select only the active channels.

The VCR automatically selects ANTENNA or CABLE of the Tuning Mode feature in the CHANNEL SETUP menu. If you need to change the setting manually, press 3.

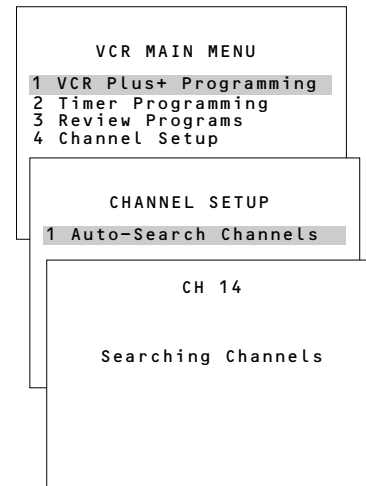

7. Add or remove channels from the VCR's memory.

You may want to add or remove channels if some of the channels are not active, have weak signals, or you do not want to watch them.

- A. Press VCR1.
- B. Press MENU•PROG on the remote to see the VCR MAIN MENU on the TV screen.
- C. Press 4 to select the CHANNEL SETUP menu.
- D. Press 2 to select the ADD/REMOVE CHANNEL menu.
- E. Follow the directions on the screen.
- F. Add or remove more channels by entering channel numbers or using CHANNEL up or down.

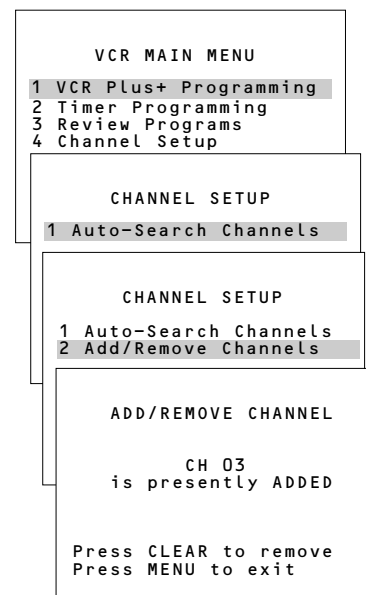

Startup

8. Use TV•VCR button.

Skip this step if you used one of the advanced hookups.

When using one of the basic hookups, the TV•VCR button lets you switch between the picture coming from the VCR or the picture from the TV channel. This button allows you to record a program on the VCR while watching another channel on the TV. *Details are on page 25.*

- A. Press VCR1 to set the remote to control the VCR.
- B. Press TV•VCR to see the picture from the VCR. The VCR indicator lights in the display panel.
- C. Press CHANNEL up or down to change channels on the VCR. The channel number changes on the TV screen and in the display panel.
- D. Press TV•VCR to see the TV channels. The VCR indicator does not light in the display panel. Change channels using the TV's remote.
- E. Return the TV to the VCR viewing channel — CH3 or CH4.
- F. Press VCR1, then TV•VCR to switch back to the picture from the VCR.

9. Set Auto TV/VCR feature.

Skip this step if you used one of the basic hookups.

If you have connected your VCR using the video input of your TV, you can prevent the VCR indicator from turning on automatically.

- A. Press MENU•PROG on remote to see VCR MAIN MENU.
- B. Press 5 to display SETUP OPTIONS.
- C. Press 3 to display CUSTOM SETUP.
- D. Press 2 to select Auto TV/VCR.
- E. Press 2 to switch between ON and OFF.
 - Select ON if you used one of the basic hookups and watch your VCR on channel 3 or 4 of your TV. You will then press the TV•VCR button to turn the VCR indicator on or off to switch between the picture coming from the VCR or television channels.
 - Select OFF if you used one of the advanced hookups and watch your VCR on the video input channel of your TV. The VCR indicator will not turn on automatically.

Pressing TV•VCR on the remote will still turn the VCR indicator on or off.

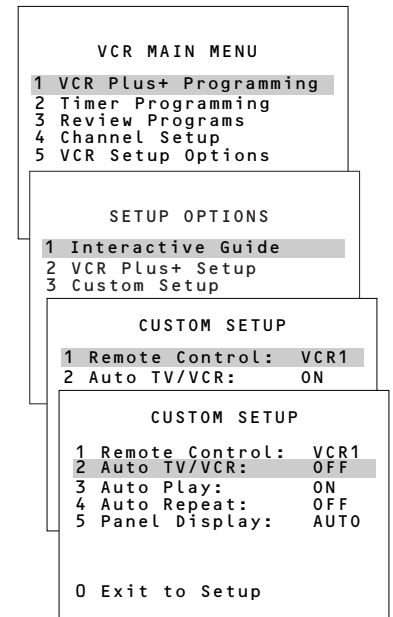

Startup

10. Set the time and date.

This --:-- appears in the clock area of the VCR's display panel.



- A. Press MENU•PROG on remote to display the VCR MAIN MENU on the TV screen.
- B. Press 6 to display SET VCR CLOCK.
- C. Enter the time and date with the number buttons on the remote.

- Press 0 before single-digit numbers.

Example: press 0, then 5, then 0, then 7 for a time of 5:07. Press 1 for AM or 2 for PM.

- Press CLEAR on the remote to change incorrect entries.

- D. Press MENU•PROG on remote to remove SET VCR CLOCK from the TV screen and start the clock.
- E. Press 0 to exit the menu system.

The time will appear in the VCR's display panel and the time and date will appear on the TV screen whenever you press DISPLAY.

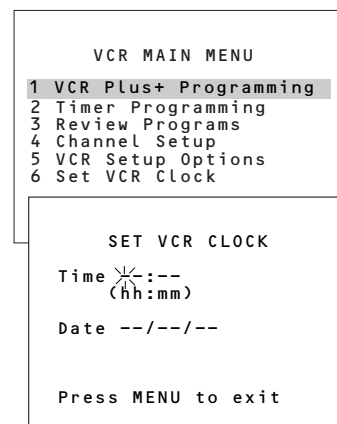

Buttons

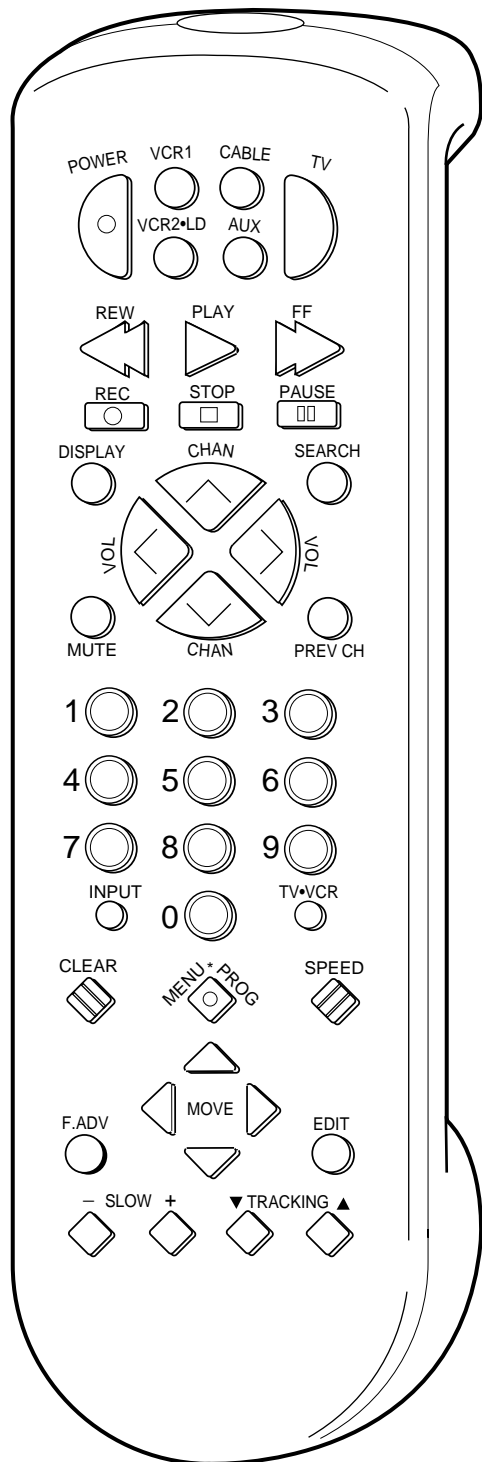

Component Buttons

Press one of the buttons to set the remote to operate that component.

AUX (Auxiliary)

Used with POWER button to turn on a compatible RCA audio component. See page 17.

is programmed to control that TV. See page 15.

CABLE

Used with POWER button to turn on a compatible cable box or an RCA DSS™ satellite receiver.* See page 16.

VCR1

Turns on a compatible RCA, ProScan or GE VCR and sets remote to control VCR.

TV

Turns on a compatible RCA, ProScan, or GE TV and sets the remote to control the TV.

VCR2•LD

Turns on a compatible RCA, ProScan or GE VCR and sets remote to control VCR when it has been set up. See page 14.

Used with POWER button to turn on another brand of TV when the remote

is programmed to control that TV. See page 15.

VCR Function Buttons

Press VCR1 (VCR2•LD) to set remote to control the VCR to use the function buttons.

Arrow Buttons (MOVE)

Allow you to move through the menus, enter data and change settings of selected features. See page 8.

FF (Fast Forward)

Fast forwards the tape when the VCR is stopped.

Searches the picture in forward motion during playback.

CHAN (Channel) Up or Down

Selects next higher or lower channel in the VCR's channel memory.

INPUT

Turns the line input (L1 or L2) in VCR display panel or VIDEO1 or VIDEO2 on TV screen on or off.

CLEAR

Resets time counter to 0:00:00.

Allows you to change entries when setting the clock or VCR for a VCR Plus+ or a timer recording.

Line input refers to the signal coming from the component connected to the audio/video input jacks on the back (L1) or front of the VCR (L2).

DISPLAY

Shows the status displays on the TV screen. See pages 20 and 36.

Edits timer programs.

MENU•PROG

Brings up VCR MAIN MENU on the TV screen.

Exits or removes a menu from the screen.

EDIT

Signals two properly connected VCRs to begin copying a tape. See page 34.

Selects a menu item.

F.ADV (Frame Advance)

Lets you view one frame with each press of the button when tape is in stop-action pause.

Numbers (0 through 9)

Select a channel up to 99 by pressing two numbers.

Select a cable channel over 99 by pressing and holding 1 until 1-- appears on the screen. Then press the other two numbers.

*DSS is a trademark of DIRECTV, Inc., a unit of GM Hughes Electronics.

VCR Function Buttons (continued)

<p>PAUSE Pauses action for viewing during playback. Pauses recording to prevent recording of unwanted scenes.</p> <p>PLAY Plays a tape.</p> <p>POWER Turns off VCR when remote is set to control the VCR.</p> <p>PREV CH (Previous Channel) Switches between two channels. Select one channel and then select another. Press PREV CH to switch between the two channels.</p>	<p>REC Starts VCR recording. Used for express recording (XPR). <i>See page 27.</i></p> <p>REW (Rewind) Rewinds the tape when the VCR is stopped. Searches the picture in reverse motion during playback.</p> <p>SEARCH Displays INDEX, TIME, GO-TO and BLANK SEARCH menus on TV. Advances tape 60 or 120 seconds during playback.</p> <p>SLOW - / + Used for slow-motion playback.</p>	<p>SPEED (Tape Speed) Selects a recording speed (SP, LP, SLP).</p> <p>STOP Stops the normal functions such as record, playback, rewind, fast forward, and pause of the VCR.</p> <p>TRACKING Up or Down Lets you manually reduce the streaks that may appear on the picture during play, slow, or pause. Reduces picture "jitter" during stop-action playback.</p> <p>TV•VCR Switches the picture signal so that it either comes from the VCR or the TV channel. <i>See page 10.</i></p>
--	--	---

TV Function Buttons

Press the TV button to set remote to control a compatible TV. Some buttons may not work with the TV.

<p>Arrow Buttons (MOVE ) Allow you to move through the menus, enter data and change settings of selected features.</p> <p>CHAN (Channel) Up or Down Selects next higher or lower channel in the TV's channel memory when remote is set to control a TV.</p> <p>CLEAR Removes menus or status displays from the screen.</p> <p>DISPLAY Shows the status displays on the screen.</p>	<p>Removes menus or displays from the screen.</p> <p>MUTE Turns the TV sound on or off.</p> <p>Numbers (0 through 9) Select a channel up to 99 by pressing two numbers. To select a cable channel over 99, press and hold 1 until 1-- appears on the screen. Then press the other two numbers.</p> <p>POWER Turns off a compatible TV when remote is set to control that TV.</p>	<p>Used with TV button to turn on a compatible TV that the remote has been programmed to control. <i>See page 15.</i></p> <p>PREV CH (Previous Channel) Switches between two channels. Select one channel and then select another. Press PREV CH to switch between the two channels.</p> <p>VOL (Volume) Up or Down Raises and lowers sound of TV.</p>
---	---	--

Cable Box or DSS™* Satellite Receiver Function Buttons

Press the CABLE button to set remote to control a compatible cable box or DSS satellite receiver (if connected). Some buttons may not work with the cable box or DSS satellite receiver. For the DSS satellite receiver, you will want to test the other remote buttons to see which ones work with the satellite receiver.

<p>CHAN (Channel) Up or Down Selects next higher or lower channel in the cable box or DSS satellite receiver's channel memory when remote is set to control a cable box or satellite.</p>	<p>Numbers (0 through 9) Select a channel up to 99 by pressing two numbers. To select a cable channel over 99, press and hold 1 until 1-- appears on the screen. Then press the other two numbers.</p>	<p>POWER Turns off a compatible cable box or DSS satellite receiver when remote is set to control that cable box or DSS satellite receiver.</p>
--	---	--

*DSS is a trademark of DIRECTV, Inc., a unit of GM Hughes Electronics.

Controlling a VCR

The VCR's remote controls two compatible RCA, ProScan or GE VCRs with the VCR1 and VCR2•LD buttons. Most compatible VCRs automatically respond to VCR1 without being programmed. If you own two compatible VCRs, test them to see if VCR1 turns on both VCRs. If it does, then you may want to program this VCR to respond to the VCR2•LD button on the remote.

Program the VCR for remote control

Set the Remote Control feature of the VCR to the VCR1 or VCR2 position. The remote then controls the VCR with either the VCR1 or VCR2•LD button — whichever position you select in the menu.

1. Press MENU•PROG to display the VCR MAIN MENU.
2. Press 5 to display the SETUP OPTIONS menu.
3. Press 3 to display the CUSTOM SETUP menu.
4. Press 1 to activate the Remote Control feature.
5. Press VCR1 or VCR2•LD to change the setting and program this VCR to respond to the VCR1 or VCR2•LD button — whichever you select.

Important Reminder: Remember you must press VCR1 or VCR2•LD on the remote — whichever you selected in the menu — before the remote will operate this VCR.

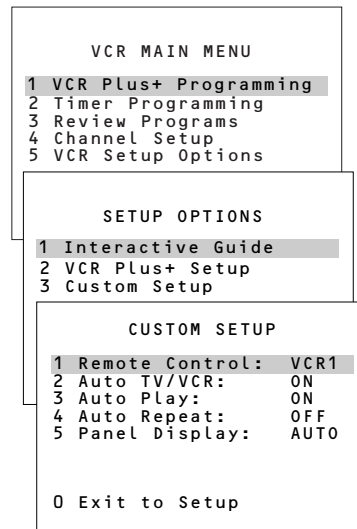

Controlling a TV

The VCR's remote is preprogrammed to control the basic functions of a compatible RCA, ProScan, or GE TV. The remote can also be set up to control other manufacturer's brands. To program the remote for another manufacturer's TV, enter the code that corresponds to your brand.

Program the remote for a TV

1. Turn on the TV.
2. Point the VCR remote at the TV.
3. Hold the TV button and press two number buttons to enter the code for your brand. If the TV changes channels when the CHAN up or down button is pressed, setup is complete.
4. Release the buttons.
5. Repeat steps 2 – 4 with a different code if the first one does not work.

TV Code List					
Brand *	Code Number(s)	Brand *	Code Number(s)	Brand *	Code Number(s)
Akai	03	Kawasho	03,06	Realistic	05
AOC	06	Kenwood	06,12	Sampo	06
Candle	06	Loewe	04	Samsung	06,09,12
Citizen	06	Luxman	06	Sanyo	05,08
Colorlyme	06	LXI	04,05,07	Sears	01,05,06,07,08,10,12
Concerto	06	Magnavox	04,06,12	Sharp	06,13
Curtis Mathes	01,06	Marantz	04,06	Sony	03
Daewoo	06	MGA	06,12	Soundesign	06
Daytron	06	Mitsubishi	06,12	Sylvania	04,06,12
Electrohome	06,12	MTC	06	Technics	11
Emerson	06	NAD	07	Techwood	06
Envision	05,06	NEC	06	Teknika	06
Fisher	05,08	Panasonic	04,11	TMK	06
GE	00,01,06,11	Philco	04,06,12	Toshiba	05,07,09
Goldstar	06,12	Philips	03,04,06,12	Universal	00
Hallmark	06	Pioneer	06	Victor	10
Hitachi	06	Portland	06	Wards	00,01,04,06,12,13
Infinity	04	ProScan	01	Yamaha	12
J C Penney	00,01,06,09	Proton	06	Zenith	02
JBL	04	Quasar	11		
Jensen	06	Radio Shack	01,05,13		
JVC	10,11	RCA	01,06,12		

* The remote may not be able to control every TV model of the brands listed.

Helpful Hint: Notice the difference between the TV and VCR on-screen displays. This is one way to tell if the remote is set to control the VCR or the TV.

Operate the TV

After you have set up your remote to control your TV, test the TV buttons to see which ones operate your TV.

1. Point the remote at the TV and press TV.
2. If TV does not turn on in step 1, press TV and then POWER.
3. Use the "TV Function Buttons" as described on page 13.

Controlling a Cable Box or an RCA DSS™* Satellite Receiver

The CABLE button on the VCR's remote is preprogrammed to control either a compatible RCA cable box or an RCA DSS satellite receiver. If the cable box is another manufacturer's brand and it has its own remote, then you may be able to program the VCR's remote to control the cable box. To program the remote for another manufacturer's cable box, enter the code that corresponds to your brand.

Program the remote for a cable box

1. Turn on the cable box.
2. Point the VCR remote at the cable box.
3. Hold the CABLE button and press two number buttons to enter the code for your brand.
4. Release the buttons.
5. Press POWER on the remote. If the cable box turns off, setup is complete.
6. Repeat steps 2 – 5 with a different code if the first one does not work.

Cable Box Code List			
Brand **	Code Number(s)	Brand **	Code Number(s)
ABC	53,54	Philips	07, 08, 19, 26, 28, 29, 32, 33, 40, 41
Anvision	07, 08	Pioneer	18, 20, 44
Cablestar	07, 08	Randtek	07, 08
Eagle	07, 08	RCA	00, 27
Eastern International	02	Regal	12, 13
General Instrument	04, 05, 15, 23, 24, 25, 30, 36	Regency	02, 33
Hamlin	12, 13, 34,48	Samsung	44
Hitachi	37, 43	Scientific Atlanta	03, 22, 35
Jerrold	04, 05, 15, 23, 24, 25, 30, 36, 45, 46,47	Sylvania	11
Macon	37, 43	Teknika	06
Magnavox	07, 08, 19, 26, 28, 29, 32, 33, 40, 41	Texscan	10, 11
NSC	09	Tocom	17, 21,49, 50
Oak	01, 16, 38	Unika	31, 32, 41
Oak Sigma	16	Universal	51, 52
Panasonic	03, 27, 39	Viewstar	07, 08, 19, 26, 28, 29, 32, 33, 40, 41
		Warner Amex	44
		Zenith	14, 42

** The remote may not be able to control every cable box model of the brands listed.

Operate the cable box or RCA DSS satellite receiver

After you have set up your remote to control your cable box (if required), test the buttons to see which ones operate your cable box or RCA DSS satellite receiver.

1. Point the remote at the cable box or satellite receiver and press CABLE.
2. If the cable box or satellite receiver does not turn on in step 1, press CABLE and then POWER.
3. Use the "Cable Box Function Buttons" for the cable box or satellite receiver or test the other remote buttons for the satellite receiver box.

*DSS is a trademark of DIRECTV, Inc., a unit of GM Hughes Electronics.

Controlling an RCA Auxiliary Component

The remote that came packed with your VCR can control only compatible RCA audio components, such as a radio, CD player, tape player or turntable. The remote must be programmed for the specific component the remote is to control. To program the remote, use the code that corresponds to your component.

Program the remote for an RCA auxiliary component

1. Turn on the component.
2. Point the VCR remote at the component.
3. Hold the AUX button and press two number buttons to enter the code for the component.
4. Release the buttons.
5. Press POWER on the remote. If the component turns off, setup is complete.

Type of Auxiliary Equipment and Code*				
	AM/FM	CD	TAPE	PHONO
RCA	03	07	06	05

* The remote may not be able to control every RCA model of the auxiliary equipment listed.

Operate the auxiliary component

After you have set up your remote to control your component, test the buttons to see which ones operate the component.

1. Point the remote at the component and press AUX.
2. If the component does not turn on in step 1, press AUX and then POWER.

Operating Instructions

To play a tape

1. Turn on the TV and tune it to channel 3, 4, or TV's video input to see the picture from the VCR.
2. Insert a tape in the VCR.

VCR automatically turns on. The cassette-in  indicator lights, and the VCR indicator lights if the Auto TV/VCR feature is set to ON. The tape automatically begins playback if the safety tab on the cassette has been removed and the Auto Play feature is turned on.

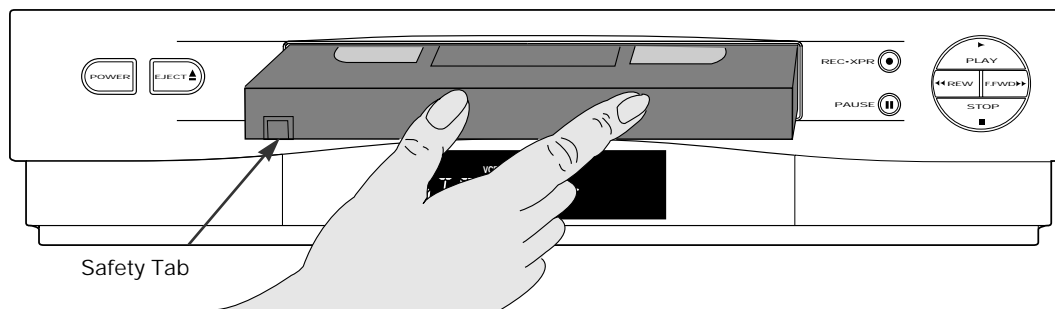

3. Press PLAY, if necessary. PLAY appears in the VCR's display panel.
4. Press TRACKING up or down on the remote or CHANNEL • TRACKING up or down on the VCR to remove any streaks from the picture, if necessary. *Details are on page 20.*
5. Press STOP on the VCR or remote.
6. Press REW.
The VCR automatically rewinds the tape if it reaches the end of the tape during playback. While rewinding, you can press POWER and the VCR will turn off after rewinding.
7. Press EJECT on the VCR to eject the tape once it is completely rewound.

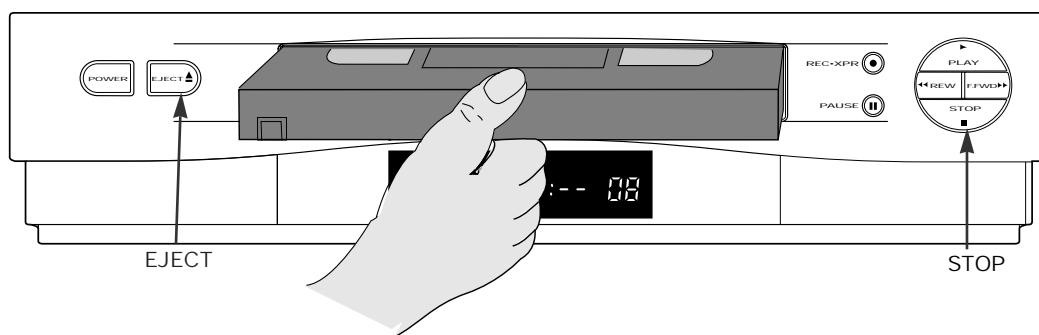

Using the Playback Features

Auto Play Feature

This feature lets you tell the VCR whether you want it to automatically start playing a tape that is inserted with the safety tab removed.

1. Press MENU•PROG on the remote to see the VCR MAIN MENU on the TV screen.
2. Press 5 to select the SETUP OPTIONS menu.
3. Press 3 to select the CUSTOM SETUP menu.
4. Press 3 to select Auto Play: ON or OFF.
 - Select ON to have a tape with its safety tab removed start playing automatically.
 - Select OFF if you do not want a tape with its safety tab removed to start playing automatically.

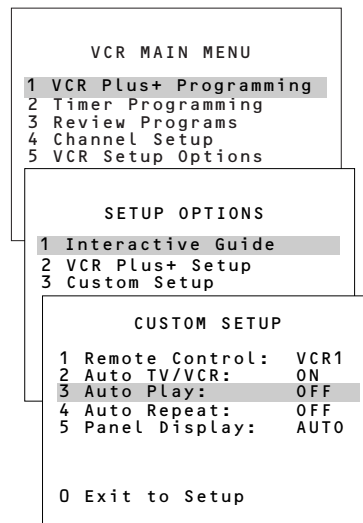

Pause for Stop Action

This feature stops the tape in action and allows you to examine the details of the scene. Stop action works best for tapes recorded in the SP and SLP speeds.

1. Press PAUSE during playback to stop the action. STILL appears in the VCR's display panel.
2. Press TRACKING up or down on the remote or CHANNEL•TRACKING on the VCR to reduce any jittering of the picture.
3. Press PAUSE or PLAY to return to playback.

The VCR switches automatically from stop-action playback to stop after a few minutes.

Slow Motion

You can view the picture in slow motion during play or play pause. SLOW + and - allow you to change the speed. Sound is turned off during slow-motion playback. Slow motion works best in the SP and SLP speeds.

1. Press SLOW + to increase the speed or - to decrease the speed.
2. Use TRACKING up or down on the remote or CHANNEL•TRACKING on the VCR to remove any streaks from the picture.
3. Press PLAY to return to playback.

The VCR switches automatically from slow-motion playback to stop after a few minutes.

Picture Search

You can search a picture during playback by fast forwarding or rewinding the tape. Sound is turned off during picture search. The picture is best for tapes recorded in the SP or SLP speed.

Fast Forward Search

1. Press F.FWD on the VCR or FF on the remote to search forward at a faster-than-normal speed.
2. Press F.FWD on the VCR, FF on the remote, or PLAY to return to playback.

Rewind Search

Use REW instead of F.FWD for the same steps as in "Fast Forward Search."

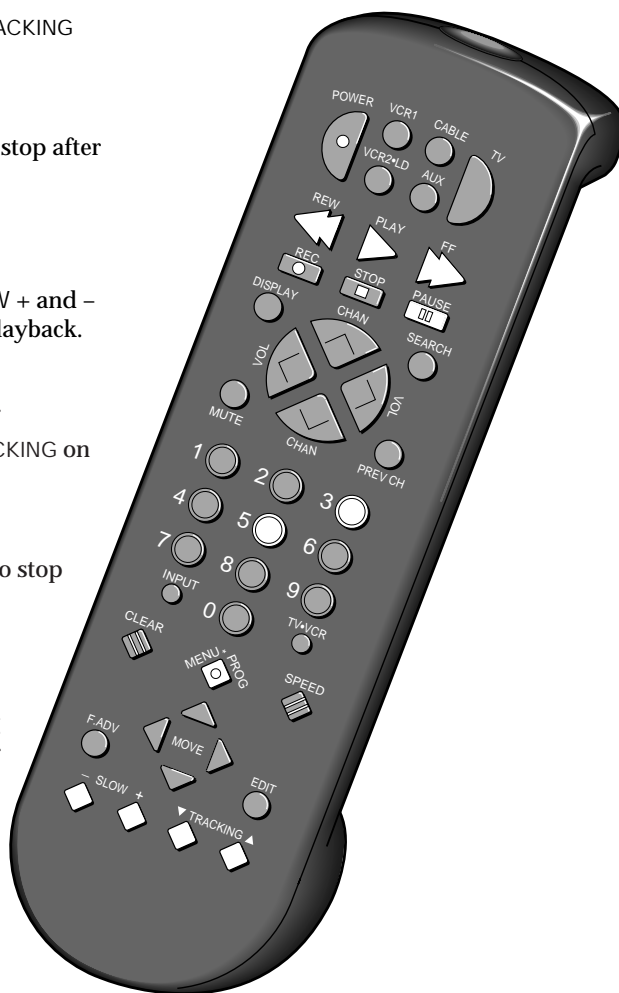

Using the Playback Features

DISPLAY Button

1. Press DISPLAY to display the status of the VCR, channel number, time counter, date, time, and tape speed on the TV screen.
The time and date must be set before they are displayed. If you do not press DISPLAY again, this display times out.
2. Press DISPLAY again to continually display the time counter on the TV screen. The time counter appears instead of the time in the VCR's display panel.
3. Press DISPLAY again to remove the time counter from the TV.
The time counter remains in the VCR's display panel and no status displays appear on the TV screen. This is convenient for editing tapes.
4. Press DISPLAY again to return to the normal displays.
The clock appears in the VCR's display panel.
Turning off the VCR automatically returns the displays to normal.

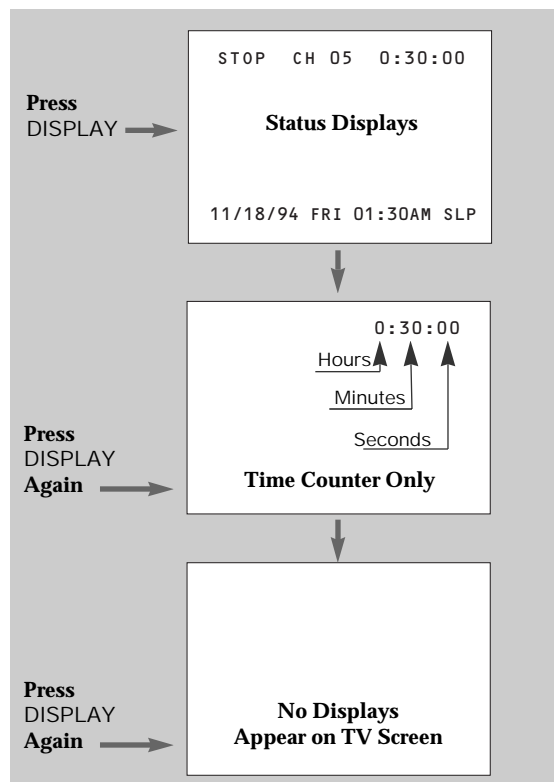

Frame Advance (F.ADV Button)

Frame advance lets you view one stop-action frame after another. Frame advance works best for tapes recorded in the SP or SLP speeds.

1. Press PAUSE to stop the action.
2. Press F.ADV each time you want to view the next frame of the scene.
3. Press PAUSE or PLAY to resume normal playback.

Automatic Tracking

The VCR has automatic tracking which adjusts the picture when playing back a tape recorded on another VCR. Automatic tracking is turned on whenever a tape is inserted or the VCR's power is turned on.

Manual Tracking

Occasionally, you may need to manually adjust tracking on a tape recorded on a different VCR or camcorder. The TRACKING buttons on the remote or CHANNEL • TRACKING on the VCR are used when playing a tape. They have no effect during recording.

When streaks or snow appear during normal or slow-motion playback, press TRACKING up or down on remote or CHANNEL • TRACKING on VCR for the best possible picture. During stop-action pause, use the TRACKING buttons to reduce picture jitter.



Using the Playback Features

Time Counter

The time counter shows the actual time it takes to record a program or play back a segment of a prerecorded tape. It helps locate the beginning or end of programs you taped. The time counter resets to 0:00:00 whenever the tape is ejected from the VCR.

For example, if a 30-minute program was recorded at the beginning of the tape, you would:

1. Insert the prerecorded tape.
2. Press DISPLAY twice to display only the time counter on the TV screen.
3. Press F.FWD on the VCR or FF on the remote to fast forward the tape until the time counter reads 0:30:00.
4. Press STOP.
This is the approximate end of the program and you can begin recording at this spot.
5. Press CLEAR to reset the time counter to 0:00:00.
6. Press DISPLAY twice to remove the time counter from the screen and return to the normal display mode.

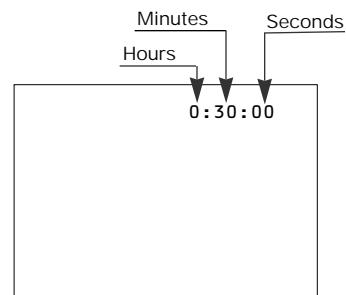

Index Search

The VCR has a "VHS Index Search System" that automatically records an index mark on the tape every time you start recording. During playback you can locate the program you want to play by the number of index marks.

The VCR will automatically locate the index number you select. The VCR will search forward or reverse from the location you are on the tape.

1. Insert the prerecorded tape and press STOP.
2. Press SEARCH on the remote to display the INDEX SEARCH menu on the TV screen.

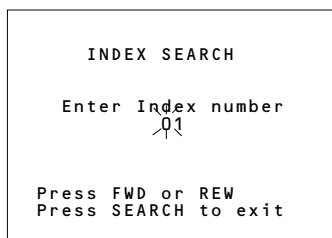

3. Press two number buttons to enter the number of index marks you want the VCR to search.
Press CLEAR on the remote to correct an entry.
4. Press F.FWD on the VCR or FF on the remote to search forward or REW to search in reverse.
5. Press STOP to stop index searching.

Some index marks may be missed by the VCR.

- A mark too close to your location on the tape.
- The mark at the beginning of a recorded segment of five minutes or less.
- The first index mark on the tape when you start at the beginning of the tape.



Using the Playback Features

Time Search

The VCR searches forward or reverse for the amount of time you select from the location where you are on the tape.

1. Insert the prerecorded tape and press STOP.
2. Press SEARCH on the remote twice to display the TIME SEARCH menu on the TV screen.

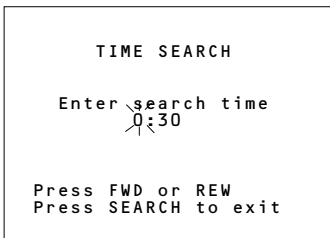

3. Press number buttons to enter the amount of time in hours and minutes you want the VCR to search.
Press CLEAR on the remote to correct an entry.
4. Press F.FWD on the VCR or FF on the remote to search forward or REW to search in reverse.
5. Press STOP to stop time searching.

Go-To Search

The VCR will search for the time counter reading you select and automatically begin playing back the tape.

1. Insert the prerecorded tape and press STOP.
2. Press SEARCH on the remote three times to display the GO-TO SEARCH menu on the TV screen.

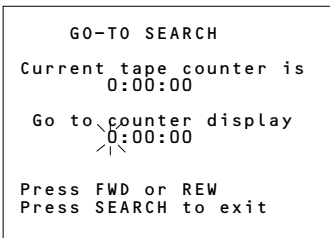

3. Press number buttons to enter the hour(s) and minute(s) of the time counter reading you want the VCR to search.
Press CLEAR on the remote to correct an entry.
4. Press F.FWD on the VCR or FF on the remote or REW to go to the time counter reading you entered.
5. Press STOP to stop go-to searching.

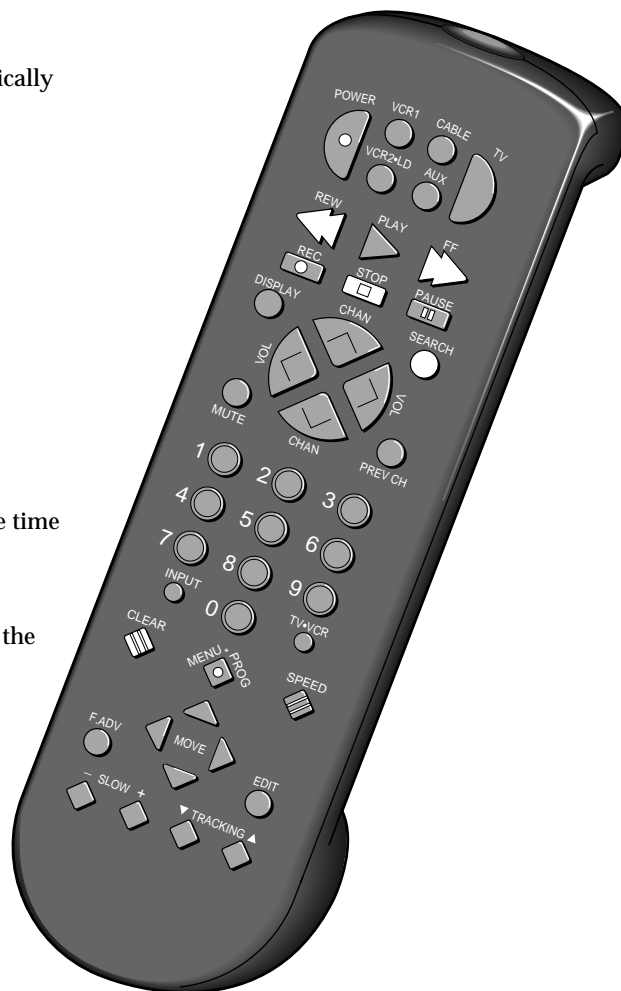

Using the Playback Features

Blank Search

The VCR searches for blank portions of the tape that are more than six seconds in length.

1. Insert the tape and press STOP.
2. Press SEARCH on the remote four times to display the BLANK SEARCH menu on the TV screen.

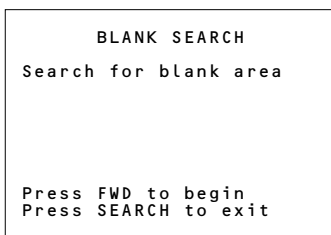

3. Press F.FWD on the VCR or FF on the remote to begin searching for six seconds of blank tape. A message appears on the screen if a blank area is not found.
4. Press STOP to stop blank searching.

Commercial Scan (SEARCH Button)

This is useful for scanning commercials or short program segments.

1. Press SEARCH once during playback to advance the tape approximately 60 seconds.
2. Press SEARCH twice during playback to advance the tape approximately 120 seconds.

Pro-Tect Plus™ Locking Feature

To disable the usage of the VCR or protect your timer recordings from any unwanted changes, lock the VCR. The buttons on the VCR or remote will not work. Just follow the directions below to lock and unlock the VCR.

1. Press and hold POWER on the remote for 10 seconds.
LOCK will appear in the VCR's display panel.
2. Press and hold VCR1 (VCR2•LD) on the remote until HELLO appears in the VCR's display panel to unlock the VCR.

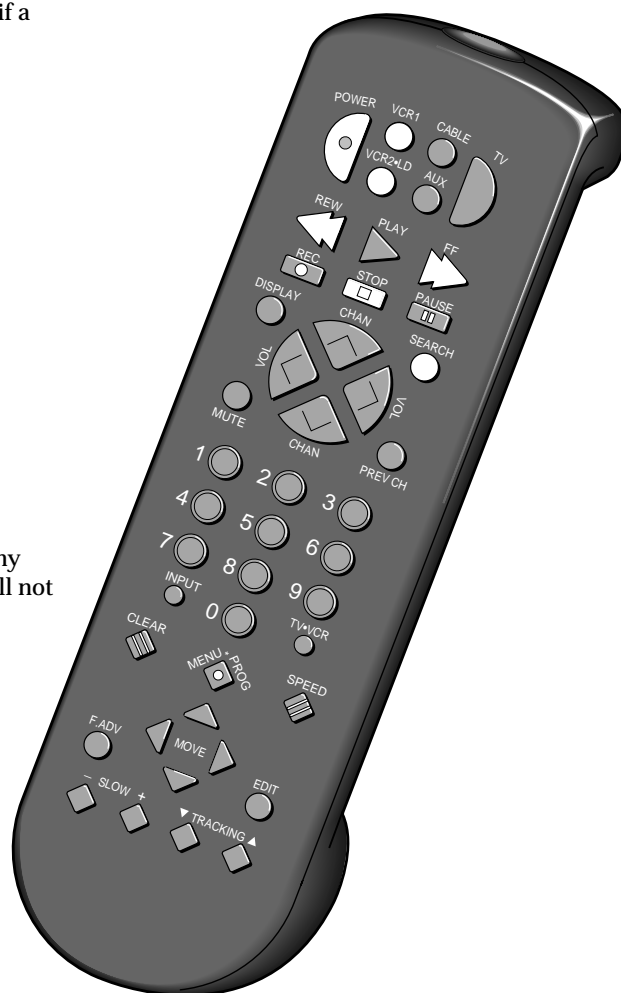

Using the Playback Features

Auto Repeat

You can play a portion of a program or an entire program over and over again. The portion or program cannot exceed a maximum length of 9 hours and 59 minutes.

1. Insert a pre-recorded tape and press STOP.
2. Go to the beginning of the segment you wish to repeat and press STOP.
3. Press DISPLAY twice to bring up the time counter, then press CLEAR to reset it to 0:00:00.
4. Press MENU•PROG on the remote to display the VCR MAIN MENU on the TV screen.
5. Press 5 to display the SETUP OPTIONS menu.
6. Press 3 to display the CUSTOM SETUP menu.
7. Press 4 to select Auto Repeat.
8. Enter the time in hours and minutes for the length of the program.
9. Press MENU•PROG to set and then exit the menu system.
The amount of time you enter appears in the Auto Repeat line.
10. Press PLAY.

The tape plays for the length of time you entered, rewinds and begins play again.

11. Press STOP.
12. Follow steps 4 - 7 to turn the Auto Repeat feature off and then exit the menu system.

Turn off the Auto Repeat feature for normal playback of a tape.

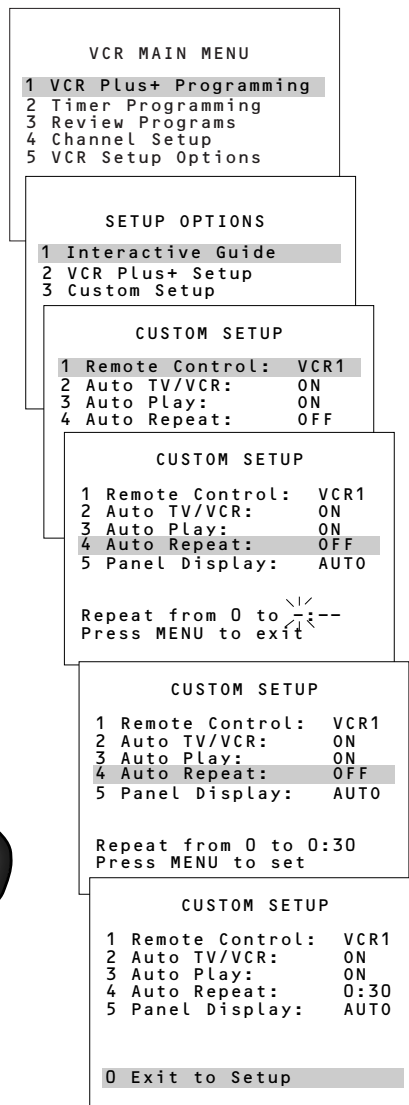
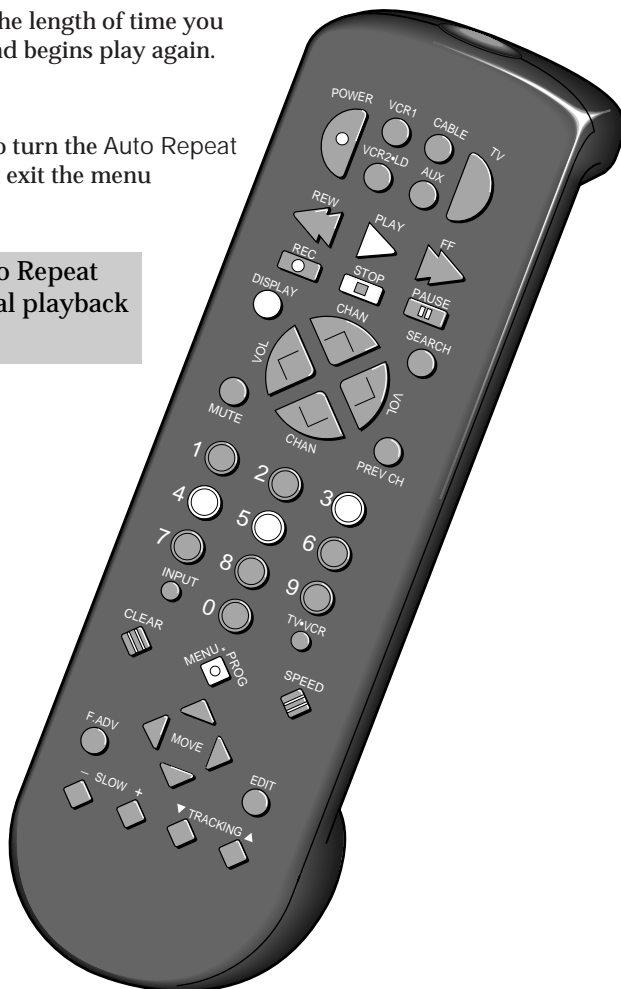

Types of Recordings

Your VCR provides different types of recording. These types are explained in the following sections:

Basic Recording – Operating Instructions

Express (XPR) Recording

Recording While You're Away

VCR Plus+ Recording

Timer Recording

Using Two VCRs for Copying Tapes

Basic Recording – Operating Instructions

To make a recording

Turn on the TV and tune it to the VCR viewing channel, either 3, 4, or TV's video input channel.

1. Insert a tape with safety tab in place.
2. Press VCR1 (VCR2•LD) to set remote to control VCR.
3. If using one of the basic hookups, make sure the VCR indicator appears in the VCR's display panel. If not, press TV•VCR to turn it on.
4. Select recording speed using SPEED on the VCR or remote.
The tape speed indicator appears in the VCR's display panel and on the TV screen.
5. Select the channel to be recorded.
The channel number appears in the VCR's display panel and on the TV screen.
6. Press REC on the remote or REC•XPR on the VCR to begin recording. REC appears in the VCR's display panel while the VCR is recording.

Watch a TV channel while VCR is recording a different channel

1. Follow steps 1 through 6 above.
2. If using one of the basic hookups, press TV•VCR to switch to the TV channel. The VCR indicator turns off in the display panel.
3. Press TV to set the remote to control TV functions for a compatible TV.
4. Select the channel you want to watch with the TV's channel buttons.
5. Press STOP on VCR or remote when recording is finished.

Recording Features

Recording Speeds

Pressing the SPEED button on the VCR or remote selects a recording speed (SP, LP, or SLP). The speed you select appears on the TV screen.

Cassette	Recording Time		
	SP	LP	SLP
T-120	2Hr	4Hr	6Hr
T-160	2Hr 40Min	5Hr 20Min	8Hr

SP (Standard Play) gives the best quality recording. That is why most prerecorded, rental tapes are recorded in SP. Fewer programs can be recorded on the tape. Special effects such as pause, slow motion, picture search, and frame advance work well in this speed.

LP (Long Play) gives twice the recording time of tapes recorded in SP. Special effects in playback are not recommended in LP.

SLP (Super Long Play) gives three times the recording time of tapes recorded in SP. Special effects such as pause, slow motion, picture search, and frame advance work well in this speed.

Recording Pause

This feature allows you to prevent recording short passages of unwanted material.

Press PAUSE during recording to stop and start recording.

REC P appears in the VCR's display panel.

The VCR automatically switches from pause to stop after a few minutes.

Express Recording (XPR)

Express recording lets you record up to four hours without using the timer program feature. The VCR will turn off automatically at the end of the recording.

Display showing 30 minutes remaining for express recording.

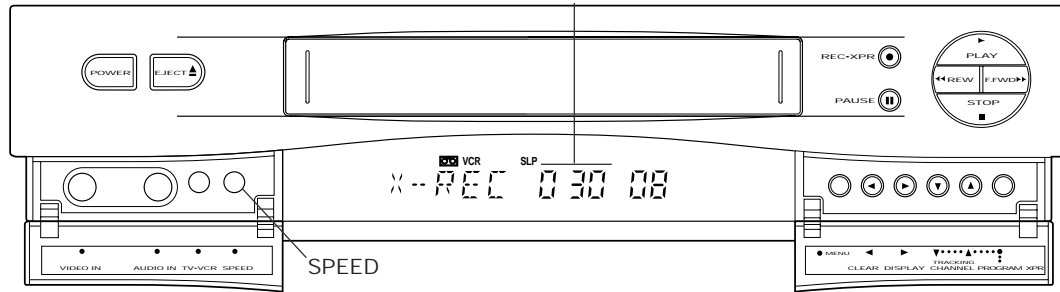

Operating Instructions

1. Turn on the VCR.
2. Insert a tape with safety tab in place.
3. Select the channel you want to record.
4. Select the desired recording speed using SPEED on the VCR or remote.
5. Press REC to activate recording.
6. Press REC repeatedly until the amount of recording time for the program is displayed in the VCR's display panel or on the TV screen.

Each press of REC increases the time — 30 minutes up to 4 hours.

Press REC	Recording Time
0:30	(30 Min)
1:00	(1 Hr)
1:30	(1 Hr, 30 Min)
2:00	(2 Hrs)
3:00	(3 Hrs)
4:00	(4 Hrs)
0:00	(XPR Turns Off)

Express Display on TV Screen
RECORD LENGTH 0:00 CH 04
Press REC to set length

The amount of time the VCR will record and the X -- REC indicator appear in the VCR's display panel. Pressing REC displays the time remaining on the TV screen. Pressing REC again increases the amount of time.

Stopping a Recording in Progress

With the VCR: Press POWER and then STOP within a few seconds.

With the Remote: Press VCR1 (VCR2•LD) and then STOP within a few seconds.



Recording While You're Away

Setting Up the Cable Box or Satellite Receiver

Sat./Cable Box Setup allows the VCR to record programs from the cable box or satellite receiver. If your cable box or satellite receiver can be controlled by a remote, the VCR may be able to tune it to the channel you want to record during VCR Plus+ and timer recordings. You may need to position the remote-controllable cable box on top of the VCR at an angle to receive the infrared remote signal. See pages 4-5.

1. Press MENU•PROG to display the VCR MAIN MENU on the TV screen.
2. Press 4 to select CHANNEL SETUP menu.
3. Press 4 to select Sat./Cable Box Setup menu.
4. **If cable box or satellite receiver is not used for all channels:** Press 2. You are finished with Sat./Cable Box Setup.

If cable box or satellite receiver is used for all channels: Press 1 to continue.

5. Press two numbers on the remote to enter the output channel of your cable box or satellite receiver. Press 0 before a single-digit number. (Valid numbers are 01 – 13.)

If you connected your cable box or satellite receiver to the VCR using the box's AUDIO/VIDEO OUT jacks, press INPUT on the remote to select the VIDEO1 or 2 option.

Press CLEAR on the remote to correct an entry.

6. Press MENU•PROG to proceed.
The VCR now automatically enters the output channel of your cable box or satellite receiver as the channel to be recorded in the VCR PLUS+ and Timer Programming menus.
7. **Manually Controlled Cable Box:** You are finished with Cable Box and VCR Plus+ Setup. Press MENU•PROG to exit.

Remotely Controlled Cable Box: Enter your cable box code from the chart on page 16 and follow the on-screen directions.

The VCR changes the cable box from channel 02 to channel 09 when you enter the correct code for your cable box. If none of the codes work, the VCR does not control your cable box. If your cable box can be controlled by the VCR, complete VCR Plus+ setup on the next page.

8. Exit the menu system by following the directions on the

Important: If your cable box or satellite receiver is controlled by the VCR, turn it on before the recording is to begin. If your cable box or satellite receiver is not controlled by the VCR, turn on the cable box or satellite receiver and tune it to the channel you want to record before the recording is to begin.

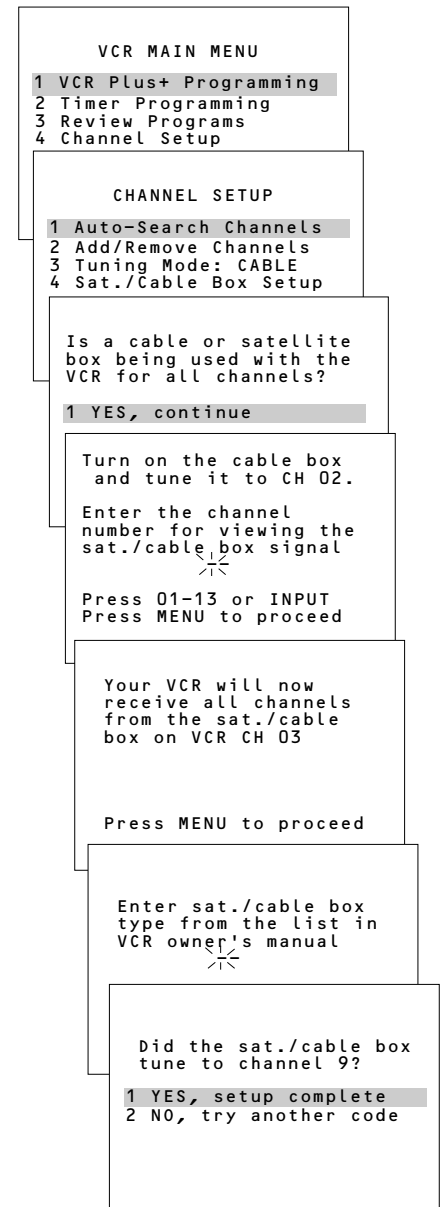

Recording While You're Away (VCR Plus+* Recording)

VCR Plus+ Setup for Antenna System, Cable System Requiring No Cable Box, or Cable Box That VCR Can Control

A VCR Plus+ channel number is assigned for each broadcast or cable channel. These numbers are listed in most publications that list PlusCode numbers.

1. Prepare a worksheet for the VCR Plus+ channels that are different than the channels you receive them on. Refer to the chart below for standardized VCR Plus+ channel numbers.

Broadcast or Cable-TV Station Name	VCR Plus+ Channel Number	Channel Number You Receive This Station On
HBO	33	See Note 1
ESPN	34	See Note 1
ABC	See Note 2	See Note 1
FOX	See Note 2	See Note 1

Note 1: Check your local or cable listing for the channel number you receive this station on.
 Note 2: Check your local listing for the broadcast or VCR Plus+ channel number assigned to this station.

2. Press MENU•PROG on the remote to display the VCR MAIN MENU on the TV screen.
3. Press 5 to select SETUP OPTIONS menu.
4. Press 2 to select VCR PLUS+ CHANNEL LIST menu.
5. Using your worksheet, press two numbers to enter each channel number you receive on a **different** channel than the assigned VCR Plus+ channel number.

If a channel in your area has been assigned more than one VCR Plus+ channel number, enter that same channel number next to each VCR Plus+ channel number.

6. Press CHAN up or down to move the VCR+ CH numbers up or down on the menu.
7. Press CLEAR on the remote to erase a number.
8. Press MENU•PROG to exit when you are finished.
9. Press 0 to exit the menu system.

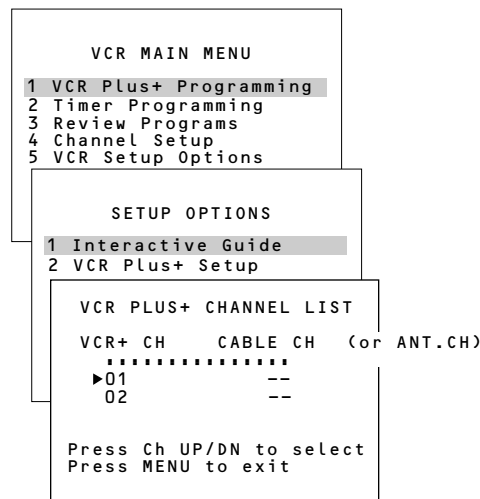

Standardized VCR Plus+ Channel Numbers for Cable-TV

U.S.A. List		Canadian List	
35 American Movie Classics	58 The Movie Channel	65 MeteoMedia/The Weather Network	
39 Arts & Entertainment	48 Music Television	48 MuchMusic Network	
57 Black Entertainment	49 The Nashville Network	55 MusiquePlus	
54 Bravo	38 Nickelodeon	52 Nashville Network	
42 Cable News Network	64 Nostalgia Television	73 Newsworld/CBC	
45 Cinemax	99 Quality Value Cable	53 Le Reseau des Sports	
98 Cinemax 2	41 Showtime	43 The Sports Network	
37 The Discovery Channel	97 Showtime 2	64 Super Ecran	
53 The Disney Channel	59 Sports Channel	37 Super Ecran B	
63 Entertainment Television	52 Turner Network Television	98 Super Ecran C	
34 ESPN Sports Network	44 USA Network	66 Telatino Network	
47 The Family Channel	62 Video Hits 1	46 TV5 Montreal	
33 Home Box Office	93 Viewer's Choice 1	92 Viewer's Choice 1	
95 Home Box Office 2	94 Viewer's Choice 2	93 Viewer's Choice 2	
96 Home Box Office 3	55 WGN Chicago	94 Viewer's Choice 3	
51 The Learning Channel	43 WTBS Atlanta	95 Viewer's Choice 4	
46 Lifetime	60 WWOR New York	71 Vision TV: Canada's Faith Network	
		38 Youth TV, Canada Inc	

*VCR Plus+ and PlusCode are trademarks of Gemstar Development Corporation.

Recording While You're Away (VCR Plus+ Recording)

The VCR Plus+ and timer program features let you program the VCR to record up to eight different programs within a one year period. Before using VCR Plus+ to record a program, make sure that:

- The clock is set correctly.
- A tape with safety tab has been inserted with enough tape to record the programs.
- The remote is set to control the VCR — using VCR1 (VCR2•LD).
- The VCR is set up for VCR Plus+ programming.
 - If you receive all channels through a cable box or satellite receiver, complete setup *on page 28*.
 - If you do not use a cable box for all channels, have a cable box that can be controlled by the VCR or use an antenna, complete VCR Plus+ Setup *on page 29*.

Setting a VCR Plus+ Recording

1. Press MENU•PROG on the remote to display the VCR MAIN MENU on the TV screen.
2. Press 1 to select VCR PLUS+.
3. Press numbers on the remote to enter PlusCode number for the program you want to record. VCR PlusCode numbers are found in most local TV listings.
Press CLEAR on the remote to correct an entry.
4. Press MENU•PROG to enter the program.
If the VCR does not recognize the PlusCode number, Unrecognized number... Please re-enter appears on the TV screen. Check the number and enter it again.
5. Press 1, 2, 3, or 4 to select type of program.
 - 1 One time – single program recorded once.
 - 2 Daily – program recorded at same time every day.
 - 3 Weekdays – program recorded at same time Monday through Friday.
 - 4 Weekly – program recorded at same time once a week.
6. Select recording speed using the SPEED button on the remote or VCR.
7. Press CLEAR repeatedly to change the program End Time and enter the new time.
This feature allows you to extend the recording time on VCR Plus+ program before the program is saved. This option may be useful when recording programs such as sporting events that could go past scheduled broadcast times.
8. Press MENU•PROG to enter your program. A reminder appears which will time out or you can press MENU•PROG to return to the VCR MAIN MENU.
PROGRAMS OVERLAP may appear on the screen if you entered two programs where the times overlap.
9. Repeat steps 2 – 6 for additional programs or press MENU•PROG repeatedly to remove the menu from the TV screen.
10. **Turn off the VCR** before recording time.
11. If using a cable box the VCR can control, turn on the cable box before the recording is to begin. If using a cable box the VCR cannot control, turn on the cable box and tune it to the channel you want to record before the recording is to begin.

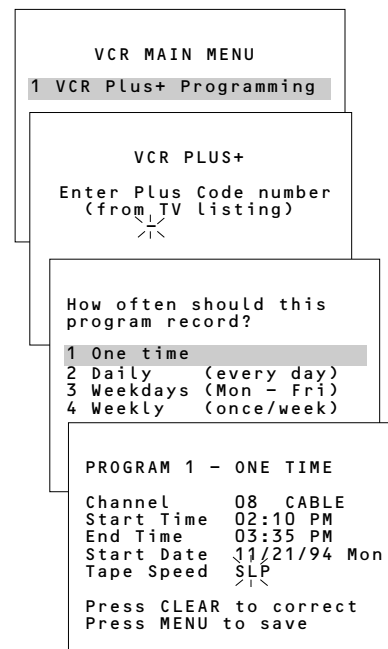

Stopping a Recording in Progress

With the VCR: Press POWER and then STOP within a few seconds.

With the Remote: Press VCR1 (VCR2•LD) and then STOP within a few seconds.

Recording While You're Away (Timer Recording)

You can set a timer program with the TV on or the TV off. The timer program feature lets you program the VCR to record up to eight different programs within a one year period. Before setting the timer, make sure that:

- The clock is set correctly.
- A tape with safety tab has been inserted with enough tape to record the programs.
- The remote is set to control the VCR — using VCR1 (VCR2•LD).
- If you receive all channels through a cable box or satellite receiver, complete setup *on page 28*.

Setting a Timer Recording With TV On (On-screen Menus)

1. Press MENU•PROG on the remote to display the VCR MAIN MENU.
2. Press 2 to select the Timer Programming menu.
3. Press 1, 2, 3, or 4 to select type of program.
 - 1 One time — single program recorded once.
 - 2 Daily — program recorded at same time every day.
 - 3 Weekdays — program recorded at same time Monday through Friday.
 - 4 Weekly — program recorded at same time once a week.
4. Press number buttons on the remote to enter the channel number (or INPUT to select line input), start time including AM or PM, end time, and start date of the recording. Just follow the on-screen prompts.

Press CLEAR to correct an entry.

If you receive all channels from a cable box or satellite receiver and have completed cable box setup *on page 28*, the VCR enters the output channel as the channel to be recording in the VCR Plus+ and Timer Programming menus.
5. Select recording speed using SPEED.
6. Press MENU•PROG to enter your program. A reminder appears which times out or you can press MENU•PROG to return to the main menu.

PROGRAMS OVERLAP may appear on the screen if you have entered two programs where the times overlap.
7. Repeat steps 2–6 for additional programs or press MENU•PROG to remove the menu from the TV screen.
8. **Turn off the VCR** before recording begins.

TIMER appears in the VCR's display panel when the timer has been programmed.
9. If using a cable box the VCR can control, turn on the cable box before the recording is to begin. If using a cable box the VCR cannot control, turn on the cable box and tune it to the channel you want to record before the recording is to begin.

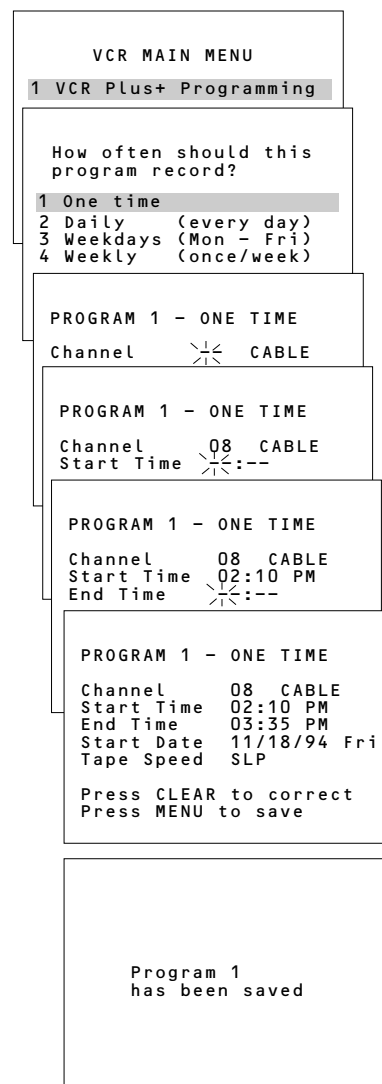

Recording While You're Away (Timer Recording)

Setting a Timer Recording With TV Off (Clock On VCR)

1. Use the PROGRAM XPR and the up or down buttons behind right front panel control door to enter the information.
2. Press PROGRAM XPR to bring up the display. The channel number flashes.
3. Press the up or down arrow to select the channel number.
4. Repeat steps 2 - 3 to enter the START, END, DATE, and tape SPEED. The time increases in increments of 30 minutes while the date increases in increments of one.
5. Press PROGRAM XPR when SAVE flashes in the display. SAVED appears to let you know the program is set.

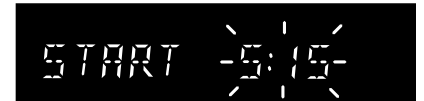

Stopping a Recording in Progress

With the VCR: Press POWER and then STOP within a few seconds.

With the Remote: Press VCR1 (VCR2•LD) and then STOP within a few seconds.

Checking or Clearing a VCR Plus+ or Timer Recording

1. Press MENU•PROG on remote to display VCR MAIN MENU on TV screen.
2. Press 3 for Review Programs. The black highlights the area for review.
3. Follow the on-screen prompts for checking or clearing the program.

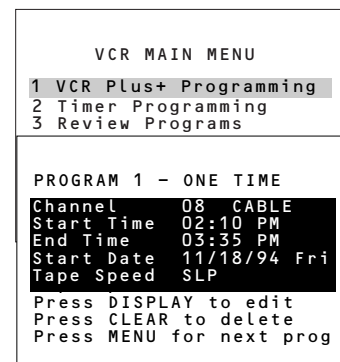

Editing a VCR Plus+ or Timer Recording

1. Press MENU•PROG on remote to display VCR MAIN MENU on TV screen.
2. Press 3 for Review Programs. The black highlights the area for review.
3. Press DISPLAY when a program you want to edit appears.
4. Use the right or left arrow buttons to move to the location you want to change or use CLEAR or number buttons, then enter the data.
5. Follow the directions at the bottom of the screen to edit.

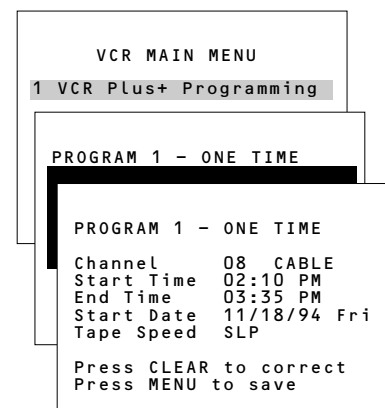

Recording While You're Away (Timer Recording)

Timer Recording From the VCR's Line Input

The line input refers to the signal coming from the AUDIO and VIDEO IN jacks of the VCR. Recording from the line input is convenient if you have a satellite receiver or similar component attached to these jacks. To timer record from the component connected to the VCR's line input:

Press INPUT to enter VIDEO 1 (back jacks) or VIDEO 2 (front jacks) instead of the channel number on the TV screen during timer programming.

```
PROGRAM 1 - ONE TIME
Channel      VIDEO1
Start Time  *---:--
End Time    *---:--
Start Date  --/--/--
Tape Speed  SLP

Press CLEAR to correct
Press MENU to exit
```

Using Two VCRs for Copying and Editing Tapes

Operating Instructions (Refer to hookup on page 6.)

Use one VCR as the playback VCR and the other as the recording VCR. If you have two compatible VCR's, use the AutoEdit™ feature *described below*.

Caution: The unauthorized recording of television programs and other materials may infringe the rights of others.

1. Turn on the TV and VCRs.
2. Tune TV to the VCR viewing channel, either 3, 4, or TV's video input.
3. If you have connected your VCR using Option A (page 6), tune recording VCR to channel 3 or 4 — the one selected on the back of the playback VCR.
If you have connected your VCR using Option B (page 6), press INPUT on recording VCR's remote to select the line input. L1 (for back jacks) or L2 (for front jacks) appears in VCR's display panel.
4. Insert the tape you want to copy into playback VCR. Insert a blank tape with safety tab in place into recording VCR.
5. Press PLAY, then PAUSE on playback VCR when you reach the point on the tape or program where you want to begin copying. If the tape was not recorded on the playback VCR, streaks may appear and you may need to adjust tracking.
6. Press REC•XPR, then PAUSE, on recording VCR.
7. Press PAUSE buttons on both VCRs at the same time to begin copying the tape.*
8. Edit out segments that you do not want to copy by pressing PAUSE on recording VCR to stop copying the tape. Then, locate the next segment you want to copy on playback VCR by using F.FWD, REW, and PLAY. Press PAUSE on the playback VCR. Press PAUSE at the same time on both VCRs to resume copying.
9. Press STOP on both VCRs when you are finished.

* You may turn off the TV after the recording has started as it does not have to be on to copy a tape.

Using Dual Remote with AutoEdit™

Use this VCR as the recording VCR and set it to respond to VCR2•LD on the remote as described on page 14. Use your other compatible VCR as the playback VCR, which should respond to VCR1.

1. Follow steps 1 – 4 in the "Operating Instructions" above.
2. Press VCR2•LD on remote to control recording VCR. Press REC•XPR, then PAUSE, to put recording VCR in pause mode.
3. Press VCR1 on remote to control playback VCR.
4. Use FF, REW, and PLAY to locate the point where you want to begin copying. Press PAUSE while VCR is playing to put playback VCR in pause mode.
5. Press EDIT on remote; the VCRs will begin copying.
6. Press EDIT again when you want to stop the tape from copying.
7. Repeat steps 4 – 6 as needed.
8. Press VCR1, STOP, then VCR2•LD, STOP, when you are finished.

Location of Controls

Front Panel

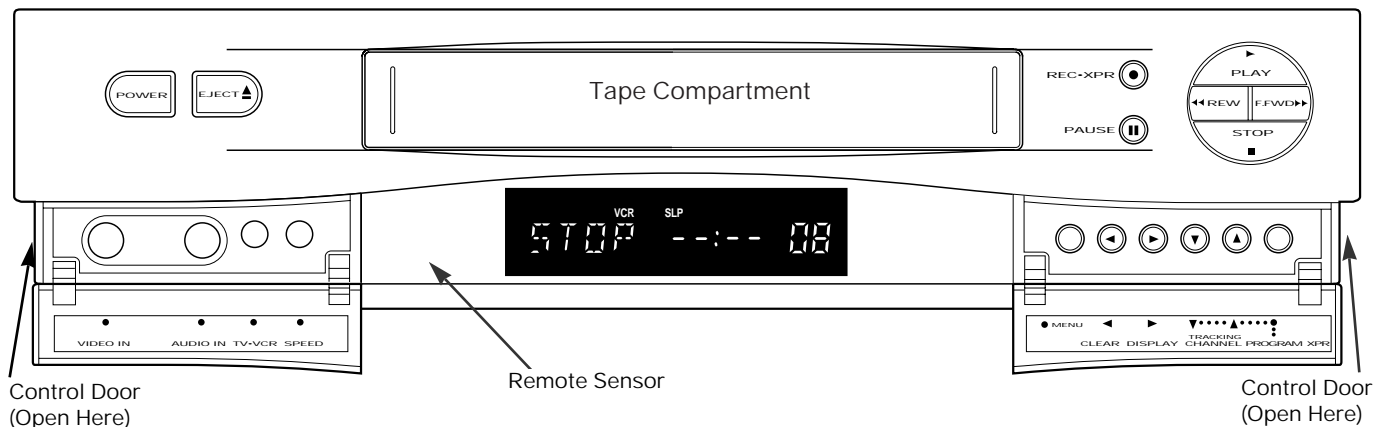

Arrow Buttons

Moves through the menu system when VCR MAIN MENU is on the TV screen.

Used for a timer recording with the TV off.

AUDIO IN Jack (L2)

Receives audio signals from another component, like a VCR or camcorder when it is connected to this jack.

CHANNEL • TRACKING Up or Down

Selects next higher or lower channel in the VCR's channel memory.

Adjusts tracking when a tape is playing.

CLEAR

Resets time counter to 0:00:00.

Allows you to change entries for selected menu features.

DISPLAY

Displays VCR status displays on the TV screen or time counter.

Edits VCR Plus+ or timer recordings.

EJECT

Ejects the tape when the VCR is stopped.

F.FWD (Fast Forward)

Fast forwards the tape when the VCR is stopped. Searches the picture forward during playback.

MENU

Displays the VCR MAIN MENU on the TV screen. Selects features in the menu.

PAUSE

Pauses action for viewing during playback.

Pauses recording to prevent recording of unwanted scenes.

PLAY

Plays a tape.

PROGRAM XPR

Used to set a timer recording with the TV off.

POWER

Turns the VCR on or off.

REC•XPR

Starts VCR recording.

Used for express recording (XPR).

Remote Sensor

Receives signals from the remote control. Aim the remote at this sensor with no objects between them.

REW (Rewind)

Rewinds the tape when the VCR is stopped.

Searches the picture in reverse during playback.

SPEED

Selects a recording speed (SP, LP, SLP).

STOP

Stops the normal functions such as record, playback, rewind, fast-forward, or pause.

TV•VCR

Switches the picture signal so that it either comes from the VCR or the TV channel. See page 10.

VIDEO IN Jack (L2)

Receives video signals from another component, like a VCR or camcorder, when it is connected to this jack.

Display Panel

This VCR has a feature where you can change the brightness level of the fluorescent display panel.

1. Press MENU•PROG on the remote to see the VCR MAIN MENU on the TV screen.
2. Press 5 to display the SETUP OPTIONS menu.
3. Press 3 to display the CUSTOM SETUP menu.
4. Press 5 repeatedly to switch among AUTO, BRITE and DIM.
 - Select AUTO to keep the display panel bright when VCR is on and dim when it is off.
 - Select BRITE to keep the display panel bright.
 - Select DIM to keep the display panel dim.

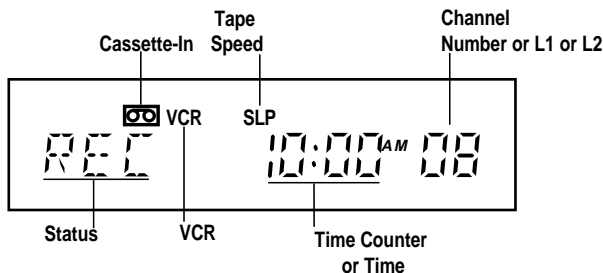
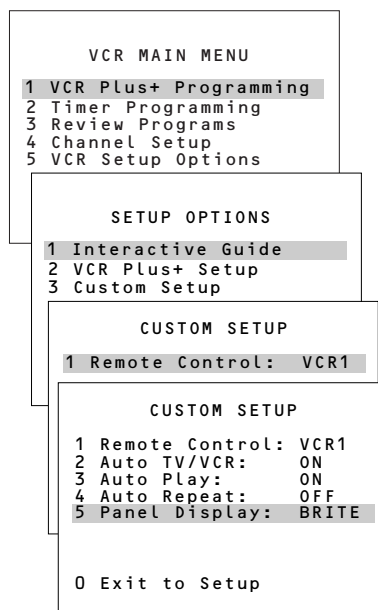

Cassette-in Indicator ()

Lights when a tape is in the VCR.

Channel Number or L1 or L2

The channel number or line input (L1 or L2) is displayed.

Status Indicators

Show what the VCR is doing.

EJECT	Ejecting Tape
FFWD	Fast forward
HELLO	Turned on or unlocked
LOCK	Pro-Tect Plus turned on
REC P	Record pause
PLAY	Playback
REC	Record
REW	Rewind
SRCH +	Forward search
SRCH -	Reverse search
SLOW +	Slow motion

STILL

STILL

STOP

TAPE flashes

TIMER

X--REC

Frame advance

Play pause

VCR stopped

Set for timer – no tape

Timer recording set

Express recording in progress

Tape Speed Indicators (SP, LP, or SLP)

Press SPEED to change.

Time or Time Counter

Press DISPLAY to switch between the current time and elapsed-time counter.

VCR Indicator (Applies Only to Basic Hookups)

Press TV•VCR to turn on or off.

VCR indicator on: Picture from VCR.

VCR indicator off: Picture from TV channel.

Location of Controls

Back Panel

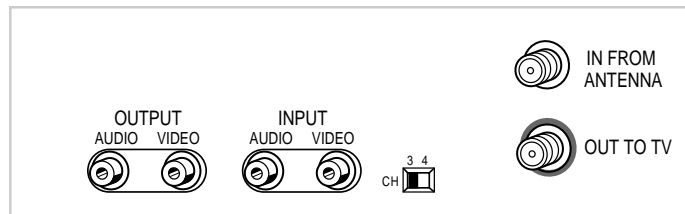

CH3 CH4 **Switch**

Selects the channel to which you will tune the TV to see the VCR picture if you connect the VCR using one of the basic hookups.

IN FROM ANTENNA **Connector**

Receives a signal from an antenna or cable system when attached.

OUT TO TV **Connector**

Passes signal to TV using the cable supplied.

VIDEO **and** AUDIO INPUT **Jacks (L1)**

Receives signals from another component, like a VCR or camcorder, when it is connected to these jacks. Use INPUT to select L1 for these jacks.

VIDEO **and** AUDIO OUTPUT **Jacks**

Sends signals from VCR to another component, like a VCR or camcorder, when it is connected to these jacks.

Trouble Checks

Sometimes problems can be easily solved by checking a few basic things. Check below before you call for help or take your VCR to an Authorized RCA VCR Servicenter.

Trouble	Here's what to try:
No power	<ul style="list-style-type: none"> • Plug VCR into an operating outlet. • Check connections.
VCR does not respond to remote	<ul style="list-style-type: none"> • Press VCR1 (VCR2•LD) to set remote to control the VCR. <i>See page 14.</i> • Aim remote at VCR with no objects between them. • Change batteries.
Remote no longer controls an RCA TV	<ul style="list-style-type: none"> • Press TV to set remote to control a compatible TV. <i>See page 15.</i> • Reprogram remote for RCA TV. <i>See page 15.</i>
Remote no longer controls a compatible TV, cable box, satellite receiver or auxiliary component	<ul style="list-style-type: none"> • Press TV, AUX, or CABLE to set remote to control the corresponding component. <i>See pages 15-17.</i> • Aim remote at component with no objects between them. • Reprogram remote after batteries have been changed. <i>See pages 15-17.</i> • Change batteries.
VCR only responds to VCR2•LD button on remote	<ul style="list-style-type: none"> • Check setting of Remote Control: VCR1/VCR2 feature. <i>See page 14.</i>
Poor or no picture for normal TV viewing	<ul style="list-style-type: none"> • Press TV•VCR to turn VCR indicator off. • Switch TV to an active channel. • Check antenna connections.
Snowy or no picture during playback	<ul style="list-style-type: none"> • Press TV•VCR to turn VCR indicator on. • Check TV channel selected (3 or 4) to make sure it matches the channel selected with CH3 CH4 switch on back of VCR. • Check TV's fine tuning. • Check video cable connections between VCR and TV monitor. • Set TV monitor to video input channel. • Try another tape. • Some snow/streaks are normal during search, stop action, frame advance, and slow-motion playback.
Streaks in picture during normal playback	<ul style="list-style-type: none"> • Press one of the TRACKING buttons on the remote or CHANNEL•TRACKING on the VCR to move streaks up or down for the best picture. • Check tape — it may be worn out or of poor quality.
Time counter not working or time counter not working in search modes.	<ul style="list-style-type: none"> • The time counter does not advance during unrecorded portions of tape. When an unrecorded segment of tape is encountered, the time counter will hold its count until recorded material is detected again. • A minus (-) will appear in front of the time if you rewind the tape farther back than a counter reading of 0:00:00.
Will not record or play	<ul style="list-style-type: none"> • No cassette in VCR. • Eject and reinsert cassette. • Broken tape — try another cassette. • VCR is in pause mode. Press PAUSE.
Will not record	<ul style="list-style-type: none"> • Safety tab removed from cassette. • Make sure the line indicator (L1 or L2) is turned off in VCR's display panel for normal recording from the VCR's tuner. Press INPUT to turn off the line indicators.

Trouble Checks

Trouble	Here's what to try:
Rewind does not operate	<ul style="list-style-type: none"> • Tape already rewound.
VCR plus+ or timer recording not made or wrong program recorded	<ul style="list-style-type: none"> • Wrong VCR plus+ code entered. • Cable box or satellite receiver not turned on when recording was to begin. • Program entered incorrectly (wrong channel or times). • Power interruption. Clock area in display panel will show --:--. • Check to see if time and date are correct — including AM/PM. • Program exceeded tape's length or tape was not rewound beforehand. • VCR was not turned off at the time recording was to start. • No tape in VCR or cassette's safety tab broken off. • VCR ejects cassette when the end of the tape is reached during a timer recording. • Cable box or satellite receiver setup not completed. <i>See page 28.</i> • VCR Plus+ setup not completed correctly. <i>See page 29.</i>
Clock shows incorrect time or date	<ul style="list-style-type: none"> • Power interruption. Clock on the front panel will show --:--. • Clock was not set accurately (check AM/PM and date). • Time counter display appears in VCR's display panel. Press DISPLAY on remote.
VCR makes noise when stopped	<ul style="list-style-type: none"> • VCR is removing tape from heads. This is normal. The head cylinder inside the VCR will continue to rotate for a few minutes after you put the VCR in the stop mode.
Will not Auto-Search active channels correctly	<ul style="list-style-type: none"> • Check antenna connections. • Check Tuning Mode: CABLE/ANTENNA feature. <i>See page 9.</i>
Cannot add or remove channels	<ul style="list-style-type: none"> • Channels must be placed in memory using Auto-Search Channels feature before channels can be added or removed from channel memory. <i>See page 9.</i>
Tape plays back in slow motion	<ul style="list-style-type: none"> • Press PLAY to return to normal playback.
Cannot select channels over 69	<ul style="list-style-type: none"> • Cable channels over 69 can only be selected if Tuning Mode: CABLE/ANTENNA feature is set to CABLE. <i>Details are on page 9.</i>
Cassette with safety tab removed does not start to play automatically	<ul style="list-style-type: none"> • Set Auto Play ON/OFF feature to ON. <i>Details are on page 19.</i>
No status displays appear on the TV screen when you change channels, etc.	<ul style="list-style-type: none"> • Display off mode is selected. Press DISPLAY. <i>See page 20.</i>
Tape or segment of tape is repeated	<ul style="list-style-type: none"> • Turn off the Repeat feature in the CUSTOM SETUP menu. <i>See page 24.</i>
Display panel is too dim or bright	<ul style="list-style-type: none"> • Reset the Panel Display feature. <i>See page 36.</i>
Control of cable box is intermittent.	<ul style="list-style-type: none"> • Reposition the cable box until a suitable angle is found. <i>See pages 4 and 5.</i>

Limited Warranty

What your warranty covers:

- Any defect in material or workmanship.

For how long after your purchase:

- Ninety days for labor charges.
- One year for parts.

The warranty period for rental units begins with the first rental.

What we will do:

- Pay any Authorized RCA VCR Servicenter the labor charges to repair your VCR.
- Pay any Authorized RCA VCR Servicenter for the new or, at our option, refurbished replacement parts required to repair your VCR.

How you get service:

- Take your VCR to any Authorized RCA VCR Servicenter. To identify your nearest Authorized RCA VCR Servicenter, ask your dealer, look in the Yellow Pages, or call 1-800-336-1900.
- Show the service technician your evidence of purchase date.
- Pick up your VCR when repairs are completed.

What your warranty does not cover:

- Customer instruction. (Your Owner's Manual clearly describes how to install, adjust, and operate your VCR. Any additional information should be obtained from your Dealer.)
- Installation and related adjustments.
- Signal reception problems not caused by your VCR.
- Damage from misuse or neglect.
- Cleaning of video/audio heads.
- Remote control batteries.
- A VCR that has been modified or incorporated into other products or is used for institutional or other commercial purposes.
- A VCR purchased or serviced outside the USA.

Product registration:

- Please complete and mail the Product Registration Card packed with your VCR. It will make it easier to contact you should it ever be necessary. The return of the card is not required for warranty coverage.

How state law relates to this warranty:

- This warranty gives you specific legal rights, and you also may have other rights that vary from state to state.

If you purchased your VCR outside the United States:

- See your dealer for details.

Specifications

Format:	VHS
Record/Playback System:	Video: 4-Head Audio: 2 Head record/playback system
Video Signal System:	EIA standard: NTSC color
Antenna:	75-ohm external VHF/UHF combined antenna terminal
Tuner:	USA: 181 channels capability* (125 cable channels) Canada: 178 channels capability* (122 cable channels)
Type:	AutoProgramming frequency synthesis
Power Requirement:	120V AC, 60 Hz
Power Consumption:	23 watts
Dimensions:	3.5 inches high (89.5 mm) 15.43 inches wide (392 mm) 12.1 inches deep (307.5 mm)
Weight:	9.46 pounds (4.3 kg)
Storage Temperature Range:	- 22°F to +149°F
Operating Temperature Range:	+41°F to +104°F

*Check your cable company's compatibility requirements.

Cleaning the VCR

Use a soft cloth or dusting attachment of your vacuum cleaner to dust your VCR. Remove dust from the ventilation holes on the top, back, sides, and bottom of the cabinet.

Plastic surfaces are easily scratched and can be marred by alcohol and various solvents. Avoid excessive use of oil-based furniture polishes since the materials used in the cabinet will accumulate more dust. We recommend using a non-abrasive, anti-static cleaner and polisher.

Index

- A**
- Accessories, Included7
 - Add or Remove Channels from Memory9
 - ADD/REMOVE CHANNEL Menu9
 - Antenna Connections2,3
 - Arrow Buttons8,12,13,35
 - Audio Components, Controlling
 - With Remote17
 - AUDIO/VIDEO IN Jacks6,33,35,37
 - AUDIO/VIDEO OUT Jacks3-6,37
 - Auto Play Feature18,19
 - Auto Repeat Feature24
 - Auto TV/VCR Feature10,18
 - Auto-Search Channels Feature9
 - AutoEdit™ Feature34
 - Automatic Tracking20
 - AUX (Auxiliary) Button12,17
- B**
- Back Panel37
 - Batteries, Inserting in Remote7
 - Buttons
 - Cable Box13
 - Components12
 - RCA DSS Satellite Receiver13
 - TV13
 - VCR12,13
- C**
- CABLE Button12,13,16
 - Cable Box Function Buttons13
 - Cable Box, Programming Remote16
 - Cable System With Cable Box2,4,5,28
 - Cable System Without Cable Box2,3
 - Cable Box Setup Menu28
 - Card, Registrationi
 - CH3 CH4 Switch3-6,7,18, 25,37
 - CHAN (Channel) Up or Down9,12,13
 - CHANNEL SETUP Menu9,28
 - CHANNEL•TRACKING18-20,35
 - Checks, Trouble38,39
 - Choosing a Hookup2
 - Cleaning the VCR41
 - CLEAR Button11-13,22,28-32,35
 - Clearing VCR Plus+ and
Timer Recordings32
 - Clock, Setting11
 - Code Lists
 - Auxiliary Equipment17
 - Cable Box16
 - TV15
 - Commercial Scan23
 - Connections
 - Antenna2-3
 - Audio/Video Jacks2,3-6
 - Cable-TV2,3-5
 - Two VCRs6
 - Contents1
 - Controlling
 - Cable Box16
 - RCA Audio Components17
 - RCA Satellite Receiver17
 - TV15
 - VCR14
 - Controlling a TV15
 - Copying and Editing Tapes34
 - Copying Tape, Connections6
 - Custom Menu10,14,19,24,36
- D**
- Date and Time, Setting11
 - Design Specifications41
 - DISPLAY Button12-13,20,32
 - Display Panel35,36
 - Displays, Status20
 - Dual Remote with AutoEdit™34
- E**
- EDIT Button12,34
 - Editing VCR Plus+ and
Timer Recordings32
 - Editing and Copying Tapes34
 - EJECT Button18,35
 - Express Recording27
 - Express Recording, Stopping27
- F**
- F.ADV (Frame
Advance) Button12,20

Index

- F.FWD (Fast Forward)
 Button19,21-23,34,36
 FF (Fast Forward)Button12,19,21,22,23,34
 Frame Advance12,20
 Front Panel.....35
- G**
- Go-To Search Feature22
 Guide, Interactive7
- H**
- Hookups
 Antenna.....2-3
 Audio/Video Jacks.....2,3-6
 Cable-TV2,3-5
 Two VCRs6
- I**
- IN FROM ANTENNA Connector3-6,37
 Index Search.....21
 Indicators36
 INPUT Button.....12,33,34
 Interactive Guide7
- L**
- L1 or L2 (Line) Indicators.....35-37
 Limited Warranty40
 Line Input, Timer Recording From.....33
 Location of Controls
 Remote Control12-13
 VCR Back Panel37
 VCR Display Panel.....36
 VCR Front Panel.....35
 Locking Feature.....23
 LP Speed.....26
- M**
- Manual Tracking.....20
 MENU Button.....8,35
 MENU PROG Button8-11,12,14,19,24,28-32
 Menu System8
 MUTE Button12,13
- N**
- Number Buttons9,12-13
- O**
- On-Screen Displays20
 Operating Instructions
 Copying Tapes34
 Express Recording.....27
 Playing a Tape.....18
 Recording a Program25
 Timer Recording.....31-33
 VCR Plus+ Recording.....29-30
 OUT TO TV Connector3-6,37
- P**
- PAUSE Button.....12,13,19-20,26,35
 Pause for Stop Action.....19
 Pause, Recording.....26
 Picture Search19
 PLAY Button12,13,18-20,35,36
 Playing a Tape.....18-24
 Point and Select.....8
 POWER Button12,13,15-18,27,30,32,35
 PREV CH (Previous Channel) Button12,13
 Problems, Solving38,39
 Product Registrationi
 PROGRAM XPR Button32,35
 Programming Remote
 Cable Box16
 RCA Audio Components.....17
 RCA DSS Satellite Receiver16
 TV15
 VCR.....14
 PROGRAMS OVERLAP30,31
 ProTect™ Plus Feature.....23
- R**
- RCA Digital Satellite System.....16
 REC Indicator25,36
 Recording
 Basic.....25
 Express (XPR).....27
 From Another VCR34

Index

One Program While Watching Another	25
Pause	26
Speeds	26
Timer	31-33
Types Of	25
VCR Plus+	29,30
REC Button	12,13,25,27,34
REC•XPR Button	25,27,34,35
Registration Card	i
Remote Control	12-17
Remote Control VCR1/VCR2 Feature	14
Remote Sensor	35
REW (Rewind) Button	12,13,19-23,34,35

S

Safety Precautions	i
Safety Tab	18
Satellite Box Setup	28
Satellite (CABLE) Button	13,16
Satellite System	13,16
Scan, Commercial	23
Search Features	
Blank	23
Commercial Scan	23
Go-To	22
Index	21
Picture	19
Time	22
SEARCH Button	12,13,21-23
Search, Picture	19
Select a Cable Box Viewing Channel	28
Sensor, Remote	35
SET VCR CLOCK Menu	11
Setting Up the VCR	7-11
SLOW + and - Buttons	12-13,19
Slow Motion	19
SLP Speed	26
Solving Problems	38,39
SP Speed	26
Specifications	41
SPEED Button	12-13,25-27,30,31,35
Speeds, Recording	26
Startup	7-11
Status Displays On-Screen	20
Status Indicators	36
STOP Button	12-13,18,21-24,25,27,30,32,35
Stop Action Pause	19

Stopping	
Express Recording	27
Timer Recording	32
VCR Plus+ Recording	30

T

Table of Contents	1
Tape, Playing	18
Time and Date, Setting	11
Time Counter	21,22,36
Time Display	11,36
Time Search	22
TIMER Indicator	31,36
Timer Recordings	31-33
TRACKING Buttons	12,13,18-20
Tracking, Automatic and Manual	20
Trouble Checks	38,39
Tuning Mode: CABLE/ANTENNA Feature	9
Turn On VCR	7
TV Button	12-13,15
TV Function Buttons	13
TVs, Compatible Chart	15
TV•VCR Button	3-6,9-13,18,25,35,36
Types of Recordings	25

V

VCR Controls	35-37
VCR Function Buttons	12-13
VCR Indicator	8,10,11,18,25,36
VCR PLUS+ CHANNEL LIST	29
VCR Plus+ Recording	29,30
VCR, Cleaning	41
VCR, Turn On	7
VCR1 Button	7-11,12,14,25,30,32,34
VCR2•LD Button	12,14,25,30,32,34
VCRs Memory, Placing Channels	9
VCRs, Connecting for Tape Copying	6
VOLUME Up or Down Button	12-13

W

Warranty, Limited	41
-------------------	----

X

XPR Recording	27
---------------	----



For your nearest Home
Entertainment Dealer
or Authorized Servicenter
call toll-free in the U.S.A.

1-800-336-1900

Canadian Consumers –
Your toll free numbers are:

English: 1-800-522-0338

French: 1-800-522-0445

If you would like a copy of this manual in French, please follow the
instructions below:

Si un livret d'instructions en français n'est pas inclus avec votre
appareil, vous pouvez en obtenir un (indiquer le numéro de modèle,
votre nom, et votre adresse) en vous adressant à:

Thomson Consumer Electronics
Attention: Canadian Operations
P.O. Box 0944
Indianapolis, IN 46206-0944

If your VCR needs service, please contact your dealer or the nearest
Servicenter from the yellow pages. Please do not send any products
to the Indianapolis address listed in this manual or on the carton.
This will only add delays in service for your product.

Thomson Consumer Electronics
600 N Sherman Dr, PO Box 1976
Indianapolis, IN 46206

©1994 Thomson Consumer Electronics, Inc.
Trademark(s)® Registered
Marca(s) Registrada(s)
Printed in Singapore
Part Number 94-VR539-1



Free Manuals Download Website

<http://myh66.com>

<http://usermanuals.us>

<http://www.somanuals.com>

<http://www.4manuals.cc>

<http://www.manual-lib.com>

<http://www.404manual.com>

<http://www.luxmanual.com>

<http://aubethermostatmanual.com>

Golf course search by state

<http://golfingnear.com>

Email search by domain

<http://emailbydomain.com>

Auto manuals search

<http://auto.somanuals.com>

TV manuals search

<http://tv.somanuals.com>