

VR602HF

USER'S GUIDE

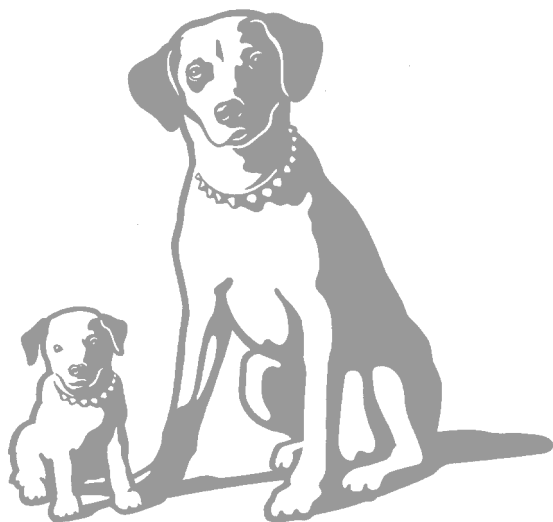

VIDEO CASSETTE **RECORDER**

TRUST

Important Information

WARNING

To reduce the risk of fire or shock hazard, do not expose this VCR to rain or moisture.

WARNING

RISK OF ELECTRIC SHOCK
DO NOT OPEN

TO REDUCE THE RISK OF ELECTRIC SHOCK, DO NOT REMOVE COVER (OR BACK). NO USER SERVICEABLE PARTS INSIDE. REFER SERVICING TO QUALIFIED SERVICE PERSONNEL.

 This symbol indicates "dangerous voltage" inside the product that presents a risk of electric shock or personal injury.

 This symbol indicates important instructions accompanying the product.

Cautions

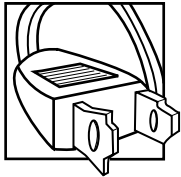

Caution: To prevent electric shock, match wide blade of plug to wide slot, fully insert.

Attention: Pour éviter les chocs électriques, introduire la lame la plus large de la fiche dans la borne correspondante de la prise et pousser jusqu'au fond.

Do not defeat the safety feature of the plug. The wide blade fits into the wall socket only one way. If you need an extension cord, make sure it matches the plug of the VCR.

For U.S.A. — Operate VCR only on 120 volts, 60Hz AC power (normal house power).

FCC Regulations state that unauthorized changes or modifications to this equipment may void the user's authority to operate it.

This reminder is provided to call your attention to Article 820-40 of the National Electrical Code (Section 54 of the Canadian Electrical Code, Part 1) which provides guidelines for proper grounding and, in particular, specifies that the cable ground shall be connected to the grounding system of the building as close to the point of cable entry as practical.

Product Registration

Please fill out the product registration card and return it immediately. Returning this card allows us to contact you if needed.

Keep your sales receipt to obtain warranty parts and service and for proof of purchase. Attach it here and record the serial and model numbers in case you need them. The numbers are located on the back of the VCR.

Model No. VR602HF

Serial No. _____

Purchase Date: _____

Dealer/Address/Phone: _____

Table of Contents

Important Information

Warnings	i
Cautions	i
Note to Cable TV Installer	i
Product Registration	i

Hooking Up the VCR

Choosing a Hookup	2
Antenna or Cable System Without a Cable Box	3
Cable System With Cable Box to Unscramble All Channels	4
Cable System With Cable Box to Unscramble Only Pay Channels	5
Connecting Two VCRs for Copying Tapes	6
Connecting a Stereo Amplifier/Receiver	7

Setting Up the VCR

Startup	
Check Accessories With VCR	8
Insert Batteries in Remote	8
Turn on TV and VCR	8
Place Channels in VCR's Memory	9
Add or Remove Channels from VCR's Memory	9
Use TV•VCR Button	10
Set the AUTO TV/VCR Feature	10
Set the Time and Date	11
Select the Language/ Sélectionner la langue	11

Using the Remote Control

VCR Function Buttons	12-13
----------------------	-------

Playing a Tape

Operating Instructions	14
Using the Playback Features	
Auto Play Feature	15
Picture Search	15
DISPLAY Button	16
Time Counter	16
Zero Search	17

Commercial Scan (SEARCH Button)	17
Slow Motion	17
Pause for Stop-Action	18
Frame Advance	18
Automatic Tracking	18
Manual Tracking	18
PLAYBACK: HI-FI/MIX/LINEAR Feature	19

Recording a Program

Types of Recordings	20
Recording Speeds	20
Recording Pause	20
Basic Recording - Operating Instructions	20
Watch a TV Channel While VCR is Recording a Different Channel	20
Express Recording	21
Recording Stereo Broadcast TV or SAP	22
Recording Audio Only	23
Recording While You're Away Setting a Timer Recording	24
Stopping a Timer Recording	24
Select Cable Box Viewing Channel	25
Timer Recording From the VCR's Line Input	25
Checking or Clearing Timer Recordings	25
Using Two VCRs for Copying and Editing Tapes	26
Copying and Editing Tapes Using Compatible Remote	26

References

Specifications	27
Cleaning the VCR	27
Location of Controls	
Front Panel	28
Back Panel	29
Display Panel	29
Trouble Checks	30-31
Limited Warranty	32
Index	33

Choosing a Hookup

The hookups on pages 3 through 5 are divided into two hookup types: Basic (A) and Advanced (B).

The basic hookup shows the backs of TVs that have only an antenna/cable connection. It is the easier of the two and additional accessories may not be needed.

The advanced hookup shows the VCR hooked up to a monitor/receiver (TV with audio and video jacks). This connection may improve the picture quality as well as convenience of operation.

Answer the questions to choose the hookup for your VCR.

1. How do you receive your TV signals?

Choose one answer from below.

- A. Outside antenna – Turn to page 3.
- B. Rabbit ears (set-top) and/or bow tie antenna – Turn to page 3.
- C. Cable System – Go to question 2.

2. What type of Cable-TV system* do you have?

Choose one answer from below.

- A. Cable without a box – Turn to page 3.
- B. Cable box to unscramble all the channels – Turn to page 4.
- C. Cable box to unscramble only pay channels, such as HBO, Showtime, Cinemax, etc. – Turn to page 5.

*You may need to contact your local cable company for assistance.

Optional Hookups

How to hook up two VCRs for copying tapes.

- A. Select a hookup by answering questions 1 and 2 above.
- B. Then, modify the connections as shown on page 6.

How to hook up a stereo amplifier/receiver.

- A. Select a hookup by answering questions 1 and 2 above.
- B. Then, modify the connections as shown on page 7.

Antenna or Cable System Without a Cable Box

A. Basic hookup.

Use this hookup for a simple connection which requires fewer accessories.

1. **Set the 3CH.4 switch on back of VCR to either channel 3 or 4.**

Tune the TV to this channel and use the TV•VCR button to watch the VCR.

2. **Connect as shown.**

This connection may require additional accessories not provided.

3. **Plug in power cords of VCR and TV.**

4. **Continue to page 8.**

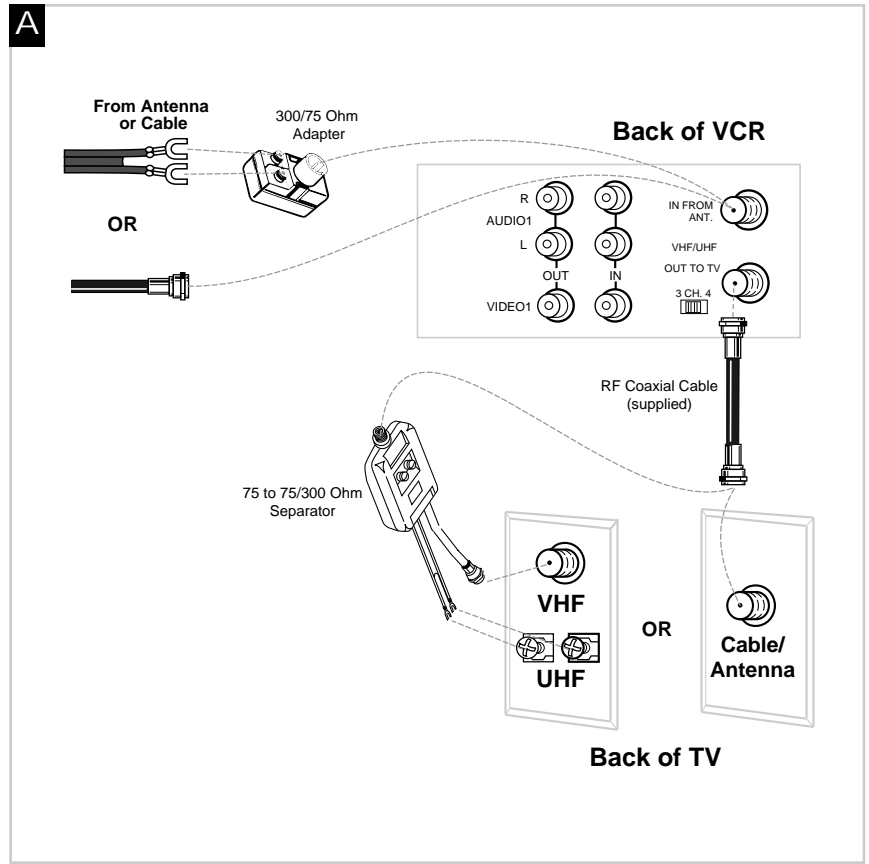

B. Advanced hookup.

Use this hookup for slightly improved picture quality, Hi-Fi Stereo playback, and more convenient operation — use of the TV•VCR button is not required.

1. **Connect as shown.**

This connection requires additional accessories not provided.

If your TV is not stereo, a Y-adapter may be required to hear sound from both channels.

2. **Plug in power cords of VCR and TV.**

3. **Continue to page 8.**

Tune the TV to its video input to watch the VCR. Set the Auto TV/VCR feature to OFF. See page 10 for details.

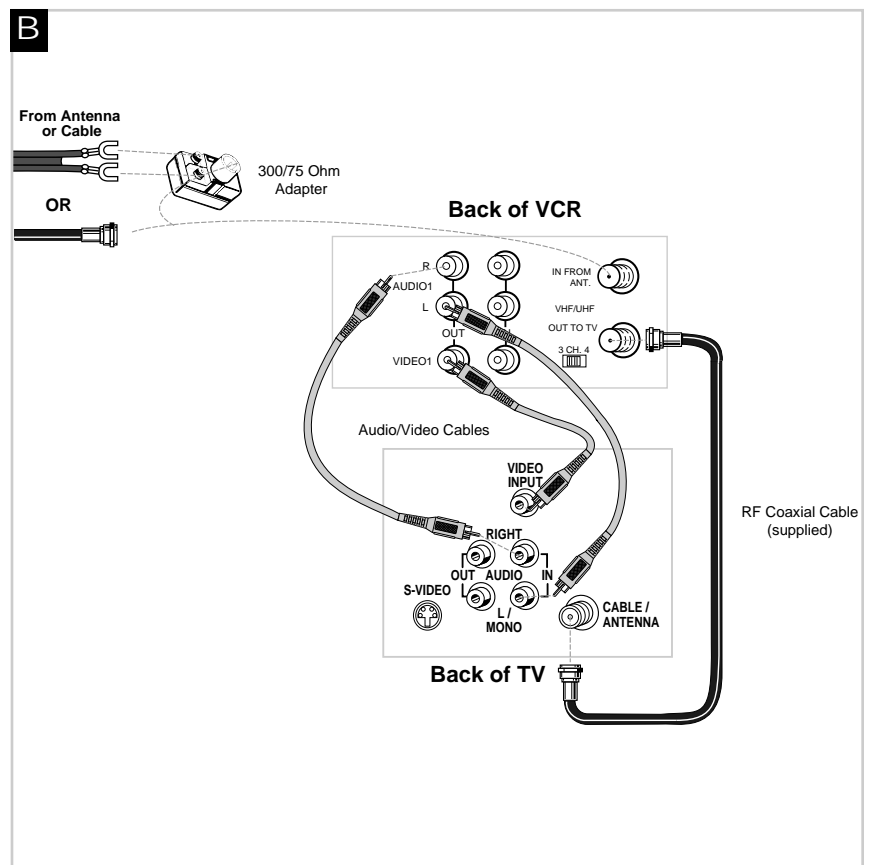

Cable System With Cable Box to Unscramble All Channels

A. Basic hookup.

Use this hookup for a simple connection which requires fewer accessories.

1. **Set the 3CH.4 switch on back of VCR to either channel 3 or 4.**
Tune the TV to this channel and use the TV•VCR button to watch the VCR.
2. **Connect as shown.**
This connection may require additional accessories not provided.
3. **Plug in power cords of VCR, TV, and cable box.**
4. **Continue to page 8.**

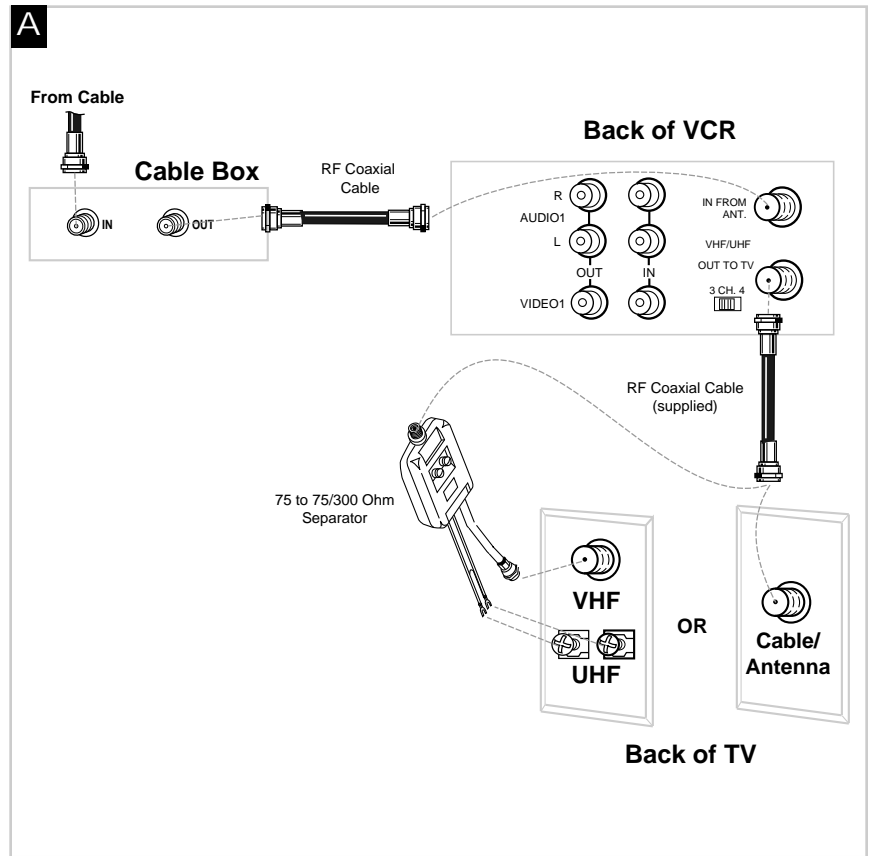

B. Advanced hookup.

Use this hookup for slightly improved picture quality, Hi-Fi Stereo playback, and more convenient operation — use of the TV•VCR button is not required.

1. **Connect as shown.**
This connection requires additional accessories not provided.
If your TV is not stereo, a Y-adaptor may be required to hear sound from both channels.
2. **Plug in power cords of VCR, TV, and cable box.**
3. **Continue to page 8.**
Tune the TV to its video input to watch the VCR. Set the Auto TV/VCR feature to OFF. See page 10 for details.

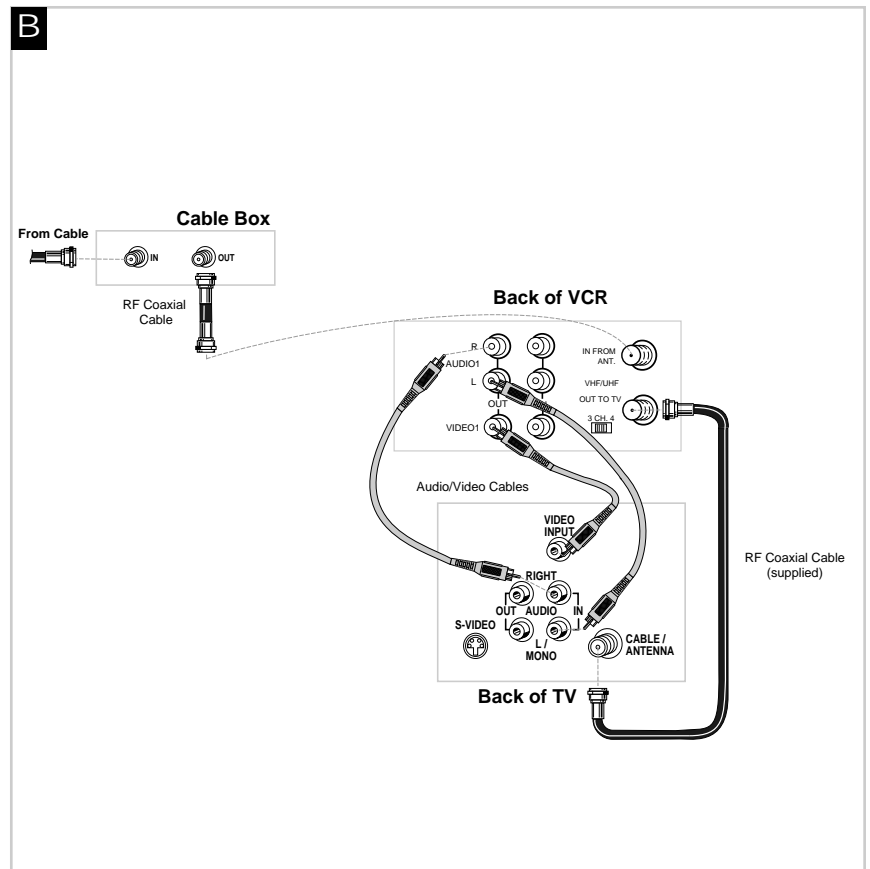

Cable System With Cable Box to Unscramble Only Pay Channels

(such as HBO, Showtime, Pay-Per-View, etc.)

A. Basic hookup.

Use this hookup for a simple connection which requires fewer accessories.

1. **Set the 3CH.4 switch on back of VCR to either channel 3 or 4.**

Tune the TV to this channel and use the TV•VCR button to watch the VCR.

2. **Connect as shown.**

This connection may require additional accessories not provided.

3. **Plug in power cords of VCR, TV, and cable box.**

4. **Continue to page 8.**

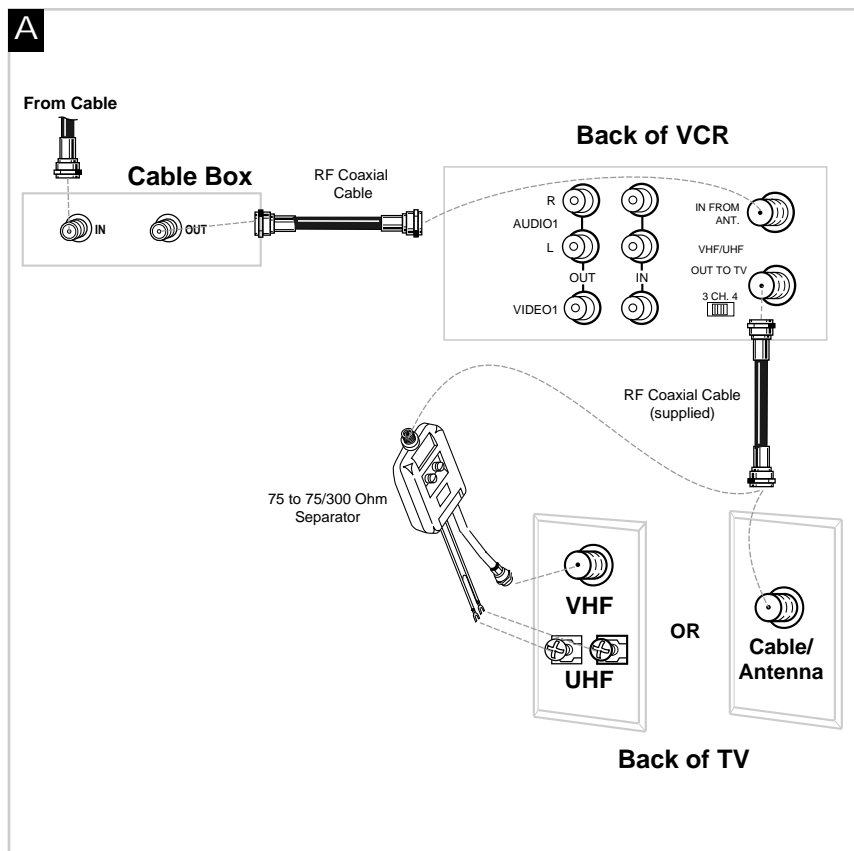

B. Advanced hookup.

Use this hookup for slightly improved picture quality, Hi-Fi Stereo playback, and more convenient operation — use of the TV•VCR button is not required.

1. **Connect as shown.**

This connection requires additional accessories not provided.

If your TV is not stereo, a Y-adaptor may be required to hear sound from both channels.

2. **Plug in power cords of VCR, TV, and cable box.**

3. **Continue to page 8.**

Tune the TV to its video input to watch the VCR. View all pay channels through the VCR.

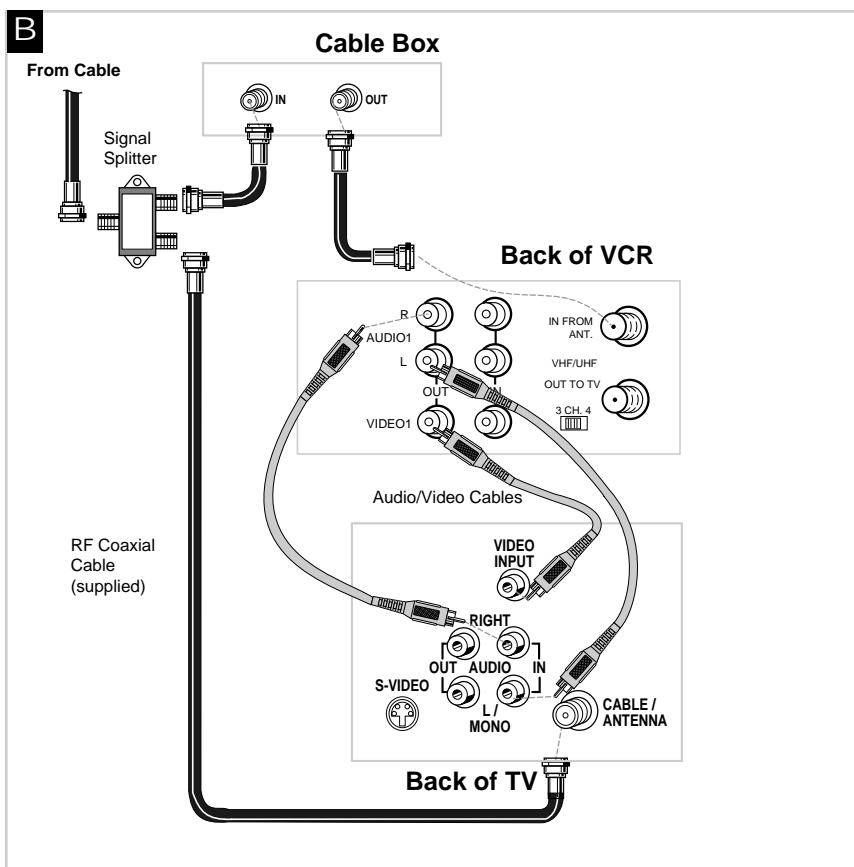

Connecting Two VCRs for Copying Tapes

Option A hookup.

Use this hookup for a simple connection which requires fewer accessories.

1. **Select a hookup from pages 2 through 5 and then modify with this connection.**
2. **Set the 3CH.4 switch on the playback VCR to either channel 3 or 4.**
Tune the recording VCR to this channel to receive the signal from the playback VCR.
3. **Connect as shown.**
This connection may require additional accessories not provided.
4. **Plug in power cords of VCRs and TV.**
5. **Continue to page 8.**

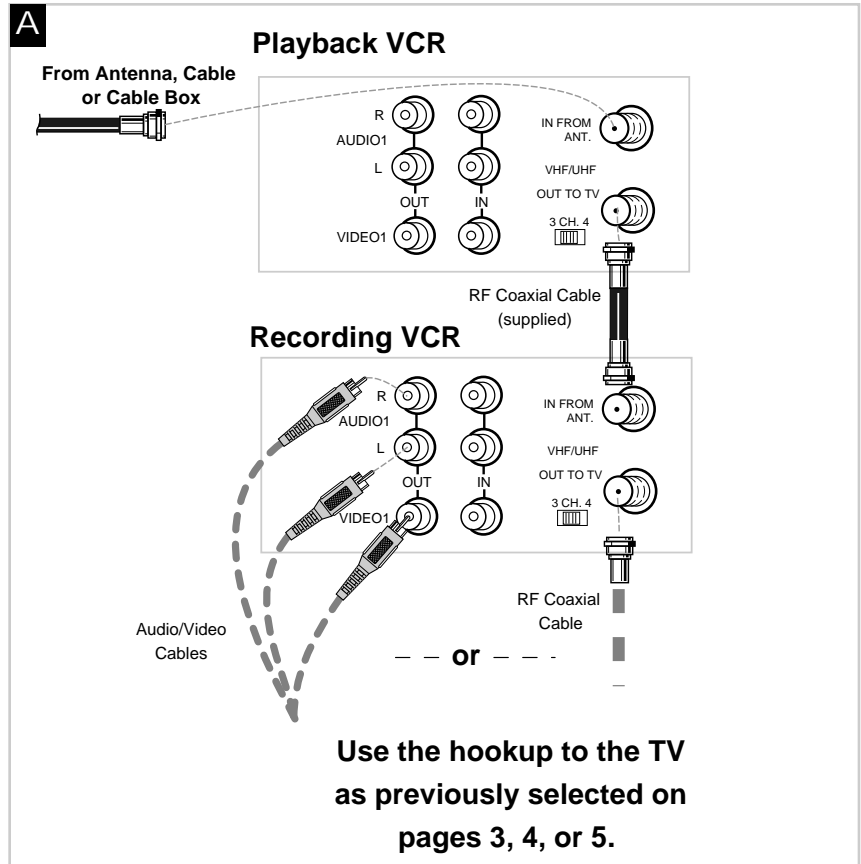

Option B hookup.

Use this hookup for slightly improved copy quality and more convenient operation — use of the TV•VCR button is not required.

1. **Select a hookup from pages 2 through 5 and then modify with this connection.**
2. **Connect as shown.**
This connection requires additional accessories not provided.
If your other VCR is not stereo, a Y-adaptor may be required to hear sound from both channels.
3. **Plug in power cords of VCRs and TV.**
4. **Continue to page 8.**

Select the line (audio/video) input on the recording VCR to receive the signal from the playback VCR.

Caution: The unauthorized recording of television programs and other materials may infringe the rights of others.

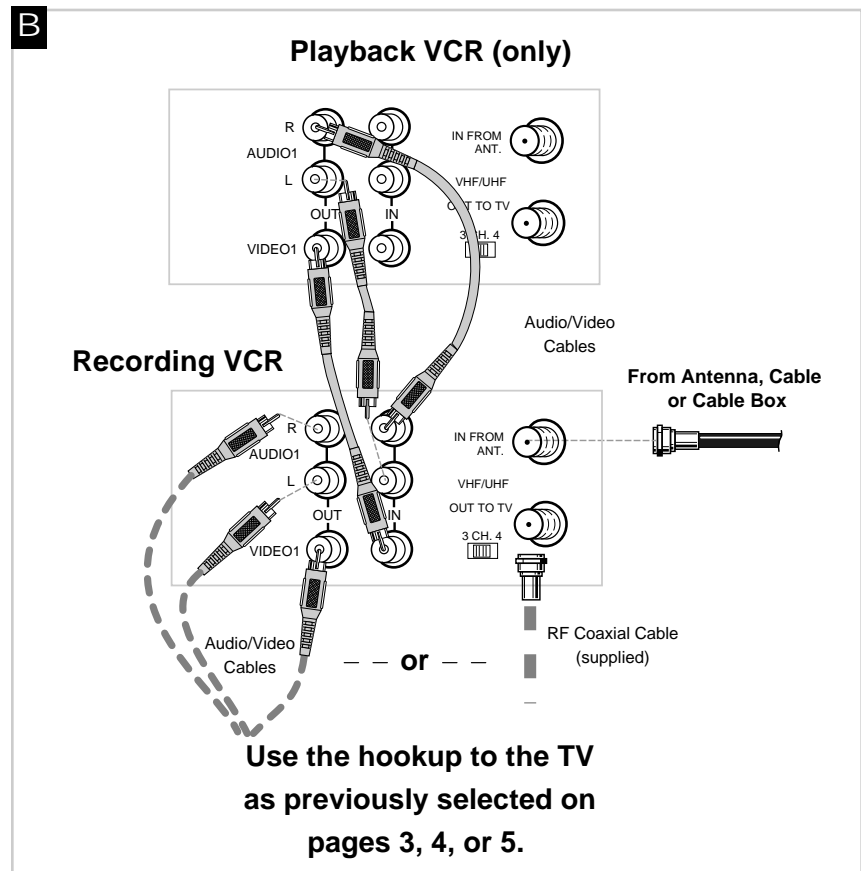

Connecting a Stereo Amplifier/Receiver

Record on the VCR from an amplifier/receiver.

Connect your VCR to a stereo amplifier/receiver to record stereo audio.

1. Select a hookup from pages 2 through 5 and then modify with this connection.

2. Connect as shown.

This connection requires additional accessories not provided.

3. Plug in power cords of amplifier/receiver, VCR, and TV.

4. See "Recording Audio Only" on page 23.

Select the line input on the VCR to receive the audio signal from the amplifier/receiver.

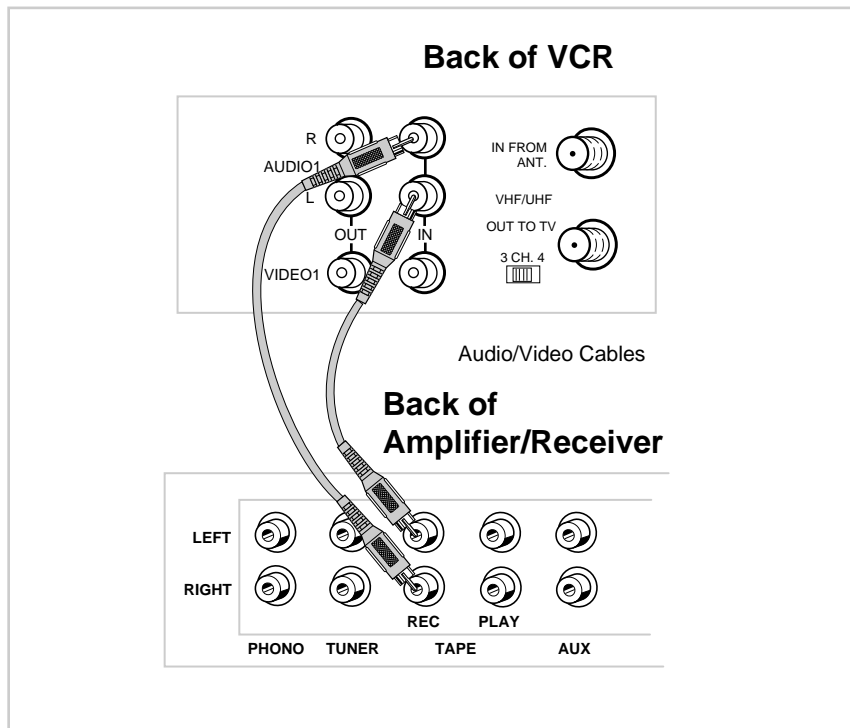

Play back stereo tapes or receive a stereo broadcast through an amplifier/receiver.

Connect your VCR to a stereo amplifier/receiver to receive stereo broadcasts or play back stereo tapes.

1. Select a hookup from pages 2 through 5 and then modify with this connection.

2. Connect as shown.

This connection requires additional accessories not provided.

3. Plug in power cords of amplifier/receiver, VCR, and TV.

4. See "Playback Operation" on page 14.

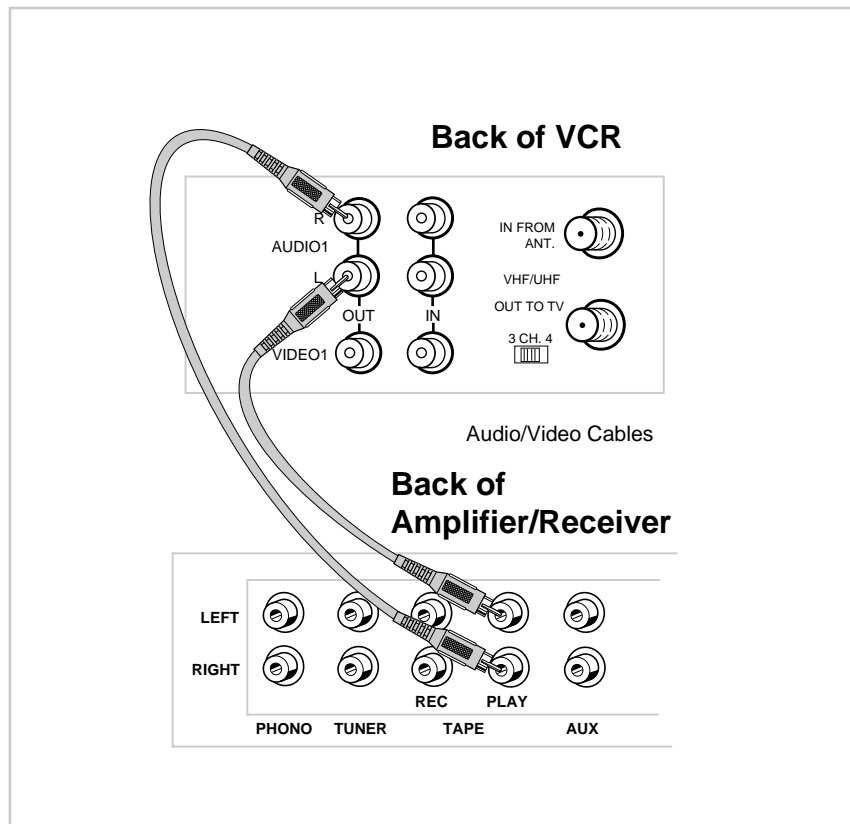

Startup

1. Check accessories with VCR.

Contact your dealer if any items are missing.

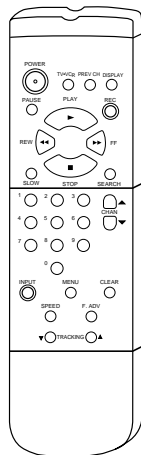

Remote
(Stock No. 221347)

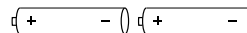

2 "AA" Batteries



RF Coaxial Cable
(Stock No. 221346)

2. Insert batteries in remote.

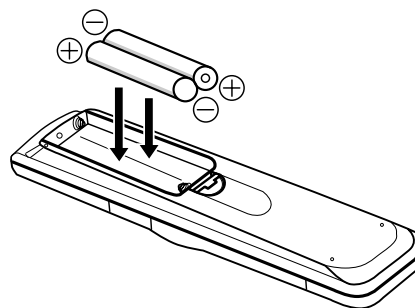
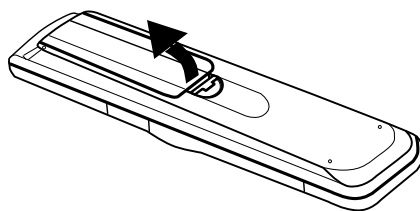

3. Turn on the TV.

- A. Turn on the TV.
- B. If you used one of the basic hookups, tune the TV to the channel selected with the 3CH.4 switch on back of VCR.
If you used one of the advanced hookups, tune the TV to the TV's video input.
(See TV owner's manual for details.)

4. Turn on the VCR.

- A. Press POWER on the remote. The POWER and VCR indicators in the VCR's display panel light. The TIMER indicator flashes until the time is set.

Startup

5. Place channels in the VCR's memory.

The first time you turn on the VCR or after a power interruption, the VCR displays a message on the TV screen prompting you to AUTO-SEARCH CHANNELS for the VCR. If the message does not appear, go to step A below. If the message appears, follow the directions on the screen.

Wait until the channel numbers stop changing. This takes about one to two minutes. The TV tunes to the lowest channel found. Then, pressing CHAN up or down selects only the active channels.

If you ever need to manually set up channels (Channel Setup) on the VCR because you change cable or antenna signals:

- A. Press MENU to display the VCR MAIN MENU on the TV screen. If this menu does not appear:
 - Make sure the TV is tuned to same channel as the 3CH.4 switch on the VCR or the TV's video input (refer to TV's manual).
 - If you use a basic hookup, check the VCR indicator in display panel — it should be on. Press TV•VCR to turn it on.
 - Check the connections.
- B. Press 3 to display the CHANNEL SETUP menu.
- C. Press 1 to begin AUTO-SEARCH CHANNELS.

The VCR automatically selects CABLE (cable TV) or ANTENNA. If you need to change the setting manually, press 3.

```

AUTO-SEARCH CHANNELS

CONNECT ANTENNA CABLE...
THEN PRESS CH UP
    
```

```

VCR MAIN MENU

1 TIMER PROGRAMMING
2 REVIEW PROGRAMS
3 CHANNEL SETUP
    
```

```

CHANNEL SETUP

1 AUTO-SEARCH CHANNELS
2 ADD/REMOVE CHANNELS
3 TUNING MODE: CABLE
4 CABLE BOX SETUP

0 EXIT TO MAIN MENU
    
```

6. Add or remove channels from the VCR's memory.

You may want to add or remove channels if some of the channels are not active, have weak signals, or you do not want to watch them.

It is best to place channels in memory using the AUTO-SEARCH CHANNELS feature *described above* before you add or remove channels since channels 2-13 are the only ones that are preset at the factory.

- A. Press MENU on the remote to see the VCR MAIN MENU on the TV screen.
- B. Press 3 to display the CHANNEL SETUP menu.
- C. Press 2 to display the ADD/REMOVE CHANNEL menu.
- D. Follow the directions on the screen.
- E. Add or remove more channels by using the CHAN up and down buttons.

```

VCR MAIN MENU

1 TIMER PROGRAMMING
2 REVIEW PROGRAMS
3 CHANNEL SETUP
    
```

```

CHANNEL SETUP

1 AUTO-SEARCH CHANNELS
2 ADD/REMOVE CHANNELS
    
```

```

ADD/REMOVE CHANNEL

      CH 03
      IS PRESENTLY ADDED

PRESS CLEAR TO REMOVE
PRESS MENU TO EXIT
    
```

Startup

7. Use TV•VCR button.

Skip this step if you used one of the advanced hookups.

When using one of the basic hookups, the TV•VCR button lets you switch between the picture coming from the VCR or television channels. This button lets you record a program on the VCR while watching another channel on the TV. *Details are on page 20.*

- A. Press TV•VCR to see the picture from the VCR. The VCR indicator lights in the display panel.
- B. Press CHAN up or down to change channels on the VCR. The channel number changes on the TV screen.
- C. Press TV•VCR to see the TV channels. The VCR indicator does not light in the display panel. Change channels using the TV's remote.
- D. Return the TV to the VCR viewing channel — CH3 or CH4.
- E. Press TV•VCR to switch back to the picture from the VCR.

8. Set AUTO TV/VCR feature.

If you used one of the basic hookups, leave the Auto TV/VCR feature set to ON.

If you used the video input of your TV to connect the VCR, you can prevent the VCR indicator from turning on automatically.

- A. Press MENU on remote to display VCR MAIN MENU.
- B. Press 4 to display VCR SETUP OPTIONS.
- C. Press 3 to select AUTO TV/VCR: ON or OFF.
 - Select ON if you used one of the basic hookups and watch your VCR on channel 3 or 4 of your TV. The VCR will automatically switch the TV•VCR setting to VCR every time you turn on the VCR, insert a tape with its safety tab removed, or press PLAY.
 - Select OFF if you used one of the advance hookups and watch your VCR on the video input channel of your TV. The VCR indicator will not turn on automatically and the signal from your antenna or cable to your TV will not be interrupted.

Pressing TV•VCR on the remote will turn the VCR indicator on or off and switch the antenna signal.

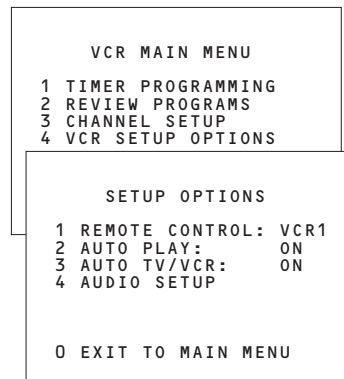

Startup

9. Set the time and date.

- A. Press MENU on remote to display the VCR MAIN MENU.
- B. Press 5 to display SET VCR CLOCK.
The TIMER indicator in the VCR's display panel flashes if the clock is not set.
- C. Enter the time and date with the number buttons on the remote.
 - Press 0 before single-digit numbers.
Example: press 0, then 5, then 0, then 7 for a time of 5:07. Press 1 for AM or 2 for PM.
 - Press CLEAR on the remote to change incorrect entries.
- D. Press MENU to start the clock and remove SET VCR CLOCK menu from the screen.

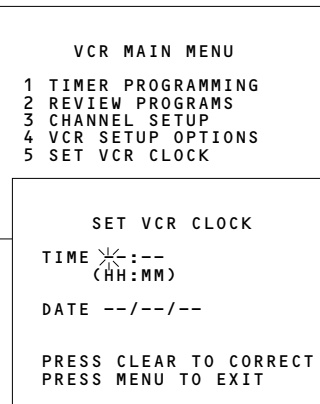

10. Select the language/sélectionner la langue.

This feature lets you select English or French as the language for your on-screen menus.

- A. Press MENU on remote to display the VCR MAIN MENU.
- B. Press 6 to switch between English or French.
 - Select LANGUAGE to have the menus displayed in English.
 - Select LANGUE to have the menus displayed in French.

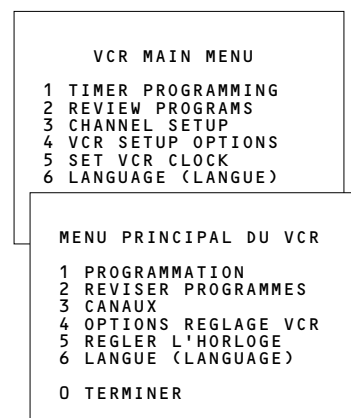

VCR Function Buttons

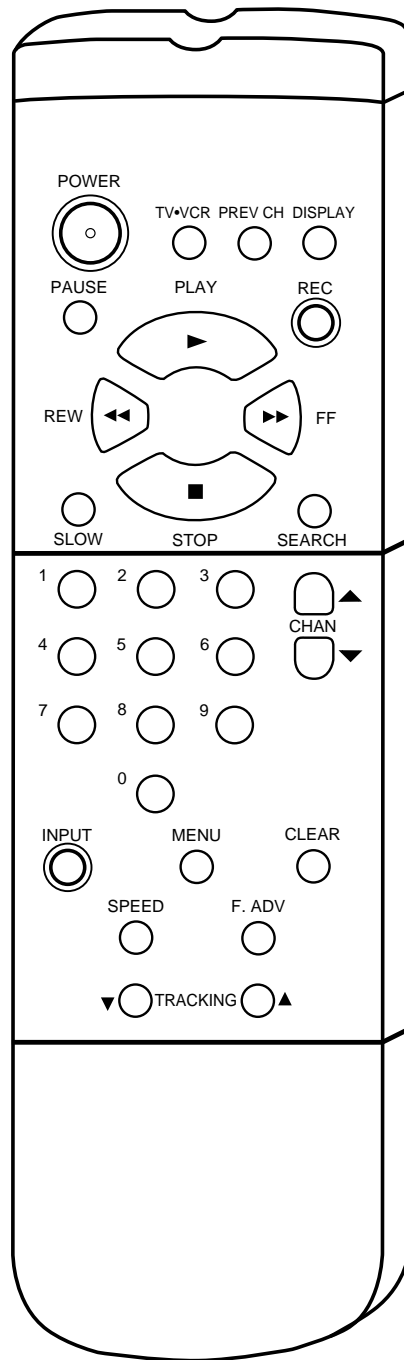

CHAN (Channel Up or Down)

Selects next higher or lower channel in the VCR's channel memory.

CLEAR

Resets time counter to 0:00:00.

Lets you change entries when setting the time or VCR for a timer recording.

DISPLAY

Shows VCR operating displays on the TV screen.

Displays the time counter.

FF (Fast Forward)

Fast forwards the tape when the VCR is stopped.

Searches the picture in forward motion during playback.

F. ADV (Frame Advance)

Lets you view one frame with each press of the button when tape is in stop-action pause.

INPUT

Turns the line input on or off.

Line input refers to the signal coming from the component connected to the audio/video jacks on the back of the VCR.

MENU

Displays the VCR MAIN MENU on the TV screen.

Removes a menu from the screen.

VCR Function Buttons

Numbers (0 through 9)

Select a channel up to 99 by pressing two numbers.

Select a cable channel over 99 by pressing and holding 1 until 1-- appears on the screen. Then press the other two numbers.

PAUSE

Pauses action for viewing during playback.

Pauses recording to prevent recording of unwanted scenes.

PLAY

Plays a tape.

POWER

Turns VCR on and off.

PREV CH (Previous Channel)

Switches between two channels.

Select one channel and then select another. Press PREV CH to switch between the two channels.

REC

Starts VCR recording.

Used for express recording.
See page 21.

REW (Rewind)

Rewinds the tape when the VCR is stopped.

Searches the picture in reverse motion during playback.

SEARCH

Displays ZERO SEARCH menu on TV.

Advances tape 60 seconds during playback.

SLOW

Used for slow-motion playback.

SPEED (Tape Speed)

Selects a recording speed (SP, LP, SLP).

STOP

Stops the VCR's normal functions such as record, playback, rewind, fast forward, and pause.

TRACKING Up or Down

Lets you manually reduce the streaks that may appear on the picture during play or pause.

Reduces picture "jitter" during stop-action playback.

TV•VCR

Switches the picture signal so that it either comes from the VCR or the TV channel. *See page 10.*

Operating Instructions

To play a tape

1. Turn on the TV and tune it to channel 3, 4, or the TV's video input to see the picture from the VCR.
2. Insert a tape in the VCR.
The VCR automatically turns on. The VCR indicator lights if the AUTO TV/VCR feature is turned ON. The tape automatically begins playback if the safety tab on the cassette has been removed and the AUTO PLAY feature is turned on.

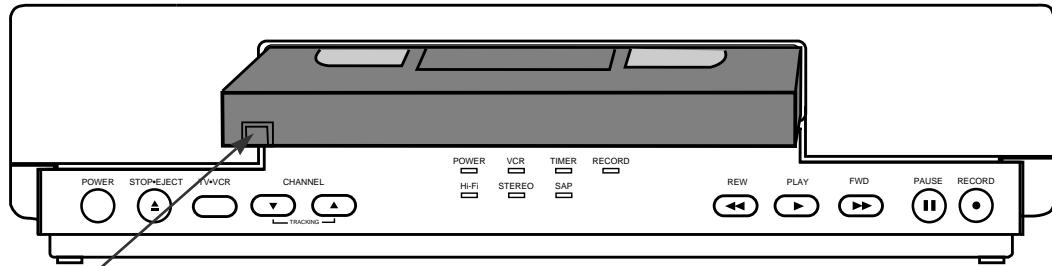

Safety Tab

3. Press PLAY, if necessary.
4. Press TRACKING up or down on the remote or the VCR to remove any streaks from the picture if necessary. *Details are on page 18.*
5. Press STOP•EJECT on the VCR or STOP on the remote.
6. Press REW on the VCR or the remote.
The VCR automatically rewinds the tape if it reaches the end of the tape during playback. Also, if you press POWER while a tape is rewinding, the VCR turns off automatically when it is completely rewound.
7. Press STOP•EJECT on the VCR to eject the tape once it is completely rewound.

Using the Playback Features

AUTO PLAY Feature

This feature lets you tell the VCR whether to automatically start playing when a tape with the safety tab removed is inserted.

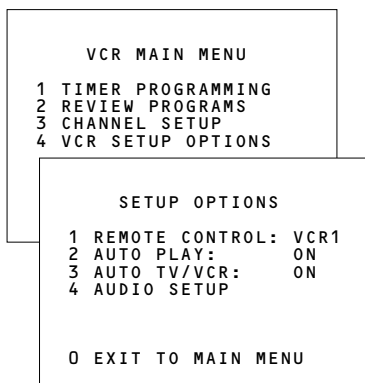

1. Press MENU on the remote to display the VCR MAIN MENU.
2. Press 4 to display the SETUP OPTIONS menu.
3. Press 2 to select AUTO PLAY: ON or OFF.
 - Select ON if you want a tape with its safety tab removed to start playing automatically.
 - Select OFF if you do *not* want a tape with its safety tab removed to start playing automatically.

Picture Search

You can search for a specific tape location during playback by fast forwarding or rewinding the tape. Sound is turned off during picture search. The time counter is removed from the TV screen during picture search. The picture works best for tapes recorded in the SP or SLP speed.

Fast Forward Search

1. Press FF to search forward at a faster-than-normal speed.
2. Press FF or PLAY to return to playback.

Rewind Search

1. Press REW to search backward at a faster-than-normal speed.
2. Press REW or PLAY to return to playback.

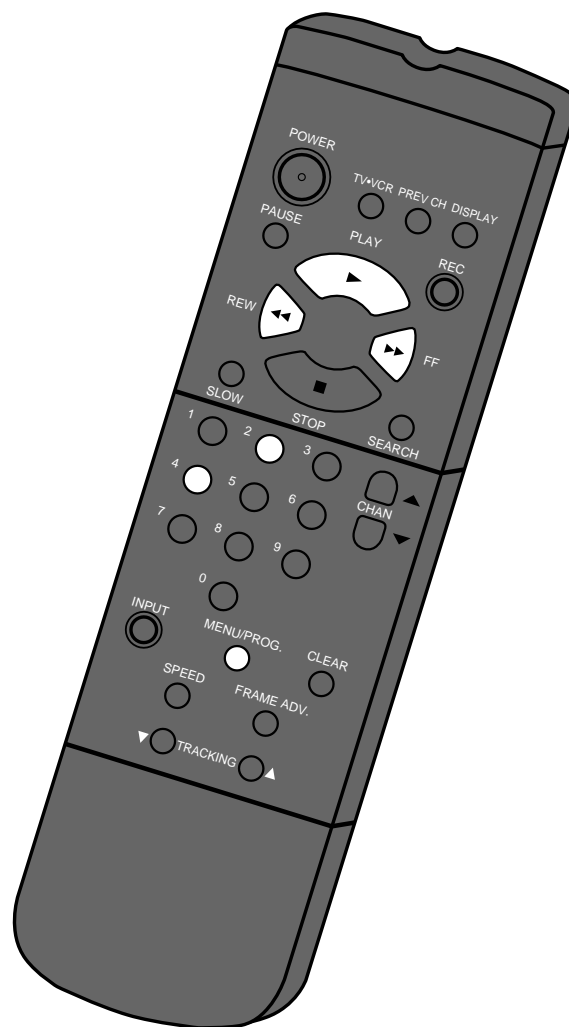

Using the Playback Features

DISPLAY Button

1. Press DISPLAY to display the status of the VCR, channel number, time counter, date, time, and tape speed on the TV screen.
You must set the time and date before they can be displayed. If you do not press DISPLAY again, this display times out.
2. Press DISPLAY again to continually display the time counter on the TV screen.
3. Press DISPLAY again to return to the normal status displays.

Time Counter

The time counter shows the actual time it takes to record a program or play back a segment of a prerecorded tape. It helps locate the beginning or end of programs you taped. The time counter resets to 0:00:00 when the tape is ejected from the VCR.

For example, if you recorded a 30-minute program at the beginning of the tape, you would:

1. Insert the prerecorded tape.
2. Press DISPLAY twice to display only the time counter on the TV screen.
3. Press FF to fast forward the tape until 0:30:00 appears in the time counter. Press STOP.

This is the end of the program. You can begin recording a new program.

4. Press CLEAR to reset the time counter to 0:00:00.
5. Press DISPLAY to remove the time counter from the screen. These displays time out.

The time counter is removed from the TV screen during picture search.

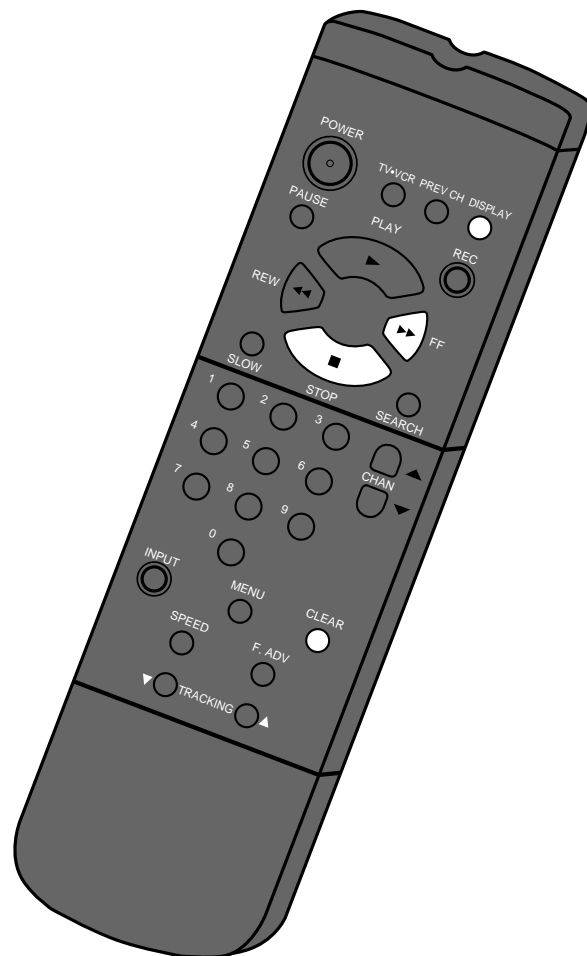
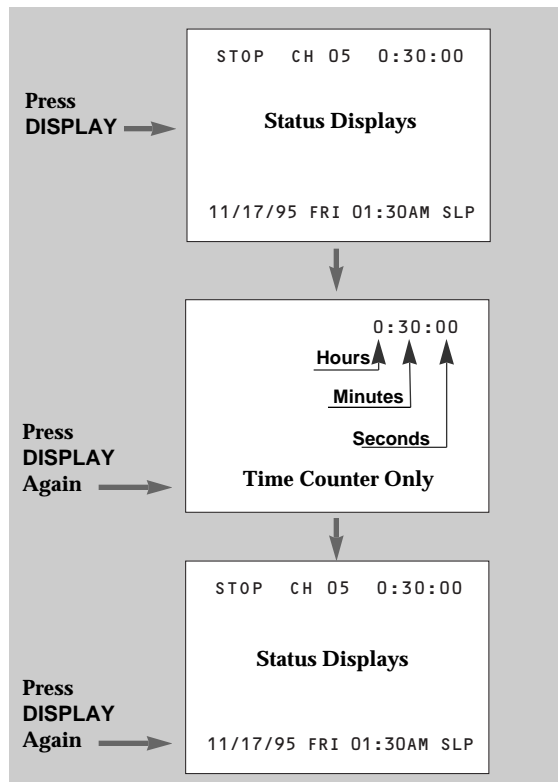

Using the Playback Features

Zero Search

The zero search feature lets you quickly return to a counter reading of 0:00:00 at any spot on the tape. This is especially convenient when you want to watch a segment of the tape several times.

1. Insert the prerecorded tape.
2. Press DISPLAY twice to display only the time counter on the TV screen.
3. Use PLAY, FF, or REW to advance to the place on the tape where you want to return quickly.
4. Press CLEAR to reset the time counter to 0:00:00.
5. Continue playing the tape.
6. Press STOP.
7. Press SEARCH to display the ZERO SEARCH menu on the TV screen. The current time counter appears.
8. Press REW or FF to return to 0:00:00. The time counter remains in the upper right corner of the TV screen during search.

```
ZERO SEARCH
CURRENT TAPE COUNTER IS
  2:17:25

PRESS REW TO GO TO 0:00
PRESS SEARCH TO EXIT
```

```
ZERO SEARCH
CURRENT TAPE COUNTER IS
 -2:17:25

PRESS FWD TO GO TO 0:00
PRESS SEARCH TO EXIT
```

Commercial Scan (SEARCH Button)

This is useful for scanning commercials or short program segments.

1. Press SEARCH during playback to advance the tape approximately 60 seconds.

Slow Motion

You can view the picture in slow motion during play or play pause. Sound is turned off during slow-motion playback. Slow motion works best in the SP or SLP speed.

1. Press SLOW to begin slow-motion playback.
2. Use TRACKING up or down on the remote or the VCR to remove any streaks from the picture.
3. Press SLOW or PLAY to return to playback.

The VCR automatically switches from slow-motion playback to stop after a few minutes.

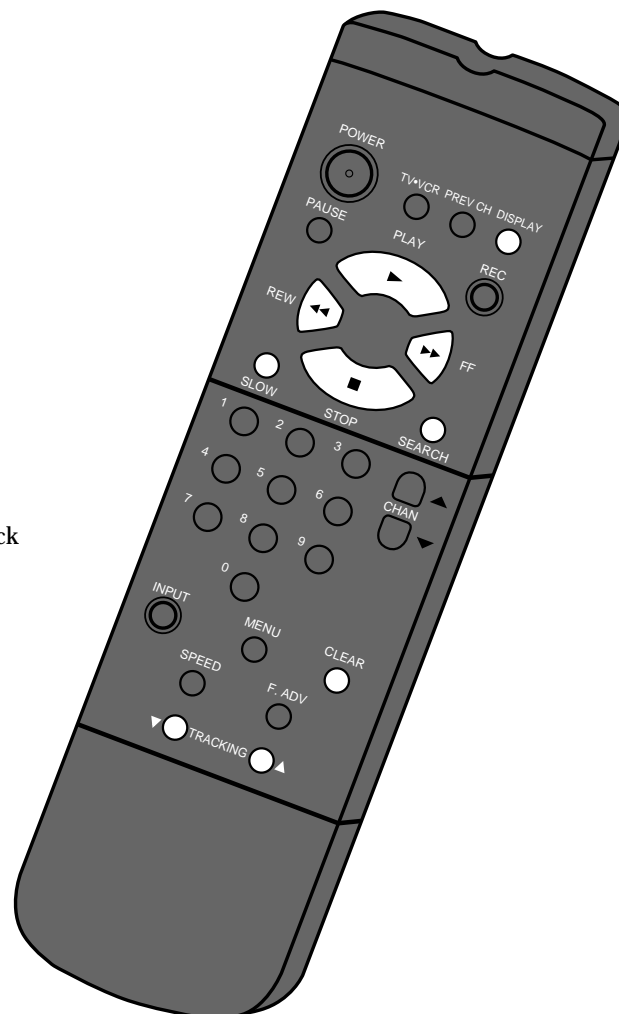

Using the Playback Features

Pause for Stop Action

This feature stops the tape in action and lets you examine the details of the scene. Stop action works best for tapes recorded in the SP or SLP speed.

1. Press PAUSE during playback to stop the action.
2. Press TRACKING up or down on the remote to reduce any jittering of the picture.
3. Press PAUSE or PLAY to return to playback.

The VCR automatically switches from stop-action playback to stop after a few minutes.

Frame Advance (F. ADV Button)

Frame advance lets you view one stop-action frame after another. Frame advance works best for tapes recorded in the SP or SLP speed.

1. Press PAUSE to stop the action.
2. Press F. ADV each time you want to view a frame of the scene.
3. Press PAUSE or PLAY to resume normal playback.

Automatic Tracking

The VCR has automatic tracking which adjusts the picture when you are playing back a tape recorded on another VCR. Automatic tracking is turned on when a tape is inserted or the VCR's power is turned on.

Manual Tracking

Occasionally, you may need to manually adjust tracking on a tape recorded on a different VCR or camcorder. Tracking is used when playing a tape. It has no effect during recording.

When streaks or snow appear in the picture, press TRACKING up or down on the remote or the VCR for the best possible picture.

During stop action pause, press TRACKING up or down on the remote to reduce any jittering of the picture.

When the sound is noisy, press TRACKING up or down on the remote for the best possible sound.

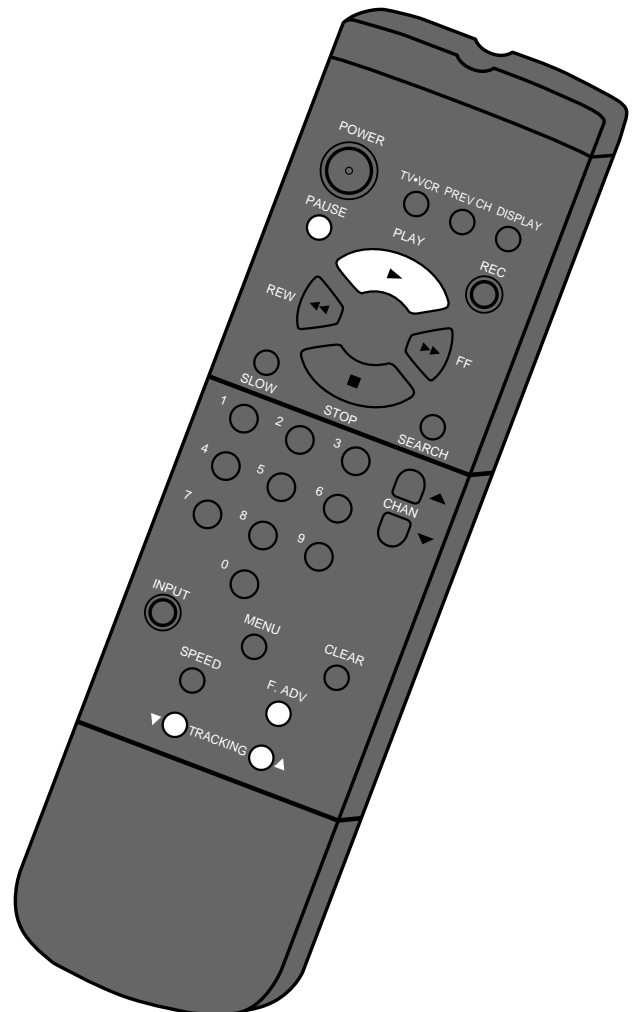

Using the Playback Features

PLAYBACK: HI-FI/MIX/LINEAR Feature

The VCR records the same audio on both the Hi-Fi and linear tracks on the tape. The Hi-Fi sound is recorded on separate left and right stereo channels. Monaural sound is recorded on the linear track.

To enjoy Hi-Fi sound, connect your VCR to a stereo television or amplifier/receiver using the audio/video jacks. The PLAYBACK: HI-FI/MIX/LINEAR feature lets you select which audio you play back.

To Select Playback Sound

1. Press MENU to see the VCR MAIN MENU.
2. Press 4 to see the SETUP OPTIONS menu on the TV screen.
3. Press 4 to see the AUDIO SETUP menu on the TV screen.
4. Press 2 to switch between HI-FI, MIX, or LINEAR sound.

- Select HI-FI to play back sound recorded on the Hi-Fi track and for normal use.

The Hi-Fi indicator lights in the VCR's display panel.

- Select MIX to play back the sound recorded on both the Hi-Fi and linear track, sound-on-sound.

The Hi-Fi indicator lights in the VCR's display panel.

- Select LINEAR to play back the sound recorded on the linear monaural track, such as a second audio program (SAP).

The Hi-Fi indicator in the VCR's display panel turns off.

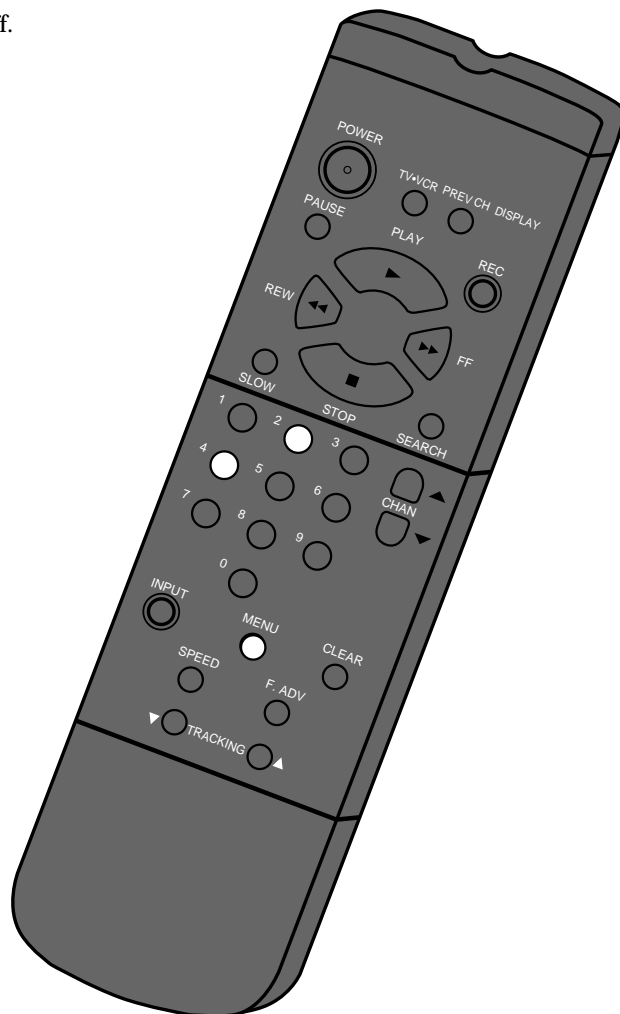
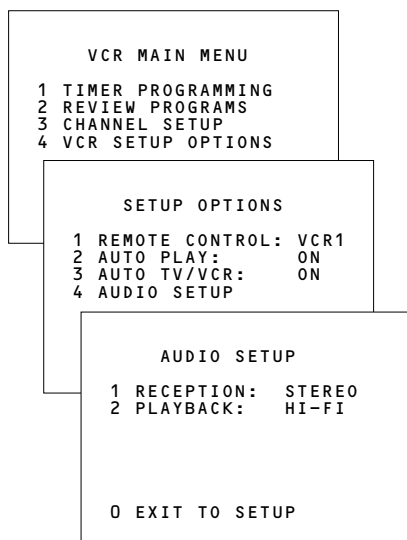

Types of Recordings

Your VCR provides different recording features. These features are explained in the following sections.

Recording Speeds

Press **SPEED** on the remote to select a recording speed (SP, LP, or SLP). The speed you select appears on the TV screen.

SP (Standard Play) gives the best quality recording. That is why most prerecorded, rental tapes are recorded in SP. Fewer programs can be recorded on the tape. Special effects such as pause, frame advance, slow motion, and picture search work well in this speed.

LP (Long Play) gives twice the recording time of tapes recorded in SP.

SLP (Super Long Play) gives three times the recording time of tapes recorded in SP. Special effects such as pause, frame advance, slow motion, and picture search work well in this speed.

Cassette	Recording Time		
	SP	LP	SLP
T-120	2Hrs	4Hrs	6Hrs
T-160	2Hrs 40Min	5Hrs 20Min	8Hrs

Recording Pause

This feature lets you prevent recording short passages of unwanted material.

Press **PAUSE** during recording to stop and start recording.

The VCR automatically switches from pause to stop after a few minutes.

Basic Recording – Operating Instructions

To make a recording

Turn on the TV and tune it to the VCR viewing channel, either 3, 4, or the TV's video input channel.

1. Insert a tape with its safety tab in place.
2. If you are using one of the basic hookups, make sure the VCR indicator appears in the VCR's display panel. If not, press **TV•VCR** to turn it on.
3. Use **SPEED** on the remote to select a recording speed. The tape speed indicator appears on the TV screen.
4. Select the channel to be recorded. The channel number appears on the TV screen.
5. Press **RECORD** and **PLAY** at the same time on the VCR or **REC** on the remote to begin recording. The **RECORD** indicator appears in the VCR's display panel while the VCR is recording.

Watch a TV channel while VCR is recording a different channel

1. Follow steps 1 through 5 above.
2. If you are using one of the basic hookups, press **TV•VCR** to switch to the TV channel. The VCR indicator turns off in the display panel.
3. Select the channel you want to watch with the TV's channel buttons.
4. Press **STOP•EJECT** on the VCR or **STOP** on the remote when the recording is finished.

Express Recording

Express recording lets you record up to four hours without using the timer program feature. The VCR turns off automatically at the end of the recording.

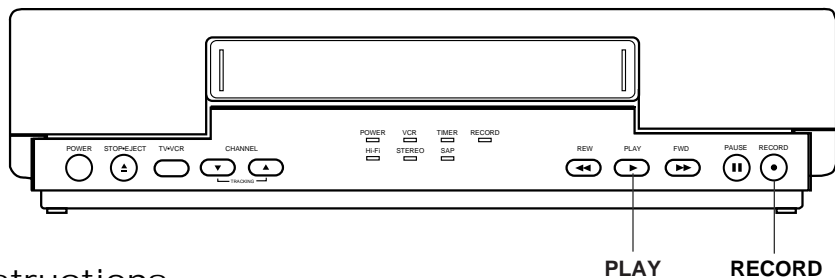

Operating Instructions

1. Turn on the VCR.
2. Insert a tape with its safety tab in place.
3. Select the channel you want to record.
4. Use SPEED on the remote to select a recording speed.
5. Press RECORD and PLAY at the same time on the VCR or REC on the remote to activate recording.
6. Press RECORD or REC repeatedly until the amount of recording time for the program is displayed on the TV screen.

Each press of RECORD or REC increases the time — 30 minutes up to 4 hours.

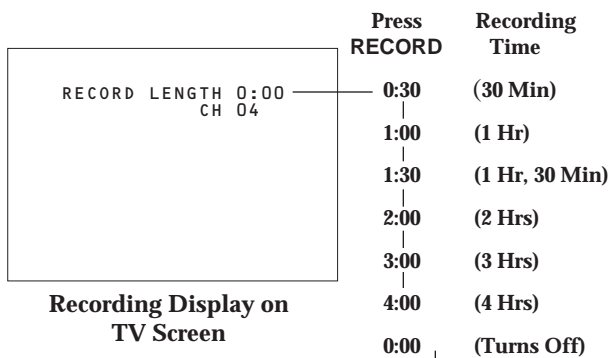

The RECORD and TIMER indicators appear in the VCR's display panel.

During recording, press RECORD and PLAY together on the VCR or REC on the remote to display the time remaining on the TV screen. Press RECORD or REC again to increase the recording time.

Stopping a Recording in Progress

With the VCR: Press STOP•EJECT.

With the Remote: Press STOP.

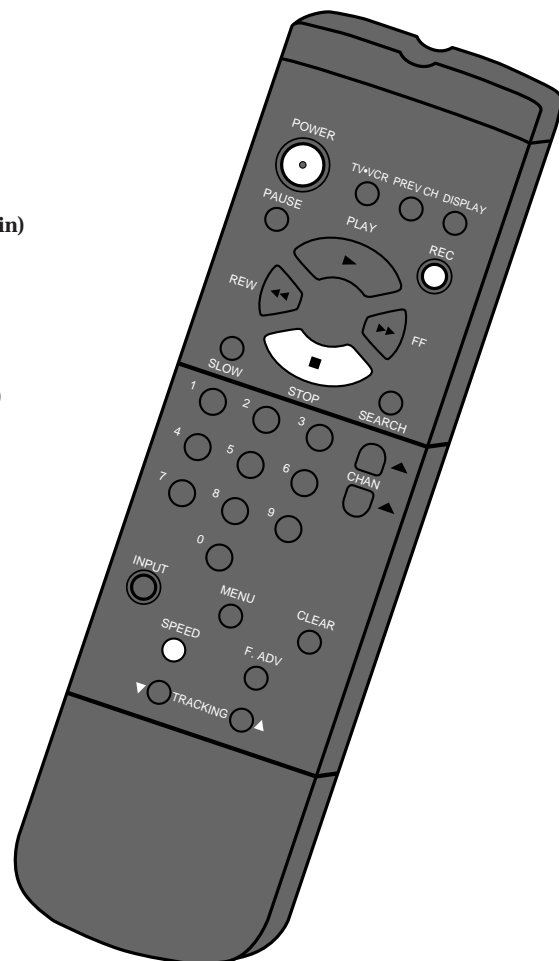

Stereo Broadcast TV or SAP (Second Audio Program)

Some TV programs are broadcast with stereo audio or a second audio language (SAP). The RECEPTION: STEREO/SAP/MONO feature lets you select the type of audio you want to record.

To record stereo broadcast TV or SAP

Turn on the TV and tune it to the VCR viewing channel, either 3, 4, or the TV's video input.

1. Insert a tape with its safety tab in place.
2. If you are using one of the basic hookups, make sure the VCR indicator appears in the VCR's display panel. If not, press TV•VCR to turn it on.
3. Use SPEED on the remote to select a recording speed. The tape speed indicator appears on the TV screen.
4. Select the channel or line input to be recorded. The channel number or VIDEO appears on the TV screen.
5. Set the RECEPTION: STEREO/SAP/MONO feature for the type of audio you want to record.
 - A. Press MENU to display the VCR MAIN MENU.
 - B. Press 4 to display the SETUP OPTIONS menu.
 - C. Press 4 again to display the AUDIO SETUP menu.
 - D. Press 1 to select the type of audio RECEPTION: STEREO, SAP, or MONO.
 - Select STEREO for normal and stereo broadcast TV recording.

The STEREO indicator lights in the VCR's display panel when the station you are tuned to is broadcasting stereo.
 - Select SAP to record SAP (second audio program) instead of the normal audio.

The SAP indicator lights in the VCR's display panel when the station you are tuned to is broadcasting SAP.

Set the PLAYBACK: HI-FI/MIX/LINEAR feature to LINEAR to hear SAP. *Details are on page 19.*
 - Select MONO if the stereo signal is weak and the sound is too "noisy."
6. Press RECORD and PLAY at the same time on the VCR or REC on the remote to start recording. The RECORD indicator lights in the display panel.
7. Press STOP•EJECT on the VCR or STOP on the remote when you are finished.

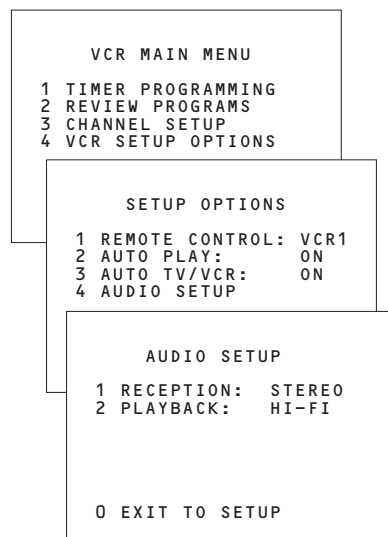

Recording Audio Only

You can record audio only from another audio source connected to the AUDIO1 IN (L and R) jacks on the back of the VCR.

To Record Audio Only *(Refer to hookup on page 7.)*

1. Press the INPUT button on the remote until VIDEO appears on the TV screen.
The VCR records audio from the audio equipment connected to the AUDIO1 IN jacks.
2. Use SPEED on the remote to select the recording speed.
The tape speed indicator appears on the TV screen.
3. Start playing the audio source. Then, press RECORD and PLAY at the same time on the VCR or REC on the remote to begin recording.
The RECORD indicator lights in the VCR's display panel.
4. Press STOP•EJECT on the VCR or STOP on the remote when you are finished.

Recording While You're Away (Timer Recording)

The timer program feature lets you program the VCR to record up to eight different programs within a one-year period. Before setting the timer, make sure that:

- The clock is set correctly.
- A tape with a safety tab has been inserted with enough tape to record the programs.
- If you receive all channels from a cable box, complete CABLE BOX SETUP *on the next page*.

Setting a Timer Recording

1. Press MENU on the remote to display the VCR MAIN MENU.
2. Press 1 to display the TIMER PROGRAMMING menu.
3. Press 1, 2, 3, or 4 to select type of program.
 - 1 ONE TIME — single program recorded once.
 - 2 DAILY — program recorded at same time every day.
 - 3 WEEKDAYS — program recorded at same time Monday through Friday.
 - 4 WEEKLY — program recorded at same time once a week.

4. Press number buttons on the remote to enter the channel number (or INPUT on the remote to select line input), start time including AM or PM, end time, and start date of the recording. Follow the on-screen prompts.

Press CLEAR on the remote to correct an entry.

If you receive all channels from a cable box and have completed CABLE BOX SETUP, the output channel of your cable box and the word CABLE automatically appears on the menu. *See page 25.*

5. Use SPEED on the remote to select the recording speed.
6. Press MENU to enter your program. A reminder appears which times out, or you can press MENU to return to the VCR MAIN MENU.
7. Repeat steps 2–6 for additional programs or press MENU to remove the menu from the TV screen.
8. If you are using a cable box, leave it turned on and tuned to the channel you want to record. Otherwise, **turn off the VCR** before recording begins.

The TIMER indicator appears in the VCR display panel.

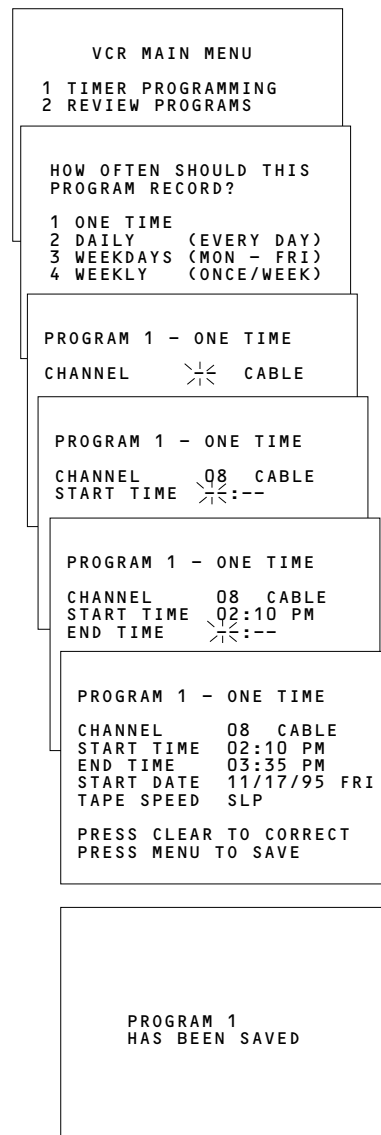

Stopping a Timer Recording

With the VCR: Press POWER and then STOP•EJECT within a few seconds.

With the Remote: Press POWER and then STOP within a few seconds.

Recording While You're Away (Timer Recording)

Select cable box viewing channel. (Required only if all channels are received from a cable box.)

1. Press MENU on the remote to display the VCR MAIN MENU.
2. Press 3 to display the CHANNEL SETUP menu.
3. Press 4 to display the CABLE BOX SETUP menu.
4. Press 1 when the CABLE BOX SETUP menu appears.
5. Press two numbers on the remote to enter the output channel of your cable box. Press 0 before a single-digit number. (Valid numbers are 01 – 13.)
Press CLEAR on the remote to correct an entry.
If you connected your cable box to the VCR using the cable box's AUDIO/VIDEO OUT jacks, press INPUT on the remote to select the VIDEO IN option.
6. Press MENU. A message appears which will time out, or you can press MENU to return to CHANNEL SETUP Menu.
The VCR automatically enters the output channel of your cable box and CABLE in the TIMER PROGRAMMING menu.

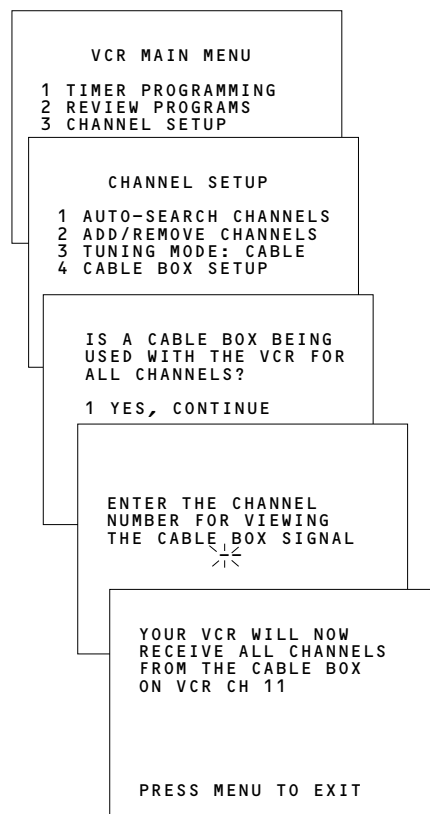

Timer Recording From the VCR's Line Input

The line input refers to the signal coming from the AUDIO and VIDEO IN jacks of the VCR. Recording from the line input is convenient if you have a satellite receiver or similar component attached to these jacks.

To timer record from the component connected to the VCR's line input, press INPUT on the remote to enter VIDEO IN instead of the channel number on the TV screen during timer programming.

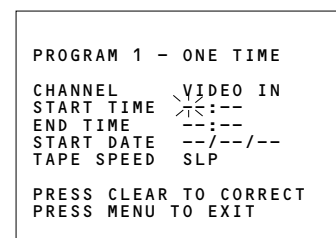

Checking or Clearing Timer Recordings

1. Press MENU on remote to display the VCR MAIN MENU.
2. Press 2 for REVIEW PROGRAMS.
Each entered program is displayed for a few seconds in sequence. Press MENU or 2 to display information faster.
3. Press CLEAR on the remote when the program you want to erase appears on the screen.

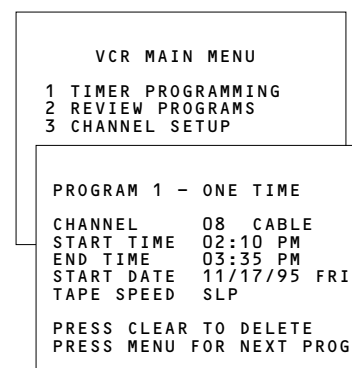

Using Two VCRs for Copying and Editing Tapes

Operating Instructions (Refer to hookup on page 6.)

Use this VCR as the playback VCR and the other as the recording VCR.

Caution: The unauthorized recording of television programs and other materials may infringe the rights of others.

1. Turn on the TV and VCRs.
2. Tune the TV to the VCR viewing channel, either 3, 4, or the TV's video input.
3. If you connected your VCR using Option A (page 6), tune the recording VCR to channel 3 or 4 – the one you selected on the back of the playback VCR.
If you connected your VCR using Option B (page 6), press INPUT on the recording VCR's remote to select the line input.
4. Insert the tape you want to copy into the playback VCR. Insert a blank tape with its safety tab in place into the recording VCR.
5. Press PLAY, then PAUSE on the playback VCR's remote when you reach the point on the tape or program where you want to begin copying. If the tape was not recorded on the playback VCR, streaks may appear and you may need to adjust tracking.
6. Press REC on the remote or RECORD on the VCR. Then, press PAUSE on the recording VCR's remote to place the recording VCR in record pause.
7. Press PAUSE on both VCRs at the same time to begin copying the tape.*
8. Edit out segments that you do not want to copy by pressing PAUSE on the recording VCR's remote to stop copying the tape. Then, locate the next segment you want to copy on the playback VCR by using FWD, REW or PLAY. Press PAUSE on the playback VCR's remote. Press PAUSE on both VCRs at the same time to resume copying.
9. Press STOP•EJECT on both VCRs when you are finished.

* You may turn off the TV after the recording has started as it does not have to be on to copy a tape.

Copying and Editing Tapes Using Compatible Remote

If you have a compatible RCA or ProScan remote with VCR1 and VCR2 buttons, you can program this VCR to respond to either VCR1 or VCR2. This lets you control both VCRs with one remote for easier copying and editing.

Set the REMOTE CONTROL feature of this VCR to VCR1 or VCR2 position. Then, the compatible remote operates the VCR with either the VCR1 or VCR2 button — depending on the position you select in the menu.

1. Press MENU to display the VCR MAIN MENU.
2. Press 4 to display SETUP OPTIONS.
3. Press 1 to activate the REMOTE CONTROL: VCR1 or VCR2 feature.
4. Press VCR1 or VCR2 on your compatible VCR's remote to change the setting and program this VCR to respond to VCR1 or VCR2 — depending on the position you selected in step 3.

VCR MAIN MENU

- 1 TIMER PROGRAMMING
- 2 REVIEW PROGRAMS
- 3 CHANNEL SETUP
- 4 VCR SETUP OPTIONS

SETUP OPTIONS

- 1 REMOTE CONTROL: VCR1
- 2 AUTO PLAY: ON
- 3 AUTO TV/VCR: ON
- 4 AUDIO SETUP

PRESS VCR2 TO CHANGE

SETUP OPTIONS

- 1 REMOTE CONTROL: VCR2
- 2 AUTO PLAY: ON
- 3 AUTO TV/VCR: ON
- 4 AUDIO SETUP

0 EXIT TO MAIN MENU

Specifications

Format:	VHS
Record/Playback System:	Video: 4-Head Audio: VHS Hi-Fi Stereo record/playback system
Video Signal System:	EIA standard: NTSC color
Antenna:	75-ohm external VHF/UHF combined antenna terminal
Tuner:	USA: 181 channels capability* (125 cable channels) Canada: 178 channels capability* (122 cable channels)
Type:	Autoprogramming frequency synthesis
Power Requirement:	120V AC, 60 Hz
Power Consumption:	23 watts
Dimensions:	3.5 inches high (89 mm) 15 inches wide (380 mm) 11.2 inches deep (285 mm)
Weight:	8.4 pounds (3.8 kg)
Storage Temperature Range:	- 22°F to +149°F
Operating Temperature Range:	+41°F to +104°F

*Check your cable company's compatibility requirements.

Cleaning the VCR

Use a soft cloth or dusting attachment of your vacuum cleaner to dust your VCR. Remove dust from the ventilation holes on the top, back, sides, and bottom of the cabinet.

Plastic surfaces are easily scratched and can be marred by alcohol and various solvents. Avoid excessive use of oil-based furniture polishes since the materials used in the cabinet will accumulate more dust. We recommend using a non-abrasive, anti-static cleaner and polisher.

Location of Controls

Front Panel

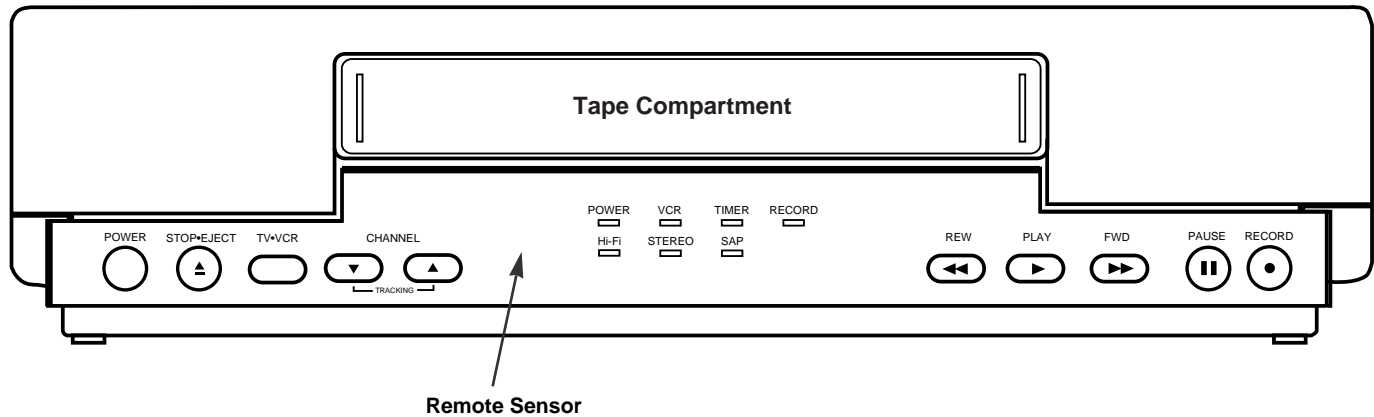

CHANNEL or TRACKING up or down

Selects next higher or lower channel in the VCR's channel memory.

Adjusts tracking during playback.

FWD (Fast Forward)

Fast forwards the tape when the VCR is stopped.

Searches the picture forward during playback.

PAUSE

Pauses the tape for stop-action viewing during playback.

Pauses the tape during recording to prevent recording unwanted material.

PLAY

Plays a tape.

Press with RECORD to start the VCR recording.

POWER

Turns the VCR on or off.

RECORD

Press RECORD and PLAY at the same time to start the VCR recording.

Used for express recording.

Remote Sensor

Receives signals from the remote control. Aim the remote at this sensor with no objects between them.

REW

Rewinds the tape when the VCR is stopped.

Searches the picture in reverse during playback.

STOP•EJECT

Stops the normal functions such as record, playback, rewind, fast-forward, or pause.

Press when the VCR is stopped to eject the cassette.

TV•VCR

Switches the picture signal so that it either comes from the VCR or the TV channel.

Location of Controls

Back Panel

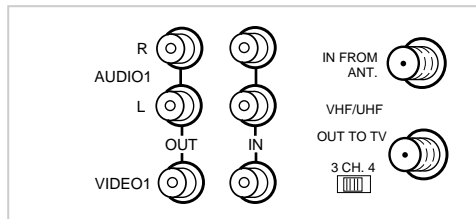

3CH.4 Switch

Selects the channel to which you tune the TV to see the VCR picture if you connect the VCR using one of the basic hookups.

IN FROM ANT. (Antenna) Connector

Receives a signal from an antenna or cable system when attached.

OUT TO TV Connector

Passes signal to TV using the cable supplied.

VIDEO1 IN and AUDIO1 (R and L) IN Jacks

Receive signals from another component like a VCR or camcorder when it is connected to these jacks. Use INPUT on the remote to select.

VIDEO1 OUT and AUDIO1 (R and L) OUT Jacks

Send signals from VCR to another component like a VCR or camcorder when it is connected to these jacks.

Display Panel

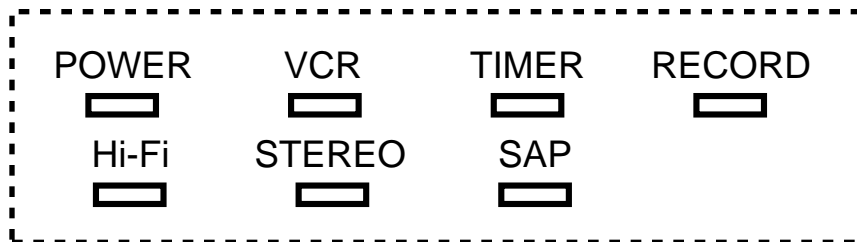

Hi-Fi Indicator

Lights when PLAYBACK: HI-FI/MIX/LINEAR feature is set to HI-FI or MIX.

POWER Indicator

Lights when the VCR is turned on.

RECORD Indicator

Lights when the VCR is recording.

STEREO Indicator

Lights when the station you are tuned to is broadcasting stereo.

SAP Indicator

Lights when the station you are tuned to is broadcasting SAP.

TIMER Indicator

Shows VCR is set for timer recording when VCR is turned off.

Flashes when the clock is not set or a timer recording is set and there is no cassette in the VCR.

VCR Indicator

Lights when using the TV•VCR button.

When using one of the basic hookups:

- The picture is coming from the VCR when the VCR indicator is on.
- The picture is coming from the television channels when the VCR indicator is off.

Trouble Checks

Sometimes problems can be easily solved by checking a few basic things. Check below before you call for help or take your VCR to an Authorized RCA VCR Servicer.

Trouble	Here's what to try:
No power	<ul style="list-style-type: none"> • Plug VCR into an operating outlet. • Check connections.
VCR does not respond to remote	<ul style="list-style-type: none"> • Remove batteries and hold down one or more buttons for several seconds to drain the microprocessor inside the remote and reset it. Re-install the batteries and try remote again. • Aim remote at VCR with no objects between them. • Change batteries. • Check setting of REMOTE CONTROL: VCR1 (VCR2) feature. <i>See page 26.</i>
Poor or no picture for normal TV viewing	<ul style="list-style-type: none"> • Press TV•VCR to turn VCR indicator off. • Switch TV to an active channel. • Check antenna connections.
Snowy or no picture during playback	<ul style="list-style-type: none"> • Press TV•VCR to turn VCR indicator on. • Check TV channel selected (3 or 4) to make sure it matches the channel selected with 3CH.4 switch on back of VCR. • Check TV's fine tuning. • Check video cable connections between VCR and TV monitor. • Set TV monitor to video input channel. • Try another tape. • Some snow/streaks are normal during search, stop action, frame advance, and slow-motion playback.
Streaks in picture during normal playback	<ul style="list-style-type: none"> • Press the TRACKING button on the remote or the VCR to move streaks for the best picture. • Check tape — it may be worn out or of poor quality.
Time counter not working	<ul style="list-style-type: none"> • The time counter does not advance during unrecorded portions of tape. When an unrecorded segment of tape is encountered, the time counter will hold its count until recorded material is detected again. • A minus (-) appears in front of the time if you rewind the tape farther back than a counter reading of 0:00:00.
Will not record or play	<ul style="list-style-type: none"> • No cassette in VCR. • Eject and reinsert cassette. • Broken tape — try another cassette. • VCR is in pause mode. Press PAUSE.
Will not record	<ul style="list-style-type: none"> • Safety tab removed from cassette. • Make sure the line indicator (VIDEO) does not appear on the TV screen for normal recording from the VCR's tuner. Press INPUT on the remote to turn the line input off.
Stereo or SAP sound not recorded	<ul style="list-style-type: none"> • RECEPTION: STEREO/SAP/MONO feature must be set to STEREO to record broadcast stereo. <i>See page 22.</i> • RECEPTION: STEREO/SAP/MONO feature must be set to SAP to record SAP. <i>See page 22.</i> • STEREO or SAP indicator not on. Station not broadcasting stereo or SAP.

Trouble Checks

Trouble	Here's what to try:
Rewind does not operate	<ul style="list-style-type: none"> • Tape already rewound.
Timer recording not made or wrong program recorded	<ul style="list-style-type: none"> • Cable box was not turned on at time recording was to begin. • Program entered incorrectly (wrong channel or times). • Power interruption. Reset clock. <i>See page 11.</i> • Check to see if time and date are correct — including AM/PM. • Program exceeded tape's length or tape was not rewound beforehand. • VCR was not turned off at the time recording was to start. • No tape in VCR or tape's safety tab broken off.
Incorrect time or date	<ul style="list-style-type: none"> • Clock was not set accurately (check AM/PM and date). <i>See page 11.</i>
VCR makes noise when stopped	<ul style="list-style-type: none"> • VCR is removing tape from heads. This is normal. The head cylinder inside the VCR continues to rotate for a few minutes after you put the VCR in the stop mode.
Will not AutoProgram active channels correctly	<ul style="list-style-type: none"> • Check antenna connections. • Check TUNING MODE: CABLE/ANTENNA feature. <i>See page 9.</i>
Cannot add or remove channels	<ul style="list-style-type: none"> • Channels must be placed in memory using AUTO-SEARCH CHANNELS feature before channels can be added or removed from channel memory. <i>See page 9.</i>
Cannot select channels over 69	<ul style="list-style-type: none"> • Cable channels over 69 can only be selected if TUNING MODE: CABLE/ANTENNA feature is set to CABLE. <i>Details are on page 9.</i>
Cassette with safety tab removed does not start to play automatically	<ul style="list-style-type: none"> • Set AUTO PLAY ON/OFF feature to ON. <i>Details are on page 15.</i>
Tape plays back in slow motion	<ul style="list-style-type: none"> • Press SLOW or PLAY to return to normal playback.
TIMER indicator flashes	<ul style="list-style-type: none"> • Clock was not set. <i>See page 11.</i> • Timer recording programmed and no cassette in VCR.
On-screen menus are in French	<ul style="list-style-type: none"> • LANGUAGE feature set to LANGUE. <i>See page 11.</i>
Time counter disappears while searching	<ul style="list-style-type: none"> • This is normal. <i>Details are on page 15.</i>
No stereo sound during playback	<ul style="list-style-type: none"> • PLAYBACK: HI-FI/MIX/LINEAR feature must be set to HI-FI to hear stereo sound during playback. <i>See page 19.</i>
Stereo audio too noisy	<ul style="list-style-type: none"> • Stereo signal is weak. Set RECEPTION: STEREO/SAP/MONO feature to MONO. • Press the TRACKING up or down button on the remote to minimize the noise.

Limited Warranty

What your warranty covers:

- Any defect in material or workmanship.

For how long after your purchase:

- 90 days for labor charges.
- One year for parts.

The warranty period for rental units begins with the first rental.

What we will do:

- Pay any Authorized RCA VCR Servicenter the labor charges to repair your VCR.
- Pay any Authorized RCA VCR Servicenter for the new or, at our option, refurbished replacement parts required to repair your VCR.

How you get service:

- Take your VCR to any Authorized RCA VCR Servicenter. To identify your nearest Authorized RCA VCR Servicenter, ask your dealer, look in the Yellow Pages, or call 1-800-336-1900.
- Show the service technician your evidence of purchase date.
- Pick up your VCR when repairs are completed.

What your warranty does not cover:

- Customer instruction. (Your Owner's Manual clearly describes how to install, adjust, and operate your VCR. Any additional information should be obtained from your dealer.)
- Installation and related adjustments.
- Signal reception problems not caused by your VCR.
- Damage from misuse or neglect.
- Cleaning of video/audio heads.
- Remote control batteries.
- A VCR that has been modified or incorporated into other products or is used for institutional or other commercial purposes.
- A VCR purchased or serviced outside the USA.
- Acts of God, such as but not limited to lightning damage.

Product Registration:

- Please complete and mail the Product Registration Card packed with your VCR. It will make it easier to contact you should it ever be necessary. The return of the card is not required for warranty coverage.

How state law relates to this warranty:

- This warranty gives you specific legal rights, and you also may have other rights that vary from state to state.

If you purchased your VCR outside the United States:

- This warranty does not apply. Contact your dealer for warranty information.

Index

- 3CH.4 Switch.....3-8,9,29
- Accessories, Included8
- Add or Remove Channels from
 - Memory.....9
- ADD/REMOVE CHANNEL Menu9
- Amplifier/Receiver Connections.....7
- Antenna Connections2,3
- AUDIO SETUP Menu19,22,23
- Audio Only, Recording23
- AUDIO1/VIDEO1 IN Jacks.....6,7,23,26,29
- AUDIO1/VIDEO1 OUT Jacks.....3-7,26,29
- AUTO TV/VCR Feature.....10
- AUTO PLAY Feature15
- AUTO-SEARCH CHANNELS Feature9
- Back Panel29
- Batteries, Inserting in Remote.....8
- Cable Box Setup.....25
- Cable System With Cable Box
 - Connections.....2,4,5
- Cable System Without Cable Box
 - Connections.....2,3
- Cable Box Setup.....25
- Card, Registrationi
- CHAN Buttons.....9,12,28
- CHANNEL SETUP Menu.....9,25
- Checking Timer Recordings25
- Checks, Trouble.....30-31
- Choosing a Hookup.....2
- Cleaning the VCR.....27
- CLEAR Button11,12,24,25
- Clearing Timer Programs.....25
- Commercial Scan.....17
- Compatible Remotes.....26
- Connections2-7
 - Antenna.....2-3
 - Amplifier/Receiver.....2,7
 - Audio/Video Jacks.....2,3-7
 - Cable-TV2,4-5
 - Two VCRs6
- Contents.....1
- Copying Tape, Connections.....6
- Copying Tapes.....26
- Date and Time, Setting11
- Design Specifications27
- DISPLAY Button.....12,16,17
- Display Panel29
- Editing Tapes26
- Express (XPR) Recording.....21
- FF (Fast Forward)
 - Button.....12,15,16,17
- First-Time Operation8-11
- Frame Advance Feature18
- F. ADV (Frame Advance)
 - Button.....12,18
- Français.....11
- Front Panel28
- FWD (Fast Forward)
 - Button.....26,28
- Hi-Fi Indicator19,29
- Hookups
 - Antenna.....2-3
 - Amplifier/Receiver.....2,7
 - Audio/Video Jacks.....2,3-7
 - Cable-TV2,4-5
 - Two VCRs6
- Hookup, Choosing.....2
- IN FROM ANT. Connector.....3-5,29
- INPUT Button.....12,24,25
- LANGUAGE (LANGUE) Menu.....11
- Language, Selecting11
- LANGUE (LANGUAGE) Menu11
- Limited Warranty.....32
- Line Input, Recording From25
- Location of Controls
 - Remote Control.....12-13
 - VCR Back Panel.....29
 - VCR Display Panel.....29
 - VCR Front Panel.....28
- LP Speed20
- MENU Button8-12,15,19,22,23-26
- Number Buttons.....12-13
- Operating Instructions
 - Audio Only Recording23
 - Broadcast Stereo TV Recording22
 - Copying Tapes.....26
 - Express (XPR) Recording.....21
 - Playing a Tape14
 - Recording a Program.....20
 - SAP Recording.....22
 - Timer Recording.....24
- Operation, First Time8-11
- OUT TO TV Connector.....3-5,29
- PAUSE Button.....12-13,18,20,26
- Pause for Stop Action18
- Pause, Recording.....20
- Picture Search15
- PLAY Button.....12-13,14,15,17,20-23,26,28
- PLAYBACK: HI-FI/LINEAR/MIX
 - Feature19,22
- Playing a Tape14-19
- POWER Button8,12-13,21,24,28
- POWER Indicator8,29
- PREV CH (Previous Channel)
 - Button12-13
- Problems, Solving30-31
- Product Registrationi
- REC Button.....12-13,20-23,26
- RECEPTION: STEREO/MONO/SAP
 - Feature22,23
- RECORD Indicator20-24,29
- Recording
 - Audio Only23
 - Basic20
 - Broadcast Stereo TV.....22
 - Express Recording21
 - From Another VCR.....26
 - One Program While
 - Watching Another.....20
 - Pause20
 - SAP (Second Audio Program).....22
 - Speeds.....20
 - Timer.....24-25
 - Types Of20
- RECORD Button.....20-23,26,28
- Registration Cardi
- REMOTE CONTROL Feature.....26
- Remote Control12-13
- Remote Sensor28
- Remove or Add Channels from
 - Memory.....9
- REMOVE/ADD CHANNEL Menu9
- Review Programs Feature25
- REW Button.....12-13,15,17,26,28
- Safety Precautions.....i
- SAP Indicator.....22,29
- SAP, Recording.....22
- SEARCH Button12-13,17
- Searching, Picture.....15
- Sélectionner la langue11
- Sensor, Remote28
- SET VCR CLOCK Menu11
- Setting a Timer Recording24
- Setting Up the VCR.....8-11
- SETUP OPTIONS Menu 10,15,19,22,23,26
- SLOW Buttons.....12-13,17
- Slow Motion.....17
- SLP Speed20
- Solving Problems30-31
- SP Speed20
- Specifications27
- SPEED Button12-13,20-24
- Speeds, Recording.....20
- Startup8-11
- STEREO Indicator22,29
- Stereo Amplifier/Receiver
 - Connections.....7
- Stereo TV, Recording22
- Stop Action Pause18
- STOP Button12-13,17,20,22-25
- STOP+EJECT Button.14,20,22,23,24,26,28
- Stopping a Recording21
- Stopping Timer Programs.....24
- Table of Contents.....1
- Time and Date, Setting11
- Time Counter16
- TIMER Indicator21,24,29
- Timer Recording
 - Checking and Clearing.....25
 - Front VCR Line Input.....25
 - Recording.....24
 - Setting.....24
 - Stopping24
- Tracking, Automatic and Manual.....18
- TRACKING Button12, 14,17,18,28
- Trouble Checks.....30-31
- TUNING MODE Feature.....9
- Turn On VCR8
- TV•VCR Button10,12-13,14,20,28
- VCR Controls28
- VCR Indicator.....8,10,14,20,29
- VCR MAIN MENU.....9-11,15,19,22-26
- VCR, Cleaning27
- VCR, Turn On.....8
- VCR1/VCR2 Feature26
- VCRs Memory, Placing Channels.....9
- VCRs, Connecting for Tape Copying.....6
- VIDEO1 IN Jacks6,7,23,25,29
- VIDEO1 OUT Jacks3-7,29
- Warranty, Limited.....32
- Zero Search.....17

For your nearest Home
Entertainment Dealer
or Authorized Servicenter
call toll-free in the USA.

1-800-336-1900

Canadian Consumers –
Your toll free numbers are:

English: 1-800-522-0338

French: 1-800-522-0445

If you would like a copy of this manual in French, please follow the
instructions below:

Si un livret d'instructions en français n'est pas inclus avec votre appareil, vous
pouvez en obtenir un (indiquer le numéro de modèle, votre nom, et votre
adresse) en vous adressant à:

Thomson Consumer Electronics
Attention: Canadian Operations
P.O. Box 0944
Indianapolis, IN 46206-0944

If your VCR needs service, please contact your dealer or the nearest
Servicenter from the Yellow Pages. Please do not send any products
to the Indianapolis address listed in this manual or on the carton.
This will only add delays in service for your product.

 **THOMSON CONSUMER ELECTRONICS**
10330 North Meridian Street
Indianapolis, IN 46290-1024

©1995 Thomson Consumer Electronics, Inc.

Trademark(s)[®] Registered

Marca(s) Registrada(s)

Printed in Japan

Part Number 95-VR602HF-1

VQTS3190 (A)

Free Manuals Download Website

<http://myh66.com>

<http://usermanuals.us>

<http://www.somanuals.com>

<http://www.4manuals.cc>

<http://www.manual-lib.com>

<http://www.404manual.com>

<http://www.luxmanual.com>

<http://aubethermostatmanual.com>

Golf course search by state

<http://golfingnear.com>

Email search by domain

<http://emailbydomain.com>

Auto manuals search

<http://auto.somanuals.com>

TV manuals search

<http://tv.somanuals.com>