

RCA

video cassette recorder user's guide

VR636HF



IMPORTANT INFORMATION

WARNING

RISK OF ELECTRIC SHOCK DO NOT OPEN

To reduce the risk of electric shock, do not remove cover (or back). No user serviceable parts inside. Refer servicing to qualified service personnel.



This symbol indicates "dangerous voltage" inside the product that presents a risk of electric shock or personal injury.



This symbol indicates important instructions accompanying the product.

WARNING

To reduce the risk of fire or shock hazard, do not expose this product to rain or moisture.

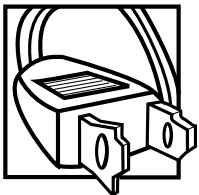

Caution: To reduce the risk of electric shock, match wide blade of plug to wide slot, fully insert.

Attention: Pour éviter les chocs électriques, introduire la lame la plus large de la fiche dans la borne correspondante de la prise et pousser jusqu'au fond.

Refer to the identification/rating label located on the back panel of your product for its proper operating voltage.

FCC Regulations state that unauthorized changes or modifications to this equipment may void the user's authority to operate it.

Cable TV Installer: This reminder is provided to call your attention to Article 820-40 of the National Electrical Code (Section 54 of the Canadian Electrical Code, Part 1) which provides guidelines for proper grounding and, in particular, specifies that the cable ground shall be connected to the grounding system of the building as close to the point of cable entry as practical.

Product Registration

Please fill out the product registration card and return it immediately. Returning this card allows us to contact you if needed.

Keep your sales receipt to obtain warranty parts and service and for proof of purchase. Attach it here and record the serial and model numbers in case you need them. The numbers are located on the back of the product.

Model No. **VR636HF** _____

Serial No. _____

Purchase Date: _____

Dealer/Address/Phone: _____

TABLE OF CONTENTS

First Things First	3
Setting up the VCR	7
Using the QuickSet Guide	8
Using the Menu to Set Up features	8
Language	8
Digital Satellite System Setup	9
Cable Box Setup	11
VCR Channels List	13
To Auto Channel Search	13
To Change the Signal Type	14
To Add or Remove Channels	14
Time and Date	15
Auto Clock Set Feature	15
Set the Time Zone	15
Set Daylight Saving	16
Set the Time and Date Manually	17
VCR Plus+ Channels	18
Additional SET-UP Features in the PREFERENCES menu	20
Remote VCR1/VCR2 Option	20
Auto Play	21
Auto TV/VCR	21
EnergySaver	22
Front Panel (VCR Display)	22
Preferred Tape Speed	22
VCR Basics	23
Remote Buttons	24
Component Buttons	24
VCR Function Buttons	24
TV Function Buttons	25
Playing a Tape	26
Automatic Rewind	27
Tape Eject	27
Recording	27
Check the Safety Tab	27
Recording	29
Recording features	30
Express Recording (XPR)	30
Timer Recording	31
Timer Recording with VCR Plus+	32
Setting Up the Channel List	32
Using VCR Plus+	32
Stopping a Timer Recording	34
Reviewing and Clearing Programs	34
Recording Broadcast Stereo TV or SAP (Second Audio Program)	34

TABLE OF CONTENTS

Recording Audio Only	35
Playing Back Audio Only	35
Using Two VCRs for Copying and Editing Tapes	36
Programming the Remote	37
About Programming the Remote	38
Programming the Remote to Control a TV	38
Operate the TV	38
TV Codes	39
Other Features	41
Picture Search Options	42
Forward and Reverse Search	42
Slow Motion	42
Commercial Scan (SEARCH Button)	42
Frame Advance	43
Index Search	43
Go-To Search	44
Tracking	44
Pro-Tect Plus™ Locking Feature	45
Time Counter	45
On-Screen Displays	46
Audio Set-Up Features	46
Reception	47
Tape Playback	47
Connections	49
Things to Know Before Connecting Components	49
Connecting Your VCR	50
Jacks and Cables	50
Choosing a VCR Connection	51
Advantages of Audio/Video Cable Connections	51
Don't Forget about the Auto TV/VCR Feature	51
TV with RF Jack only	52
TV with Audio/Video Jacks	53
TV with Audio/Video Jacks and Cable Box to Unscramble Pay Channels Only	54
TV with RF Jack and Digital Satellite Receiver	55
TV with Audio/Video Jacks and Digital Satellite Receiver	56
Appendix: Reference	57
Front Panel	58
Display Panel	59
Back Panel	60
Troubleshooting Tips	61
Limited Warranty	65
Specifications	66
Cleaning the VCR	66
Index	67

FIRST THINGS FIRST

HI, MY NAME IS LIZ...

and I wrote this User's Guide. It's my job to see that you have a rewarding user manual experience. You'll find that I've arranged this manual to clearly explain all of your VCR's features.

READ THE FIRST THREE SECTIONS

The first three sections of the manual introduce you to your VCR, and show you how to set the VCR up and use the on-screen menus. Reading these sections gives you the basic information you need to use your VCR.

WHAT'S LEFT?

The rest of the book highlights playback and recording information, contains a detailed connections section, and a reference section that includes troubleshooting tips, limited warranty, and index.

1 FIRST THINGS FIRST



2 SETTING UP THE VCR



3 VCR BASICS



4 RECORDING



5 PROGRAMMING THE REMOTE



6 OTHER FEATURES



7 CONNECTIONS

READ ME!

These note boxes give you tips for your new video cassette recorder.

FIRST THINGS FIRST

STEP 1: UNPACK WHAT'S IN THE BOX

The following items come packed in the box:

- VCR
- Remote control
- RF coaxial cable

STEP 2: INSTALL BATTERIES IN THE REMOTE CONTROL

Follow these steps whenever you need to install or change the batteries in your VCR remote.

1. Remove the cover of the battery compartment.
2. Place the batteries in the remote, matching the + and – ends of each battery to the diagram inside the compartment.
3. Replace the cover.

STEP 3: CONNECT YOUR VCR

If you connect your VCR to your home antenna or cable system and then to your TV, use the VCR's ANT. IN and RF OUT jacks for a good signal as shown.

If you have a TV with AUDIO/VIDEO jacks, use the jacks for a better connection. Refer to the *Connections* section, toward the back of the manual.

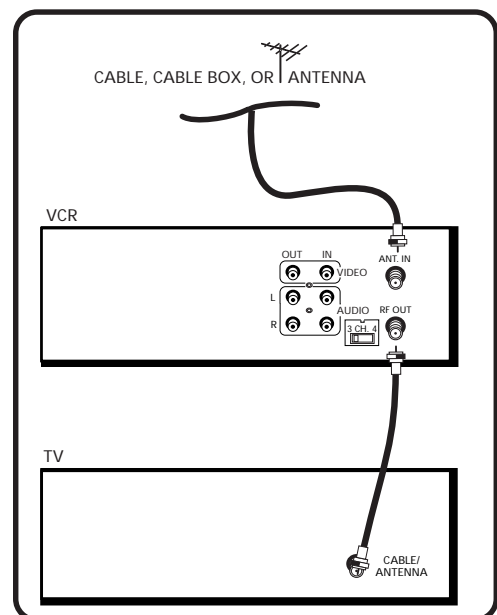

FIRST THINGS FIRST

STEP 4: PLUG IN THE VCR

Match the wide blade of the plug with the wide slot in the outlet. Be sure to insert the plug completely.

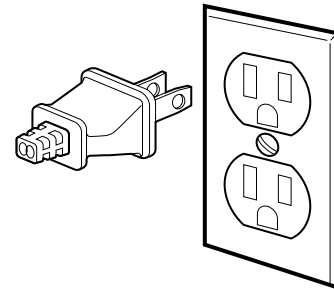

STEP 5: TUNE THE TV

Tune the TV to the VCR viewing channel. The VCR viewing channel is channel 3 or 4 or the TV's video input.

- If you connect your VCR using the ANTENNA connectors with RF coaxial cable, set the 3 CH. 4 switch to channel 3 or channel 4 — the channel you want to use on your TV.
- If you connect your VCR using the AUDIO/VIDEO jacks with audio/video cables, select the TV's video input to see the signal. See the *TV Owner's Manual*.

STEP 6: TURN ON THE VCR

The first time you connect your VCR and turn it on, a menu screen appears. This is the beginning of the QuickSet Guide which helps you to set up specific features of the VCR. If you choose not to use this Guide, you can set up each feature individually.

Go to the next step to understand how to move through and change items in the menu system.

STEP 7: ACCESS THE MENUS

The MENU and number buttons let you access, select and change menu items. For example, to change the Auto Play setting, you would do the following:

VCR Viewing Channel

When using the ANT. IN and RF OUT jacks to connect your VCR, tune your TV to channel 3 or 4.

When using the AUDIO/VIDEO jacks to connect your VCR, tune your TV to the TV's video input.

FIRST THINGS FIRST

1. Press MENU to display the VCR MAIN MENU.

```
VCR MAIN MENU
1 VCR Plus+
2 Timer Recordings
3 Time
4 Channels
5 Setup
6 Preferences
7 Audio
8 Language
0 Exit
```

2. Press 6 to display the PREFERENCES menu.

```
PREFERENCES
1 Remote Control: VCR1
2 Auto Play: ON
3 Auto TV/VCR: ON
4 EnergySaver: 2:00
5 Front Panel: AUTO
6 Tape Speed: SLP
0 Exit
```

3. Press 2 to switch Auto Play to ON or OFF.

```
PREFERENCES
1 Remote Control: VCR1
2 Auto Play: OFF
3 Auto TV/VCR: ON
4 EnergySaver: 2:00
5 Front Panel: AUTO
6 Tape Speed: SLP
0 Exit
```

See *Additional Set-Up Features* for detailed information about the Auto Play feature.

STEP 8: SET UP THE VCR

Once you understand how to move around through the menus, go to the next section to set up your VCR.

SETTING UP THE VCR

ON-SCREEN GUIDE AND ADDITIONAL SET-UP FEATURES

Below is a list of set-up features that you may want to set up before you begin using your VCR for the first time.

- Using QuickSet Guide
- Select a Language
- Set up for a Digital Satellite System
- Set up for a Cable Box
- Set up VCR Channel List (AUTO CHANNEL SEARCH)
- Set Time Zone and Daylight Savings (Auto Clock)
- Set the Time and Date Manually
- Set up VCR Plus+ Channels
- Set the Remote VCR1/VCR2 feature
- Set the Auto Play feature
- Set the Auto TV/VCR feature
- Set the EnergySaver feature
- Set the Front Panel feature
- Set the Preferred Tape Speed feature

1 FIRST THINGS FIRST



2 SETTING UP THE VCR



3 VCR BASICS



4 RECORDING



5 PROGRAMMING THE REMOTE



6 OTHER FEATURES



7 CONNECTIONS

SETTING UP THE VCR

USING THE QUICKSET GUIDE

The QuickSet Guide is an automated procedure that helps you set up your VCR. The first time you turn on your VCR, the first screen of the Guide appears.

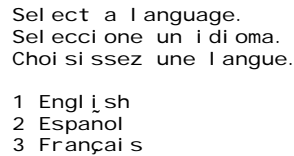

Select a language.
Selecione un idioma.
Choisissez une langue.

- 1 English
- 2 Español
- 3 Français

Just follow the step-by-step procedures until setup is complete. Some of the feature options may not apply to your VCR configuration.

If the menu does not appear:

- Make sure TV is tuned to the same channel as the 3 CH.4 switch or TV's video line input.
- Make sure VCR indicator is on in the VCR display if you connected your VCR using the ANT. IN and RF OUT jacks.
- Check your connections.

If you choose to set up the VCR options individually, then go to the next section.

If you ever need to manually enter setup.

1. Press MENU to display the VCR MAIN MENU.
2. Press 5 to display the Setup menu.

USING THE MENU TO SET UP FEATURES

You can set up features by using the menu system. Each feature that appears in the QuickSet Guide is explained in this section as well as a few others you may want to set up before you begin using your VCR.

LANGUAGE

Select your preferred language, and the on-screen displays will appear in that language.

On-Screen Menus

Not all the VCR screens are shown in this manual when explaining the features.

SETTING UP THE VCR

1. Press MENU to display the VCR MAIN MENU.

```
VCR MAIN MENU
1 VCR Plus+
2 Timer Recordings
3 Time
4 Channels
5 Setup
6 Preferences
7 Audio
8 Language
0 Exit
```

2. Press 8 to select the LANGUAGE menu.

```
LANGUAGE
Select a language.
1>English
2 Español
3 Français
Press MENU to continue
```

3. Select English, Español (Spanish), or Français (French).

DIGITAL SATELLITE SYSTEM SETUP

With this setup, the VCR turns on an RCA, ProScan, or GE satellite receiver and tunes it to the desired channel at the start time of a timer recording. For other brands, the VCR tunes the receiver to the desired channel only if the receiver is turned on. Position the satellite receiver above the VCR as shown in the *Connections* section.

1. Press MENU to display the VCR MAIN MENU.

```
VCR MAIN MENU
1 VCR Plus+
2 Timer Recordings
3 Time
4 Channels
5 Setup
6 Preferences
7 Audio
8 Language
0 Exit
```

2. Press 4 to display CHANNELS menu.

```
CHANNELS
1 Auto Channel Search
2 Add/Remove Channels
3 Signal Type: CABLE
4 VCR Plus+ Channel List
5 Cable Box Setup
6 DSS Setup
0 Exit
```

SETTING UP THE VCR

3. Press 6 to select DSS SETUP.

DSS SETUP

On what channel does the VCR receive signals from the DSS receiver?

--

Enter 01-125 or INPUT
Press MENU to cancel

4. Enter the output channel of your satellite receiver, usually 03, 04, or video line input and press MENU. The VCR confirms that it receives all DSS signals on the specified channel.

DSS SETUP

The VCR will now receive all signals from the DSS receiver on channel 03.

Press MENU to continue

5. Press MENU and enter the code for your Digital Satellite Receiver from the Satellite Receiver Code List.

DSS SETUP

Enter the code for your DSS receiver from the list in your User's Manual

--

Press MENU to cancel

6. Turn on your satellite receiver and tune it to channel 100 and then press MENU. Follow the on-screen directions.

DSS SETUP

Please turn on your DSS Receiver and tune it to channel 100.

Press MENU to continue

Once you have completed the setup, the VCR confirms the DSS Setup is completed or canceled.

Satellite Receiver Codes

GE	00
Panasonic	01
ProScan	00
RCA	00
Toshiba	02
Sony	03

This VCR may not control all models of the brands that are shown.

SETTING UP THE VCR

CABLE BOX SETUP

This setup applies only when all channels are received through the cable box. There are two steps:

- The first sets up the VCR for the output channel of the cable box signal.
- The second sets up the VCR for a remote-controllable cable box so the VCR can control the cable box by changing channels for timer or VCR Plus+ recordings. Position the remote-controllable cable box above the VCR as shown in *the Connections* section.

1. Press MENU to display the VCR MAIN MENU.

```
VCR MAIN MENU
1 VCR Plus+
2 Timer Recordings
3 Time
4 Channels
5 Setup
6 Preferences
7 Audio
8 Language
0 Exit
```

2. Press 4 to display the CHANNELS menu.

```
CHANNELS
1 Auto Channel Search
2 Add/Remove Channels
3 Signal Type: CABLE
4 VCR Plus+ Channel List
5 Cable Box Setup
6 DSS Setup
0 Exit
```

3. Press 5 to display CABLE BOX SETUP. Then select one of the three choices.

```
CABLE BOX SETUP
Do you use your cable
box to receive ALL
channels or only SOME
channels?
1 ALL channels
2 Only SOME channels
3 Cancel setup
```

Cable Box Setup

ALL CHANNELS: enter two numbers for output channel of your cable box or press INPUT.

ONLY SOME CHANNELS: if you only use the cable box to tune premium channels.

CANCEL SETUP: select to cancel.

SETTING UP THE VCR

4. If you selected ALL CHANNELS, enter the output channel of your cable box, usually 03, 04, or video line input and press MENU.

CABLE BOX SETUP
On what channel does the VCR receive signals from the cable box? (usually 3, 4, or Video)

04

Press CLEAR to correct
Press MENU to continue

CABLE BOX SETUP
The VCR will now receive all signals from the cable box on channel 04.

Press MENU to continue

Once you complete the setup, the VCR confirms that the VCR will now receive all signals on the designated channel.

5. Press MENU and select whether your cable box is remote controllable.

CABLE BOX SETUP
Can your cable box be operated with a remote control?

1 Yes
2 No

6. If your cable box is remote-controllable, turn it on and tune it to channel 2. Press MENU to continue.

CABLE BOX SETUP
Please turn on your Cable Box and tune it to channel 2.

Press MENU to continue

7. Enter the code for your cable box from the cable box code list.

CABLE BOX SETUP
Enter the code for your cable box from the list in your User's Manual.

--

Press MENU to cancel

Cable Box Codes

ABC	22,46
Anvision	07,08
Cablestar	07,08
Eagle	08
Eastern International	02
General Instrument	04,05, 15,23,24,25,30,36,46
Hamlin	12,13,34,48
Hitachi	37,43,46
Jerrold	04,05,15,23,24, 25,30,36,45,46,47
Macom	37,43
Magnavox	07,08,19,21, 26,28,29,32,33,40,41
NSC	09
Oak	01,16,38
Oak Sigma	16
Panasonic	03,27,39
Philips	07,08,19,21, 26,28,29,32,33,40,41
Pioneer	18,20,44
Randtek	07,08
RCA	27
Regal	12,13
Regency	02,33
Samsung	44
Scientific Atlanta	03,22,35
Signature	46
Sprucer	27
Starcom	46
Sylvania	11
Teknika	06
Texscan	10,11
Tocom	17,21,49,50
Unika	31,32,41
Viewstar	07,08,19,21, 26,28,29,32,33,40,41
Warner Amex	44
Zenith	14,42

This VCR may not control all models of the brands that are shown.

SETTING UP THE VCR

8. Select one of the choices and follow the on-screen instructions.

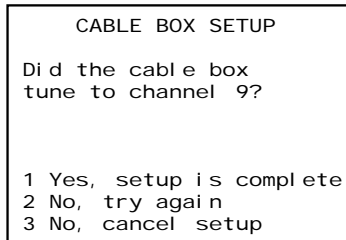

Once you have completed the setup, the VCR confirms the CABLE BOX SETUP is completed or canceled.

VCR CHANNELS LIST

If you use a cable box for *all channels*, this step is not necessary. Your VCR may come with a channel list preset at the factory. Even though your VCR may come with a list, it's possible that you may want to add or eliminate some channels depending on whether they are active.

To Auto Channel Search

1. Press MENU to display the VCR MAIN MENU.

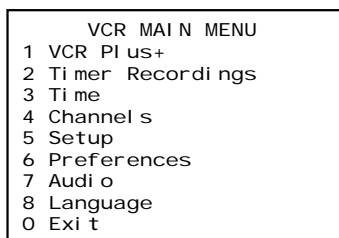

2. Press 4 to display the CHANNELS menu.

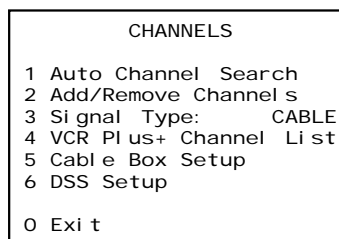

SETTING UP THE VCR

- Press 1 to display the AUTO CHANNEL SEARCH menu.

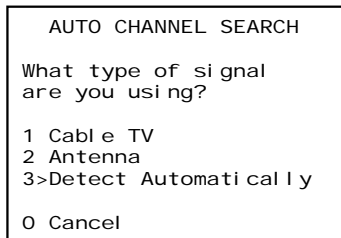

- Select one of the three AUTO CHANNEL SEARCH options.

Choices one and two are self-explanatory. If you choose Detect Automatically, the VCR automatically detects which signal system you have attached to your VCR.

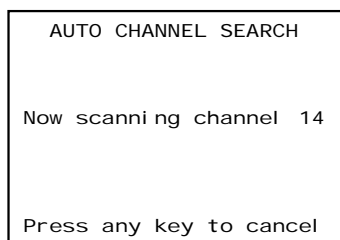

The VCR begins scanning for the available channels--this takes about one to two minutes. The lowest channel is tuned once the search is complete. Now pressing CHAN up or down should only select the active channels.

To Change the Signal Type

- Press MENU to display the VCR MAIN MENU.
- Press 4 to display the CHANNELS menu.
- Press 3 to change the Signal Type between CABLE and ANTENNA.

To Add or Remove Channels

You may want to add or remove channels after you Auto Channel Search, especially if some of the channels have weak signals or you don't want to watch them.

- Press MENU to display the VCR MAIN MENU.
- Press 4 to display the CHANNELS menu.

Auto Channel Search

Use the Auto Channel Search feature to place all available channels in memory.

If you ever change cable or antenna signals, you may need to Auto Channel Search again.

Detect Automatically

A strong cable or antenna signal in your area may cause Auto Detect to mis-detect. If this should happen, select 1 or 2 for the system you have.

SETTING UP THE VCR

3. Press 2 to display the ADD/REMOVE CHANNELS screen. Use CHAN up or down or number buttons to go to the channels you want to remove or add.

ADD/REMOVE CHANNELS

Channel 115
is presently ADDED

Press CLEAR to remove
Press MENU to exit

ADD/REMOVE CHANNELS

Channel 115
is presently REMOVED

Press INFO to add
Press MENU to exit

TIME AND DATE

The VCR gives you two ways to set the time and date. The Auto Clock feature which enables the VCR to update the clock each time you turn off the VCR. The Auto Clock feature is advantageous because it updates the time for you automatically. The second way is entering the time and date manually into the menu system.

AUTO CLOCK SET FEATURE

The Auto Clock feature is set to ON at the factory. In the ON setting, the VCR looks for a channel carrying XDS (Extended Data Services) information and updates the clock using the Coordinated Universal Time. There are certain steps that are required, such as Auto Channel Search, setting the Time Zone, and setting the Daylight Savings feature, before the Auto Clock feature works.

Set the Time Zone

1. Press MENU to display the VCR MAIN MENU.

VCR MAIN MENU

- 1 VCR Plus+
- 2 Timer Recordings
- 3 Time
- 4 Channels
- 5 Setup
- 6 Preferences
- 7 Audio
- 8 Language
- 0 Exit

Selecting Channels

The CHANNEL up and down buttons access those channels active in your VCR channel list.

You can still access channels not in the channel list by using the number buttons on the remote.

Auto Clock Info

With a cable box, the VCR will not reset the clock after a power outage unless the cable box is set to the channel carrying the broadcast signal.

If AUTO CLOCK SET is unsuccessful, try tuning the VCR (or cable box) to a channel carrying the XDS information (usually PBS), then turn the VCR off.

If the time does not set within 10 minutes, set the time and date manually through the menu items.

Check local cable system or TV stations for availability of channels with XDS.

SETTING UP THE VCR

2. Press 3 to display TIME menu.

```
TIME
1 Set Time and Date
2 Auto Clock Set: ON
3 Set Time Zone
4 Set Daylight Savings

XDS Time Data was
found on channel 20.

0 Exit
```

3. Press 3 to display the SET TIME ZONE screen.

```
SET TIME ZONE
What is your Time Zone?
1 Eastern
2 Central
3 Mountain
4 Pacific
5 Alaska
6 Hawaii
7▶Automatic
Press MENU to continue
```

4. Select your time zone.

If you select Automatic for your time zone, the VCR sets the clock using the first Coordinated Universal Time information it finds. If the time is not correct, select another time zone or set the time and date through the menu system.

Set Daylight Savings

1. Press MENU to display the VCR MAIN MENU.
2. Press 3 to display the TIME menu.
3. Press 4 to display the SET DAYLIGHT SAVINGS menu.

```
SET DAYLIGHT SAVINGS

Does your area observe
Daylight Savings Time
from April to October?

1 Yes, DST is observed
2 No
3▶Automatic
Press MENU to continue
```

4. Select one of the options.
 - DST is the acronym for Daylight Savings Time.
 - If you choose AUTOMATIC, the VCR sets the clock using the DST information broadcast in the signal (channel).

Spring forward; Fall backward

In the Spring, daylight-saving time begins on the first Sunday in April. Because the clock automatically changes from 2:00 AM to 3:00 AM (forward one hour), remember to include the extra hour for timer recording falling within this time frame.

In the Autumn, daylight-saving time ends on the last Sunday in October. The VCR clock automatically changes from 2:00 AM to 1:00 AM (back one hour). Therefore, it can affect your recording length.

SETTING UP THE VCR

SET THE TIME AND DATE MANUALLY

If the AUTO CLOCK SET was unsuccessful, set the clock through the menu option. The AUTO CLOCK SET feature is set to OFF automatically when you set the clock this way.

1. Press MENU to display the VCR MAIN MENU.

```
VCR MAIN MENU
1 VCR Plus+
2 Timer Recordings
3 Time
4 Channels
5 Setup
6 Preferences
7 Audio
8 Language
0 Exit
```

2. Press 3 to display the TIME menu.

```
TIME
1 Set Time and Date
2 Auto Clock Set: ON
3 Set Time Zone
4 Set Daylight Savings

XDS Time Data was
not found.

0 Exit
```

3. Press 1 to display the SET TIME AND DATE menu.

```
SET TIME AND DATE

Time --:--
(hh:mm)

Date --/--/--

Press MENU to cancel
```

4. Enter the data using the number buttons. Press 0 before single-digit numbers and follow the on-screen directions.

```
SET TIME AND DATE

Time 12:34 PM

Date 11/18/98 Wednesday

Press CLEAR to correct
Press MENU to set
```

Time/Date Display

Pressing INFO on the remote displays the time and date on the screen.

SETTING UP THE VCR

VCR PLUS+ CHANNELS

Using VCR Plus+ can make programming timer recordings for cable or off-air antenna easier, but you have to put in a little time right now to set up a channel list. A worksheet and abbreviated codes for typical cable services in the U.S. and Canada are provided.

1. Press MENU to display the VCR MAIN MENU.

```
VCR MAIN MENU
1 VCR Plus+
2 Timer Recordings
3 Time
4 Channels
5 Setup
6 Preferences
7 Audio
8 Language
0 Exit
```

2. Press 4 to display the CHANNELS menu.

```
CHANNELS
1 Auto Channel Search
2 Add/Remove Channels
3 Signal Type: CABLE
4 VCR Plus+ Channel List
5 Cable Box Setup
6 DSS Setup
0 Exit
```

3. Press 4 to display the VCR Plus+ Channel List screen.

```
VCR+ Channel My Channel
5 -- --
4 -- --
3 -> -> -> --
2 -- --
1 -- --

Use CH+/- to select
Press 0-9 to change
Press MENU to save
```

4. Enter the data following the on-screen directions using your worksheet.

```
VCR+ Channel My Channel
5 46
4 --
3 -> -> -> 23
2 --
1 --

Use CH+/- to select
Press 0-9 to change
Press MENU to save
```

Two-Digit VCR Plus+ Channel Numbers for Cable TV (USA List)

35	American Movie Classics
39	Arts &-Entertainment
57	Black Entertainment
54	Bravo
42	Cable News Network
45	Cinemax
98	Cinemax 2
37	The Discovery Channel
53	The Disney Channel
63	Entertainment Television
34	ESPN Sports Network
47	The Family Channel
33	Home Box Office
95	Home Box Office 2
96	Home Box Office 3
51	The Learning Channel
46	Lifetime
58	The Movie Channel
48	Music Television
49	The Nashville Network
38	Nickelodeon
64	Nostalgia Television
99	Quality Value Cable
41	Showtime
97	Showtime 2
59	Sports Channel
52	Turner Network Television
44	USA-Network
62	Video Hits 1
93	Viewer's Choice 1
94	Viewer's Choice 2
55	WGN Chicago
43	WTBS Atlanta
60	WWOR-New York

See next page for Canadian List

VCR Plus+ Channel List

Refer to your local television list for a complete VCR Plus+ channel list for your viewing area or contact your cable company. Using the list may save you some time.

SETTING UP THE VCR

ADDITIONAL SET-UP FEATURES IN THE PREFERENCES MENU

The features in this section are all accessed through the PREFERENCES menu.

1. Press MENU to display the VCR MAIN MENU.

```
VCR MAIN MENU
1 VCR Plus+
2 Timer Recordings
3 Time
4 Channels
5 Setup
6 Preferences
7 Audio
8 Language
0 Exit
```

2. Press 6 to display the PREFERENCES menu.

```
PREFERENCES
1 Remote Control: VCR1
2 Auto Play: ON
3 Auto TV/VCR: ON
4 EnergySaver: 2:00
5 Front Panel: AUTO
6 Tape Speed: SLP
0 Exit
```

Now you are ready to select an item from the menu to set up.

REMOTE VCR1/VCR2 OPTION

If you own a compatible RCA, GE, or ProScan remote that has a VCR2, VCR2•LD, or VCR2•DVD button, this feature allows you to set this VCR to respond to that button.

Press 1 to select the Remote Control item. Then press the VCR2, VCR2•LD, or VCR2•DVD button to change.

```
PREFERENCES
(PRESS VCR2 TO CHANGE)
2 Auto Play: ON
3 Auto TV/VCR: ON
4 EnergySaver: 2:00
5 Front Panel: AUTO
6 Tape Speed: SLP
0 Exit
```

```
PREFERENCES
1 Remote Control: VCR2
2 Auto Play: ON
3 Auto TV/VCR: ON
4 EnergySaver: 2:00
5 Front Panel: AUTO
6 Tape Speed: SLP
0 Exit
```

Remote Control Option

Changing the remote option to VCR2 disables the remote that came with your VCR.

SETTING UP THE VCR

The VCR will only respond to the compatible remote's VCR2, VCR2•LD, or VCR2•DVD button. If you change the remote setting to VCR2, the remote that came with your VCR will no longer control it.

Use the compatible remote to change the remote setting back to VCR1. Display the PREFERENCES menu, press 1, and then press VCR on the VCR's remote.

AUTO PLAY

This feature allows the VCR to automatically start playing when you insert a tape with the safety tab removed. Press 2 to switch between ON or OFF.

- Select ON if you want a tape with its safety tab removed to start playing automatically when the tape is inserted.
- Select OFF if you *do not* want a tape with its safety tab removed to start playing automatically.

AUTO TV/VCR

This feature controls whether the TV/VCR switch changes automatically to the VCR mode. Press 3 to switch between ON and OFF.

- Select ON if you want the VCR to switch to the VCR mode when the VCR is turned on or a cassette is inserted. *This only applies if you connect the ANT. IN and RF OUT jacks of your VCR and TV and watch your VCR on channel 3 or 4 of your TV.*
- Select OFF if you want the VCR to remain in the TV mode. This is useful if you watch your VCR on the TV's video input and you don't want your antenna/cable signal interrupted by the VCR. Refer to the *Connections* section, toward the back of the manual.

Auto TV/VCR

Pressing TV•VCR will still switch between the VCR and TV mode.

VCR mode: VCR indicator in the display panel lights.

TV mode: VCR indicator turns off.

SETTING UP THE VCR

ENERGYSAVER

By default, this VCR automatically turns off after two hours of inactivity. Press 4 to change the time delay, or to disable the feature.

- OFF: The VCR will remain turned on until you shut it off.
- 1:00, 2:00, or 3:00: The VCR turns off after one, two, or three hours of inactivity.

Thirty seconds before shutting off, the VCR will warn you with a screen reading, "The VCR will turn off in 30 seconds. Press any key to cancel."

If you use the VCR's tuner instead of your TV to tune channels, you may want to turn this feature off.

FRONT PANEL (VCR DISPLAY)

You can change the brightness level of the fluorescent display panel on the front of the VCR. Press 5 to switch between the options.

- AUTO brightens the display when the VCR is on and dims the display when the VCR is off.
- BRIGHT keeps the display bright.
- DIM keeps the display at a low brightness level.

PREFERRED TAPE SPEED

You can set a preferred tape speed that is established each time the VCR is turned on and as the initial setting for timer programming. Press 6 to switch between the options.

- SP sets the preferred recording speed to SP.
- SLP sets the preferred recording speed to SLP.

The preferred setting can be overridden using the SPEED button on the remote.

Tape Speeds

SP (Standard Play)

Gives the best quality recording, but fewer programs can be recorded on the tape. Special effects such as pause, slow motion, picture search, and frame advance work well when you play back tapes recorded in this speed.

LP (Long Play)

Your VCR is capable of playing back tapes recorded in LP. You cannot record in the LP speed.

SLP (Super Long Play)

Gives three times the recording time of tapes recorded in SP. Special effects such as pause, slow motion, picture search, and frame advance work well when you play back tapes recorded in this speed.

	Recording Time	
Cassette	SP	SLP
T-120	2Hr	6Hr
T-160	2Hr 40Min	8Hr

VCR BASICS

LEARN THE BASICS TO GET YOU STARTED

These VCR basics should be enough for you to begin enjoying your VCR. Learning the remote control functions, playing a recorded tape, and recording a program should do just that.

However, there are other features that enhance the enjoyment of your VCR, but they aren't necessary to get you started. If you want to learn more about your VCR, just keep reading.

1 FIRST THINGS FIRST



2 SETTING UP THE VCR



3 VCR BASICS



4 RECORDING



5 PROGRAMMING THE REMOTE



6 OTHER FEATURES



7 CONNECTIONS

VCR Basics tells you what you need to know in order to watch a movie or tape your favorite show.

VCR BASICS

REMOTE BUTTONS

The remote control is capable of controlling your VCR and many brands of televisions. If you have an RCA, ProScan, or GE TV, you may be able to control it without having to program the remote.

COMPONENT BUTTONS

OFF Turns off VCR when remote is set to control the VCR. Also turns some compatible components on and off.

TV Turns on a compatible RCA, ProScan, or GE TV and sets the remote to control the TV. Also used with the OFF button to turn on a different brand of TV (if programmed) and sets the remote to control the TV.

VCR Turns on a compatible RCA, ProScan, or GE VCR and sets the remote to control the VCR.

VCR FUNCTION BUTTONS

CHAN Up or Down Selects next higher or lower channel in the VCR's channel memory.

CLEAR Resets time counter to 0:00:00. Allows you to change entries when setting the clock or a timer recording.

F.ADV Lets you view one frame with each press of the button when tape is in pause.

FORWARD Fast forwards the tape when the VCR is stopped. Searches forward through a tape during playback. Starts slow motion during play-pause and increases slow-motion speed.

GO BACK Switches between two channels. Select one channel and then select another using the number buttons. Press GO BACK to switch between the two channels.

INFO Shows the status displays on the TV screen.

INPUT Selects between the line input and the VCR's tuner. Line input refers to the signal coming from the component connected to the AUDIO/VIDEO IN jacks.

MENU Brings up VCR MAIN MENU on the TV screen.

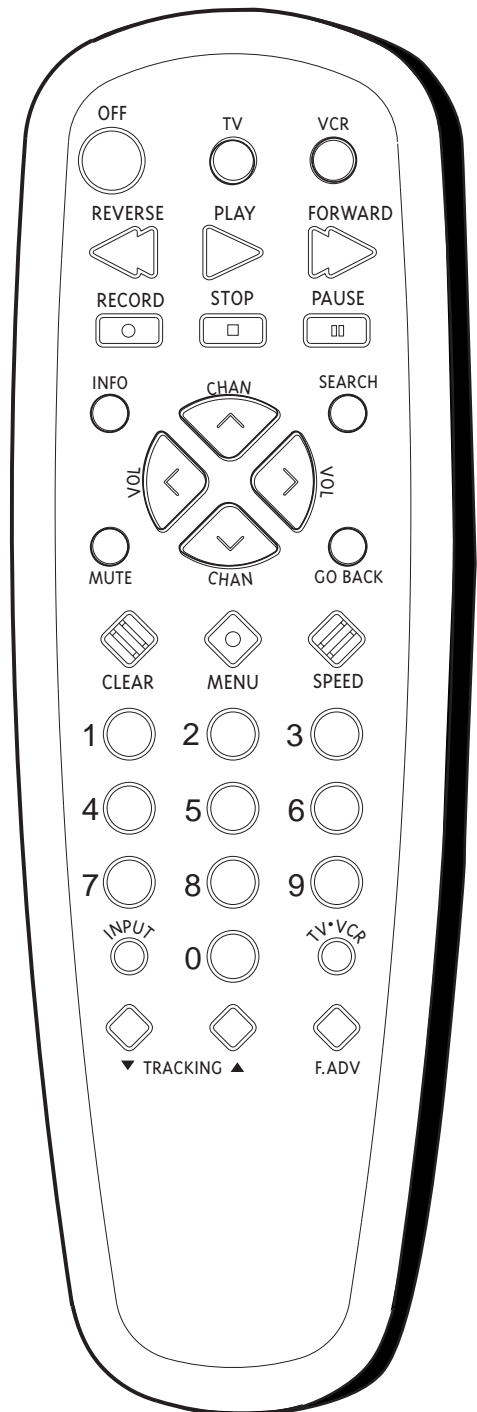

VCR BASICS

Numbers (0 through 9) Select a channel up to 99 by pressing two numbers. Select a cable channel over 99 by pressing and holding 1 until 1 -- appears on the screen. Then press the other two numbers.

OFF Turns off the VCR when the remote is set to control the VCR.

PAUSE Pauses playback or recording. Press PAUSE again to return to playback or recording.

PLAY Plays a tape.

RECORD Starts VCR recording. Also used for express recording.

REVERSE Rewinds the tape when the VCR is stopped. Searches backward through a tape during playback. Starts slow motion during play-pause and decreases slow-motion speed.

SEARCH Displays Index and Go-To Search menus on TV screen when VCR is stopped. Advances the tape 30 seconds of recorded material during playback. Each press advances the tape an additional 30 seconds up to five minutes.

SPEED Selects a recording speed (SP or SLP).

STOP Stops the current VCR function such as record, playback, rewind, or fast forward.

TRACKING Up or Down Lets you manually reduce the streaks that may appear on the picture during play, slow motion, or pause. Reduces picture "jitter" during stop-action playback.

TV•VCR Switches the picture signal so that it either comes from the VCR or cable/antenna system.

TV FUNCTION BUTTONS

CHAN Up or Down Selects next higher or lower channel in the TV's channel memory.

CLEAR Removes menus or status displays from the screen.

GO BACK Switches between two channels. Select one channel and then select another using the number buttons. Press GO BACK to switch between the two channels.

INFO Shows the TV's status displays on the TV screen.

MUTE Reduces volume to minimum level.

TV Buttons

The TV buttons may not control all features of all models of RCA, ProScan and GE TVs.

VCR BASICS

Numbers (0 through 9) Select a channel up to 99 by pressing two numbers. Select a cable channel over 99 by pressing and holding 1 until 1 -- appears on the screen. Then press the other two numbers.

OFF Turns a compatible TV off and on.

VOL Up and Down Raises and lowers sound of TV.

PLAYING A TAPE

1. Tune the TV to your VCR viewing channel (3, 4, or TV's video input).
2. Insert a tape in the VCR.

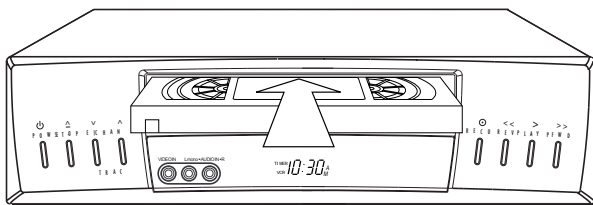

If the Auto Play feature is set to ON, the tape automatically begins playback (if the safety tab on the cassette is removed).

- Press FWD or REV (FORWARD or REVERSE on remote) to position the tape.
- Press PLAY•PAUSE (if necessary) on the VCR (PLAY on remote) to begin tape play.
- Press PLAY•PAUSE (PAUSE on remote) for stop action.
- Press TRACKING up or down to remove any streaks from the picture, if necessary.
- Press STOP•EJECT on VCR (STOP on remote) to stop playback.

Pause

If you pause, the VCR automatically switches from pause to stop after a few minutes to reduce tape wear.

Automatic Tracking

The VCR has automatic tracking which adjusts the picture when playing back a tape recorded on another VCR. Automatic tracking is turned on whenever a tape is inserted or the VCR's power is turned on.

VCR BASICS

AUTOMATIC REWIND

The VCR automatically rewinds the tape if it reaches the end of the tape during playback. While rewinding, you can press POWER and the VCR will turn off after rewinding.

TAPE EJECT

Press STOP•EJECT on the VCR (STOP on remote) when it is stopped to eject the tape.

RECORDING

If you want to record something that you're watching, you can use basic recording.

1. Set the tape speed by pressing the SPEED button on the remote (see "Preferred Tape Speed" in *Setting Up the VCR* section for information about tape speed settings).
2. Press the RECORD button to begin recording.
3. Press STOP to stop recording.

If you just want to pause the recording for a short time (such as during a commercial), press PAUSE instead of STOP.

CHECK THE SAFETY TAB

No matter which recording option you use, you need to make sure there is a tape in the VCR, and that the tape's safety tab is in place. You cannot record on a tape with the safety tab removed.



If the safety tab is removed and you want to record over it, simply cover the hole with vinyl tape.

RECORDING

SEVERAL RECORDING OPTIONS

Now that you've gone through the necessary steps to operate your VCR, I'll explain the different recording features that are available to suit your needs.

Recording Features:

- Recording (explained in *VCR Basics* section)
- Express Recording
- Timer Recording
- Timer Recording with VCR Plus+
- Broadcast Stereo or Second Audio Program (SAP)
- Audio Only Recording
- Copying and Editing Tapes

1 FIRST THINGS FIRST



2 SETTING UP THE VCR



3 VCR BASICS



4 RECORDING



5 PROGRAMMING THE REMOTE



6 OTHER FEATURES



7 CONNECTIONS

RECORDING

RECORDING FEATURES

There are four ways to record programs:

- **Recording** lets you press one button to start recording a program. (See *VCR Basics* section.)
- **Express Recording** lets you start recording a program you are watching, and then set the VCR to automatically stop recording after a designated period of time.
- **Timer Recording** lets you program the VCR to automatically start and stop recording at a predetermined time.
- **Timer Recording with VCR Plus+** lets you program the VCR just by entering a PlusCode number found in TV guides.

EXPRESS RECORDING (XPR)

Use express recording when you want to quickly record the remaining portion of the program you are watching.

1. Set the tape speed by pressing the SPEED button on the remote.
2. Press the RECORD button to begin recording.
3. Repeatedly press the RECORD button to set up the recording duration.

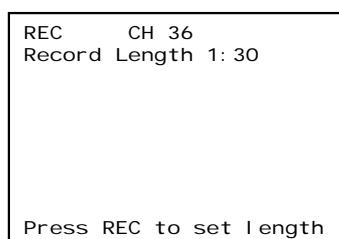
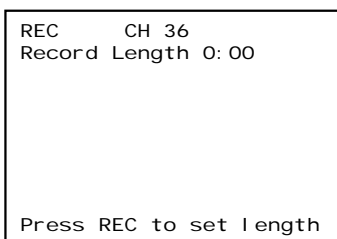

Each time you press the RECORD button, you increase the recording time (up to 4 hours).

The VCR continues to record for the amount of time you indicate, and then automatically turns off.

To stop an express recording, press and hold STOP for a few seconds.

Express Recording

Express recording is a great way to tape the last quarter of the game, or the last part of a movie when you have to leave.

RECORDING

TIMER RECORDING

You can set up as many as eight timer recording programs.

1. Press MENU to display the VCR MAIN MENU.

```
VCR MAIN MENU
1 VCR Plus+
2 Timer Recordings
3 Time
4 Channels
5 Setup
6 Preferences
7 Audio
8 Language
0 Exit
```

2. Press 2 to display the TIMER RECORDINGS menu.

```
TIMER RECORDINGS
1 Create a New Program
2 Review Existing Progs.
3 Use VCR PLUS+ Code

0 Exit
```

3. Select 1 to Create a New Program.

```
How often should this
program record?
1 One time
2 Daily (every day)
3 Weekdays (M-F)
4 Weekly (once per week)
0 Cancel
```

4. Select how often you want the program to record.

```
Program 1 (One time)
Channel  --
Start Time  --:--
End Time  --:--
Start Date --/--/--
Tape Speed SLP

Press MENU to cancel
```

5. Enter the data for the program with the number buttons.

The data includes the channel number (press INPUT to select the line input), start time including AM or PM, and end time. The start date is automatically entered based on the VCR clock. The date and/or speed can be changed when flashing.

Timer Recording Information

Clock must be set correctly.

Insert a tape with the safety tab in place and enough tape to record the program.

PROGRAMS OVERLAP appears if you have entered two programs where the times overlap.

The TIMER indicator appears in the display when you turn off the VCR and a timer recording has been set. It flashes if there is no tape in the VCR.

If your cable box or satellite receiver can not be controlled by the VCR, turn it on and tune it to the channel you want to record before the recording is to begin. The VCR channel should be set to the box's output channel, usually Channel 3 or 4.

RECORDING

- Review the information to make sure it is correct, and then press MENU to save.

Program 1 (One time) Channel 104 Cable Start Time 12:00 AM End Time 01:30 AM Start Date 11/18/98 Wed Tape Speed SLP Press CLEAR to correct Press MENU for next prog	Program 1 has been saved Remember to insert a recordable tape and turn the VCR off before the program start time. Press MENU to continue
--	--

TIMER RECORDING WITH VCR PLUS+

You can use VCR Plus+ to simplify timer programming by entering the TV show's PlusCode number found in most TV and cable listings.

Setting Up the Channel List

If you did not set up the VCR Plus+ channel list, you can do it now.

- Display the CHANNELS menu from the VCR MAIN MENU.
- Display the VCR Plus+ Channel List menu.
- Go to *Setting Up Your VCR* if you need more information on setting up your VCR Plus+ channel list.

VCR MAIN MENU 1 VCR Plus+ 2 Timer Recordings 3 Time 4 Channels	CHANNELS 1 Auto Channel Search 2 Add/Remove Channels 3 Signal Type: CABLE 4 VCR Plus+ Channel List	VCR+ Channel My Channel 5 46 4 -- 3 -> -> -> 23 2 -- 1 -- Use CH+/- to select Press 0-9 to change Press MENU to save
--	--	--

Using VCR Plus+

- Press MENU to bring up the VCR MAIN MENU.

VCR MAIN MENU 1 VCR Plus+ 2 Timer Recordings 3 Time 4 Channels 5 Setup 6 Preferences 7 Audio 8 Language 0 Exit

- Press 1 to display the VCR PLUS+ menu.

VCR PLUS+ Enter PlusCode Number (from TV listing) - Press MENU to cancel
--

If your cable box can not be controlled by the VCR, turn it on and tune it to the channel you want to record before the recording is to begin.

If, after perform cbsetup, i

If your cable box is not compatible, you must turn on cable box and tune it to the channel you want to record in order for a vcr plus recording.

if, after perform cbsetup, if cable box ISS compatible, turn on cable box and leave on for vcrplus recording.

RECORDING

3. Enter the VCR PlusCode shown in your local television programming guide.

```
VCR PLUS+
Enter PlusCode Number
  (from TV listing)
  128768

Press CLEAR to correct
Press MENU when done
```

4. Press MENU to enter the VCR PlusCode number.

```
How often should this
program record?

1 One time
2 Daily (every day)
3 Weekdays (M-F)
4 Weekly (once per week)

0 Cancel
```

5. Indicate how often you want the program to be recorded.

```
Program 1 (One time)

Channel      03 Cable
Start Time   08:00 PM
End Time     09:30 PM
Start Date   11/18/98 Wed
Tape Speed   SLP

Press CLEAR to adjust
Press MENU to save
```

6. Change the speed with the SPEED button on the remote or the program end time with the CLEAR button on the remote (if necessary).

Changing the end time comes in handy when you are recording a program, such as a sporting event, that may exceed the scheduled broadcast time.

7. Press MENU to save the program.

```
Program 1 has been saved

Remember to insert a
recordable tape and
turn the VCR off before
the program start time.

Press MENU to continue
```

VCR Plus+ Recording

Clock must be set correctly.

Insert a tape with the safety tab in place and enough tape to record the program.

The **TIMER** indicator appears in the display when you turn off the VCR and a timer recording has been set. It flashes if there is no tape in the VCR.

PROGRAMS OVERLAP appears if you have entered two programs where the times overlap.

UNRECOGNIZED NUMBER... PLEASE RE-ENTER appears when the VCR does not recognize the PlusCode number.

If your cable box can be controlled by the VCR, turn it on and leave it on before the recording is to begin.

If your cable box cannot be controlled by the VCR, turn it on and tune it to the channel you want to record before the recording is to begin.

Timer recordings will not be lost in the event of an extended power outage.

RECORDING

STOPPING A TIMER RECORDING

To stop or cancel a timer recording in progress (even an express recording):

- Press and hold the STOP button for a few seconds.

REVIEWING AND CLEARING PROGRAMS

To review programs that you have already set up:

1. Press 2 when the VCR MAIN MENU is displayed to display the TIMER RECORDINGS menu.

```
TI MER RECO RDI NGS
1 Create a New Program
2 Revi ew Exi sti ng Progs.
3 Use VCR PI us+ Code

0 Exi t
```

2. Press 2 to display the Review Existing Progs. screen.

```
Program 1 (One time)
Channel      104 Cabl e
Start Time  12: 00 AM
End Time    01: 30 AM
Start Date  11/18/98 Wed
Tape Speed  SLP

Press CLEAR to erase
Press MENU for next prog
```

3. Press CLEAR to erase or MENU to see the next program.

RECORDING BROADCAST STEREO TV OR SAP (SECOND AUDIO PROGRAM)

Some TV programs are broadcast with stereo audio or SAP (Second Audio Program).

1. Turn on the TV and tune it to the VCR viewing channel (either 3, 4, or TV's video input).
2. Insert a tape with safety tab in place.

RECORDING

3. If your VCR viewing channel is 3 or 4, make sure the VCR indicator appears in the VCR's display panel. If not, press the TV•VCR button on the remote to turn it on.
4. Use the SPEED button on the remote to select a recording speed. The tape speed indicator appears on the TV screen.
5. Select the channel or line input to be recorded.
6. Set the Reception: STEREO/MONO/SAP feature for the type of audio you want to record. See "Audio Set-Up Features" in the *Other Features* section.

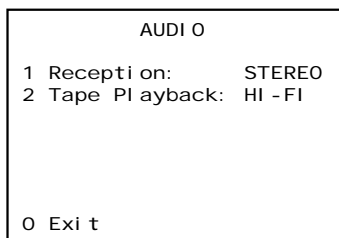

7. Press RECORD to start recording.
8. Press STOP when you are finished.

RECORDING AUDIO ONLY

You can record audio only from another audio source connected to the AUDIO IN (R and L) jacks on the back of the VCR or the AUDIO IN (R and Lmono) jacks on the front of the VCR. (Select L1 to record from the jacks on the back or L2 to record from the jacks on the front of the VCR.)

1. Press the INPUT button on the remote to select the line input.
The VCR will record audio from the audio equipment connected to the AUDIO IN jacks.
2. Use SPEED on the remote to select the recording speed.
3. Start audio source playing and press RECORD to begin recording.
4. Press STOP when you are finished.

Playing Back Audio Only

To get stereo sound, connect the AUDIO OUT jacks of the VCR to the appropriate input on your amplifier or receiver. Do not use the phono input. Refer to your amplifier or receiver user's guide.

Recording audio only will erase anything that was previously recorded on the tape.

Audio Connection

BACK of VCR

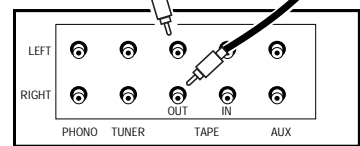
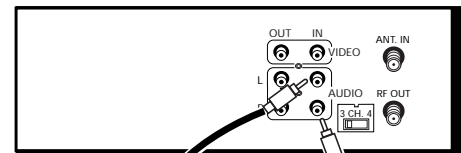

BACK of AMPLIFIER / RECEIVER

RECORDING

USING TWO VCRs FOR COPYING AND EDITING TAPES

Use one VCR as the *playback VCR* and the other as the *recording VCR*.

1. Connect the VCRs using the diagram below.
2. Turn on both VCRs and TV.
3. Tune the TV to the VCR viewing channel (either 3, 4, or TV's video input).
4. If you are using coaxial cables for the connection, tune *recording VCR* to channel 3 or 4—the one selected on the *playback VCR*.

If you are using audio/video cables, select L1 to record from the jacks on the back or L2 to record from the jacks on the front of the *recording VCR*.

5. Insert the tape you want to copy into *playback VCR*. Insert a blank tape with its safety tab in place into *recording VCR*.
6. Use visual search to locate the segment you want to copy on the *playback VCR*. Pause the tape at this location.
7. Press RECORD on the *recording VCR*, then PAUSE.
8. Press PAUSE on both VCRs to begin copying.
9. Press PAUSE on both VCRs to stop copying.
10. Repeat steps 6–9 to copy or edit additional segments.

Caution:

The unauthorized recording of satellite broadcasts, television programs, or other copyrighted materials may infringe the rights of others.

Two VCR Connection

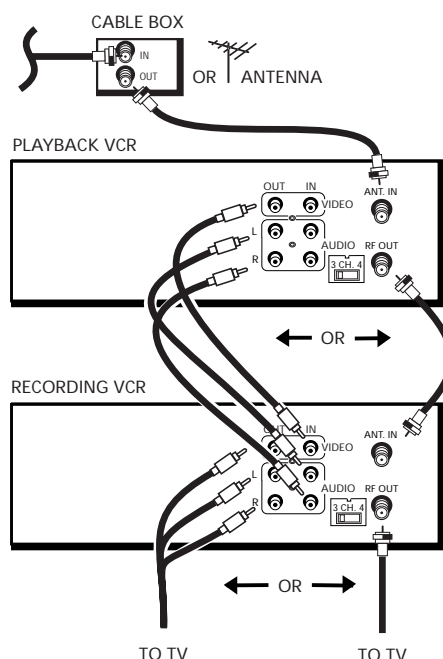

PROGRAMMING THE REMOTE

CONTROL YOUR TV

The remote can be programmed to control a television.

It is programmed to control an RCA, GE, or ProScan TV. Other manufacturer's brands need to be programmed.

1 FIRST THINGS FIRST



2 SETTING UP THE VCR



3 VCR BASICS



4 RECORDING



5 PROGRAMMING THE REMOTE



6 OTHER FEATURES



7 CONNECTIONS

PROGRAMMING THE REMOTE

ABOUT PROGRAMMING THE REMOTE

The remote can be programmed to control other brands of remote-controllable TVs. It is already programmed to operate most RCA, ProScan, and GE televisions.

PROGRAMMING THE REMOTE TO CONTROL A TV

If the TV does not turn on when you press the TV button, the remote needs to be programmed.

Follow these steps to program the remote to control your particular TV:

1. Turn on the TV.
2. Find your TV brand and code number(s) on the code list on the next page.
3. Press and hold the TV button on the remote.
4. Enter the two-digit code from the code list.
5. Release TV, and then press CHAN up or down. If the TV responds to the remote commands, the remote is programmed.
6. If the TV does not respond, repeat these steps using the next code in the list.

OPERATE THE TV

After you set up the remote, see which buttons operate your TV.

1. Point the remote at the TV, and press the TV button.
If the TV does not turn on, press the TV button and then press the OFF button.
2. You may want to experiment to see which buttons operate your TV. Try pressing buttons, such as VOL and MUTE. See "TV Function Buttons" in the *VCR Basic Section* for details.



This remote may not operate all models of the brands that are shown. Note the difference between the TV and VCR on-screen displays to see which one the remote is operating.

PROGRAMMING THE REMOTE

TV Codes

Akai	03	NAD	07
AOC	06,12	NEC	06
Candle	06	Panasonic	04,08,11
Citizen	06	Philco	04,06,12
Colortyme	06	Philips	03,04,06,12
Concerto	06	Pioneer	06
Curtis Mathes	01,06	Portland	06,12
Daewoo	06,12	ProScan	01
Daytron	06	Proton	06
Electrohome	06,12	Quasar	11
Emerson	06	Radio Shack	01,05,13
Envision	05,06	RCA	01,06,12
Fisher	05,08	Realistic	05
GE	00,01,06,11	Sampo	06
Goldstar	06,12	Samsung	06,09,12
Hallmark	06	Sanyo	05,08
Hitachi	06,14	Sears	01,05,06,07, 08,10,12
Infinity	04	Sharp	06,13
J C Penney	00,01,06,09,12	Sony	03
JBL	04	Soundesign	06
Jensen	06	Sylvania	04,06,12
JVC	10,11	Technics	11
Kawasho	03,06	Techwood	06
Kenwood	06,12	Teknika	06
Loewe	04	TMK	06
Luxman	06	Toshiba	05,07,08,09
LXI	04,05,07	Universal	00
Magnavox	04,06,12	Victor	10
Marantz	04,06	Wards	00,01,04,06,12,13
MGA	06,12	Yamaha	12
Mitsubishi	06,12	Zenith	02
MTC	06		

OTHER FEATURES

FEATURES TO ENHANCE VCR OPERATION

- Picture Search Options
- Tracking
- Pro-Tect Plus™ Locking
- Time Counter
- On-Screen Displays
- Audio Reception
- Audio Playback

1 FIRST THINGS FIRST



2 SETTING UP THE VCR



3 VCR BASICS



4 RECORDING



5 PROGRAMMING THE REMOTE



6 OTHER FEATURES



7 CONNECTIONS

OTHER FEATURES

PICTURE SEARCH OPTIONS

The most basic way to search during playback is using the FORWARD or REVERSE buttons. This section contains several other options available for searching a tape.

FORWARD AND REVERSE SEARCH

You can search a tape during playback. Sound is turned off during picture search. Search works well for tapes recorded at either the SP or SLP speed.

1. Press FORWARD to search forward or REVERSE to search in reverse.
2. Press FORWARD or REVERSE again or press PLAY to return to normal playback.

SLOW MOTION

You can view a tape during play or play-pause using slow motion. Slow motion works well for tapes recorded at the SP or SLP speed.

1. During playback, press PAUSE and then FORWARD or REVERSE to begin slow-motion playback,
2. Press FORWARD to increase or REVERSE to decrease the speed of the search.
3. Use TRACKING up or down to remove any streaks from the picture.
4. Press PLAY to return to normal playback.

The VCR switches automatically from slow-motion playback to stop after a few minutes.

COMMERCIAL SCAN (SEARCH BUTTON)

This is useful for skipping commercials or short program segments.

1. Press SEARCH once during playback to advance the tape approximately 30 seconds of recorded material.
2. Each press of the SEARCH button adds an additional 30 seconds up to five minutes.

OTHER FEATURES

FRAME ADVANCE

Frame advance lets you view one-stop action frame after another during playback. Frame advance works well for tapes recorded at the SP or SLP speed.

1. Press PAUSE or F .ADV to "freeze" the action.
2. Press F.ADV each time you want to view a frame of the scene.
3. Press PAUSE or PLA Y to return to normal playback.

INDEX SEARCH

The VCR has a "VHS Index Search System" that automatically records an index mark on the tape every time you start a recording. During playback you can locate the program you want to play by the number of index marks or by scanning. The VCR will search forward or reverse from the location you are on the tape.

To Search:

1. Press ST OP.
2. Press SEARCH on the remote to display the INDEX SEARCH menu on the TV screen.
3. If you want to search through a certain number of index marks, press two number buttons to enter the number of marks you want to search. Press CLEAR on the remote to correct an entry.
4. Press FOR WARD to search forward or REVERSE to search in reverse. The VCR will locate your index mark and begin playback. If you did not enter a specific index number, the VCR will locate the next index mark and begin playback.
5. Press STOP to stop index searching.

Some index marks may be missed by the VCR:

- A mark too close to your location on the tape.
- The mark at the beginning of a recorded segment of five minutes or less.
- The first index mark on the tape when you start at the beginning of the tape.

```
INDEX SEARCH
Press REV OR FWD
to begin scanning
OR
enter a specific
index number
  --
Press SEARCH to exit
```

```
INDEX SEARCH
Searching for
index number 12...
Press STOP to cancel
```

```
INDEX SEARCH
Searching for
index marks...
Press STOP to cancel
```

OTHER FEATURES

GO-TO SEARCH

The Go-To search feature enables the VCR to quickly locate a counter reading anywhere on the tape. When the VCR locates the counter reading, it will begin playback.

1. Press STOP.
2. Press SEARCH on the remote until the GO-TO SEARCH menu appears on the screen.
3. Press number buttons to enter the hour(s) and/or minutes of the counter reading you want the VCR to "go to". Press CLEAR on the remote to correct an entry.
4. Press FORWARD to search forward or REVERSE to search in reverse.
5. Press STOP to stop Go-To searching.

```
GO-TO SEARCH
Current tape counter is
      2:17:25
Press REV or FWD
to go to ---:00
Press SEARCH to exit.
```

TRACKING

Your VCR has automatic tracking which removes the streaks or snow from the picture. Automatic tracking is activated when you insert a tape or turn on the VCR. Occasionally you may need to manually adjust tracking, especially if the tape was recorded on a different VCR. Just use the TRACKING buttons to remove the streaks or snow. You can also use tracking when you pause a tape to reduce jittering of the picture.

When you manually adjust the picture, automatic tracking is turned off. To turn automatic tracking back on, press both TRACKING buttons on the front of the VCR at the same time, or eject the tape and re-insert it.

Tracking has no effect during recording--only playback.

OTHER FEATURES

PRO-TECT PLUS™ LOCKING FEATURE

To disable the usage of the VCR, or to protect your timer recordings, you can lock the VCR so that the buttons on the VCR or remote won't work.

- **To Lock:** Press and hold the VCR button on the remote for approximately six seconds. The VCR turns off. **SAFE** appears in the display if any button is pressed to let you know the feature is activated.
- **To Lock While a Timer Recording Is In Progress:** Press and hold the VCR button on the remote for approximately six seconds. **SAFE** appears in the display to let you know the feature is activated.
- **To Unlock:** Press and hold the VCR button on the remote for approximately six seconds. The VCR turns on.

TIME COUNTER

The time counter shows the actual time it takes to record a program or play back a segment of a recorded tape. It helps locate the beginning or end of programs you taped. The time counter resets to 0:00:00 whenever the tape is ejected from the VCR.

For example, if you record a 30-minute program at the beginning of the tape and you want to go to the end of that program to begin another recording, you would:

1. Press **INFO** **twice** to display the time counter.
2. Press **CLEAR** to reset the time counter to 0:00:00.
3. Press **FORWARD** to forward the tape until the time counter reads 0:30:00.
4. Press **STOP**. This is the approximate end of the program. (You may want to press **PLAY** to verify.) Now, you can begin recording at this spot.
5. Press **INFO** to remove the time counter from the screen and return to the normal display mode.

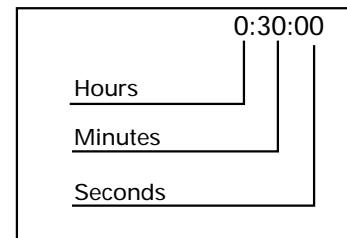

Locking Your VCR:

If a timer recording is programmed, make sure your VCR is turned off. Locking your VCR prevents the VCR from being accidentally turned on.

OTHER FEATURES

ON-SCREEN DISPLAYS

The INFO button shows the status of the VCR (Stop, Play, Rec, etc.), channel number (Video1 or Video 2 for the line input), time counter, date, time, and tape speed on the TV screen. The date and time must be set before they can be displayed.

1. Press INFO to see the on-screen displays. If the channel name is available, it appears under the channel number.
2. Press INFO again to have only the time counter remain on the screen.
3. Press INFO again to return to the normal display mode.

Turning off the VCR also resets the displays.

AUDIO SET-UP FEATURES

The audio set-up features enhance your tape playback and recordings. The features in this section are accessed through the AUDIO menu and are shown in the displays below.

1. Press MENU to display the VCR MAIN MENU.

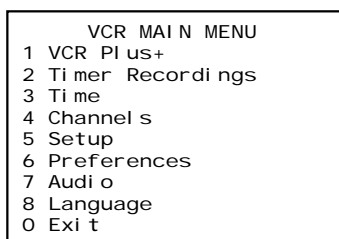

2. Press 7 to display the AUDIO menu.

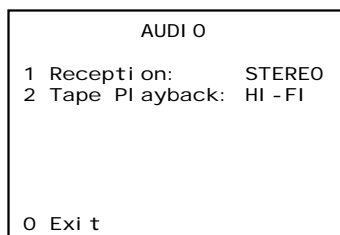

Now you are ready to select an item from the menu to set up.

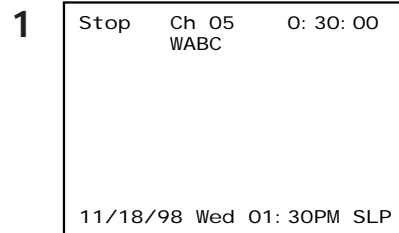

*On-screen display
(times out)*

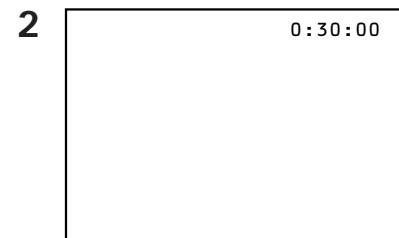

*Time counter only
(does not time out)*



*Normal display mode
(status displays will appear)*

OTHER FEATURES

RECEPTION

Some TV programs are broadcast with stereo audio or a second audio program (SAP) which offers a second language. The Reception feature lets you select the type of audio you want to record. Press 1 to switch between Reception: STEREO, MONO, and SAP.

- Select STEREO for normal or stereo broadcast TV recording.
- Select MONO if the stereo signal is weak and the sound is too noisy.
- Select SAP to record a second audio program instead of the normal audio on both the hi-fi and linear tracks.

TAPE PLAYBACK

The VCR records the same audio on both the Hi-Fi and linear tracks on the tape. Hi-Fi sound is recorded on separate left and right stereo channels. Monaural sound is recorded on the linear track. Press 2 to switch between Tape Playback: HI-FI, LINEAR and MIX.

To enjoy Hi-Fi sound, connect your VCR to a stereo television or amplifier/receiver using the audio/video jacks. The Tape Playback feature lets you select which audio you play back.

- Select HI-FI to play back sound recorded on the Hi-Fi track and for normal use.
- Select LINEAR to play back the sound recorded on the linear monaural track, such as a second audio program (SAP) or a dubbed voice-over.
- Select MIX to play back the sound recorded on both the linear track and the Hi-Fi track, sound-on-sound.

To receive Hi-Fi stereo sound, use audio-video cables with a compatible TV or receiver. Using only the RF OUT jack will not produce stereo sound.

CONNECTIONS

THINGS TO KNOW BEFORE CONNECTING COMPONENTS

Protect Your Components from Power Surges

- Connect all components before plugging any power cords into the wall outlet.
- Always turn off the TV and other components before you connect or disconnect any cables.

Position Cables Correctly to Avoid Audio Hum or Interference

- Insert all cable plugs firmly into their jacks.
- Place the audio/video cables to the sides of the TV's back panel instead of straight down the middle after you connect your components.
- Try not to coil any twin-lead cables and keep them away from the audio/video cables as much as possible.
- Make sure all antennas and cables are properly grounded. Refer to the Safety Tips sheet packed with your unit.

Protect Your Components from Overheating

- Do not block ventilation holes in any of the components. Arrange the components so that air can circulate freely.
- Do not stack components.
- Allow adequate ventilation when placing your components in a stand.
- Place an amplifier or satellite receiver on the top shelf of the stand so heated air rising from it will not flow around other components.

1 FIRST THINGS FIRST



2 SETTING UP THE VCR



3 VCR BASICS



4 RECORDING



5 PROGRAMMING THE REMOTE



6 OTHER FEATURES



7 CONNECTIONS

CONNECTIONS

CONNECTING YOUR VCR

Refer to these pages to help you connect your VCR.

JACKS AND CABLES

RF Jacks and Coaxial Cables (F-type)

The RF jacks provide good picture and mono sound quality, and must be used if audio/video connections are not available for your TV.

These jacks are required for antenna or cable-TV connections. The RF jacks on the VCR are labeled ANT. IN and RF OUT. The coaxial cable supplied with your VCR is used to connect the VCR's RF OUT jack and your TV's antenna input.



RF Jack

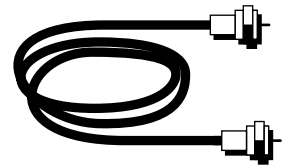

Audio/Video Jacks and Cables (RCA-type)

The AUDIO/VIDEO jacks provide very good picture quality and stereo sound, and can be used if your TV has audio/video input jacks.

These jacks are used for most audio/video connections between components. The VCR AUDIO/VIDEO jacks are color coded (yellow for video, red for right audio, and white for left audio). If your TV only has one input for audio (mono), you may need a Y-adaptor to hear sound from both channels.



Audio/Video Jack

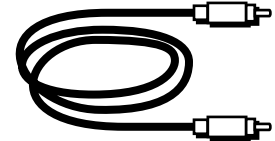

CONNECTIONS

CHOOSING A VCR CONNECTION

There are several different ways to connect your VCR, depending on whether or not you have cable service, and if you have a cable box, and whether some of the channels are scrambled, and maybe you have a satellite receiver along with cable (but no cable box), or a satellite receiver and no cable or...well, you get the picture.

Five connections are described in this section and one of them should provide you with a VCR connection that works.

- TV with RF jack only
- TV with audio/video jacks
- TV with audio/video jacks and cable box to unscramble pay channels only
- TV with RF jack and satellite receiver
- TV with audio/video jacks and satellite receiver

If you need to connect additional components not shown in the diagrams here (and are unsure of how to connect them), refer to the instruction manual that came with that particular component.

ADVANTAGES OF AUDIO/VIDEO CABLE CONNECTIONS

Using a simple coaxial cable connection gives you good picture quality. If your television has audio/video jacks, I highly recommend using them to get even better picture quality and stereo sound when recording and playing back videotapes. These connections give you more convenient operation by not having to share the TV's antenna signal.

DON'T FORGET ABOUT THE AUTO TV/VCR FEATURE

The TV/VCR switch controls whether the picture signal is coming from the VCR or the TV.

You can change the setting manually by using the TV•VCR button on the remote or you can set the Auto TV/VCR feature to ON when using only the ANT. IN and RF OUT jacks and OFF when using the AUDIO/VIDEO output jacks--so your TV signal is not interrupted when the VCR is turned on.

CONNECTIONS

TV WITH RF JACK ONLY

This connection assumes:

- You are connecting antenna, cable, or cable box system.
- Your television has only an RF input jack.

This connection provides:

- Mono sound playback from VCR.
- Record one channel while watching another (except when using a cable box for all channels).

To use this connection, you must have:

- (1) coaxial cable for cable or antenna connection; (2) for cable box

If your cable box is remote controllable:

- Position it above the VCR as shown. Make sure not to block any of the VCR's ventilation holes.

To connect:

1. Connect cables as shown.
2. Return to *First Things First*, then follow the steps.

Using This Connection

Tune your TV to channel 3 or 4, whichever one you selected with the 3 CH. 4 switch on the back of the VCR.

Auto TV/VCR Setting:

- Set the Auto TV/VCR feature to ON.

To play a tape:

1. Insert a tape.
2. If necessary, press PLAY.

To record one program and watch another:

1. Begin recording a program using one of the recording features.
2. Press the TV•VCR button and select a different channel on the TV.

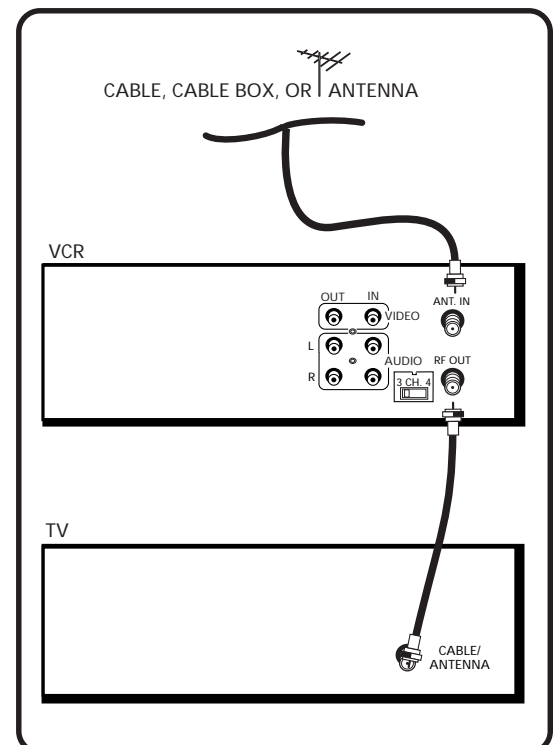
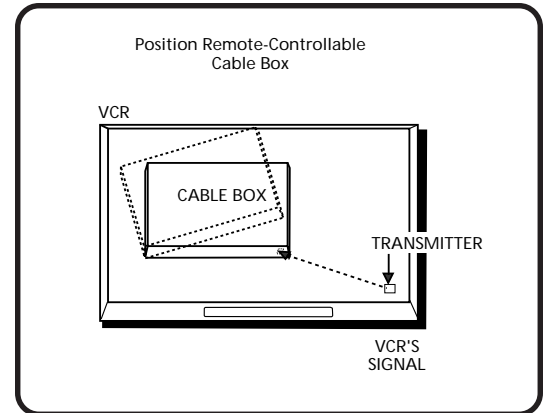

CONNECTIONS

TV WITH AUDIO/VIDEO JACKS

This connection assumes:

- You are connecting an antenna, cable, or cable box system.
- Your television has audio/video jacks.

This connection provides:

- Stereo sound playback from VCR.
- Record one channel while watching another (except when using a cable box for all channels).

To use this connection, you must have:

- (1) coaxial cable for cable/antenna connection; (2) for cable box
- (3) audio/video cables

If your cable box is remote controllable:

- Position it above the VCR as shown. Make sure not to block any of the VCR's ventilation holes.

To connect:

1. Connect cables as shown.
2. Return to *First Things First*, then follow the steps.

Using This Connection

Tune your TV to its video input channel. Use of TV•VCR button is not required.

Auto TV/VCR Setting:

- Set the Auto TV/VCR feature to OFF.

To play a tape:

1. Insert a tape.
2. If necessary, press PLAY.

To record one program and watch another:

1. Begin recording a program using one of the recording features.
2. Select a different channel on the TV.

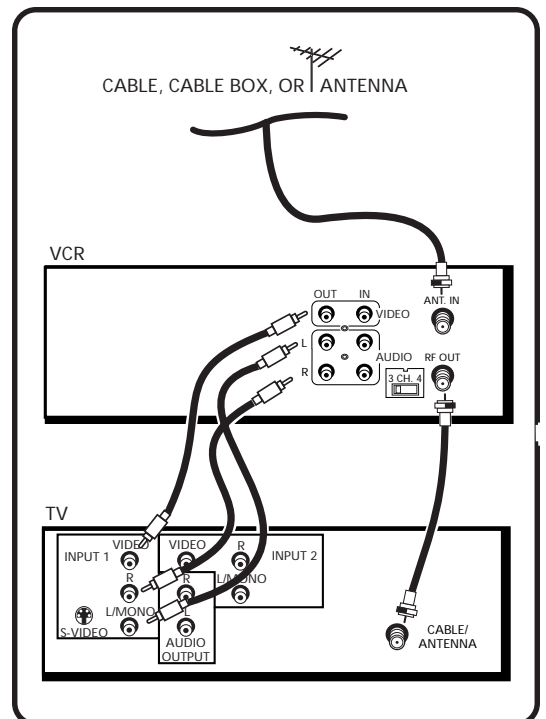
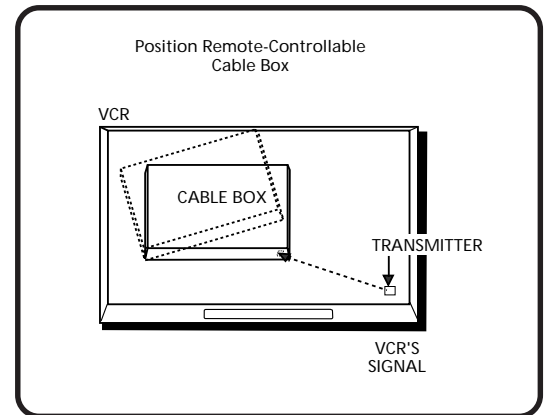

CONNECTIONS

TV WITH AUDIO/VIDEO JACKS AND CABLE BOX TO UNSCRAMBLE PAY CHANNELS ONLY

This connection assumes:

- You are using a cable box only to unscramble premium channels.
- Your TV has audio/video input jacks.

This connection provides:

- Stereo sound playback from VCR.
- Recording a scrambled or unscrambled channel through the cable box while watching an unscrambled channel.

To use this connection, you must have:

- (3) coaxial cables
- (3) audio/video cables
- (1) splitter

If your cable box is remote controllable:

- Position it above the VCR as shown. Make sure not to block any of the VCR's ventilation holes.

To connect:

1. Connect cables as shown.
2. Return to *First Things First*, then follow the steps.

Using This Connection

Tune your TV to its video input channel. Use of TV•VCR button is not required.

Auto TV/VCR Setting:

- Set the Auto TV/VCR feature to OFF.

To play a tape:

1. Insert a tape.
2. If necessary, press PLAY.

To record a scrambled or unscrambled program and watch another unscrambled program:

1. Begin recording a scrambled or unscrambled program through the cable box using one of the recording features.
2. Select an unscrambled channel on the TV.

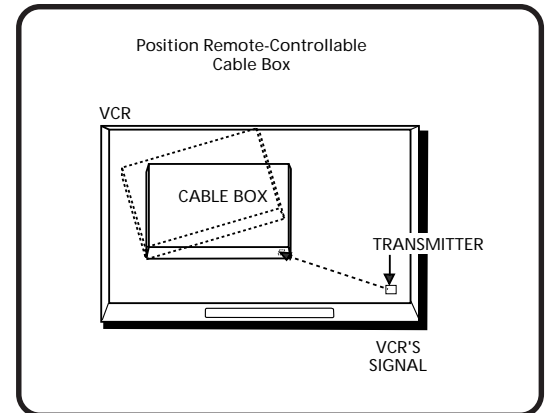

All scrambled channels must be viewed through the VCR.

For Cable Box Setup, select ALL channels. See page 11.

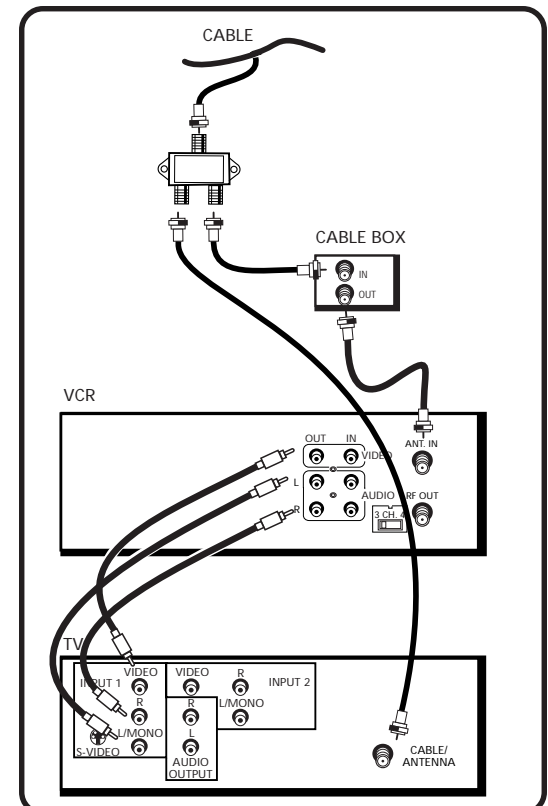

CONNECTIONS

TV WITH RF JACK AND DIGITAL SATELLITE RECEIVER

This connection assumes:

- You have a basic digital satellite system and your TV does not have audio/video input jacks.

This connection provides:

- Mono sound playback from VCR, recording from a digital satellite receiver, and recording one off-air or cable channel while watching another.

To use this connection, you must have:

- (4) coaxial cables and (3) audio/video cables

If the VCR can control your digital satellite receiver:

- Position it above the VCR as shown. Make sure not to block any of the VCR's ventilation holes.

To connect:

- Connect cables as shown.
- Return to the *First Things First* Section, then follow the steps.

Using This Connection

- Tune your TV to channel 3 or 4, whichever one you selected with the 3 CH. 4 switch on the back of the VCR.
- To record and watch off-air or cable, tune your VCR to channel 3 or 4 whichever one you selected with the 3 CH. 4 switch on the back of the receiver. Turn off receiver.
- To watch and/or record from the digital satellite receiver, tune your VCR to its line input. L1 appears in display.

Auto TV/VCR Setting:

- Set the Auto TV/VCR feature to ON.

To play a tape:

- Insert a tape.
- If necessary, press VCR and then PLAY.

To record one off-air or cable program and watch another:

- Turn off the digital satellite receiver and begin recording a program using a recording feature.
- Press TV•VCR and select a different channel on the TV.

To record a digital satellite receiver program:

- Turn on the receiver, tune the VCR to its line input, and begin recording a program using a recording feature.

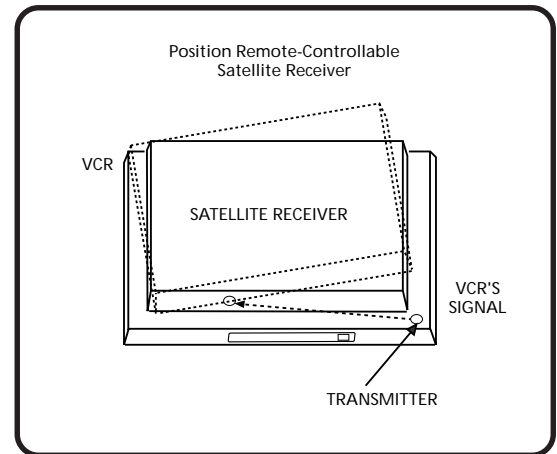

Caution

The unauthorized recording of satellite broadcasts, television programs, or other copyrighted materials may infringe the rights of others.

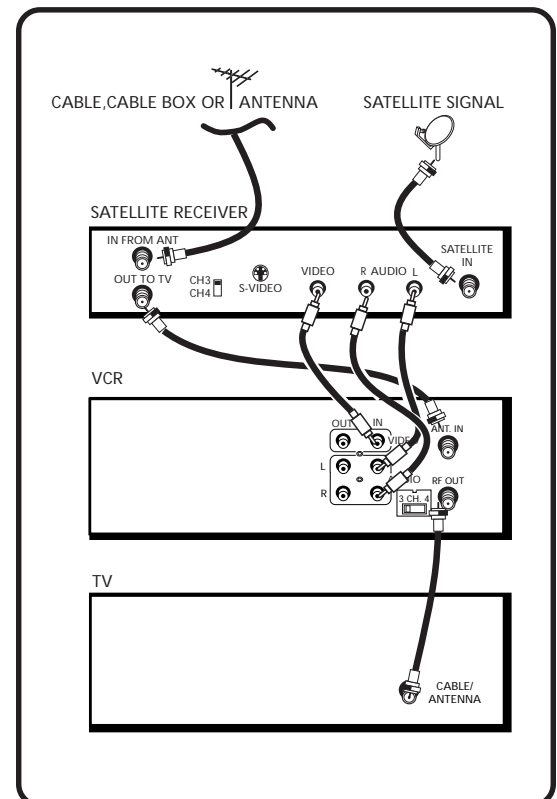

CONNECTIONS

TV WITH AUDIO/VIDEO JACKS AND DIGITAL SATELLITE RECEIVER

This connection assumes:

- You have an advanced digital satellite system and your TV has audio/video input jacks.

This connection provides:

- Stereo sound playback from VCR, recording from receiver while watching cable or off-air channel, and recording one cable or off-air channel while watching another.

To use this connection, you must have:

- (3) coaxial cables and (6) audio/video cables

If the VCR can control your digital satellite receiver:

- Position it above the VCR as shown. Make sure not to block any of the VCR's ventilation holes.

To connect:

- Connect cables as shown.
- Return to the *First Things First* Section, then follow the steps.

Using This Connection

- Tune your TV to its video input to record (or watch) the VCR or digital satellite receiver.
- To record from the digital satellite receiver, tune your VCR to its line input. L1 appears in the display.

Auto TV/VCR Setting:

- Set the Auto TV/VCR feature to OFF. Use of TV•VCR button is not required.

To play a tape:

- Insert a tape.
- If necessary, press VCR and then PLAY.

To record one off-air or cable program and watch another:

- Begin recording a program using a recording feature.
- Select a different channel on the TV.

To record a digital satellite receiver program and watch a cable or off-air channel:

- Turn on the receiver, tune the VCR to its line input, and begin recording a program using a recording feature.
- Select a different channel on the TV.

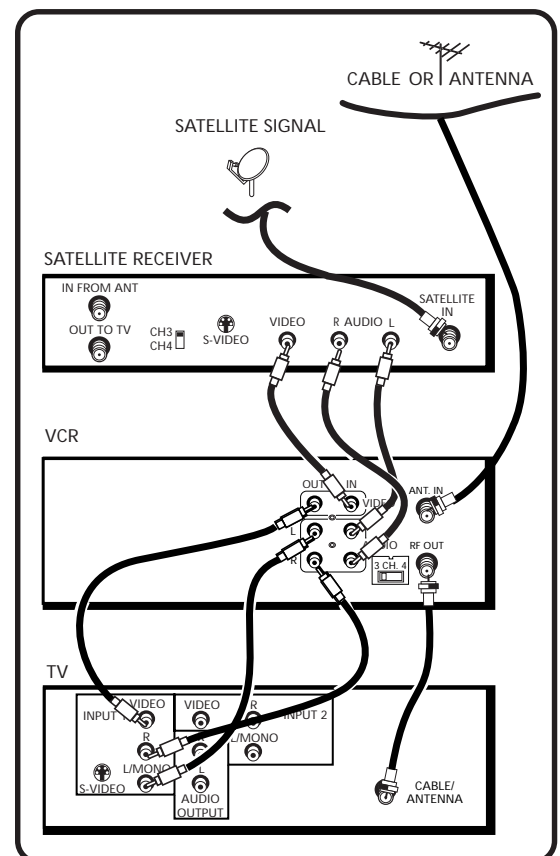
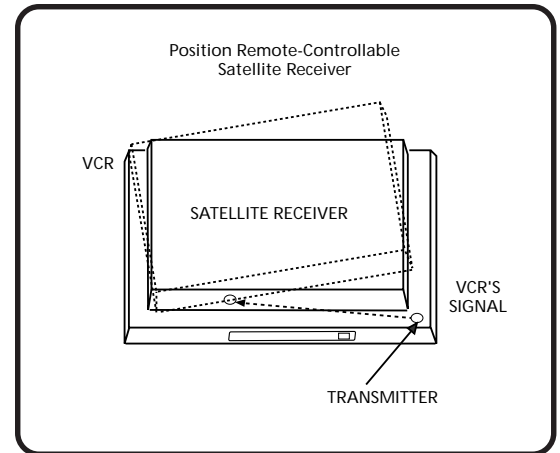

APPENDIX: REFERENCE

This section gives you some additional information about the VCR, including a description of the unit's controls and display.

You also will find a *Troubleshooting Tips* section in this Appendix, which might help to resolve some of those simple problems.

Finally, this section contains your warranty information.

APPENDIX: REFERENCE

FRONT PANEL

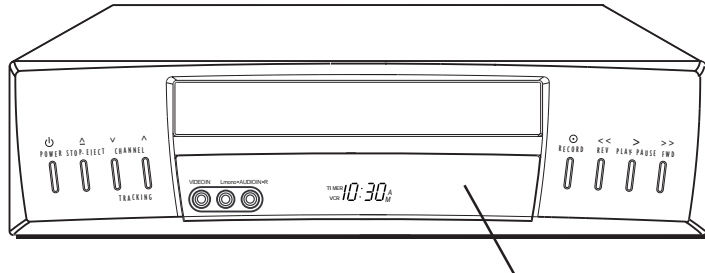

Remote Sensor

AUDIO (R and Lmono) and VIDEO IN Jacks Receives signals from another component, like a VCR or camcorder, when it is connected to these jacks. Use INPUT on the remote to select "L2" to record from these jacks.

CHANNEL•TRACKING Up or Down Selects next higher or lower channel in the VCR's channel memory. Adjusts tracking when a tape is playing. Press both together to recenter tracking.

FWD Forwards the tape when the VCR is stopped. Searches the picture forward during playback. Starts slow motion during play-pause and increases slow-motion speed.

PLAY•PAUSE Plays a tape. Pauses action for viewing during playback. Pauses recording to prevent recording of unwanted scenes.

POWER Turns the VCR on or off.

RECORD Starts VCR recording. Used for express recording.

Remote Sensor Receives signals from the remote control. Aim the remote at this sensor.

REV Rewinds the tape when the VCR is stopped. Searches the picture in reverse during playback. Starts slow motion during play-pause and decreases slow-motion speed.

STOP•EJECT Stops the normal functions such as record, playback, rewind, fast-forward, or pause. Ejects the tape when the VCR is stopped.

APPENDIX: REFERENCE

DISPLAY PANEL



Time, Channel Number, Line Input Indicator (L1 or L2), Tape Speed Indicator, or Status Indicators

Time The current time appears. Only an AM indicator appears with the time. There is no indicator for PM.

Channel Number or Line Input Indicator The channel number appears when the VCR is tuned to a channel. The line indicator (L1 or L2) appears when a line input is selected.

Tape Speed Indicator (SP and SLP) Press SPEED on the remote to change.

Status Indicators Show what the VCR is doing.

- HI and BYE Turned on/unlocked; turned off
- FF Fast forwarding
- PLAY In playback (flashes during play-pause and slow)
- REC Recording (flashes when in record pause mode)
- REW Rewinding
- R0:30 Express recording in progress
- SAFE Pro-Tect Plus turned on
- SCH and SCH- Forward and reverse search during playback
- STOP Tape is stopped

TIMER Lights during express recording and when VCR is turned off and set for timer recording. Flashes when timer recording is set and there is no cassette in the VCR.

VCR Indicator (Applies only if the VCR Viewing Channel is 3 or 4). Press the TV•VCR button to turn on or off.

- VCR indicator on: Picture from VCR.
- VCR indicator off: Picture from TV channel.

APPENDIX: REFERENCE

BACK PANEL

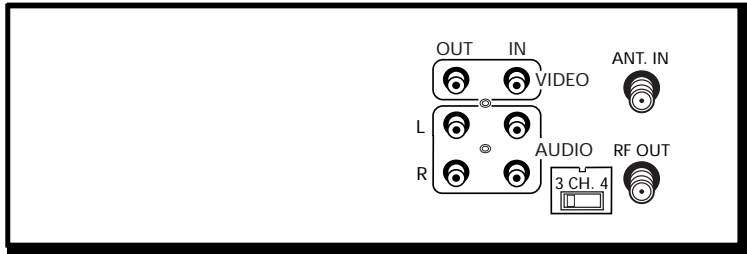

3 CH. 4 Switch Selects the channel to which you will tune the TV to see the VCR picture if you connect the VCR using one of the basic hookups.

AUDIO (R and L) and VIDEO IN Jacks Receives signals from another component, like a VCR or camcorder, when it is connected to these jacks. Use INPUT on the remote to select "L1" to record from these jacks.

AUDIO (R and L) and VIDEO OUT Jacks Sends signals from VCR to another component, like a TV or VCR, when it is connected to these jacks.

ANT. IN Jack Receives a signal from an antenna or cable system when attached.

RF OUT Jack Passes signal to TV using the cable supplied.

APPENDIX: REFERENCE

TROUBLESHOOTING TIPS

No power

- Check to make sure it is plugged into an operating outlet.
- Check to make sure your connections are correct.

VCR does not respond to remote

- Press VCR to set remote to control the VCR.
- Check to make sure there are no objects between the VCR and remote.
- The batteries may need changing.
- Make sure the Remote VCR1/VCR2 setting is set to VCR1 so the remote that came packed with your VCR can operate it.

Remote no longer controls an RCA, ProScan, or GE TV

- Press TV to set remote to control a compatible TV.
- Check to make sure the remote is programmed to control an RCA, ProScan, or GE TV.

Remote no longer controls a compatible TV

- Press TV to set remote to control the corresponding component.
- Check to make sure there are no objects between the component and remote.
- The batteries may need changing.
- Reprogram remote after batteries have been changed.
- Remove batteries and hold number button 1 for at least 60 seconds to drain the microprocessor inside the remote. Release number 1, replace the batteries, and (if necessary) reprogram the remote.

Poor or no picture for normal TV viewing

- Check to make sure the VCR indicator is off.
- Check to make sure the TV is switched to an active channel.
- Check to make sure the antenna connections are secure and correct.

Snowy or no picture during playback

- Press TV•VCR to turn VCR indicator on.
- Check TV channel selected (3 or 4) to make sure it matches the channel selected with 3 CH. 4 switch on back of VCR.
- Check to make sure the TV's fine tuning is correct for the channel you have selected.
- Check video cable connections between VCR and TV monitor.
- Check to make sure the TV monitor is set to video input.
- Try another tape.
- Some snow/streaks are normal during search, stop action, frame advance, and slow-motion playback.

continued on next page

APPENDIX: REFERENCE

Streaks in picture during normal playback

- Press one of the TRACKING buttons to move streaks up or down for the best picture.
- Check to make sure the tape is of good quality and not worn out.

Time counter not working or time counter not working in search modes

- The time counter does not advance during unrecorded portions of tape. When an unrecorded segment of tape is encountered, the time counter will hold its count until recorded material is detected again.
- A minus (-) will appear in front of the time if you rewind the tape farther back than a counter reading of 0:00:00.
- The time counter disappears during search; this is normal.

Will not record or play

- Check to make sure there is a tape in the VCR.
- Try ejecting and reinserting the cassette.
- Check to make sure the tape is not broken.
- Check to make sure the VCR is not in pause mode. Press PAUSE or PLAY to return to normal playback.
- Check the ProTect Plus™ feature.

Rewind does not operate

- Check to make sure the tape is not already rewound.

VCR Plus+ or timer recording not made or wrong program recorded

- Check to make sure the correct VCR Plus+ code is entered.
- Check to make sure the cable box or satellite receiver was turned on when recording was to begin.
- Check to make sure the program was entered correctly (wrong channel or times).
- VCR cannot control cable box or satellite receiver. Check to make sure VCR was set up for cable box or DSS control or try repositioning the cable box or satellite receiver.
- Power interruption. Reset the clock.
- Check to see if time and date are correct – including AM/PM.
- Check to make sure the program did not exceed the tape's length or the tape was not rewound beforehand.
- Check to make sure the VCR was turned off at the time recording was to start.
- Check to make sure there was a tape in the VCR and the cassette's safety tab was intact.
- VCR ejects cassette when the end of the tape is reached during a timer recording.
- Check to make sure VCR Plus+ setup was completed correctly.

Will not record

- Check to make sure the safety tab is intact.
- Check to make sure the VCR is not in the line mode. Press INPUT on the remote.

APPENDIX: REFERENCE

Clock shows incorrect time or date

- Power interruption. Automatic clock set was not turned on or did not work properly. Check time zone and daylight-savings settings.
- Make sure VCR or cable box is tuned to channel carrying XDS information.
- Auto clock set is not supported by digital satellite receivers. Set the clock manually.

Time did not adjust for daylight-saving time

- Check to make sure daylight-saving feature is set correctly.

VCR makes noise when stopped

- VCR is removing tape from heads. This is normal. The head cylinder inside the VCR will continue to rotate for a few minutes after you put the VCR in the stop mode.

Will not AUTO CHANNEL SEARCH active channels correctly

- Check to make sure the antenna connections are secure and correct.
- Check to make sure the Signal Type: CABLE/ANTENNA feature is set correctly.
- If Detect Automatically was selected for the Signal Type in the AUTO CHANNEL SEARCH menu, try using either CABLE TV or ANTENNA instead.
- May not be necessary if using a cable box for all channels. Contact your local cable company for more information.

Tape plays back in slow motion

- Press PLAY to return to normal playback.

Cannot select channels over 69

- Cable channels over 69 can only be selected if Signal Type: CABLE/ANTENNA feature is set to CABLE.

Cassette with safety tab removed does not start to play automatically

- Check to make sure the Auto Play ON/OFF feature is set to ON.

TIMER indicator flashes

- Check to make sure there is a cassette in the VCR when a timer recording is set.

Time counter disappears during searching

- This is normal.

On-screen menus appear in English, French, or Spanish

- Check LANGUAGE feature.

APPENDIX: REFERENCE

No stereo sound during playback

- Check to make sure the Tape Playback feature is set to HI-FI to hear stereo sound during playback. The tape you are playing must be recorded in HI-FI in order to play back in HI-FI.
- Must use the AUDIO/VIDEO jacks on the back of the VCR to hear stereo sound.

Stereo audio too noisy

- Stereo signal is weak. Set Reception: STEREO/SAP/MONO feature to MONO.
- Press one of the TRACKING up or down buttons to minimize the noise.

APPENDIX: REFERENCE

LIMITED WARRANTY

What your warranty covers:

- Any defect in materials or workmanship.

For how long after your purchase:

- Ninety days for labor charges.
- One year for parts.

The warranty period for rental units begins with the first rental or 45 days from date of shipment to the rental firm, whichever comes first.

What we will do:

- Pay any Authorized RCA VCR Service Center the labor charges to repair your VCR.
- Pay any Authorized RCA VCR Service Center for the new or, at our option, refurbished replacement parts required to repair your VCR.

How you get service:

- Take your VCR to any Authorized RCA VCR Service Center. To identify your nearest Authorized RCA VCR Service Center, ask your dealer, look in the Yellow Pages, or call 1-800-336-1900.
- Show the Authorized Service Center Representative your evidence or purchase date or first rental.
- Pick up your VCR when repairs are completed.

What your warranty does not cover:

- Customer instruction. (Your Owner's Manual clearly describes how to install, adjust, and operate your VCR. Any additional information should be obtained from your Dealer.)
- Installation and related adjustments.
- Signal reception problems not caused by your VCR.
- Damage from misuse or neglect.
- Cleaning of video/audio heads.
- Batteries.
- A VCR that has been modified or incorporated into other products or is used for institutional or other commercial purposes.
- A VCR purchased or serviced outside the USA.
- Acts of God, such as but not limited to lightning damage.

Product Registration:

- Please complete and mail the Product Registration Card packed with your VCR. It will make it easier to contact you should it ever be necessary. The return of the card is not required for warranty coverage.

How state law relates to this warranty:

- This warranty gives you specific legal rights and you also may have other rights that vary from state to state.

If you purchased your VCR outside the United States:

- This warranty does not apply. Contact your dealer for warranty information.

APPENDIX: REFERENCE

SPECIFICATIONS

Format:	VHS
Record/Playback System:	Video: 4-head Audio: 2 Hi-Fi record/playback system
Video Signal System:	EIA standard: NTSC color
Antenna:	75-ohm external VHF/UHF combined antenna terminal
Tuner:	USA: 181 channels capability* (125 cable channels) Canada: 178 channels capability* (122 cable channels)
Type:	AutoProgramming frequency synthesis
Power Requirement:	120V AC, 60 Hz
Power Consumption:	19 watts (Standby: <4 watts)
Dimensions:	3.54 inches high (90 mm) 14.2 inches wide (360 mm) 10.75 inches deep (273 mm)
Weight:	pounds (3.7 kg)
Storage Temperature Range:	- 22°F to +149°F (-30°C to +65°C)
Operating Temperature Range:	+41°F to +104°F (+5°C to +40°C)

*Check your cable company's compatibility requirements.

CLEANING THE VCR

Use a soft cloth or dusting attachment of your vacuum cleaner to dust your VCR. Remove dust from the ventilation holes on the top, back, sides, and bottom of the cabinet.

Plastic surfaces are easily scratched and can be marred by alcohol and various solvents. Avoid excessive use of oil-based furniture polishes since the materials used in the cabinet will accumulate more dust. We recommend using a nonabrasive, antistatic cleaner and polisher.

Specifications are subject to change.

INDEX

3 CH. 4 switch 5, 8, 52, 55, 60

A

Accessing menus 5
Add or remove channels 14
ADD/REMOVE CHANNELS screen
 15
ANT. IN and RF OUT jacks
 4, 5, 8, 50, 51, 52, 55, 60
Audio
 AUDIO menu 46
 Hi-Fi 47
 linear 47
 mono 47
 playback 47
 reception 47
 recording audio only 35
 SAP 47
 set-up features 46
 stereo 47
AUDIO/VIDEO jacks
 4, 5, 24, 35, 36, 50,
 51, 53, 54, 56, 58, 60
Auto channel search 13
AUTO CHANNEL SEARCH menu
 14
Auto clock set feature 15
AUTO CLOCK SET screen 15
Auto play feature 6, 21, 26
Auto TV/VCR feature
 21, 51, 52, 53, 54, 55, 56
Automatic rewind 27
Automatic tracking 26

B

Back panel controls 60
Basics, learn the 23
Batteries, install in the remote 4
Broadcast stereo TV recording 34

C

Cable box codes 12
Cable box setup 11
CABLE BOX SETUP menu 11
Cables
 positioning 49
 types of 50
CHAN buttons 15, 24, 25, 38
CHANNEL buttons 15, 58
Channel list 13, 32
Channel name display 46
Channel number display 59
Channels, add or remove 14
CHANNELS menu
 9, 11, 13, 14, 18, 32
Cleaning the VCR 66
CLEAR button
 24, 25, 33, 34, 43, 44, 45
Clearing programs 34
Commercial scan search 42
Connecting your VCR 4
Connections
 audio only 35
 audio/video cable advantages
 51
 choosing 51
 information 49, 50
 TV with AUDIO/VIDEO jacks 53
 TV with AUDIO/VIDEO jacks and
 cable box to unscramble pay
 channels only 54
 TV with AUDIO/VIDEO jacks and
 satellite receiver 56
 TV with RF jack and satellite
 receiver 55
 TV with RF jack only 52
 two VCRs 36
Contents 1
Copying and editing tapes 36

D

Date and time setting 16
Detect automatically 14
Digital satellite system setup 9
Display panel 59
Display panel brightness 22
Displays
 front panel 58
 on-screen 46
DSS SETUP menu 10
DST (Daylight Savings Time) 16

E

Editing tapes 36
Eject, tape 27
EnergySaver feature 22
Express recording 30

F

F.ADV button 24, 43
First setup 3
Forward and reverse search 42
FORWARD button
 24, 26, 42, 43, 44, 45
Frame advance 43
Front panel
 controls 58
 VCR display brightness feature
 22
FWD button 26, 58

G

GO BACK button 24, 25
Go-to search 44
GO-TO SEARCH menu 44

continued on next page

INDEX

H

Hi-Fi playback 47

I

Important information

inside front cover

Index search 43

INDEX SEARCH menu 43

INFO button 17, 24, 25, 45, 46

INPUT button 24, 31, 35

J

Jacks

ANT. IN and RF OUT

4, 5, 8, 50, 51, 52, 55, 60

AUDIO/VIDEO

4, 5, 24, 35, 36, 50, 51,
53, 54, 56, 58, 60

types of 50

L

L1 and L2 line indicators

35, 36, 56, 59

Language feature 8

LANGUAGE menu 9

Limited warranty 65

Linear playback 47

Locking feature 45

LP speed 22

M

MENU button

5, 6, 8, 9, 10, 11, 12, 13, 14,
15, 16, 17, 18, 20, 24, 31,
32, 33, 34, 46

Mix audio playback 47

Mono playback 47

Mono reception 47

MUTE button 25

N

Number buttons 5, 25, 26

O

OFF button 24, 25, 26, 38

On-screen displays 46

Overheating 49

P

PAUSE button

25, 26, 27, 36, 42, 43

Pause during play 27

Picture search options 42

PLAY button

25, 26, 42, 43, 45, 52, 53,
54, 55, 56

PLAY•PAUSE button 26, 58

Playing a tape 26

Plugging in the VCR 5

POWER button 27, 58

Power surges 49

PREFERENCES menu 20

Preferred tape speed feature 22

Pro-Tect Plus locking feature 45

Problem solving 61

Product registration

inside front cover

Programming the remote

to operate a TV 38

PROGRAMS OVERLAP message

31, 33

Q

QuickSet guide 8

R

Reception

mono 47

reception: STEREO/MONO/SAP

feature 35

SAP 47

stereo 47

RECORD button

25, 27, 30, 35, 36, 58

Recording

audio only 35

broadcast stereo TV 34

copying and editing tapes 36

express 30

SAP 34

speeds 22

timer 31

types of 30

VCR plus+ 32

XPR (express) 30

Remote

buttons 24

component buttons 24

install batteries 4

program for TV 38

sensor 58

TV function buttons 25

VCR function buttons 24

VCR1/VCR2 option 20

Remove or add channels 14

REV button 26, 58

REVERSE button

25, 26, 42, 43, 44

Review programs screen 34

Reviewing programs 34

Rewind, automatic 27

S

SAFE indicator 45

Safety tab 27, 36

SAP reception 47

SAP recording 34

Satellite receiver codes 10

Search

commercial scan 42

forward and reverse 42

INDEX

- frame advance 43
 - go-to 44
 - index 43
 - slow-motion 42
 - SEARCH button 25, 42, 43, 44
 - SET DAYLIGHT SAVINGS screen 16
 - Set time and date manually 17
 - SET TIME AND DATE menu 17
 - SET TIME ZONE screen 16
 - Set up
 - additional features 7
 - cable box 11
 - digital satellite system 9
 - first 3
 - language 8
 - setting up the VCR 6
 - setup menu 8
 - using menus 8
 - Signal type
 - CABLE and ANTENNA 14
 - changing 14
 - Slow-motion search 42
 - SLP speed 22, 42, 43
 - Solving problems 61
 - SP speed 22, 42, 43
 - Specifications 66
 - SPEED button 25, 27, 30, 33, 35
 - Status indicators
 - BYE 59
 - FF 59
 - HI 59
 - PLAY 59
 - R0:30 (express recording) 59
 - REC 59
 - REW 59
 - SAFE 59
 - SCH and SCH- 59
 - STOP 59
 - TIMER 59
 - Stereo reception 47
 - STOP button
 - 25, 26, 27, 30, 35, 43, 44, 45
 - STOP•EJECT button 26, 27, 58
 - Stop-action pause 27
 - Stopping a timer recording 34
- ## T
- Tab, safety 27, 36
 - Table of contents 1
 - Tape
 - eject 27
 - playback 47
 - playing 26
 - record over 27
 - Tape speed indicators 35, 59
 - Tape speeds, description 22
 - Time and date
 - set daylight saving 16
 - setting 15, 16
 - setting time zone 15, 16
 - Time counter 45
 - Time display 59
 - TIME menu 16, 17
 - TIMER indicator 31, 33, 59
 - Timer recording
 - clearing programs 34
 - express 30
 - information 31
 - stopping 34
 - TIMER RECORDINGS menu 31
 - using 31
 - with VCR Plus+ 30
 - Tips, troubleshooting 61
 - Tracking 44
 - TRACKING buttons
 - 25, 26, 42, 44, 58
 - Troubleshooting tips 61
 - TV button 24, 38
 - TV codes 39
 - TV function buttons 25
 - TV•VCR button
 - 25, 35, 51, 52, 53, 54,
 - 55, 56, 59
- ## U
- Unpack the VCR 4
 - UNRECOGNIZED NUMBER message 33
- ## V
- VCR button 21, 24, 45
 - VCR channel 36
 - VCR channel list 13
 - VCR, cleaning 66
 - VCR function buttons 24
 - VCR indicator 8, 59
 - VCR MAIN MENU
 - 6, 8, 9, 11, 13, 14, 15, 16,
 - 17, 18, 20, 31, 32, 46
 - VCR Plus+
 - channel list Canada 19
 - channel list menu 32
 - channel list screen 18
 - channel list USA 18
 - channels 18
 - clearing programs 34
 - information 33
 - menu 32
 - PlusCodes 33
 - recording 32, 33
 - setting up channels 18
 - stopping 34
 - worksheet for channels 19
 - VCR, turn on 5
 - VCR viewing channel 5, 34
 - Video1 and Video2 indicators 46
 - VOL buttons 26
- ## W
- Warranty, limited 65
- ## X
- XDS (Extended Data Services) information 15
 - XPR (express recording) 30

If your VCR needs service, please contact your dealer or the nearest Servicenter from the yellow pages. Please do not send any products to the Indianapolis address listed in this manual or on the carton. This will only add delays in service for your product.

 **THOMSON CONSUMER ELECTRONICS**

10330 North Meridian Street
Indianapolis, IN 46290

©1998 Thomson Consumer Electronics, Inc.

Trademark(s)® Registered

Marca(s) Registrada(s)

Printed in Japan

TOCOM 15313900



As an ENERGY STAR® Partner, Thomson Consumer Electronics has determined that this product or product model meets the ENERGY STAR® guidelines for energy efficiency.

Free Manuals Download Website

<http://myh66.com>

<http://usermanuals.us>

<http://www.somanuals.com>

<http://www.4manuals.cc>

<http://www.manual-lib.com>

<http://www.404manual.com>

<http://www.luxmanual.com>

<http://aubethermostatmanual.com>

Golf course search by state

<http://golfingnear.com>

Email search by domain

<http://emailbydomain.com>

Auto manuals search

<http://auto.somanuals.com>

TV manuals search

<http://tv.somanuals.com>