

VR725HF

USER'S GUIDE

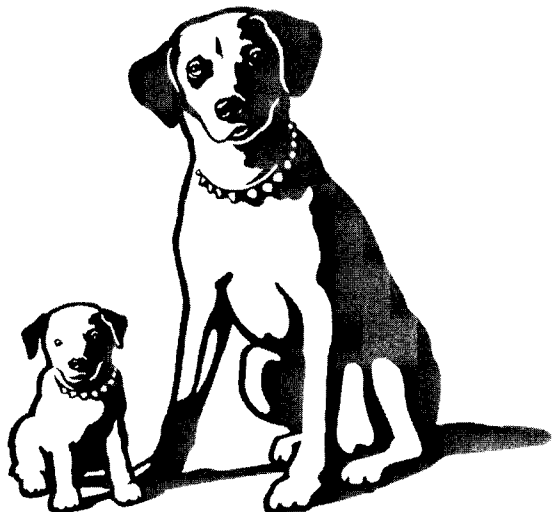
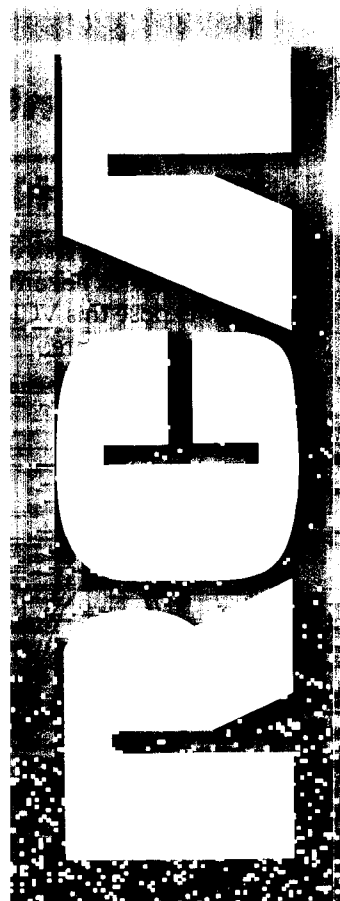

VIDEO CASSETTE RECORDER

Important Information

WARNING

To reduce the risk of fire or shock hazard, do not expose this VCR to rain or moisture.

WARNING

RISK OF ELECTRIC SHOCK
DO NOT OPEN

TO REDUCE THE RISK OF ELECTRIC SHOCK, DO NOT REMOVE COVER (OR BACK). NO USER SERVICEABLE PARTS INSIDE. REFER SERVICING TO QUALIFIED SERVICE PERSONNEL.



This symbol indicates "dangerous voltage" inside the product that presents a risk of electric shock or personal injury.



This symbol indicates important instructions accompanying the product.

Cautions

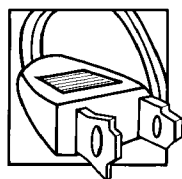

Caution: To prevent electric shock, match wide blade of plug to wide slot, fully insert.

Attention: Pour éviter les chocs électriques, introduire la lame la plus large de la fiche dans la borne correspondante de la prise et pousser jusqu'au fond.

Do not defeat the safety feature of the plug. The wide blade fits into the wall socket only one way. If you need an extension cord, make sure it matches the plug of the VCR.

For U.S.A. — Operate VCR only on 120 volts, 60Hz AC power (normal house power).

FCC Regulations state that unauthorized changes or modifications to this equipment may void the user's authority to operate it.

Note To Cable TV Installer

This reminder is provided to call your attention to Article 820-40 of the National Electrical Code (Section 54 of the Canadian Electrical Code, Part 1) which provides guidelines for proper grounding and, in particular, specifies that the cable ground shall be connected to the grounding system of the

Product Registration

Please fill out the product registration card and return it immediately. Returning this card allows us to contact you if needed.

Keep your sales receipt to obtain warranty parts and service and for proof of purchase. Attach it here and record the serial and model numbers in case you need them. The numbers are located on the back of the VCR.

Model No. **VR725HF** _____

Serial No. _____

Purchase Date: _____

Dealer/Address/Phone: _____

Table of Contents

Important Information

Warnings _____	i
Cautions _____	i
Note to Cable TV Installer _____	i
Product Registration _____	i

Hooking Up the VCR

Choosing a Hookup _____	2
Antenna or Cable System Without a Cable Box _____	3
Cable System With Cable Box to Unscramble All Channels _____	4
Cable System With Cable Box to Unscramble Only Pay Channels _____	5
RCA DSS® Satellite Receiver _____	6-7
Connecting Two VCRs for Copying Tapes _____	8
Connecting a Stereo Amplifier/Receiver _____	9

Setting Up the VCR

Startup	
Check Accessories With VCR _____	10
Insert Batteries in Remote _____	10
Turn on TV and VCR _____	10
Place Channels in VCR's Memory _____	11
Add or Remove Channels from VCR's Memory _____	11
Use TV•VCR Button _____	12
Set the AUTO TV/VCR Feature _____	12
Set the Time and Date _____	13
Set the Automatic Daylight-Saving Time _____	13
Set Display Panel Brightness _____	13

Using the Remote Control

Component, VCR, TV, Cable Box, and RCA DSS® Receiver Buttons _____	14-15
Controlling a VCR _____	16
Controlling a TV _____	17
Controlling a Cable Box or RCA DSS® Receiver _____	18
Controlling an Auxiliary RCA Component _____	19

Playing a Tape

Operating Instructions _____	20
Using the Playback Features	
PLAYBACK: HI-FI/MIX/LINEAR Feature _____	21
Auto Play Feature _____	22
Auto Repeat Feature _____	22
DISPLAY Button _____	23
Time Counter _____	23
Pause for Stop-Action _____	24
Slow Motion _____	24
Picture Search _____	24
Automatic Tracking _____	24

Manual Tracking _____	24
Variable Speed Picture Search Using Shuttle Ring on the VCR _____	25
Variable Speed Picture Search and Frame Advance Using Jog Shuttle on the remote _____	25
Commercial Scan (SEARCH Button) _____	26
Index Search _____	26
Zero Search _____	27
Blank Search _____	27

Recording a Program

Types of Recordings _____	28
Basic Recording –	
Operating Instructions _____	28
Watch a TV Channel While VCR is Recording a Different Channel _____	28
Recording Features	
Recording Speeds _____	29
Recording Pause _____	29
Flying Erase Head _____	29
Automatic Head Cleaning _____	29
Express Recording _____	30
Recording Broadcast Stereo TV or SAP _____	31
Recording Audio Only _____	32
Recording While You're Away	
Setup Cable Box or RCA DSS® Satellite Receiver _____	33
VCR Plus+ Recording _____	34-35
Timer Recording _____	36
Checking or Clearing VCR Plus+ or Timer Recordings _____	35
Timer Recording From the VCR's Line Input _____	37
S-VHS Recording _____	38
Using Two VCRs for Copying and Editing Tapes _____	39
Audio and Video Dubbing _____	40-41

References

Location of Controls	
Front Panel _____	42
Back Panel _____	43
Display Panel _____	44
Specifications _____	45
Cleaning the VCR _____	45
Trouble Checks _____	46-48
Limited Warranty _____	49
Index _____	50-52

Choosing a Hookup

The hookups on pages 3 through 8 are divided into two hookup types: Basic (A) and Advanced (B).

The basic hookup shows the backs of TVs that have only an antenna/cable connection. It is the easier of the two and additional accessories may not be needed.

The advanced hookup shows the VCR hooked up to a monitor/receiver (TV with audio and video jacks) using a signal splitter. This connection may improve the picture quality as well as convenience of operation.

Answer the questions to choose the hookup for your VCR.

1. How do you receive your TV signals?

Choose one answer from below.

- A. Outside antenna – Turn to page 3.
- B. Rabbit ears (set-top) and/or bow tie antenna – Turn to page 3.
- C. Cable System – Go to question 2.
- D. RCA DSS® Satellite System and another source (A, B, C) – Go to question 3.

2. What type of Cable-TV system* do you have?

Choose one answer from below.

- A. Cable without a box – Turn to page 3.
- B. Cable box to unscramble all the channels – Turn to page 4.
- C. Cable box to unscramble only pay channels, such as HBO, Showtime, Cinemax, etc. – Turn to page 5.

*You may need to contact your local cable company for assistance.

3. What type of RCA DSS® satellite system** do you have?

Choose one answer from below.

- A. Satellite receiver connected to TV without audio/video inputs – Turn to page 6.
- B. Basic satellite receiver connected to TV with audio/video inputs – Turn to page 7.
- C. Deluxe satellite receiver connected to TV with audio/video inputs – Turn to page 7.

Optional Hookups

How to hook up two VCRs for copying tapes?

- A. Select a hookup by answering the questions above.
- B. Then, modify the connections as shown on page 8.

How to hook up a stereo amplifier/receiver?

- A. Select a hookup by answering questions 1 and 2 above.
- B. Then, modify the connections as shown on page 9.

**DSS® is a registered trademark of DIRECTV, INC., a unit of GM Hughes Electronics.

Antenna or Cable System Without a Cable Box

A. Basic hookup.

Use this hookup for a simple connection which requires fewer accessories.

1. Set the **3 CH. 4** switch on back of VCR to either channel 3 or 4.
Tune the TV to this channel and use the TV•VCR button to watch the VCR.
2. Connect as shown.
This connection may require additional accessories not provided.
3. Plug in power cords of VCR and TV.
4. **Continue to page 10.**

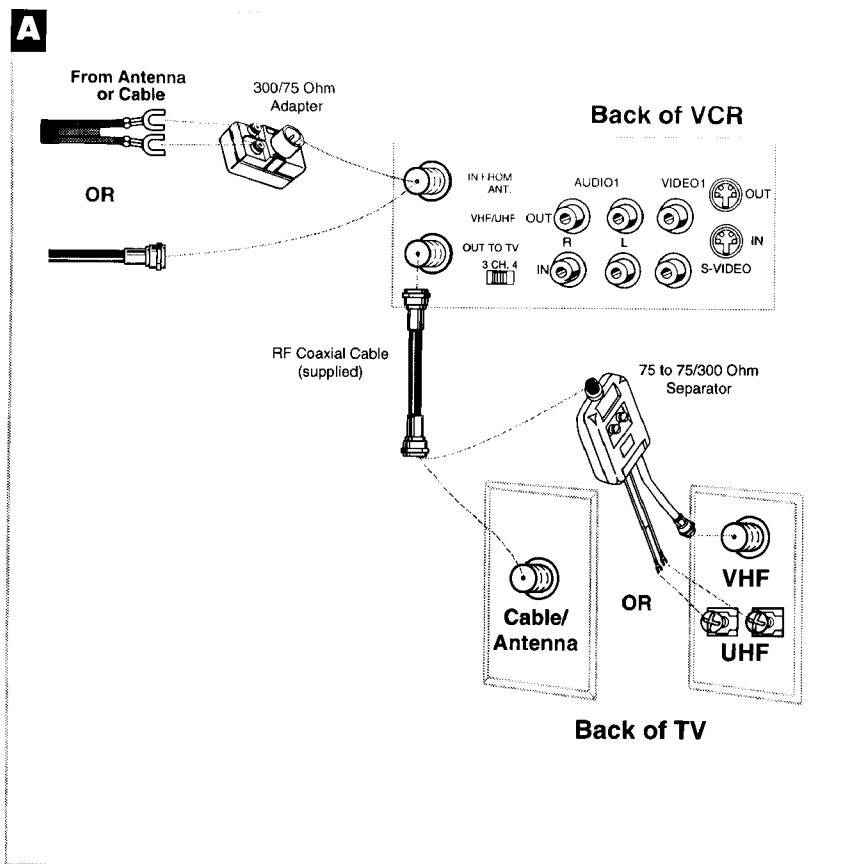

B. Advanced hookup.

Use this hookup for slightly improved picture quality and more convenient operation — use of the TV•VCR button is not required.

1. Connect as shown.
This connection requires additional accessories not provided.
If your TV/monitor has an S-VIDEO connector, also connect the supplied S-VHS cable to take advantage of S-VHS.
If your TV is not stereo, you may need a Y-adapter to hear sound from both channels.
2. Plug in power cords of VCR and TV.
3. **Continue to page 10.**

Tune the TV to its video input to watch the VCR. Set the AUTO TV/VCR feature to OFF. See page 12 for details.

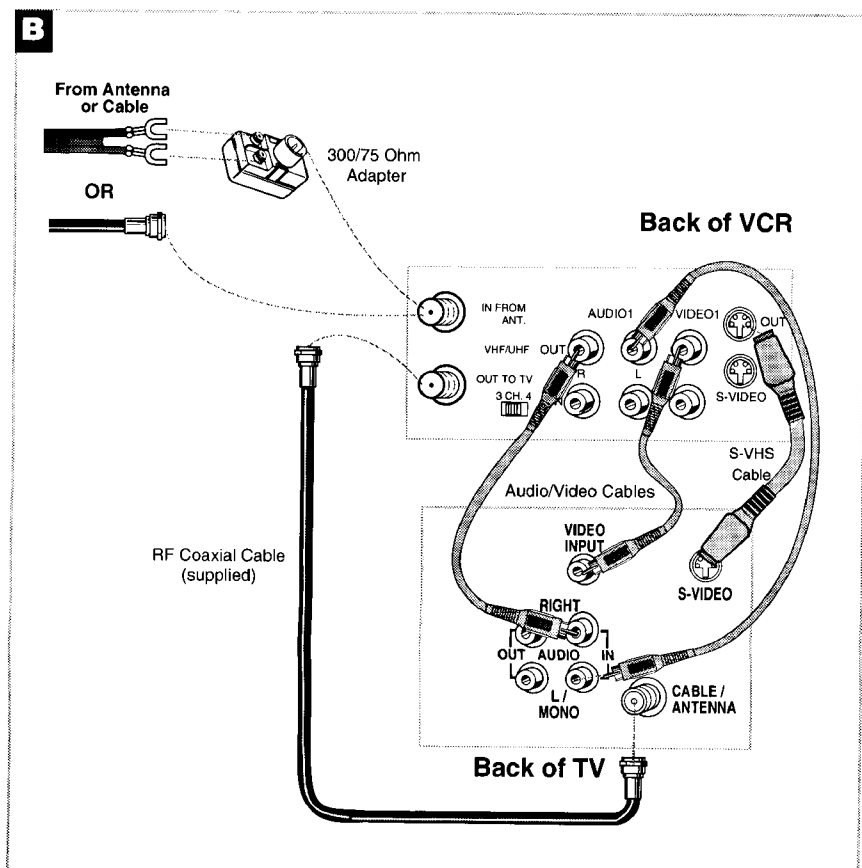

Cable System With Cable Box to Unscramble All Channels

Position Cable Box

Position the remote-controllable cable box on top of the VCR. You may need to position it at different angles before the VCR can control it. Make sure the cable box does not cover the transmitting window on top of the VCR.

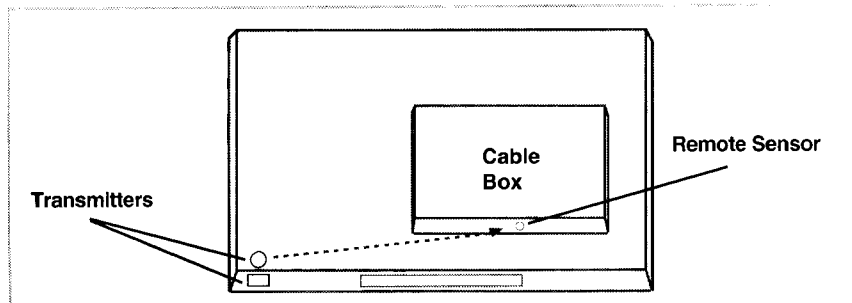

A. Basic hookup.

Use this hookup for a simple connection which requires fewer accessories.

1. Set the 3 CH. 4 switch on back of VCR to either channel 3 or 4.

Tune the TV to this channel and use the TV•VCR button to watch the VCR.

2. Connect as shown.

This connection may require additional accessories not provided.

3. Plug in power cords of VCR, TV, and cable box.

4. **Continue to page 10.**

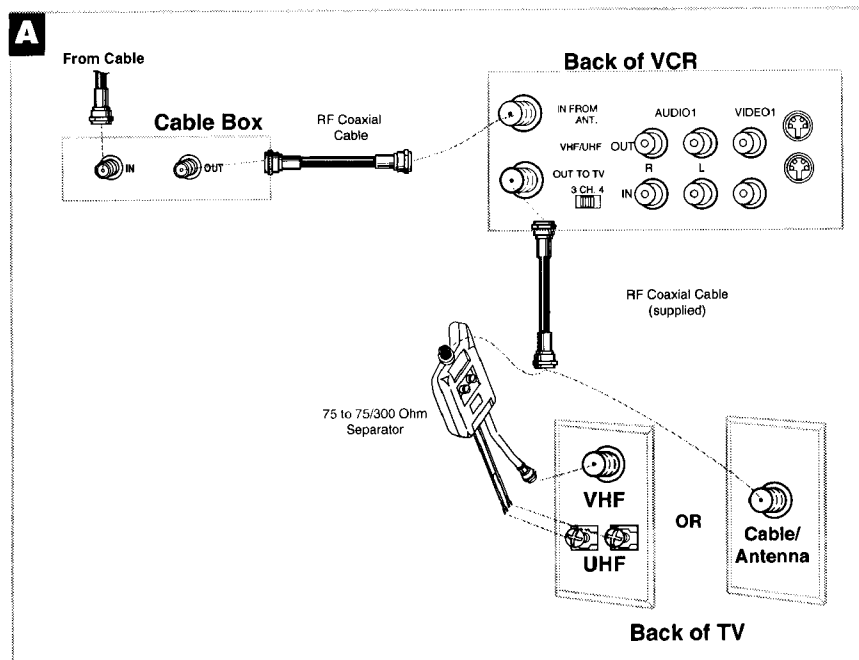

B. Advanced hookup.

Use this hookup for slightly improved picture quality and more convenient operation — use of the TV•VCR button is not required.

1. Connect as shown.

This connection requires additional accessories not provided.

2. Plug in power cords of VCR, TV, and cable box.

If your TV/monitor has an S-VIDEO connector, also connect the supplied S-VHS cable to take advantage of S-VHS.

If your TV is not stereo, you may need a Y-adaptor to hear sound from both channels.

3. **Continue to page 10.**

Tune the TV to its video input to watch the VCR. Set the AUTO TV/VCR feature to OFF. See page 12 for details.

Caution: The unauthorized recording of satellite broadcasts, television programs, or other materials may infringe the rights of others.

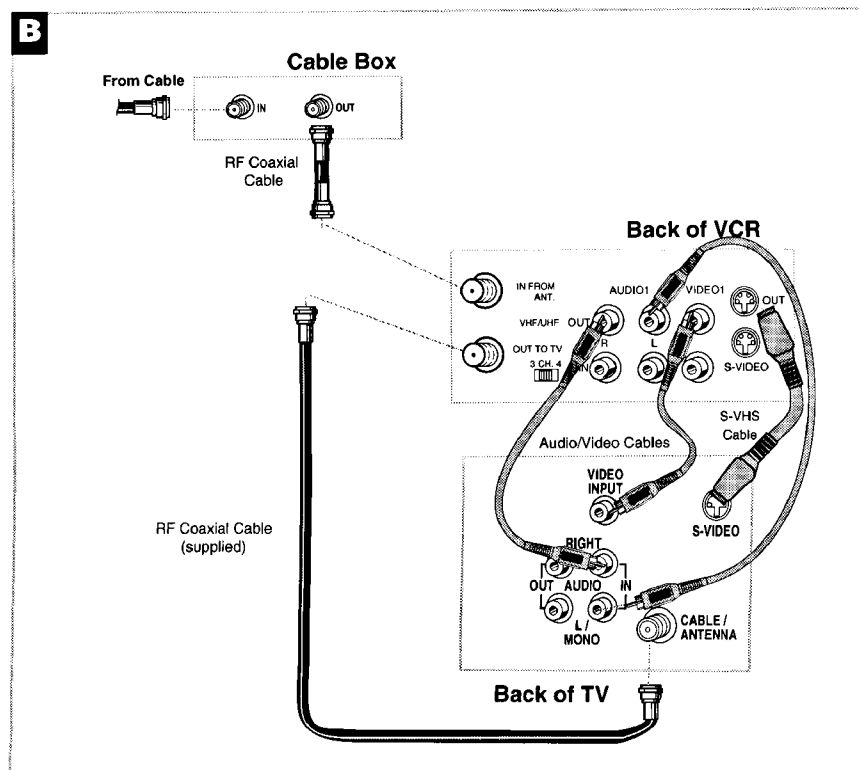

Cable System With Cable Box to Unscramble Only Pay Channels

(such as HBO, Showtime, Pay-Per-View, etc.)

Position Cable Box

Position the remote-controllable cable box on top of the VCR. You may need to position it at different angles before the VCR can control it. Make sure the cable box does not cover the transmitting window on top of the VCR.

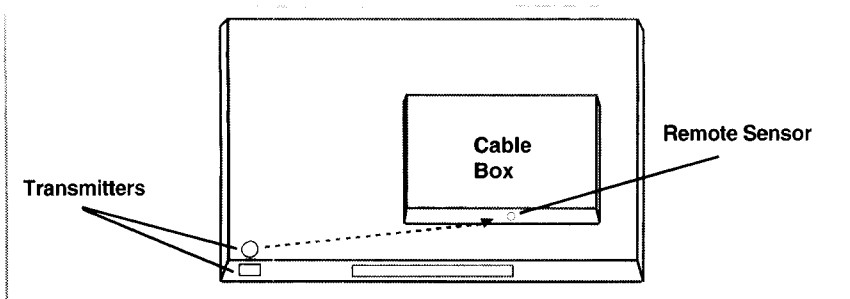

A. Basic hookup.

Use this hookup for a simple connection which requires fewer accessories.

1. Set the 3 CH. 4 switch on back of VCR to either channel 3 or 4.

Tune the TV to this channel and use the TV•VCR button to watch the VCR.

2. Connect as shown.

This connection may require additional accessories not provided.

3. Plug in power cords of VCR, TV, and cable box.

4. **Continue to page 10.**

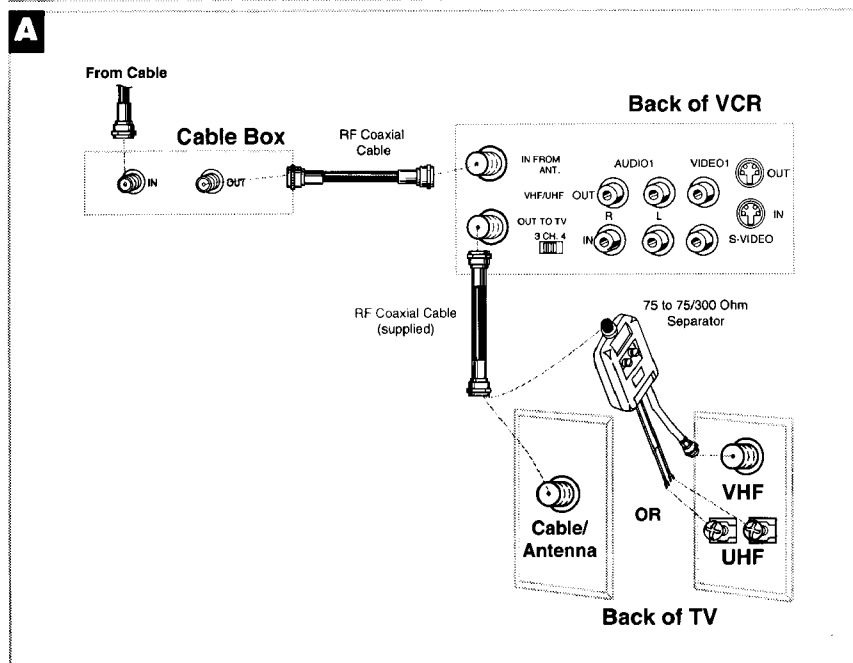

B. Advanced hookup.

Use this hookup for slightly improved picture quality and more convenient operation — use of the TV•VCR button is not required.

1. Connect as shown.

This connection requires additional accessories not provided.

If your TV/monitor has an S-VIDEO connector, also connect the supplied S-VHS cable to take advantage of S-VHS.

If your TV is not stereo, you may need a Y-adapter to hear sound from both channels.

2. Plug in power cords of VCR, TV, and cable box.

3. **Continue to page 10.**

Tune the TV to its video input to watch the VCR. View all pay channels through the VCR.

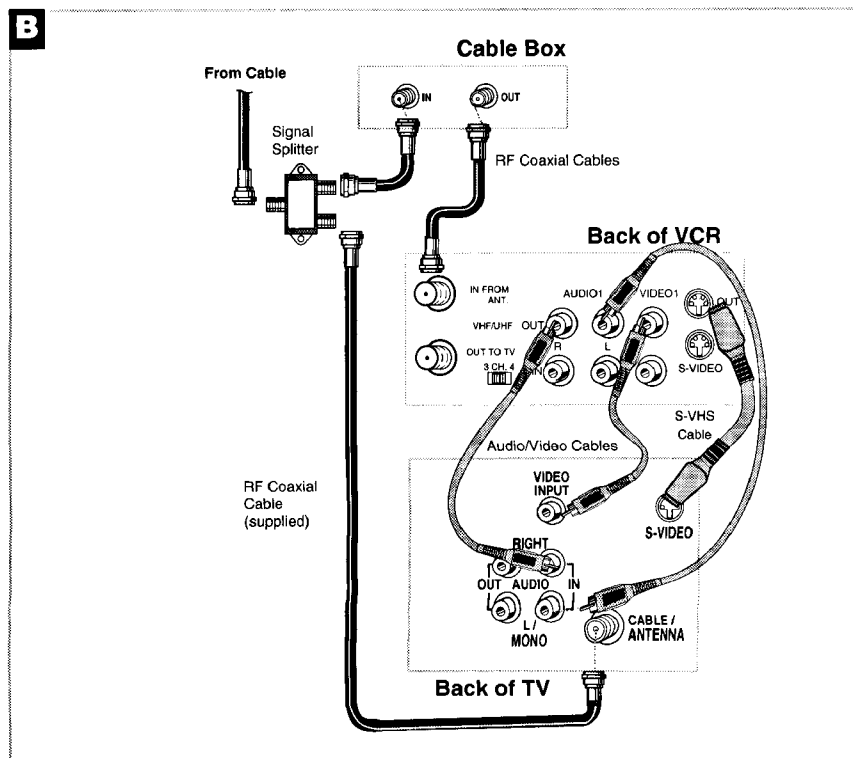

RCA DSS® Satellite Receiver

Position RCA DSS® receiver.

Position the receiver on top of the VCR. You may need to position it at different angles before the VCR can control it. Make sure the receiver does not cover the transmitting window on top of the VCR.

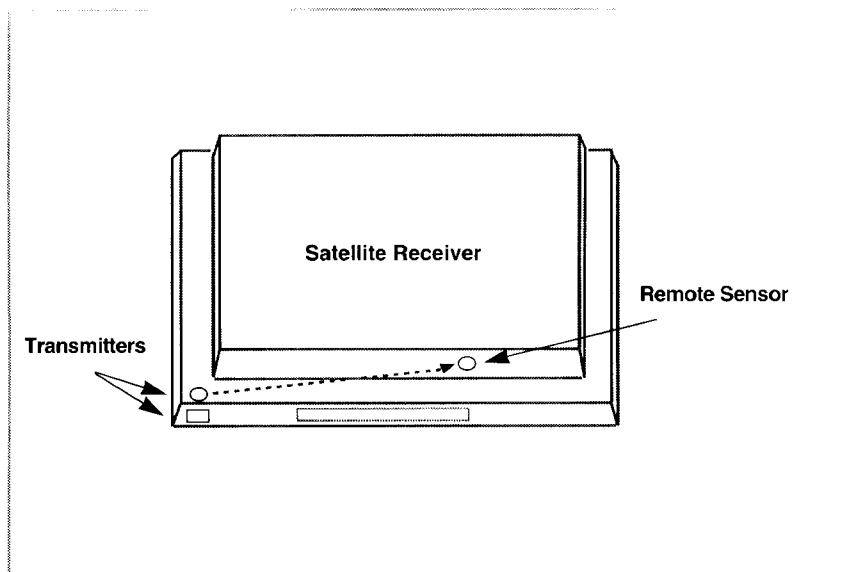

A. Basic hookup.

Use this hookup if your TV does not have audio/video jacks.

- 1. Set the CH3 CH4 switch on back of satellite receiver to either channel 3 or 4.**
You will tune the VCR to this channel or its line input (L1) to record from the receiver.
To watch the satellite receiver, turn off the VCR.
If you want to watch or record the signal from your antenna, cable, or cable box, make sure the satellite receiver is turned off.
- 2. Set the CH3 CH4 switch on back of VCR to either channel 3 or 4.**
You will tune the TV to this channel and use the TV•VCR button to watch the VCR.
- 3. Connect as shown.**
This connection may require additional accessories not provided.
- 4. Plug in power cords of VCR, TV, and receiver.**
- 5. Continue to page 10.**

Caution: The unauthorized recording of satellite broadcasts, television programs, or other materials may infringe the rights of others.

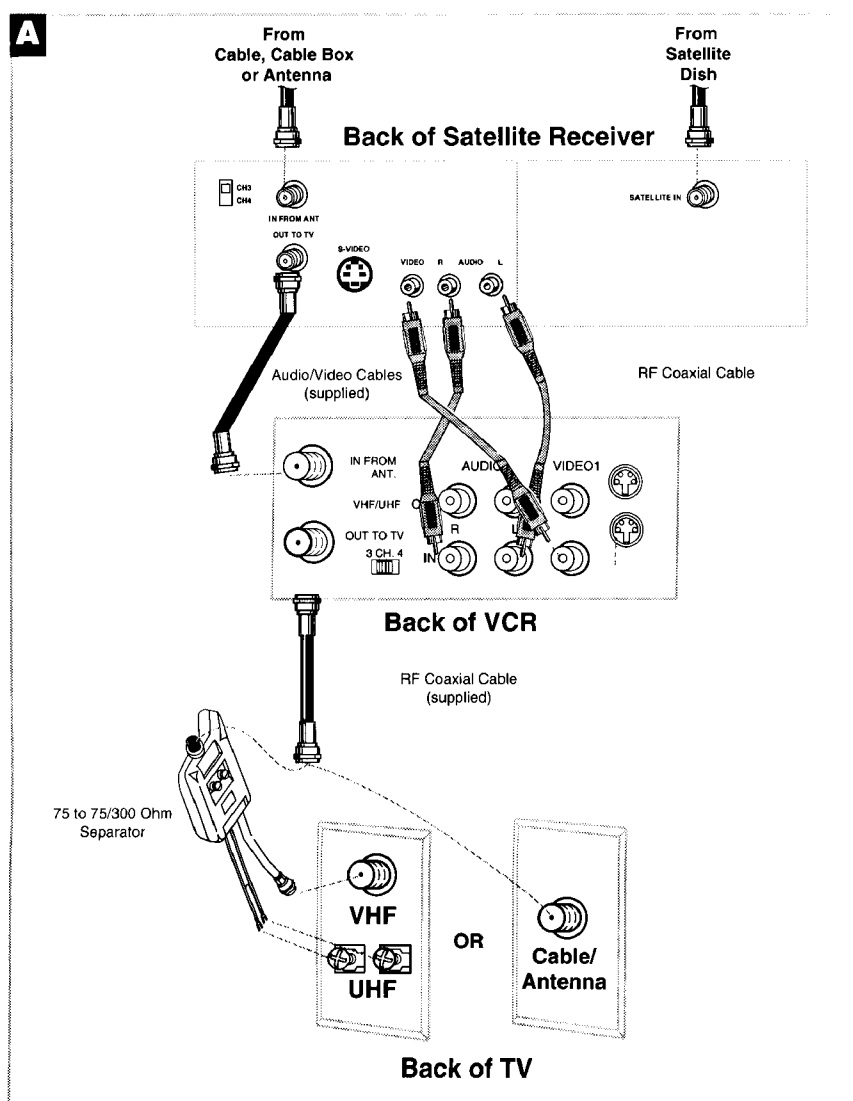

RCA DSS® Satellite Receiver

B. Advanced hookup with basic receiver.

Use this hookup if your TV has audio/video jacks and your receiver has one set of AUDIO/VIDEO jacks.

- 1. Set the CH3 CH4 switch on back of receiver to either channel 3 or 4.**

You will tune the VCR to this channel to record from the satellite receiver.

To watch the satellite receiver, tune your TV to its video input channel.

If you want to watch or record the signal from your antenna, cable, or cable box, make sure the satellite receiver is turned off.
- 2. Set the CH3 CH4 switch on back of VCR to either channel 3 or 4.**

You will tune the TV to this channel and use the TV•VCR button to watch the VCR.
- 3. Connect as shown.**

This connection may require additional accessories not provided.
- 4. Plug in power cords of VCR, TV, and receiver.**
- 5. Continue to page 10.**

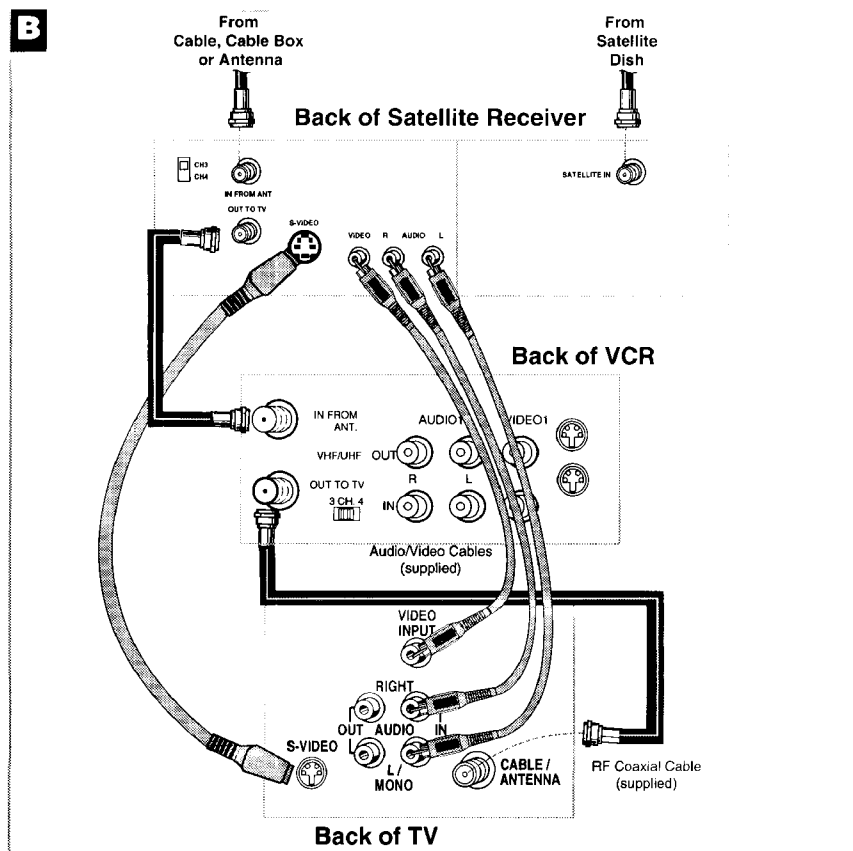

C. Advanced hookup with deluxe receiver.

Use this hookup if your TV has audio/video jacks and your receiver has two sets of AUDIO/VIDEO jacks.

- 1. Set the CH3 CH4 switch on back of VCR to either channel 3 or 4.**

You will tune the TV to this channel and use the TV•VCR button to watch the VCR.

To record from the satellite receiver, you will tune the VCR to its line input (L1).

To watch the satellite receiver, tune your TV to its video input channel.
- 2. Connect as shown.**

This connection may require additional accessories not provided.
- 3. Plug in power cords of VCR, TV, and receiver.**
- 4. Continue to page 10.**

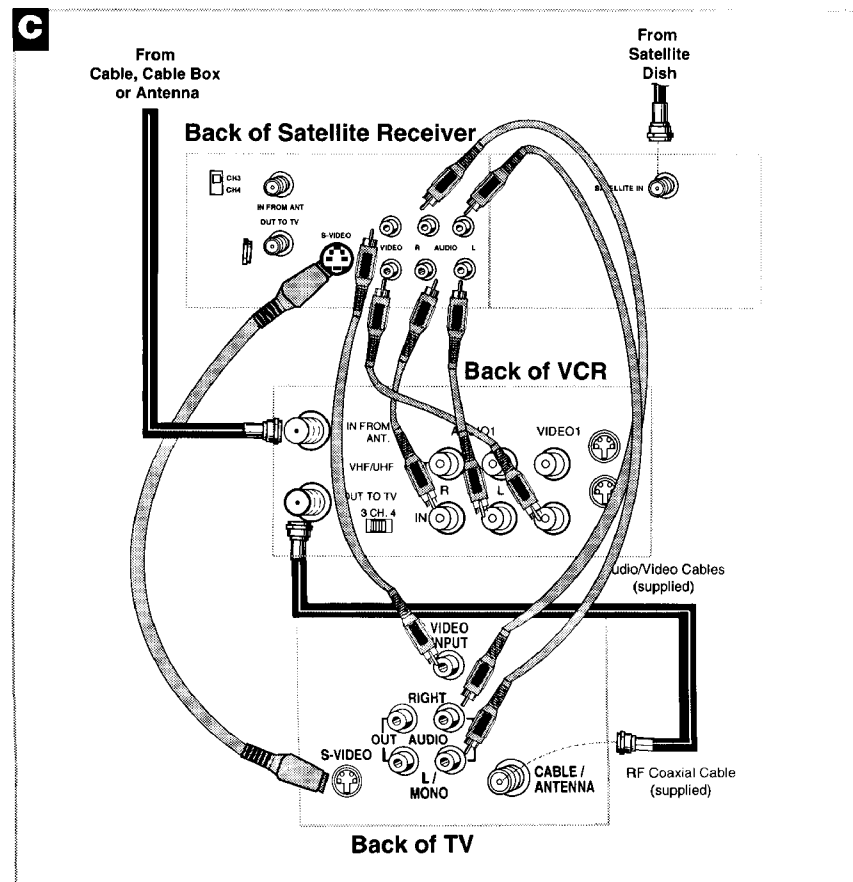

Caution: The unauthorized recording of satellite broadcasts, television programs, or other materials may infringe the rights of others.

Connecting Two VCRs for Copying Tapes

Option A hookup.

Use this hookup for a simple connection which requires fewer accessories.

1. Select a hookup from pages 2 through 5 and then modify with this connection.
2. Set the 3 CH. 4 switch on the playback VCR to either channel 3 or 4.
Tune the recording VCR to this channel to receive the signal from the playback VCR.
3. Connect as shown.
This connection may require additional accessories not provided.
4. Plug in power cords of VCRs and TV.
5. **Continue to page 10.**

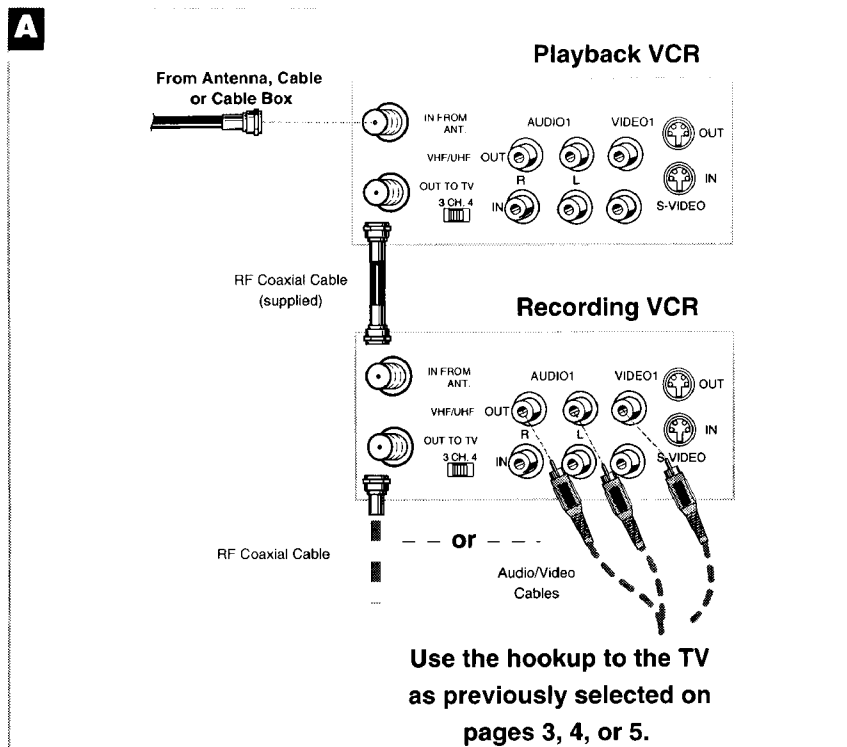

Option B hookup.

Use this hookup for slightly improved copy quality and more convenient operation — use of the TV•VCR button is not required.

1. Select a hookup from pages 2 through 5 and then modify with this connection.
2. Connect as shown.
This connection requires additional accessories not provided.
If your other VCR has an S-VIDEO connector, also connect the supplied S-VHS cable to take advantage of S-VHS.
If your VCR is not stereo, you may need a Y-adaptor to hear sound from both channels.
3. Plug in power cords of VCRs and TV.
4. **Continue to page 10.**

Select the line (audio/video) input ("L1" or "L2") on the recording VCR to receive the signal from the playback VCR.

Caution: The unauthorized recording of television programs and other materials may infringe the rights of others.

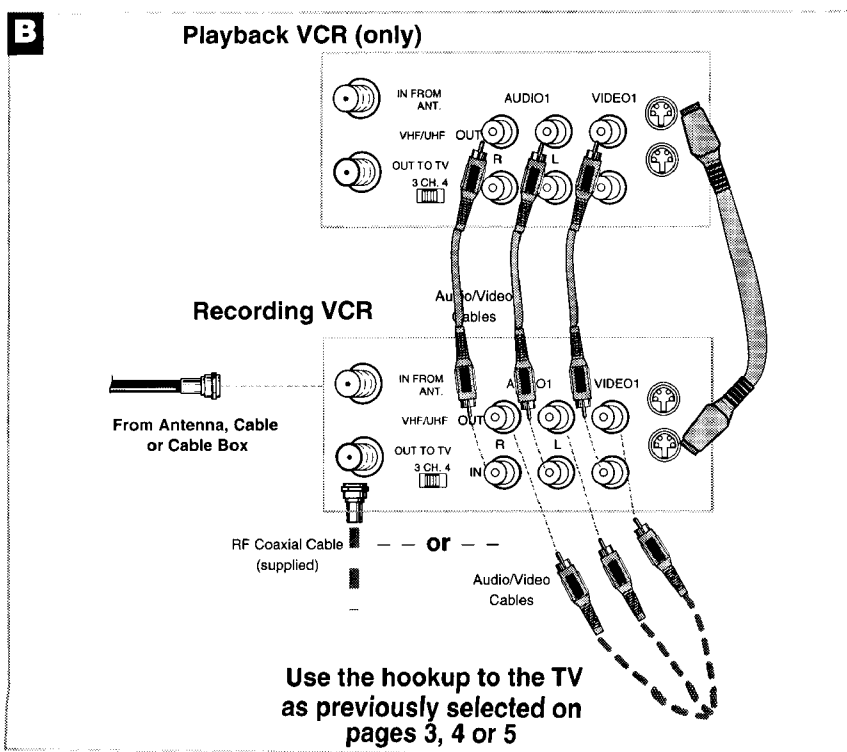

Front View for front audio/video input connection.

VIDEO 1: For rear audio/video connection.
VIDEO 2: For front audio/video connection.

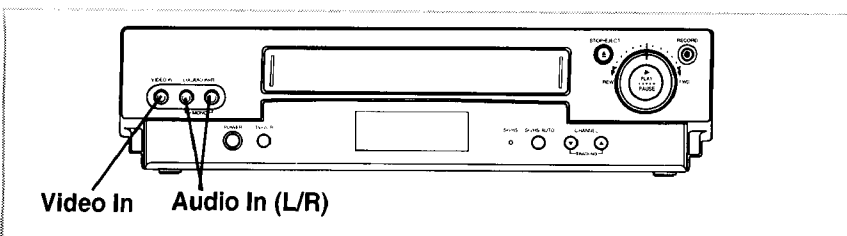

Connecting a Stereo Amplifier/Receiver

Record on the VCR from an amplifier/receiver.

Connect your VCR to a stereo amplifier/receiver to record stereo audio.

1. Select a hookup from pages 2 through 7 and then modify with this connection.

2. Connect as shown.

This connection requires additional accessories not provided.

3. Plug in power cords of amplifier/receiver, VCR, and TV.

4. Turn to page 32 for "Recording Audio Only."

Select the line input ("L1" or "L2") on the VCR to receive the audio signal from the amplifier/receiver.

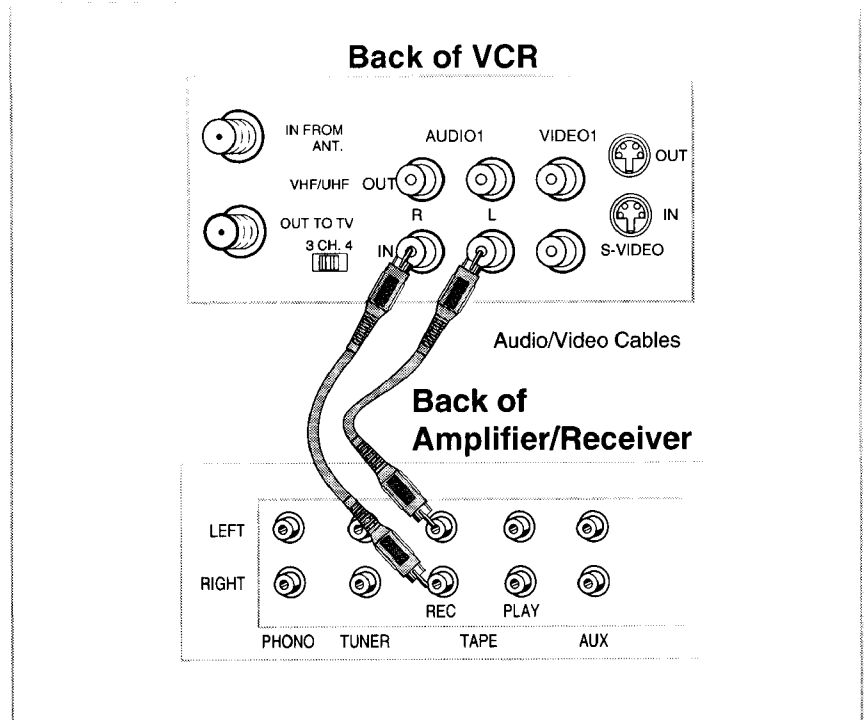

Play back stereo tapes or receive a stereo broadcast through an amplifier/receiver.

Connect your VCR to a stereo amplifier/receiver to receive stereo broadcasts or play back stereo tapes.

1. Select a hookup from pages 2 through 7 and then modify with this connection.

2. Connect as shown.

This connection requires additional accessories not provided.

3. Plug in power cords of amplifier/receiver, VCR, and TV.

4. Turn to page 20 for "Playback Operation."

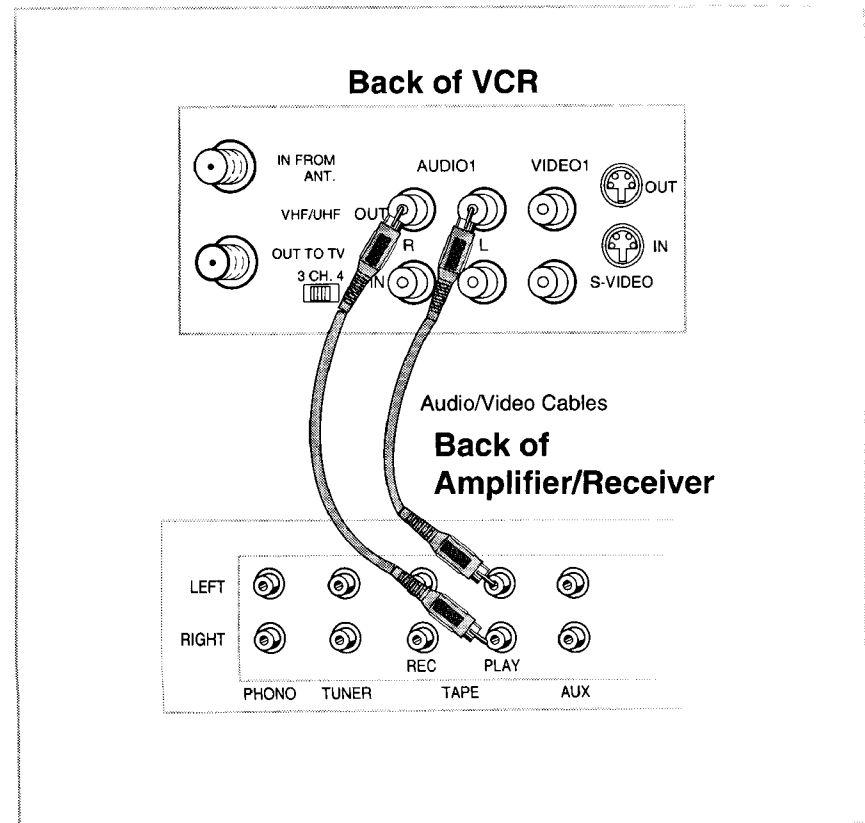

Startup

1. Check accessories with VCR.

Contact your dealer if any items are missing.

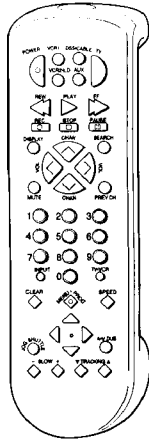

Remote (Stock No. 221321)

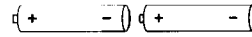

2 "AAA" Batteries

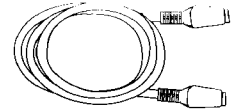

S-VHS Connecting Cable
(Stock No. 219748)



RF Coaxial Cable
(Stock No. 221383)

2. Insert batteries in remote.

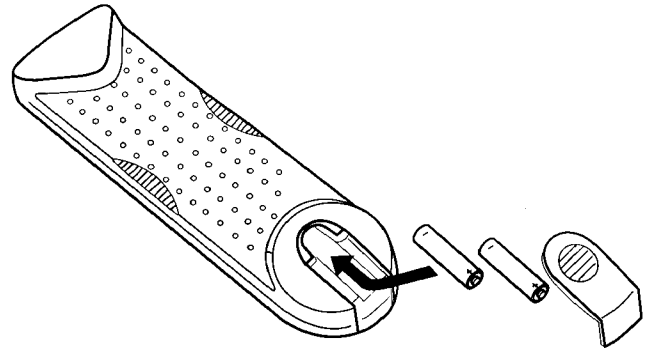
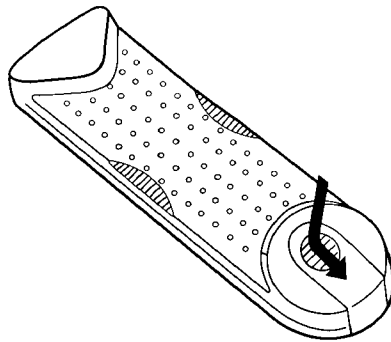

3. Turn on the TV.

- A. Turn on the TV.
- B. If you used one of the basic hookups, tune the TV to the channel selected with the 3 CH. 4 switch on back of VCR.
If you used one of the advanced hookups, tune the TV to the TV's video input.
(See TV owner's manual for details.)

4. Turn on the VCR.

- A. Press VCR1 on the remote.

Startup

5. Place channels in the VCR's memory.

The first time you turn on the VCR or after a power interruption, the VCR displays a message on the TV screen prompting you to perform an **AUTO CHANNEL SEARCH**. If the message does not appear, go to step A below. If the message appears, follow the directions on the screen.

Wait until the channel numbers stop changing. This takes about one to two minutes. Then, the TV tunes to the lowest channel found. Pressing **CHAN** up or down selects only the active channels.

If you ever need to manually **SETUP CHANNELS** on the VCR because you change cable or antenna signals:

- A. Press **MENU•PROG** to display the **VCR MAIN MENU** on the TV screen. If this menu does not appear:
 - Make sure TV is tuned to the same channel as the **3 CH. 4** switch on the VCR or the TV's video input (refer to the TV's manual).
 - Press **VCR1**, then press **MENU•PROG** again.
 - If you are using a basic hookup, the **VCR** indicator should be on. If it is not on, press **TV•VCR** to turn it on.
 - Check the connections.
- B. Press **4** to display the **CHANNELS** menu.
- C. Press **1** to begin **AUTO CHANNEL SEARCH**.

The VCR automatically selects **CABLE** (cable TV) or **ANTENNA**. If you need to change the setting manually, press **3**.

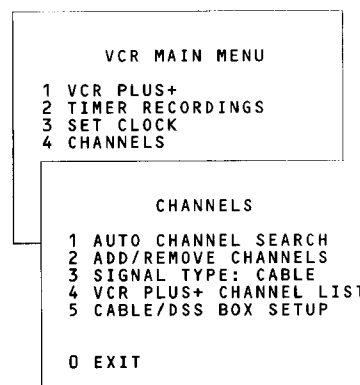
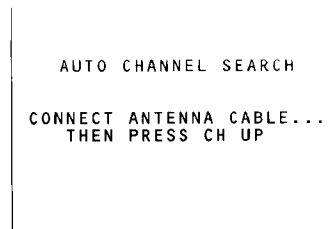

6. Add or remove channels from the VCR's memory.

You can add or remove channels if some of the channels are not active, have weak signals, or if you do not want to watch them.

We recommend channels be placed in memory using the **AUTO CHANNEL SEARCH** feature described in step 5 before adding or removing channels. Channels 2-13, L1 and L2 are present at the factory.

- A. Press **VCR1**.
- B. Press **MENU•PROG** on the remote to see the **VCR MAIN MENU** on the TV screen.
- C. Press **4** to display the **CHANNELS** menu.
- D. Press **2** to display the **ADD/REMOVE CHANNEL** menu.
- E. Follow the directions on the screen.
- F. You can add or remove more channels by entering channel numbers or using **CHAN** up or down.

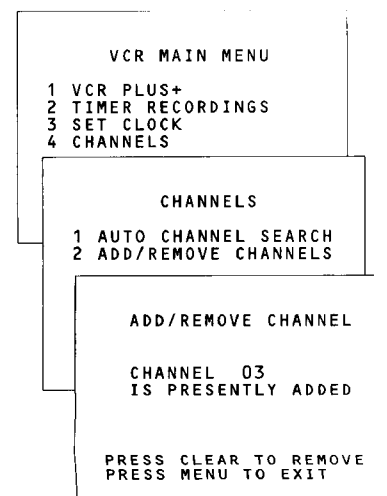

Startup

7. Use TV•VCR button.

Skip this step if you used one of the advanced hookups.

If you are using one of the basic hookups, the TV•VCR button lets you switch between the picture coming from the VCR and the picture from the TV channel. This button lets you record a program on the VCR while watching another channel on the TV. *Details are on page 30.*

- A. Press VCR1 to set the remote to control the VCR.
- B. Press TV•VCR to see the picture from the VCR.
The VCR indicator lights in the display panel.
- C. Press CHAN up or down to change channels on the VCR.
The channel number changes on the TV screen and in the display panel.
- D. Press TV•VCR to see the TV channels.
The VCR indicator does not light in the display panel.
Change channels using the TV's remote.
- E. Return the TV to the VCR viewing channel — CH3 or CH4.
- F. Press VCR1, then TV•VCR to switch back to the picture from the VCR.

8. Set AUTO TV/VCR feature.

Skip this step if you used one of the basic hookups.

If you connected your VCR using the video input of your TV, you can prevent the VCR indicator from turning on automatically.

- A. Press MENU•PROG on remote to see VCR MAIN MENU.
- B. Press 5 to display the PREFERENCES menu.
- C. Press 3 to select AUTO TV/VCR: ON or OFF.
 - Select ON if you are using one of the basic hookups and watch your VCR on channel 3 or 4 of your TV. Then, you can press the TV•VCR button to switch between the picture coming from the VCR (the VCR indicator is on) or television channels (the VCR indicator is off).
 - Select OFF if you are using one of the advance hookups and watch your VCR on the video input channel of your TV. The VCR indicator will not turn on automatically.

Pressing TV•VCR still turns the VCR indicator on or off.

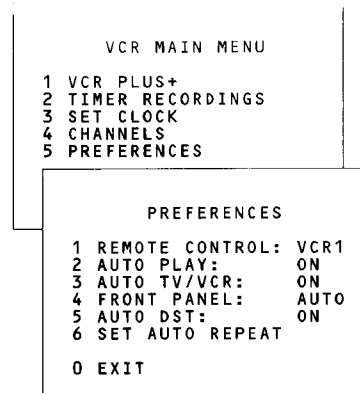

Startup

9. Set the time and date.

When you first turn on the VCR, --- appears in the clock area of the VCR's display panel.

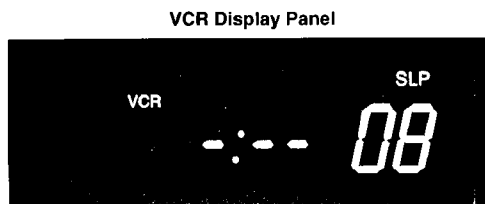

- A. Press MENU•PROG on the remote to see the VCR MAIN MENU.
- B. Press 3 to display SET CLOCK.
- C. Enter the time and date with the number buttons on the remote.
 - Press 0 before single-digit numbers.
Example: press 0, then 5, then 0, then 7 for a time of 5:07. Press 1 for AM or 2 for PM.
 - Press CLEAR on the remote to change incorrect entries.
- D. Press MENU•PROG on the remote to remove SET CLOCK from the TV screen and start the clock. The time appears in the VCR's display panel, and the time and date appear on the TV screen when you press DISPLAY on remote.

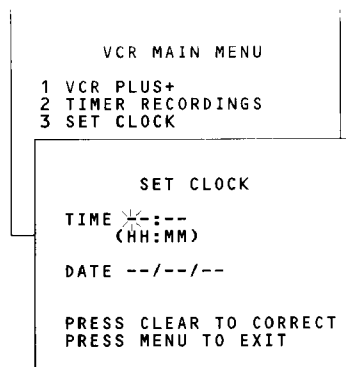

10. Set the Automatic Daylight-Saving Time

Select this feature if you want the VCR's clock to advance one hour in April and reverse one hour in October automatically.

- A. Press MENU•PROG on the remote to display the VCR MAIN MENU.
- B. Press 5 to display the PREFERENCES menu.
- C. Press 5 to select an AUTO DST mode.
 - Select ON if you want the VCR's clock to adjust for Daylight Saving Time automatically.
 - Select OFF if you do *not* want the VCR's clock to adjust for Daylight Saving Time automatically.

In the Spring, daylight-saving time begins on the first Sunday in April. Clocks are set forward one hour.

Because the clock automatically changes from 2:00 AM to 3:00 AM, remember that any part of a scheduled Timer Recording that falls between these two times will not be recorded

In the autumn, daylight-saving time finish on the last Sunday in October. Clocks are set back one hour.

The VCR clock automatically changes from 2:00 AM to 1:00 AM. Therefore, it can affect your recording length.

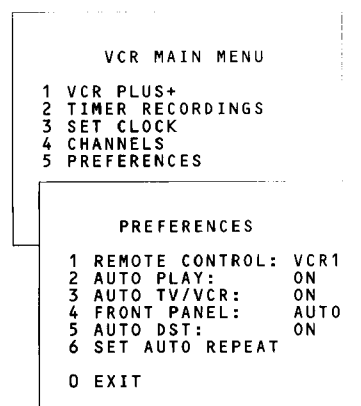

11. Select the display panel brightness.

You can change the brightness level of the fluorescent display panel.

- A. Press MENU•PROG on remote to see the VCR MAIN MENU.
- B. Press 5 to display the PREFERENCES menu.
- C. Press 4 to select a FRONT PANEL mode.
 - Select AUTO to keep the display panel bright when VCR is on and dim when it is off.
 - Select BRIGHT to keep the display panel bright.
 - Select DIM to keep the display panel dim.

Buttons

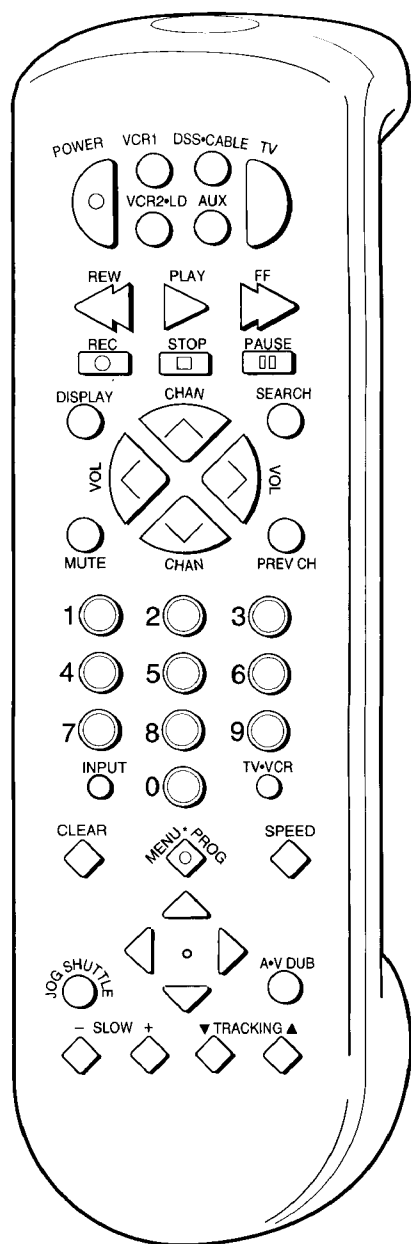

Component Buttons

Press one of the buttons to set the remote to operate that component.

AUX (Auxiliary)

Used with **POWER** button to turn on a compatible RCA audio component. *See page 19.*

DSS•CABLE

Used with **POWER** button to turn on a compatible cable box or satellite receiver. *See page 18.*

TV

Turns on a compatible RCA, ProScan, or GE TV and sets the remote to control the TV.

Used with **POWER** button to turn on another brand of TV when the remote is programmed to control that TV. *See page 17.*

VCR1

Turns on a compatible RCA, ProScan, or GE VCR and sets remote to control VCR.

VCR2•LD

Turns on a compatible RCA, ProScan, or GE VCR and sets remote to control VCR when it has been setup. *See page 16.*

Used with **POWER** button to turn on compatible RCA or ProScan LaserDisc player.

VCR Function Buttons

Press **VCR1** (**VCR2•LD**) to set the remote to control the VCR and use the function buttons.

A•V DUB

Used for audio and video dubbing. *See pages 42-43.*

CHAN (Channel) Up or Down

Selects next higher or lower channel in the VCR's channel memory.

CLEAR

Resets time counter to 0:00:00.

Lets you change entries when setting the clock or VCR for a VCR Plus+ or a timer recording.

DISPLAY

Displays VCR operating displays on the TV screen.

Displays the time counter.

FF (Fast Forward)

Fast forwards the tape when the VCR is stopped.

Searches the picture in forward motion during playback.

INPUT

Turns the line input ("L1" or "L2") on or off.

Line input refers to the signal coming from the component connected to the audio/video jacks on the back or the front of the VCR.

JOG SHUTTLE and

Used for frame advance.

Used for variable speed search.

The indicator in the center of the arrow buttons lights when the jog shuttle is turned on.

MENU•PROG

Displays the VCR MAIN MENU on the TV screen.

Removes a menu from the screen.

Numbers (0 through 9)

Select a channel up to 99—press two numbers.

Select a cable channel over 99—press and hold **1** until **1--** appears on the screen. Then, press the other two numbers.

Buttons

VCR Function Buttons

(continued)

PAUSE

Pauses action for viewing during playback.

Pauses recording to prevent recording of unwanted scenes.

PLAY

Plays a tape.

POWER

Turns off VCR when remote is set to control the VCR.

PREV CH (Previous Channel)

Switches between two channels.

Select one channel and then select another. Press PREV CH to switch between the two channels.

REC

Starts VCR recording.

Used for express recording.

See page 30.

REW (Rewind)

Rewinds the tape when the VCR is stopped.

Searches the picture in reverse motion during playback.

SEARCH

Displays INDEX, ZERO, and BLANK search menus on TV.

Advances tape 60 seconds during playback.

SLOW - / +

Used for slow-motion playback.

SPEED (Tape Speed)

Selects a recording speed (SP, LP, SLP).

STOP

Stops the normal functions such as record, playback, rewind, fast forward, and pause of the VCR.

TRACKING Up or Down

Lets you manually reduce the streaks that may appear on the picture during play, slow, or pause.

Reduces picture "jitter" during stop-action playback.

TV•VCR

Switches the picture signal so that it either comes from the VCR or the TV channel. See page 12.

TV Function Buttons

Press the TV button to set remote to control a compatible TV. Some buttons may not work with the TV.

CHAN (Channel) Up or Down

Selects next higher or lower channel in the TV's channel memory when remote is set to control a TV.

CLEAR

Removes menus from the screen.

DISPLAY

Shows the status displays on the screen.

Removes displays from the screen.

POWER

Turns off a compatible TV when remote is set to control that TV.

Used with TV button to turn on a compatible TV that the remote has been programmed to control. See page 17.

MUTE

Turns the TV sound on or off.

Numbers (0 through 9)

Select a channel up to 99 by pressing two numbers.

To select a cable channel over 99, press and hold 1 until 1-- appears on the screen. Then press the other two numbers.

PREV CH (Previous Channel)

Switches between two channels.

Select one channel and then select another. Press PREV CH to switch between the two channels.

VOL (Volume) Up or Down

Raises and lowers sound.

Cable Box or RCA DSS[®] Receiver Function Buttons

Press the CABLE button to set remote to control a compatible cable box or RCA satellite receiver. Some buttons may not work with the cable box or receiver.

CHAN (Channel) Up or Down

Selects next higher or lower channel in the cable box's or satellite receiver's channel memory when remote is set to control it.

Numbers (0 through 9)

Used to select a channel.

POWER

Turns off a compatible cable box or satellite receiver when remote is set to control it.

Controlling a VCR

The VCR's remote controls compatible RCA, ProScan, or GE VCRs with the VCR1 and VCR2•LD buttons. Most compatible VCRs automatically respond to VCR1 without being programmed. If you own two compatible VCRs, test them to see if VCR1 turns on both VCRs. If it does, then you may want to program this VCR to respond to the VCR2•LD button on the remote.

Program the VCR for Remote Control

Set the REMOTE CONTROL feature of the VCR to the VCR1 or VCR2 position. Then, the remote controls the VCR with either the VCR1 or VCR2•LD button — the position you select in the menu.

1. Press MENU•PROG to display the VCR MAIN MENU.
2. Press 5 to display the PREFERENCES menu.
3. Press 1 to activate the REMOTE CONTROL feature.
4. Press VCR1 or VCR2•LD to change the setting and program this VCR to respond to the VCR1 or VCR2•LD button — the position you select.

Important Reminder: Remember you must press VCR1 or VCR2•LD on the remote — the position you selected in the menu — before the remote will operate this VCR.

```
VCR MAIN MENU
1 VCR PLUS+
2 TIMER RECORDINGS
3 SET CLOCK
4 CHANNELS
5 PREFERENCES
```

```
PREFERENCES
1 REMOTE CONTROL: VCR1
2 AUTO PLAY: ON
3 AUTO TV/VCR: ON
3 FRONT PANEL: AUTO
4 AUTO DST: ON
5 SET AUTO REPEAT
0 EXIT
```

Controlling a TV

The VCR's remote is preprogrammed to control the basic functions of a compatible RCA, ProScan, or GE TV. The remote can also be set up to control other manufacturer's brands. To program the remote, enter remote code numbers that correspond to your brand.

Program the Remote for a TV

1. Turn on the TV.
2. Point the VCR remote at the TV.
3. Hold the TV button and press two number buttons to enter the code for your brand. If the TV changes channels when you press CHAN up or down, setup is complete.
4. Release the buttons.
5. Repeat steps 2 – 4 with a different code if the first one does not work.

Helpful Hint: Notice the difference between the TV and VCR on-screen displays. This is one way to tell if the remote is set to control the VCR or the TV.

Brand *	Code Number(s)	Brand *	Code Number(s)
Akai	03	NAD	07,08
AOC	06,12	NEC	06,12
Candle	06	Panasonic	04,11
Citizen	06	Philco	04,06,12
Colortyme	06	Philips	03,04,06
Concerto	06	Pioneer	06
Curtis Mathes	01,06	Portland	06,12
Daewoo	06,12	ProScan	01
Daytron	06	Proton	06
Electrohome	06	Quasar	11
Emerson	06	Radio Shack	01,05,13
Envision	05,06	RCA	01,06,12
Fisher	05	Realistic	05
GE	00,01,06,11	Sampo	06
Goldstar	06,12	Samsung	06,09,12
Hallmark	06	Sanyo	05
Hitachi	06,14	Sears	01,05,06,07,08,10
Infinity	04	Sharp	06,13
J C Penney	00,01,06,09,12	Sony	03
JBL	04	Soundesign	06
Jensen	06	Sylvania	04,06
JVC	10,11	Technics	11
Kawasho	03,06	Techwood	06
Kenwood	06	Teknika	06
Loewe	04	TMK	06
Luxman	06	Toshiba	05,07,08,09
LXI	04,05,07	Universal	00
Magnavox	04,06	Victor	10
Marantz	04	Wards	00,01,04,06,12,13
Marantz	04,06	Yamaha	12
MGA	06,12	Zenith	02
Mitsubishi	06,12		
MTC	06,12		

* The remote may not be able to control every model TV of the brands listed.

Operate the TV

After you set up your remote to control your TV, test the TV buttons to see which ones operate your TV.

1. Point the remote at the TV and press TV.
2. If TV does not turn on in step 1, press TV and then POWER.
3. Use the "TV Function Buttons" as described on page 15.

Controlling a Cable Box or an RCA DSS® Receiver*

The CABLE button on the VCR's remote is preprogrammed to control either a compatible RCA cable box or satellite receiver. If your cable box is another manufacturer's brand and has its own remote, you will probably be able to program the VCR's remote to control your cable box. To program the VCR's remote, enter the code that corresponds to your brand.

Program the remote

1. Turn on the cable box.
2. Point the VCR remote at the cable box.
3. Hold the CABLE button and press two number buttons to enter the code for your brand.
4. Release the buttons.
5. Press POWER on the remote. If the cable box turns off, setup is complete.
6. Repeat steps 2 – 4 with a different code if the first one does not work.

Brand of Cable-TV Box or RCA DSS®	Code Number(s)
ABC	53,54
Anvision	07, 08
Cablestar	56
Diamond	07, 08
Eagle	07,08
Eastern International	02
General Instrument	04, 05, 15, 23, 24, 25, 30, 36
Hamlin	12, 13, 34,48
Hitachi	37, 43
Jerrold	04, 05, 15, 23, 24, 25, 30, 36, 45, 46,47
Macom	37, 43
Magnavox	07, 08, 19, 26, 28, 29, 32, 33, 40, 41
NSC	09
Oak	01, 16, 38
Oak Sigma	16
Panasonic	03, 27, 39
Philips	07, 08, 19, 26, 28, 29, 32, 33, 40, 41
Pioneer	18, 20, 44
Randtek	07, 08
RCA	60, 27
RCA DSS®	00
Regal	12, 13
Regency	02, 33
Samsung	44
Scientific Atlanta	03, 22, 35
Stargete2000	58
Sylvania	11, 59
Teknika	06
Texscan	10, 11, 59
Tocom	17, 21, 49, 50, 55
Unika	31, 32, 41
Universal	51, 52
Viewstar	07, 08, 19, 26, 28, 29, 32, 33, 40, 41
Warner Amex	44
Zenith	14, 42, 57

* The remote may not be able to control every cable box of the brands listed.

Operate the Cable Box or Satellite Receiver

After you set up your remote (if required) to control your cable box, test the buttons to see which ones operate your cable box or satellite receiver.

1. Point the remote at the cable box or satellite receiver and press CABLE.
2. If the cable box or receiver does not turn on in step 1, press CABLE, then POWER.
3. Use the "Cable Box or RCA Digital Satellite Receiver Function Buttons" for the cable box and test the "TV Function Buttons" to see which ones operate the satellite receiver.
See page 15.

*DSS® is a registered trademark of DIRECTV, Inc., a unit of GM Hughes Electronics.

Controlling an Auxiliary RCA Component

The remote that came packed with your VCR is also capable of controlling one compatible RCA audio component, such as an AM/FM radio, CD player, tape player, or phonograph. The remote must be programmed for the specific component it is to control. To program the remote, use the code that corresponds to your component.

Program the Remote for an Auxiliary Component

1. Turn on the component.
2. Point the VCR remote at the component.
3. Hold the **AUX** button and press two number buttons to enter the code for your component.
4. Release the buttons.
5. Press **POWER** on the remote. If the component turns off, setup is complete.

Type of Auxiliary Audio Equipment and Code*				
	AM/FM	CD	Tape	Phono
RCA	03	07	06	05

* The remote may not be able to control every RCA model of audio equipment listed.

Operate the Auxiliary Component

After you have set up your remote to control your component, test the buttons to see which ones operate the component.

1. Point the remote at the component and press **AUX**.
2. If the component does not turn on in step 1, press **AUX** and then **POWER**.
3. Test the buttons on the remote to see which ones operate your component.

Operating Instructions

To Play a Tape

1. Turn on the TV and tune it to channel 3, 4, or the TV's video input to see the picture from the VCR.
2. Insert a tape in the VCR.

VCR automatically turns on. The cassette-in indicator () lights, and the VCR indicator lights if the AUTO TV/VCR feature is set to ON. The tape automatically begins playback if the safety tab on the cassette has been removed and the AUTO PLAY feature is turned on.

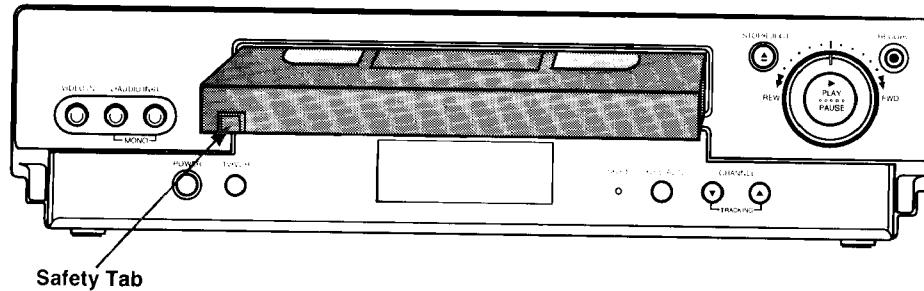

3. Press PLAY•PAUSE on the VCR or PLAY on the remote, if necessary. The playback indicator (▶) appears in the VCR's display panel.
4. Press TRACKING up or down to remove any streaks from the picture, if necessary. *Details are on page 25.*
5. Press STOP•EJECT on the VCR or STOP on the remote.
6. Press REW on the VCR or remote.
The VCR automatically rewinds the tape if it reaches the end of the tape during playback. Also, while a tape is rewinding, if you press POWER, the VCR turns off after rewinding complete.
7. Press STOP•EJECT on the VCR to eject the tape once it is completely rewound.

Using the Playback Features

TAPE PLAYBACK: HI-FI/MIX/LINEAR Feature

The VCR records the same audio on both the Hi-Fi and linear tracks on the tape. The Hi-Fi sound is recorded on separate left and right stereo channels. Monaural sound is recorded on the linear track.

To enjoy Hi-Fi sound, connect your VCR to a stereo television or amplifier/receiver using the audio/video jacks. The TAPE PLAYBACK: HI-FI/MIX/LINEAR feature lets you select which audio you play back.

To Select Playback Sound

1. Press MENU•PROG to display the VCR MAIN MENU.
2. Press 6 to display the AUDIO menu.
3. Press 2 to switch between HI-FI, MIX, or LINEAR sound.
 - Select HI-FI to play back sound recorded on the Hi-Fi track and for normal use.

The Hi-Fi indicator lights in the VCR's display panel.

- Select MIX to play back the sound recorded on both the linear track and the Hi-Fi track, sound-on-sound.

The Hi-Fi indicator lights in the VCR's display panel.

- Select LINEAR to play back the sound recorded on the linear monaural track, such as a second audio program (SAP).

The Hi-Fi indicator turns off in the VCR's display panel.

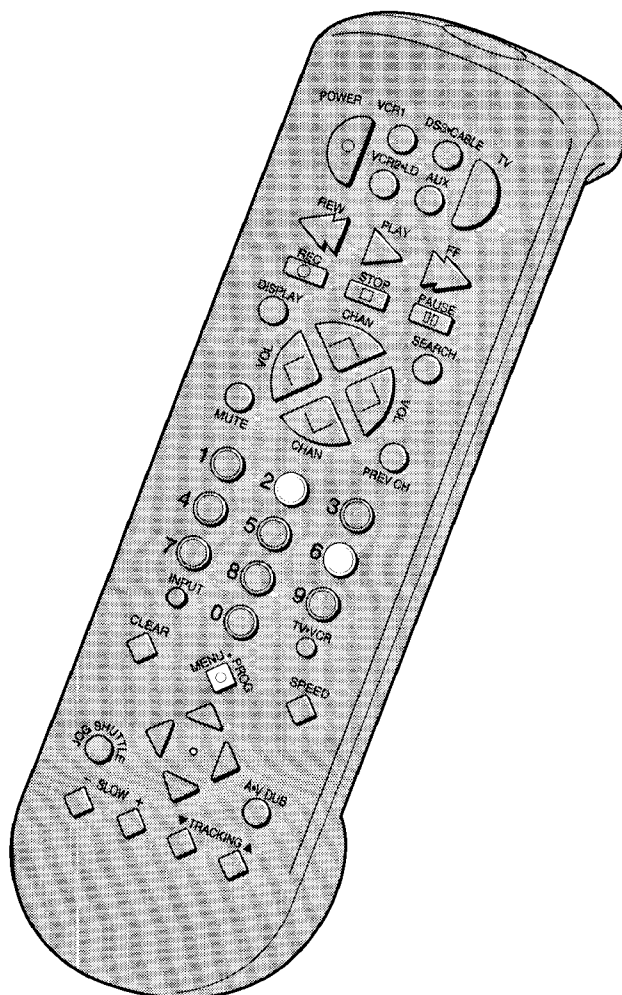
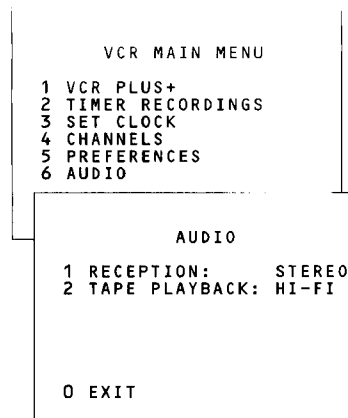

Using the Playback Features

AUTO PLAY Feature

This feature lets you tell the VCR whether to start playing automatically when you insert a tape with its safety tab removed.

1. Press MENU•PROG on the remote to see the VCR MAIN MENU.
2. Press 5 to display the PREFERENCES menu.
3. Press 2 again to select AUTO PLAY: ON or OFF.
 - Select ON if you want a tape with its safety tab removed to start playing automatically.
 - Select OFF if you do *not* want a tape with its safety tab removed to start playing automatically.

VCR MAIN MENU

- 1 VCR PLUS+
- 2 TIMER RECORDINGS
- 3 SET CLOCK
- 4 CHANNELS
- 5 PREFERENCES

PREFERENCES

- 1 REMOTE CONTROL: VCR1
- 2 AUTO PLAY: ON
- 3 AUTO TV/VCR: ON
- 4 FRONT PANEL: AUTO
- 5 AUTO DST: ON
- 6 SET AUTO REPEAT
- 0 EXIT

AUTO REPEAT Feature

When you set this feature, the VCR plays a tape for the amount of time you specify, over and over. For example, if you enter a length of two hours, the VCR will play the tape for two hours, automatically rewind the tape, and play the tape again.

1. Press MENU on the remote to display the VCR MAIN MENU
2. Press 5 to display the PREFERENCES menu.
3. Press 6 to display the SET AUTO REPEAT menu.
4. Set the length of time you want the tape to play in a repeating loop.
 - Press CLEAR on the remote to correct the length.
 - Select a length of 0:00 with the CLEAR button if you do not want the tape to repeat.
 - Eject the tape to cancel the repeat feature.
 - If the time you enter exceeds the actual length of the tape, the VCR plays to the end of the tape.

AUTO REPEAT MENU

SET THE LENGTH OF TIME
YOU WANT THE TAPE TO
PLAY IN A REPEATING LOOP

LOOP FROM 0:00 TO --:--
(H:MM)

PRESS MENU TO EXIT

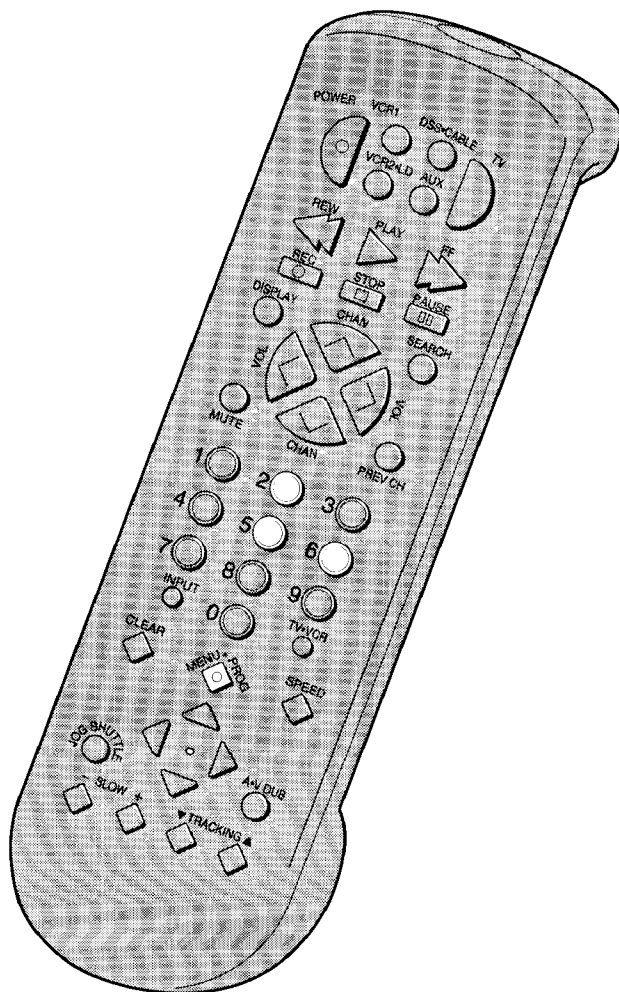

Using the Playback Features

DISPLAY Button

1. Press DISPLAY to display the status of the VCR, channel number, time counter, date, time, and tape speed on the TV screen.
The time and date must be set before they can be displayed. If you do not press DISPLAY again, this display times out.
2. Press DISPLAY again to continually display the time counter on the TV screen. The time counter appears instead of the time in the VCR's display panel.
3. Press DISPLAY again to remove the time counter from the screen. No displays appear on the TV screen and the time counter remains in the VCR's display panel. This is convenient for editing tapes.
3. Press DISPLAY again to return to the normal status displays. The clock appears in VCR's display panel.
Turning off the VCR automatically returns the displays to normal.

Time Counter

The time counter shows the actual time it takes to record a program or play back a segment of a prerecorded tape. It helps locate the beginning or end of programs you taped. The time counter resets to 0:00:00 whenever the tape is ejected from the VCR.

For example, if a 30-minute program was recorded at the beginning of the tape, you would:

1. Insert the prerecorded tape.
2. Press DISPLAY twice to display only the time counter on the TV screen.
3. Use SHUTTLE Ring on the VCR or FF on the remote to fast forward the tape until 0:30:00 appears in the time counter.
4. Press STOP.
This is the approximate end of the program. You can begin recording a new program.
5. Press CLEAR to reset the time counter to 0:00:00.
6. Press DISPLAY twice to remove the time counter from the screen and return to the normal display mode. These displays time out.

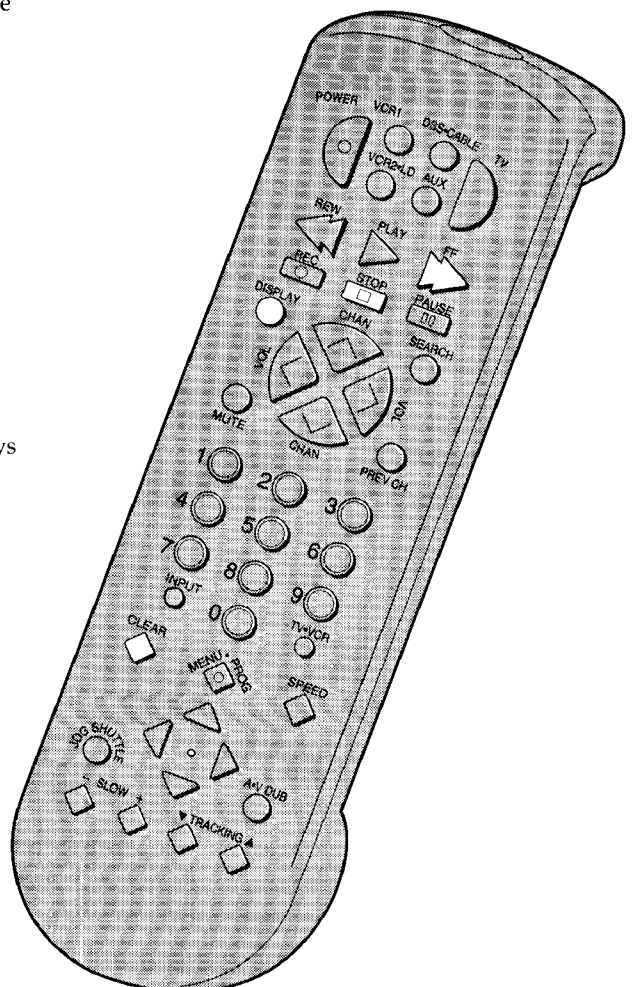
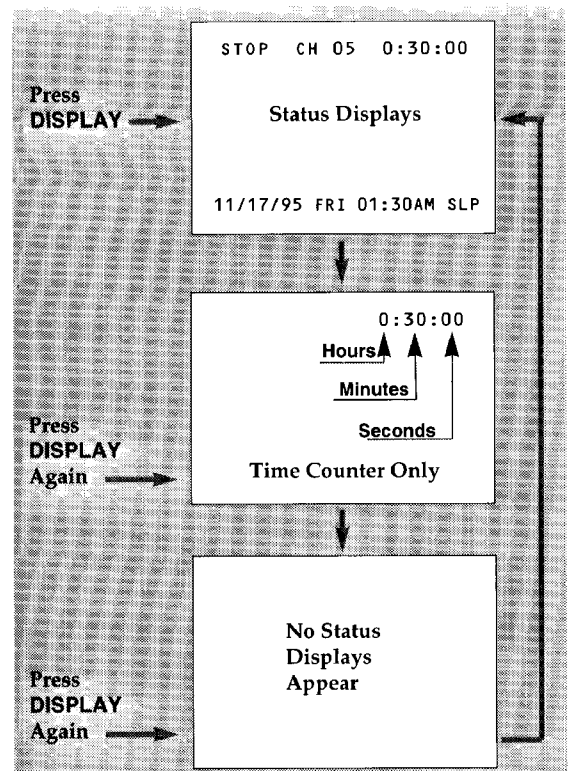

Using the Playback Features

Pause for Stop Action

This feature stops the tape in action and lets you examine details of the scene on the screen. Stop action works best for tapes recorded in the SP and SLP speeds.

1. Press **PLAY•PAUSE** on the VCR or **PAUSE** on the remote during playback to stop the action.
The pause indicator (II) appears in the VCR's display panel.
2. Press **TRACKING** up or down to reduce any picture jittering.
3. Press **PLAY•PAUSE** on the VCR or **PAUSE** or **PLAY** on the remote to return to playback.
The VCR automatically switches from stop-action playback to stop after a few minutes.

Slow Motion

You can view a tape in slow motion during play or play pause. **SLOW +** and **-** let you change the speed. Sound is turned off during slow-motion playback. Slow motion works best in the SP and SLP speeds.

1. Press **SLOW +** or **-** to begin slow-motion playback.
2. Press **SLOW +** to increase the speed or **SLOW -** to decrease the speed.
3. Use **TRACKING** up or down to remove any streaks from the picture.
4. Press **PLAY•PAUSE** on the VCR or **PLAY** on the remote to return to playback.
The VCR automatically switches from slow-motion playback to stop after a few minutes.

Picture Search

You can search for a specific tape location during playback by fast forwarding or rewinding the tape. Sound is turned off during picture search. Picture Search works best for tapes recorded in the SP or SLP speed.

Fast Forward Search

1. Use the **SHUTTLE** Ring on the VCR or **FF** on the remote to search forward at a faster-than-normal speed.
2. Use **FF** or **PLAY** on the remote to return to playback.

Rewind Search

1. Use the **SHUTTLE** Ring on the VCR or **REW** on the remote to search in reverse at a faster-than-normal speed.
2. Use **REW** or **PLAY** on the remote to return to playback.

Automatic Tracking

The VCR has automatic tracking which adjusts the picture when playing back a tape recorded on another VCR. Automatic tracking is turned on whenever a tape is inserted or the VCR's power is turned on.

Manual Tracking

Occasionally, you may need to manually adjust tracking on a tape recorded on a different VCR or camcorder. The **TRACKING** buttons on the remote or VCR are used when playing a tape. They have no effect during recording.

When streaks or snow appear, press **TRACKING** up or down for the best possible picture.

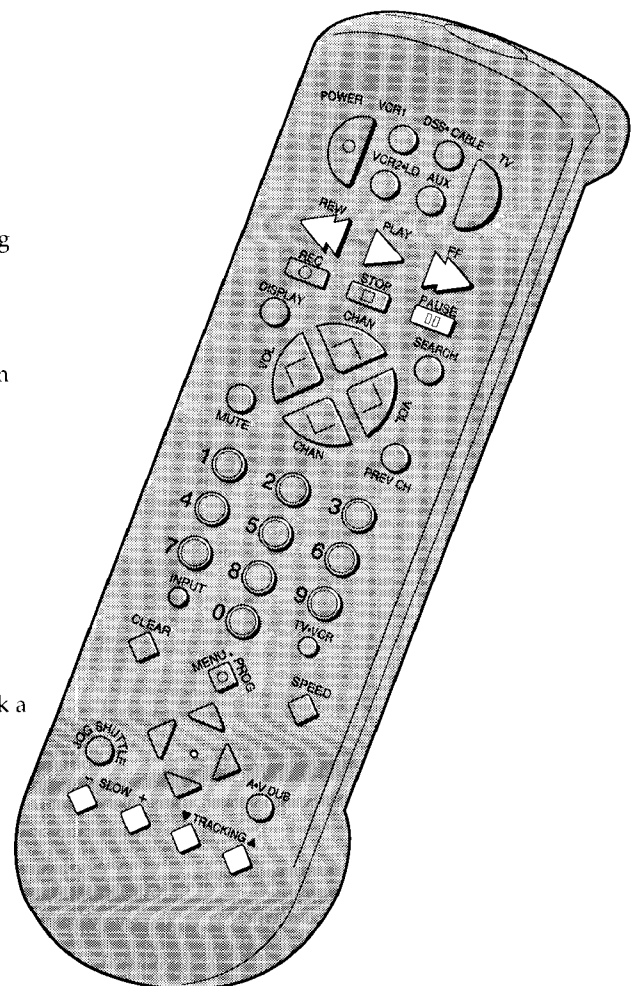

Using the Playback Features

Variable Speed Picture Search Using the SHUTTLE Ring on the VCR

The Shuttle lets you search a picture during playback at variable speeds in both forward and reverse.

Sound is turned off during picture search. The picture is best for tapes recorded in the SP or SLP speed.

1. Turn the SHUTTLE Ring on the VCR while in Play or Still mode to start a forward or reverse search.
 - The more you turn the Ring, the faster the search speed.
 - When the SHUTTLE Ring on the VCR is turned more than half way in stop mode, normal Fast Forward or Rewind begins.
 - Some noise bars are normal during Shuttle operation.
 - After 3 minutes in Still or Slow, the VCR will go into Stop mode.
 - When the SHUTTLE Ring is released, the VCR goes into Still mode.
2. Press PLAY•PAUSE on the VCR, or PLAY or PAUSE on the remote to return to normal playback and turn off the shuttle feature.

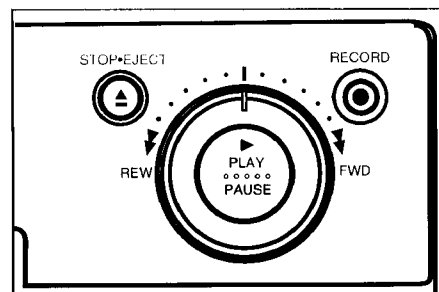

Variable Speed Picture Search and Frame Advance Using JOG SHUTTLE on the Remote Control

During playback, the JOG SHUTTLE button and the left (◀) or right (▶) arrow let you search a tape at variable speeds in both forward and reverse. The JOG SHUTTLE button and the up (▲) or down (▼) arrow let you view one stop-action frame after another.

Sound is turned off during picture search and frame advance. The picture is best for tapes recorded in the SP or SLP speed.

1. Press JOG SHUTTLE on the remote during playback. The indicator in the center of the arrows lights, and the VCR enters pause.
 - Press and quickly release ▶ on the remote to search forward slowly. Press and hold ▶ to search faster.
 - Press and quickly release ◀ on the remote to search in reverse slowly. Press and hold ◀ to search faster.
 - Press ▲ or ▼ on the remote while VCR is searching to place the VCR in pause. Press ▲ to advance or ▼ to reverse the picture one frame at a time.
2. Press PLAY•PAUSE on the VCR, or PLAY or PAUSE on the remote to return to normal playback and turn off the jog shuttle feature.

Pressing a button other than a JOG SHUTTLE button, except TRACKING UP or TRACKING DOWN, turns off the jog shuttle and indicator.

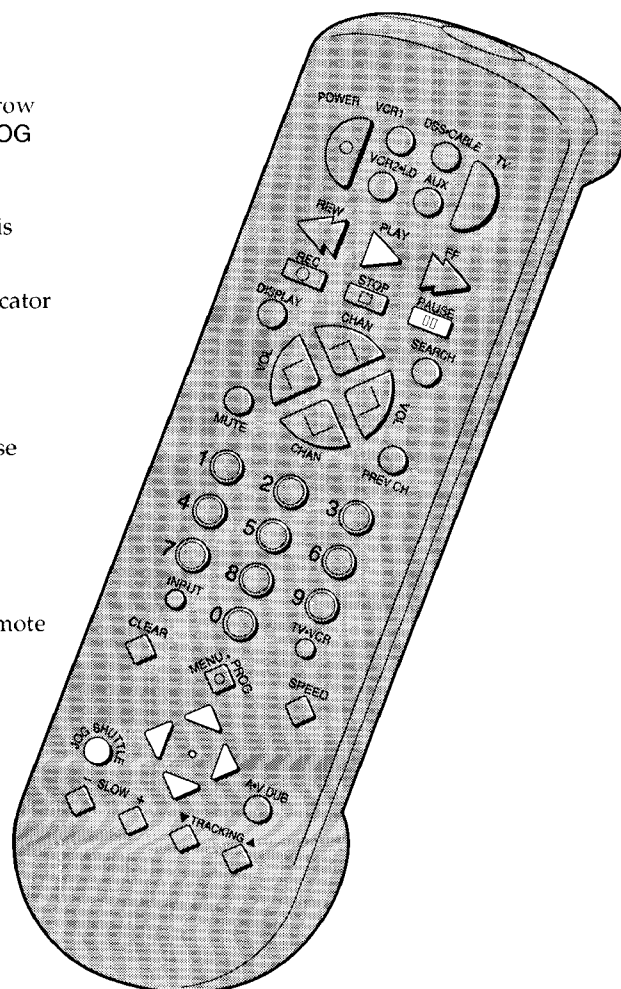

Using the Playback Features

Commercial Scan (SEARCH Button)

This is useful for scanning commercials or short program segments.

1. Press **SEARCH** once during playback to advance the tape approximately 60 seconds.

Index Search

The VCR has a "VHS Index Search System" that automatically records an index mark on the tape every time you stop and start recording. You can locate the program you want to play by the number of index marks.

The VCR automatically locates the index number you select. The VCR will search forward or backward from the current location on the tape.

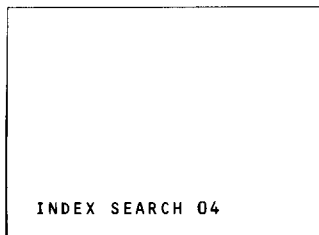
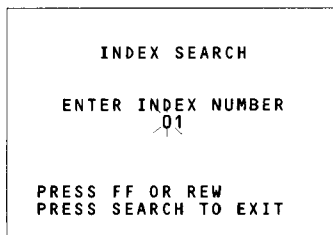

1. Insert the prerecorded tape and press **STOP**.
2. Press **SEARCH** on the remote to display the **INDEX SEARCH** menu.
3. Press two number buttons to enter the number of index marks you want the VCR to search.
Press **CLEAR** on the remote to correct an entry.
4. Use **SHUTTLE** Ring on the VCR or **FF** on the remote to search forward or **REW** to search in reverse.
5. Press **STOP** to stop index searching.

Some index marks may be missed by the VCR.

- A mark too close to your location on the tape.
- The mark at the beginning of a recorded segment of five minutes or less.
- The first index mark on the tape when you start at the beginning of the tape.

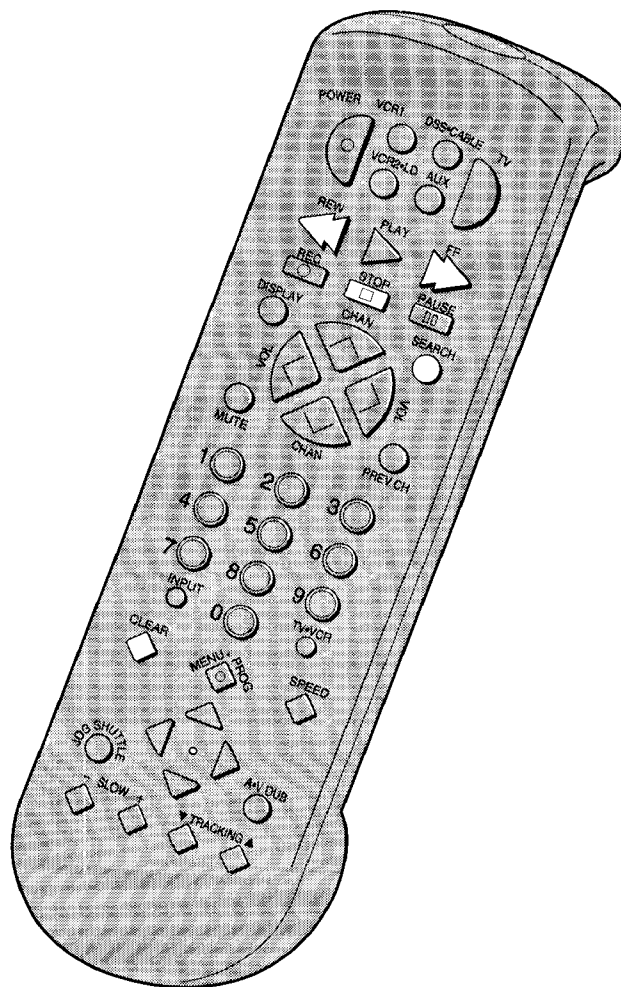

Using the Playback Features

Zero Search

The zero search feature lets you quickly return to a counter reading of 0:00:00 anywhere on the tape. This is especially convenient when you want to watch a segment of the tape several times.

1. Insert the prerecorded tape.
2. Press DISPLAY twice to display only the time counter on the TV screen.
3. Use PLAY•PAUSE, the SHUTTLE Ring or FWD on the VCR or FF on the remote, or REW to advance to the spot on the tape where you want to return to quickly.
4. Press STOP.
5. Press CLEAR to reset the time counter to 0:00:00.
6. Continue playing the tape.
7. Press STOP.
8. Press SEARCH twice in the stop mode to display the ZERO SEARCH menu on the TV screen. The current time counter is displayed.
9. Use SHUTTLE Ring on the VCR or FF on the remote, or REW to return to 0:00:00. The time counter appears in the upper right corner of the TV screen during search.

```
ZERO SEARCH
CURRENT TAPE COUNTER IS
2:17:25

PRESS REW TO GO TO 0:00
PRESS SEARCH TO EXIT
```

```
ZERO SEARCH
CURRENT TAPE COUNTER IS
-2:17:25

PRESS FF TO GO TO 0:00
PRESS SEARCH TO EXIT
```

Blank Search

The VCR searches for blank portions of the tape that are more than six seconds long.

```
BLANK SEARCH
SEARCH FOR BLANK AREA

PRESS FF TO BEGIN
PRESS SEARCH TO EXIT
```

1. Insert a prerecorded tape. Press STOP.
2. Press SEARCH three times to display the BLANK SEARCH menu.
3. Use SHUTTLE Ring on the VCR or FF on the remote to begin searching for six seconds of blank tape.
A message appears on the screen if a blank area is not found.
4. Press STOP to stop BLANK searching.

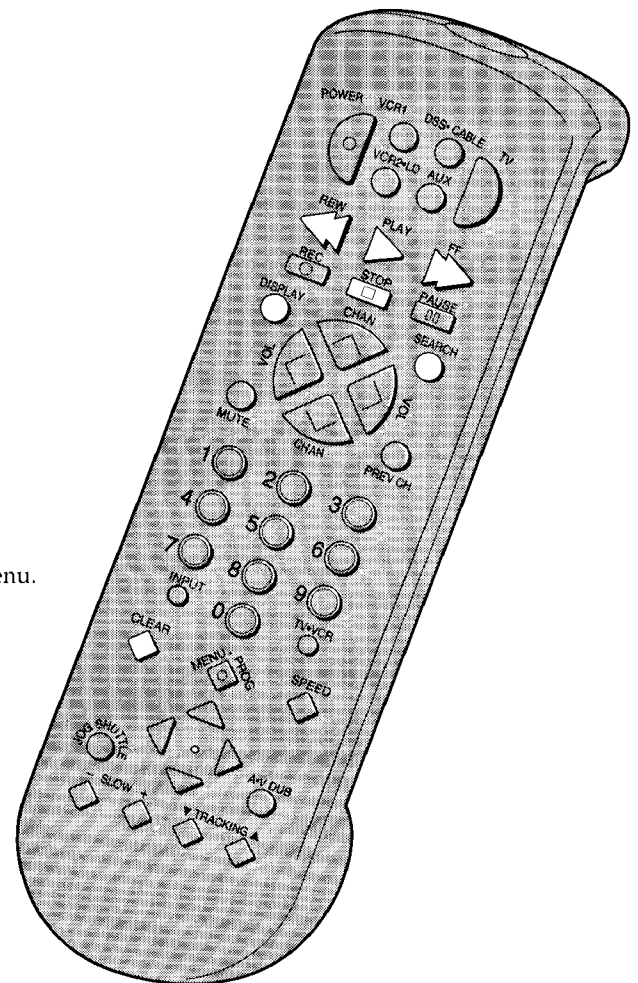

Types of Recordings

Your VCR provides different types of recording. These types are explained in the following sections.

Basic Recording – Operating Instructions

To Make a Recording

Turn on the TV and tune it to the VCR viewing channel, either 3, 4, or the TV's video input channel.

1. Insert a tape with its safety tab in place.
2. Press VCR1 (VCR2•LD) to set the remote to control VCR.
3. If you are using one of the basic hookups, make sure the VCR indicator appears in the VCR's display panel. If not, press TV•VCR to turn it on.
4. Select a recording speed using SPEED on the remote.
The tape speed indicator appears in the VCR's display panel and on the TV screen.
5. Select the channel or line input ("L1" or "L2") to be recorded.
The channel number, "L1", or "L2" appears in the VCR's display panel and VIDEO1 or VIDEO2 appears on the TV screen.
 - L1: For rear audio/video connection.
 - L2: For front audio/video connection.
6. Press REC on the remote or RECORD on the VCR to begin recording. The REC indicator (REC) and the playback indicator (▶) appear in the VCR's display panel while the VCR is recording.

To Stop a Recording

Press STOP on the VCR or the remote.

Watch a TV Channel While VCR is Recording a Different Channel

1. Follow steps 1 through 6 above.
2. If you are using one of the basic hookups, press TV•VCR to switch to the TV channel. The VCR indicator turns off in the display panel.
3. Press TV to set the remote to control TV functions for a compatible TV.
4. Select the channel you want to watch with the TV's channel buttons.
5. Press STOP•EJECT on VCR or STOP on remote when recording is finished.

Recording Features

Recording Speeds

Press **SPEED** on the remote to select a recording speed (SP, LP, or SLP). The speed you select appears in the VCR's display panel and on the TV screen.

Cassette	Recording Time		
	SP	LP	SLP
T-120	2Hr	4Hr	6Hr
T-160	2Hr 40Min	5Hr 20Min	8Hr

SP (Standard Play) gives the best quality recording. This is why most prerecorded, rental tapes are recorded in SP. Fewer programs can be recorded on the tape. Special effects such as pause, slow motion, picture search, and frame advance work well in this speed.

LP (Long Play) gives twice the recording time of tapes recorded in SP. Special effects in playback are not recommended in LP.

SLP (Super Long Play) gives three times the recording time of tapes recorded in SP. Special effects such as pause, slow motion, picture search, and frame advance work well in this speed.

Recording Pause

You can skip short passages of unwanted material and not record them.

Press **PLAY•PAUSE** on the VCR or **PAUSE** on the remote during recording to stop and start recording.

The record indicator (REC) and the pause indicator (II) appear in the VCR's display panel.

The VCR automatically switches from pause to stop after a few minutes.

Flying Erase Head

A separate erase head is mounted on the spinning headwheel — hence the term "flying". This lets you make clean edits without the glitches or rainbow noise that can appear when editing a tape.

Automatic Head Cleaner

The VCR has an automatic head cleaner system. When a cassette is inserted, the head cleaning system is activated. This system minimizes the need for accessory cleaners or a visit to a Servicenter.

Express Recording

Express recording lets you record up to four hours without using the timer program feature. The VCR turns off automatically at the end of the recording.

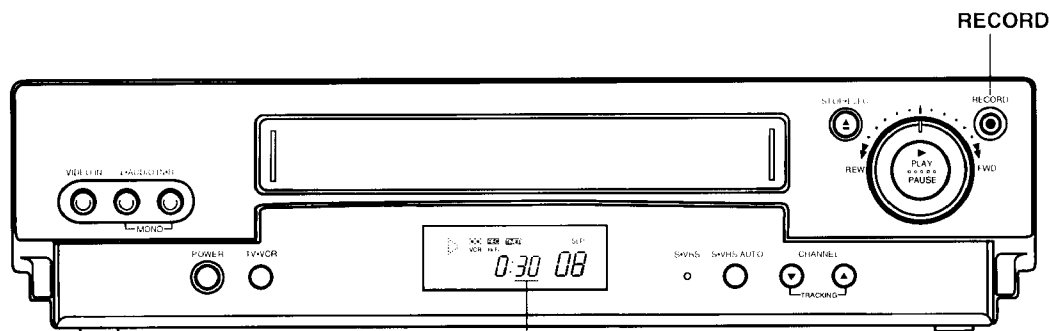

Display showing 30 minutes remaining

Operating Instructions

1. Turn on the VCR.
2. Insert a tape with its safety tab in place.
3. Select the channel you want to record.
4. Select the desired recording speed using SPEED on the remote.
5. Press REC on remote or RECORD on the VCR to activate the recording.
6. Press RECORD or REC repeatedly until the amount of recording time for the program is displayed in the VCR's display panel or on the TV screen.

Each press of RECORD or REC increases the time — 30 minutes up to 4 hours.

Press RECORD	Recording Time
0:30	(30 Min)
1:00	(1 Hr)
1:30	(1 Hr, 30 Min)
2:00	(2 Hrs)
3:00	(3 Hrs)
4:00	(4 Hrs)
0:00	(Turns Off)

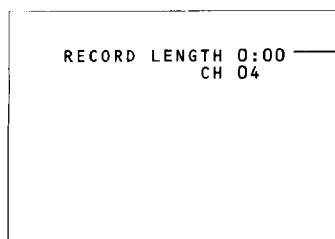

Recording Display on TV Screen

The amount of time the VCR will record and the record (REC) the playback (▶) and the time (TIMER) indicators appear in the VCR's display panel.

During recording, press RECORD on the VCR or REC on the remote to display the time remaining on the TV screen. Press RECORD or REC again to increase the recording time.

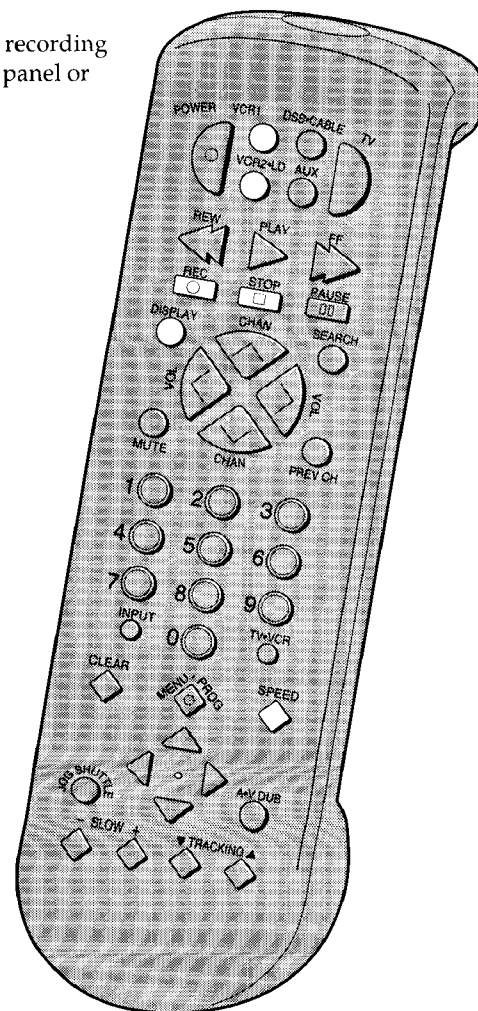

Stopping an Express Recording in Progress

With the VCR: Press POWER and then STOP•EJECT within a few seconds.

With the Remote: Press VCR1 (VCR2•LD) and then STOP within a few seconds.

Recording Broadcast Stereo TV or SAP (Second Audio Program)

Some TV programs are broadcast with stereo audio or a second audio language (SAP). The RECEPTION: STEREO/MONO/SAP feature lets you select the type of audio you want to record.

To Record Stereo Broadcast TV or SAP

Turn on the TV and tune it to the VCR viewing channel, either 3, 4, or the TV's video input.

1. Insert a tape with its safety tab in place.
2. If using one of the basic hookups, make sure the VCR indicator appears in the VCR's display panel. If not, press TV•VCR to turn it on.
3. Use SPEED on the remote to select a recording speed.
The tape speed indicator appears in the VCR's display panel and on the TV screen.
4. Select the channel, "L1" (Rear connection), or "L2" (Front connection) to be recorded.
Channel number, "L1", or "L2" appears in the VCR's display panel.
5. Set the RECEPTION:STEREO/MONO/SAP feature for the type of audio you want to record.
 - A. Press MENU•PROG to display the VCR MAIN MENU on the TV screen.
 - B. Press 6 to display the AUDIO menu.
 - C. Press 1 to select the type of audio RECEPTION: STEREO, MONO, or SAP.
 - Set to STEREO for normal recording and to record broadcast stereo TV.
The STEREO indicator lights in the VCR's display panel when the station you are tuned to is broadcasting stereo.
 - Set to MONO if the stereo signal is weak and the sound is too "noisy".
 - Set to SAP to record SAP (second audio program) instead of the normal audio on both the hifi and linear tracks.
The SAP indicator lights in the VCR's display panel when the station you are tuned to is broadcasting SAP.
 - D. Repeatedly press 0 to remove the menus from the TV screen.
6. Press REC on remote or RECORD on the VCR to start recording. The record indicator (REC) and the playback indicator (▶) appear in the VCR's display panel.
7. Press STOP•EJECT on the VCR or STOP on the remote when you are finished.

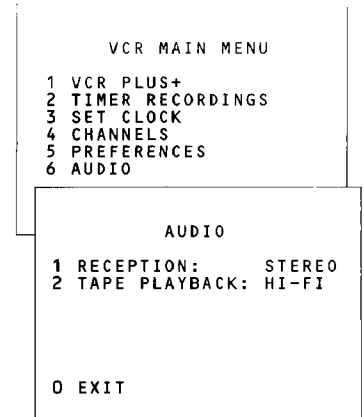

Recording Audio Only

You can record audio only from another audio source connected to the AUDIO1 or AUDIO2 IN (L and R) jacks on the back of the VCR.

To Record Audio Only (Refer to hookup on page 9.)

1. Press the **INPUT** button on remote until the line indicator "L1 (Rear connection)" or "L2 (Front connection)" appears in the VCR's display panel.
Then, the VCR records audio from the audio equipment connected to the AUDIO1 or AUDIO2 IN jacks.
2. Use **SPEED** on the remote to select the recording speed.
The tape speed indicator appears in the VCR's display panel and on the TV screen.
3. Start playing the audio source and press **REC** on remote or **RECORD** on the VCR to begin recording.
The record indicator (**REC**) and the playback indicator (**▶**) appear in the VCR's display panel.
4. Press **STOP•EJECT** on the VCR or **STOP** on the remote when you are finished.

Recording While You're Away

Setup Cable Box or RCA Satellite Receiver (Required Only if All Channels are Received From a Cable Box or Receiver)

CABLE BOX SETUP tells the VCR the output channel of your cable box or RCA satellite receiver. If your cable box can be controlled by a remote, the VCR may be able to tune it to the channel you want to record during VCR Plus+ and timer recordings. Position the remote-controllable cable box on top of the VCR as shown on page 4 or 5.

1. Turn on your cable box and tune it to channel 02.
2. Press MENU•PROG on the remote to display the VCR MAIN MENU.
3. Press 4 to display the CHANNELS menu.
4. Press 5 to display the CABLE/DSS BOX SETUP menu.
5. **The cable box or receiver is not used for all channels:** Press 2 on the remote. You are finished with CABLE/DSS BOX SETUP.

The cable box or receiver is used for all channels: Press 1 on the remote.

6. Press two numbers on the remote to enter the output channel of your cable box or receiver. Press 0 before a single digit number. Valid numbers are 01-125.

If you connected your cable box or receiver to the VCR using the audio/video jacks, press INPUT on the VCR to select the VIDEO 1 or VIDEO 2 option.

7. Press MENU•PROG to enter the output channel of your cable box. THE VCR WILL NOW RECEIVE ALL CHANNELS FROM THE CABLE BOX message will appear on the TV screen showing the output channel.

The VCR automatically enters the output channel of your cable box or receiver as the channel to be recorded in the VCR PLUS+ and TIMER RECORDINGS menus.

8. Press MENU•PROG to display the THE CODE FOR YOUR CABLE BOX or DSS RECEIVER message on the TV screen.

9. **Manual Controlled Cable box or Satellite Receiver:** Press MENU•PROG. You are finished with CABLE BOX SETUP.

Remote Controlled Cable box: Enter your cable box type (01-60) from the chart on page 18. or enter 00 for the DSS Receiver.

10. Press MENU•PROG twice to enter your cable box type. The VCR will change the cable box from channel 02 to channel 09 when you enter the correct code for your cable box.

11. **The cable box is tuned to channel 9:** Press number 1 on the remote. You are finished with CABLE BOX SETUP. The VCR then tunes the cable box to the correct channel during VCR Plus+ and timer recording. Complete "VCR Plus+ Set Up" on the next page.

The cable box did not tune to channel 9: Press number 2 on the remote and enter a different code from the chart. If these codes do not work:

- Try repositioning the cable box on top of the VCR and reentering the codes.
- Try entering all code numbers (00 – 60). Press CLEAR on remote to change incorrect entries.

If none of the codes work, press MENU•PROG to quit. The VCR will not control your cable box. Turn on the cable box and leave it tuned to the channel you want to record some time before the recording is to begin.

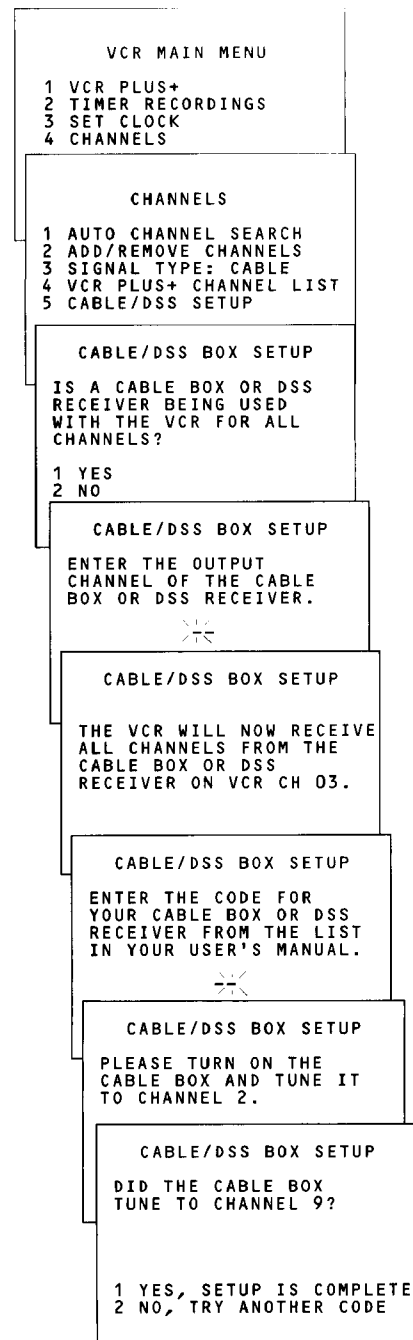

Recording While You're Away (VCR Plus+* Recording)

VCR Plus+ Setup for Antenna, Unscrambled (Not Requiring a Cable Box) Cable Systems, or Cable Box VCR Can Control

A VCR Plus+ channel number is assigned for each broadcast or cable channel. These numbers are listed in most publications that list PlusCode numbers.

1. Prepare a worksheet for the VCR Plus+ channels that are different from the channels you receive them on. Refer to the chart below for standardized VCR Plus+ channel numbers.

Broadcast or Cable-TV Station Name	VCR Plus+ Channel Number	Channel Number You Receive This Station On
HBO	33	See Note 1
ESPN	34	See Note 1
ABC	See Note 2	See Note 1
FOX	See Note 2	See Note 1

Note 1: Check your local or cable listing for the channel number you receive this station on.
Note 2: Check your local listing for the broadcast or VCR Plus+ channel number assigned to this station.

2. Press MENU•PROG on the remote to display the VCR MAIN MENU on the TV screen.
3. Press 4 to display CHANNELS menu.
4. Press 4 to display VCR PLUS+ CHANNEL LIST menu.
5. Using your worksheet, press two numbers to enter each channel number you receive on a **different** channel than the assigned VCR Plus+ channel number.

If a channel in your area has been assigned more than one VCR Plus+ channel number, enter that same channel number next to each VCR Plus+ channel number.

Press CHAN up or down to move the VCR PLUS+ numbers up or down on the menu.
 Press CLEAR on the remote to erase a number.

6. Press MENU•PROG when you are finished.

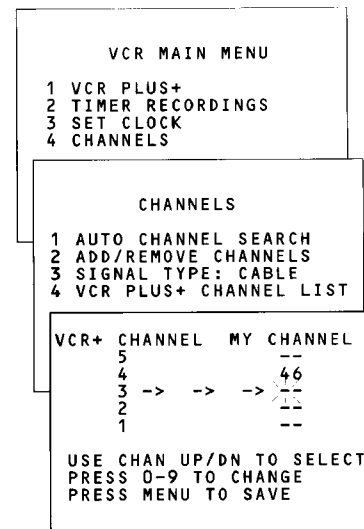

Standardized VCR Plus+ Channel Numbers for Cable-TV

U.S.A. List		Canadian List	
35 American Movie Classics	58 The Movie Channel	67 Allarcom Pay	99 First Choice Four
39 Arts & Entertainment	48 Music Television	Television/Superchannel	90 House of Commons
57 Black Entertainment	49 The Nashville Network	44 Arts & Entertainment	91 La Chaine Francaise
54 Bravo	38 Nickelodeon	72 Cable News Network-Headline	51 The Learning Channel
42 Cable News Network	64 Nostalgia Television	News	65 MeteoMedia/The Weather Network
45 Cinemax	99 Quality Value Cable	61 Cable News Network	48 MuchMusic Network
98 Cinemax 2	41 Showtime	70 Canadian Home Shopping Network	55 MusiquePlus
37 The Discovery Channel	97 Showtime 2	56 Canal Famille	52 Nashville Network
53 The Disney Channel	59 Sports Channel	69 Cathay International Television Inc	73 Newsworld/CBC
63 Entertainment Television	52 Turner Network Television	68 Chinavision Canada Corp	53 Le Reseau des Sports
34 ESPN Sports Network	44 USA Network	60 Country Music Television	43 The Sports Network
47 The Family Channel	62 Video Hits 1	63 Family Channel	64 Super Ecran
33 Home Box Office	93 Viewer's Choice 1	62 First Choice	37 Super Ecran B
95 Home Box Office 2	94 Viewer's Choice 2	96 First Choice Two	98 Super Ecran C
96 Home Box Office 3	55 WGN Chicago	97 First Choice Three	66 Telatino Network
51 The Learning Channel	43 WTBS Atlanta		46 TV5 Montreal
46 Lifetime	60 WWOR New York		92 Viewer's Choice 1

*VCR Plus+ and PlusCode are trademarks of Gemstar Development Corporation.

Recording While You're Away (VCR Plus+ Recording)

The VCR Plus+ and timer program features let you program the VCR to record up to eight different programs within a one year period. Before using VCR Plus+ to record a program, make sure that:

- The clock is set correctly.
- A tape with safety tab has been inserted with enough tape to record the programs.
- The remote is set to control the VCR — using VCR1 (VCR2•LD).
- The VCR is setup for VCR Plus+ programming if you.
 - receive all channels through a cable box or RCA satellite receiver, setup the cable box or receiver as described on page 33.
 - use an antenna, do not use a cable box for all channels, or have a cable box the VCR can control, complete VCR Plus+ Setup on page 34.

Setting a VCR Plus+ Recording

1. Press MENU•PROG on the remote to display the VCR MAIN MENU.
2. Press 1 to display the VCR PLUS+ menu.
3. Press numbers on the remote to enter PlusCode number for the program you want to record. VCR PlusCode numbers are found in most local TV listings.

Press CLEAR on the remote to correct an entry.

4. Press MENU•PROG to enter the program.

If the VCR does not recognize the PlusCode number, UNRECOGNIZED NUMBER... PLEASE RE-ENTER appears on the TV screen. Check the number and enter it again.

5. Press 1, 2, 3, or 4 to select type of program.
 - 1 ONE TIME – single program recorded once.
 - 2 DAILY – program recorded at same time every day.
 - 3 WEEKDAYS – program recorded at same time Monday through Friday.
 - 4 WEEKLY – program recorded at same time once a week.

6. Select a recording speed using SPEED on the remote.
7. Press CLEAR if you want to change the program end time. This feature lets you extend the recording time on VCR Plus+ programs. Also, this option may be useful when you are recording programs such as sporting events that could exceed scheduled broadcast times.

8. Press MENU•PROG to enter your program. A reminder appears which will time out or you can press MENU•PROG to return to the VCR MAIN MENU.

9. Repeat steps 2 – 6 for additional programs or press MENU•PROG to remove the menu from the TV screen.

10. Turn off the VCR before recording time.

The TIMER indicator appears in the VCR's display panel when the timer has been programmed.

11. **Manually Controlled Cable box or Satellite Receiver:** Turn on the cable box or satellite receiver and tune it to the channel you want to record before the time the recording is to begin.

Remote Controlled Cable box: Turn on the cable box before the time the recording is to begin.

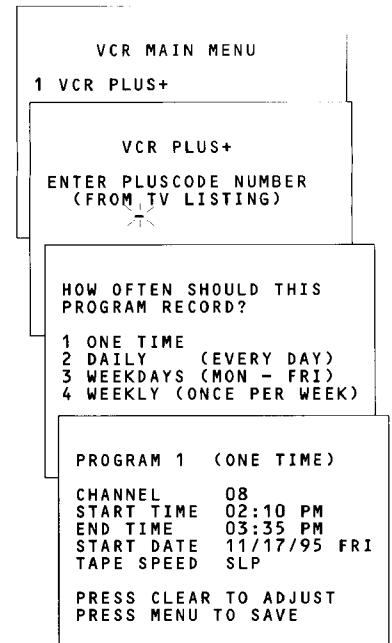

Stopping a Timer Recording in Progress

With the VCR: Press POWER and then STOP•EJECT within a few seconds.

With the Remote: Press VCR1 (VCR2•LD) and then STOP within a few seconds.

Recording While You're Away (Timer Recording)

The timer program feature lets you program the VCR to record up to eight different programs within a one year period. Before setting the timer, make sure that:

- The clock is set correctly.
- A tape with its safety tab in place has been inserted and has enough tape to record the programs.
- The remote is set to control the VCR — using VCR1 (VCR2•LD).
- If you receive all channels through a cable box or RCA satellite receiver, setup the cable box or receiver as described on page 33.

Setting a Timer Recording

1. Press MENU•PROG on the remote to display the VCR MAIN MENU.
2. Press 2 to display the TIMER RECORDINGS menu.
3. Press 1 to display the CREATE A NEW PROGRAM menu.
4. Press 1, 2, 3, or 4 to select type of program.
 - 1 ONE TIME — single program recorded once.
 - 2 DAILY — program recorded at same time every day.
 - 3 WEEKDAYS — program recorded at same time Monday through Friday.
 - 4 WEEKLY — program recorded at same time once a week.
5. Press number buttons on the remote to enter the channel number (or INPUT to select "L1" or "L2"), start time including AM or PM, end time, and start date of the recording. Just follow the on-screen prompts.

Press CLEAR on the remote to correct an entry.

If you receive all channels from a cable box or satellite receiver and have completed CABLE BOX SETUP and the cable box is not controllable, the output channel of your cable box or receiver and CABLE automatically appear on the menu.

6. Use SPEED on the remote to select a recording speed.
7. Press MENU•PROG to enter your program. A reminder appears which will time out or you can press MENU•PROG to return to the TIMER RECORDINGS menu..
8. Repeat steps 3–7 for additional programs or press MENU•PROG twice to remove the menu from the TV screen.
9. Turn off the VCR before recording begins.

The TIMER indicator appears in the VCR's display panel when the timer has been programmed.
10. Manually Controlled Cable box or Satellite Receiver: Turn on the cable box or receiver and tune it to the channel you want to record before the time the recording is to begin.

Remote Controlled Cable box: Turn on the cable box before the time the recording is to begin.

Stopping a Recording in Progress

With the VCR: Press POWER and then STOP•EJECT within a few seconds.

With the Remote: Press VCR1 (VCR2•LD) and then STOP within a few seconds.

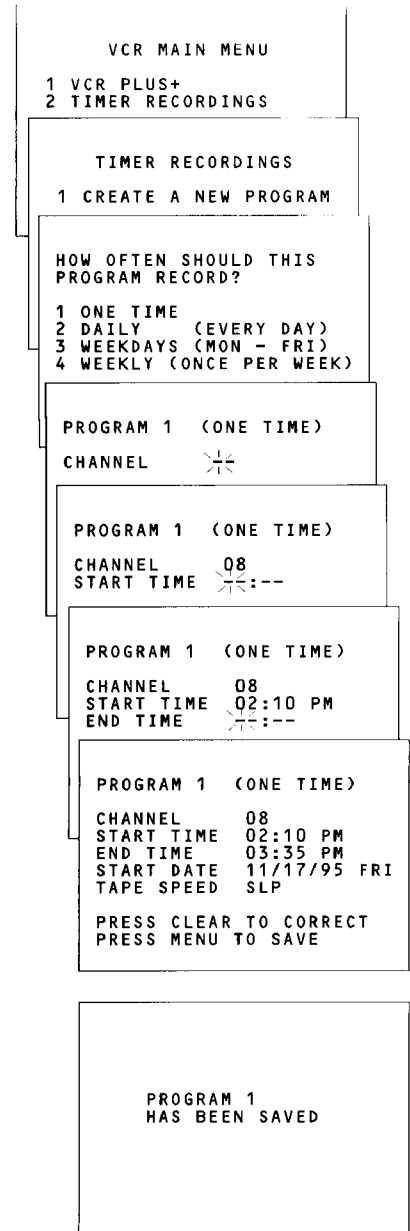

Recording While You're Away

Checking or Clearing VCR Plus+ or Timer Recordings

1. Press MENU•PROG on remote to display VCR MAIN MENU on TV screen.
2. Press 2 to display the TIMER RECORDINGS menu.
3. Press 2 to display the REVIEW EXISTING PROGS.
4. Press MENU•PROG or 2 to display the information faster.
5. Press CLEAR when the program you want to erase appears on the screen.

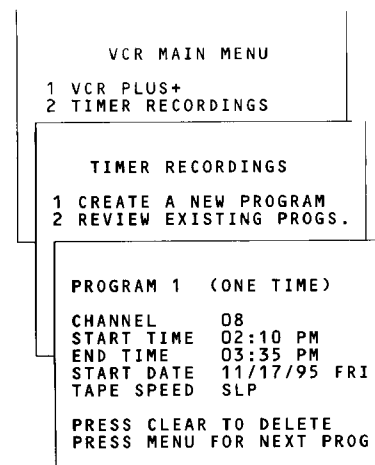

Timer Recording From the VCR's Line Input

The line input refers to the signal coming from the AUDIO1, AUDIO2, S-VIDEO, VIDEO1 or VIDEO1 IN jacks of the VCR. Recording from the line input is convenient if you have a satellite receiver or similar component attached to these jacks. To timer record from the component connected to the VCR's line input: press INPUT to enter VIDEO 1 or VIDEO 2 instead of the channel number on the TV screen during timer programming.

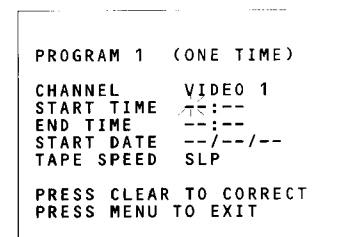

S-VHS Recording

S(Super)-VHS Recording (Refer to hookups on pages 3-9.)



The VCR is capable of recording in VHS or S-VHS format. To record in S-VHS, use cassettes labeled with the **S-VHS** symbol. It is not possible to record in S-VHS using a standard VHS tape.

S-VHS tapes must be played back in a VCR with S-VHS. S-VHS recordings cannot be played back in VCRs that do not have the **S-VHS** symbol. The S-VHS indicator lights when playing back an S-VHS tape.

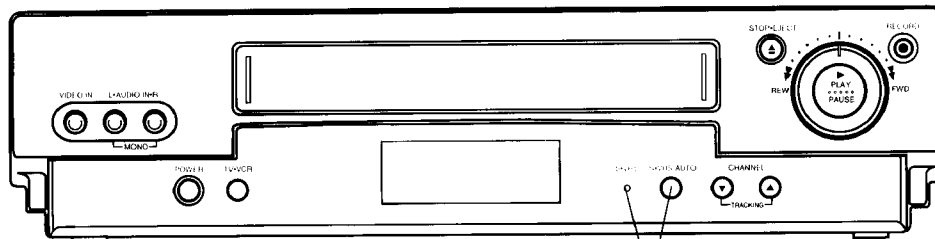

S-VHS AUTO Button and S-VHS Indicator

- To record in S-VHS, push the S-VHS AUTO button. The S-VHS AUTO indicator light turns on.
- To turn off S-VHS and record in VHS, push S-VHS AUTO button. The S-VHS AUTO indicator light turns off.

Refer to the chart below for the results.

S-VHS Recording			
S-VHS AUTO Button	Tape Type	S-VHS Indicator	Result
OFF	Standard	Off	Standard VHS
OFF	S-VHS	Off	Standard VHS
ON	Standard	Off	Standard VHS
ON	S-VHS	On	Super VHS

Using Two VCRs for Copying and Editing Tapes

Operating Instructions (Refer to hookup on page 8.)

Use one VCR as the playback VCR and the other as the recording VCR.

Caution: The unauthorized recording of television programs and other materials may infringe the rights of others.

1. Turn on the TV and VCRs.
2. Tune TV to the VCR viewing channel, either 3, 4, or the TV's video input.
3. If you have connected your VCR using Option A (page 8), tune recording VCR to channel 3 or 4 — the one selected on the back of the playback VCR.
If you have connected your VCR using Option B (page 8), press **INPUT** on recording VCR to select the line input. "L1" or "L2" appears in VCR's display panel.
4. Insert the tape you want to copy into playback VCR. Insert a blank tape with safety tab in place into recording VCR.
5. Press **PLAY•PAUSE**, then **PLAY•PAUSE** on playback VCR when you reach the point on the tape or program where you want to begin copying. If the tape was not recorded on the playback VCR, streaks may appear and you may need to adjust tracking.
6. Press **RECORD** on the VCR or **REC** on the remote, then **PLAY•PAUSE**, on recording VCR.
7. Press **PLAY•PAUSE** buttons on both VCRs at the same time to begin copying the tape.*
8. Edit out segments that you do not want to copy by pressing **PLAY•PAUSE** on recording VCR to stop copying the tape. Then, locate the next segment you want to copy on playback VCR by using **SHUTTLE** Ring, and **PLAY•PAUSE**. Press **PLAY•PAUSE** on the playback VCR. Press **PLAY•PAUSE** at the same time on both VCRs to resume copying.
9. Press **STOP•EJECT** on both VCRs when you are finished.

* You can turn off the TV after the recording has started as it does not have to be on to copy a tape.

Audio and Video Dubbing

Audio dubbing records new audio in place of the audio formerly recorded on the linear (mono) track of the tape. Audio dubbing does not affect the audio recorded on the Hi-Fi tracks or the recorded video. To playback the dubbed audio, set the RECEPTION: HI-FI/MIX/LINEAR feature to LINEAR. To hear the original audio, set the RECEPTION feature to HI-FI.

Video dubbing records new video in place of existing video segments. Hi-fi audio will be erased, but linear audio will remain unchanged. The flying erase head produces clean edits when you video dub.

To Audio Dub (Refer to hookup on page 9.)

1. Turn on the audio source and VCR.
2. Tune the TV to the VCR viewing channel, either 3, 4, or the TV's video input.
3. Insert the tape you want to dub on into the VCR.
4. Press INPUT on VCR's remote to select the line input (L1 or L2).
"L1" or "L2" appears in the VCR's display panel.
5. Press PLAY•PAUSE on the VCR or PLAY on the remote. When you reach the point on the tape where you want to begin dubbing, press PLAY•PAUSE on the VCR or PAUSE on the remote, or JOG SHUTTLE.
6. Press A•V DUB on the remote until A.DUB appears in the VCR's display panel. The VCR enters the audio dubbing mode and A.DUB remains in the VCR's display panel.
7. Start the audio source playing, and press PLAY•PAUSE on the VCR or PAUSE on the remote to begin audio dubbing.*
New audio is recorded on the linear track.
8. Press STOP•EJECT on the VCR or STOP on the remote when you are finished.

* You can turn off the TV after the dubbing has started as it does not have to be on to dub a tape.

Audio and Video Dubbing

(continued)

To Video Dub (Refer to hookup on page 8, Option B.)

Caution

If you attempt to video dub onto a blank tape, the video will "break up" and flash during playback. Record something on the blank tape, and then video dub.

1. Connect the two VCRs and turn them on.
2. Tune TV to the VCR viewing channel, either 3, 4, or the TV's video input.
3. Press **INPUT** on recording VCR to select the line input (L1 or L2). "L1" or "L2" appears in the VCR's display panel and "VIDEO 1" or "VIDEO 2" appears on the TV screen.
4. Insert the tape you want to copy into playback VCR. Insert a tape you want to dub with the safety tab in place in the recording VCR.
5. Press **PLAY•PAUSE** on the recording VCR. When you reach the point on the tape where you want to begin dubbing, press **PLAY•PAUSE**.
6. Press **A•V DUB** on the recording VCR's remote until **V.DUB** appears in the VCR's display panel. The VCR enters the video dubbing mode and **V.DUB** remains in the VCR's display panel.
7. Press **PLAY•PAUSE** on the playback VCR. Then press **PLAY•PAUSE**. The VCR enters the play-pause mode.
8. Press **PLAY•PAUSE** on **both** VCRs **at the same time** to begin dubbing the tape.*
9. Press **STOP•EJECT** on the VCR or **STOP** on the remote when you are finished.

* You can turn off the TV after the dubbing has started as it does not have to be on to dub a tape.

To Audio and Video Dub

1. Connect the dubbing source(s) and follow steps 1– 5 above.
2. Press **A•V DUB** on the recording VCR's remote until **A.DUB** and **V.DUB** appear in the VCR's display panel. The VCR will enter the audio/video dubbing mode and **A.DUB** and **V. DUB** remain in the VCR's display panel.
3. Proceed with steps 7 – 8 above.
The existing video, linear audio, and hi-fi audio will be replaced by the new audio and video.
4. Press **STOP•EJECT** on the VCR or **STOP** on the remote when you are finished.

Location of Controls

Front Panel

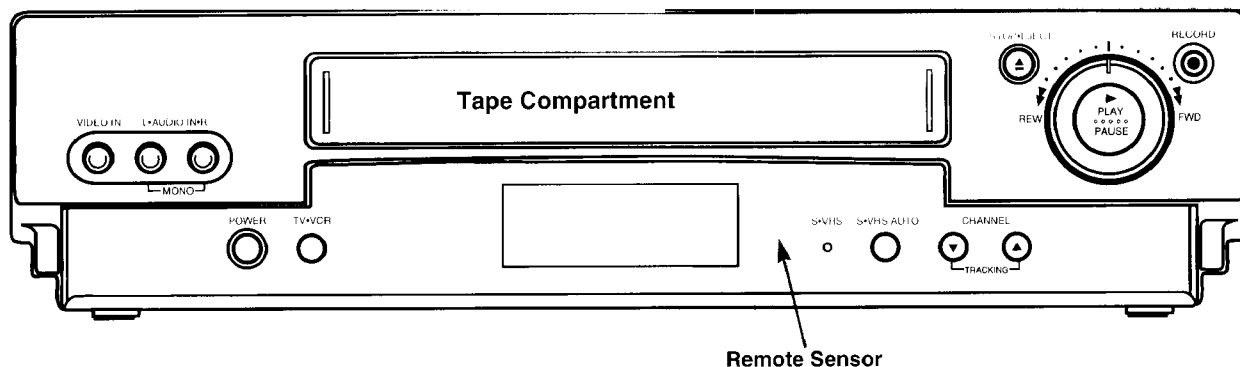

CHANNEL or TRACKING Up or Down
 Selects next higher or lower channel in the VCR's channel memory.
 Adjusts tracking during playback.

PLAY•PAUSE
 Plays a tape.
 Pauses the tape for stop-action viewing during playback.
 Pauses the tape during recording to prevent recording unwanted material.

POWER
 Turns the VCR on or off.

RECORD
 Starts the VCR recording.
 Used for express recording.

Remote Sensor
 Receives signals from the remote control.
 Aim the remote at this sensor with no objects between them.

S-VHS AUTO
 Selects VHS or S-VHS recording.
 See page 38.

S-VHS (Indicator)
 Lights during S-VHS recording or playback.

SHUTTLE Ring
 Places the VCR in Shuttle mode and starts a forward or reverse search when you turn the Ring while in Play or Still mode.

STOP•EJECT
 Stops the normal functions such as record, playback, rewind, fast forward, or pause.
 Press when the VCR is stopped to eject the cassette.

TV•VCR (Applies only to basic hookup)
 Switches the picture signal so that it either comes from the VCR or the TV channel. See page 12.

VIDEO and AUDIO (R and L) IN Jacks
 Receives signals from another component, such as a VCR or camcorder, when it is connected to these jacks.

Location of Controls

Back Panel

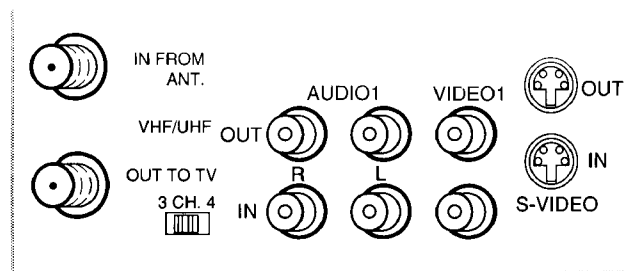

3 CH. 4 Switch

Selects the channel to which you will tune the TV to see the VCR picture if you connect the VCR using one of the basic hookups.

IN FROM ANT. (Antenna) Connector

Receives a signal from an antenna or cable system when attached.

OUT TO TV Connector

Passes signal to TV using the cable supplied.

S-VIDEO OUT and IN Connectors

Lets you attach another S-VHS component to the S-VIDEO IN connector using the included S-VHS cable. Use INPUT on the remote to display L1 in the VCR's display panel to select.

Lets you attach the S-VIDEO OUT connector to a TV monitor having an S-VIDEO IN connector to take full advantage of the S-VHS format.

Also, remember to attach the audio jacks. The S-VHS cable carries only video.

VIDEO1 and AUDIO1 (R and L) IN Jacks

Receives signals from another component, such as a VCR or camcorder, when it is connected to these jacks.

Display L1 in the VCR's display panel using INPUT on the remote to select these jacks.

VIDEO1 and AUDIO1 (R and L) OUT Jacks

Sends signals from VCR to another component, such as a monitor TV or another VCR, when it is connected to these jacks.

If the other component is not stereo, you may need a Y-adaptor to hear both channels.

Location of Controls

Display Panel

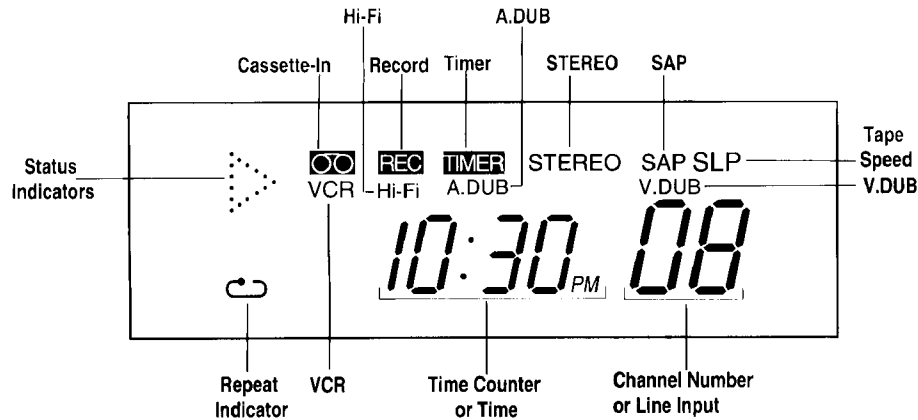

A. DUB Indicator

A.DUB lights during audio dubbing.

Cassette-in Indicator (📀)

Lights when a tape is in the VCR.

Channel Number or Line Input ("L1" or "L2")

The channel number or line input is displayed. Press INPUT on the remote to light "L1" or "L2" to record from the VIDEO1 or VIDEO2 and AUDIO1 or AUDIO2 IN jacks on the back of the VCR.

Hi-Fi Indicator

Lights when AUDIO PLAY is set to HIFI or MIX.

Repeat Indicator (🔄)

Lights when the repeat play is performed.

SAP Indicator

Lights when the station you are tuned to is broadcasting SAP.

Status Indicators

Show what the VCR is doing.

REC and ▶	Record
REC and	Record-pause
▶	Playback
◀	Reverse playback
	Play-pause
	Frame advance
▶	Slow motion
◀	Reverse slow motion
◀ flashing	Rewind
◀ flashing	Reverse search
▶ flashing	Fast forward
▶ flashing	Forward search
flashing	Cassette ejecting

STEREO Indicator

Lights when the station you are tuned to is broadcasting stereo.

Tape Speed Indicators (SP, LP, or SLP)

Tape speed. Press SPEED on remote to change.

Time or Time Counter

Press DISPLAY on remote to switch between the current time and elapsed-time counter.

TIMER Indicator

Lights when VCR is set for timer recording and VCR is turned off or XPR recording is performed. Flashes if tape is not inserted.

V.DUB Indicator

V.DUB lights during video dubbing.

VCR Indicator (Applies Only to Basic Hookups)

Press TV•VCR to turn on or off.

VCR indicator on: Picture from VCR.

VCR indicator off: Picture from TV channel.

Specifications

Format:	S-VHS
Record/Playback System:	Video: 4:1 lead Audio: 2 Hi-Fi record/playback system Flying Erase Head
Video Signal System:	EIA standard: NTSC color
Antenna:	75-ohm external VHF/UHF combined antenna terminal
Tuner:	USA: 181 channels capability* (125 cable channels) Canada: 178 channels capability* (122 cable channels)
Type:	AutoProgramming frequency synthesis
Power Requirement:	120V AC, 60 Hz
Power Consumption:	28 watts
Dimensions:	3.5 inches high (89 mm) 15 inches wide (380 mm) 11.5 inches deep (292 mm)
Weight:	9.5 pounds (4.3 kg)
Storage Temperature Range:	- 22°F to +149°F
Operating Temperature Range:	+41°F to +104°F

*Check your cable company's compatibility requirements.

Cleaning the VCR

Use a soft cloth or dusting attachment of your vacuum cleaner to dust your VCR. Remove dust from the ventilation holes on the top, back, sides, and bottom of the cabinet.

Plastic surfaces are easily scratched and can be marred by alcohol and various solvents. Avoid excessive use of oil-based furniture polishes since the materials used in the cabinet will accumulate more dust. We recommend using a non-abrasive, anti-static cleaner and polisher.

Trouble Checks

Sometimes problems can be easily solved by checking a few basic things. Check below before you call for help or take your VCR to an Authorized RCA VCR Servicenter.

Trouble	Here's what to try:
No power	<ul style="list-style-type: none"> • Plug VCR into an operating outlet. • Check connections.
VCR does not respond to remote	<ul style="list-style-type: none"> • Remove batteries and hold down one or more buttons for several seconds to drain the microprocessor inside the remote and reset it. Re-install the batteries and try remote again. • Press VCR1 (VCR2•LD) to set remote to control the VCR. <i>See page 16.</i> • Aim remote at VCR with no objects between them. • Change batteries.
Remote no longer controls an RCA TV	<ul style="list-style-type: none"> • Press TV to set remote to control a compatible TV. <i>See page 17.</i> • Reprogram remote for RCA TV. <i>See page 17</i>
Remote no longer controls a compatible TV, cable box, or auxiliary component	<ul style="list-style-type: none"> • Press TV, AUX, or CABLE to set remote to control the corresponding component. <i>See pages 17-19.</i> • Aim remote at TV with no objects between them. • Reprogram remote after batteries have been changed. <i>See pages 17-19.</i> • Change batteries.
VCR only responds to VCR2•LD button on remote	<ul style="list-style-type: none"> • Check setting of REMOTE CONTROL: VCR1/VCR2 feature. <i>See page 16.</i>
Poor or no picture for normal TV viewing	<ul style="list-style-type: none"> • Press TV•VCR to turn VCR indicator off. • Switch TV to an active channel. • Check antenna connections.
Snowy or no picture during playback	<ul style="list-style-type: none"> • Press TV•VCR to turn VCR indicator on. • Check TV channel selected (3 or 4) to make sure it matches the channel selected with 3 CH. 4 switch on back of VCR. • Check TV's fine tuning. • Check video cable connections between VCR and TV monitor. • Set TV monitor to video input channel. • Try another tape. • Some snow/streaks are normal during search, stop action, frame advance, and slow-motion playback.
Streaks in picture during normal playback	<ul style="list-style-type: none"> • Press one of the TRACKING buttons to move streaks up or down for the best picture. • Check tape — it may be worn out or of poor quality.
Time counter not working or not advancing during search mode.	<ul style="list-style-type: none"> • The time counter does not advance during unrecorded portions of tape. When an unrecorded segment of tape is encountered, the time counter will hold its count until recorded material is detected again. • A minus (-) will appear in front of the time if you rewind the tape farther back than a counter reading of 0:00:00.
Will not record or play	<ul style="list-style-type: none"> • No cassette in VCR. • Eject and reinsert cassette. • Broken tape — try another cassette. • VCR is in pause mode. Press PLAY•PAUSE on the VCR or PAUSE on the remote. • Pressing JOG SHUTTLE during playback places VCR in pause mode. Press PLAY•PAUSE on the VCR or PLAY on the remote, or PAUSE to return to normal playback.

Trouble Checks

Trouble	Here's what to try:
Will not record	<ul style="list-style-type: none"> • Safety tab removed from cassette. • Make sure the line indicator ("L1" or "L2") is turned off in VCR's display panel for normal recording from the VCR's tuner. Press INPUT on remote to turn off the line indicator.
Stereo or SAP sound not recorded	<ul style="list-style-type: none"> • RECEPTION: STEREO/SAP/MONO feature must be set to STEREO to record broadcast stereo. <i>See page 31.</i> • RECEPTION: STEREO/SAP/MONO feature must be set to SAP to record SAP. <i>See page 31.</i> • STEREO or SAP indicator not on. Station not broadcasting stereo or SAP.
Rewind does not operate	<ul style="list-style-type: none"> • Tape already rewound.
VCR plus+ or timer recording not made or wrong program recorded	<ul style="list-style-type: none"> • Wrong VCR plus+ code entered. • Cable box setup not done or not done correctly. <i>See page 33.</i> • Cable box was not turned on at time recording was to begin. • Program entered incorrectly (wrong channel or times). • Power interruption. Clock area in display panel will show --:--. • Check to see if time and date are correct — including AM/PM. • Program exceeded tape's length or tape was not rewound beforehand. • VCR was not turned off at the time recording was to start. • No tape in VCR or cassette's safety tab broken off. • VCR ejects cassette when the end of the tape is reached during a timer recording.
Clock shows incorrect time or date	<ul style="list-style-type: none"> • Power interruption. Clock on the front panel will show --:--. • Clock was not set accurately (check AM/PM and date). • Time counter display appears in VCR's display panel. Press DISPLAY on remote.
VCR makes noise when stopped	<ul style="list-style-type: none"> • VCR is removing tape from heads. This is normal. The head cylinder inside the VCR will continue to rotate for a few minutes after you put the VCR in the stop mode.
Will not AUTO-SEARCH active channels correctly	<ul style="list-style-type: none"> • Check antenna connections. • Check SIGNAL TYPE: CABLE/ANTENNA feature. <i>See page 11.</i>
Tape plays back in slow motion	<ul style="list-style-type: none"> • Press PLAY•PAUSE on the VCR or PLAY on the remote to return to normal playback.
Cannot select channels over 69	<ul style="list-style-type: none"> • Cable channels over 69 can only be selected if SIGNAL TYPE: CABLE/ANTENNA feature is set to CABLE. <i>Details are on page 11.</i>

Trouble Checks

Trouble

Here's what to try:

Cassette with safety tab removed does not start to play automatically	<ul style="list-style-type: none"> • Set AUTO PLAY ON/OFF feature to ON. <i>Details are on page 22.</i>
No stereo sound during playback	<ul style="list-style-type: none"> • TAPE PLAYBACK: HI-FI/MIX/LINEAR feature must be set to HI-FI to hear stereo sound during playback. <i>See page 21.</i>
Stereo audio too noisy	<ul style="list-style-type: none"> • Stereo signal is weak. Set RECEPTION: STEREO/SAP/MONO feature to MONO. • Press one of the TRACKING up or down buttons to minimize the noise.
S-VHS recording not made or no sound during playback	<ul style="list-style-type: none"> • Check position of S-VHS AUTO switch on VCR. <i>See page 38.</i> • A tape with S-VHS must be used to make S-VHS recordings. • Make sure the component's S-VIDEO connectors are connected using an S-VHS cable. • Be sure to also connect the audio cables. The S-VHS cable carries only video.
Tape plays over and over	<ul style="list-style-type: none"> • Check setting of AUTO REPEAT ON/OFF menu. <i>See page 22.</i>
Jog shuttle arrow buttons will not function	<ul style="list-style-type: none"> • Press JOG SHUTTLE button to turn on jog shuttle buttons. Indicator will light. • Indicator light off. Pressing any other button during jog shuttle operation will turn off jog shuttle. Press JOG SHUTTLE to turn jog shuttle back on.
Tape continues forward or reverse search during jog shuttle operation	<ul style="list-style-type: none"> • Press PLAY•PAUSE on the VCR or PLAY on the remote to return to normal playback. • Press ▼ or ▲ to place VCR in pause mode.

Limited Warranty

What your warranty covers:

- Any defect in material or workmanship.

For how long after your purchase:

- Ninety days for labor charges.
- One year for parts.

The warranty period for rental units begins with the first rental.

What we will do:

- Pay any Authorized RCA VCR Servicenter the labor charges to repair your VCR.
- Pay any Authorized RCA VCR Servicenter for the new or, at our option, refurbished replacement parts required to repair your VCR.

How you get service:

- Take your VCR to any Authorized RCA VCR Servicenter. To identify your nearest Authorized RCA VCR Servicenter, ask your dealer, look in the Yellow Pages, or call 1-800-336-1900.
- Show the service technician your evidence of purchase date.
- Pick up your VCR when repairs are completed.

What your warranty does not cover:

- Customer instruction. (Your Owner's Manual clearly describes how to install, adjust, and operate your VCR. Any additional information should be obtained from your Dealer.)
- Installation and related adjustments.
- Signal reception problems not caused by your VCR.
- Damage from misuse or neglect.
- Cleaning of video/audio heads.
- Remote control batteries.
- A VCR that has been modified or incorporated into other products or is used for institutional or other commercial purposes.
- A VCR purchased or serviced outside the USA.
- Acts of God, such as but not limited to lightning charge.

Product Registration:

- Please complete and mail the Product Registration Card packed with your VCR. It will make it easier to contact you should it ever be necessary. The return of the card is not required for warranty coverage.

How state law relates to this warranty:

- This warranty gives you specific legal rights, and you also may have other rights that vary from state to state.

If you purchased your VCR outside the United States:

- This warranty does not apply. See your dealer for details.

Index

- 3 CH. 4 Switch 3-8,43
- A.DUB Indicator 40-41
- A•V DUB Button 14,40-41
- Accessories, Included 10
- Add or Remove Channels Memory 11
- ADD/REMOVE CHANNEL Menu 11
- Amplifier/Receiver Connections 9
- Antenna Connections 2,3
- Arrow  Buttons 14,25
- Audio and Video Dubbing 40-41
- AUDIO and VIDEO IN Jacks 8,9,32,39,43
- AUDIO and VIDEO OUT Jacks 3-9,21,39,43
- Audio Components, RCA 19
- AUDIO Menu 21,31
- AUTO PLAY Feature 20,22
- AUTO REPEAT Feature 22
- AUTO TV/VCR Feature 12,20
- AUTO CHANNEL SEARCH Feature 1
- Automatic Head Cleaner 29
- Automatic Tracking 24
- AUX (Auxiliary) Button 14,19
- Back Panel 43
- Batteries, Inserting in Remote 10
- Blank Search Feature 27
- BLANK SEARCH Menu 27
- Broadcast Stereo, Recording 31
- CABLE BOX SETUP Menu 33
- CABLE Button 14-15,18
- Cable Box Function Buttons 15
- Cable Box, Programming Remote 18
- Cable System With Cable Box Connections 2,4-5
- Cable System Without Cable
 - Box Connections 2,3
- Card, Registration i
- CHAN (Channel) Up or Down Buttons 1,14-15
- CHANNEL Buttons 11,42
- CHANNELS Menu 11,33,34
- Checks, Trouble 46-48
- Choosing a Hookup 2
- Cleaning the VCR 45
- CLEAR Button 13-15,23,26,27,34-37
- Clearing VCR Plus+ and Timer Recordings 37
- Commercial Scan 26
- Connections
 - Amplifier/Receiver 9
 - Antenna 2-3
 - Audio/Video Jacks 2,3-9
 - Cable-TV 2,3-5
 - RCA DSS Receiver 6-7
 - Two VCRs 8
- Contents 1
- Controlling a TV with Remote 17
- Copying and Editing Tapes 39
- Copying Tape, Connections 8
- Date and Time, Setting 13
- Design Specifications 45
- DISPLAY Button 14-15,23,27
- Display Panel 13,44
- Displays, Status 23,44
- DSS®, *see* RCA DSS
- Dubbing 40-41
- Editing and Copying Tapes 39
- Express Recording 30
- Express Recording, Stopping 30
- FWD (Fast Forward) Button 23,24,26,27,39,42
- FF (Fast Forward) Button 14,23,24,26,27,39
- First-Time Operation 10-13
- Flying Erase Head 29
- Frame Advance Feature 25
- Front Panel Controls 41
- Head Cleaner, Automatic 29
- Hi-Fi Indicator 21,44
- Hookups
 - Amplifier/Receiver 9
 - Antenna 2-3
 - Audio/Video Jacks 2,3-9
 - Cable-TV 2,3-5
 - Two VCRs 8
- IN FROM ANT (Antenna) Connector 3-8,43
- INDEX Feature 26
- INDEX SEARCH Menu 26
- INPUT Button 14,32,37,40,41,43,44
- JOG SHUTTLE Button and
 - Indicator 14,25,40-41
- Limited Warranty 49
- Line Indicator (L1 or L2) 44
- Line Input, Timer Recording From 37
- Location of Controls
 - Remote Control 14-15
 - VCR Back Panel 43
 - VCR Display Panel 44
 - VCR Front Panel 42
- LP Speed 29
- Manual Tracking 24
- MENU•PROG Button 11-14,16,21,22,31-37
- MUTE Button 14-15
- Number Buttons 14-15
- On-Screen Displays 23
- Operating Instructions
 - Copying Tapes 39
 - Express Recording 30
 - Playing a Tape 20
 - Recording a Program 28
 - S-VHS Recording 38
 - Timer Recording 36
 - VCR Plus+ Recording 34-35
- Operation, First Time 10-13
- OUT TO TV Connector 3-8,43
- PANEL DISPLAY Feature 13
- PAUSE Button 14-15,24,25,29,39-42
- Pause for Stop Action 24
- Pause, Recording 29
- Picture Search 24,25
- PLAY Button 14-15,20,24,25,28,30-32,39-42

Index

- PLAY•PAUSE Button20,24-25,27,29,39-42
- TAPE PLAYBACK:
- HI-FI/LINEAR/MIX Feature21,32
 - Playing a Tape20-27
- POWER Button14-15,17-19,30,35,36,42
- PREFERENCES Menu12,13,16,22
- PREV CH (Previous Channel) Button14-15
- Product Registrationi
- Programming Remote for Cable Box18
- Programming Remote to Control VCR16
- Programming Remote to Control TV17
- RCA Digital Satellite System18
- RCA DSS® Satellite Receiver15,18,33
- RCA DSS® Satellite Receiver
- Function Buttons15,18
- REC Button14-15,28,30-32
- REC Indicator28,30-32,44
- RECORD Button28,30-32,39,42
- RECEPTION: STEREO/MONO/
- SAP Feature31,32
- Recording
- Audio Only32
 - Basic28
 - Broadcast Stereo TV31
 - Express30
 - From Another VCR39
 - One Program While Watching Another28
 - Pause29
 - S-VHS38
 - SAP (Second Audio Program)31
 - Speeds29
 - Timer36
 - Types Of28
 - VCR Plus+34-35
- Recording Audio Only32
- Recording, Basic28
- Registration Cardi
- Remote Control12-19
- VCR1/VCR2 Feature16
- Remote Sensor42
- Remove or Add Channels from Memory11
- REMOVE/ADD CHANNEL Menu11
- Repeat Indicator22,44
- REW (Rewind) Button14-15,24,26,27,39,42
- S-VHS AUTO Button38,42
- S-VHS Indicator38,42
- S-VHS Recording38
- S-VHS Recording Chart38
- S-VIDEO Connectors3-8,43
- Safety Precautionsi
- Safety Tab20
- SAP Indicator31,44
- SAP, Recording31
- Satellite System18
- Scan, Commercial26
- SEARCH Button14-15,26-27
- Search, Picture24,25
- Select a Playback Sound21
- Sensor, Remote42
- Set VCR Clock Menu13
- Setting a VCR Plus+ Recording35
- Setting Up the VCR10-12
- Setup Cable Box33
- SETUP OPTIONS Menu12,13,16,22,31,32,34
- SHUTTLE Ring23-27,39,42
- SIGNAL TYPE: CABLE/ANTENNA
- Feature11
 - SLOW + and - Buttons14-15,24
 - Slow Motion24
 - SLP Speed29
 - Solving Problems46-48
 - SP Speed29
 - Specifications45
 - SPEED Button14-15,28,29,30-32,35,36
 - Speeds, Recording29
 - Startup10-13
 - Status Displays23
 - Status Indicators44
 - STEREO Indicator31,44
 - Stereo Amplifier/Receiver Connections9
 - Stereo TV, Recording31
 - STOP Button14-15,20,25-28,30-31,35,36,39-41
 - STOP•EJECT Button18,20,26-28,30-32,35,36,39-42
 - Stop Action Pause24
 - Stopping an Express Recording30
 - Tape Speed Indicators29,44
 - Tape, Playing20-27
 - Time and Date, Setting13
 - Time Counter23,27,44
 - Time Display13,44
 - TIMER Indicator30,35,36,44
 - Timer Recording36
 - Timer Recording
 - Checking37
 - Clearing37
 - Setting36
 - Stopping36
- TRACKING Up and Down
- Buttons14-15,20,24,42
- Tracking, Automatic24
- Tracking, Manual24
- Trouble Checks46-48
- Turn On VCR10
- TV Button14-15,17
- TV Function Buttons15
- TV•VCR Button3-8,12,14-15,20,28,42
- Types of Recordings28
- Using the Remote14-19
- V.DUB Indicator41
- VCR Controls42-44
- VCR Function Buttons14-15
- VCR Indicator12,20,28,44
- VCR MAIN MENU11-13,22,31,32,33-37

Index

VCR PLUS+ CHANNEL LIST Menu	34	VCR2 Button	14,16,30,35,36
VCR PLUS+ Menu	35	VCR1/VCR2 Feature	16
VCR Plus+ Recording		VCR's Memory, Placing Channels In	11
Checking	37	VCRs, Connecting for Tape Copying	8
Clearing	37	Video and Audio Dubbing	40-41
Setting	35	VOL (Volume) Up or Down Button	14-15
Setup	34	Warranty, Limited	49
Stopping	35	Xpress Recording	30
VCR, Cleaning	45	ZERO SEARCH Menu	27
VCR, Turn On	10	Zero Search Feature	27
VCR1 Button	10-13,14,16,28,30,35,36		

For your nearest Home
Entertainment Dealer or
Authorized Servicenter
call toll-free in the U.S.A.

1-800-336-1900

Canadian Consumers –
Your toll free numbers are:

English: 1-800-522-0338

French: 1-800-522-0445

If you would like a copy of this manual in French, please follow the
instructions below:

Si un livret d'instructions en français n'est pas inclus avec votre
appareil, vous pouvez en obtenir un (indiquer le numéro de modèle,
votre nom, et votre adresse) en vous adressant à:

Thomson Consumer Electronics
Attention: Canadian Operations
P.O. Box 0944
Indianapolis, IN 46206-0944

If your VCR needs service, please contact your dealer or the nearest
Servicenter from the yellow pages. Please do not send any products to
the Indianapolis address listed in this manual or on the carton. This
will only add delays in service for your product.

 **THOMSON CONSUMER ELECTRONICS**
10330 North Meridian Street
Indianapolis, IN 46290-1024

©1995 Thomson Consumer Electronics, Inc.

Trademark(s)® Registered

Marca(s) Registrada(s)

Printed in Japan

Part Number 95-VR725HF-1

VQTS3135 (A)

Free Manuals Download Website

<http://myh66.com>

<http://usermanuals.us>

<http://www.somanuals.com>

<http://www.4manuals.cc>

<http://www.manual-lib.com>

<http://www.404manual.com>

<http://www.luxmanual.com>

<http://aubethermostatmanual.com>

Golf course search by state

<http://golfingnear.com>

Email search by domain

<http://emailbydomain.com>

Auto manuals search

<http://auto.somanuals.com>

TV manuals search

<http://tv.somanuals.com>