

REALISTIC[®]

OWNERS' MANUAL

MODEL DX-150A

**THE WORLD'S FIRST DELUXE
ALL SOLID STATE FOUR BAND**

AC / DC
117V / 12V

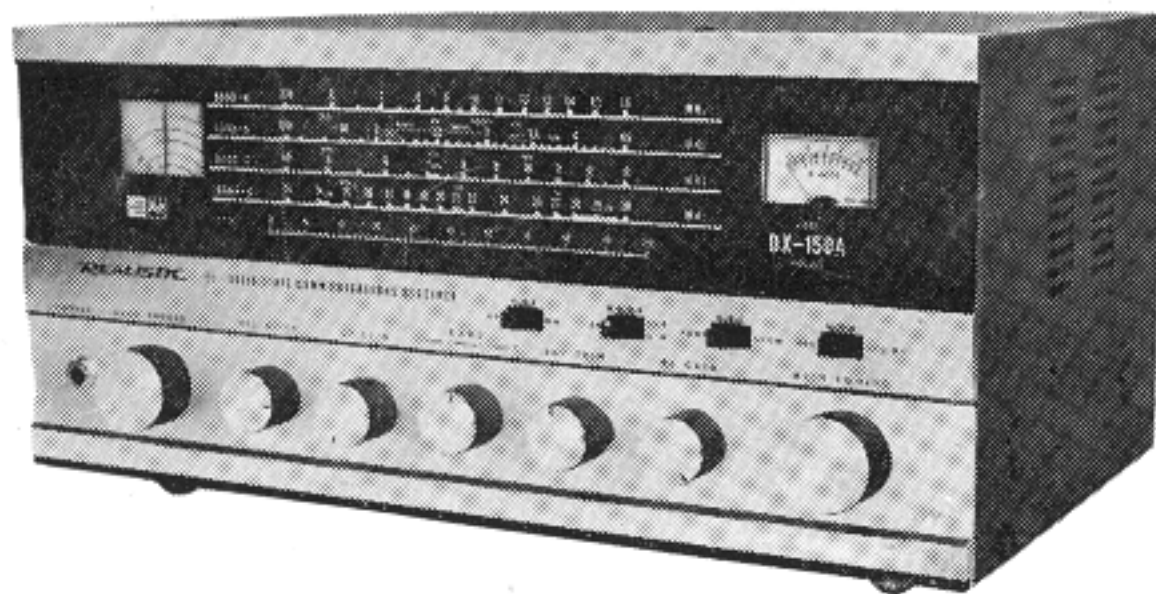

© 1972
COPYRIGHT 1972

CUSTOM MANUFACTURED FOR
RADIO SHACK **T C** A TANDY CORPORATION COMPANY

13

- Short Wave Puts the World at Your Fingertips !
- Tune In On Broadcasts From Far Off Places !
- Hear Live-Action Drama as It Actually Happens !
- Be Able to Tune in all Types of Communications-SSB/AM/CW-Amateur, CB, International, Government.

... It All Comes to Life on Your
Realistic DX-150A Communications Receiver

Today's busy airwaves are literally full of programs of entertainment and educational value. A good portion of international programming is transmitted in English from such distant cities as London, Tokyo, Paris, Rome, Berlin and Moscow.

Many fascinating and important events occur every day on the short wave radio bands. You may hear transoceanic jets making position and weather reports to airways control centers...the captain of a fishing vessel radioing news of his catch...or the Coast Guard instituting rescue operations to aid a ship in distress. The armed services constantly use short wave frequencies to communicate between aircraft, land bases and ships at sea. Radio Amateurs provide a wealth of technical information during their contacts with one another throughout the world.

The short wave bands encompass many, many interesting services, providing thousands of listeners with an absorbing new hobby. There is activity on these bands, day and night, every day, every week of the year.

This booklet has been prepared to help you discover for yourself what a fascinating and wonderful world short wave really is. Happy Hunting on the airwaves !

CONTENTS

- | | |
|-----------------------------|---|
| 1. HISTORY OF SHORT WAVE | 8. MORSE CODE (CM) and RADIO TERMS |
| 2. HOW SHORT WAVE WORKS | 9. DX CHASING |
| 3. WHAT TO LISTEN FOR | 10. COUNTRY LOG |
| 4. YOUR SHORT WAVE RECEIVER | 11. SCHEMATIC DIAGRAM and TRANSISTOR LAYOUT |
| 5. SHORT WAVE ANTENNAS | |
| 6. FREQUENCY CONVERSION | |
| 7. TIME CONVERSION | |

- Short Wave Puts the World at Your Fingertips !
- Tune In On Broadcasts From Far Off Places !
- Hear Live-Action Drama as It Actually Happens !
- Be Able to Tune in all Types of Communications-SSB/AM/CW-Amateur, CB, International, Government.

... It All Comes to Life on Your
Realistic DX-150A Communications Receiver

Today's busy airwaves are literally full of programs of entertainment and educational value. A good portion of international programming is transmitted in English from such distant cities as London, Tokyo, Paris, Rome, Berlin and Moscow.

Many fascinating and important events occur every day on the short wave radio bands. You may hear transoceanic jets making position and weather reports to airways control centers...the captain of a fishing vessel radioing news of his catch...or the Coast Guard instituting rescue operations to aid a ship in distress. The armed services constantly use short wave frequencies to communicate between aircraft, land bases and ships at sea. Radio Amateurs provide a wealth of technical information during their contacts with one another throughout the world.

The short wave bands encompass many, many interesting services, providing thousands of listeners with an absorbing new hobby. There is activity on these bands, day and night, every day, every week of the year.

This booklet has been prepared to help you discover for yourself what a fascinating and wonderful world short wave really is. Happy Hunting on the airwaves !

CONTENTS

- | | |
|-----------------------------|---|
| 1. HISTORY OF SHORT WAVE | 8. MORSE CODE (CM) and RADIO TERMS |
| 2. HOW SHORT WAVE WORKS | 9. DX CHASING |
| 3. WHAT TO LISTEN FOR | 10. COUNTRY LOG |
| 4. YOUR SHORT WAVE RECEIVER | 11. SCHEMATIC DIAGRAM and TRANSISTOR LAYOUT |
| 5. SHORT WAVE ANTENNAS | |
| 6. FREQUENCY CONVERSION | |
| 7. TIME CONVERSION | |

1. HISTORY OF SHORT WAVE

The development of short wave involved such famous personalities as Hertz, Maxwell, Marconi, DeForest, Armstrong and many others. Each made significant contributions to the growth of radio and short wave... Maxwell developed new mathematical formulae; Hertz transmitted the first radio signals; DeForest invented the vacuum tube; Armstrong conceived and developed such radio circuitry as the superheterodyne and the FM receivers. Marconi, of course, transmitted the first transatlantic radio signal from England to Canada.

Marconi's feat was the more amazing because it was generally assumed that radio signals like light rays travelled in straight lines. It was thought that radio waves would shoot off into space—that they were incapable of curving around the earth.

Further transatlantic tests indicated an increase in distance from day to night operation. Two theorists—Kennely and Heaviside—working independently of one another, conceived the idea of an electrical region high in the earth's atmosphere that acted like a mirror on radio waves. Instead of heading into space, radio-wave energy was reflected back to earth where it could be received by a distant station. In tribute to the accuracy of the concept, the region was designated the Kenely-Heaviside Layer. Today it is more commonly called the ionosphere. The special behavior of this electrified region is largely responsible for the first field of short wave radio.

"Ham" Operators also have contributed greatly to the development of short wave listening. Radio amateurs have been communicating across the "Pond" (the ocean) since the early 1920's on all the short wave bands available to them.

2. HOW SHORT WAVE WORKS

A short wave signal is an invisible field of energy which travels at the speed of light (186,000 miles per second) as it carries a signal from the antenna of a station to the short wave set.

The electrical forces which produce a radio wave originate in the transmitter portion of the sending station. Electrical currents are made to surge back and forth at extremely high speeds. As these currents progress through the various stages in the transmitter, they are amplified and boosted in power. This radio frequency power is then applied to the transmitting antenna thus generating the actual radio wave... the field of electrical energy which travels outward from the antenna. As described earlier, this wave travels upward toward outer space with some of the wave's energy reflected off the ionosphere and back to earth to a distant receiving station. See Fig. 1.

FIG. 1



At different periods of the year, short-wave reception improves above the usual value between the receiving site and various areas in the world. As an example — the spring months bring the strongest signals from Australia and the South Pacific. In the fall months, signals from Europe and the Far East dominate the bands. Also, as daylight changes into darkness each day between your receiving location and the transmitting station, so does the nature of the reception. Day-to-day variations are also present.

3. WHAT TO LISTEN FOR

The Short Wave Bands are your passport to a world of exciting adventure—**AMATEUR RADIO**. Amateur (ham) radio stations are operated by private citizens in more than 250 countries around the world. (See Section 9B)

Hams talk to other amateur operators for personal pleasure or experimentation. No business or commercial transactions are permitted over stations operating in this service. Hams are allowed to operate on any frequency within assigned bands. The amateur bands are the 160-80-40-20-15 and 10 meter bands. The section on frequency conversion will give an explanation of the relationship between megahertz and meters.

SINGLE SIDE BAND. When tuning your receiver across the amateur bands, you will hear many single side band signals. This type of signal will sound distorted and unintelligible in an ordinary AM (Amplitude Modulated) receiver. The reason for this is the absence of a carrier in the transmission of a single side band signal. Your DX-150A receiver allows you to clarify a single side band signal through the use of a product detector. The SSB-CW position on the mode switch enables you to “re-insert” carrier to a received SSB signal. The adjustment of the BFO pitch and band spread tuning will further clarify the received signal.

SHIP-TO-SHORE MOBILE RADIO TELEPHONE. Essentially a telephone without wires. Operated by telephone companies and businesses who lease transmitters and receivers to individuals. Listen between 2 and 3 megahertz.

AIRCRAFT. Weather information, flight conditions, rerouting of plans in time of bad weather. Federal communications between planes and stations on the ground. Signals in this service are found at approximately 2.6, 2.9, to 3.0, at 4.1 and at approximately 7.6 MHz.

MILITARY. Air Force, Army, Navy, Marine and Coast Guard communications may be heard between ground stations and planes or vehicles 24 hours a day. These signals may be heard throughout the short wave frequency range.

MARITIME MOBILE. Commercial vessels, fishing fleets, and pleasure craft regularly communicate routine and emergency messages on short wave. These may be heard in the ranges from 2 to 3 MHz, 4 to 4.4 MHz, 6.2 to 6.5 MHz and 7.9 to 8.8 MHz.

INTERNATIONAL SHORT WAVE BROADCASTING. International broadcasting offers the most varied entertainment of all the services you will listen to on short wave. Many governments operate powerful short wave transmitters (e.g. the U.S. Government's Voice of America) to keep the world informed of activities within their countries. Many countries also license commercial short wave stations and, in fact, many regions of the world conduct most of their daily broadcasting on short wave instead of on the standard broadcast band. For specific stations and frequencies consult your Country Log.

STANDARD TIME SIGNALS-WWV and CHU. The United States Bureau of Standards broadcasts the correct time with voice as well as code identification. The identification occurs during the last ten minutes of each 5-minute period (i.e. 03 to 05, 08 to 10, 13 to 15, etc.). Other checks such as radio frequency, audio frequency and forecast of conditions which will affect radio reception are broadcast. WWV will be found at 2.5, 5.0, 10.0, 15.0 and 20.0 MHz. The Canadian Government provides a similar service at 3.3 and 7.33 MHz. Voice announcements are made every minute in both English and French over station "CHU".

4. SHORT WAVE RECEIVER

Your Realistic DX-150A is a communications Receiver designed and manufactured to the most rigid quality standards. It has been packed to ensure safe arrival. Carefully lift the unit out of the shipping carton and inspect for any visible damage.

Decide where you want to set up the receiver. In making your decision you should consider :

- a. **YOUR COMFORT.** You will spend many hours with your receiver-be sure it is placed where you can enjoy it at any time.
- b. **YOUR ANTENNA.** In the beginning, you will doubtless use a long wire antenna. As you gain more experience and begin reaching out for more distant stations, you may want to set up an outside antenna. With this in mind, choose a location near a window or outside wall. A short wave antenna kit is available at your nearest Radio Shack store (Cat. No. 278-1373).
- c. **YOUR GROUND.** If you set up an outside antenna, it is good practice to ground your set for safety. This will require running a ground wire from the ground connection on the back of the receiver to a cold water pipe or metal pipe driven into the earth.

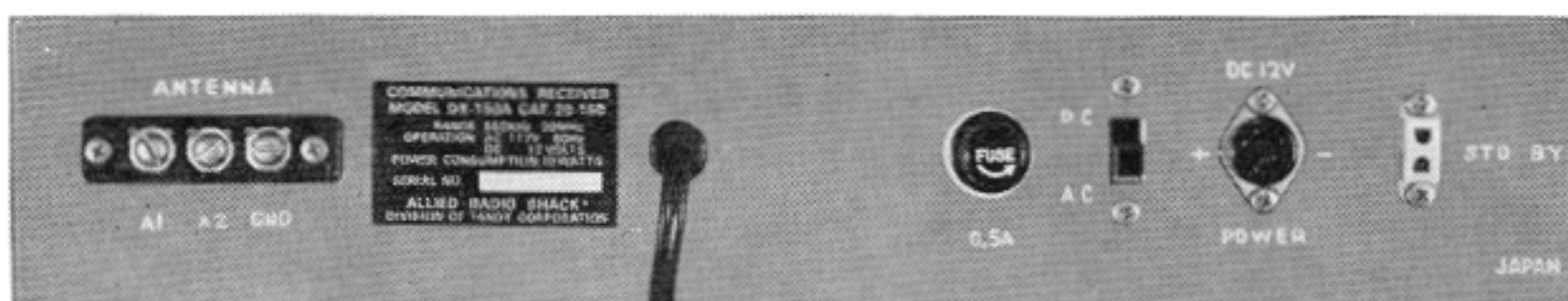

BACK VIEW OF RECEIVER FIG. 2

Connect a lead-in wire to antenna terminal marked A1 and a ground lead to terminal marked G. Stretch lead-in wire out through the window and UP to your antenna.

Reception on the Broadcast Band can be improved by the use of a random length long wire antenna. Generally the longer the wire, the better the reception. [See diagram Page 8]

AC OPERATION

To complete the initial AC installation, plug your receiver into an electrical outlet which provides 105-125 VAC, 60 Hz. Power consumption is 10 watts. This is the type of electrical supply common throughout the United States.

12V DC OPERATION

The DX-150A may also be used on 12V DC negative(—) ground. 12V negative is standard on most U.S. cars. Additionally you may use any other 12V DC source such as 8 1½V D-size dry batteries (23-466, 23-150, 23-222, etc. from Radio Shack's catalog). DX-150 accessories include a 12V DC cigarette lighter cable set and an 8-cell battery pack and cable set (Cat. No.20-1501). To switch to DC operation from AC use slide switch on back panel; front panel on-off control is used in normal manner. Dial lights do not function on 12VDC.

WIRING A DC PLUG IF NECESSARY

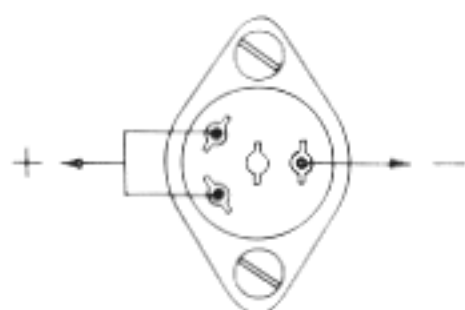

FIG. 3

Unscrew back cap of plug. Solder as indicated in Fig. 3, push wire through back of plug and soldering at pin side, Fig. 3A.

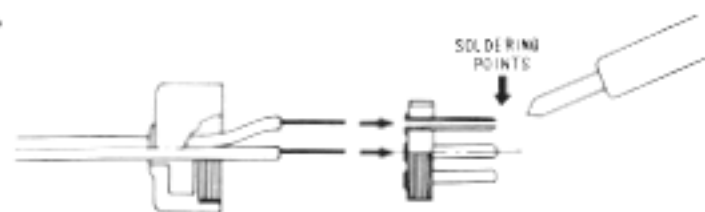

FIG. 3A

HOW TO OPERATE YOUR RECEIVER

We would suggest that you familiarize yourself with your receiver by tuning in the Standard AM Broadcast Band (Band A) first. Familiar stations will come in loud and clear. You'll also discover many other stations which you may never have heard before.

Readying Your Receiver :

- Turn unit ON by turning the OFF/VOLUME clockwise.
- Slide AM-CM/SSB to AM position.
- Slide OPR switch to REC
- Turn Bandsread Control until hair line is on high end of dial.
- To select the band you wish to tune, turn BAND SELECTOR Control to the appropriate band number.

Tuning Standard AM Broadcast Band :

- Turn BAND SELECTOR Control to Band A setting.
- Using TUNING Control, move pointer to the station frequency desired.
- If several stations are close together, they may be fine tuned on the Bandspread Dial . . usually by moving from high to low until you have separated the stations.

Tuning Short Wave Stations :

The transmission of short wave signals is a more precise operation. There are several things, beyond the control of your receiver, which may affect their reception. These are: 1) atmospheric conditions-e.g. solar disturbances which can help make a signal come in loud and clear OR reduce signal strength and clarity OR block it out completely; 2) day-to-night and month-to-month atmospheric variance; 3) your own skill in tuning your receiver. A good way to develop your skill rapidly is Dial Scanning (tuning through the entire band).

Dial Scanning :

- Select the band you wish to scan by turning BAND SELECTOR Control to Band A-B or C.
- Adjust Bandspread Dial to high end.
- Slowly move the pointer across the dial using the TUNING Control. Alternately, you will hear—nothing, a few squeals, then code (dots and dashes), voice or music.
- When you have tuned in as fine as possible with the TUNING Control, use the BANDSPREAD Control to further separate stations.
- The CW code which you have heard while scanning may be tuned in clearly enough to READ by turning the AM/CM. Turning the BANDSPREAD control will make the tone sound higher or lower as you wish.

5. ANTENNAS

An antenna is a *necessary* adjunct to ALL short wave receivers. The better the antenna, the more signals you will be able to receive (even weak and remote ones).

Because the majority of owners want good results on all short wave frequencies covered by DX-150A a suitable antenna for general coverage is sketched at right.

For the best reception, mount it high and clear away from power lines, trees and surrounding objects.

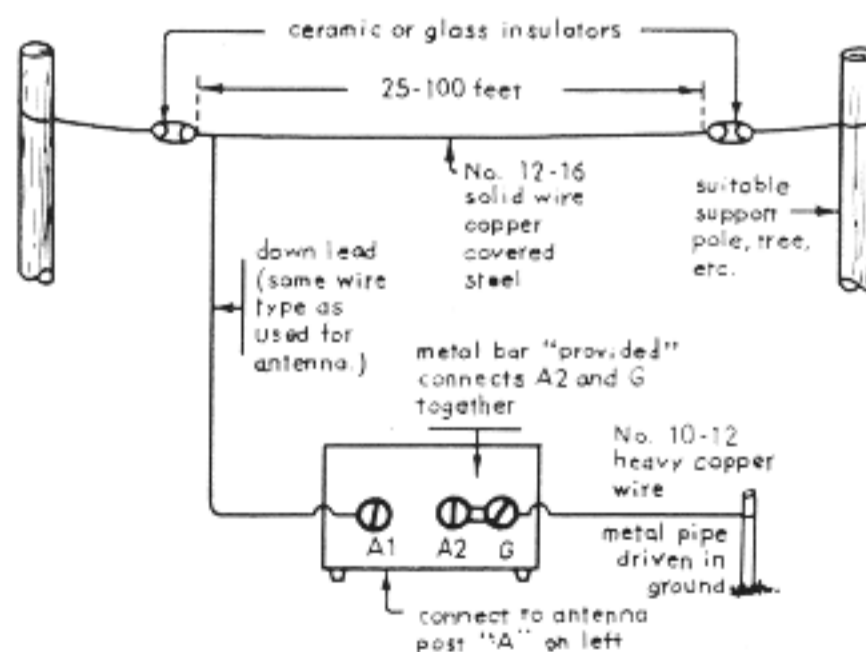

FIG. 4

6. FREQUENCY CONVERSION

Communications receivers are calibrated in megahertz. However, it is helpful to know which meter band corresponds to the frequency (in megahertz) of the station being tuned in. This applies particularly to the International Short Wave Broadcasting stations which often announce only in meters. Megahertz may be converted to meters by using this simple formula:

$$300/\text{Megahertz} = \text{Meters}$$

For example:

$$300/7.1 = 42.25 \quad \text{or} \quad 7.1 \text{ MHz} = 42.25 \text{ meters}$$

The conversion from meters to megahertz uses the same formula:

$$300/\text{Meters} = \text{Megahertz}$$

For example:

$$300/42.25 = 7.1 \text{ MHz}$$

7. TIME CONVERSION

A 24-hour clock is used to tell communications time. One AM is 0100; four AM is 0400; Noon is 1200; 3:30 PM is 1530; 8:45 PM is 2045. This simple method precludes any confusion between AM and PM. (See Chart at right).

GMT (Greenwich Mean Time—the time at Greenwich Observatory, England) is the basis for telling time in International Broadcasting. To convert from GMT to local time or any other time zone, add or subtract the hours shown on the INTERNATIONAL TIME MAP (below).

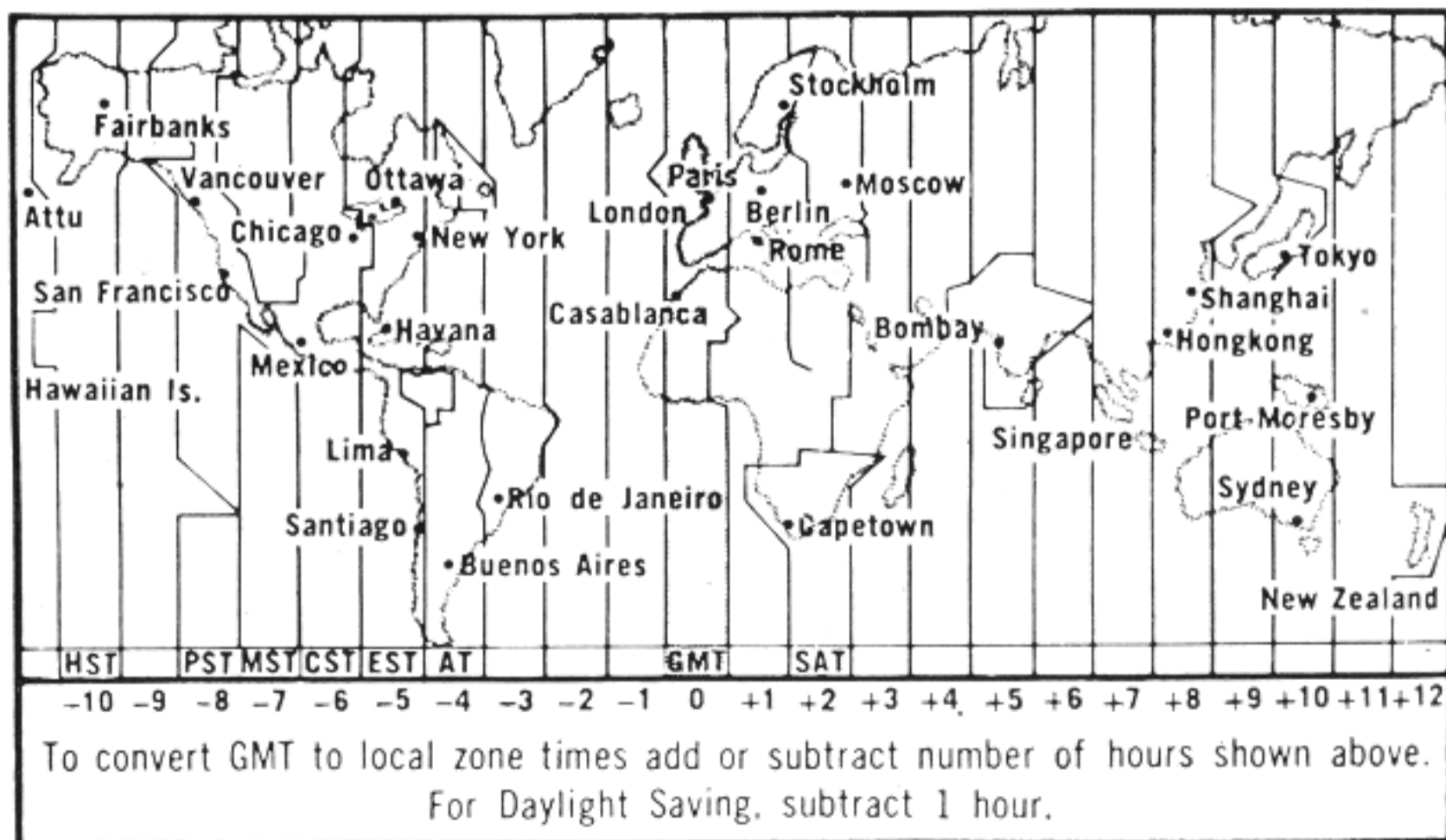
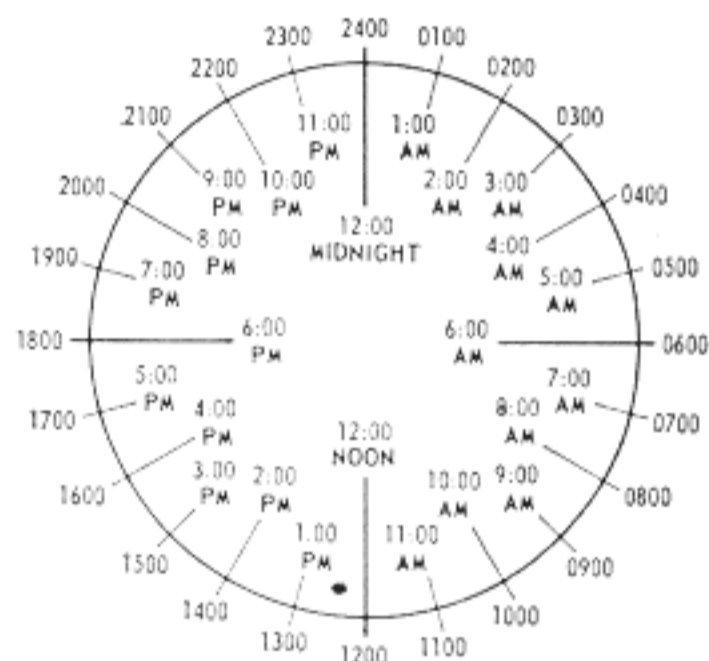

Example: 2300 GMT is 1800 EST (Eastern Standard Time). This is equivalent to 11:00 PM in London, Eng., 6:00 PM in New York or 7:00 AM in Tokyo (the next day).

REALISTIC[®] MODEL DX-150A

FOUR BAND SHORT WAVE RECEIVER

(Identification of Features and Controls)

COVERAGE. Broadcast band (Band A) covers 535 to 1600 KHz plus extended coverage up to the 1.8 MHz short wave band. Three other short wave bands are provided which produce continuous coverage from 1.9 MHz (1900KHz) to 30 MHz.

BAND A—Standard Broadcast 535-1.6 MHz

BAND B—Includes 1.55 - 4.5 MHz. The thick lines between 1.8-2 MHz and 3.5-4 MHz signify the 160 meter and 80 meter Amateur Bands respectively.

BAND C—Includes 4.5-13 MHz. The 40-meter Amateur Band is indicated by the thick line.

BAND D—Covers 13-30 MHz. This band includes the 20 meter, 15 meter, 11 meter (CB) and 10 meter bands.

MONITOR SPEAKER: 3×5-inch permanent magnet, 8 ohm voice coil. Also see PHONES below.

PHONES: Front Phone Jack is provided for plugging in any headphones from 8 to 2000 ohms, such as Radio Shack 33-196, 279-198. Jack is also used for plugging in an external 8-ohm speaker such as 20-1500.

BANDSPREAD CONTROL: Similar to a fine tuning control. Use for fine tuning after you have adjusted the main Tuning pointer to the approximate dial locations of the station you wish to receive. This control is calibrated for the individual Amateur Bands. (See Section 9B).

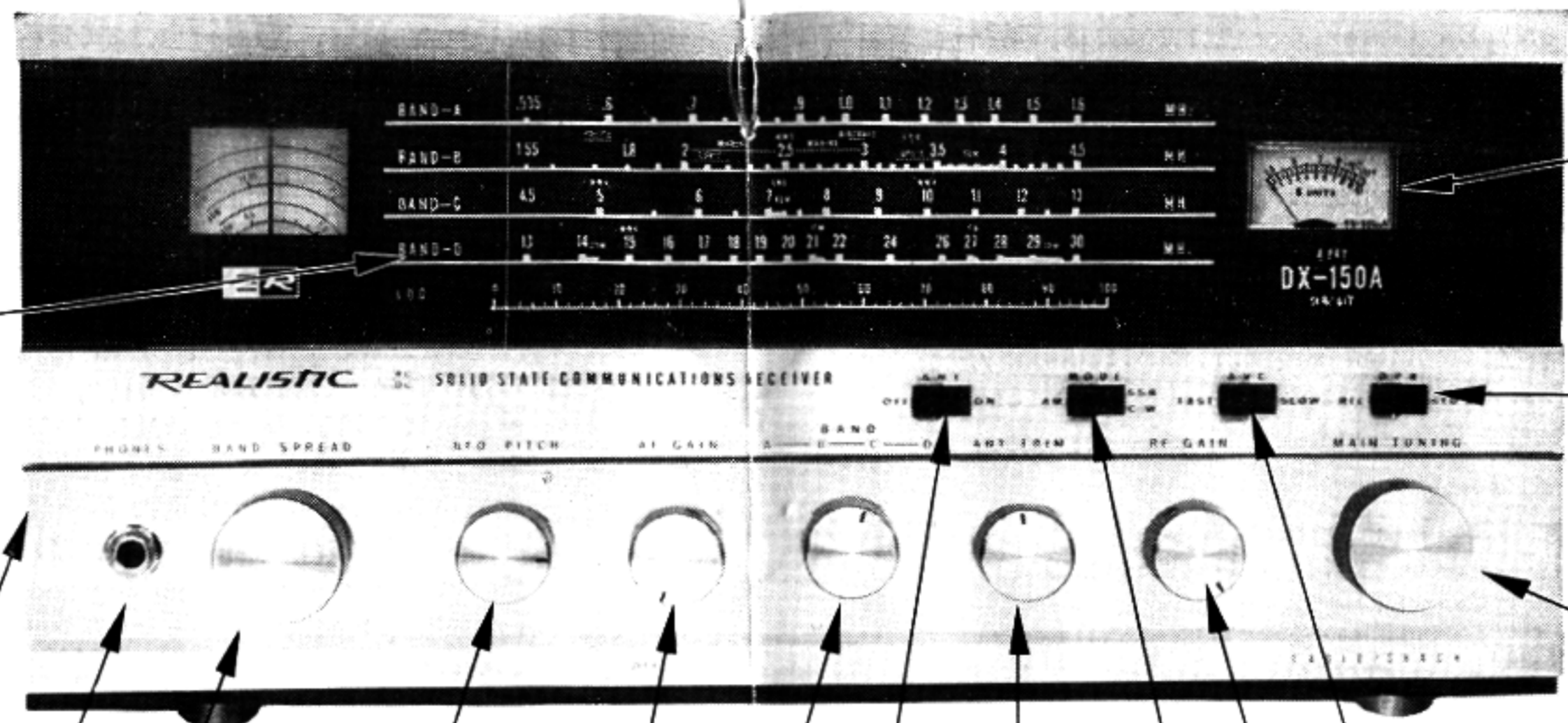

THE "S" METER: An indicator that serves both as a tuning aid and a relative signal strength indicator. The face of the meter is calibrated in both S units and decibels (DB) above S9.

RECEIVE/STANDBY SWITCH: In Receive position, your Audio comes through either your Speaker or your Headphones. In Standby Position, the set remains ON but your Speaker and Headphone circuits are disconnected.

MAIN TUNING CONTROL: Use for regular or fast tuning. Moves pointer to dial location. Use for tuning most Standard Broadcast stations and for scanning the Short Wave Bands.

AVC SWITCH: Switch provides AVC action suitable to either AM, CW/SSB reception. It is marked fast-slow. SSB or CW require fast AVC while AM requires slow AVC.

RF GAIN: This control permits adjustment of RF sensitivity on all bands. For weak signal reception advance control fully clockwise-for very strong signals adjust control counter-clockwise.

SSB/AM/CW SWITCH: Provides the necessary beat frequency tone when receiving CW (code) signals or single sideband (SSB). To receive normal AM broadcasts, the switch should be set in the AM position. To receive CW (code) or SSB signals, switch should be put in the CW, SSB position. Tone pitch is adjusted with BFO Pitch, Bandspread, or main tuning.

BANDSPREAD: When tuning amateur bands, first adjust main tuning control points to high end (♦ setting mark on dial) of indicated band. Then, by tuning band spread control, you will be able to easily tune in amateur signals. The bandspread dial is calibrated for all amateur bands.

BFO PITCH: After peaking the received CW or SSB signal, adjust the BFO Pitch Control either clockwise or counterclockwise for the most desirable CW note or single side band voice quality.

ON/OFF AF GAIN: Turns receiver ON (clockwise) and OFF (counterclockwise); also controls volume which increases as you turn right.

BAND SELECTOR: The letters A, B, C, and D above Band control knob coincide with the band letters on dial at left.

ANTENNA TRIMMER: This control permits peaking incoming signals on all bands for optimum results; a slight adjustment may be necessary on each band.

ANL: Automatic Noise Limiter-Aids in reduction of static and noise.

8. MORSE CODE AND RADIO TERMS

Familiar Short Wave and Radio Amateur Terms

AF Gain Control-same as volume control... *AM*-Amplitude Modulation-the transmitting frequency amplitude is varied at an audio rate... *ANL*-Automatic Noise Limiter-reduces impulse noises (ignition, static, crashes, etc.)... *ANT*-Antenna... *AVC*-Automatic Volume Control-controls radio frequency gain automatically-(i.e., reduces gain on strong signals)... *BFO*-Beat Frequency Oscillator-provides a special beating signal so that CW (code) signals can be heard... *CQ*-a general call used by radio amateurs to establish contact. Caller will talk to anyone who answers. Can also be used specifically (CQ/DX, when calling only DX stations, or CQ Chicago, when calling stations only in Chicago)... *CW*-Continuous Wave-unmodulated signal wherein intelligence is transmitted by interrupting signal to produce dots and dashes (code)... *DX*-distant stations... *FM*-Frequency Modulation-the transmitting frequency is varied at an audio rate... *QRM*-interference from other signals... *QRN*-interference static... *QRX*-Standby... *QSL*-usually a card which verifies contact or acknowledges specific transmission... *QSO*-a contact between two stations... *QSY*-change operating frequency... *RF Gain Control*-radio frequency gain control: controls the sensitivity of the radio frequency amplifier stage... *RST*-readability, strength tone... *SWL*-short wave listener... *73's*-best regards... *88's*-love and kisses... *XYL*-wife... *YL*-young lady... *SSB*-Single Side Band.

Official Radio Ten Signals (Police, fire, etc.)

10-1	Receiving poorly	10-11	Remain in service
10-2	Receiving well	10-13	Advise weather and road conditions
10-3	Granted	10-14	Correct time
10-4	Received	10-18	Anything for us?
10-5	Relay	10-19	Nothing for you
10-6	Standby	10-20	What is your location?
10-7	Out of service	10-91	Too weak; talk louder
10-8	In service	10-92	Too loud
10-9	Repeat, conditions bad	10-93	Frequency check
10-10	Out of service-subject to call	10-94	Give a test

INTERNATIONAL MORSE CODE

Letter	Phonetic Sound	Dot-Dash Sequence	Letter	Phonetic Sound	Dot-Dash Sequence
A	di-dah	•-	T	dah	-
B	dah-di-di-dit	-•••	U	di-di-dah	••-
C	dah-di-dah-dit	-•-•	V	di-di-di-dah	•••-
D	dah-di-dit	-••	W	di-dah-dah	•---
E	dit	•	X	dah-di-di-dah	-••-
F	di-di-dah-dit	••-•	Y	dah-di-dah-dah	-•-•-
G	dah-dah-dit	-••	Z	dah-dah-di-dit	-•••
H	di-di-di-dit	••••	Numbers		
I	di-dit	••	1	di-dah-dah-dah-dah	•----
J	di-dah-dah-dah	•---	2	di-di-dah-dah-dah	••---
K	dah-di-dah	-•-	3	di-di-di-dah-dah	•••--
L	di-dah-di-dit	•-••	4	di-di-di-di-dah	••••-
M	dah-dah	--	5	di-di-di-di-dit	•••••
N	dah-dit	-•	6	dah-di-di-di-dit	-••••
O	dah-dah-dah	---	7	dah-dah-di-di-dit	--•••
P	di--dah-dah-dit	•-••	8	dah-dah-dah-di-dit	---••
Q	dah-dah-di-dah	-•-•-	9	dah-dah-dah-dah-dit	----•
R	di-dah-dit	•-•	0	dah-dah-dah-dah-dah	-----
S	di-di-dit	•••			

9. DX (DISTANT STATION) CHASING

A-INTERNATIONAL SHORT WAVE BANDS

The technique of DX Chasing requires a certain degree of electronic detective work. Although some activity always prevails on the bands, you will find your time more profitably (and more enjoyably) employed if you devote some effort to preparing a careful schedule prior to listening for DX. Programs, Propagation Reports from the U.S. Bureau of Standards, Logs-should all be studied, analyzed and written up, in that order. These tactics are basic.

DX Chasing presents an intriguing challenge to the SWL'er in addition to being a source of interest and education. Following is a list of INTERNATIONAL SHORT WAVE Bands that your receiver is capable of receiving.

60 METER BAND. Frequency Range: 4.75 to 5.06 MHz. This is primarily a domestic band broadcasting to local listeners. However, it is often possible to receive such signals at considerable distances. The 60-meter region is designated the "Tropical Band" since many of the stations using it are located in South and Central America. On occasion, the central and southern parts of Africa are also heard. Best reception on this band is during the winter months in the early evening.

49 METER BAND. Frequency Range: 5.95 to 6.2 MHz. The behavior of this band is somewhat similar to the 60-meter band. However, it is occupied by very strong International Broadcasting stations and, for this reason, may at times be more consistent.

41 METER BAND. Frequency Range: 7.1 to 7.3 MHz. A shared band that will, at times, have interference from other services. Radio Amateur stations will be heard occasionally between 7 and 7.3 MHz with voice signals between 7.2 and 7.3 MHz. During the evening hours, strong international Broadcasting stations almost completely take over this band.

31 METER BAND. Frequency Range: 9.2 to 9.7 MHz. This band offers the greatest coverage of all. Primarily a nighttime band, it offers some daylight listening as well. It also holds up well during the winter evenings, making it one of the best all-round bands in the spectrum.

25 METER BAND. Frequency Range: 11.7 to 11.975 MHz. The daylight reception is somewhat improved over the lower frequencies. Evening reception is possible at certain times of the year but not as regularly as on the lower bands.

19 METER BAND. Frequency Range: 15.1 to 15.45 MHz. Signals over extreme distances are heard after sunrise and throughout the daylight hours. Some night listening is possible during the summer months.

16 METER BAND. Frequency Range: 17.7 to 17.9 MHz. Signals at this end of the Radio Frequency spectrum are significantly subject to changes in sunspot activity. The generally accepted theory is that, as the number of sunspots increase, the higher frequencies are received over longer distances. Therefore, at the peak of the solar cycle, this band should offer wonderful possibilities of daylight DX. (Note: the solar cycle peak occurs at eleven year intervals. The last peak occurred in 1958-59).

14 METER BAND. Frequency Range: 21.450 to 21.7 MHz. Signals in this band are subject to changes in sunspot activity. At times this band will have stronger signals than the 16 meter band due to a build up of ionospheric return from frequencies higher than 21 MHz. Many international stations are now moving into

the 14 meter band in anticipation of better sunspot conditions.

B-AMATEUR SHORT WAVE BANDS

160 METER BAND. Frequency Range: 1.8 to 2 MHz. This band is located on the high side of the Domestic Broadcast Band and is normally used for local distances of 25 to 200 miles. CW and phone are used on a shared basis.

80-75 METER BAND. Frequency Range: 3.5 to 4 MHz. This band, normally used for distances of 50 to 500 miles, has occasional openings of up to 3000 miles at night. CW is from 3.5 to 3.8 MHz; phone is from 3.8 to 4 MHz.

40 METER BAND. Frequency Range: 7.0 to 7.3 MHz. Good for distances of 150 to 2000 miles. As with the lower frequencies, the distance increases during the dark hours with occasional openings to 5000 miles.

20 METER BAND. Frequency Range: 14.0 to 14.350 MHz. This band, normally used for distances of 600 to 3000 miles, has occasional openings of up to 7000 miles. The CW portion is from 14.0 to 14.2 MHz. USA phone is from 14.2 to 14.350 MHz. Peak distances are usually at sunrise and sunset. This is primarily a daylight band with nighttime activity limited to the late spring, summer and early fall months.

15 METER BAND. Frequency Range: 21.0 to 21.450 MHz. American phone portion 21.250 to 21.450 MHz. Normal distances from 800 to 4000 miles with occasional openings of up to 8000 miles. This is a daylight band with peak distances occurring during the day right up to sunset. Summer time produces a combination of long distance and short distance "skip". During winter evenings the band is usually dead with signals limited to "line of sight" signals, sometimes referred to as "ground waves".

10 METER BAND. Frequency Range: 28.0 to 29.7 MHz. CW portion 28.0 to 28.5 MHz; American phone portion 28.5 to 29.7 MHz. Normal distance Ranges from 1000 to 5000 miles with occasional openings of up to 10,000 miles or better. Summer time produces a phenomenon commonly referred to as "short skip" with intermediate distances of 200 to 800 miles. During winter evenings the band is normally closed with ground wave signals limited to 25 to 50 miles. During this period the waves act similiary to VHF (very high frequencies) or television frequencies.

10. COUNTRY LOG

The following pages will be useful in spotting and identifying International Short Wave Broadcasting stations in operation around the world. The stations listed can be heard throughout the North American Continent. Transmission periods vary throughout day and night. ALL broadcasts (unless otherwise specified) are in English.

Columns are provided for LOCAL TIME HEARD (see Section-TIME CONVERSION) and PROGRAM TYPE so that you may identify the broadcast you heard.

Canada, Great Britain and the U.S. transmit many English broadcasts (in addition to those listed in the Log). Below are listed a number of International Short Wave stations heard around the world. It should be noted that the actual number of stations is far larger than this list.

CITY	COUNTRY	CALL	MHz	PROGRAM	TIME HEARD
Monrovia	Liberia	ELBC	3.255		
Belize	British Honduras		3.300		
Accra	Ghana		3.365		
Paradys	S. Africa		4.810		
	Singapore	FBS	5.010		
Dar-es-salaam	Tanganyika		5.050		
Addis-Ababa	Ethiopia		5.060		
Sao Paulo	Brazil	ZYR226	5.955		
Ismaning	Germany		5.960		
	Dominican Republic	Radio Caribe	5.970		
Ciudad	North Borneo		5.980		
Jesselton	Haiti	4VB	5.980		
Cap Hatien	Rumania		5.990		
Bucharest	Belgium	ORU	6.000		
Brussels	Egypt		6.015		
Abu Zabal	Rhodesia		6.020		
Salisburg	Morocco		6.025		
Tangier	Iraq		6.030		
Abu Ghurais	England	GWS	6.035		
Daventry	Monaco	3M3	6.037		
	China	BCA22	6.040		
Nanking	Indonesia	YDF	6.045		
Djakarta	Nigeria		6.050		
Ibadan	Poland		6.055		
Warsaw	Canada	CKR2	6.060		
Sackville N.B.	India		6.065		
Delhi	U.S.S.R.		6.075		
Minsk	Canada		6.100		
Halifax	England	BBC	6.110		
London	Monaco		6.115		
	Japan	FEN	6.160		
Tokyo	Mexico		6.165		
Mexico City	Switzerland		6.165		
Berne	Nigeria		6.175		
Kaduna	North Korea		6.195		
Pyongyang	North Korea		6.250		
Pyongyang	Egypt		7.051		
Cairo	Taiwan		7.100		
Chiavi	Congo		7.105		
Brazzaville	Okinawa	VOA	7.160		
Naha	Hungary		7.220		
Budapest	Pakistan		7.280		
Karachi	East Germany		7.300		
Berlin	Czechoslovakia		7.340		
Prague	U.S.S.R.	Radio Moscow	7.555		
Moscow	Belgium		9.144		
Brussels	Bulgaria		9.255		
Sofia	China		9.480		
Peking	Denmark	OZF	9.520		
Copenhagen	Cuba		9.531		
Havana	Nigeria		9.535		
Lagos	Switzerland		9.535		
Berne	New Zealand	ZL2	9.540		
Wellington	Czechoslovakia		9.550		
Prague	Windward Islands	WIBS	9.550		
St. George's	Rumania		9.570		
Bucharest					

COUNTRY LOG (Continued)

Rome	Italy	RAI	9.575
Montreal	Canada	CBC	9.585
Lourenco	Mozambique		
Marques		CR7BJ	9.616
Stockholm	Sweden	Radio Sweden	9.665
Buenos Aires	Argentina	LRA	9.690
	Dominican		
Ciudad	Republic	Radio Caribe	9.735
Peking	China		9.785
Moscow	U.S.S.R.	Radio Moscow	9.805
Barbados	Windward Islands	2NX50	11.475
Moscow	U.S.S.R.	Radio Moscow	11.570
Cairo	Egypt		11.665
Bangkok	Thailand	HSK9	11.670
Karachi	Pakistan		11.674
Stockholm	Sweden	Radio Sweden	11.705
New Delhi	India		11.710
Melbourne	Australia	VLA	11.710
Hilversum	Holland		11.730
St. George's	Windward Islands		11.735
Rabat	Morocco		11.735
Vatican City	Vatican	HVJ	11.740
Montreal	Canada	CBC	11.760
Djakarta	Indonesia		11.795
Melbourne	Australia	VLA	11.810
Moscow	U.S.S.R.	Radio Moscow	11.818
Brussels	Belgium	ORU	11.850
Elizabethville	Katanga		11.866
Manila	Philippines	DZF2	11.920
Brazzaville	Congo		11.925
	Singapore	BBC-FES	11.955
Peking	China		12.125
Teheran	Iran	2PB	15.125
Tokyo	Japan	JOA15	15.135
Helsinki	Finland	O1X4	15.190
Montreal	Canada		15.190
Monrovia	Liberia	ELWA	15.198
Taipei	Taiwan	BED3	15.225
Belgrade	Yugoslavia		15.240
Stockholm	Sweden	Radio Sweden	15.240
Tel Aviv	Israel		15.250
Colombo	Ceylon		15.265
Warsaw	Poland		15.275
Wellington	New Zealand	ZLA	15.280
Melbourne	Australia	VLA	15.315
Paris	France		15.350
New York City	United States	WRUL	15.380
Cologne	West Germany	DMQ15	15.405
Seoul	South Korea	HLK9	17.745
New York City	United States	WRUL	17.750
Lisbon	Portugal	CSA44	17.870

Transistor & Diode Complement of DX-150A

NUMBER	TYPE	FUNCTION
Q 1	2SK19	Cascade RF stage
Q 2	2SC373	AVC amplifier
Q 3	2SK19	Cascade RF stage
Q 4	2SK19	Mixer
Q 5	2SC372	1st IF amplifier
Q 6	2SC372	2nd IF amplifier
Q 7	2SK19	Local oscillator
Q 8	2SC372	B.F.O. stage
Q 9	2SC372	Buffer stage
Q 10	2SC373	Amplifier for CW/SSB
Q 11	2SC373	1st AF amplifier
Q 12	2SC373	2nd AF amplifier
Q 13	2SD72	AF power amplifier
Q 14	2SD72	AF power amplifier
Q 15	2SC373	AVC amplifier
Q 16	2SD146	DC regulator
D 1, 2	1N34	Overload protector
D 3	1N73	IF noise limiter
D 4	1N34	AF detector
D 5	1N34	AF noise limiter
D 6, 7	1N34	AVC detector
D 8	SZ-7	7V voltage regulator
D 9-12	1N34	Product detector
D 13, 14	FR-1P	Rectifier
Th 1, 2	D-1E	Temperature compensator

Note: Transistor type and rating may be revised for improvement

PICTORIAL VIEW OF CHASSIS (TOP)

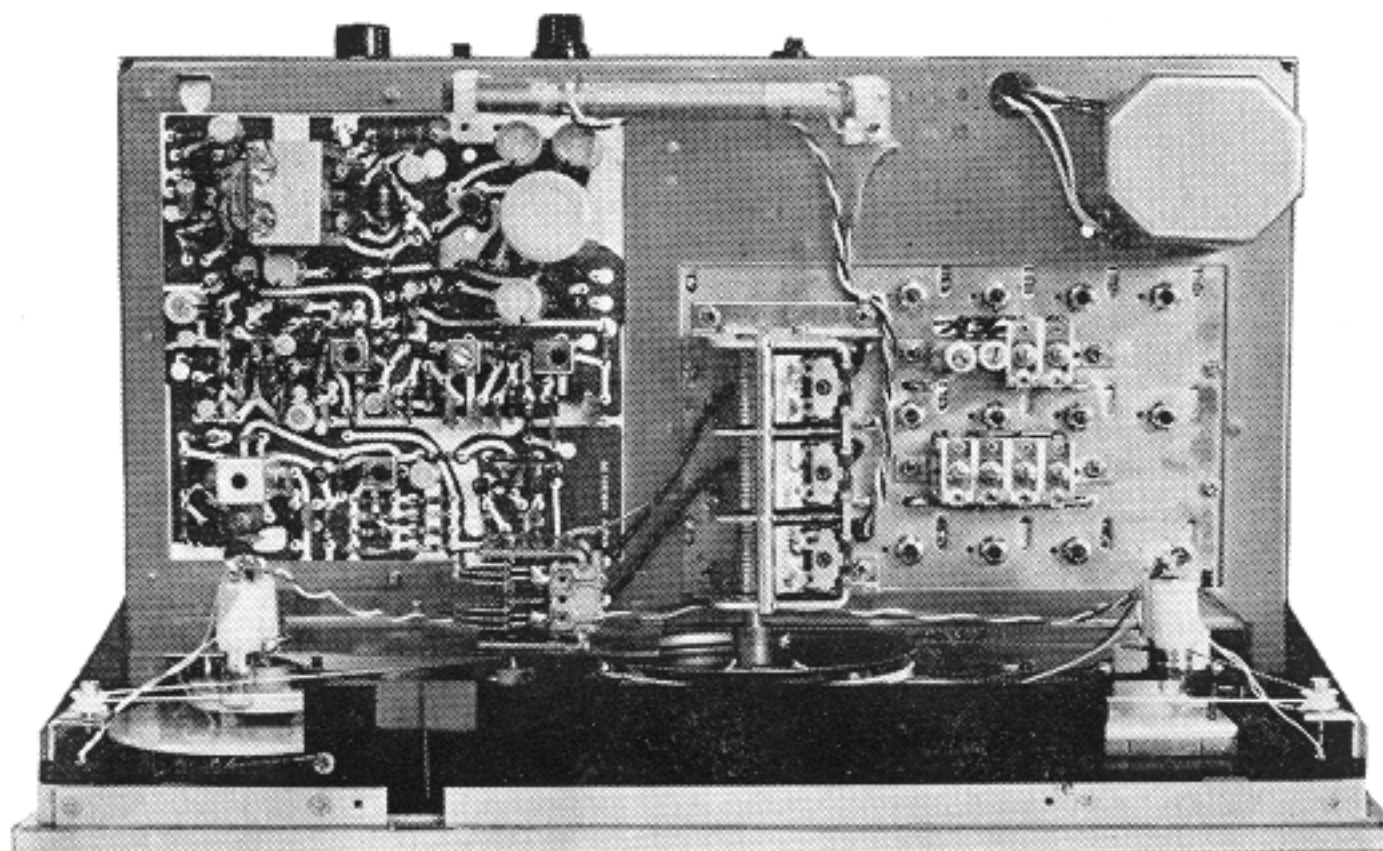

SCHEMATIC OF DIAGRAM DX-150A

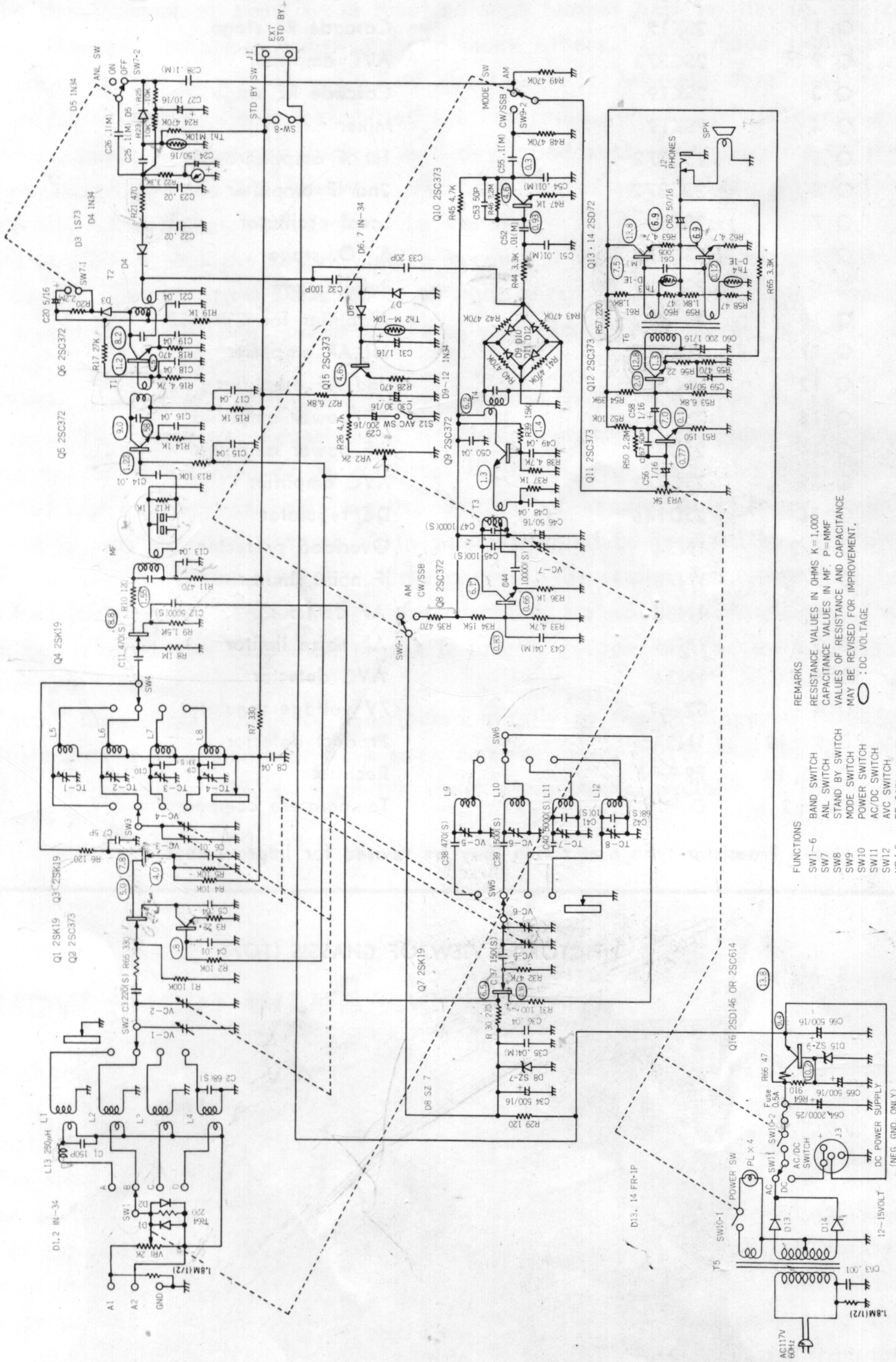

REMARKS
 RESISTANCE VALUES IN OHMS K=1,000
 CAPACITANCE VALUES IN MF. P=PMF
 VALUES OF RESISTANCE AND CAPACITANCE
 MAY BE REVISED FOR IMPROVEMENT.
 ○ : DC VOLTAGE

FUNCTIONS
 SW1-6 BAND SWITCH
 SW7 ANL SWITCH
 SW8 STAND BY SWITCH
 SW9 MODE SWITCH
 SW10 POWER SWITCH
 SW11 AC/DC SWITCH
 VR 1,2 RF GAIN
 VR 3 AF GAIN

RECOMMENDED DX-150A ACCESSORIES

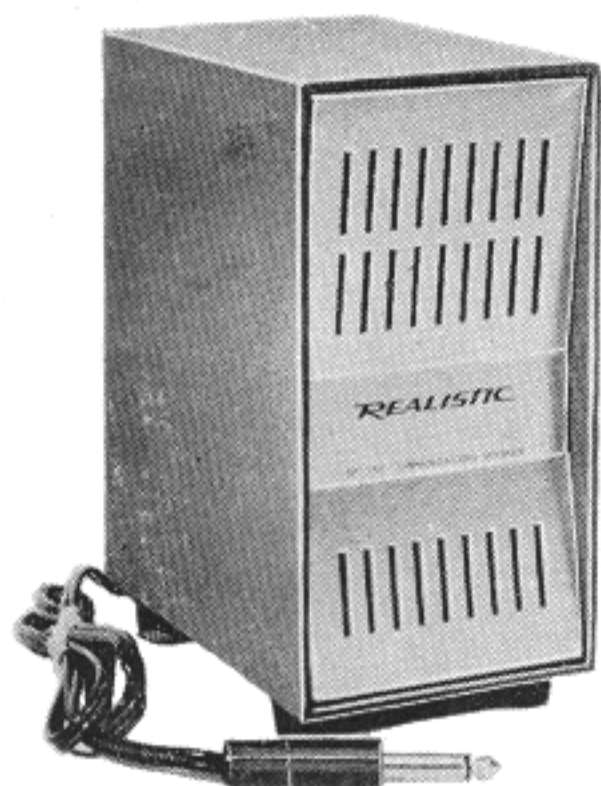

VOICE-FREQUENCY EXTERNAL SPEAKER

- 8 Ohms Impedance
- Rated at 5 Watts
Peak Power Capacity
- Styled to Match the DX-150A

7⁹⁵

Brushed aluminum grille with wrap-around metal cabinet makes the Model SP-150 the perfect external speaker for Realistic communications receivers. Provides greater intelligibility on both voice and CW. Complete with 36" cord and standard 1/4" phone plug. Size: 5 1/8 x 7 x 3 1/2". 20-1500, Shipping weight 4 lbs. 7.95

12 VDC BATTERY PACK

- Powers Your DX-150A
up to 100 Hours from
8 "D" Cell Batteries

7⁹⁵

Provides instant power at all times! Contains 8 long-life "D" cells, 2 spare battery tubes, connecting cables for all Realistic communications equipment and CB walkie talkies. Complete with carry case with straps. Size: 10 1/4 x 3 1/8 x 3". 20-1501, Ship. wt. 4 lbs. 7.95

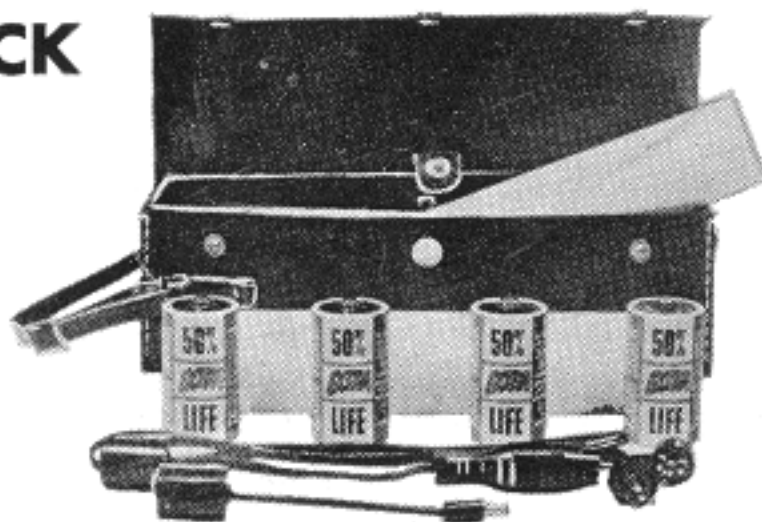

SHORT WAVE ANTENNA KIT

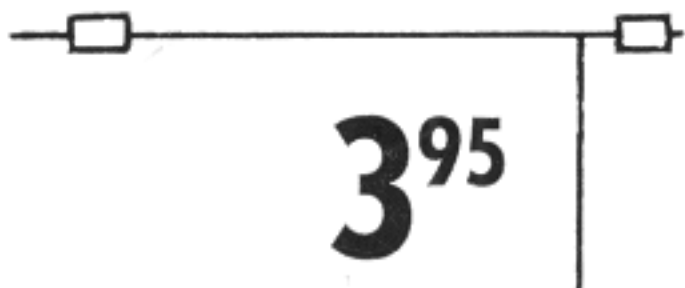

3⁹⁵

- Improves Signal Reception
from Distant Points

Antenna kit contains 75 ft. bare copper antenna wire #7/24, 50 ft. lead-in wire, plus insulators, nail knobs, ground clamp, window lead-in strips. 278-758, Shipping weight 2 lbs. 3.95

8 OHM MONO HEADPHONE



2⁴⁹

- With Standard
1/4" Phone Plug

Perfect for use with Realistic receivers for CW reception—or private short wave listening. Adjustable headpiece. Lightweight and comfortable. 279-198, Shipping weight 1 lb. 2.49

Free Manuals Download Website

<http://myh66.com>

<http://usermanuals.us>

<http://www.somanuals.com>

<http://www.4manuals.cc>

<http://www.manual-lib.com>

<http://www.404manual.com>

<http://www.luxmanual.com>

<http://aubethermostatmanual.com>

Golf course search by state

<http://golfingnear.com>

Email search by domain

<http://emailbydomain.com>

Auto manuals search

<http://auto.somanuals.com>

TV manuals search

<http://tv.somanuals.com>