

# OWNER'S MANUAL

## PRO-27 20-Channel Direct-Entry Programmable Scanner

Please read before using this equipment.

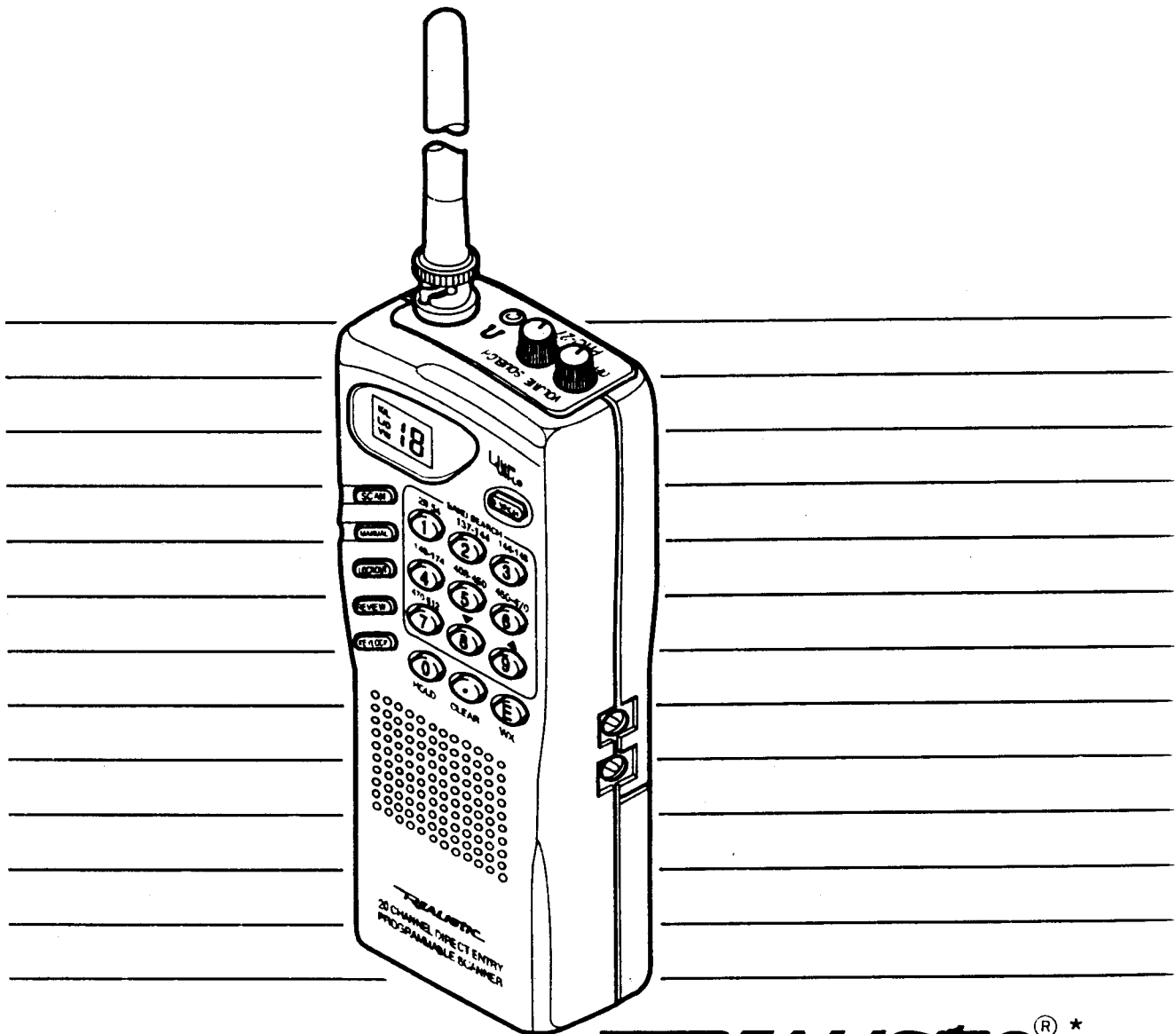

**REALISTIC**® \*

20-507 (Available in Canada only)  
20-9507 (Available in Europe and Australia)

# FEATURES

---

Your new Realistic PRO-27 20-Channel Direct-Entry Programmable Scanner lets you in on all the action! This scanner gives you direct access to multiple frequencies. You can search the seven preprogrammed frequency bands and store up to 20 frequencies into the 20 available channels so you can easily scan them.

The secret to your scanner's ability to scan so many frequencies is its custom-designed microprocessor—a tiny, built-in computer.

Your scanner includes these features:

**20 Programmable Channels**—lets you store frequencies into the scanner's memory.

**Band Search**—lets you search the seven preprogrammed frequency bands for active frequencies, and direct the search upward or downward through the bands.

**Two-Second Scan Delay**—automatically delays scanning for about 2 seconds before moving to another channel, so you can hear more replies.

**Lockout Function**—lets you set your scanner to skip over specified channels.

**Weather Band Key**—lets you scan the preprogrammed weather frequencies to keep you informed of the most current weather conditions. The weather band is only available in Canada.

**Keylock**—prevents you from accidentally changing the scanner's programming.

**Liquid-Crystal Display**—shows the selected channel and the selected functions.

**Memory Backup**—protects the frequencies stored in your scanner's memory for up to 60 minutes without power.

**Low Battery Alarm**—lets you know when the batteries get low.

**Optional Power Sources**—let you power the scanner from internal batteries, a standard AC outlet (using an optional AC adapter), or a vehicle's battery (using an optional DC adapter).

**Ni-Cd Battery Charging Circuit**—lets you recharge nickel-cadmium batteries (not supplied) while they are inside the battery compartment.

©InterTAN Inc. 1995

All Rights Reserved.

Registered Trademark of InterTAN Inc.

\*Registered Trademark of Tandy Corporation.

---

---

**BNC Connector**—lets you connect the supplied flexible antenna or an optional outdoor antenna.

**Audio Output Jack**—lets you connect optional earphones or headphones so you can listen privately, or external speakers so you can listen in a noisy area.

The Pro-27 (20-507 available in Canada only) receives these bands:

- 29-50 MHz (VHF Lo)
- 50-54 MHz  
(6-Meter Ham Band)
- 137-144 MHz (Government)
- 144-148 MHz  
(2-Meter Ham Band)
- 148-174 MHz (VHF Hi)
- 406-450 MHz  
(Ham radio and government)
- 450-470 MHz  
(UHF Standard)
- 470-512 MHz  
(UHF "T" Band)

The Pro-27 (20-9507 available in Europe and Australia) receives these bands:

- 66-88 MHz (VHF Lo)
- 137-144 MHz (VHF Lo)
- 144-148 MHz  
(2-Meter Ham Band)
- 148-174 MHz (VHF Hi)
- 406-450 MHz  
(Ham Radio and VHF Hi)
- 450-470 MHz  
(UHF Standard)
- 470-512 MHz (UHF Hi)

**Important:** In some areas, the mobile use of a scanner might be unlawful or require a permit. Check the laws in your area. Tandy/Radio Shack assumes no responsibility for the improper use of this scanner.

For your records, please record your scanner's serial number in the space provided. The serial number is located on the back of the scanner.

Serial Number: \_\_\_\_\_

---

---

## NOTICE

Your scanner might cause radio or TV interference even when it is operating properly. To determine whether your scanner is causing the interference, turn off your scanner. If the interference goes away, your scanner is causing it.

Try to eliminate the interference by:

- Moving your scanner away from the receiver
- Connecting your scanner to an outlet that is on a different electrical circuit from the receiver
- Contacting your local Tandy/Radio Shack store for assistance

If you cannot eliminate the interference, local laws may require you to stop using your scanner.

**Note:** Mobile use of this scanner maybe unlawful or requires a permit in some areas. Check the laws in your area.

This device complies with North American regulations. Operation is subject to the following two conditions: 1) This device may not cause harmful interference. 2) This device must accept any interference received, including interference that may cause undesired operation.

Use of scanners must conform to the requirements of the law of the country where they are utilized. Always check that your intended use is legally permitted. InterTAN Inc. and its subsidiaries cannot be held responsible for the illegal use of scanners.

# CONTENTS

---

---

Preparation . . . . .	7
Connecting to Power . . . . .	7
Using Internal Battery Power . . . . .	7
Important Information about the External Power Jacks . . . . .	8
Charging Nickel-Cadmium Batteries . . . . .	9
Using Standard AC Power . . . . .	9
Using Vehicle Battery Power . . . . .	11
Resetting the Scanner . . . . .	12
Connecting the Supplied Antenna . . . . .	13
Connecting an Optional Outdoor Antenna . . . . .	14
Connecting an Earphone/Headphones/External Speakers . . . . .	15
Listening Safely . . . . .	16
Traffic Safety . . . . .	16
Attaching the Belt Clip . . . . .	16
Understanding your Scanner . . . . .	17
A Look at the Keypad . . . . .	17
A Look at the Display . . . . .	18
Operation . . . . .	19
Turning On the Scanner . . . . .	19
Setting the Volume and Squelch . . . . .	19
Finding Birdie Frequencies . . . . .	20
Searching For and Storing Active Frequencies . . . . .	21
Manually Storing Frequencies . . . . .	23
Scanning the Stored Channels . . . . .	25
Automatic 2-Second Scan Delay . . . . .	25
Manually Selecting a Channel . . . . .	25
Locking Out Channels . . . . .	26
Listening to the Weather Band . . . . .	27
Using the Keylock . . . . .	27

---

---

A General Guide to Scanning . . . . .	28
Guide to Frequencies . . . . .	28
Guide to the Action Bands (Canada only) . . . . .	28
Avoiding Image Frequencies . . . . .	29
Frequency Conversion . . . . .	30
Troubleshooting . . . . .	31
Care and Maintenance . . . . .	33
Specifications . . . . .	34

# PREPARATION

---

## CONNECTING TO POWER

You can power your scanner from any of these three sources:

- Internal batteries (not supplied)
- Standard AC power (using an optional AC adapter)
- Your vehicle's battery (using an optional DC adapter)

## Using Internal Battery Power

You can power your scanner from four AA batteries. For the best results and longest battery life, we recommend alkaline batteries.

**Note:** You can also power your scanner from rechargeable nickel-cadmium (Ni-Cd) batteries. Keep in mind that fully charged Ni-Cd batteries produce slightly less voltage than alkaline batteries.

Follow these steps to install batteries.

1. If the scanner is on, turn VOLUME/OFF counterclockwise until it clicks to turn it off.
2. Press on the bottom center of the battery compartment cover and lift it off.

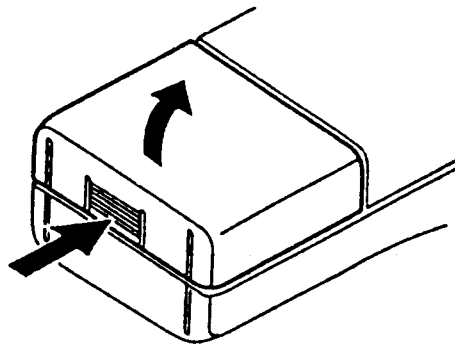

3. Remove the batteries from the battery compartment and the cover (if necessary).

- 
- 
4. Install two fresh batteries in the compartment and two in the cover as indicated by the polarity symbols (+ and -) marked inside.

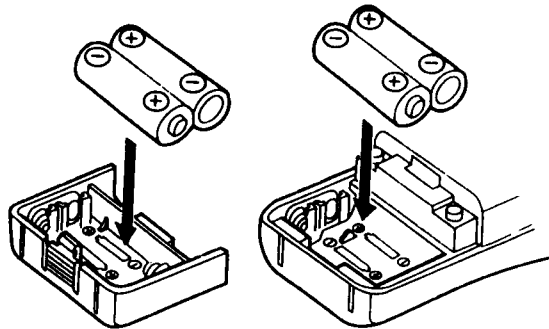

**Caution:**

- Never mix rechargeable and non-rechargeable batteries.
- Use only fresh batteries of the required size and type. Always remove old or weak batteries. Batteries can leak chemicals that destroy electronic circuits.

5. Replace the cover.

When the batteries are low, the scanner beeps every 15 seconds. When this happens, replace all four non-rechargeable batteries or recharge all four rechargeable nickel-cadmium batteries (see “Charging Nickel-Cadmium Batteries”).

## Important Information about the External Power Jacks

The POWER jack lets you connect an external AC or DC adapter to operate the scanner. You can use the POWER jack when you install either rechargeable or non-rechargeable batteries in the scanner.

The CHARGE jack lets you connect an external AC or DC adapter to operate the scanner and recharge nickel-cadmium batteries while they are in the scanner.

**Caution:** Never connect an adapter to the scanner’s CHARGE jack if you install non-rechargeable batteries in the scanner! If you try to recharge non-rechargeable batteries, they may leak and damage the scanner or the surface underneath, or they could get very hot and may explode.



---

## Charging Nickel-Cadmium Batteries

The scanner has a built-in circuit that lets you recharge the nickel-cadmium batteries while they are in the scanner.

To recharge the batteries, connect an AC or DC adapter into the CHARGE jack (see “Using Standard AC Power” or “Using Vehicle Battery Power”).

**Warning:** Never connect either adapter to the scanner’s CHARGE jack if you install non-rechargeable batteries in the scanner! If you try to recharge non-rechargeable batteries, they may leak or get very hot and may explode.

### Charging tips:

- The first time you use nickel-cadmium batteries, charge them at least 24 hours to bring them to a full charge. Subsequent charging take about 10 to 18 hours. Charging takes longer if you operate the scanner while charging the batteries.
- Nickel-cadmium batteries deliver more current and stay charged longer between charging if you occasionally let them fully discharge before fully charging them. To let the batteries fully discharge, simply use the scanner until the scanner begins beeping every 15 seconds.

### Using Standard AC Power

You can power your scanner from a standard AC outlet using an optional AC adapter.

**Warning:** Do not use an AC adapter’s polarized plug with an extension cord, receptacle, or other outlet unless the blades can be fully inserted to prevent blade exposure.

---

---

**Cautions:**

- The AC adapter should supply 12 volts and deliver at least 200 milliamps. Also, its center tip is set to positive and its plug properly fits the scanner's POWER and CHARGE jacks. Using an adapter that does not meet these specifications could damage the scanner or the adapter.
- Be sure you connect the AC adapter to the scanner before you connect it to a standard AC outlet. Then disconnect the adapter from the AC outlet before you disconnect it from the scanner.

**Note:**

- The scanner receives a 12-volt input at the CHARGE or POWER jack and reduces it to the 6 volts required by the scanner.
- If you install rechargeable nickel-cadmium batteries in the scanner, connect the AC adapter to the CHARGE jack instead of the POWER jack. This lets you use the AC adapter to power the scanner and recharge the batteries at the same time.
- Connect the adapter's power module to a standard AC outlet.

---

---

## Using Vehicle Battery Power

You can power your scanner from your vehicle's battery power using an optional DC auto adapter.

### Cautions:

- This scanner is designed to work in a vehicle that has a 12-volt DC, negative-ground electrical system. If you are not sure about your vehicle, check with your vehicle's dealer.
- The DC adapter should supply 12 volts and deliver at least 200 milliamps. Its center tip is set to positive and its plug properly fits the scanner's POWER and CHARGE jacks. Using an adapter that does not meet these specifications could damage the scanner or the adapter.
- Be sure you connect the adapter to the scanner before you connect it to the cigarette-lighter socket. Then disconnect the adapter from the cigarette-lighter before you disconnect it from the scanner.

**Note:** The scanner receives a 12-volt input at the CHARGE or POWER jack and reduces it to the 6 volts required by the scanner.

1. Plug the adapter's barrel plug into your scanner's POWER jack.

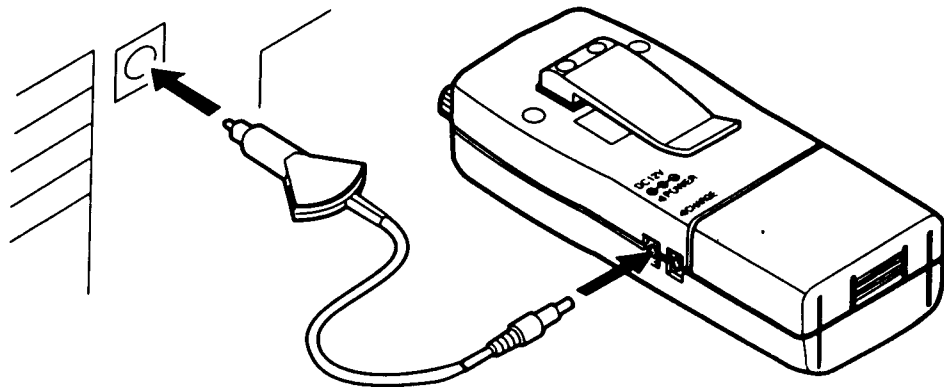

---

**Note:** If you installed rechargeable nickel-cadmium batteries in the scanner, connect the DC adapter to the CHARGE jack instead of the POWER jack. This lets you use the DC adapter to power the scanner and recharge the batteries at the same time.

2. Plug the other end of the adapter into your vehicle's cigarette-lighter socket.

**Note:** If the scanner does not operate properly with a DC adapter connected to your vehicle's cigarette-lighter socket, you might need to unplug the adapter and clean the socket to remove ash and other debris or check the fuse inside the DC adapter cord (if applicable).

## RESETTING THE SCANNER

If the scanner's display locks up or does not work properly after you connect power, you might need to reset the scanner.

**Caution:** Resetting the scanner clears all the information you stored in the scanner's memory. Before you reset the scanner, try turning it off and on to see if it begins working properly. Reset the scanner only when you are sure it is not working properly.

1. If the scanner is on, turn VOLUME/OFF counterclockwise until it clicks to turn it off.

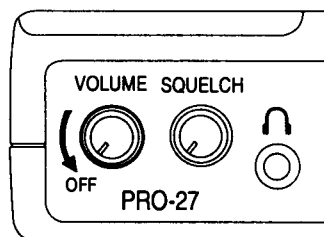

2. While holding down 2 and 9, turn on the scanner. L appears on the display.

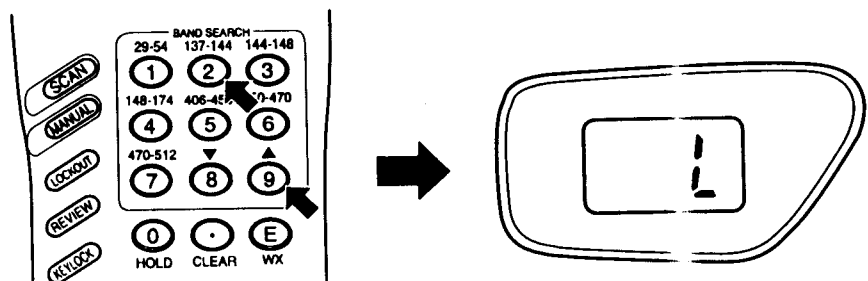

- 
- 
3. Press MANUAL until a channel number appears on the display.

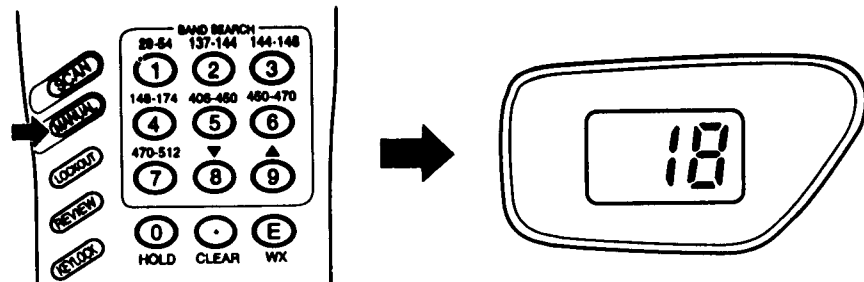

## CONNECTING THE SUPPLIED ANTENNA

Follow these steps to attach the supplied flexible antenna to the antenna jack on top of the scanner.

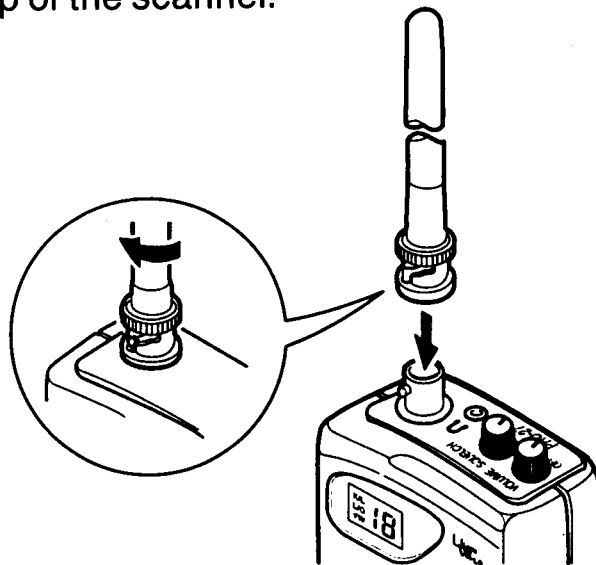

1. Slide the antenna's BNC connector slots over the tabs on the scanner's antenna jack.
2. Press down and rotate the antenna's BNC connector clockwise until it locks into place.

---

---

## CONNECTING AN OPTIONAL OUTDOOR ANTENNA

The supplied antenna is usually adequate for strong, local signals. However, for better reception on all bands, you can attach an optional outdoor antenna, such as an external mobile antenna, telescoping antenna, multi-band, or outdoor base antenna. If the coaxial cable's connector does not fit the antenna jack, you might also need an adapter. Your local Tandy/Radio Shack store sells a complete line of outdoor antennas, adapters, connectors, and mounting hardware.

For the best performance, consider the following when deciding on an outdoor base antenna and its location:

- The location of the antenna should be as high as possible.
- The antenna and antenna cable should be as far away as possible from sources of electrical noise (appliances, other radios, and so on).
- The antenna should be vertical.

Mount the antenna following the instructions supplied with the antenna and its mounting hardware. Then route the antenna cable to the scanner, and connect it to the antenna jack on top of the scanner.

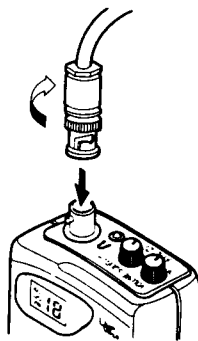

**Warning:** When installing or removing an outdoor antenna, use extreme caution. If the antenna starts to fall, let it go! It could contact overhead power lines. If the antenna touches a power line, contact with the antenna, mast, cable or guy wires can cause electrocution and death! Call the power company to remove the antenna. Do not attempt to do so yourself.

---

---

**Caution:** Do not route the cable over sharp edges or moving objects.

**Note:** Always use 50-ohm coaxial cable to connect an outdoor antenna.

- For lengths under 15 meters (50 feet), use 50-ohm coaxial cable or RG8/M.
- For lengths over 15 meters (50 feet), use 50-ohm coaxial cable, low-loss coaxial cable.

## CONNECTING AN EARPHONE/ HEADPHONES/EXTERNAL SPEAKER

- The 3.5mm (1/8-inch)  jack on top of the scanner lets you connect an earphone, headphones, or external speaker(s).

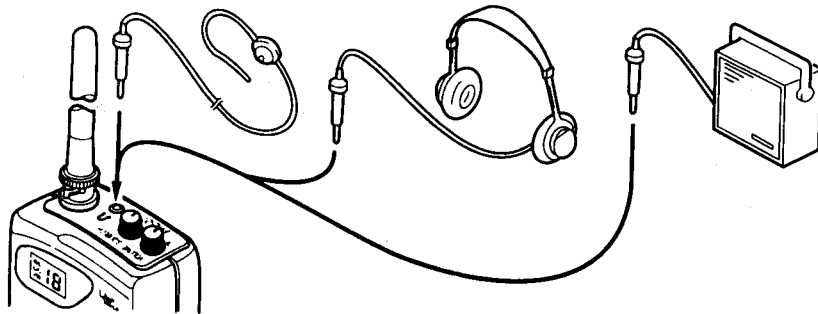

- For private listening, connect an earphone.
- For more comfortable private listening, connect monaural headphones.
- For listening from a remote area or in a noisy area, connect an extension speaker.

**Note:** Connecting any external device to the  jack automatically disconnects the internal speaker.

---

---

## Listening Safely

To protect your hearing, follow these guidelines when you use an earphone or headphones.

- Do not listen at extremely high volume levels. Extended high-volume listening can lead to permanent hearing loss.
- Set the volume to the lowest setting before you begin listening. After you begin listening, adjust the volume to a comfortable level.
- Once you set the volume, do not increase it. Over time, your ears adapt to the volume level, so a volume level that does not cause discomfort might still damage your hearing.

## Traffic Safety

Do not wear an earphone/headphones while operating a motor vehicle or riding a bicycle. This can create a traffic hazard and is illegal in some areas.

Even though some earphones/headphones are designed to let you hear some outside sounds when listening at normal volume levels, they still present a traffic hazard.

## ATTACHING THE BELT CLIP

You can connect the supplied belt clip to your scanner for hands-free carrying when you are on the go. Attach the clip to your scanner with the two supplied Phillips-head screws.

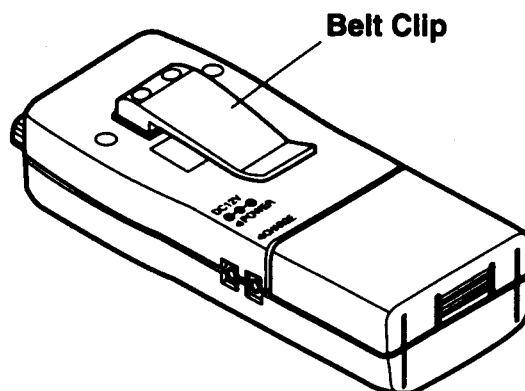



# UNDERSTANDING YOUR SCANNER

## A LOOK AT THE KEYPAD

This look at the scanner's keypad will help you understand each key's function.

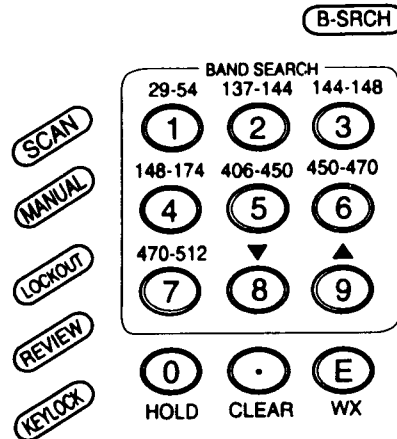

Key	Function
<b>SCAN</b>	Starts scanning through the stored channels.
<b>MANUAL</b>	Stops scanning and lets you manually enter a channel number or frequency.
<b>LOCKOUT</b>	Turns the selected channel's lockout function on and off.
<b>REVIEW</b>	Displays the stored frequency or the frequency you are about to store, one digit at a time.
<b>KEYLOCK</b>	Locks the scanner's keypad to protect it from accidental program changes.
<b>B-SRCH</b>	Searches the selected band.
<b>1 -7</b>	Each single-digit number on the keys enters the numbers for a channel or a frequency. Each range of numbers above these number keys enters the numbers for a frequency band (for example 137-144 above the "2" key).
<b>8 /▼, 9 /▲</b>	The single-digit number on the key enters the numbers 8 or 9 for a channel or a frequency. The arrow above the number key enters the up or down search mode direction.
<b>0/HOLD</b>	The single-digit number on the key enters the number 0 for a channel or a frequency.

---

---

**HOLD** below the number key temporarily stops a frequency search so you can listen to the transmission or store the frequency into a channel.

•/**CLEAR**      • on the key enters the decimal point in a frequency.  
**CLEAR** below the key erases an incorrect entry or an error.

**E/WX**      **E** (enter) on the key stores a key entry into memory.  
**WX** below the key starts scanning through the weather band. The weather band is received only in Canada.

## A LOOK AT THE DISPLAY

The scanner's display shows two digits at a time when it displays a two-digit channel number. But, in all other cases, the scanner displays only one digit at a time (for example, when you enter channel numbers and when it displays frequencies). Symbols appear or flash on the display to indicate other functions or conditions.

A look at the scanner's display will help you understand what each indicator means.

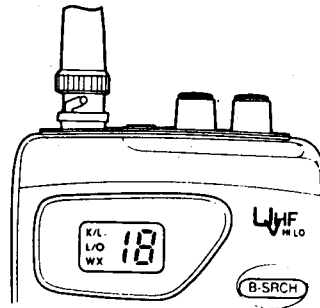

<b>Indicator</b>	<b>Appears when</b>
<b>K/L</b>	The scanner is set to keylock to protect against accidental program changes.
<b>L/O</b>	The scanner is monitoring a channel that is locked out of the scan mode.
<b>WX</b>	The scanner is monitoring a weather broadcast. The weather channels are received in Canada only.
<b>E</b>	You make an entry error.
<b>d</b>	You are doing a direct search (appears only briefly).
<b>h</b>	You press <b>HOLD</b> to stop the scanner from direct searching.
<b>H</b>	You press <b>HOLD</b> to stop the scanner from band searching.
<b>18</b>	

# OPERATION

## TURNING ON THE SCANNER

Turn VOLUME/OFF clockwise until it clicks to turn on your scanner. The scanner automatically scans the 20 channels.

**Note:** The first time you turn on the scanner, the channels might not have any frequencies stored in them, but the scanner will continuously scan the empty channels.

## SETTING THE VOLUME AND SQUELCH

1. Press MANUAL to stop the scanning. The display shows the current channel.

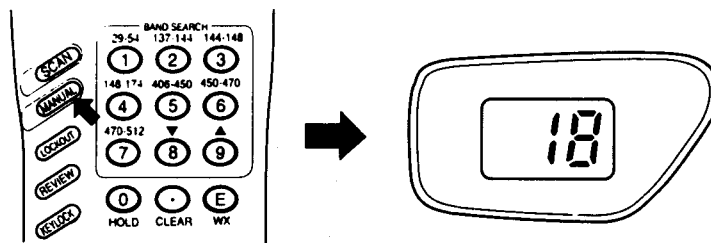

2. Turn SQUELCH fully clockwise.

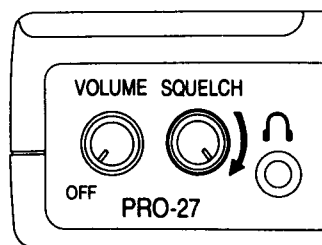

3. Turn VOLUME/OFF clockwise to set the scanner's volume about half way.

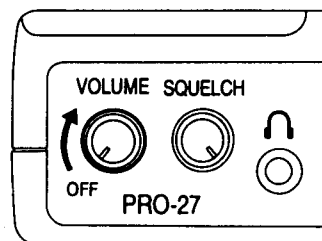

4. Turn SQUELCH counterclockwise until you hear a hissing noise.
5. Adjust VOLUME/OFF to a comfortable level.
6. Slowly turn SQUELCH clockwise until the hissing noise stops.

---

---

## Squelch Tips

- If the scanner picks up unwanted or weak transmissions, slightly turn SQUELCH clockwise to decrease receiver sensitivity.
- If the scanner does not pick up any transmissions, slightly turn SQUELCH counterclockwise to increase receiver sensitivity.

## FINDING BIRDIE FREQUENCIES

Birdies are operating frequencies generated and used inside the scanner's receiver. These operating frequencies could interfere with broadcasts on the same frequencies and make them difficult or impossible to receive.

If you store one of these frequencies into a channel, you might hear only noise when the scanner stops on that frequency. If the interference is not severe, you might be able to turn SQUELCH clockwise to cut out the birdie.

These are the most common birdies to watch for:

- 31.2 MHz (20-507 for Canada)
- 41.6 MHz (20-507 for Canada)
- 52.0 MHz (20-507 for Canada)
- 72.8 MHz (20-9507 for Europe and Australia)
- 145.6 MHz
- 156.0 MHz

To find your scanner's specific birdies:

1. Disconnect the antenna and move it away from the scanner.  
**Note:** Make sure that no other nearby radios or TVs are turned on.
2. Search every frequency band from its lowest frequency to the highest (see "Searching For and Storing Active Frequencies").  
If searching stops on a frequency (as if the scanner had found a signal) but there is no sound, the frequency might be a birdie.

For future reference, record all the birdies in your particular scanner here.

_____	_____	_____
_____	_____	_____
_____	_____	_____

---

---

## SEARCHING FOR AND STORING ACTIVE FREQUENCIES

You can set your scanner to search for transmissions:

- Within any one of the seven preprogrammed frequency bands (BAND SEARCH).

You can select these bands using the number keys 1-7.

1: 29-54 MHz (20-507 for Canada) 66-88 MHz (20-9507 for Europe and Australia)	5: 406-450 MHz
2: 137-144 MHz	6: 450-470 MHz
3: 144-148 MHz	7: 470-512 MHz
4: 148-174 MHz	

- Starting from a band where you have stored a frequency (DIRECT SEARCH).

Follow these steps to search for active frequencies.

1. While the scanner is stopped, enter the channel number where you want to either:
  - Store a frequency the scanner finds while searching any of the seven preprogrammed bands.
  - Replace a stored frequency with another frequency the scanner finds while searching the same band as the stored frequency.

**Note:** When you enter a two-digit channel number (10-19), the display shows only one digit at a time. After you press MANUAL, the display shows the full two-digit number. When you enter CH 20, the display shows "0."

---

---

2. Press MANUAL then B-SRCH. Then, while K/L, L/O, and WX flash on the display, do either of these things:

- Start BAND SEARCH by entering the number of the frequency band you want to search. The scanner searches starting from the selected band's lowest frequency.
- Start DIRECT SEARCH by pressing 8 / ▼ to search downward or 9 / ▲ to search upward. The scanner searches the band that contains the channel you selected.

**Notes:**

- If you do not start band search or direct search while K/L, L/O, and WX flash on the display, the scanner automatically searches the previously searched band.
- When the scanner searches upward, the display segments cycle clockwise. When the scanner searches downward, the display segments cycle counterclockwise. While searching, the selected band number (BAND SEARCH) or d (DIRECT SEARCH) briefly appears at each cycle.

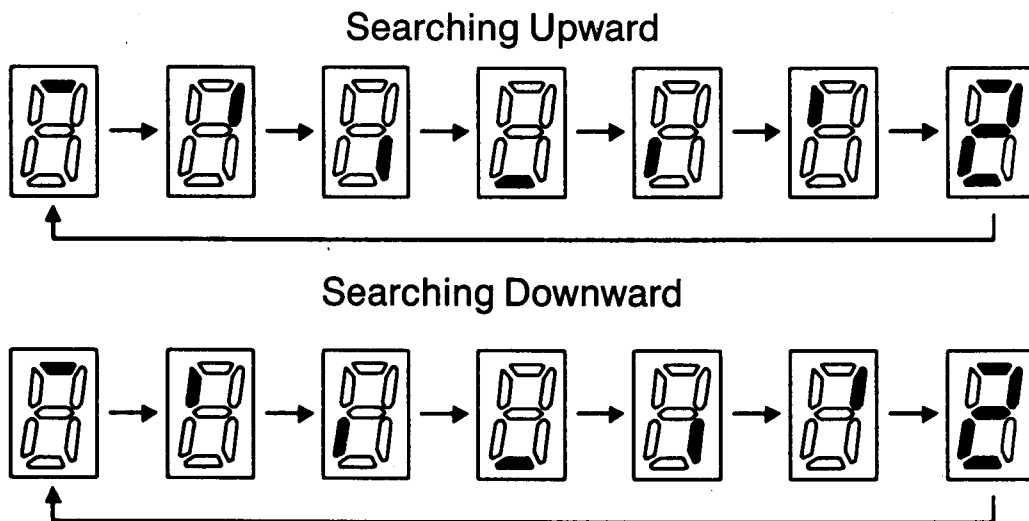

- To change the frequency band, simply select the desired band while the scanner is searching.
- To change the search direction, press 8 / ▼ or 9 / ▲.

---

---

3. When the scanner stops on an active frequency, the channel number you selected flashes on the display.

- To store the frequency into the selected channel:

a. Press 0/HOLD to stop the search (hold mode). h (DIRECT SEARCH) or H (BAND SEARCH) appears on the display.

**Note:** If you want to see the frequency, simply press REVIEW.

b. Press E/WX (Enter). The scanner stores the frequency into the selected channel and its number appears on the display.

c. Press B-SRCH then 8 / ▼ or 9 / ▲ to continue the search after storing the frequency.

- To continue the search without storing the frequency, you can either:

— Release the hold mode by simply pressing 0/HOLD (to continue search in the same direction).

— Press and hold 8 / ▼ or 9 / ▲ for about 1 second (to change the direction of search).

**Note:** To store the frequency into another channel, press REVIEW to see the frequency and determine which band the frequency is in. Then repeat Steps 1-4 to search the band again for the frequency and store it in the new channel.

## MANUALLY STORING FREQUENCIES

You can manually store a frequency into each of the 20 channels.

Follow these steps to manually store frequencies.

1. While the scanner is stopped, enter the channel number where you want to store a frequency, then press MANUAL. The desired channel number appears on the display.

2. Enter the desired frequency, including the decimal point.

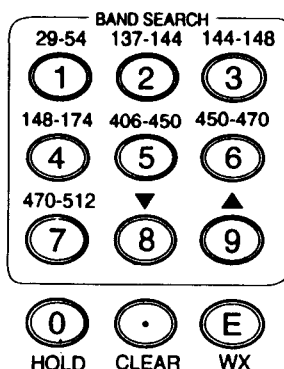

**Notes:**

- The decimal point appears as a dash (–) on the display.
  - To confirm the frequency you entered before you store it, press REVIEW. The frequency appears on the display, one digit at a time, then the selected channel number reappears.
3. Press E/WX (enter) to store the frequency into the selected channel.

**Notes:**

- To confirm the frequency you stored, press REVIEW. The stored frequency appears on the display, one digit at a time.
  - If you make a mistake in Step 2, E (error) appears on the display. If this happens, press •/CLEAR and repeat Steps 2 and 3.
4. To program the next channel in sequence, press MANUAL then repeat Steps 2 and 3.

**Notes:**

- VHF band frequencies (30-300 MHz) are found at .005 MHz steps (5 kHz). UHF band frequencies (300-3000 MHz) are found at .0125 MHz steps (12.5 kHz).
- When you enter a frequency, the scanner automatically rounds it to the nearest valid number. For example, if you enter the frequency 151.473 MHz, your scanner rounds it up to 151.475 MHz.
- Without battery or external adapter power, the scanner protects the frequencies stored in memory for about 60 minutes.



---

---

## SCANNING THE STORED CHANNELS

To scan the stored channels, press SCAN. Your scanner scans through all the channels except the ones you lock out (see "Locking Out Channels").

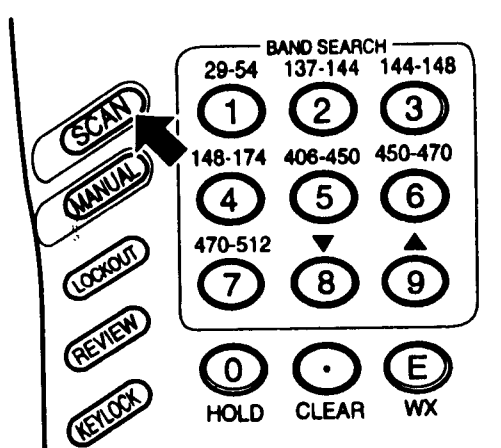

### Automatic 2-Second Scan Delay

Your scanner stops when it finds a signal, and starts scanning again about 2 seconds after the signal ends. This 2-second delay gives you a chance to hear a reply to the first signal.

### MANUALLY SELECTING A CHANNEL

You can continuously monitor a single channel without scanning. This is useful if you hear a broadcast and want to hear all the details, or if you want to monitor a channel you locked out.

To monitor a channel while scanning, press MANUAL, enter the channel number, then press MANUAL again.

**Note:** When you enter CH1 to CH19, the display shows the channel number which you enter. When you enter CH20, the display shows "0."

If scanning has stopped at the desired channel, simply press MANUAL once.

Repeatedly press MANUAL to step through the channels one at a time.

---

---

## LOCKING OUT CHANNELS

You can set your scanner to scan more efficiently by locking out channels you do not want to monitor, such as channels with a continuous transmission.

Enter the channel number you want to lock out, and press MANUAL. Then press LOCKOUT so L/O appears on the display.

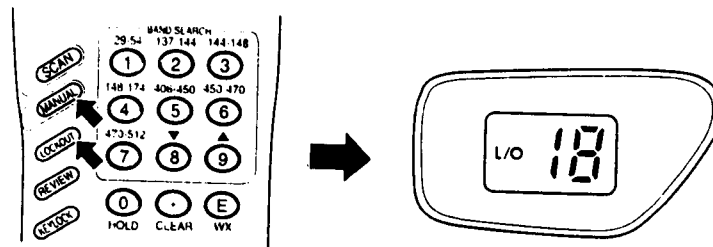

### Notes:

- You can still manually select locked out channels.
- You cannot lock out all channels.

To unlock a channel, manually select the channel and press LOCK-OUT so L/O disappears.

---

---

## LISTENING TO THE WEATHER BAND

The weather band is received in Canada only. The scanner is preprogrammed with seven weather channels. You can hear your local forecast and regional weather information on one or more of these channels.

162.4 MHz	162.5 MHz
162.425 MHz	162.525 MHz
162.450 MHz	162.550 MHz
162.475 MHz	

To hear your local forecast and regional weather information, simply press E/WX. Your scanner scans through the weather band and stops on an active broadcast. WX appears on the display. If a broadcast is weak, press E/WX again to continue scanning the weather band.

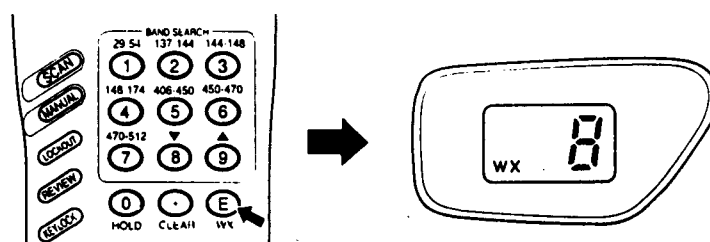

## USING THE KEYLOCK

After you program your scanner, you can protect it from accidental program changes by turning on the keylock feature. When the keylock is on, the only controls you can use are SCAN, MANUAL, KEYLOCK, VOLUME/OFF, and SQUELCH.

To turn on the keylock, press KEYLOCK until K/L appears on the display. To turn it off, press KEYLOCK until K/L disappears.

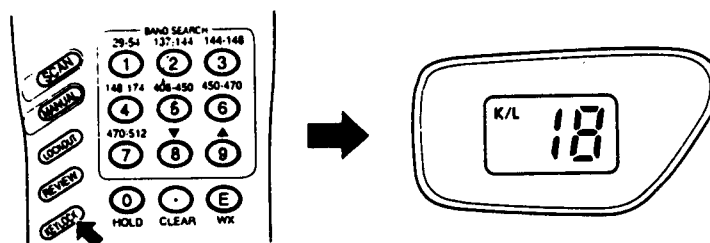

# **A GENERAL GUIDE TO SCANNING**

---

---

Reception of the frequencies covered by your scanner is mainly "line-of-sight." This means you usually cannot hear stations that are beyond the horizon.

During the summer months, you might be able to hear stations in the 30-50 MHz range located several hundred or even thousands of miles away. This is because of summer atmospheric conditions commonly known as skip. This type of reception is unpredictable but often very interesting!

## **GUIDE TO FREQUENCIES**

National Weather Frequencies (Available in Canada only)

* 161.650 MHz	* 162.440 MHz	162.525 MHz
* 161.775 MHz	162.450 MHz	162.550 MHz
162.400 MHz	162.475 MHz	* 163.275 MHz
162.425 MHz	162.500 MHz	

\* Not programmed.

## **A GUIDE TO THE ACTION BANDS**

### **(20-507, available in Canada only)**

With a little investigation, you can find the active frequencies in your community. We can give you some general pointers on finding these frequencies and you can take it from there. Please use caution and common sense when you hear an emergency call. Never go to the scene of an emergency. It could be very dangerous.

Find out if there is a local club that monitors your community's frequencies. Perhaps a local electronics repair shop that works on equipment similar to your scanner can give you channel frequencies used by local radio services.

---

---

As a general rule on VHF, most activity concentrates between 153.785 and 155.98 MHz and then again from 158.73 to 159.46 MHz. Here you find local government, police, fire, and most emergency services. If you are near major railroad tracks, listen between 160.0 to 161.9 for signals.

In some larger cities, there has been a move to the UHF bands for emergency services. Here, most of the activity is between 453.025 and 453.95 MHz and between 456.025 and 467.925 MHz.

In the UHF band, mobile units operate between 456.025 and 459.95 MHz and between 465.025 and 469.975 MHz. A repeater picks up the mobile unit's transmissions on one frequency, then rebroadcasts (or repeats) the transmission 5 MHz lower, but at a higher power level, than the mobile units (that is, 451.025-454.95 MHz and 460.025-464.975 MHz). This means that if you find an active frequency inside one of the mobile unit's frequency spreads, you can look 5 MHz lower to find the repeater frequency.

## AVOIDING IMAGE FREQUENCIES

You might discover one of your regular stations on another frequency that is not listed. It might be what is known as an image frequency.

For example, you might find a service that regularly uses a frequency of 453.275 also on 474.975.

To see if it is an image, do a little math.

Note the new frequency	474.975
Double the intermediate frequency of 10.85 MHz (21.700) and subtract it from the new frequency.	<u>– 21.700</u>
If the answer is the regular frequency, then you have tuned to an image.	453.275

Occasionally you might get interference on a weak or distant channel from a strong broadcast 21.7 MHz below the tuned frequency. This is rare, and the image signal is usually cleared whenever there is a broadcast on the actual frequency.

---

---

## FREQUENCY CONVERSION

The tuning location of a station can be expressed in frequency (kHz or MHz) or in wavelength (meters). The following information can help you make the necessary conversions.

1 MHz (million) = 1,000 kHz (thousand)

To convert MHz to kHz, multiply by 1,000:

$$9.62 \text{ MHz} \times 1000 = 9620 \text{ kHz}$$

To convert from kHz to MHz, divide by 1,000.

$$\frac{2780 \text{ kHz}}{1000} = 2.780 \text{ MHz}$$

To convert MHz to meters, divide 300 by the number of megahertz.

$$\frac{300}{7.1 \text{ MHz}} = 42.25 \text{ meters}$$

# TROUBLESHOOTING

Your Realistic PRO-27 20-Channel Direct-Entry Programmable Scanner should require very little maintenance. If you have problems, refer to this chart for possible solutions. If you cannot solve the problem, contact your local Tandy/Radio Shack store for assistance.

Problem	Probable Cause	Solution
Scanner is totally inoperative.	The batteries are dead.  Batteries are not correctly installed.  The optional AC or DC power adapter is not connected.	Replace the batteries with fresh ones or recharge the rechargeable batteries.  Make sure the + and - terminals are properly aligned.  Be sure the adapter is fully inserted into the DC 12V jack.
The scanner's display dims and the scanner sounds a tone every 15-30 seconds.	The batteries are weak.  The AC or DC adapter used does not provide the required 12 Volts DC.	Replace the non-rechargeable batteries, or recharge the Ni-Cd rechargeable batteries.  Be sure the adapter is set to provide no less than 12V DC.
Poor or no reception.	Improperly connected antenna.	Be sure the antenna is properly connected.
	Programmed frequencies are the same as Birdie frequencies.	Avoid programming frequencies listed under "Birdie Frequencies," or only select them manually.
	Environment is not suitable for reception by the scanner.	Relocate the scanner and try again.
	Batteries are weak or dead.	Replace them with new ones or recharge the Ni-Cd batteries.
E appears on the display.	Programming error.	Reprogram the frequency correctly.
Keyboard does not work.	The keylock function is activated.	Press KEYLOCK until K/L disappears from the display to turn off the keylock.

---

---

<b>Problem</b>	<b>Probable Cause</b>	<b>Solution</b>
Keys do not work or display changes at random.	Undertermined error.	Reset the scanner (see "Resetting the Scanner").
Scanner is on, but will not scan.	The SQUELCH control is not correctly adjusted.	Adjust the SQUELCH control clockwise (see "Setting the Volume and Squelch").



# CARE AND MAINTENANCE

---

Your new Realistic PRO-27 20-Channel Direct-Entry Programmable Scanner is an example of superior design and craftsmanship. The following suggestions will help you care for your scanner so you can enjoy it for years.



Keep the scanner dry. If it gets wet, wipe it dry immediately. Liquids can contain minerals that can corrode the electronic circuits.



Use only fresh batteries of the required size and type. Always remove old and weak batteries. They can leak chemicals that destroy electronic circuits.



Handle the scanner gently and carefully. Dropping it can damage circuit boards and cases and can cause the scanner to work improperly.



Use and store the scanner only in normal temperature environments. Temperature extremes can shorten the life of electronic devices, damage batteries, and distort or melt plastic parts.



Keep the scanner away from dust and dirt, which can cause premature wear of parts.



Wipe the scanner with a damp cloth occasionally to keep it looking new. Do not use harsh chemicals, cleaning solvents, or strong detergent to clean the scanner.

Modifying or tampering with your scanner's internal components can cause a malfunction and might invalidate the scanner's warranty and void the unit's legal certification to operate it. If your scanner is not operating as it should, take it to your local Tandy/Radio Shack store for assistance.

# SPECIFICATIONS

---

The Pro-27 (20-507 available in Canada only) receives these bands:

VHF-Lo and 10-Meter Ham	29-50 MHz (in 5 kHz steps)
Ham	50-54 MHz (in 5 kHz steps)
Government	137-144 MHz (in 5 kHz steps)
Ham	144-148 MHz (in 5 kHz steps)
VHF-Hi	148-174 MHz (in 5 kHz steps)
Ham/Gov't	406-450 MHz (in 12.5 kHz steps)
UHF-Standard	450-470 MHz (in 12.5 kHz steps)
UHF-Hi ("T")	470-512 MHz (in 12.5 kHz steps)

The Pro-27 (20-9507 available in Europe and Australia) receives these bands:

VHF-Lo	66-88 MHz (in 5 kHz steps)
VHF-Lo	137-144 MHz (in 5 kHz steps)
Ham	144-148 (in 5 kHz steps)
VHF-Hi	148-174 MHz (in 5 kHz steps)
Ham/UHF	406-450 MHz (in 12.5 kHz steps)
UHF-Standard	450-470 MHz (in 12.5 kHz steps)
UHF-Hi	470-512 MHz (in 12.5 kHz steps)
Channels of Operation	Any 20 channels in any band combinations

Sensitivity (FM: 20 dB S/N ratio at 3 kHz deviation):

29-54 MHz (20-507 for Canada)	0.4 $\mu$ V
66-88 MHz (20-9507 for Europe and Australia)	0.5 $\mu$ V
137-174 MHz	0.5 $\mu$ V
406-512 MHz	0.6 $\mu$ V

Selectivity:

$\pm 10$ kHz	-6 dB
$\pm 17$ kHz	-50 dB

Scanning Rate . . . . . 10 Channels/Sec.

Delay Time . . . . . 2 Seconds

Acceptable RF Displacement . . . . .  $\pm 6$  kHz

IF Frequencies . . . . . 10.85 MHz and 450 kHz

Squelch Sensitivity:

Threshold	Less than 0.4 $\mu$ V
Tight	(S+N)/N 25 dB

---

---

Built-in Speaker . . . . . 1<sup>9</sup>/<sub>16</sub> Inches (4 cm) 8 Ohm, Dynamic Type

**Power Requirements**

DC . . . . . 4-AA Batteries (6.0 VDC)  
or 4-AA Rechargeable Ni-Cd Batteries (4.8 VDC)  
or Vehicle Battery DC Adapter

AC . . . . . AC Adapter

**Current Drain:**

Squelched . . . . . 55 mA  
Full Volume Unsquelched . . . . . 135 mA

Dimensions . . . . . 162 x 68.5 x 39 mm  
(6<sup>3</sup>/<sub>8</sub> x 2<sup>11</sup>/<sub>16</sub> x 1<sup>9</sup>/<sub>16</sub> Inches) (HWD)

Weight . . . . . 230 g (8.10 oz)

Specifications are typical; individual units might vary. Specifications are subject to change and improvement without notice.

---

---

### **InterTAN WARRANTY**

InterTAN warrants that this product will be free from defects in materials and workmanship for a period of one (1) year from the date of purchase. Within this period, simply take the product and your proof of purchase to any InterTAN store or dealer and the product will be repaired without charge for parts and labour. InterTAN reserves the right to charge for transportation. Any product which has been subject to misuse or accidental damage is excluded from this warranty.

This warranty is only applicable to a product purchased through InterTAN's company owned stores and dealers and to a product that is presented for repair in a country where InterTAN offers the product for sale. While this warranty does not confer any legal rights other than those set out above, you may have additional statutory rights which will vary under the laws of the various countries, states, provinces and other governmental entities in which InterTAN operates. This warranty is subject to all statutory rights you may have in the country of purchase.

***WE SERVICE WHAT WE SELL***

---

---

**MANUFACTURED IN THE PHILIPPINES, IMPORTED FOR/IMPORTE POUR  
InterTAN CANADA LTD. BARRIE, CANADA, L4M 4W5  
InterTAN AUSTRALIA LTD, A.C.N. 002 511 944  
InterTAN U.K. LTD. WEST MIDLANDS, WS27PS  
REGISTERED TRADEMARK OF InterTAN INC.  
\*REGISTERED TRADEMARK OF TANDY CORPORATION**

5A5

JBZZ01253BZ  
Printed in the Philippines

## Free Manuals Download Website

<http://myh66.com>

<http://usermanuals.us>

<http://www.somanuals.com>

<http://www.4manuals.cc>

<http://www.manual-lib.com>

<http://www.404manual.com>

<http://www.luxmanual.com>

<http://aubethermostatmanual.com>

Golf course search by state

<http://golfingnear.com>

Email search by domain

<http://emailbydomain.com>

Auto manuals search

<http://auto.somanuals.com>

TV manuals search

<http://tv.somanuals.com>